



CITY

60098



 LEGO.com/city



PL

Ważne informacje dotyczące baterii
Nigdy nie należy stosować razem różnych rodzajów baterii ani stosować równocześnie starych i nowych baterii. Jeżeli produkt nie jest używany przez dłuższy czas lub jeżeli baterie się wyczerpały, należy wyjąć baterie. Nigdy nie należy stosować uszkodzonych baterii. Należy stosować wyłącznie zalecany rodzaj baterii lub rodzaj mu odpowiadający. Przy wkładaniu baterii należy zwrócić uwagę na właściwe położenie biegunów. Baterie akumulatorowe należy ładować w odpowiedniej ładowarce pod nadzorem osoby dorosłej. Nie można naładować baterii bez wyjęcia ich z produktu i nigdy nie należy tego próbować. Nigdy nie należy próbować ładowania baterii jednorazowych. Nigdy nie należy doprowadzać do zwarcia w gnieździe baterii.

CZ

Důležitá informace o bateriích
Nikdy nepoužívejte najednou různé typy baterií nebo kombinaci starých a nových baterií. Nebude-li se výrobek delší dobu používat nebo jsou-li baterie vybité, vždy je vyjměte z výrobku. Nikdy nepoužívejte poškozené baterie. Používejte pouze doporučené nebo odpovídající typy baterií. Baterie instalujte se správnou orientací pólů. Nabíjitelné baterie musí být nabity ve vhodné nabíječce pod dohledem dospělé osoby. Nabíjitelné baterie nelze nabíjet, jsou-li umístěny ve výrobku, a nesměte se o to ani pokoušet. Nikdy se nesnažte nabíjet baterie, které nejsou nabíjitelné. Nikdy nezkratujte kontakty v prostoru pro baterie.

SK

Dôležitá informácia o batériách
Nikdy nepoužívajte naraz odlišné typy batérií ani nekombinujte staré batérie s novými. Batérie vždy vyberte, ak sa výrobok nebude dlhšie používať, ale ak sa batérie vybitli. Nikdy nepoužívajte poškodené batérie. Používajte len odporúčané alebo zodpovedajúce typy batérií. Batérie vkladajte so správnou orientáciou pólou. Dobíjateľné batérie sa musia nabíjať vo vhodnom nabíjači pod dozorom dospeljej osoby. Dobíjateľné batérie sa nesmú nabíjať, ak sú umiestnené vo výrobku, a nesmiete sa o to ani pokúšať. Nikdy sa nesnažte nabíjať batérie, ktoré nie sú dobíjateľné. Nikdy neskratujte kontakty v priestore pre batérie.

HU

Fontos tudnivalók az elemekről
Soha ne használjon különböző típusú elemeket, illetve ne használjon vegyesen új és használt elemeket. Mindig távolítsa el az elemeket, ha a készülékét előre láthatóan hosszabb ideig nem fogják használni, vagy ha az elemek lemerültek. Soha ne használjon megrongálódott akkumulátort. Csak az ajánlott típusú, vagy annak megfelelő elemet használjon. Az elemeket polaritáshegyesen helyezze be. Az akkumulátorokat csak a megfelelő akkumulátortöltővel szabad feltölteni, egy felnőtt segítő felügyelete mellett. Az akkumulátorokat nem lehet feltölteni, ha azok a készülékben vannak. Ezt meg sem szabad próbálni. Soha ne próbálja meg feltölteni a nem tölthető elemeket. Soha ne hozzon létre rövidzárlatot az elemtartó kivezetésén.

UA

Необхідна інформація про батареїки
Ніколи не використовуйте одночасно батареїки різних типів або батареїки з різним терміном придатності. Обов'язково вилучайте батареїки з приладу, якщо довго не користуетесь ним, або якщо в батареїках вже скінчився заряд. Ніколи не використовуйте пошкоджені батареїки. Використовуйте батареїки лише рекомендованого або відповідного типу. Вставляйте батареїки, враховуючи задану полярність. Акумуляторні батареїки повинні заряджатись у відповідному зарядному приладі під наглядом дорослого. В будь-якому випадку не намагайтесь підзарядити батареїки, що знаходяться в приладі. В будь-якому випадку не намагайтесь підзарядити батареїки, що не підлягають підзарядці. В будь-якому випадку не намагайтесь зробити коротке замикання в приладі для батерей.

HR

Važne obavijesti o bateriji
Nikada nemoj koristiti različite vrste baterija zajedno, isto tako ni kombinaciju starih i novih baterija. Uvijek izvadite baterije ako dugo nećeš koristiti proizvod ili ako su one potrošene. Nikada nemoj koristiti oštećene baterije. Koristi samo preporučenu vrstu ili odgovarajuću vrstu baterija. Umetni baterije pazite da dobro okreneš polove. Akumulatorske se baterije moraju puniti uz pomoć propisanog punjača i uz nadzor odrasle osobe. Baterije se ne smiju puniti dok su još u proizvodu i to nikada nemoj pokušavati. Nikada ne pokušavaj puniti baterije koje nisu predviđene za punjenje. Nikada ne izazivaj kratki spoj u držaču baterija.

SR

Важне информације о батеријама
Не користите различите типове батерија заједно нити комбинацију старих и нових батерија. Увек извадите батерије уколико производ нећете дуже време користити или уколико су батерије празне. Никада не користите оштећене батерије. Употребљавајте само препоручени тип батерија или одговарајућу замену. Ставите батерије тако да су полови правилно позиционисани. Батерије на пуњење се морају пунити одговарајућим пуњачем под надзором одраслог лица. Батерије не смеће да пуните нити да покушате пунити док су у производу. Никада не покушавајте да пуните батерије које не могу да се пуне. Никада не преспajaјте полове кућишта за батерије.

SL

Pomembne informacije o baterijah
Nikoli ne uporabljajte skupaj različnih baterij ali kombinacije starih in novih baterij. Vedno odstranite baterije, če izdelka dlje časa ne boste uporabljali ali če so iztrošene. Nikoli ne uporabljajte poškodovanih baterij. Uporabljajte le baterije priporočene ali ustrezne tipa. Baterije vstavite tako, da so njihovi polji pravilno obrnjeni. Akumulatorske baterije je treba polniti s pravim polnilnikom pod nadzorom odrasle osebe. Akumulatorskih baterij ni mogoče polniti, dokler so še v izdelku. Tega tudi ne smete poskušati. Nikoli ne poskušajte polniti baterij, ki niso akumulatorske. Pazite, da ležišč za baterije ne boste spravili v kratek stik.

RO

Informații importante despre baterii
Nu folosiți niciodată împreună tipuri diferite de baterii, sau o combinație de baterii vechi și noi. Îndepărtați întotdeauna bateriile dacă produsul nu este folosit timp îndelungat sau dacă bateriile s-au epuizat. Nu folosiți niciodată baterii deteriorate. Folosiți numai baterii de tipul recomandat, sau un tip corespunzător. Introduceți bateriile astfel ca polii să fie poziționați corect. Bateriile reincărcabile trebuie reincărcate utilizând încărcătorul corect sub supravegherea unui adult. Nu puteți reincărca bateriile în timp ce acestea sunt încă în produs, și niciodată nu trebuie să încercați să faceți acest lucru. Nu încercați niciodată să reincărcăți baterii nereîncărcabile. Nu scurtcircuitați niciodată suportul bateriei.

BG

Важна информация за батериите
Не използвайте различни типове батериите едновременно или комбинация от стари и нови батери. Винаги изваждайте батериите, ако изделието няма да се използва продължително време или ако батериите са се изтощили. Не използвайте повредени батери. Използвайте само батери от препоръчвания тип или съответстващ на него тип. Поставете батериите така, че полюсите да са разположени правилно. Аккумуляторните батери трябва да се зареждат с подходящо зареждащо устройство под надзора на възрастни. Батериите не могат да се зареждат, докато са поставени в изделието, така че не трябва да се опитвате да правите това. Не се опитвайте да зареждате батери, които не са акумулаторни. Не свързвайте в късо съединение контактите на отделението за батериите.

LV

Svarīga informācija par baterijām
Nekad vienlaikus nelietojiet dažādu tipu, kā arī vecas un jaunas baterijas. Vienmēr izņemiet baterijas, ja tās ir izlādējušas vai ja produkts ilgāku laiku netiek lietots. Nekad nelietojiet bojātas baterijas. Lietojiet tikai ieteicamā tipa vai atbilstoša tipa baterijas, lietotojot baterijas, ievietojiet pareizi polaritāti. Uzlādējamu bateriju lādēšanai izmantojiet atbilstošu bateriju lādētāju; uzlāde jāveic pieaugušu uzraudzībā. Baterijas nevar uzlādēt un nekad nedrīkst mēģināt uzlādēt, kamēr tas ievietots produktā. Nemēģiniet uzlādēt baterijas, kas nav uzlādējamas. Nepieļaujiet issavienojumu bateriju nodalījumā.

ET

Oluline teave patareide kohta
Ära kunagi kasuta koos erinevat tüüpi patareisid, samuti vanu ja uusi patareisid. Kui märguasja ei kasutata pika aja jooksul, võta patarei sellest välja. Ära kunagi kasuta kahjustatud patareisid. Kasuta ainult ettenähtud tüüpi või nelle samaväärseid patareisid. Pane patareid märguasja sisse nii, et pluss- ja miinusklemmi asend oleks õige. Akusid tuleb laadida ainult neile ettenähtud akulaadija abil täiskasvanu järelevalve all. Akusid ei saa laadida sel ajal, kui need on märguasja sees. Ära kunagi püüa nii teha. Ära kunagi proovi akulaadijaga laadida tavalisi patareisid. Patareipesa klemmide vahel ei tohi tekkida lühisid.

LT

Svarbi informacija apie elementus
Vienu metu nenaudokite skirtingu elementu, taip pat su naujais elementais nenaudokite senų. Jei nenaudosite gaminio ilgesnį laiką arba jei elementai išsekę, visuomet išimkite juos iš gaminio. Niekada nenaudokite pažeistų elementų. Naudokite tik rekomenduojamo arba atitinkamo tipo elementus. Elementus dėkite atsižvelgdami į jų poliškumą. Elementus galima įkrauti tik tinkamu krovikliu ir prižiūrint suaugusiųsiems. Jokių būdu negalima, ir niekuomet nebandykite įkrauti elementu įkrauti vienkartinių elementu. Saugokitės, kad elementų dėkle nesukeltumėte trumpojo jungimo.

TR

Piller hakkında önemli bilgiler
Hiçbir zaman değişik tipte pilleri ya da eski pilleri yeni pilleri bir arada kullanmayın. Uzun süre pilli kullanılmayacaksa ya da piller bitmişse, pilleri çıkarın. Hiçbir zaman zedelenmiş piller kullanmayın. Sadece önerilen tipte piller ya da bunların dengi olan piller kullanın. Pilleri kutupları doğru konumda olacak şekilde yerleştirin. Bitince sarılı pilleri doğru pil sarı aletini kullanarak, bir yetişkinin denetiminde sarıl edin. Sarılı pilleri, ürünün içindeyken sarıl edemezsiniz ve hiçbir zaman bunu yapmaya çalışmayın. Hiçbir zaman, sarılı olmayan pilleri sarıl etmeye çalışmayın. Hiçbir zaman pil kutusuna kısa devre yaptırmayın.



EN	Protect the environment by not disposing of this product with your household waste (2002/96/EC). Check with your local authority for recycling advice and facilities.
DE	Schützen Sie die Umwelt und entsorgen Sie dieses Produkt nicht mit Ihrem Hausmüll (2002/96/EC). Informationen zu Recycling-Möglichkeiten erhalten Sie bei den örtlichen Behörden.
FR	Protégez l'environnement : ne jetez pas ce produit avec vos autres déchets ménagers (Directive européenne 2002/96/EC). Contactez les autorités locales pour obtenir des informations sur le recyclage et connaître les points de collecte.
IT	Proteggi l'ambiente! Non smaltire questo prodotto con i rifiuti domestici (2002/96/EC). Per consulenza sul riciclaggio dei rifiuti e le strutture di riciclaggio, rivolgerti alle proprie autorità locali.
NL	Bescherm het milieu: gooi dit product niet samen met het andere huisvuil weg (2002/96/EC). Raadpleeg de plaatselijke instanties voor locaties van milieustations en advies over hergebruik.
ES	Proteja el medio ambiente no deshaciéndose de este producto junto con sus residuos domésticos (2002/96/EC). Solicite a su autoridad local consejos e información sobre instalaciones de reciclado.
DA	Beskyt miljøet! Smid ikke dette produkt ud sammen med husholdningsaffaldet (2002/96/EC). Få vejledning om genbrug og genbrugsstationer hos din kommune.
FI	Tämä tuote on hävitettävä ympäristönsuojelun vuoksi asianmukaisesti talousjätteistä erillään (2002/96/EC). Tietoja kierrätyspisteiden sijainnista saa kunnan tai kaupungin teknisestä virastosta.
SV	Skydda miljön genom att inte kasta denna produkt bland ditt hushållsavfall (2002/96/EC). Kontakta din kommun för frågor om återvinning och miljöstationer.
PT	Proteja o ambiente não eliminando este produto com o seu lixo doméstico (2002/96/CE). Consulte as autoridades locais para informação sobre reciclagem e sistemas de recolha.



EL	Προστατέψτε το περιβάλλον. Μην πετάτε αυτό το προϊόν μαζί με τα συνηθισμένα οικιακά απορρίμματα (2002/96/EC). Επικοινωνήστε με τις τοπικές αρχές σχετικά με συμβουλές και εγκαταστάσεις ανακύκλωσης.
JA	環境保護のため、本製品は家庭ごみとは別に処分してください (2002/96/EC)。リサイクルに関する指示や施設については、お住まいの地方自治体にお問い合わせください。
ZH	注意保护环境，请勿将本产品与家庭垃圾一起丢弃处理 (2002/96/EC)。请咨询您当地相关部门，了解回收设施与回收建议。
KO	환경 보호를 위해 이 제품을 생활폐기물과 함께 버리지 마십시오(2002/96/EC). 재활용 방법 및 시설에 관한 사항은 현지 관계 당국에 문의하십시오.
RU	Защищайте окружающую среду, не утилизируйте этот продукт вместе с бытовым мусором (директива 2002/96/EC). Осведомитесь у местных органов власти о правилах вторичной переработки и утилизации таких отходов.
PL	Aby chronić środowisko naturalne, nie należy wyrzucać tego produktu wraz z odpadkami z gospodarstwa domowego (2002/96/WE). W celu uzyskania wskazówek dotyczących recyklingu oraz adresów zakładów należy skontaktować się z lokalnym urzędem.
CZ	Nevyhazujte tento produkt do domácího odpadu, chráňte životní prostředí (2002/96/EC). Zjistěte si prosím u místních úřadů možnosti recyklace a dostupná zařízení.
SK	Nevyhádzajte tento produkt do domáceho odpadu, chráňte životné prostredie (2002/96/EC). Zistite si prosím na miestnych úradoch možnosti recyklácie a dostupné zariadenia.
HU	Környezetét óvja, ha ettől a terméktől nem a háztartási hulladékkal együtt válik meg (2002/96/EC). Érdeklődjék a lakóhelyéhez közel eső hatóságnál az újrahasznosítás módjáról és lehetőségeiről.
UA	Допоможіть захистити довкілля: не утилізуйте цей виріб разом із побутовим сміттям (2002/96/EC). Вказівки з утилізації та відомості про пункти прийому з'ясуйте в місцевих компетентних органах.



HR	Zaštitite okoliš tako da ovaj proizvod ne odložite u otpad zajedno s kućanskim otpadom (2002/96/EZ). Od lokalnih vlasti zatražite savjet ili informacije o pogonima za recikliranje.
SR	Zaštitite životnu sredinu tako što nećete odlagati ovaj proizvod sa kućnim otpadom (2002/96/EC). Obratite se lokalnoj ovlašćenoj službi da biste dobili savete o recikliranju i saznali o objektima za reciklažu.
SL	Zaščitite okolje! Okolje varujte tako, da tega izdelka ne zavržete skupaj z gospodinjскими odpadki (v skladu z direktivo 2002/96/ES). Pri krajevni upravi preverite, kakšne možnosti in kateri obrati za recikliranje obstajajo v vaši okolici.
RO	Protejați mediul înconjurător și nu vă debarașiți de acest produs împreună cu deșeurile menajere (2002/96/CE). Consultați autoritățile locale pentru îndrumări și facilități de reciclare.
BG	Защитете околната среда и не изхвърляйте този продукт заедно с битовите си отпадъци (2002/96/EO). Свържете се с местните власти относно съвети и съоръжения за рециклиране.
LV	Lai saudzētu vidi, neizmetiet šo izstrādājumu kopā ar sadzīves atkritumiem (2002/96/EC). Vērsieties vietējās varas iestādēs, lai noskaidrotu, kur un kā tas nododams pārstrādei.
ET	Keskkonda saate kaitsta nii, et ei kõrvalda seda toodet koos olmejäätmetega (2002/96/EÜ). Nõuandeid toote taaskasutusse võtmise ja ümbertöötlemispunktide kohta saate asjaomastel kohalikul asutustel.
LT	Saugokite aplinką – nemeskite šio produkto kartu su buitinėmis atliekomis (2002/96/EB). Atsižvelkite į savo vietos valdžios rekomendacijas dėl pakartotinio panaudojimo ir sąlygas.
TR	Bu ürünü, evsel atıklarla birlikte atmayarak çevreyi koruyun (2002/96/EC). Geri dönüşüm tavsiyeleri ve tesisler hakkında bilgi için yerel yönetimle iletişime kurun.

This device complies with part 15 of the FCC Rules. Operation is subject to the following two conditions: (1) This device may not cause harmful interference, and (2) this device must accept any interference received, including interference that may cause undesired operation.

NOTE: This equipment has been tested and found to comply with the limits for a Class B digital device, pursuant to part 15 of the FCC Rules. These limits are designed to provide reasonable protection against harmful interference in a residential installation. This equipment generates, uses and can radiate radio frequency energy and, if not installed and used in accordance with the instructions, may cause harmful interference to radio communications. However, there is no guarantee that interference will not occur in a particular installation. If this equipment does cause harmful interference to radio or television reception, which can be determined by turning the equipment off and on, the user is encouraged to try to correct the interference by one or more of the following measures:

- Reorient or relocate the receiving antenna.
- Increase the separation between the equipment and receiver.
- Connect the equipment into an outlet on a circuit different from that to which the receiver is connected.
- Consult the dealer or an experienced radio/TV technician for help.

Caution: Changes or modifications not expressly approved by the party responsible for compliance could void the user's authority to operate the equipment.

This Class B digital apparatus complies with Canadian ICES-003.
Cet appareil numérique de la classe B est conforme à la norme NMB-003 du Canada.



Remote Control

Fernbedienung
Télécommande
Control Remoto
Comando à Distância
Távírányító
远程控制



ON/OFF
An/Aus
Marche/arrêt

Encendido/apagado
Ligado/Desligado
Be/ki

开/关

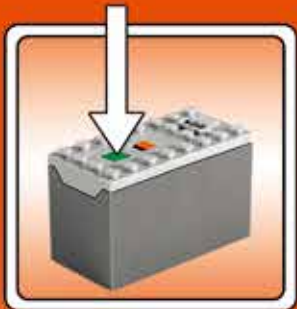

Battery Box

Batteriebox
Boîtier à piles
Batería
Bateria
Elemtartó doboz
电池盒





Change direction of train
Änderung der Fahrtrichtung
Change le sens de la marche du train
Cambia la direzione del treno
Verander de rijrichting van de trein
Cambia la dirección del tren
Skift togets retning
Junan kulkusuunnan vaihtaminen
Ändra tågets riktning
Mudar a direcção do comboio
Αλλάξε την κατεύθυνση του τρένου
トレインの進行方向を変える
改变列车方向
회전 방향 바꾸기
Изменение направления движения поезда
Zmień kierunek jazdy pociągu
Změna směru vlaku
Zmena smeru vlaku
A menetirány átváltása
Переключатк напрямків руху потяга
Promjena smjera vlaka
Промени смер воза
Spremeni smer voznje vlaka
Schimbă direcția trenului
Променете посоката на движение на влака
Maini vilciēna kustības virzienu
Rongji soidusuuna muutmīne
Pakeisk traukinio kryptį
Tren yönünü deęiřtirin

Turn wheel and change speed
Einstellung der Fahrtgeschwindigkeit
Tourne le volant et change de vitesse
Gira la rotellina e cambia velocit a
Draai het wiel voor meer of minder snelheid
Gira la rueda para cambiar la velocidad del tren
Drej hjulet, og skift hastighed
Nopeuden s a t o k aant opyr all a
Vrid p  ratten och  ndra hastighet
Rodar o bot o para alterar a velocidade
Γυρίσε τον τροχ  και  λλαξε ταχύτητα
車輪を回転させる / スピードを変える
转向与改变速度
바퀴를 돌려 속도 바꾸기
Поверните колесико, чтобы изменить скорость
Obr c ko o, by zmienic predkořc
Oto  kole ekem a zme n rychlost
Oto  kolieskom a zme n rychlost
A ker ek elforgat as val a sebess g v ltozik
Обертанням колеса змінюється швидк сть
Brzina se podeřava okretanjem kota ica
Okreni to kniћ da promeniř brzinu
Zavrti koleřeřek in spremeni hitrost
Roteřte roata ři schimb  viteza
Zavъртете колелото, за да промените скоростта
Pagriez ripu un maini  trumst
Keera rooli ja muuda kiirust
Pasuk ratuka ir pakeisk greitį
Tekeri  evirip hizi deęiřtirin



Train trouble-shooting guide
Anleitung zur Fehlerbehebung bei Z gen
Guide de d pannage du train
Guia de solu i o de problemas ferroviarios
Guia de resolu i o de problemas do comboio
Vas ti javit si  tmutat 
列车故障指南

LEGO.com/city



Remote Control

Fernbedienung
Télécommande
Control Remoto
Comando à Distância
Távirányító
远程控制



Receiver

Empfänger
Récepteur
Receptor
Vevő
接收器

8 Channels Frequenzen canaux
canales canals csatorna 频道





LEGO.com/brickseparator

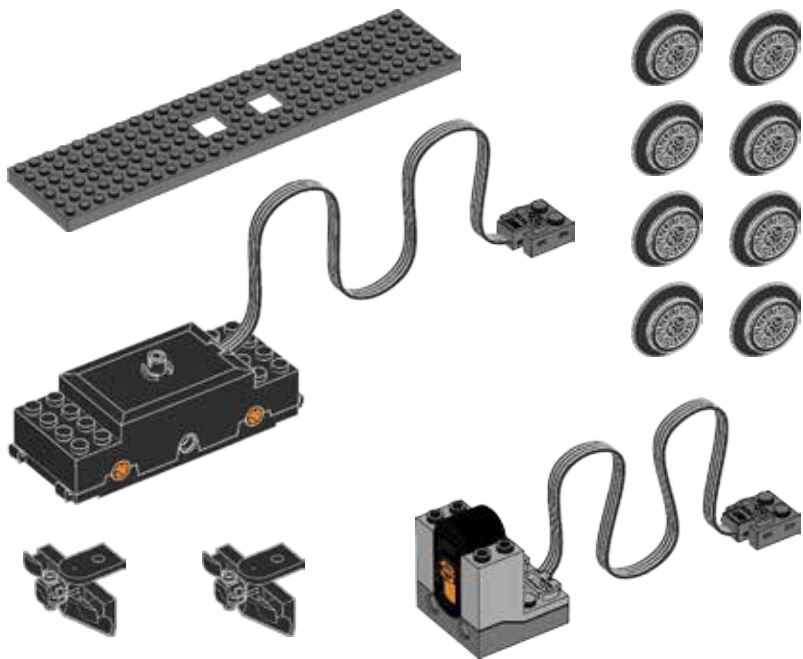

+

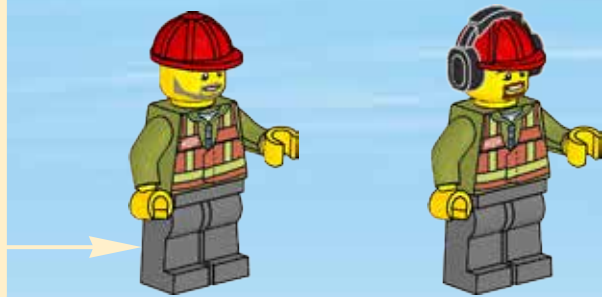
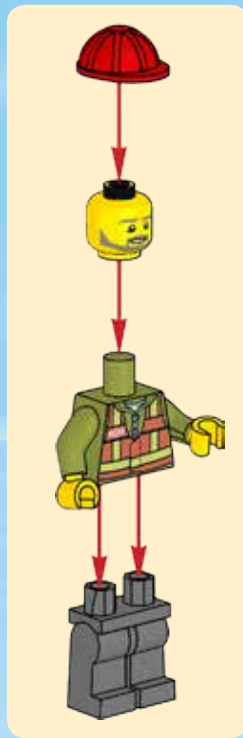
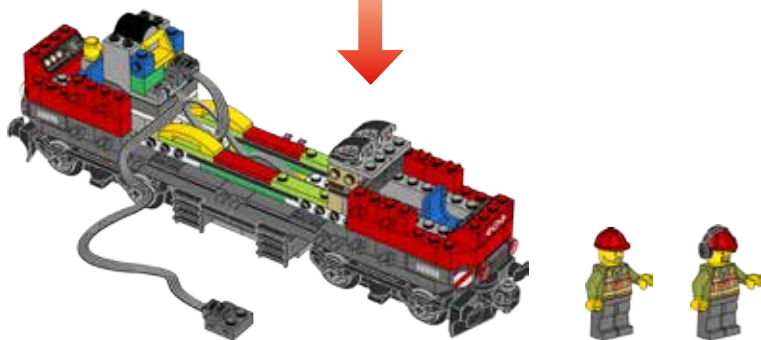

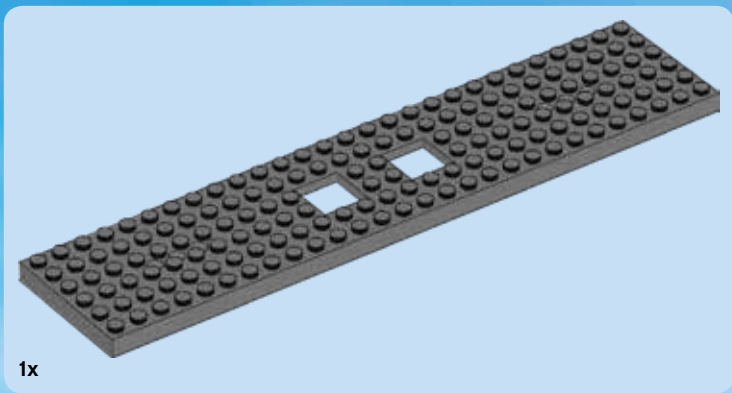

1x

1

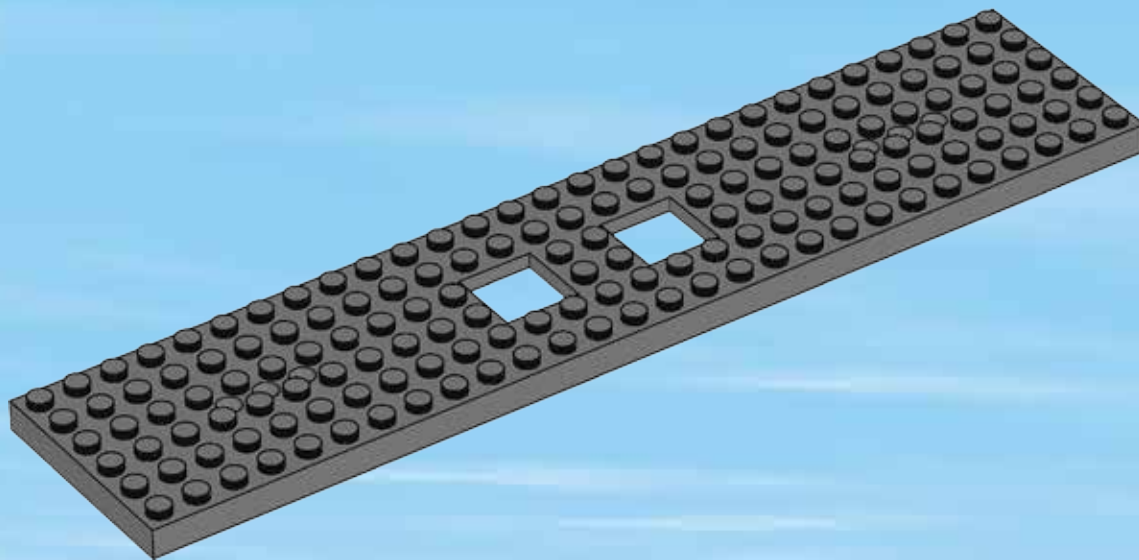

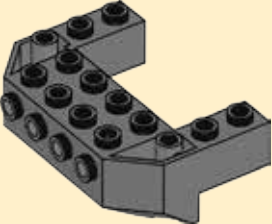

2

1 

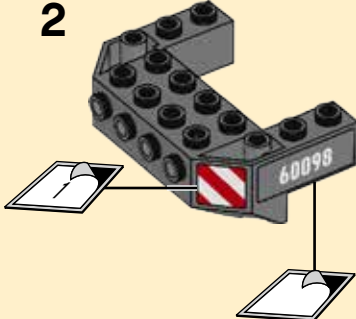
2 

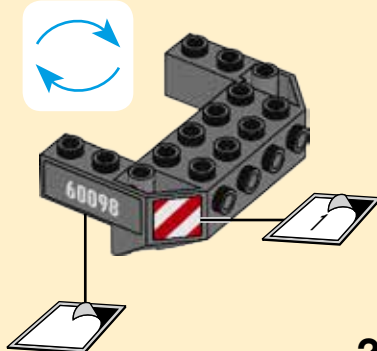
3 

2x

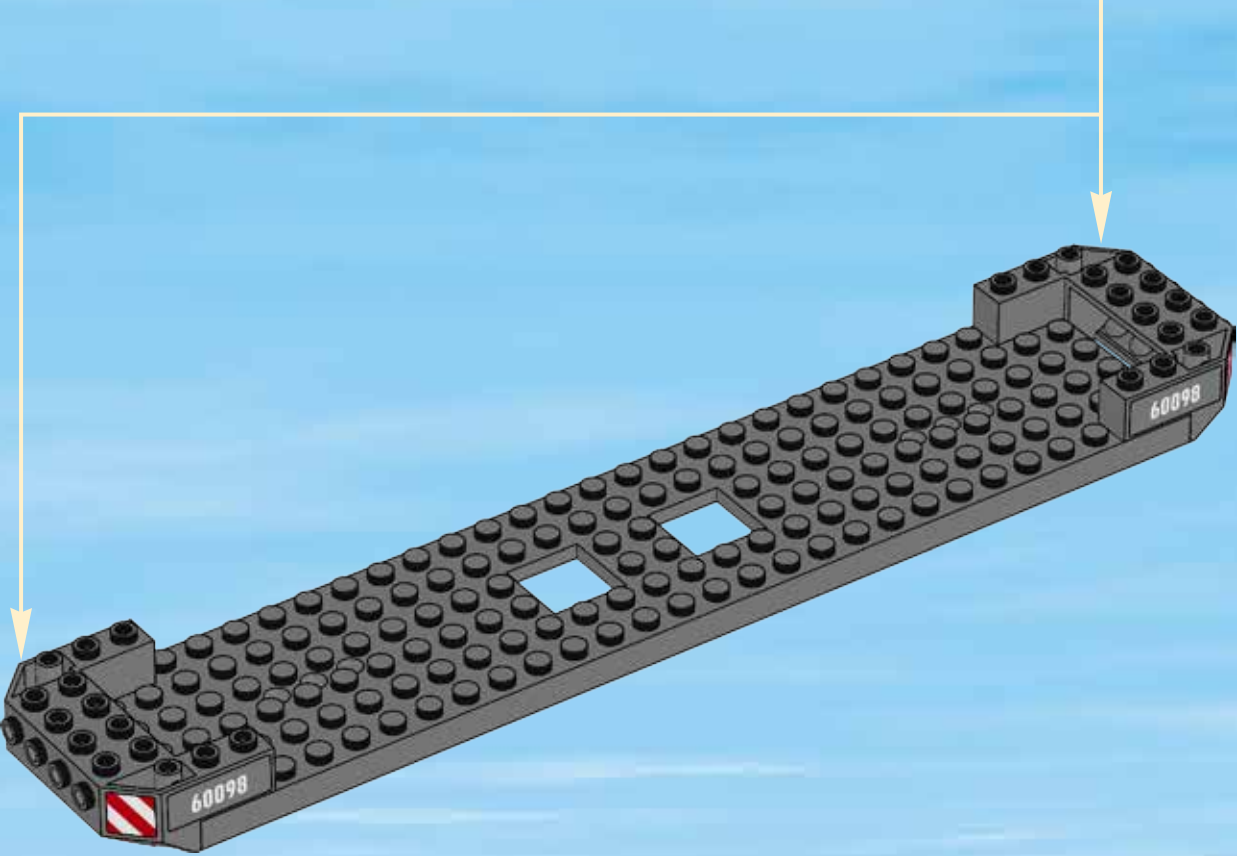

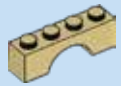

4x

3

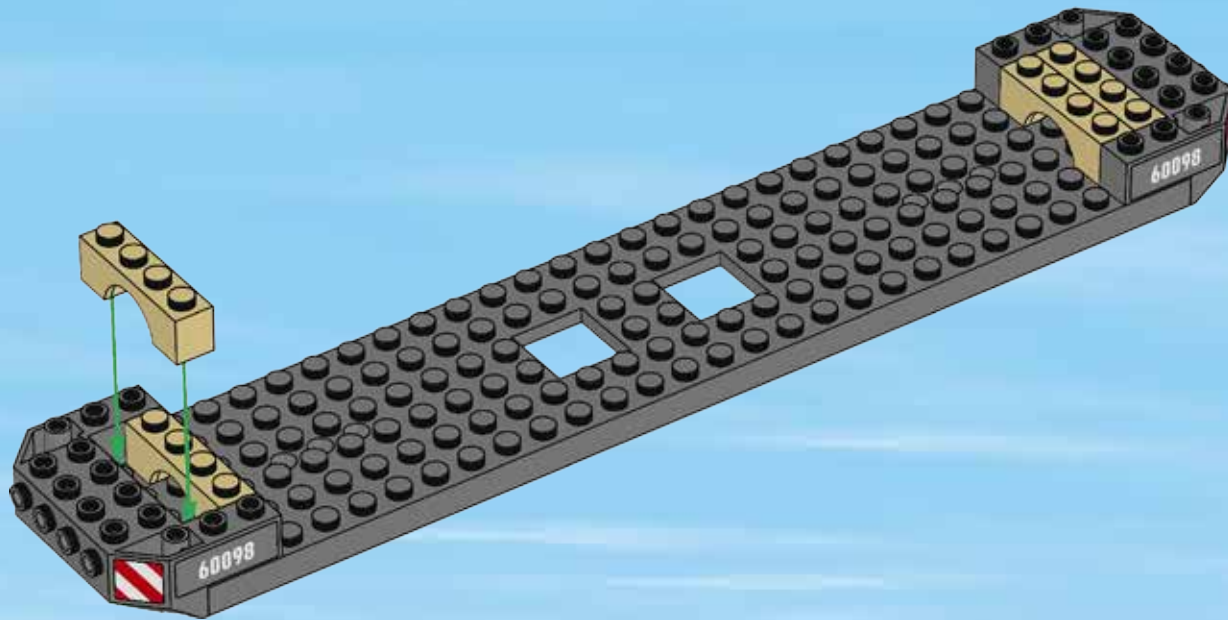



8x

4

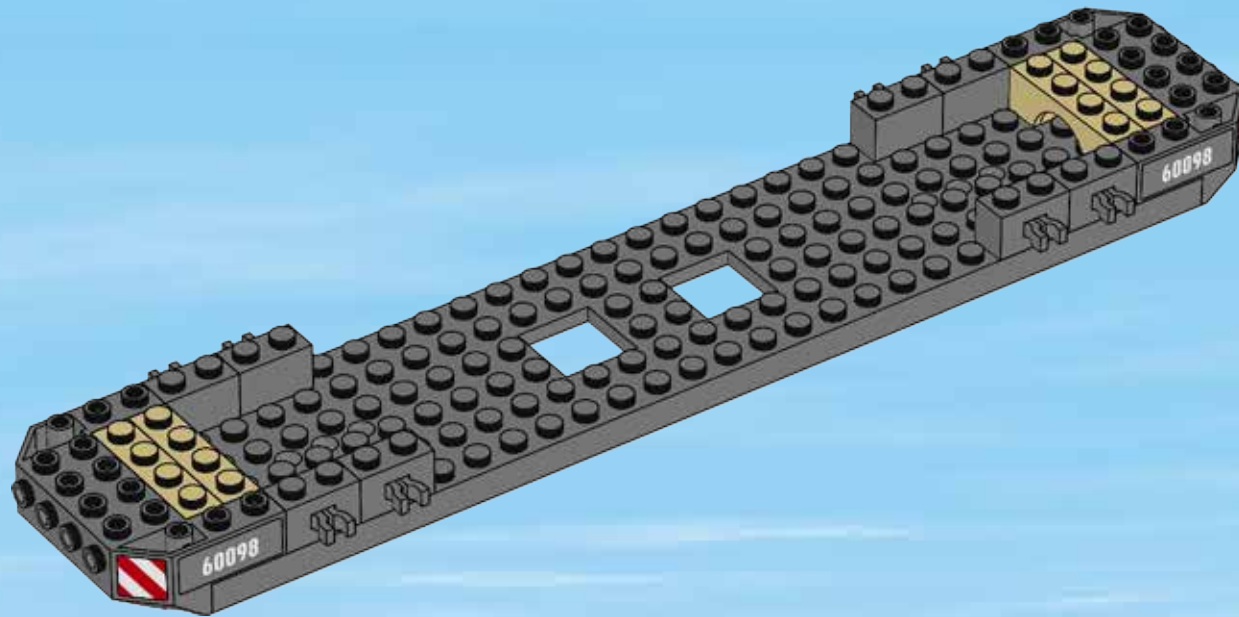



6

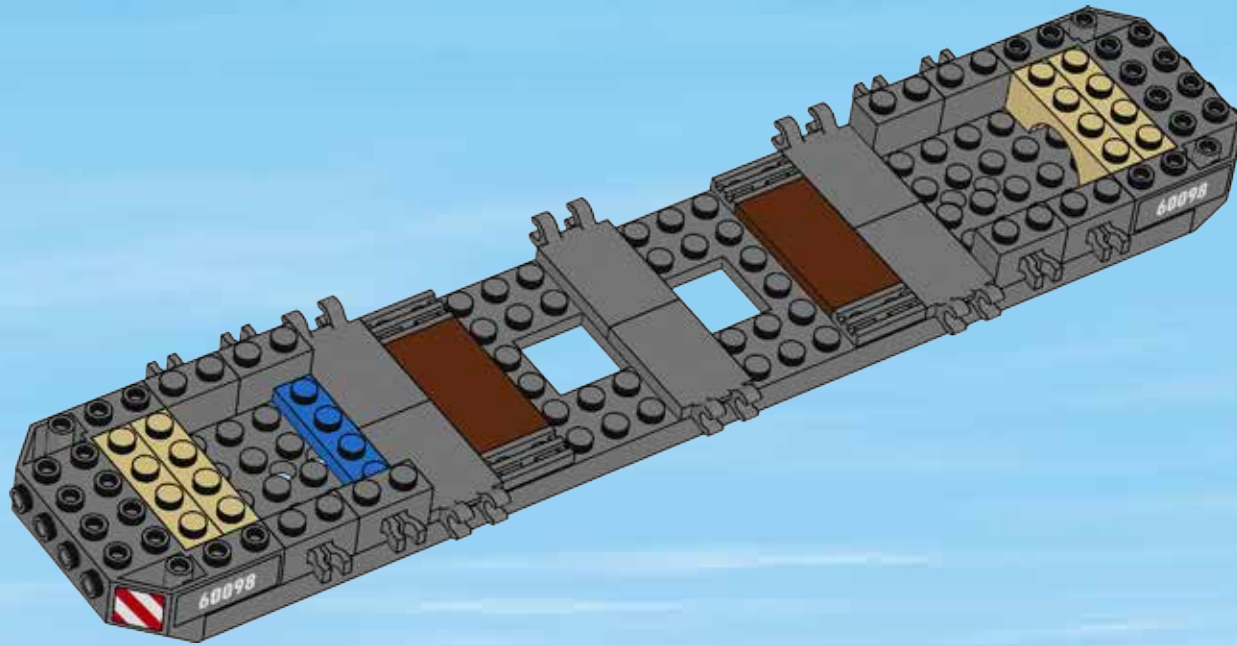



4x

7

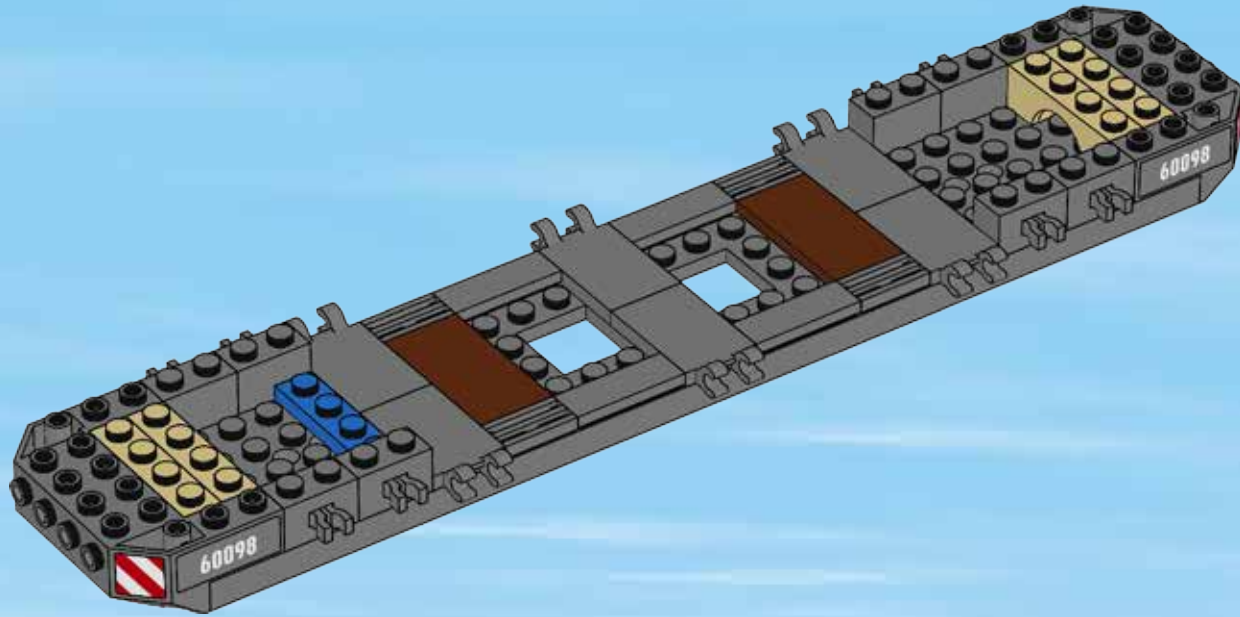



4x



3x

8

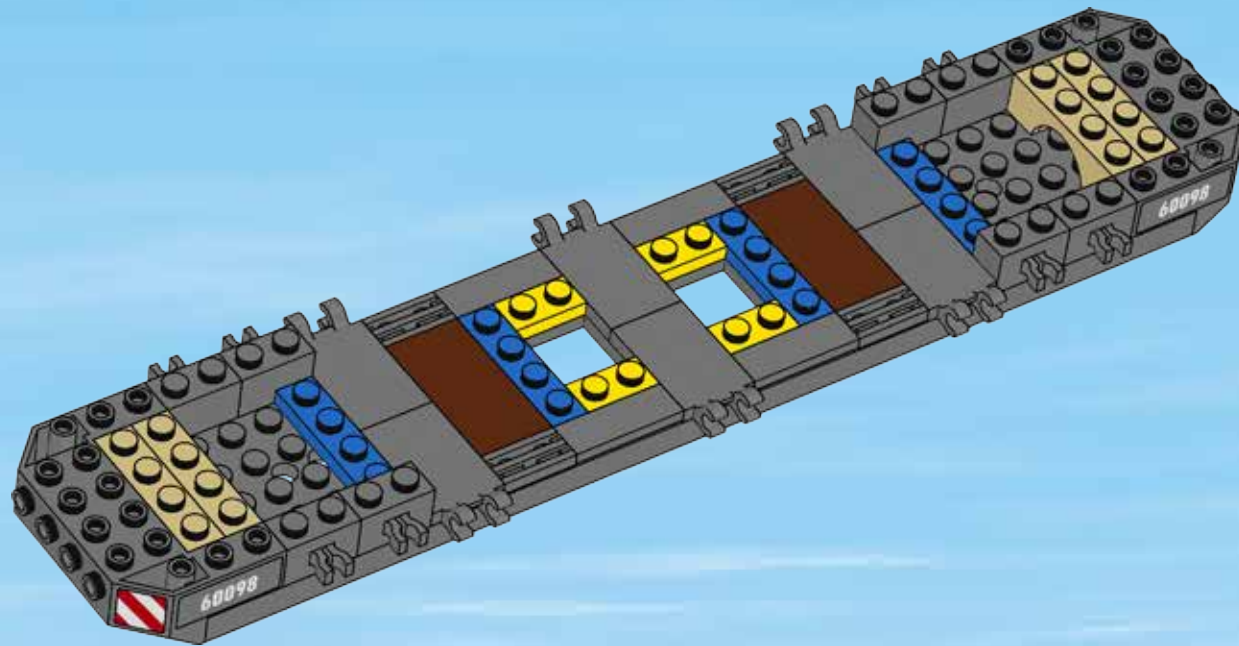



4x

9

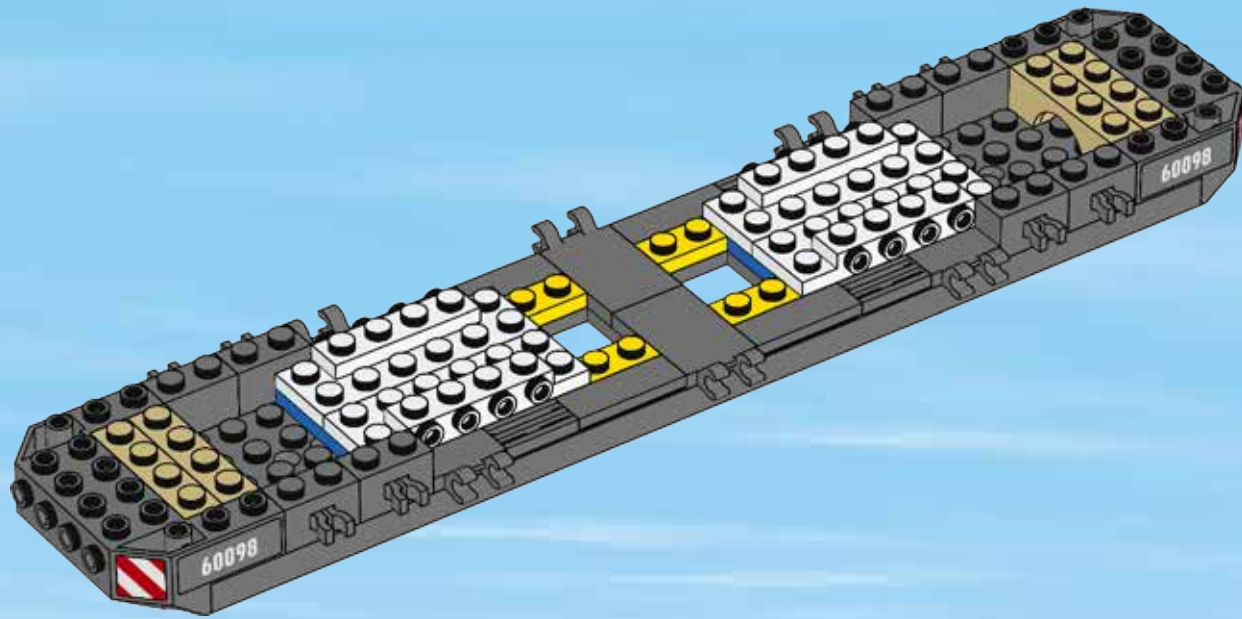



2x

10

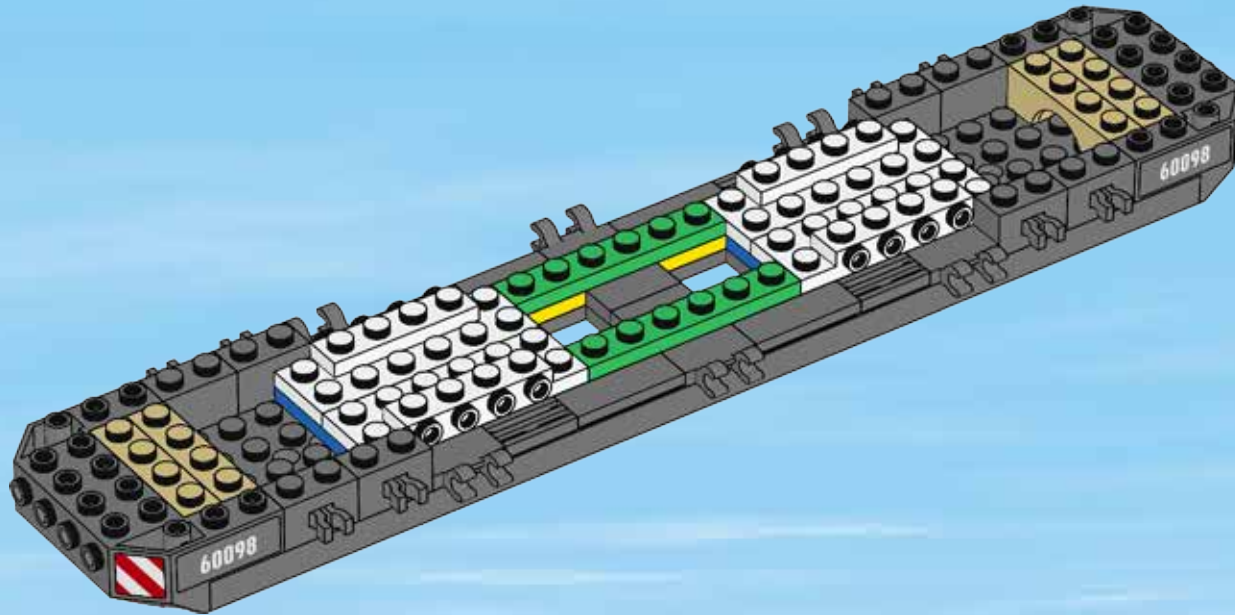

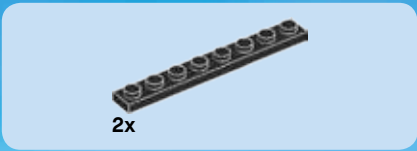

11

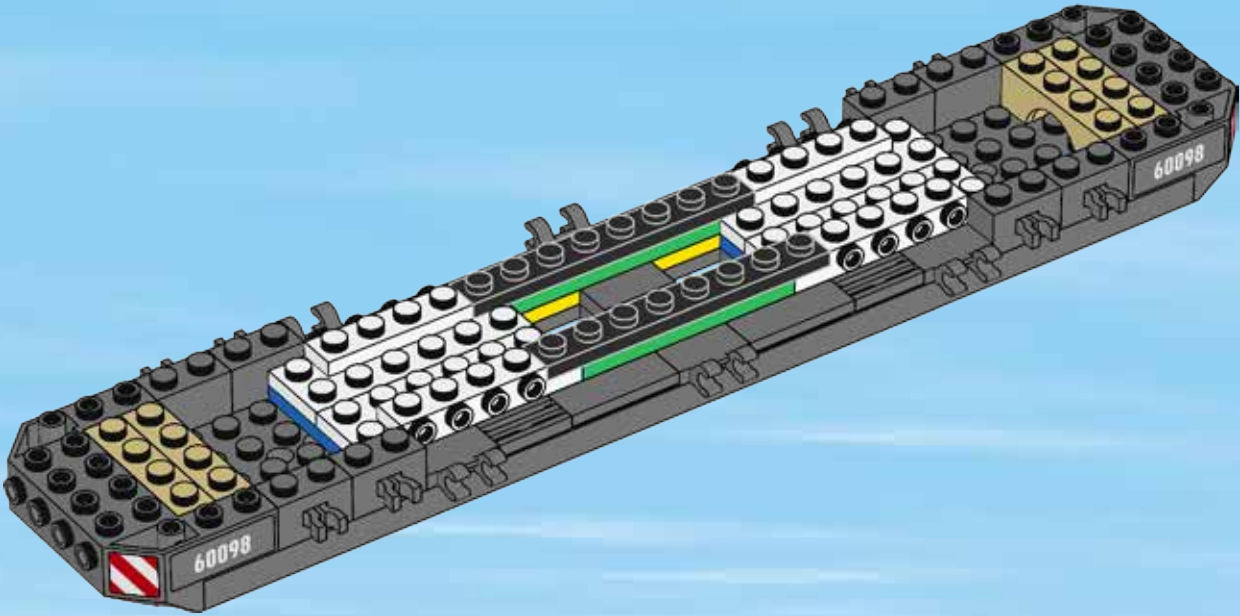



2x



4x

12

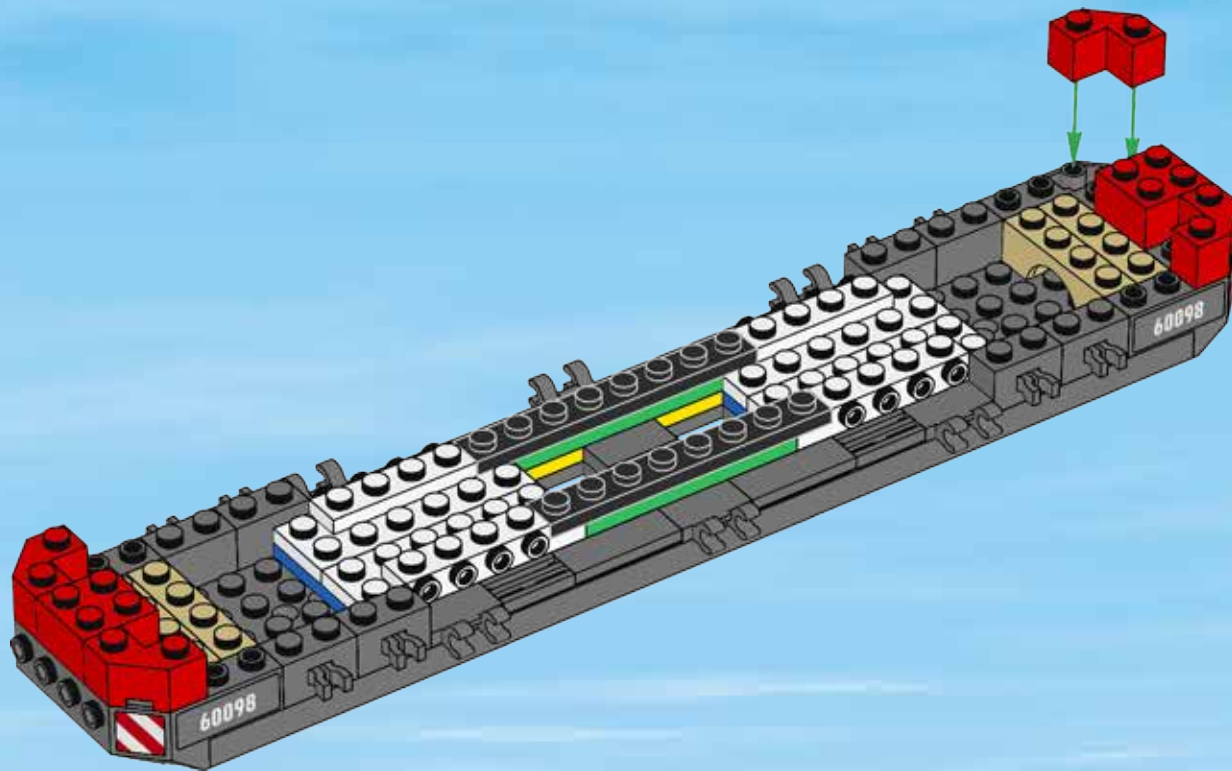

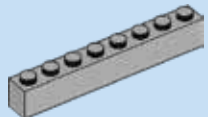

4x



2x

13

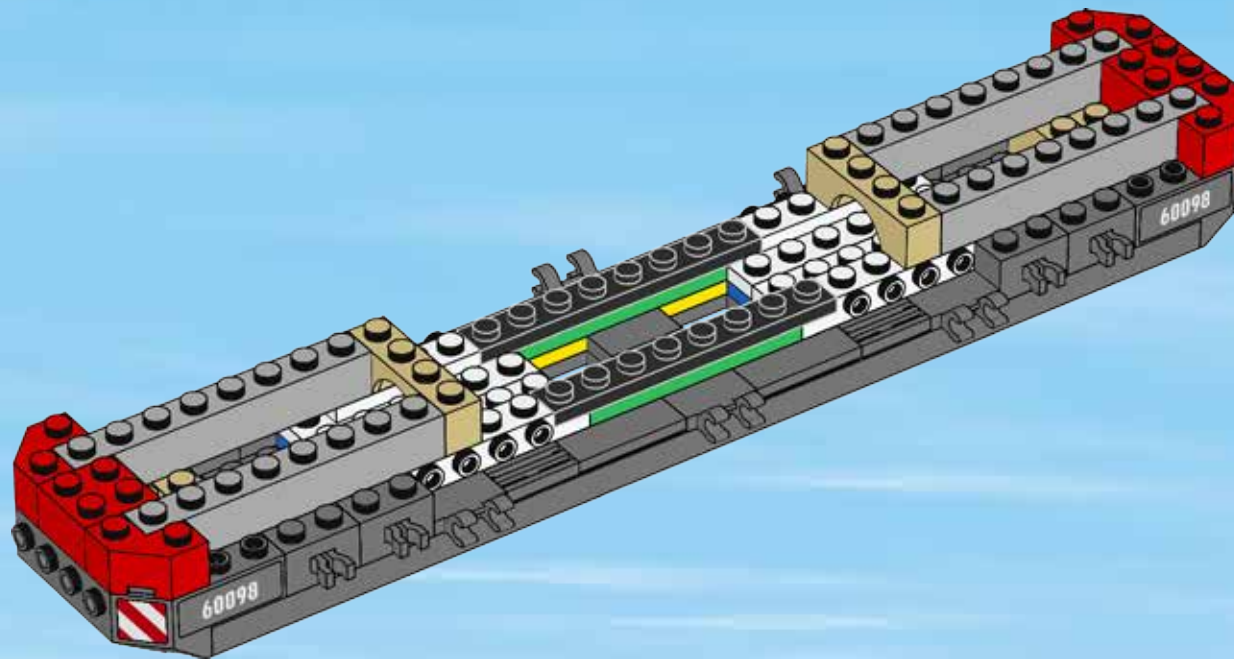

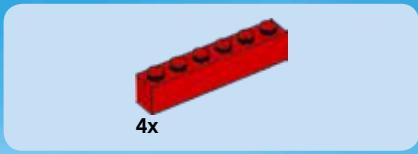

14

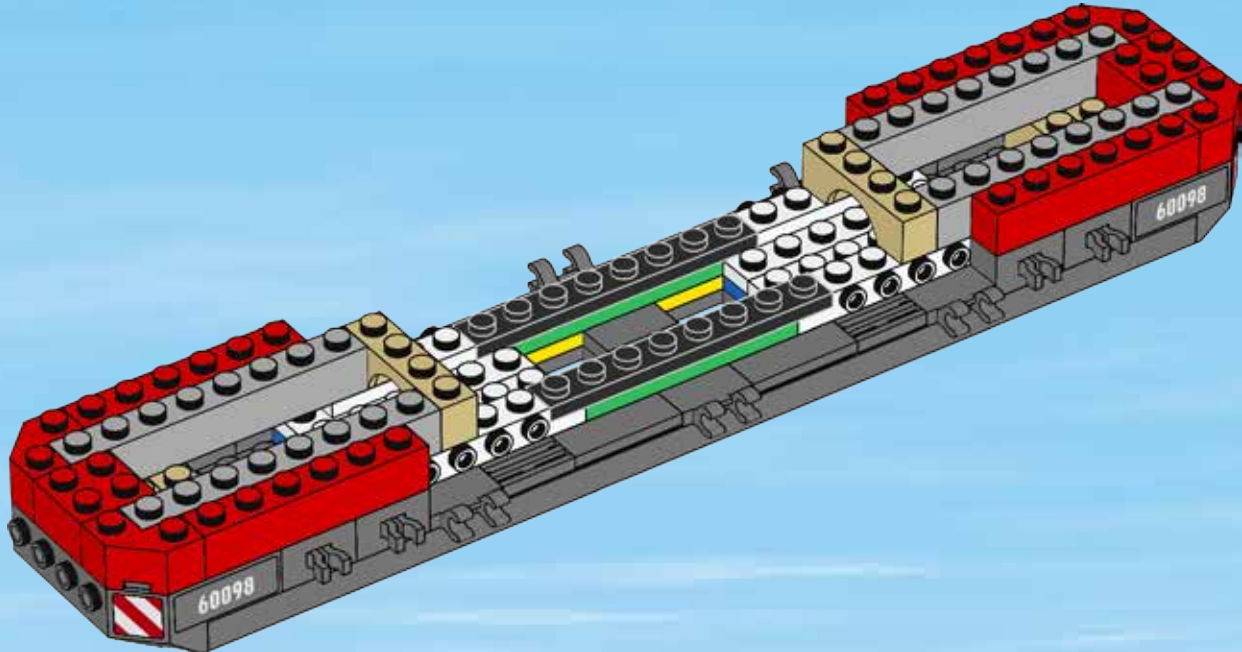



2x



4x

15

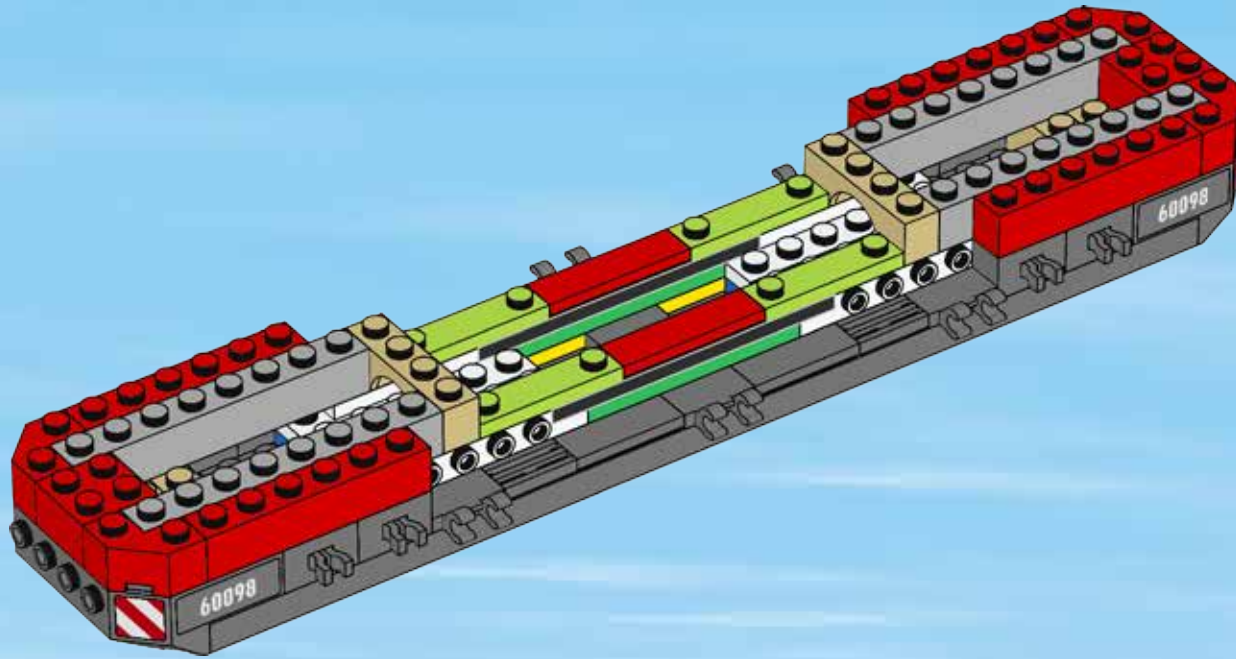

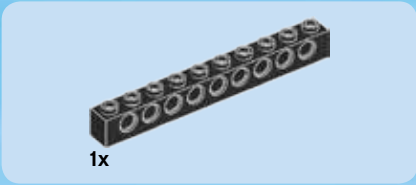
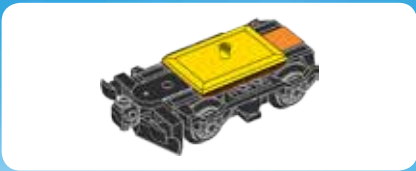

1

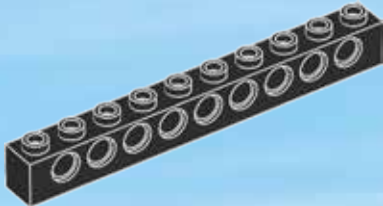

2

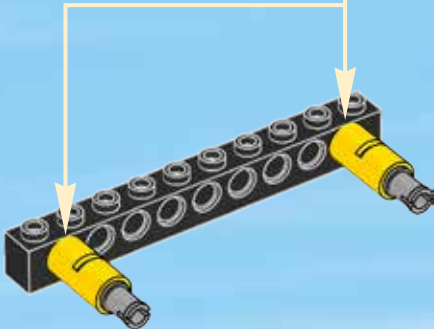
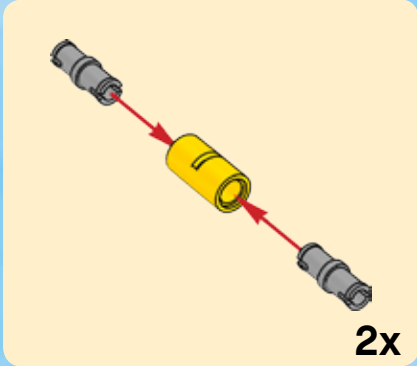



2x

3

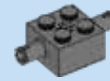
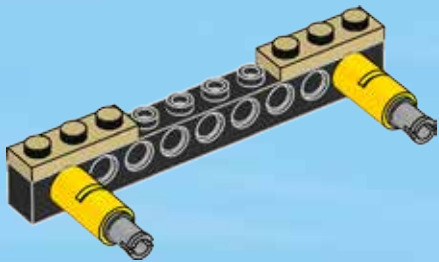

2x

4

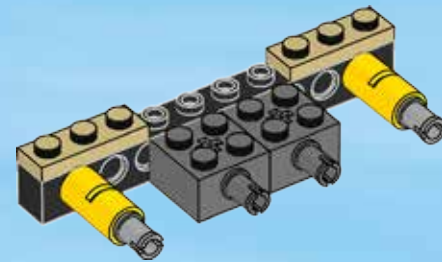



5

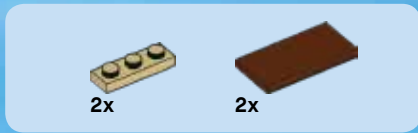
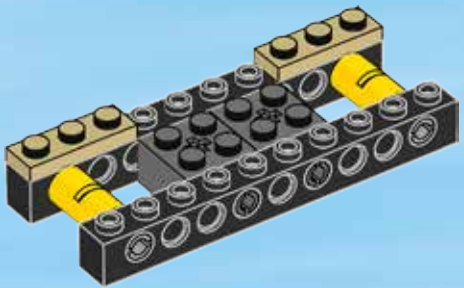

6

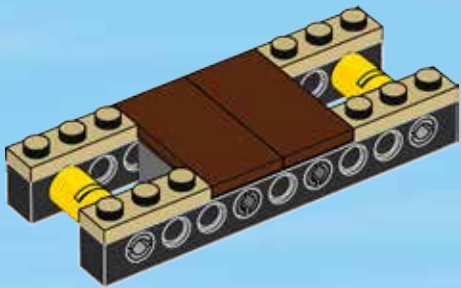

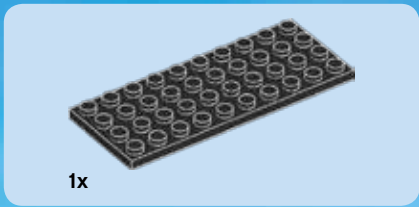

7

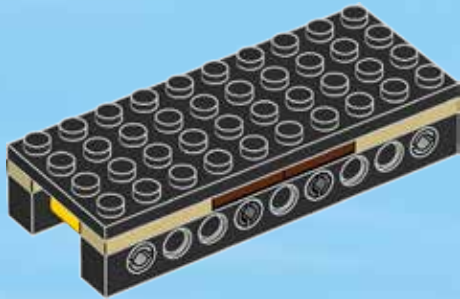

8

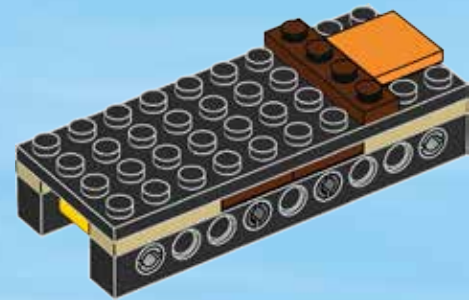



3x

9

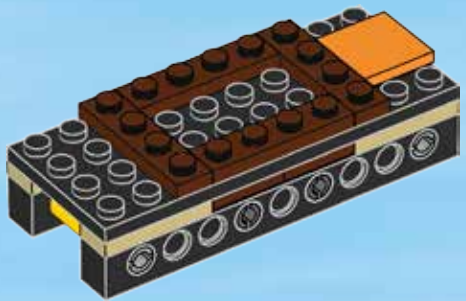

1x

10

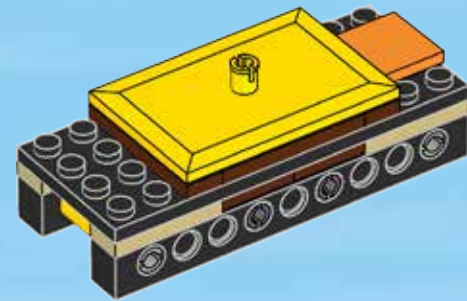

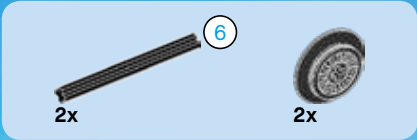

11

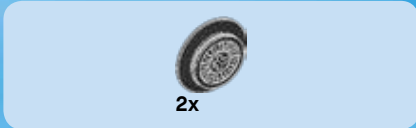
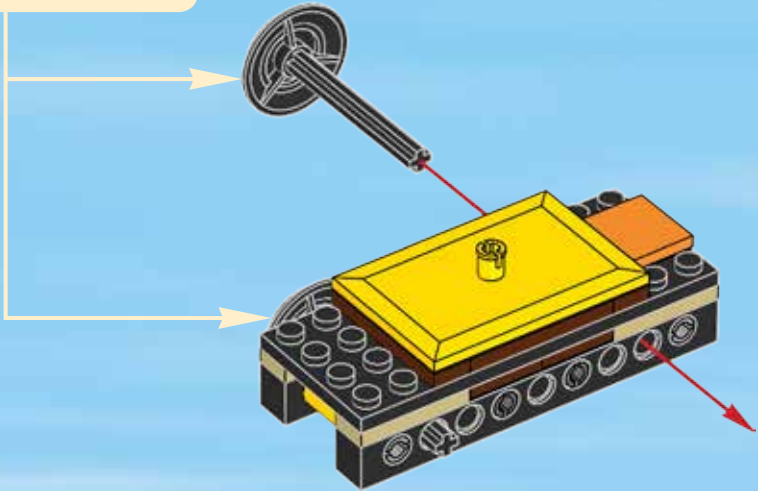
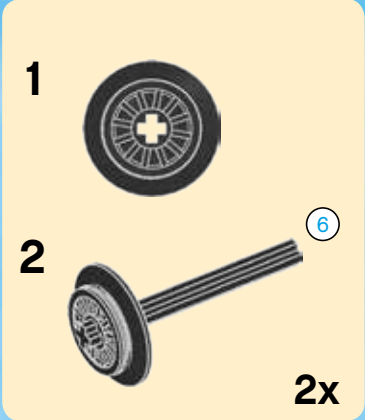

12



16

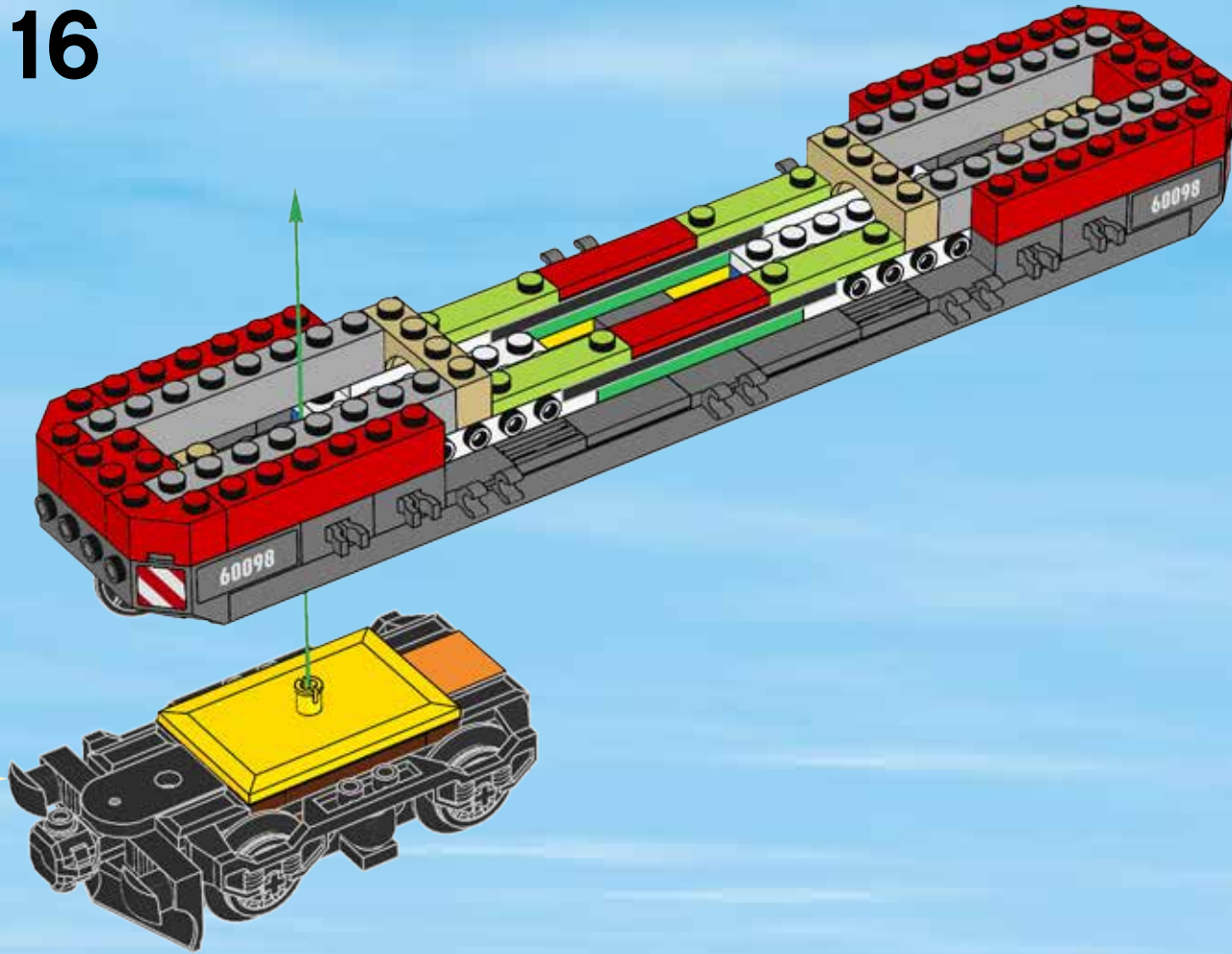



1x



2x

17

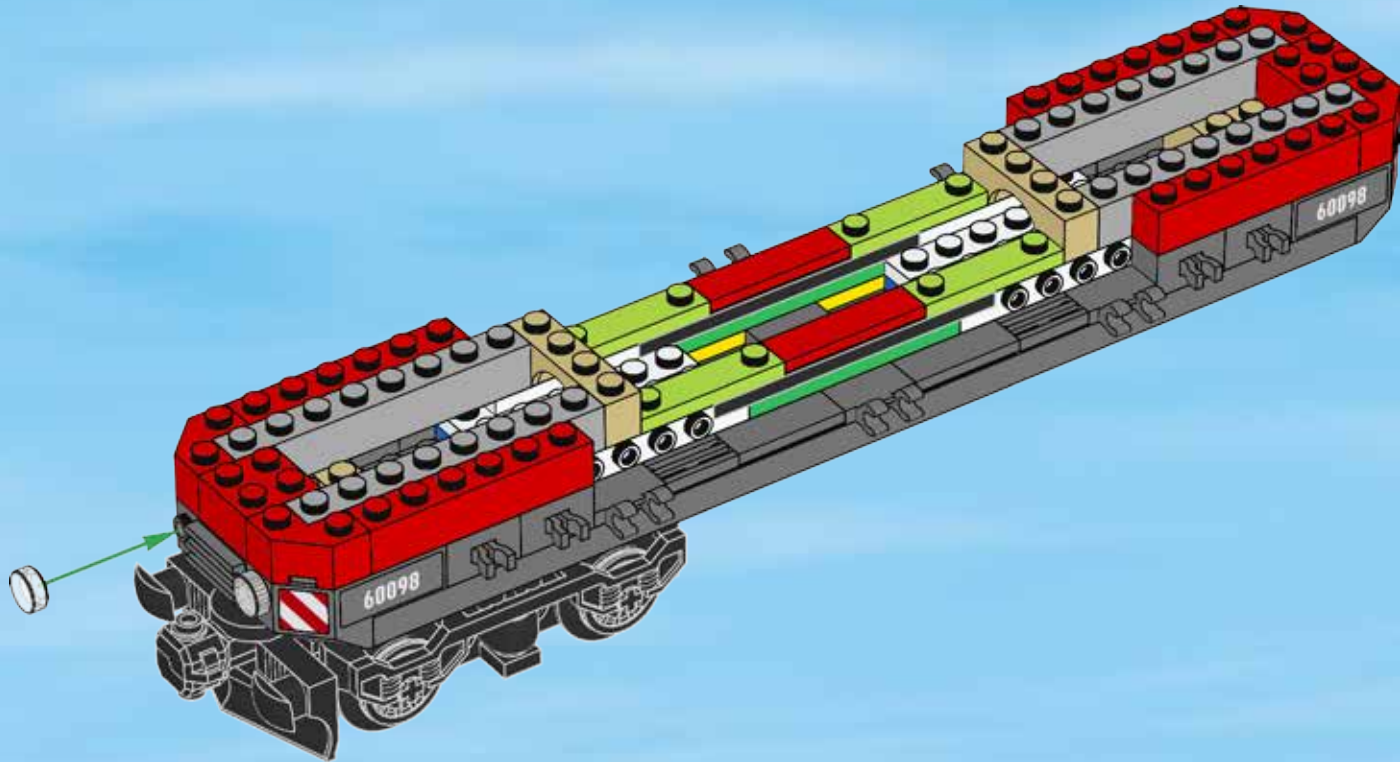

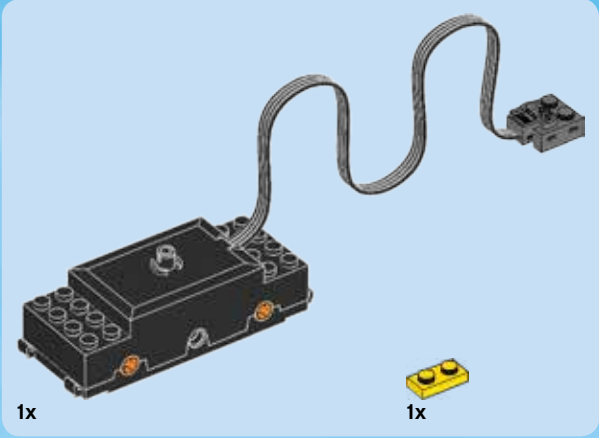
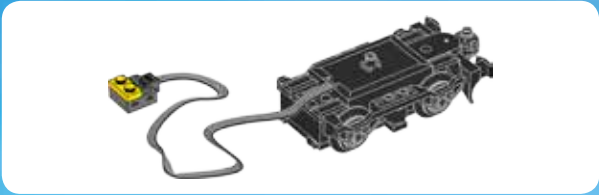

1

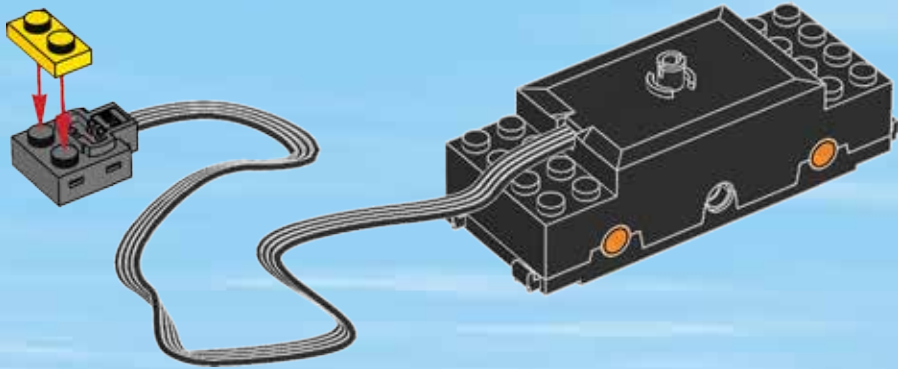

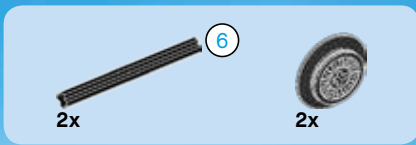

2

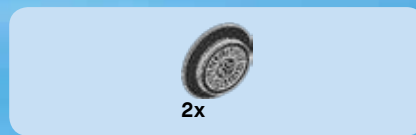
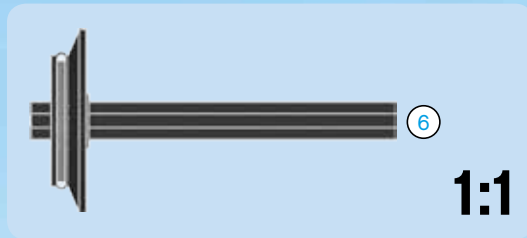
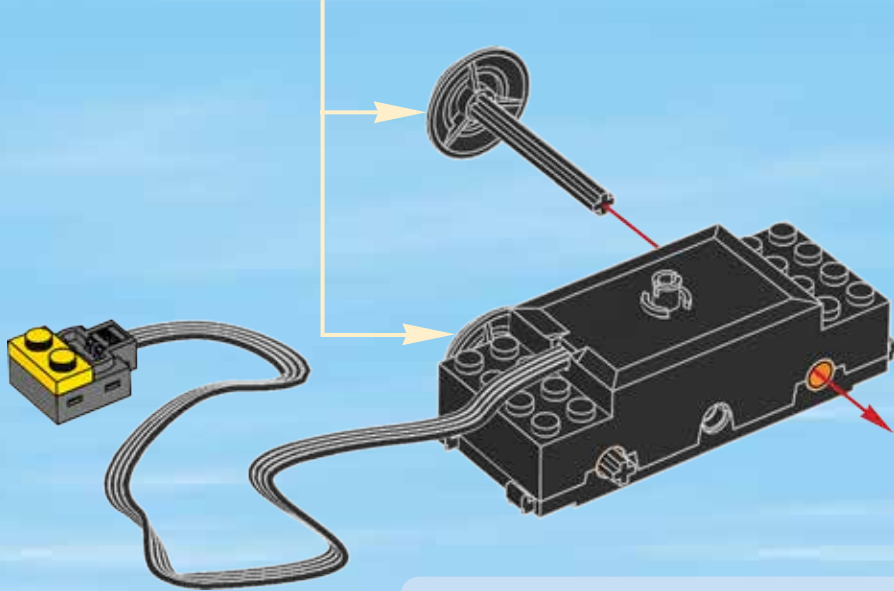
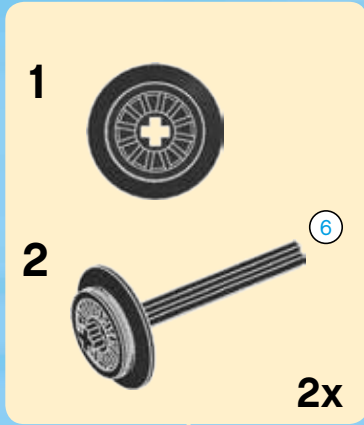

3

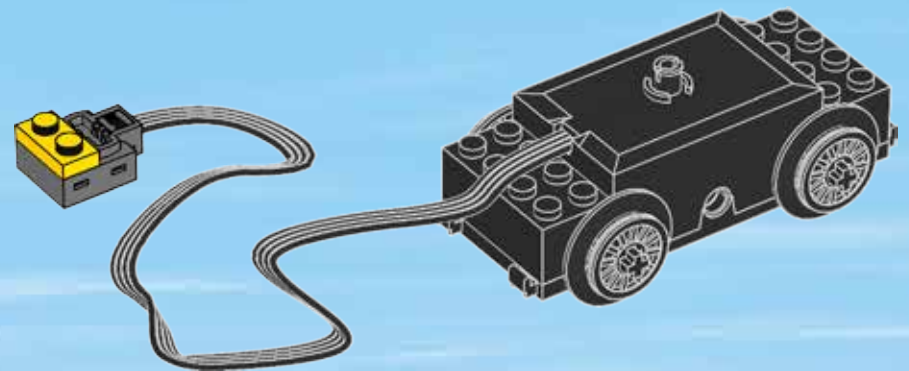

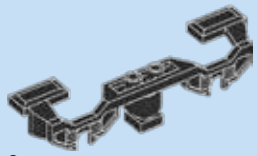

2x

4

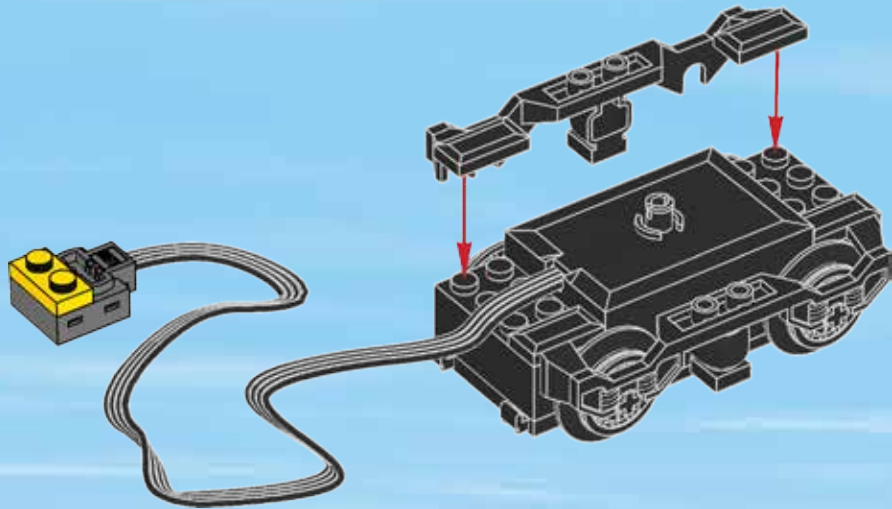

1x

5

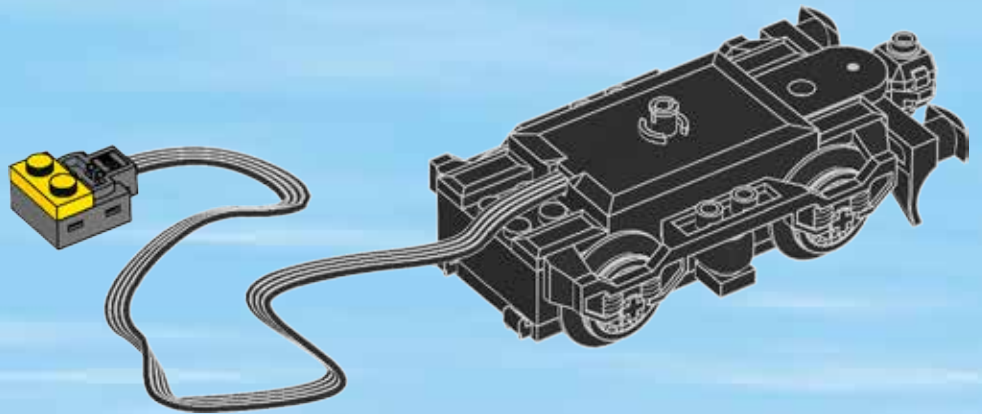

18

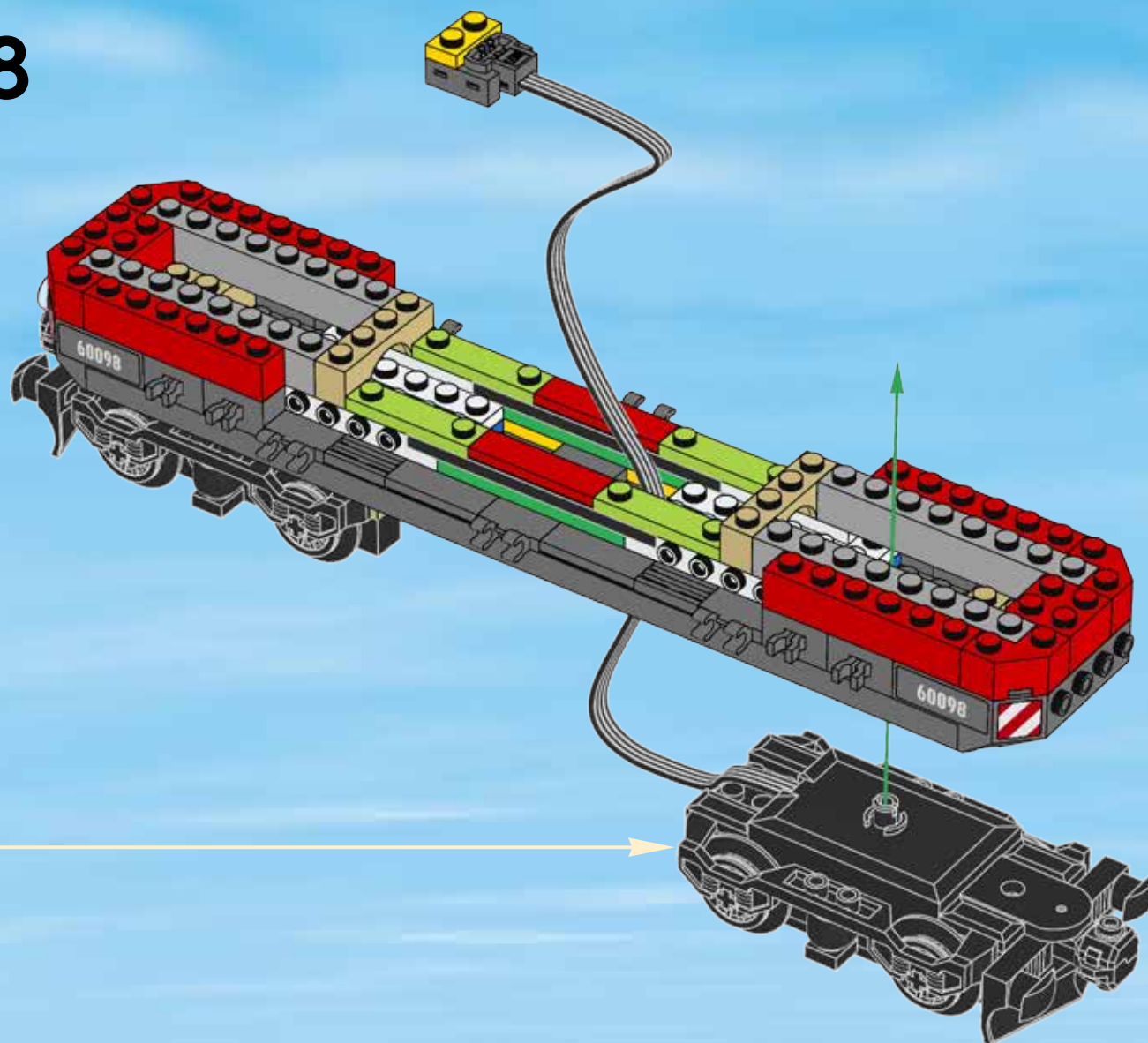



1x



2x

19

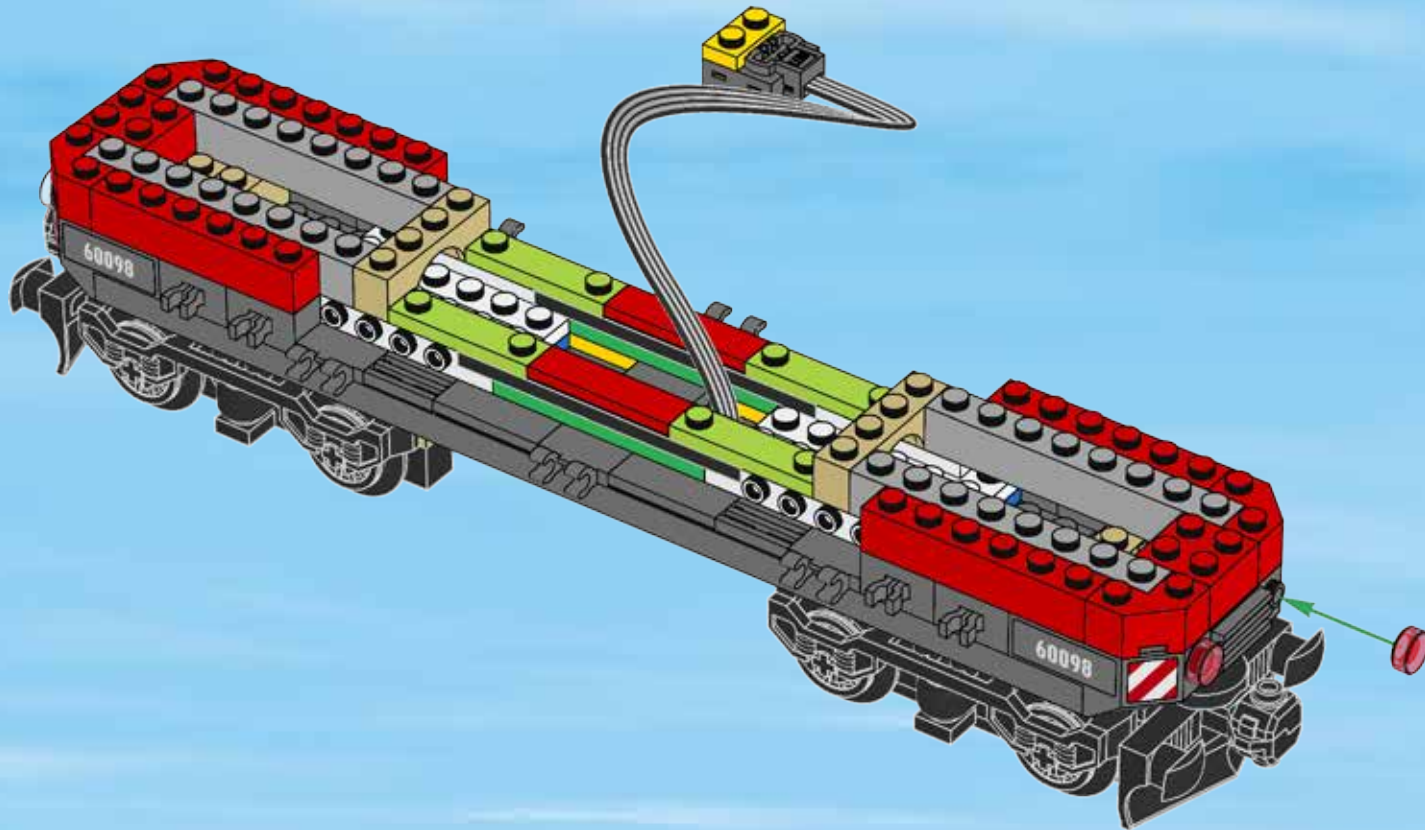

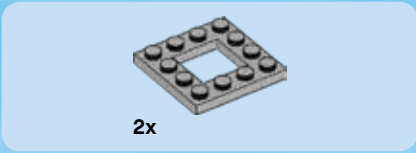
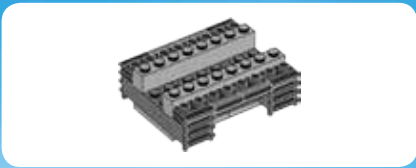

1

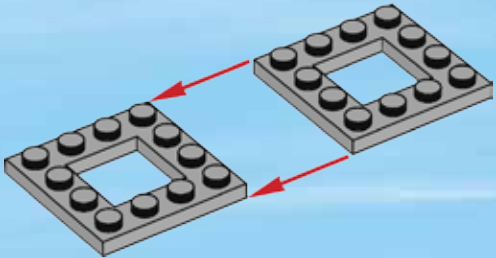

2

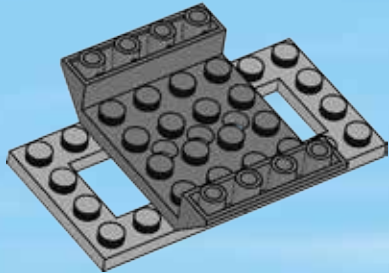



2x

3

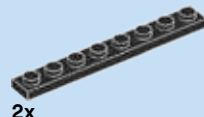
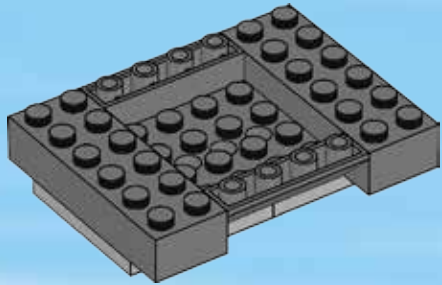

2x

4

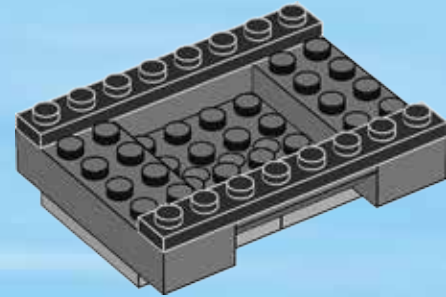



4x

5

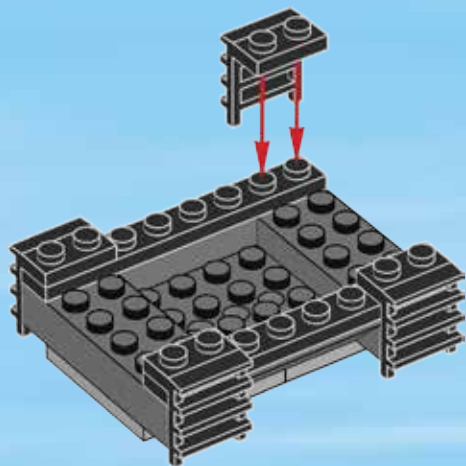

4x

6

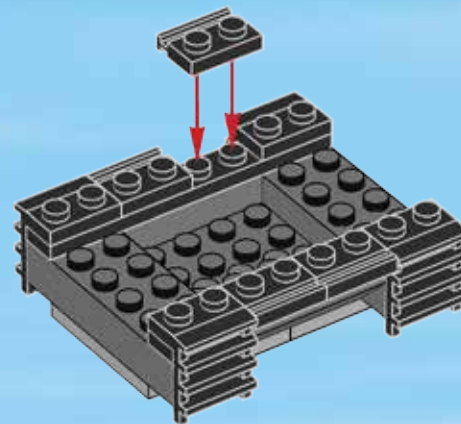

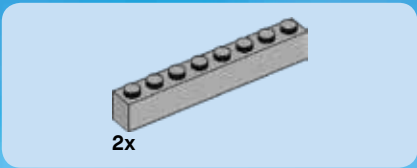

7

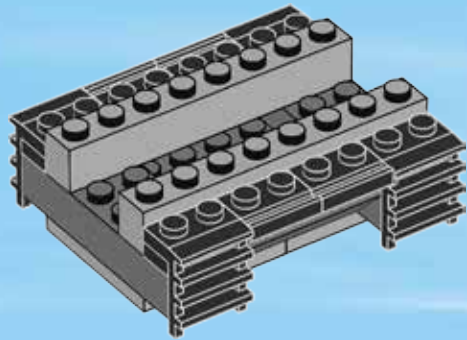

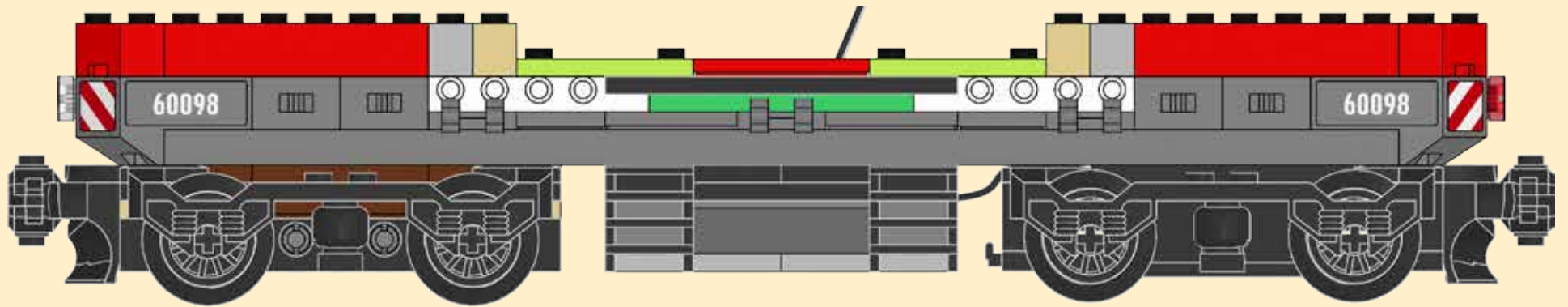

20

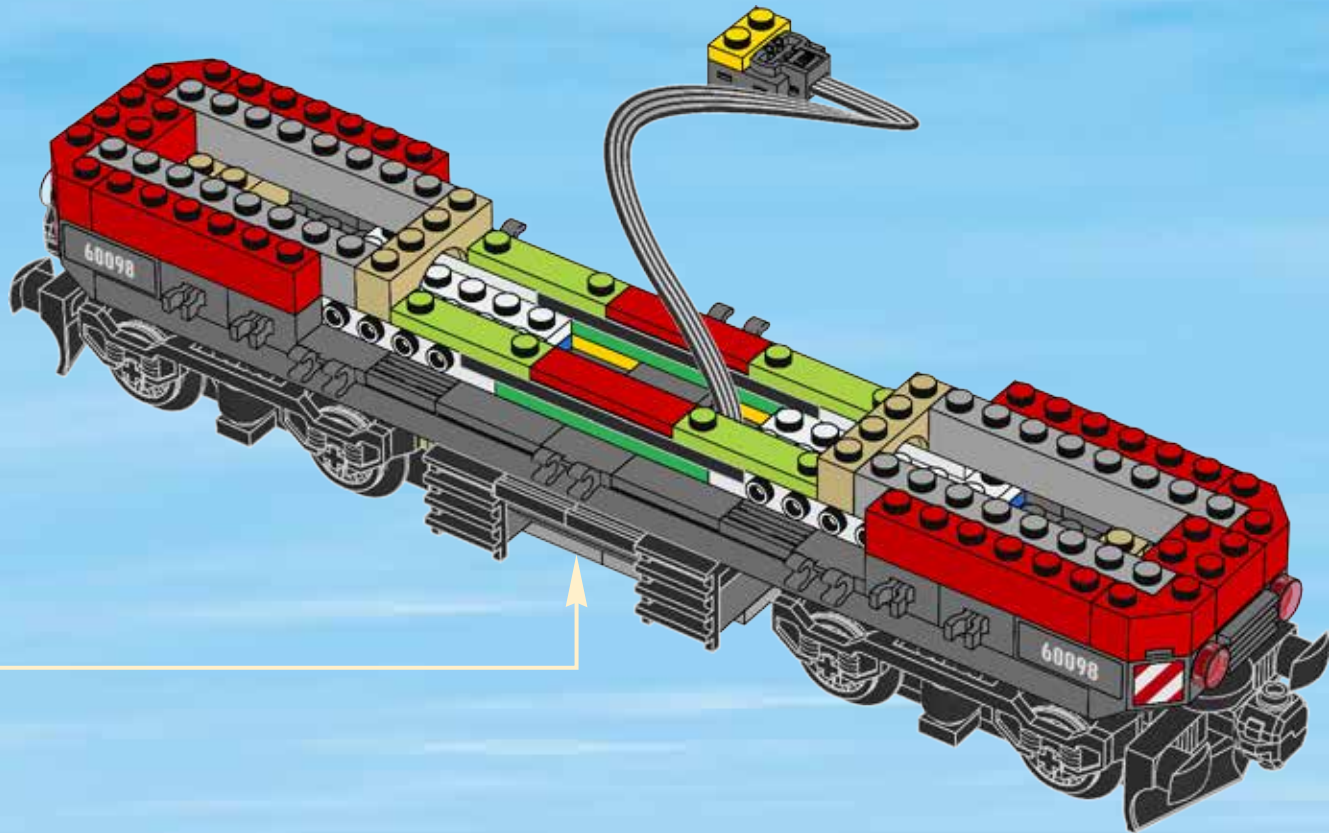



2x

21

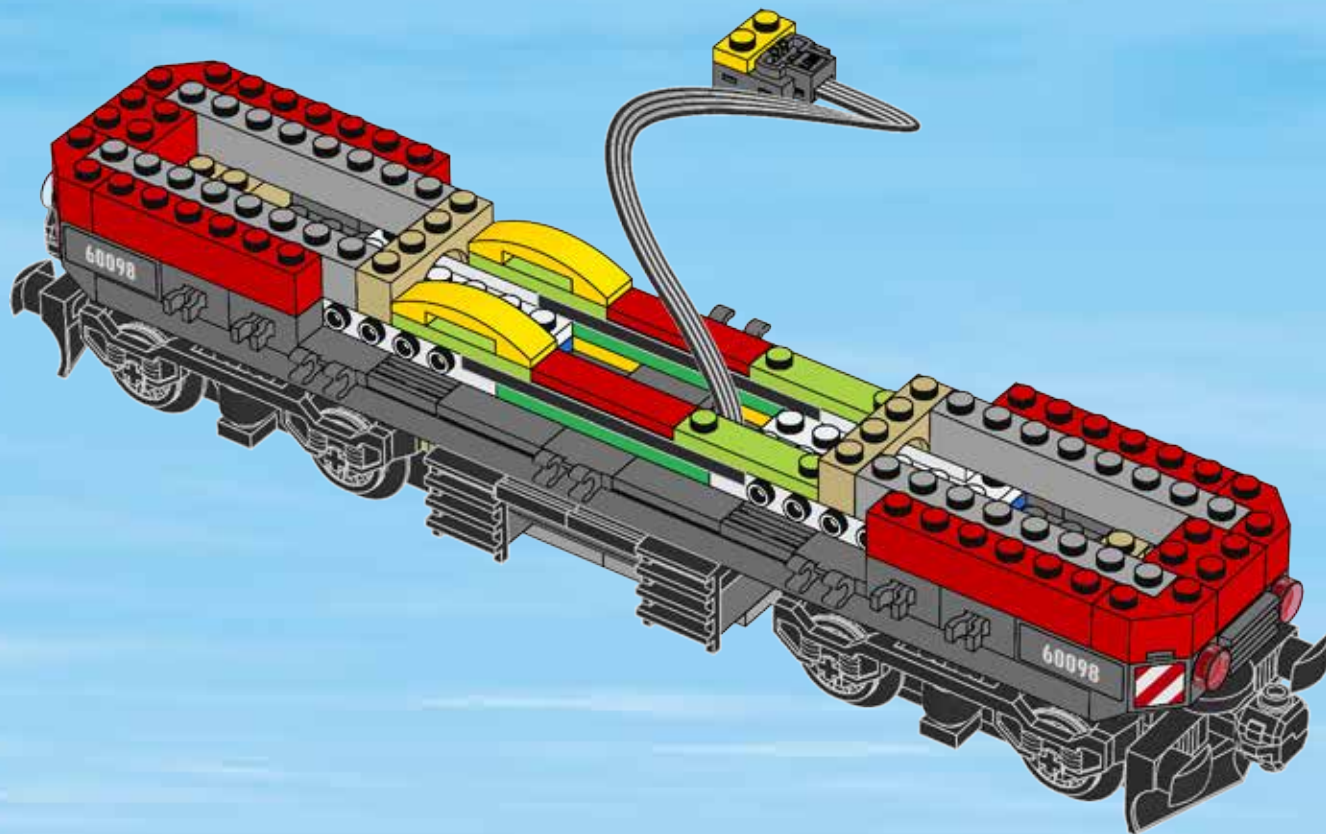



2x

22

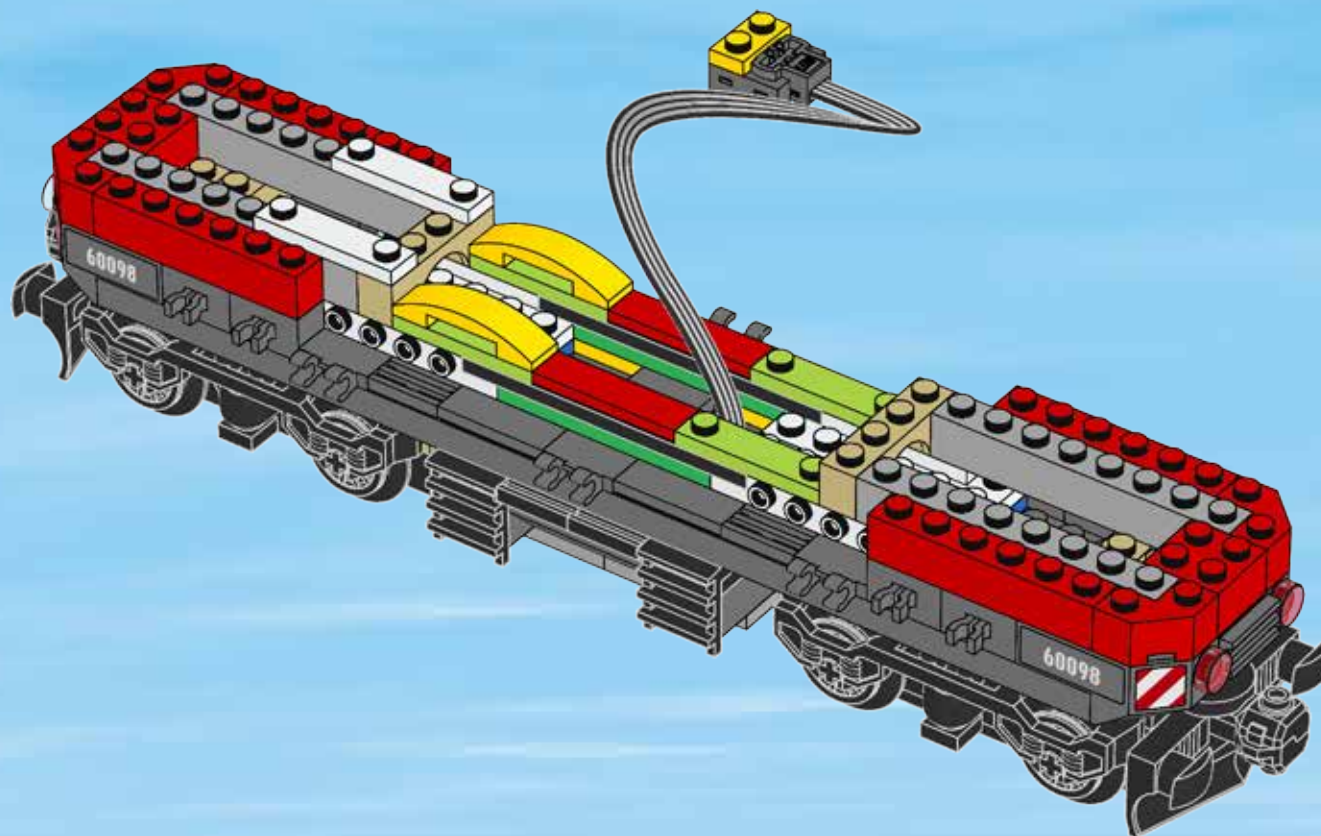



8x

23

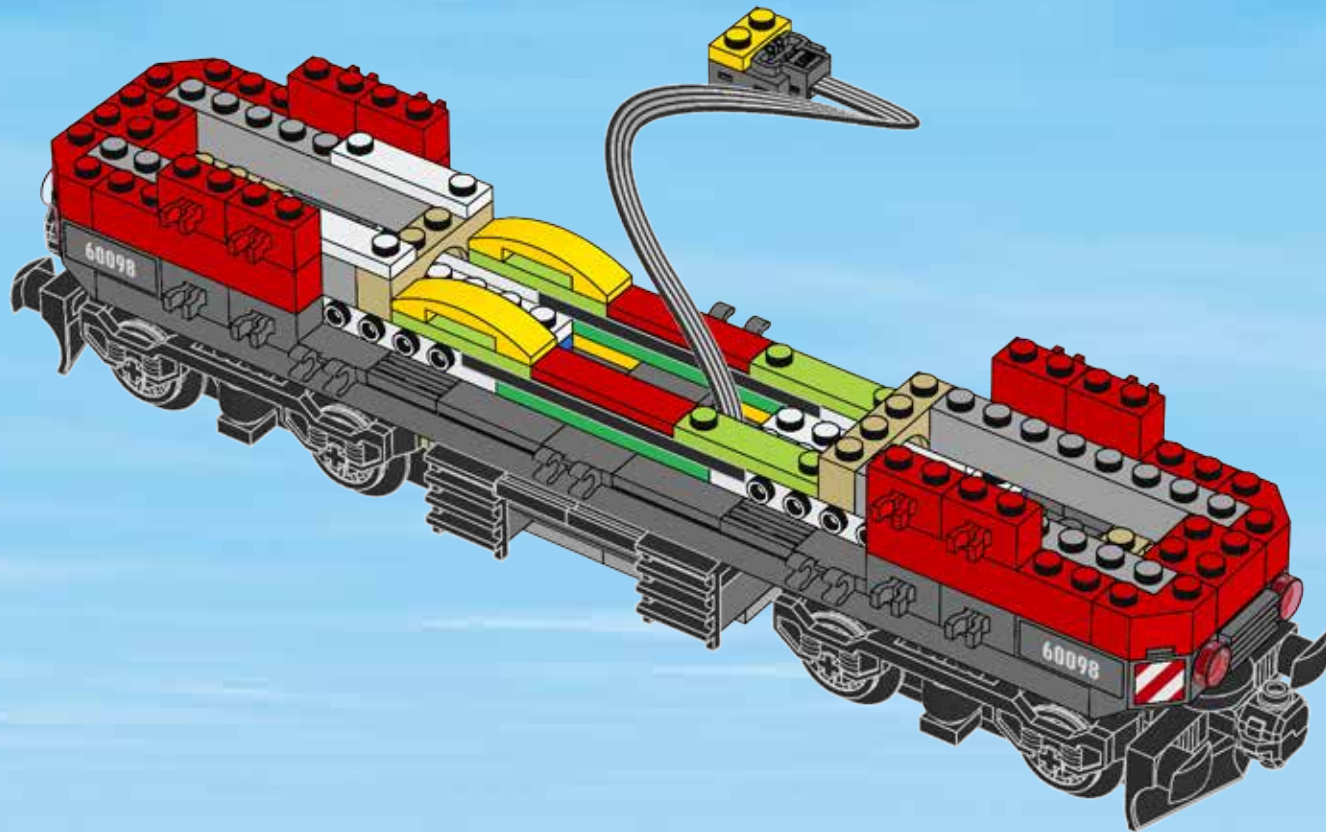



2x

24

1



2



3

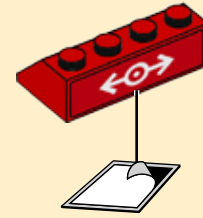

2x

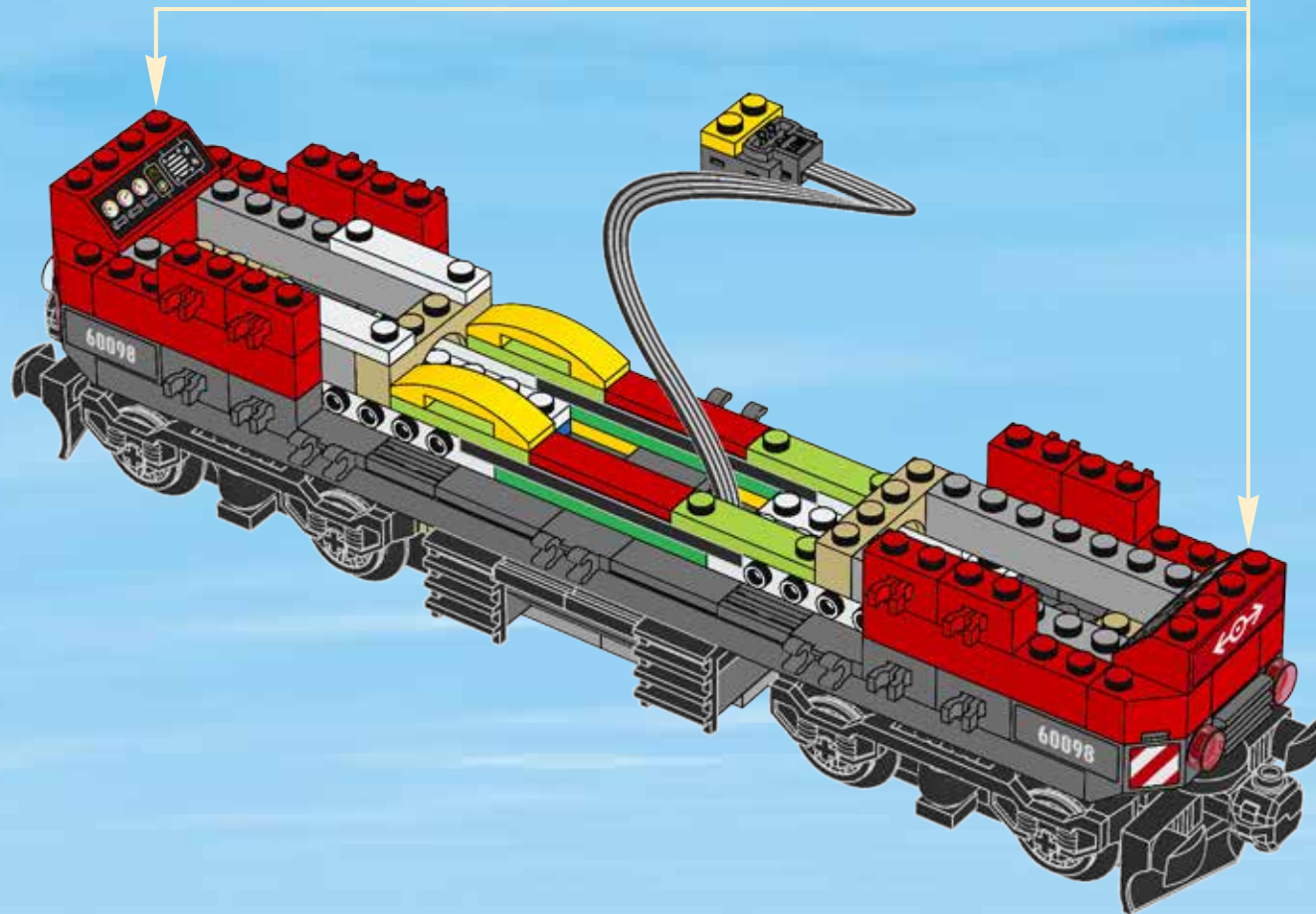



1x



2x

25

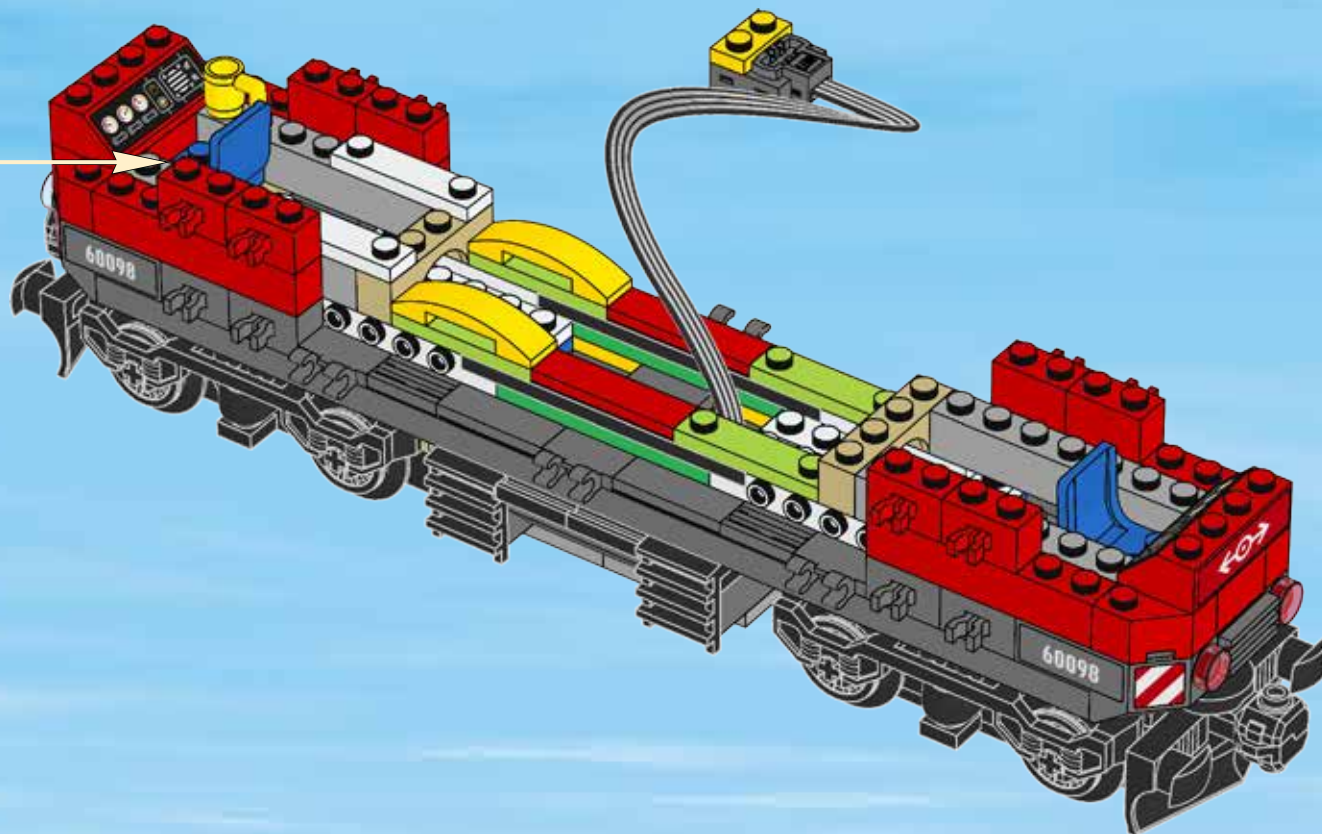

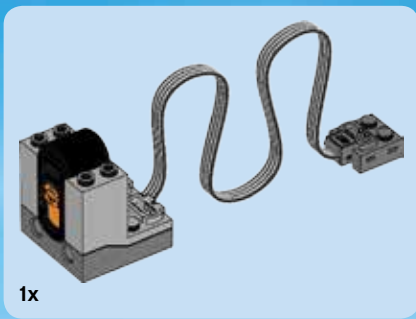

26

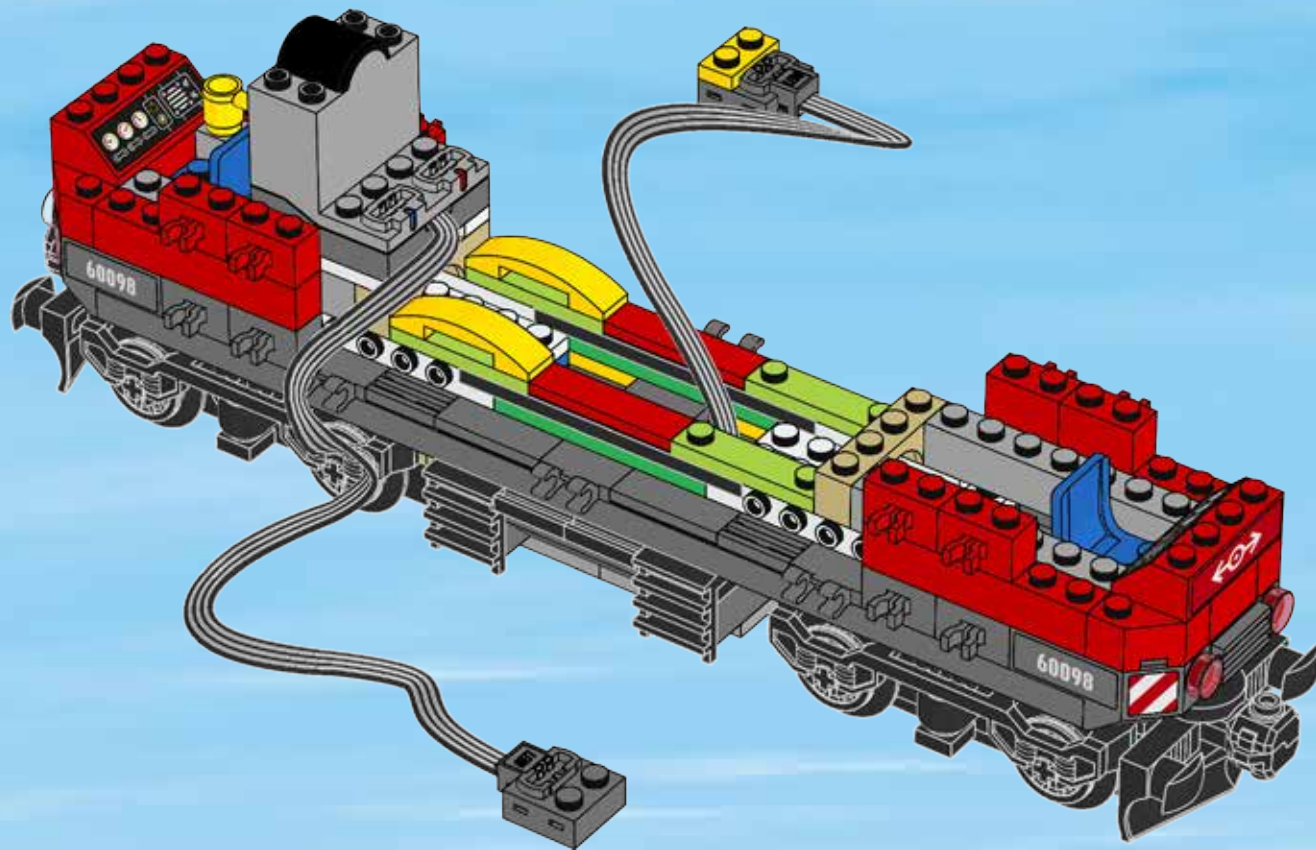

27

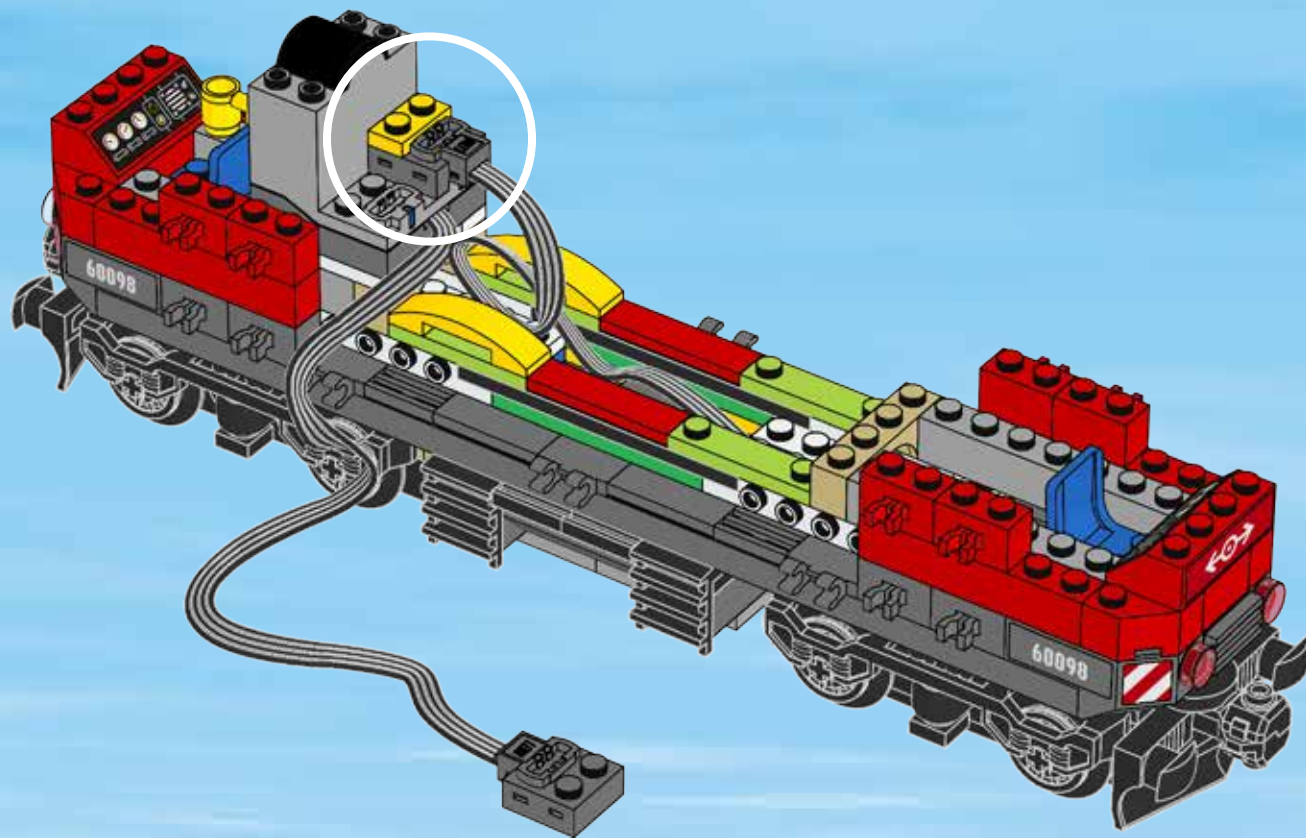



1x

28

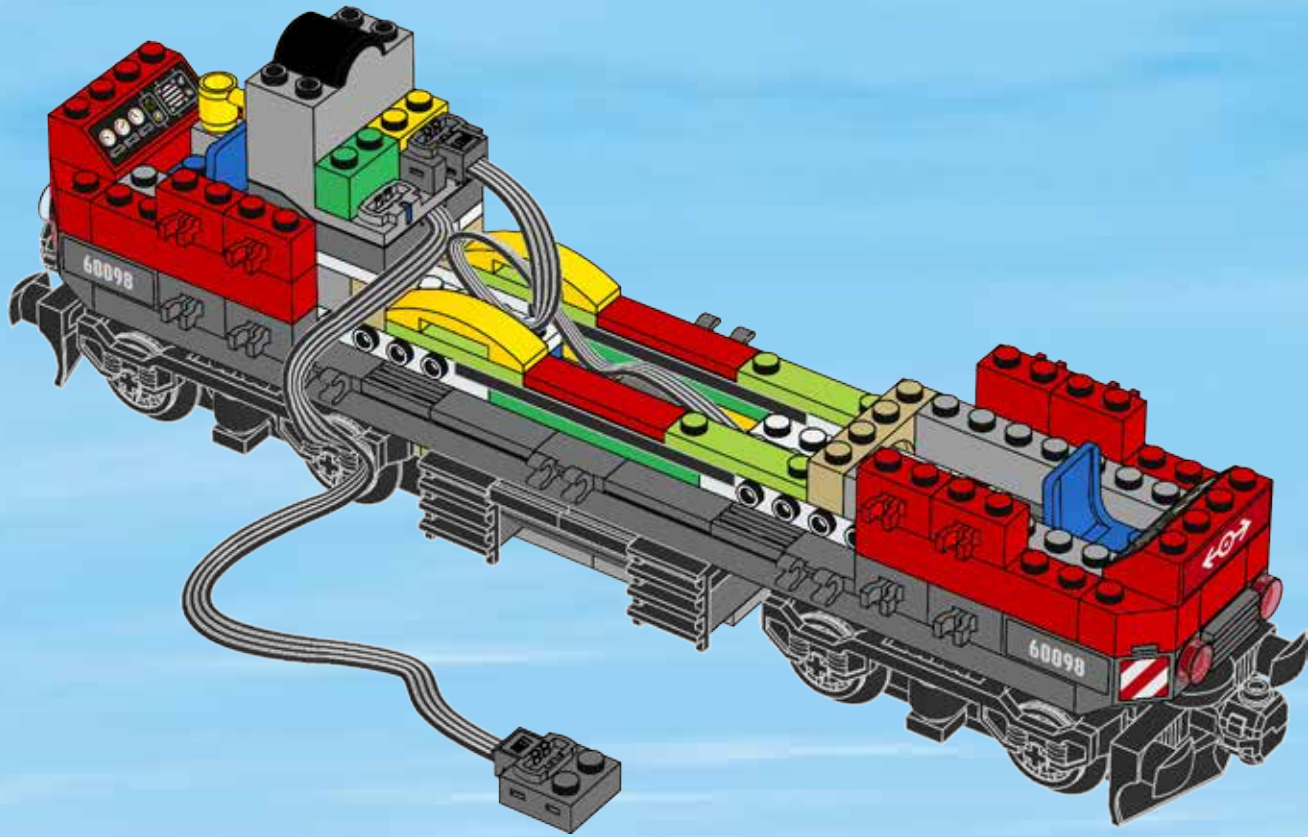



1x



2x

29

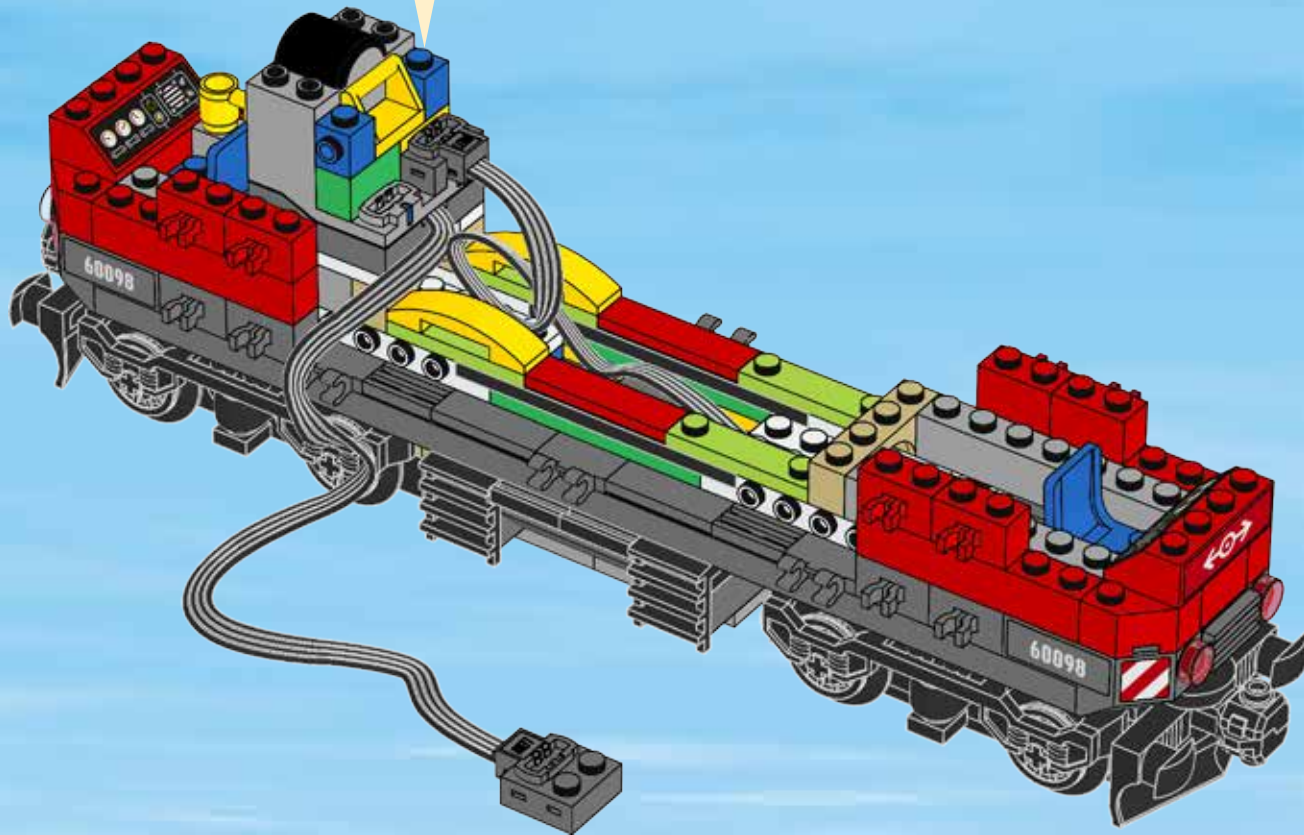

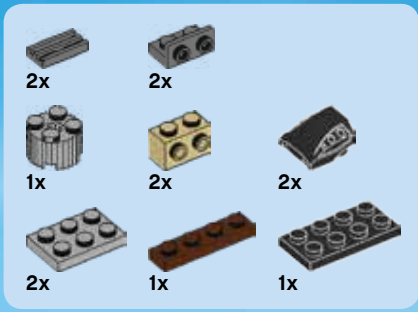

30

1

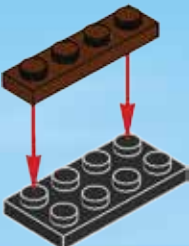

2



3

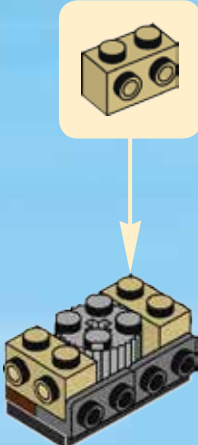

4

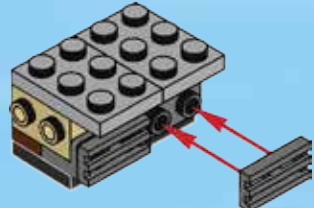

5

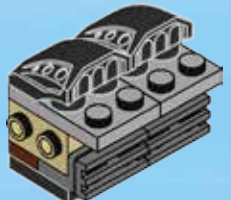

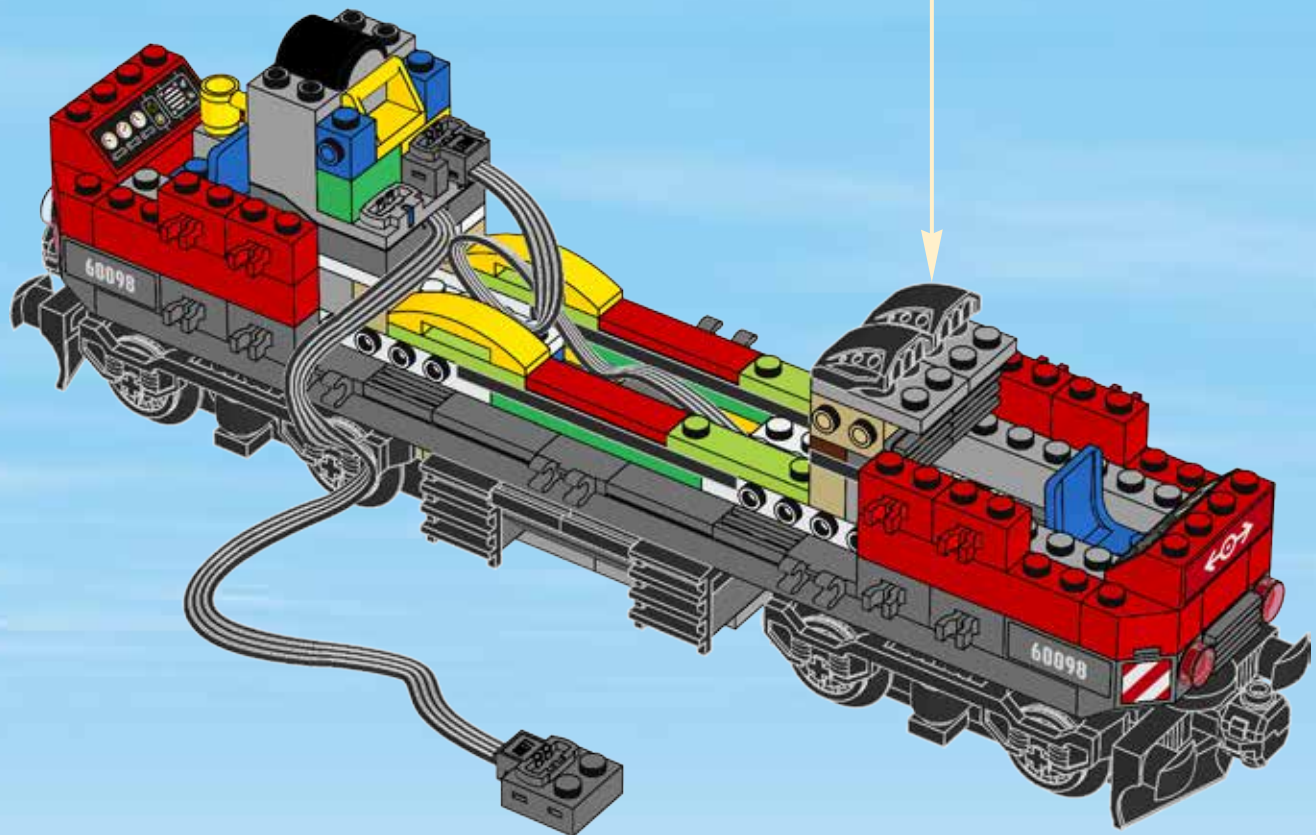



+



4x



2x



2x

31

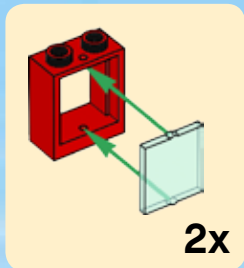
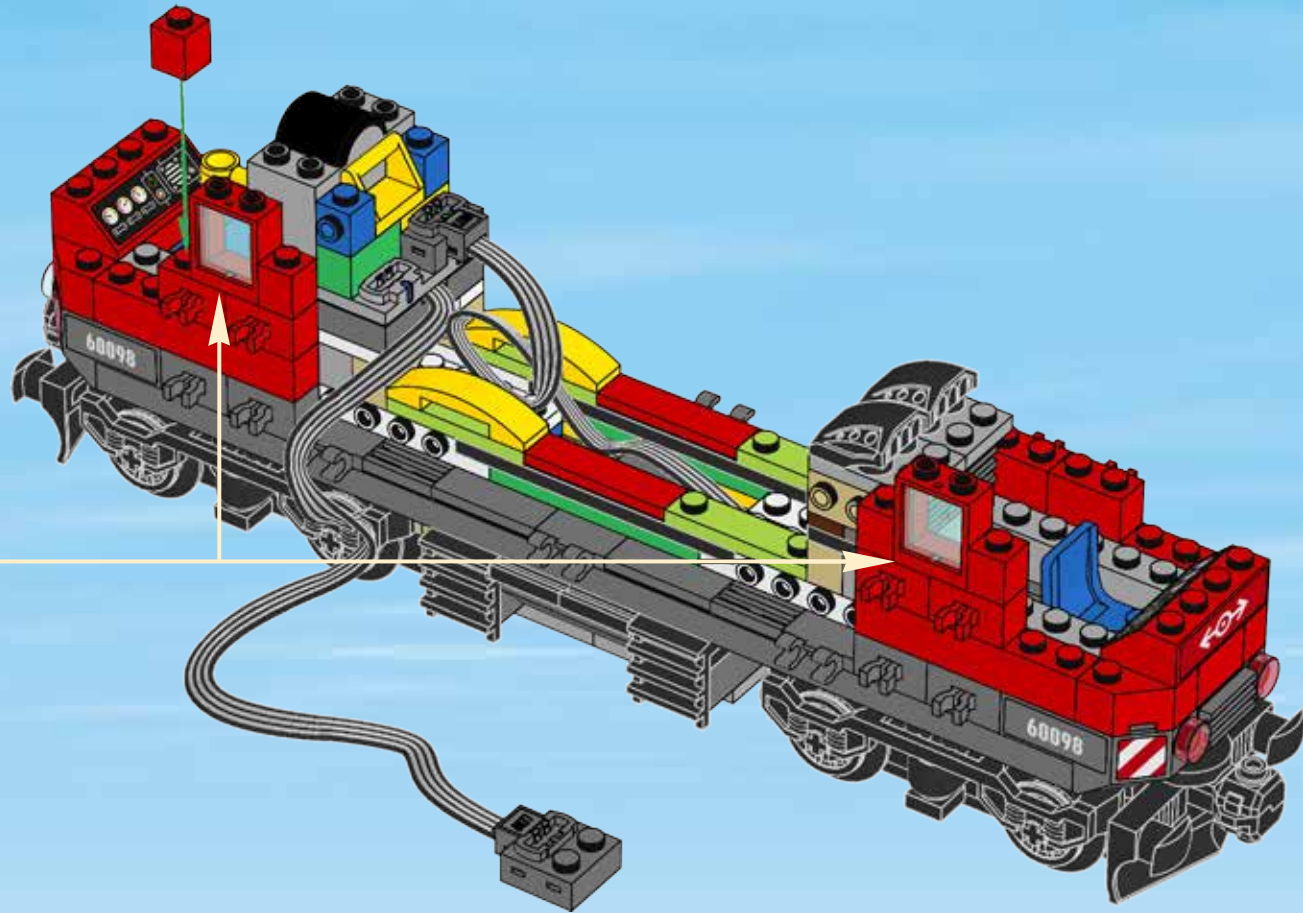

2x



4x



2x



2x

32

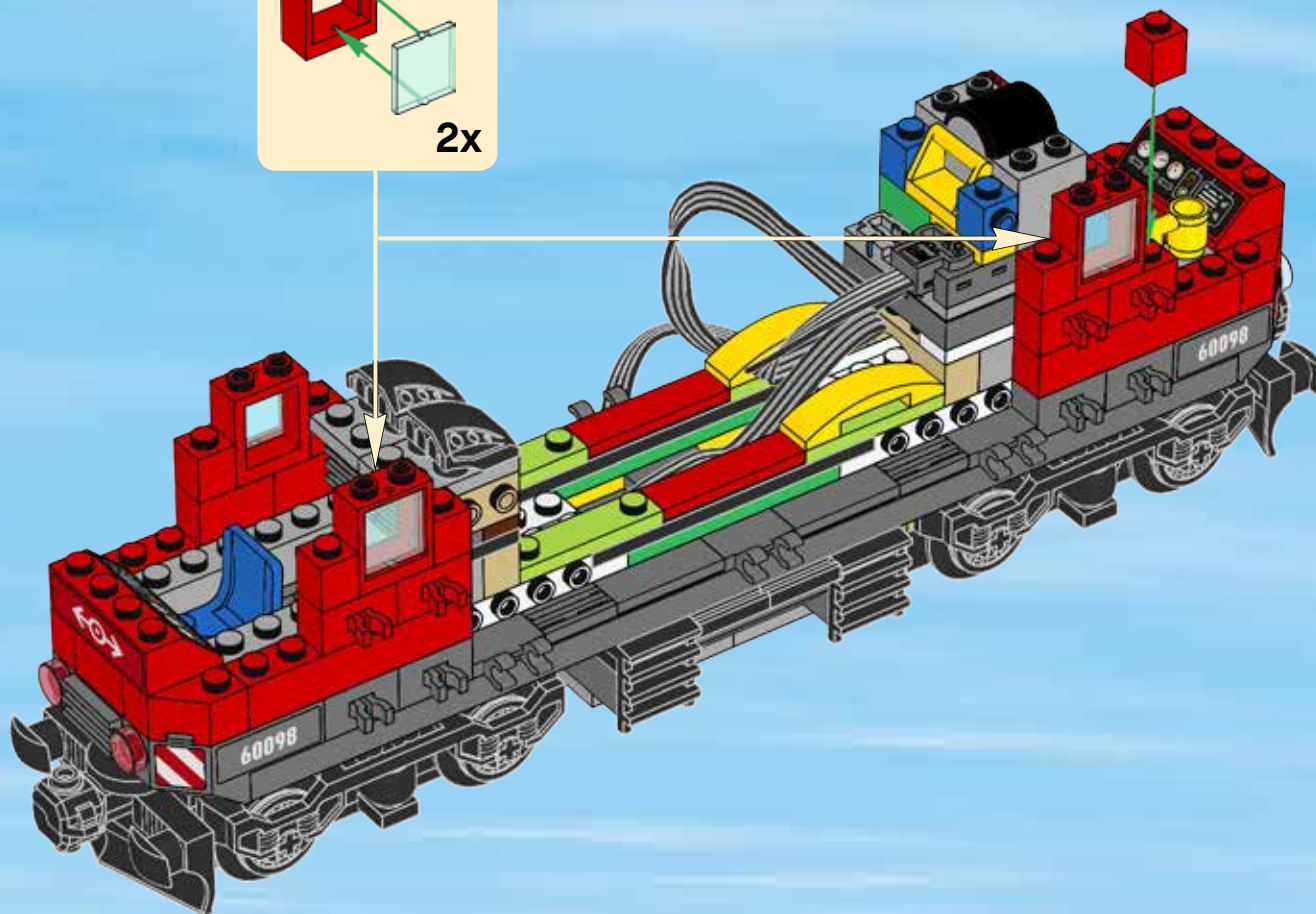
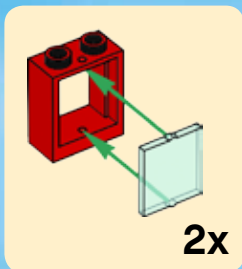



33

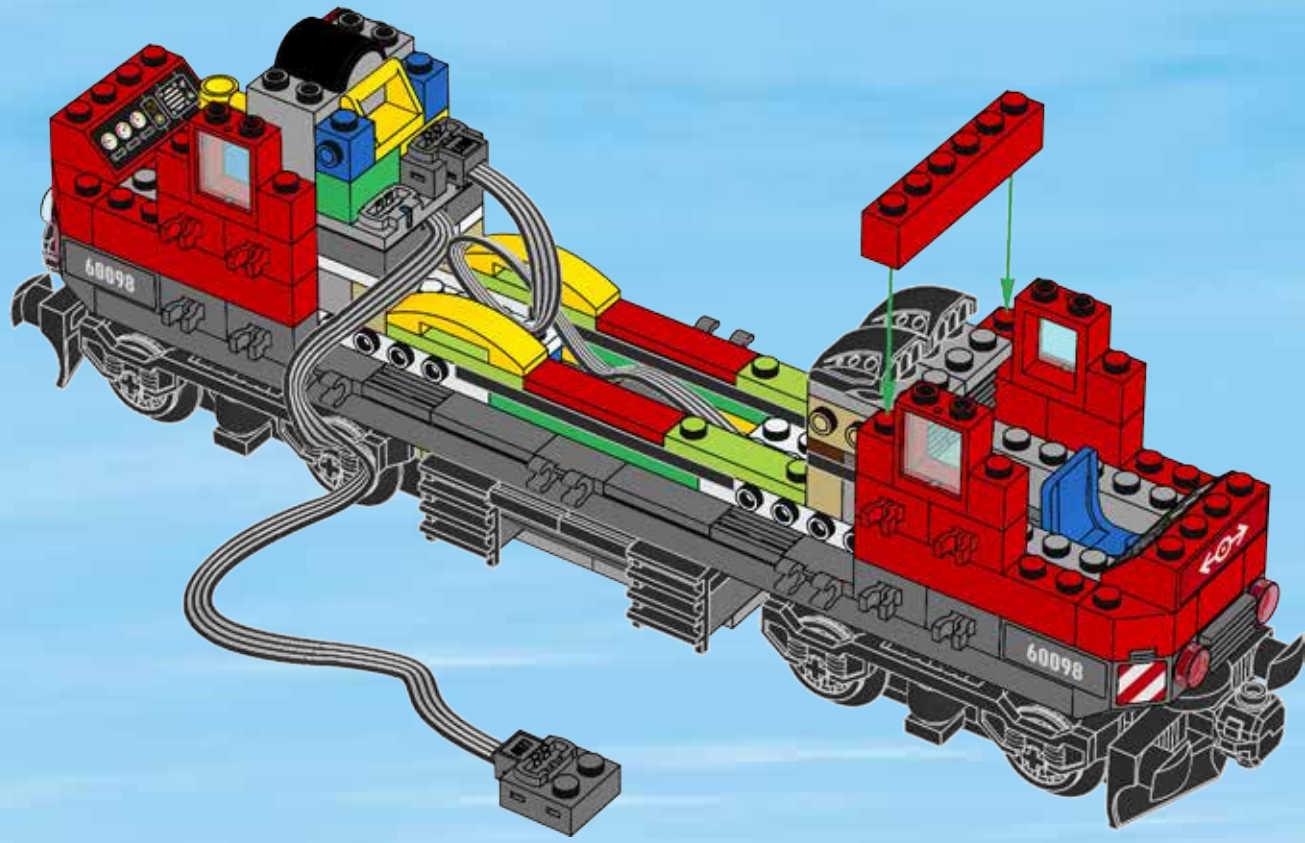



6x

34

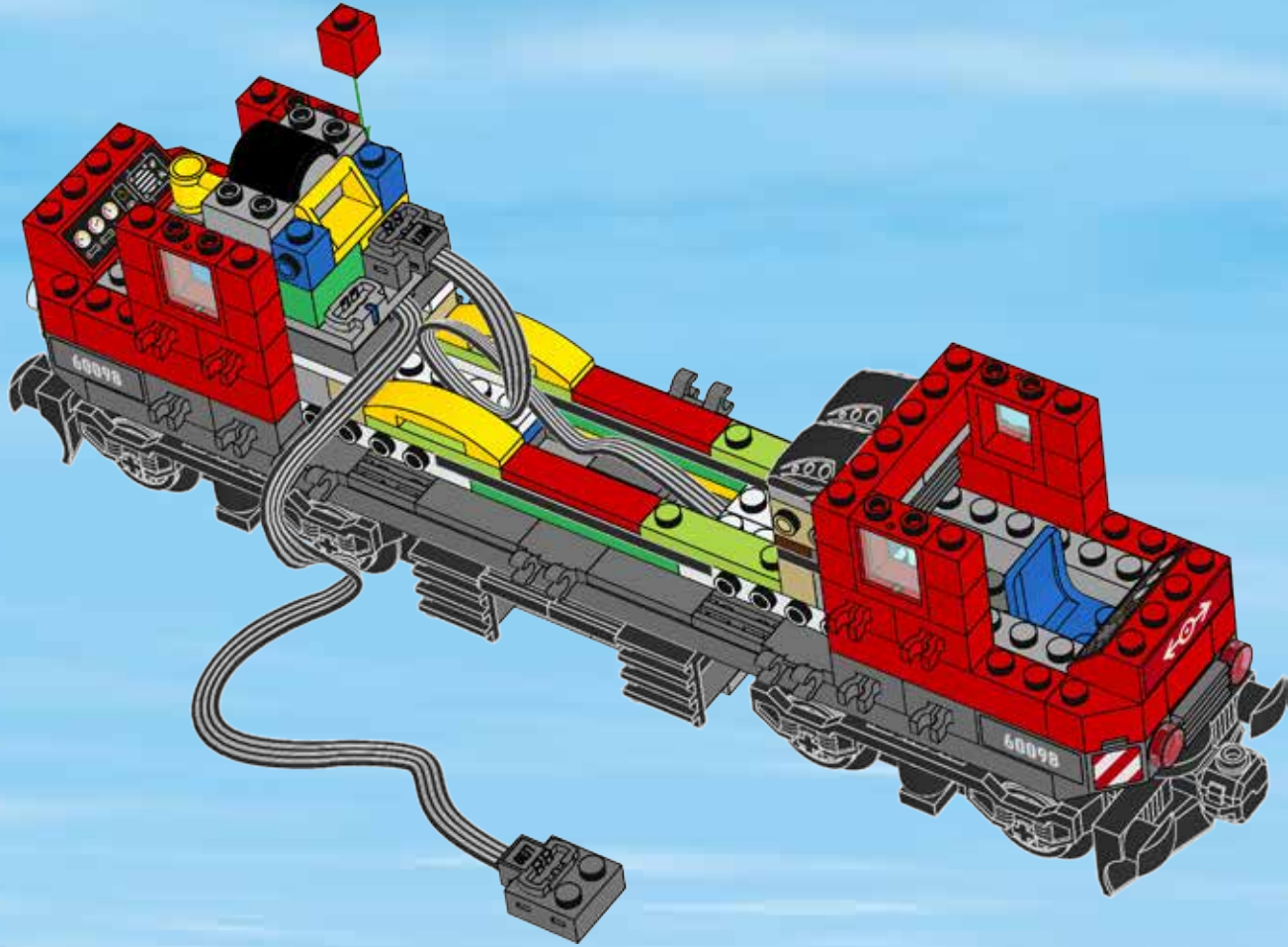



35

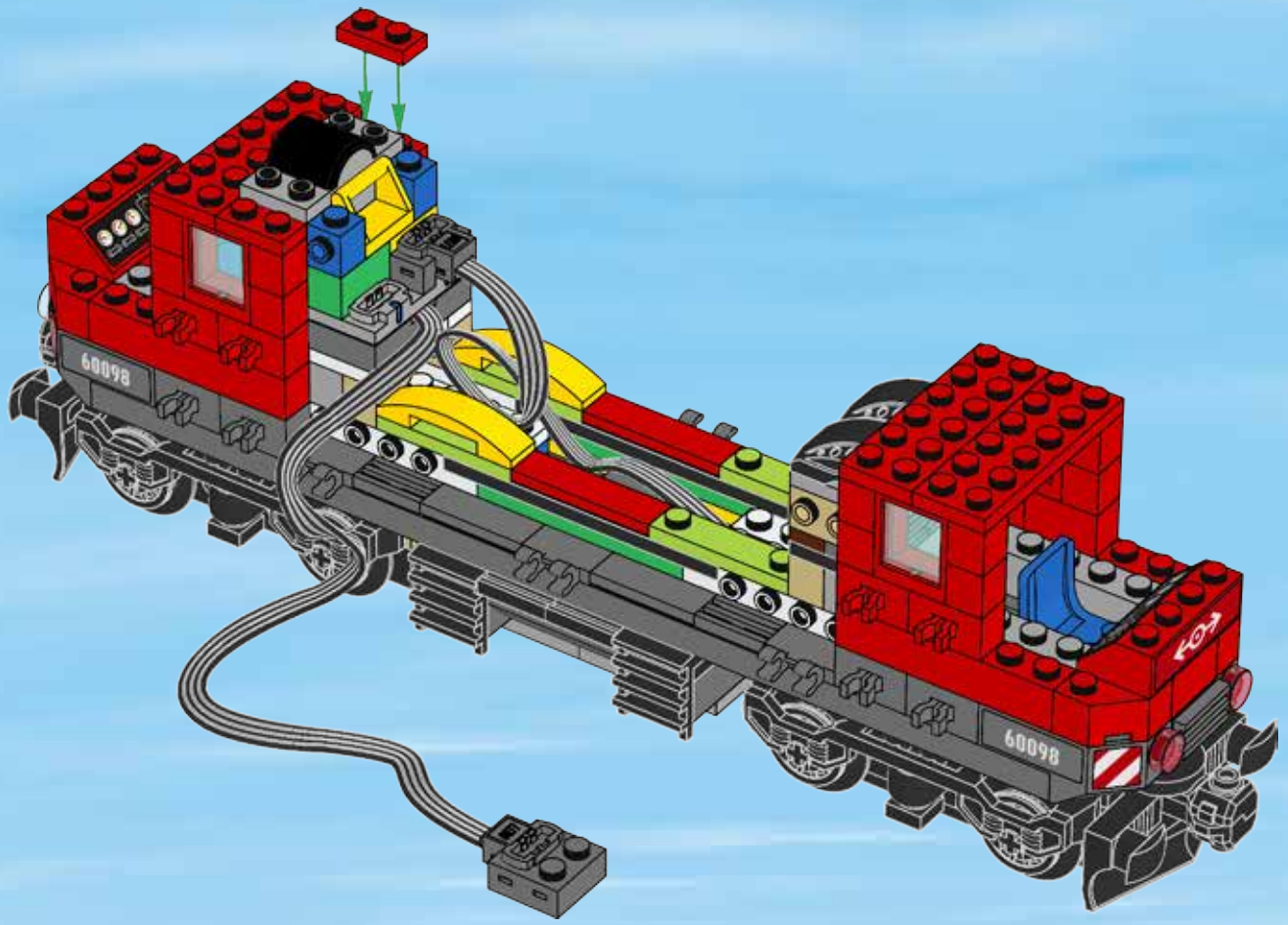



8x

36

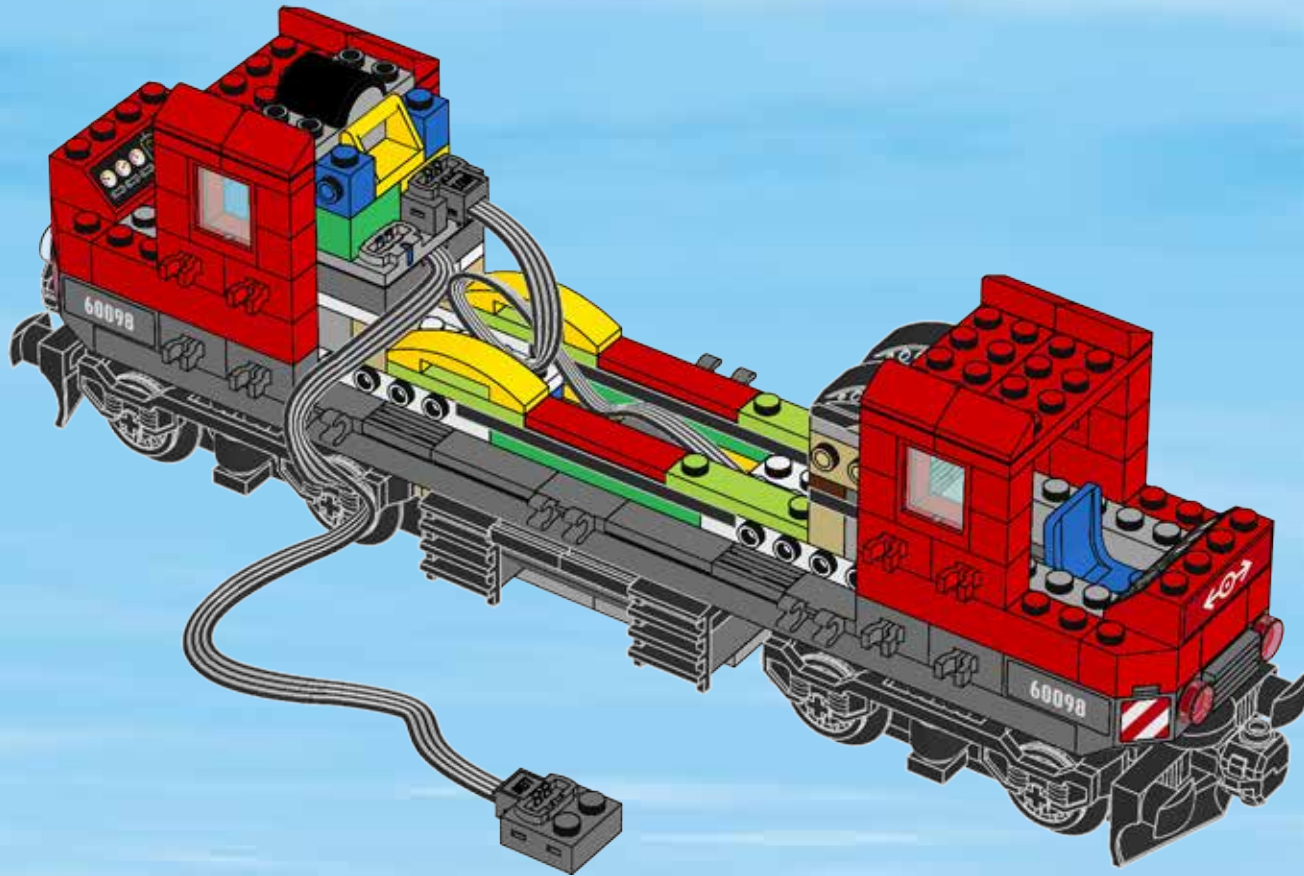



2x



2x

37

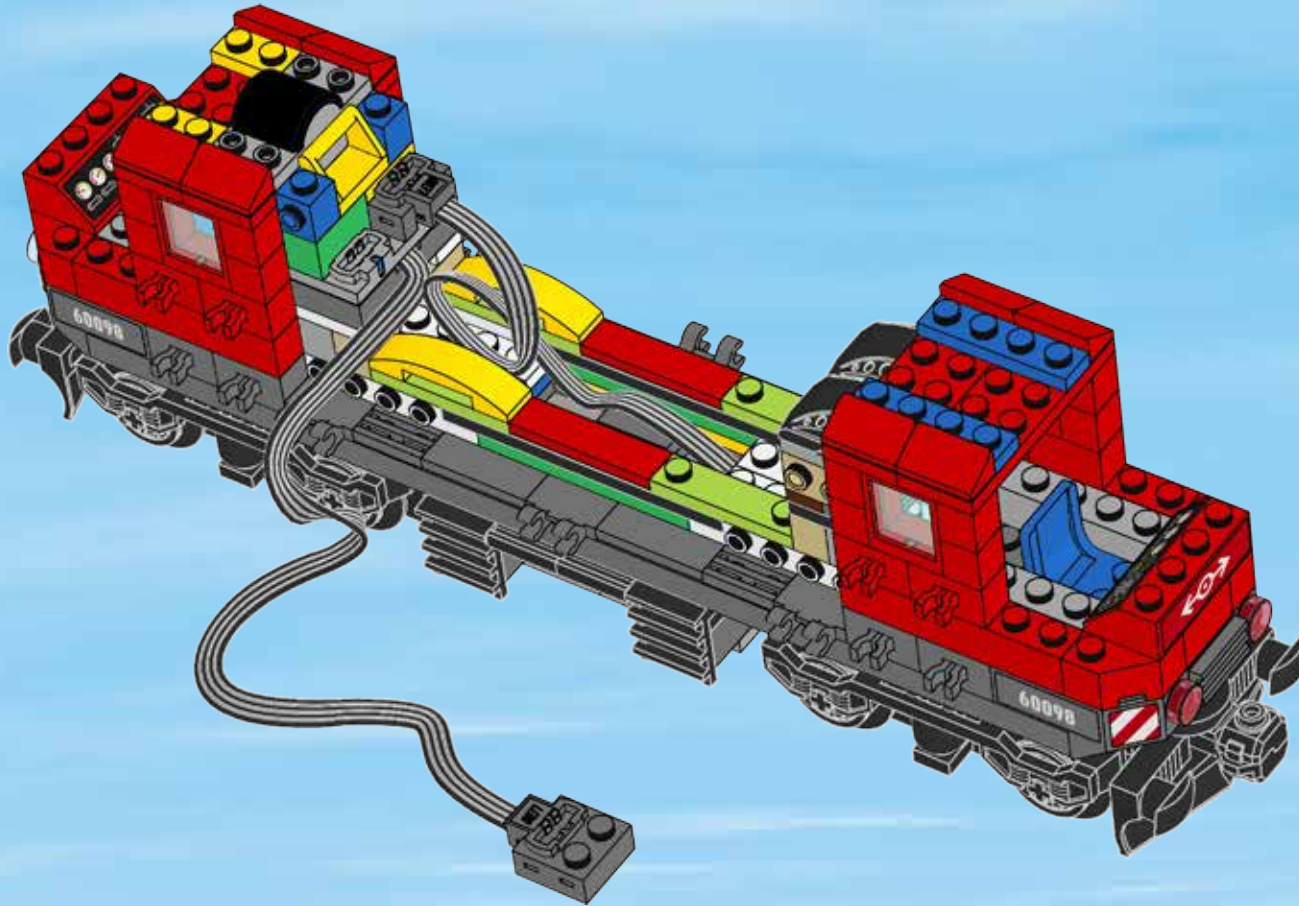



1x



2x

38

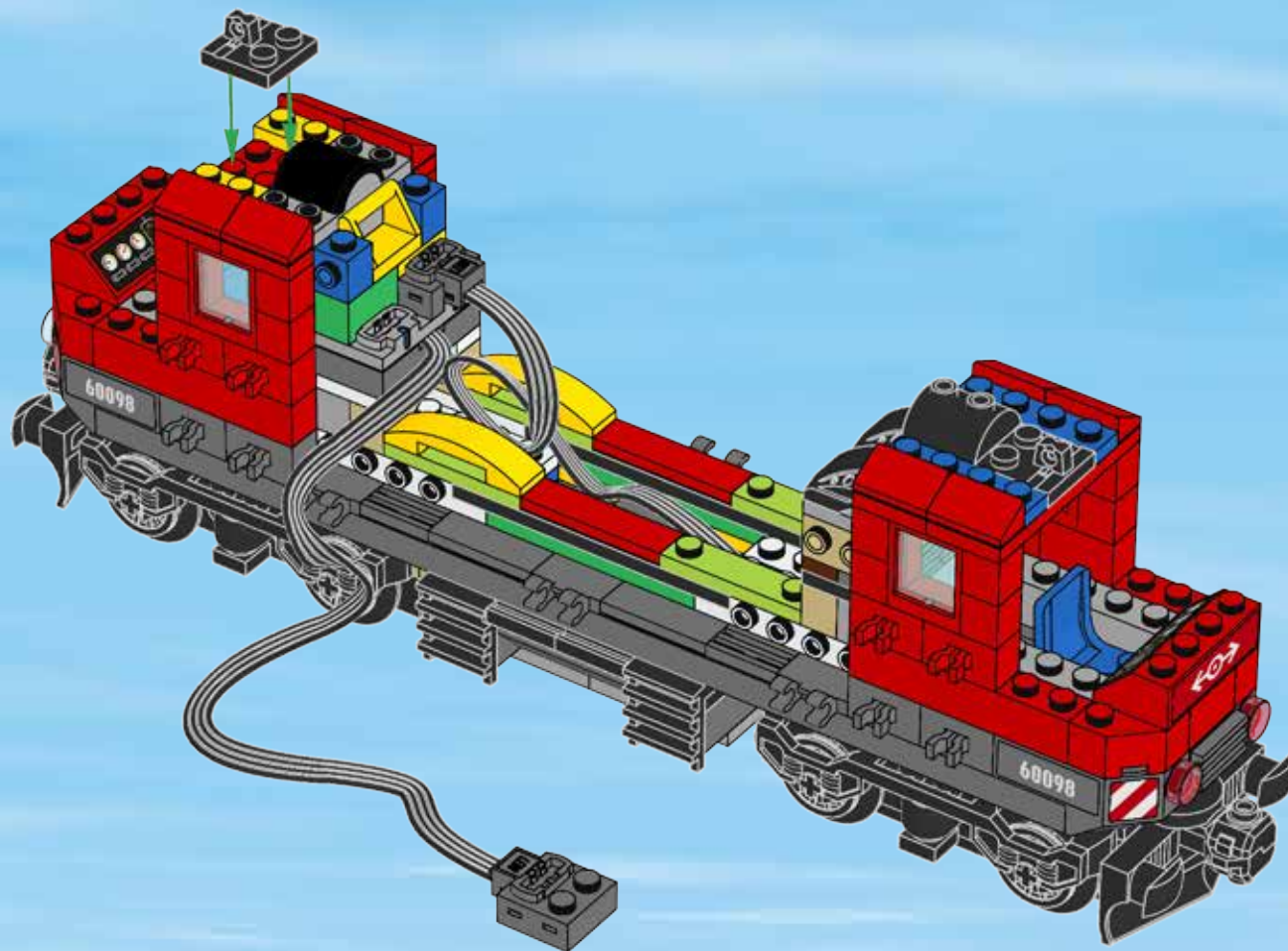

4x  2x 

39

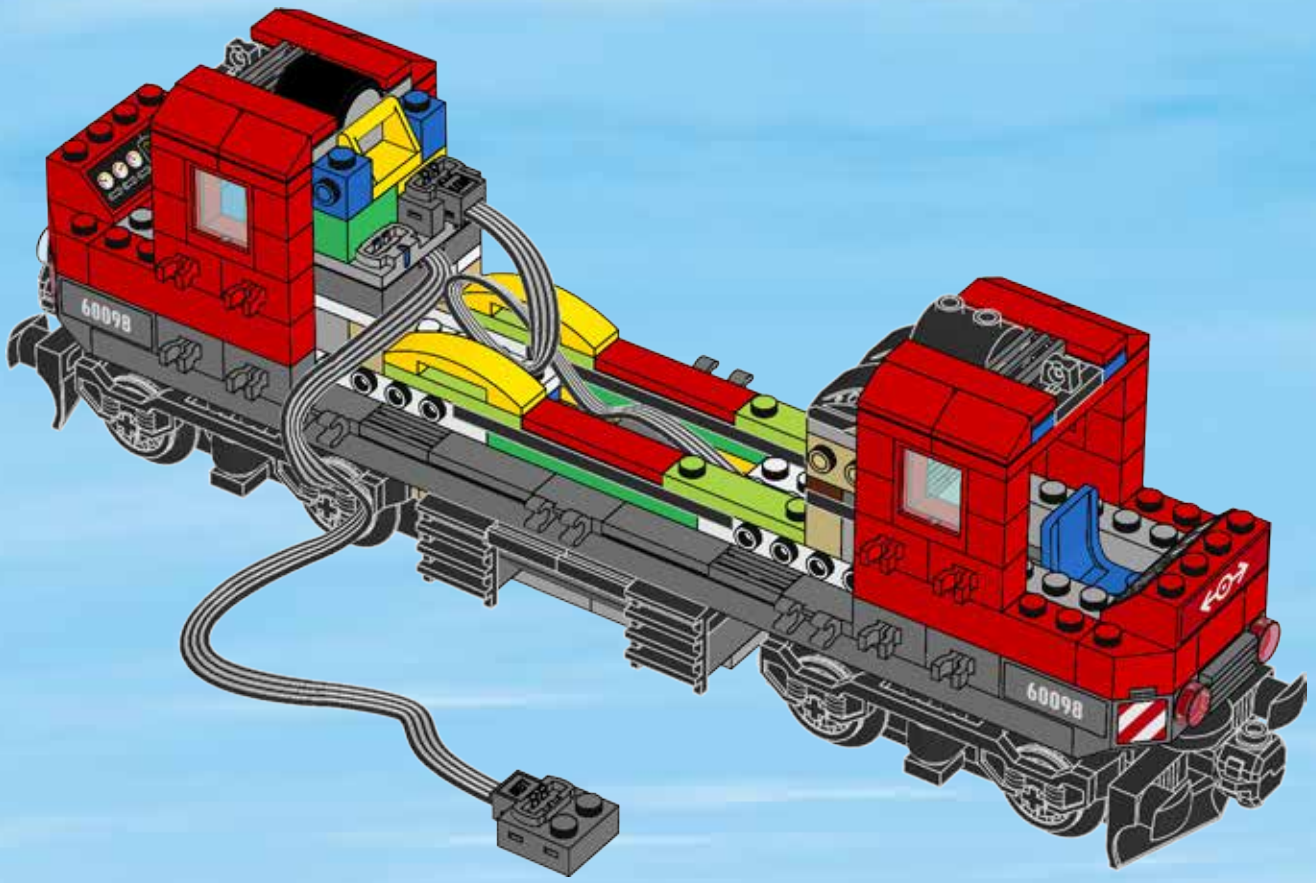

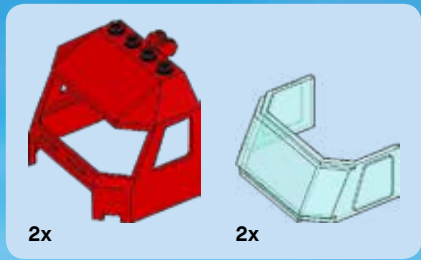

40

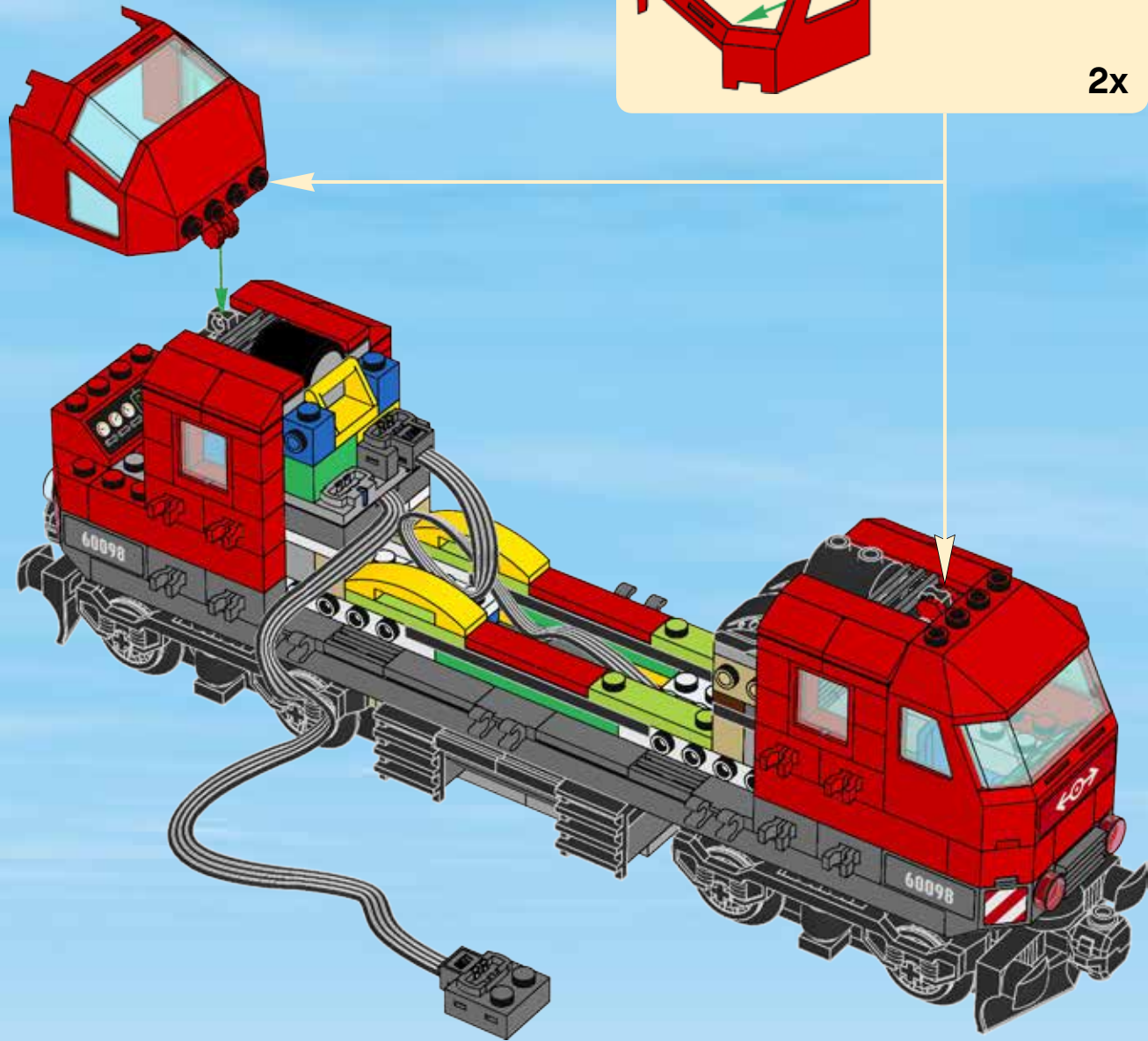
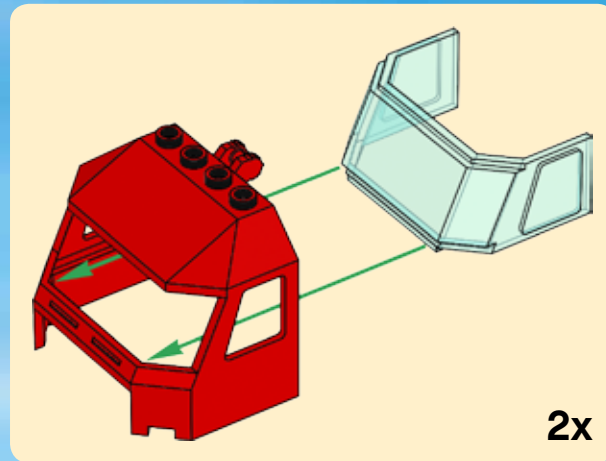

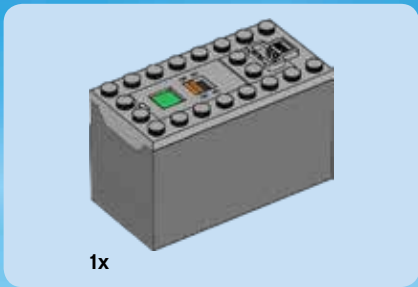

1x

41

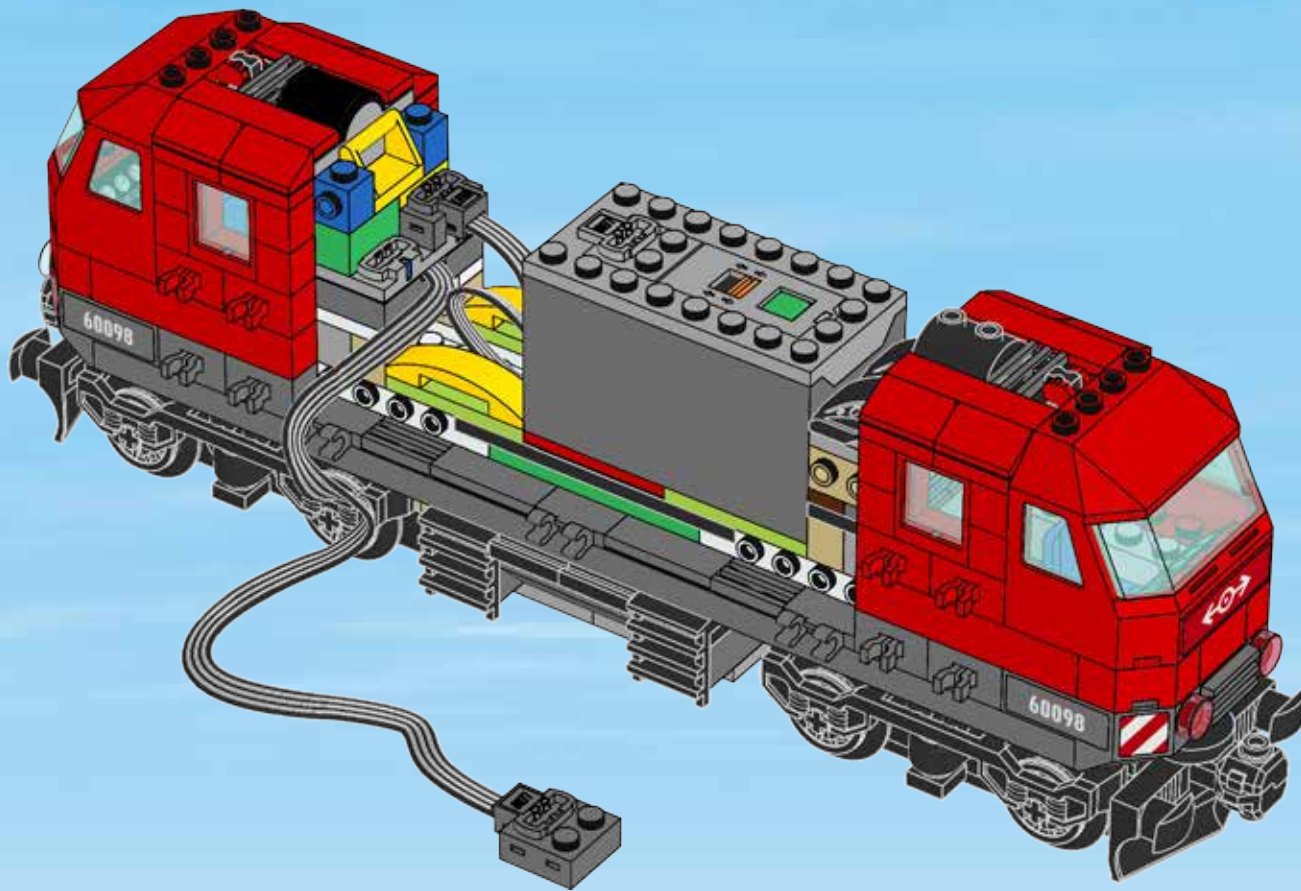

42

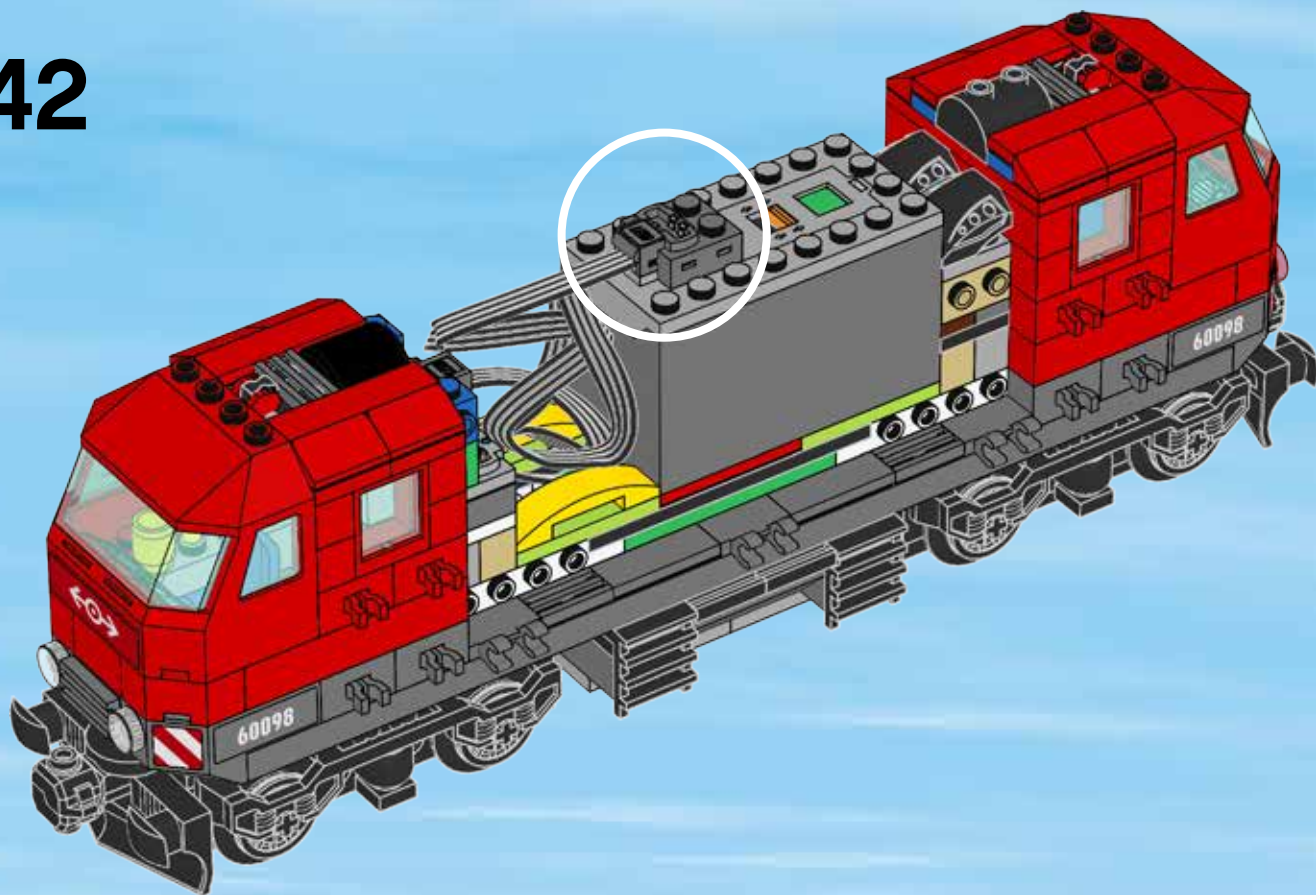

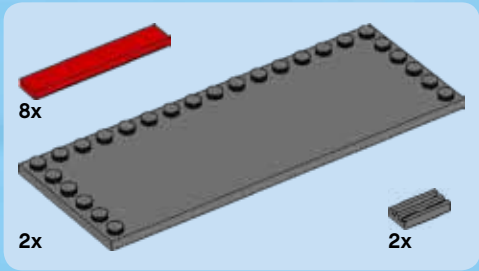

43

1

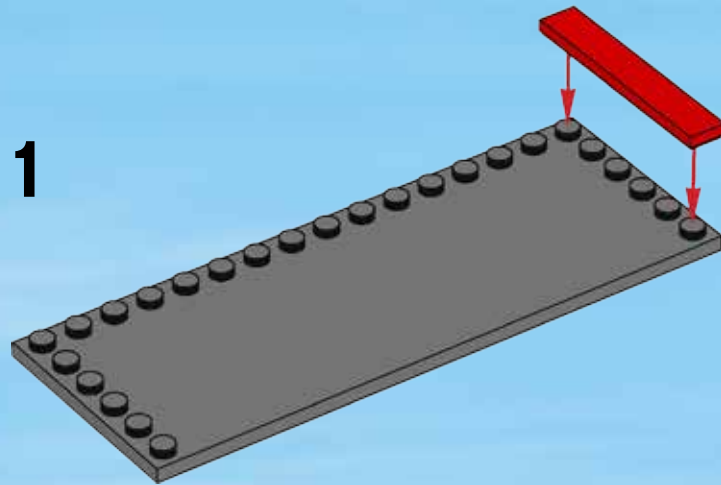

2

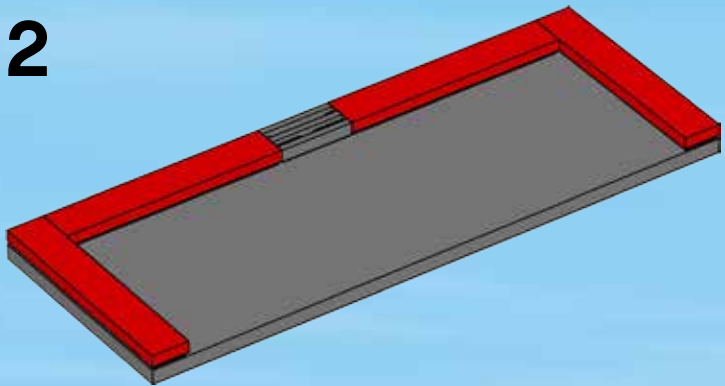

3

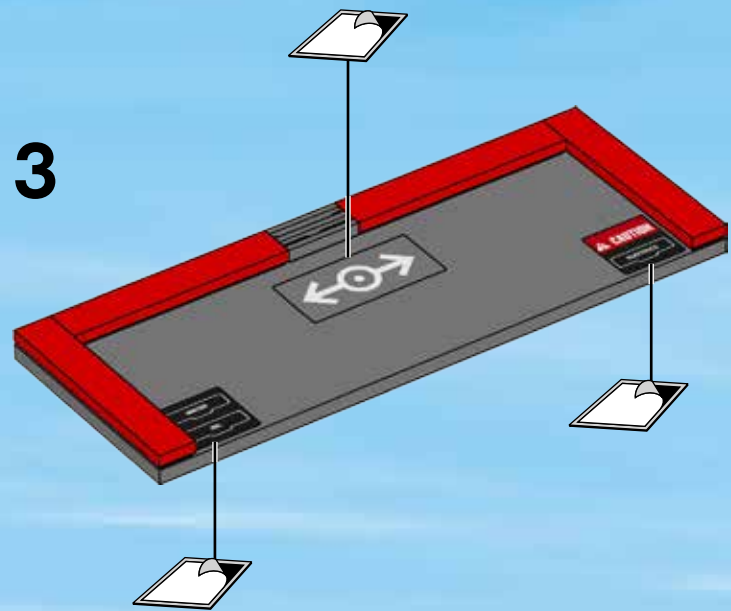

2x

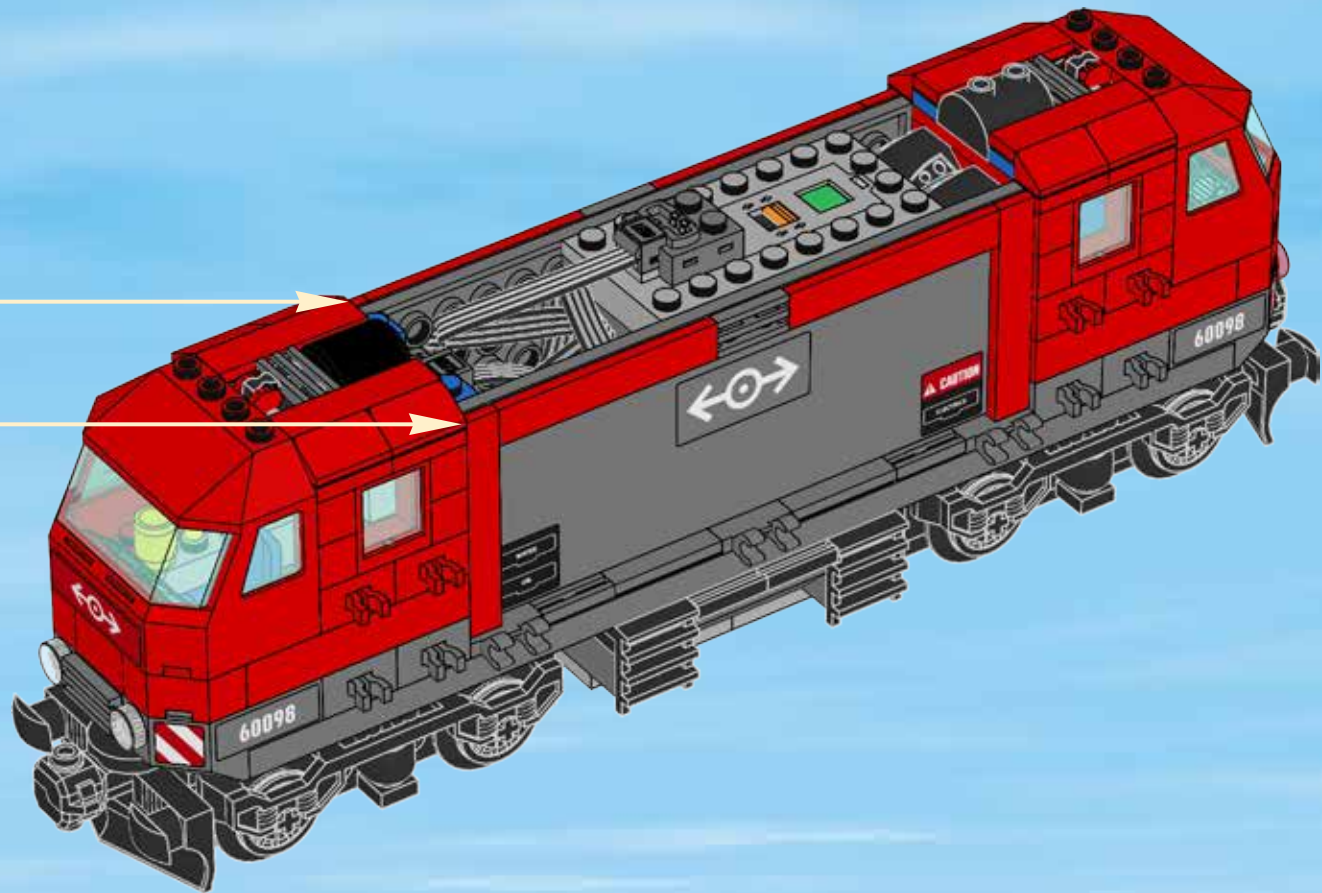

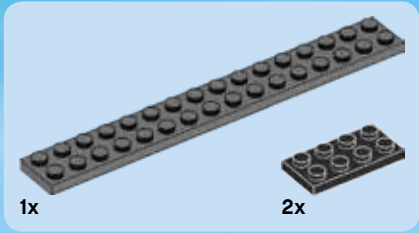
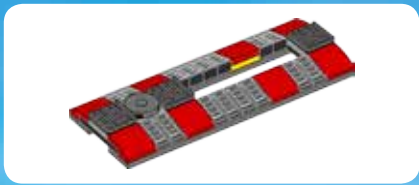

1

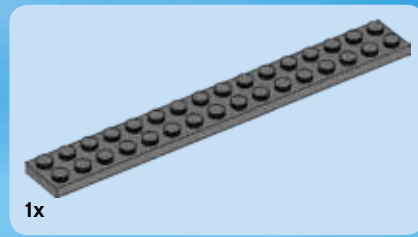
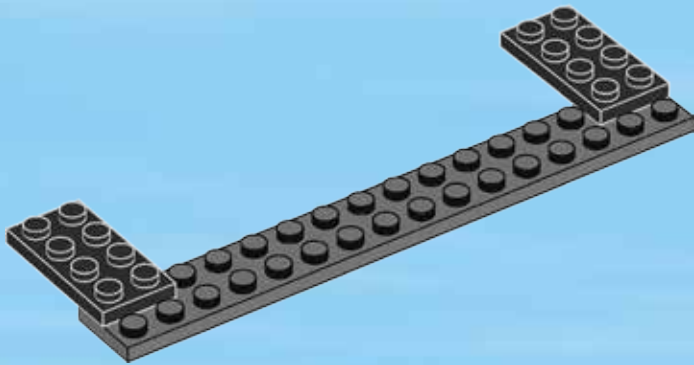

2

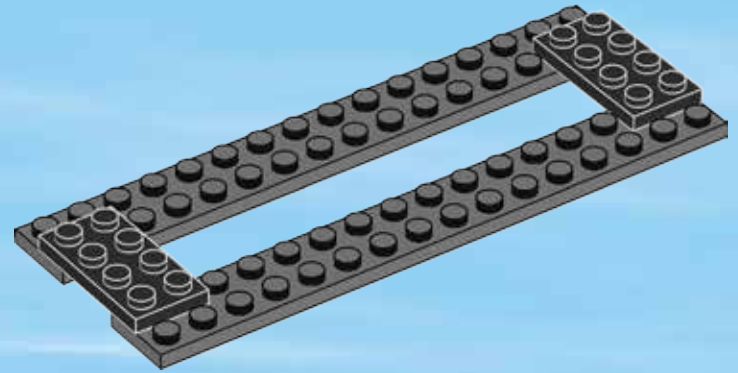



4x

3

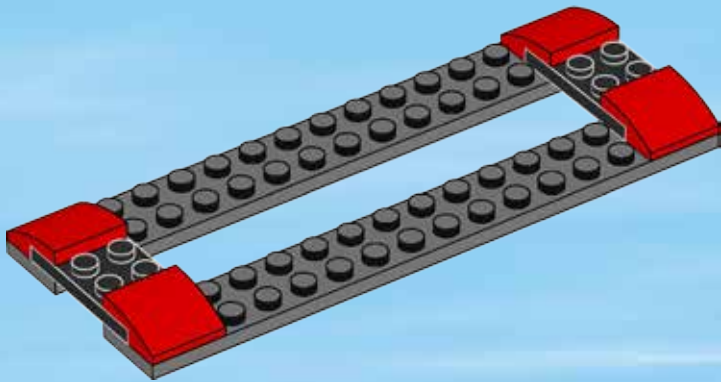

8x

4

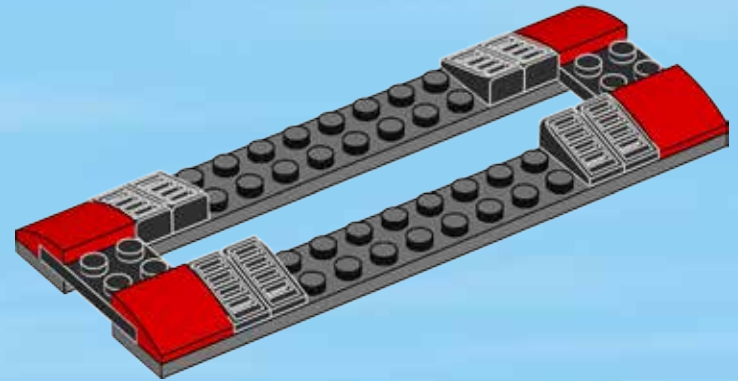

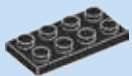

1x



2x

5

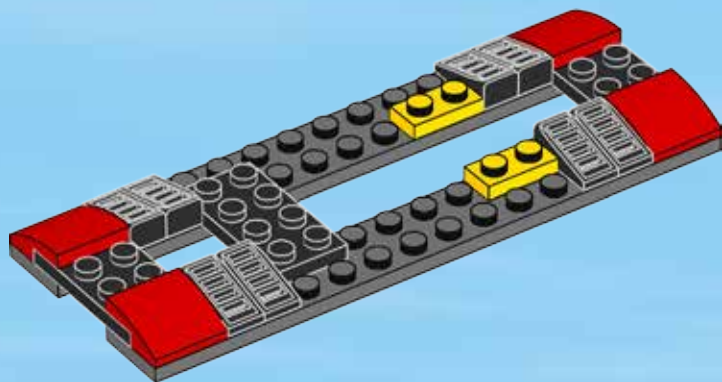

4x

6

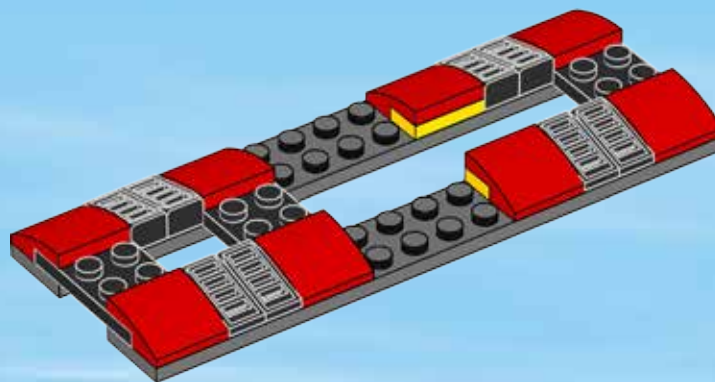



8x

7

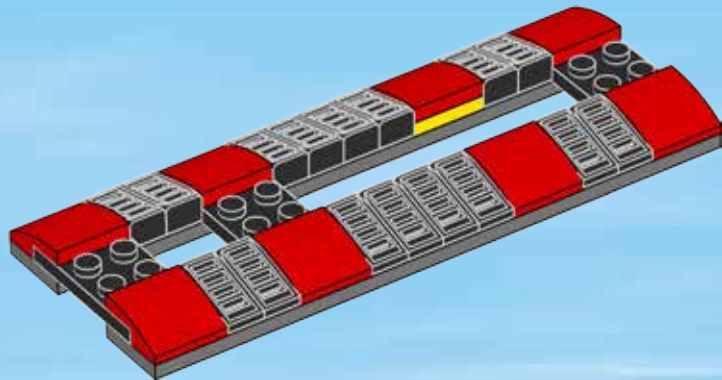

1x



1x

8

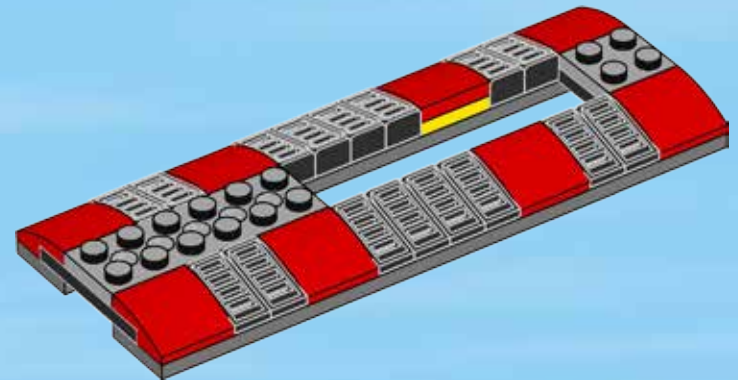



6x



1x

9

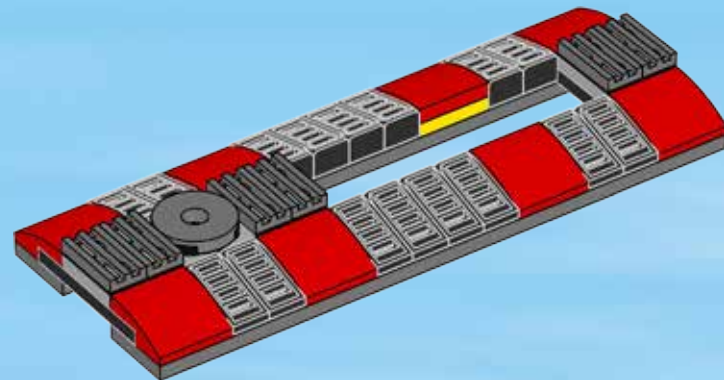

44



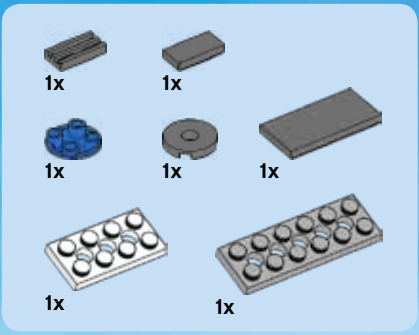

45

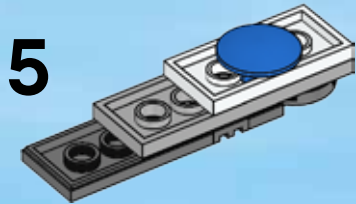
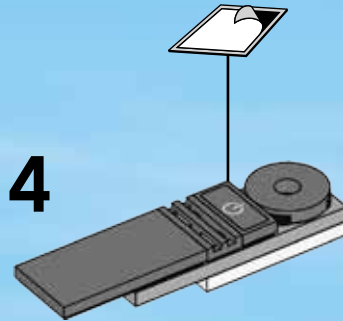
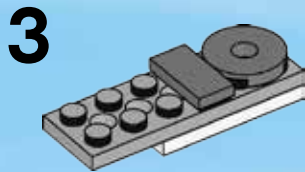
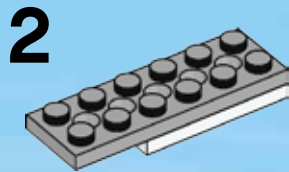

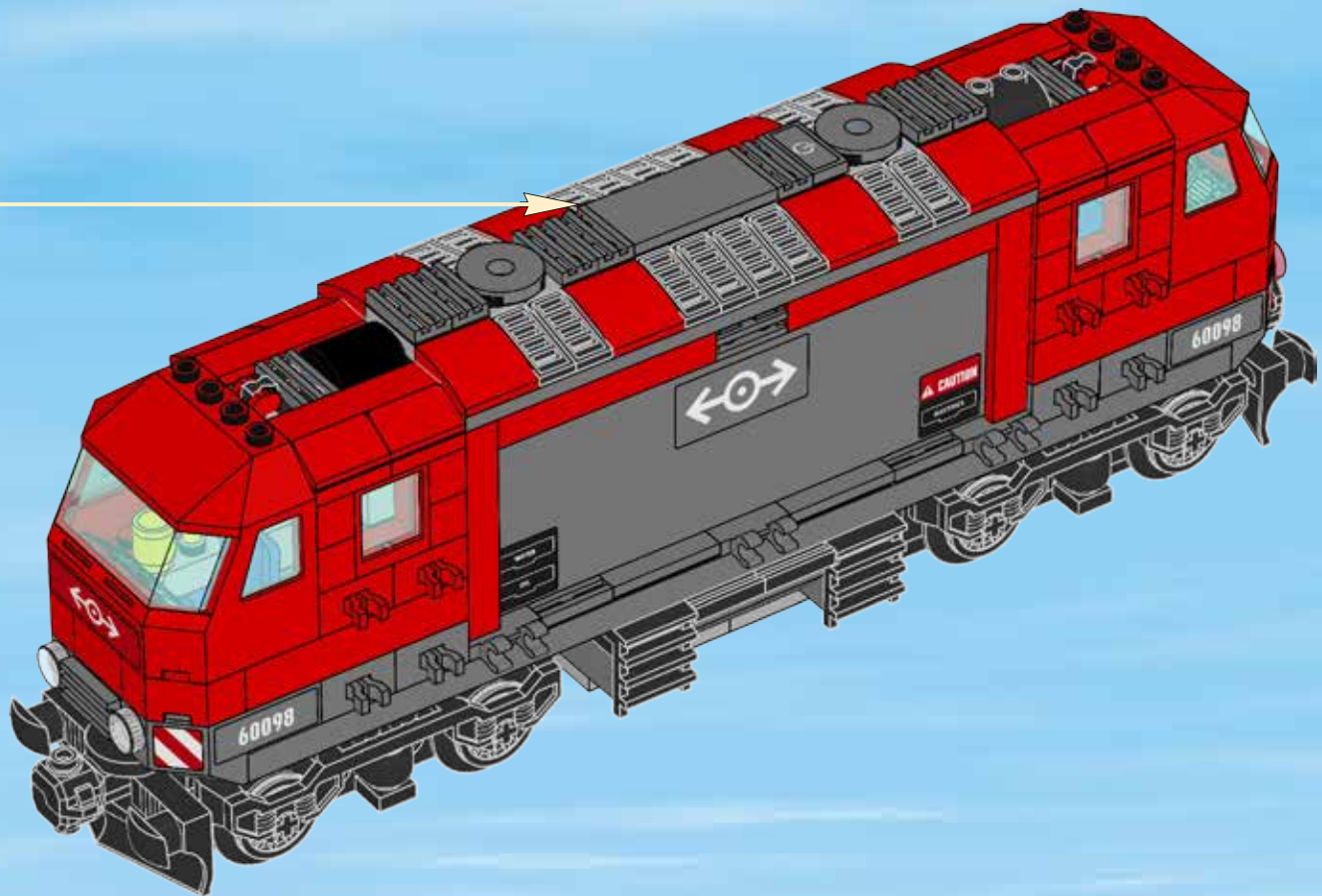

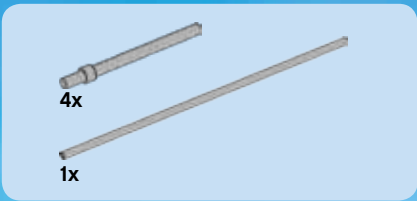

46





5x

47



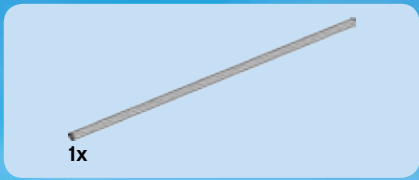

48



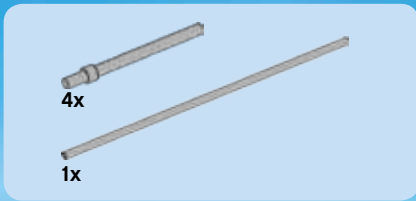

49





5x

50





51



52

