



CITY

60086



 LEGO.com/city



WARNING: CHOKING HAZARD.
Toy contains small parts and a small ball.
Not for children under 3 years.

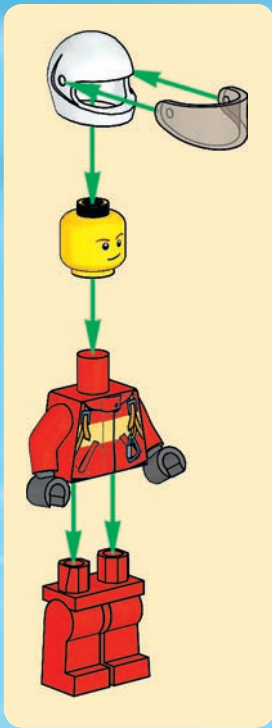
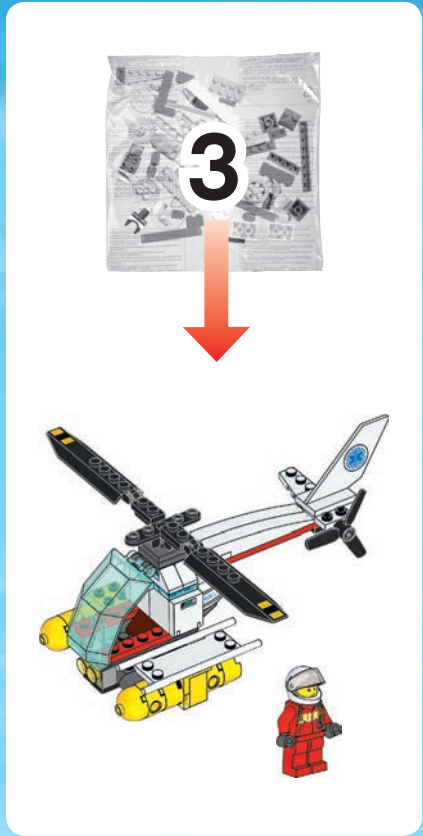

⚠ AVERTISSEMENT :
RISQUE D'ÉTOUFFEMENT.
Le jouet contient des petites pièces ainsi qu'une petite boule. Il ne convient pas aux enfants de moins de 3 ans.

⚠ ADVERTENCIA:
PELIGRO DE ASFIXIA.
Juguete que contiene partes pequeñas y una pelota pequeña. No recomendado para niños menores de 3 años.

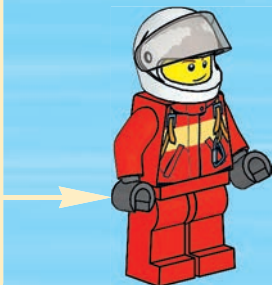

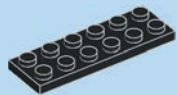

1x

1

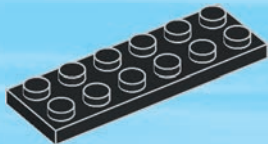

1x

2

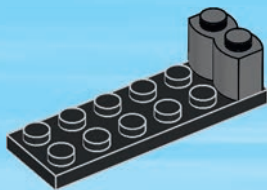



2x

3

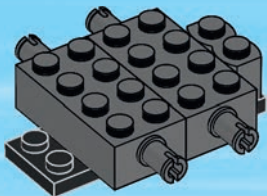

4



1x

4

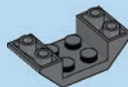
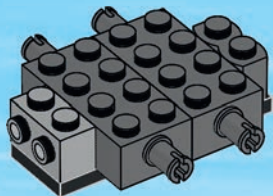

1x



1x

5

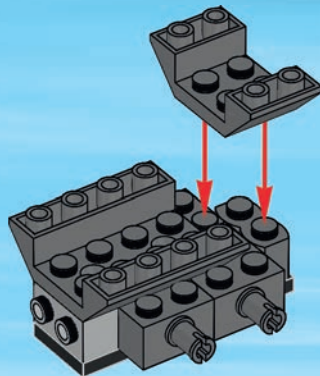



2x

6

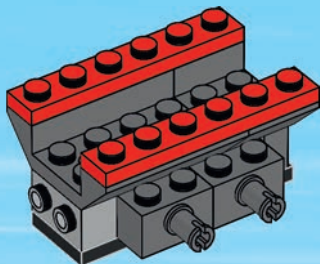



1x

7

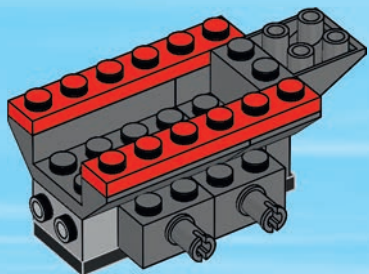

1x

8

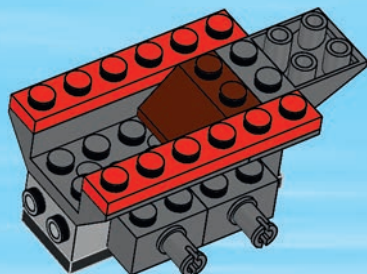



9

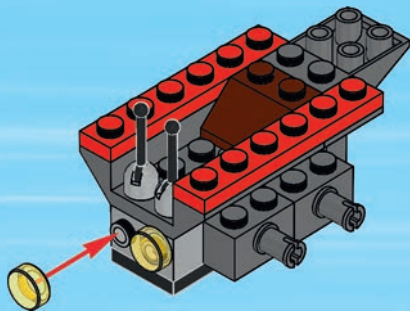

8



1x



1x



1x

10

1

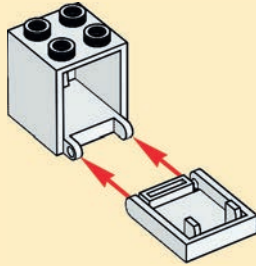

2

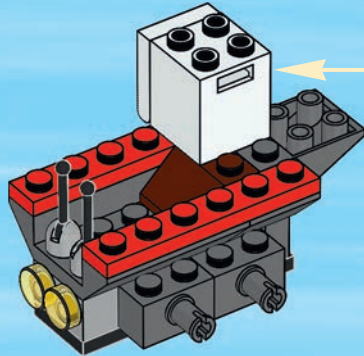
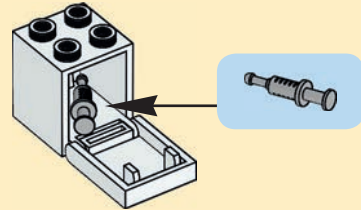

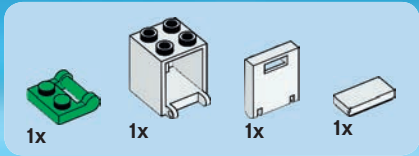

11

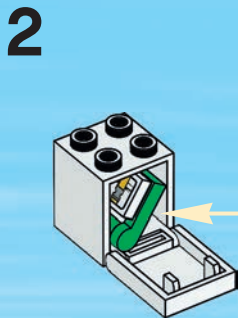
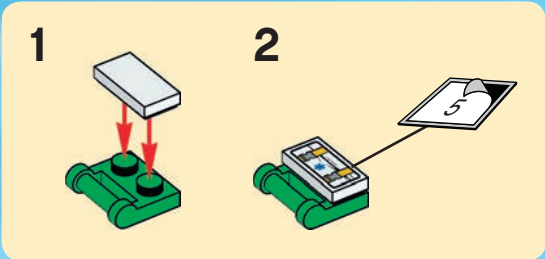
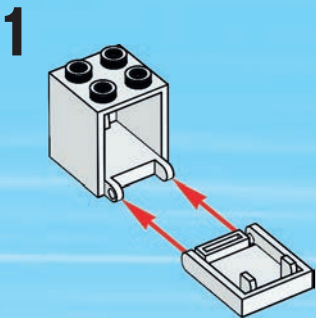

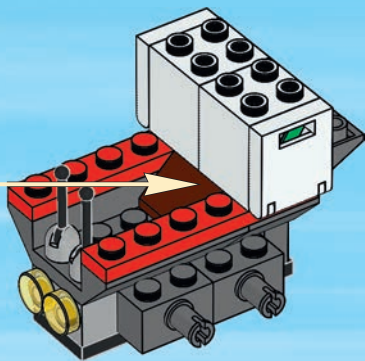



3x

12

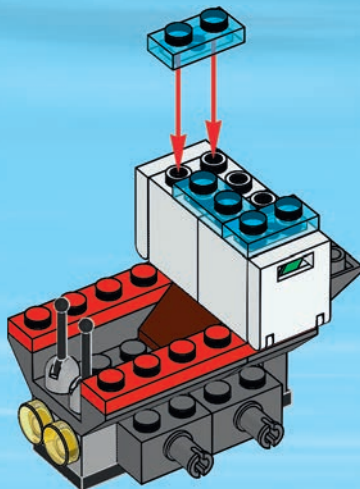



2x

13

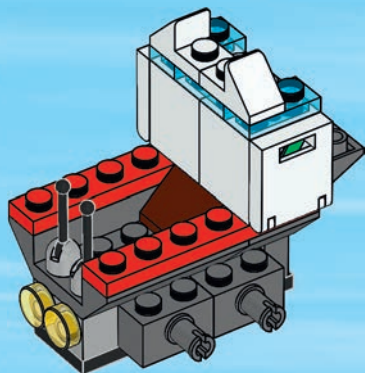

1x

14

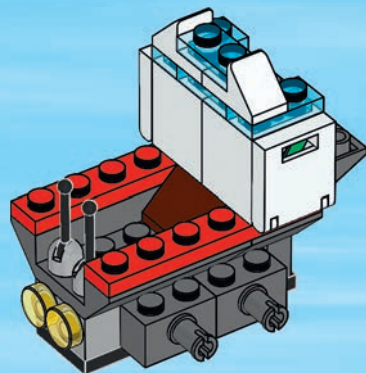



1x

1



1x



1x

2

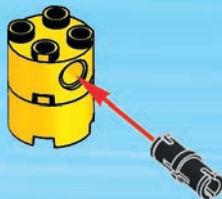



1x

3



1x



1x

4





1x

5

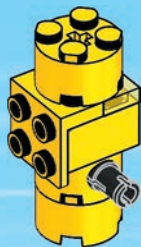

1x



1x

6

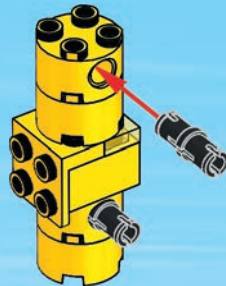



1x

7

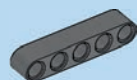
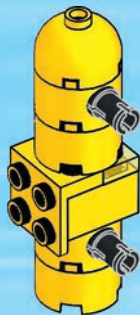

1x

8

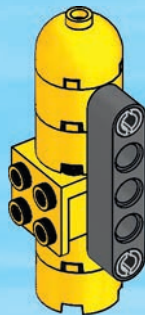

9

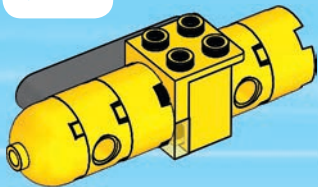

15

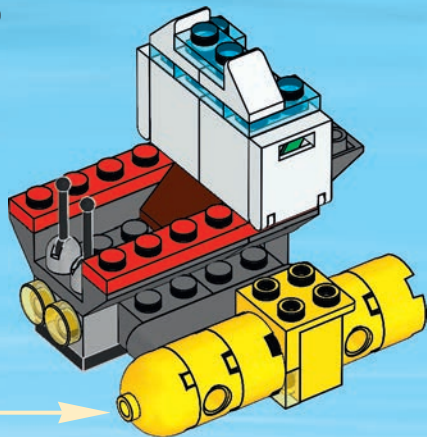



1x

1



1x



1x

2





1x

3



1x



1x

4





1x

5

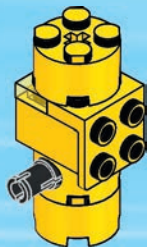

1x



1x

6

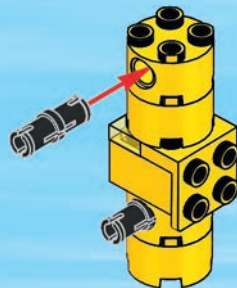



1x

7



1x

8

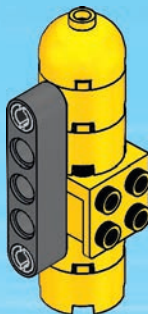

9

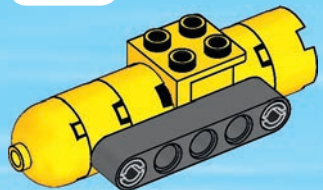

16

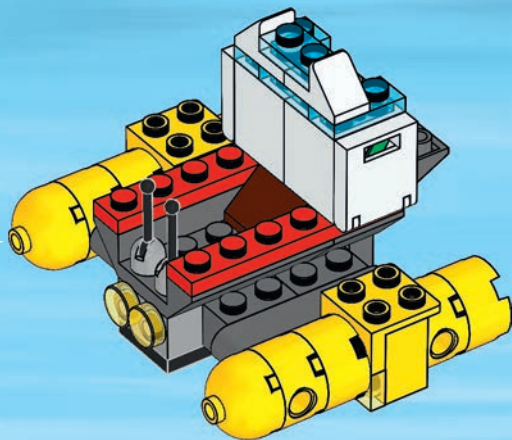



1x



1x

17

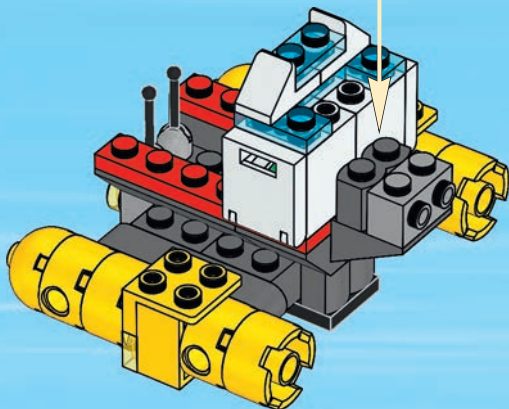



2x

18

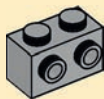

2x

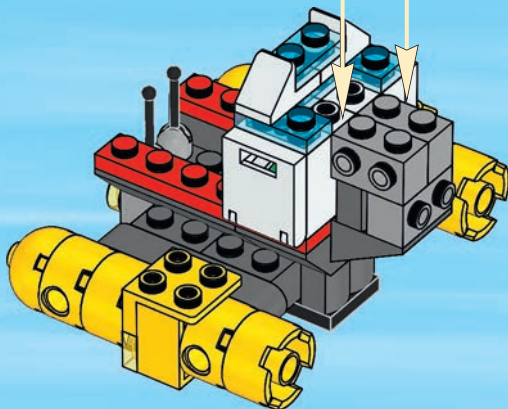



2x

19

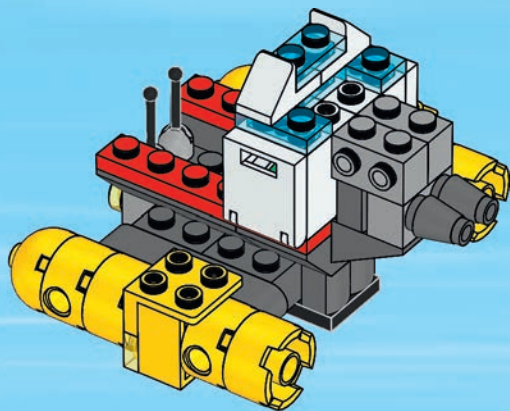



1x

20

1



2

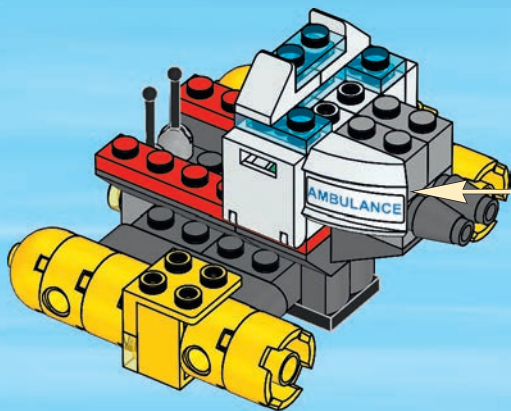



1x

21

1



2

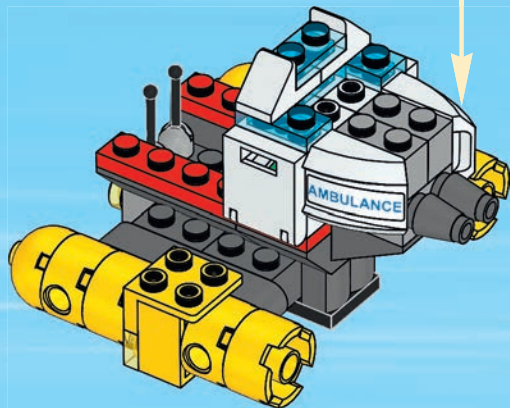

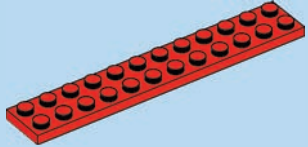
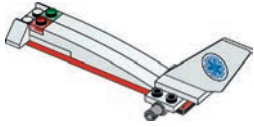

1x



2x

1

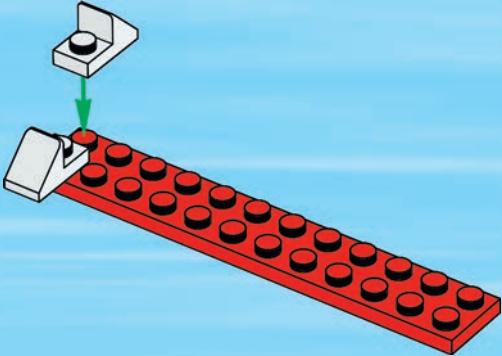

1x

2

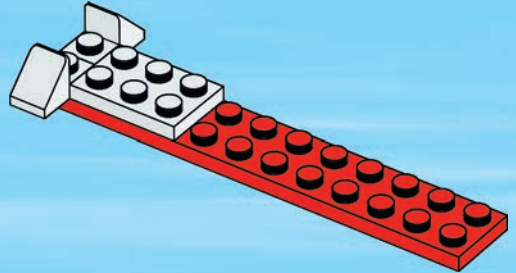

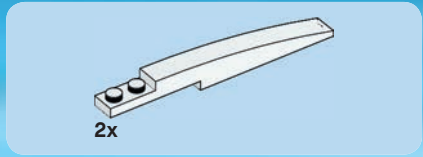

3

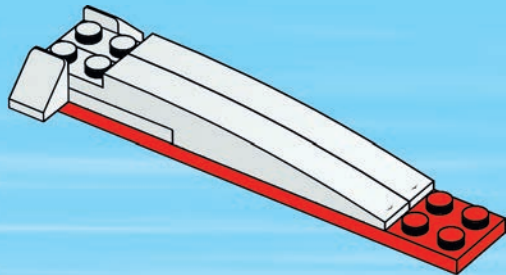



1x



1x

4

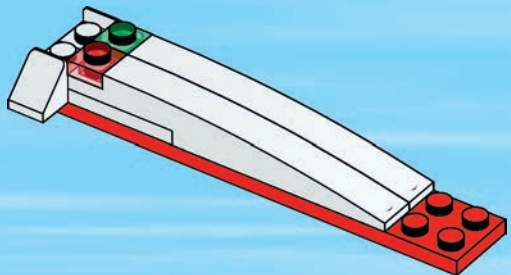

1x

5

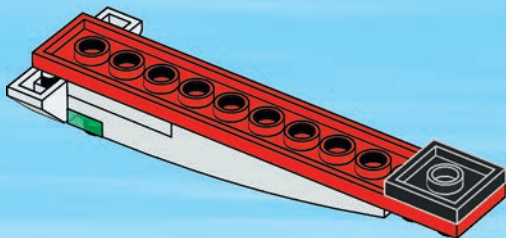



1x



1x

6

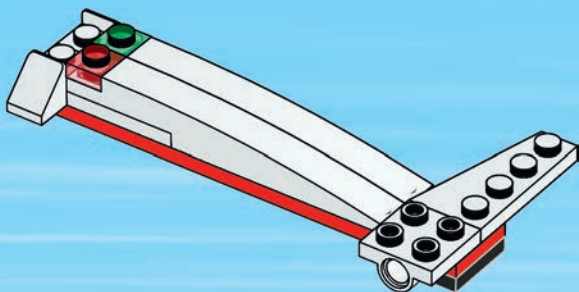

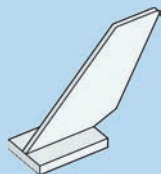

1x

7

1

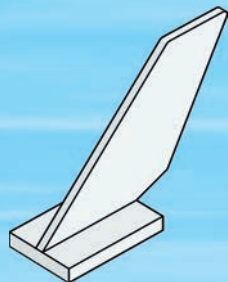

2

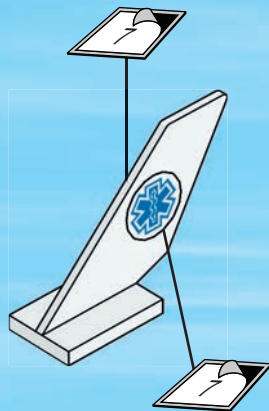

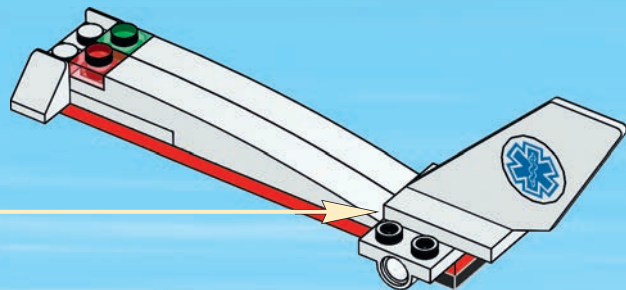



1x

8

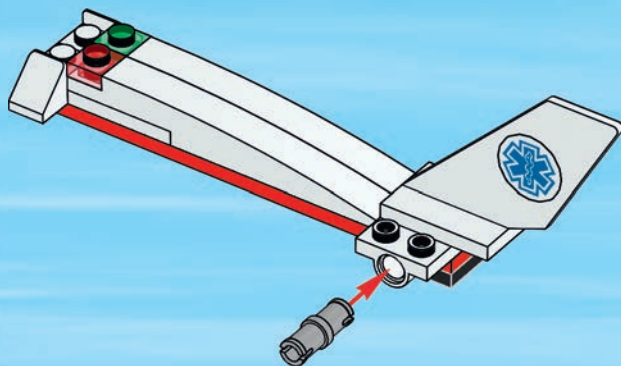

22

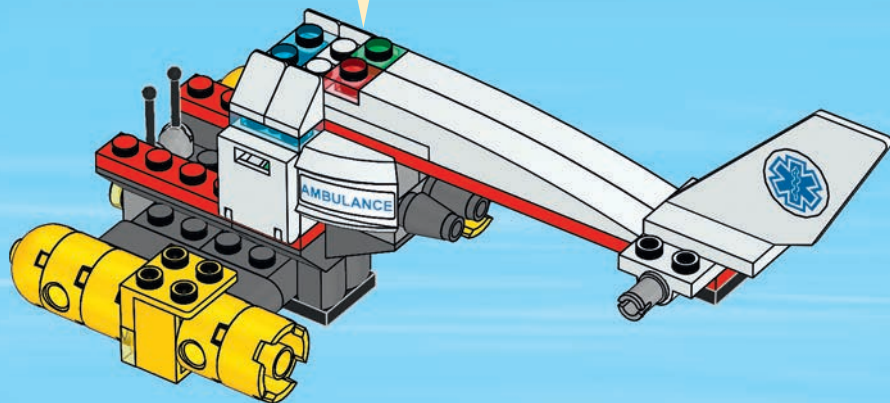



2x

23

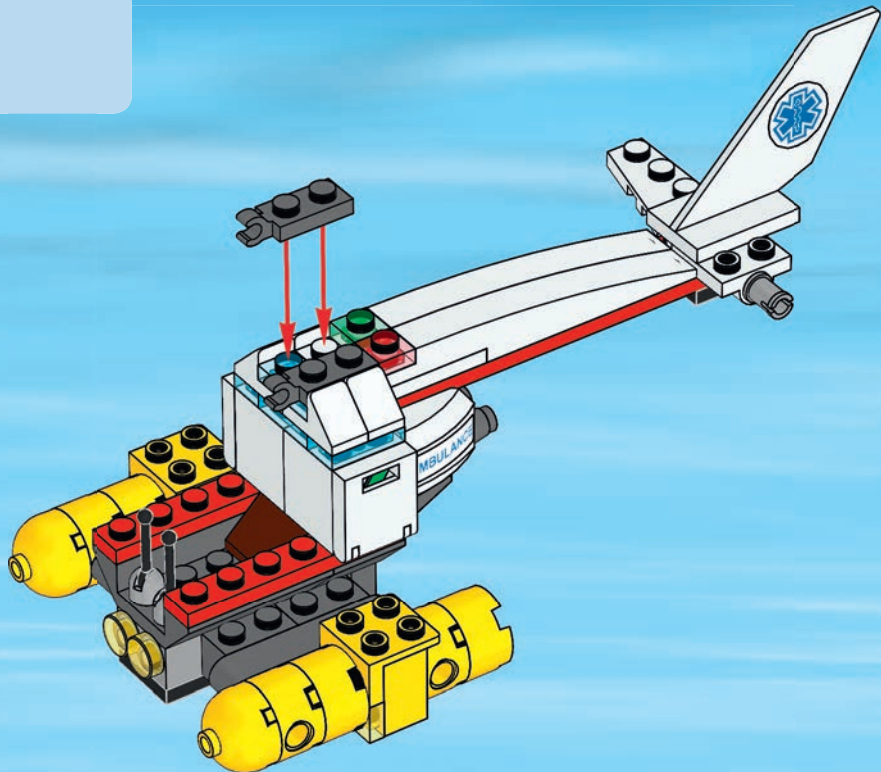



1x

24

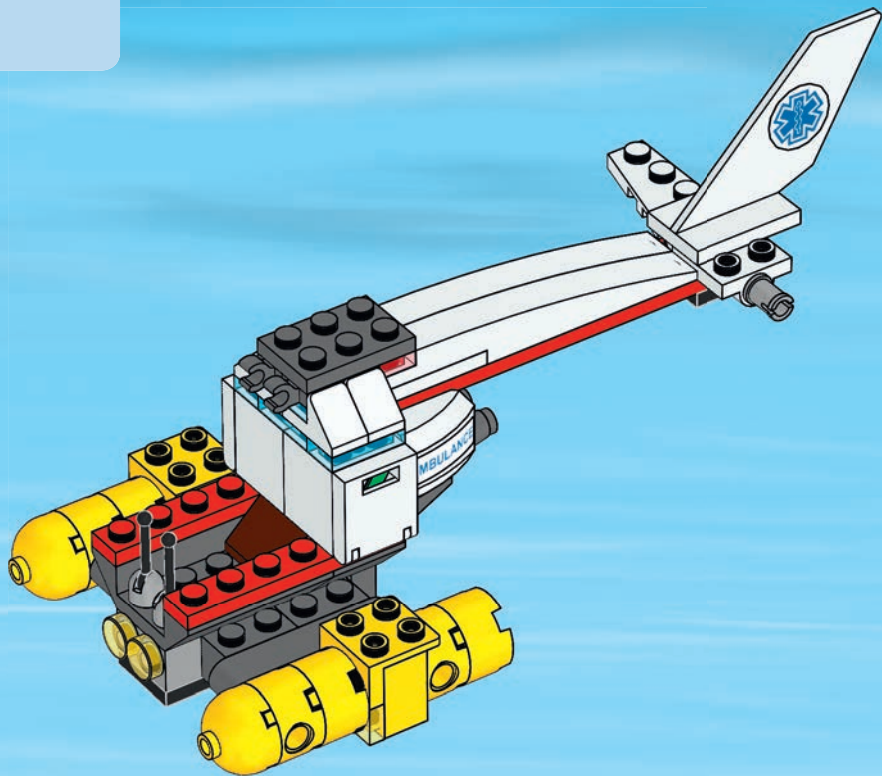



1x



1x

25

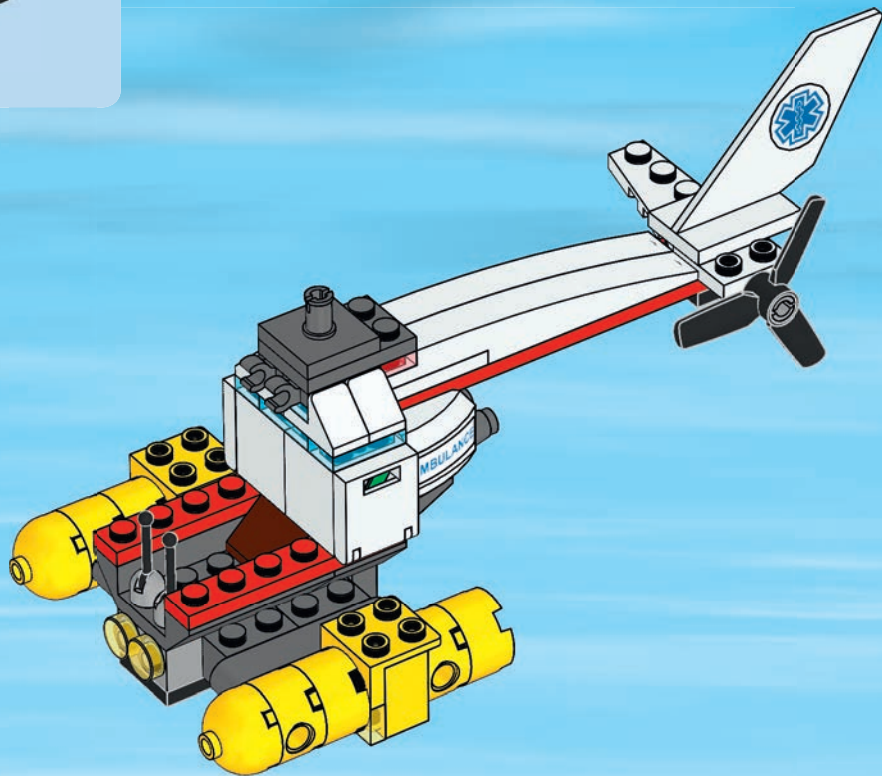

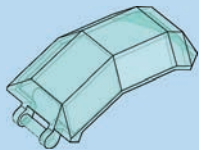

1x

26

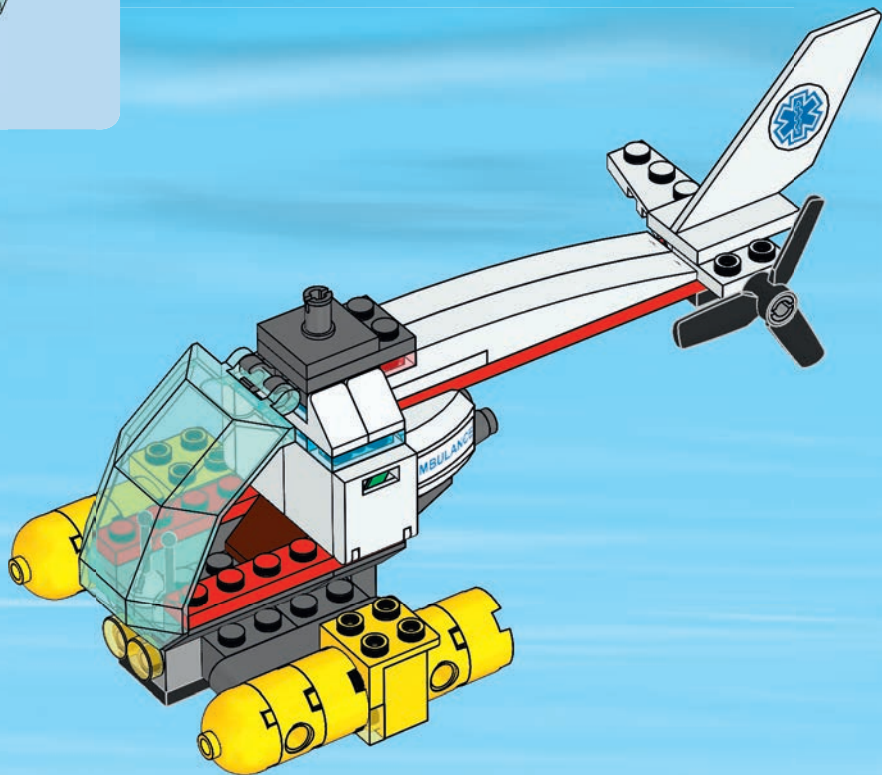



1x

27

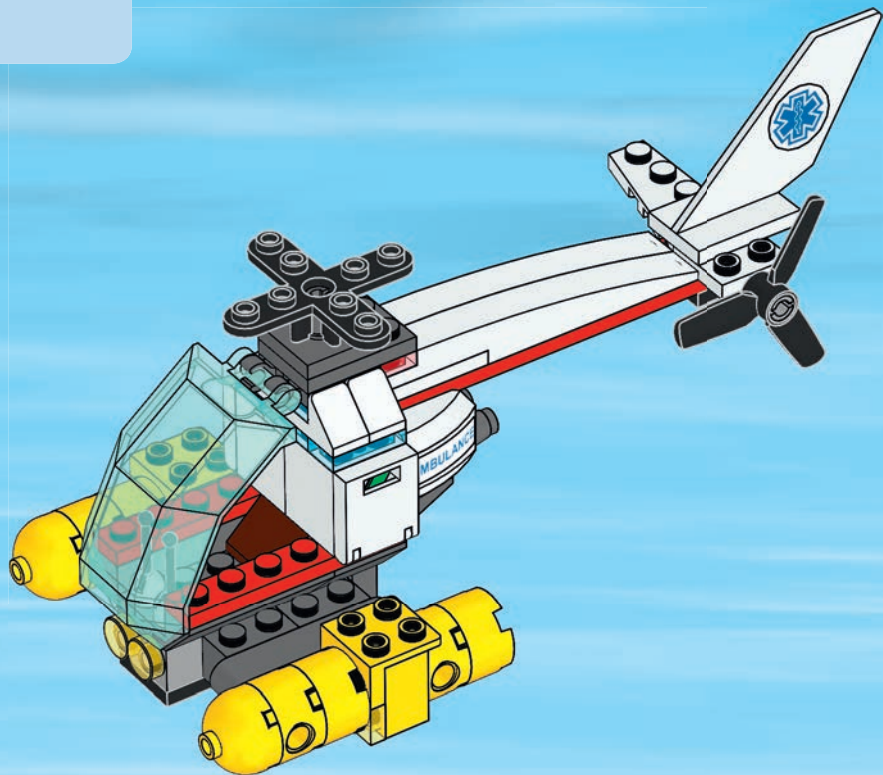

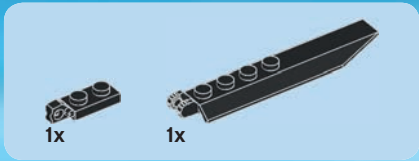

28

1

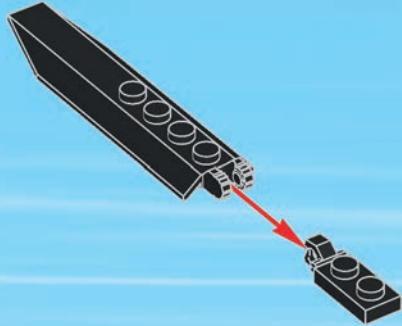

2

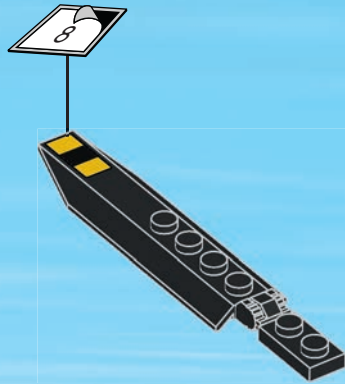

2x

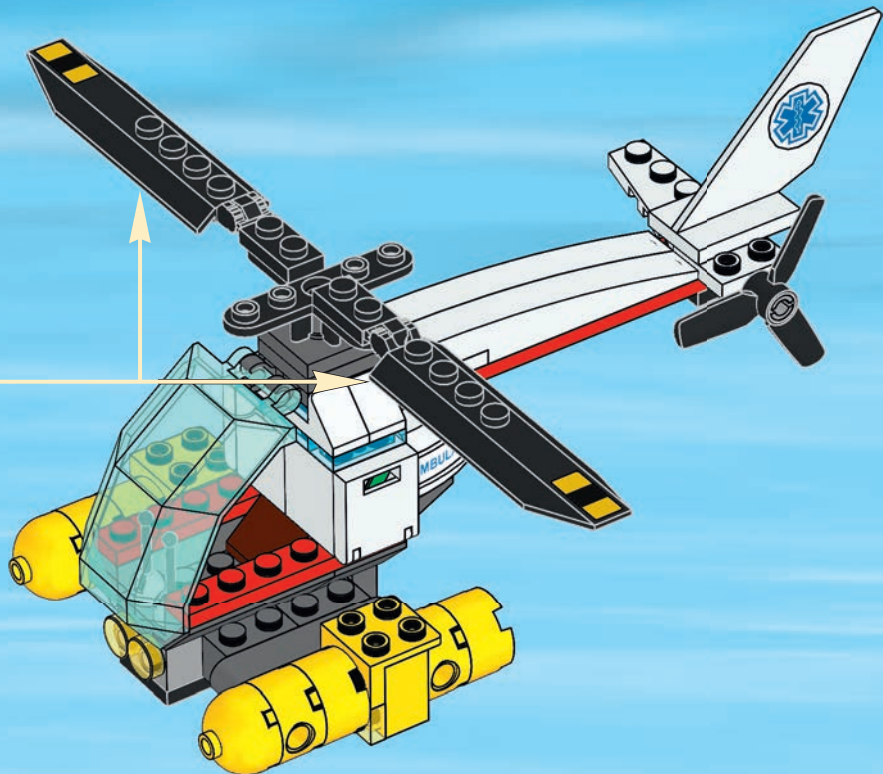

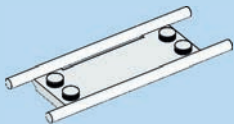

1x

29

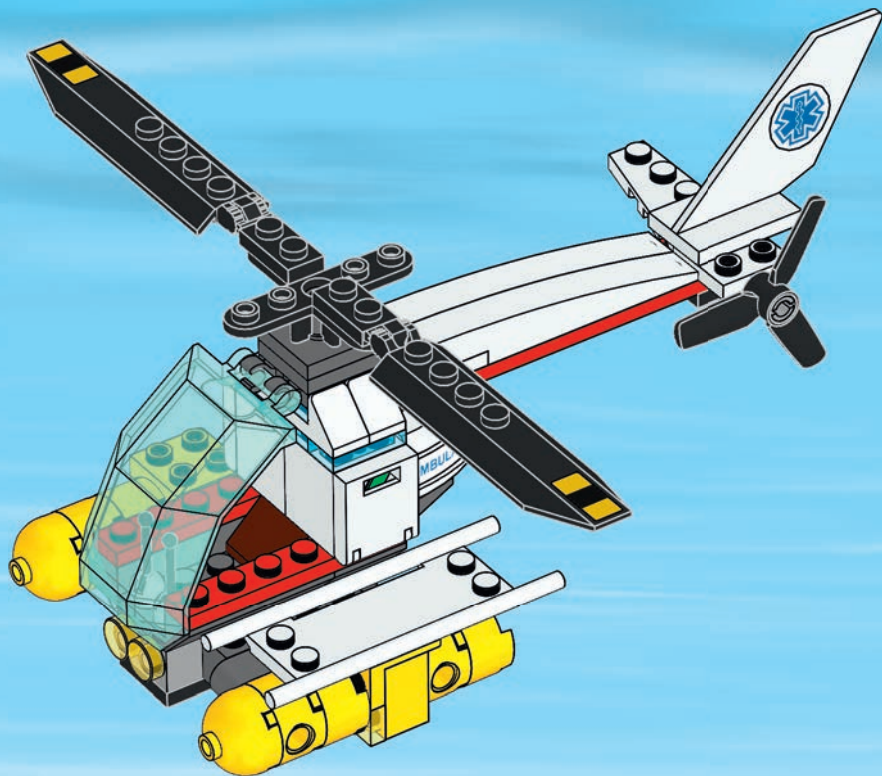

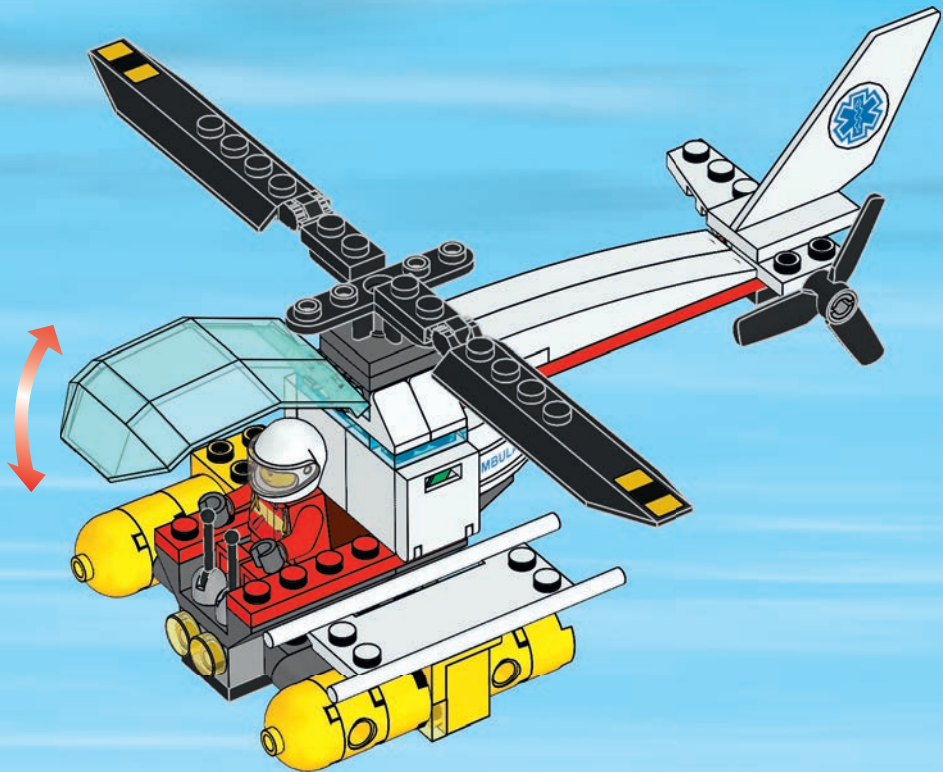



FREE ONLINE GAME & APP!
JEU EN LIGNE ET APPLI GRATUITS !
¡JUEGO ONLINE Y APP GRATIS!



LEGO.COM/CITY

ANDROID APP ON
Google play

Available on the
App Store



Apple, the Apple logo, iPad, iPhone and iPod touch are trademarks of Apple Inc., registered in the U.S. and other countries. App Store is a service mark of Apple Inc./Apple. Le logo Apple, iPad, iPhone et iPod touch sont des marques de commerce d'Apple Inc., déposées aux États-Unis et dans d'autres pays. App Store est une marque de service d'Apple Inc./Apple, et le logo de Apple, iPad, iPhone et iPod touch sont des marques de commerce d'Apple Inc., enregistrées en É.-U. et dans d'autres pays. App Store est une marque de service de Apple Inc. Google Play is a trademark of Google Inc./Google Play est une marque de commerce de Google Inc./Google Play est un marca comercial de Google Inc.





1x
9342



1x
6032091



1x
434921



1x
4599453



1x
4611701



2x
366621



2x
4221775



4x
4121715



2x
4295260



1x
4521931



1x
3000841



2x
4201019



1x
4155537



1x
6079141



1x
6019162



1x
4654448



1x
6016453



4x
4266417



6x
4260426



2x
4194746



4x
4650500



1x
6018507



1x
4163306



1x
4598955



1x
4162916



1x
6056241



2x
4650879



2x
4649066



1x
4261397



1x
4211202



1x
4211383



1x
4211564



5x
6015344



1x
4211436



2x
4211438



1x
6117967



2x
4278273



1x
4563719



1x
4641048



6x
4211764



1x
4211807



1x
4217436



2x
4211095



2x
4580437



2x
4529240



2x
4210718



1x
4211064



1x
4211076



1x
4658974



3x
6071261



1x
4210631



2x
4211043



2x
4211001



6x
4581225



1x
6013082



1x
4211129



1x
4222693



1x
4211065



1x
4211002



1x
4210997



1x
6012812



1x
4261908



1x
4218696



1x
6063277



1x
6015890



2x
4210686



1x
4157108

Customer Service
Kundenservice
Service Consommateurs
Servicio Al Consumidor
LEGO.com/service or dial

00800 5346 5555 :     
1-800-422-5346 :  



LEGO and the LEGO logo are trademarks of the/son/les marques de commerce du/son marcas registradas de LEGO Group. ©2015 The LEGO Group. 61325663