



4850

Spider-Man's
first chase

SPIDER-MAN™



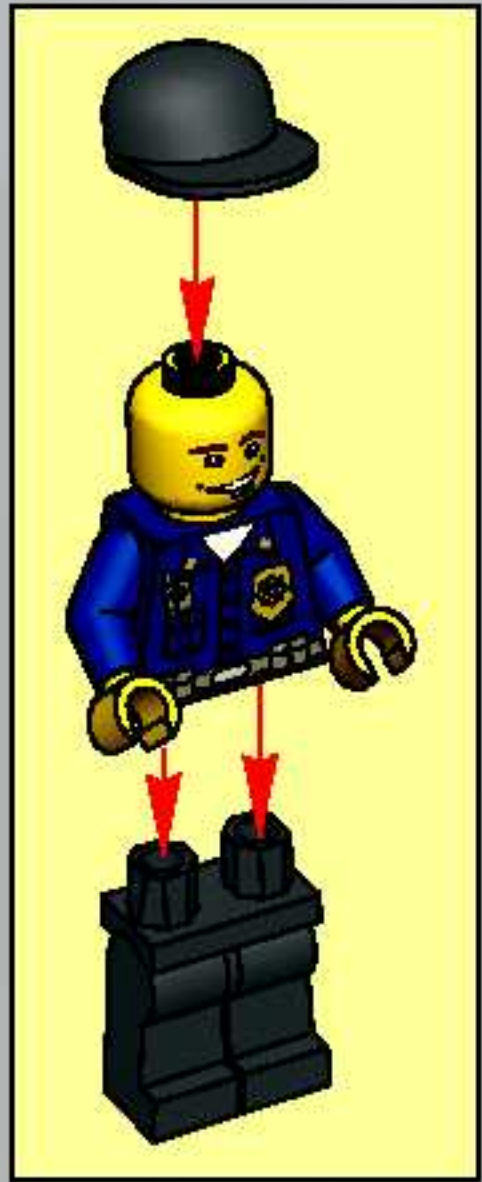

1

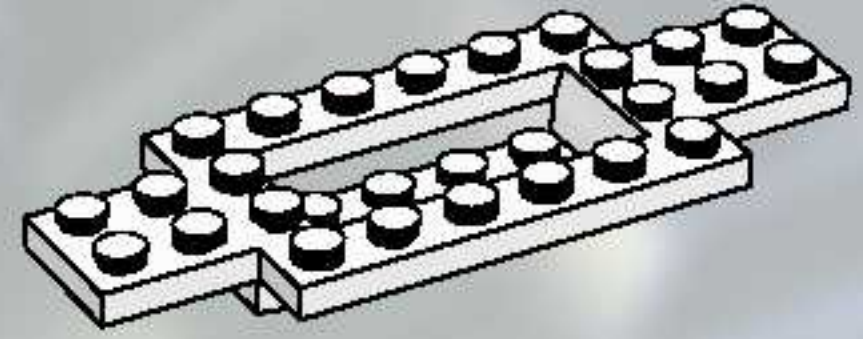

2

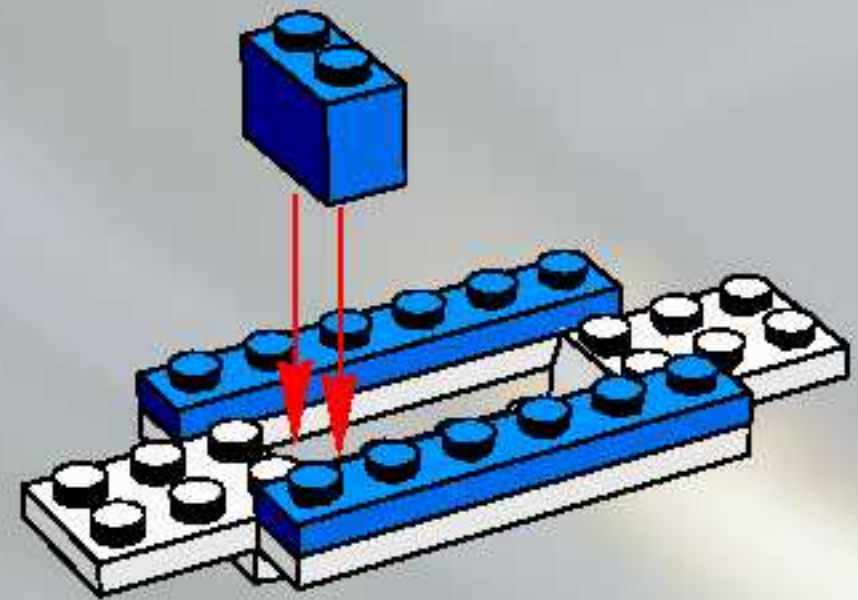

3

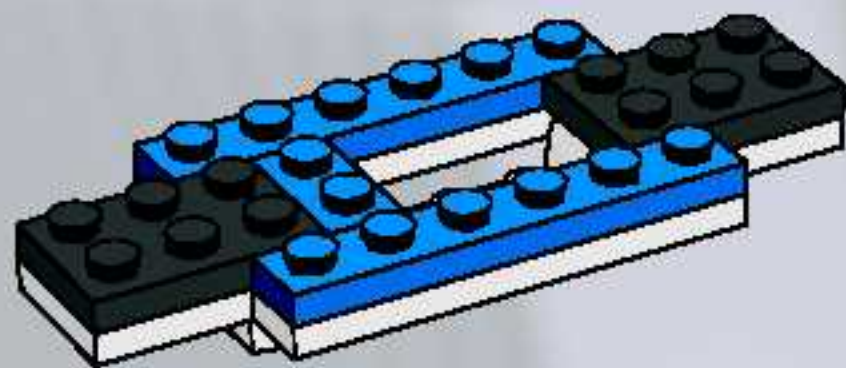

4

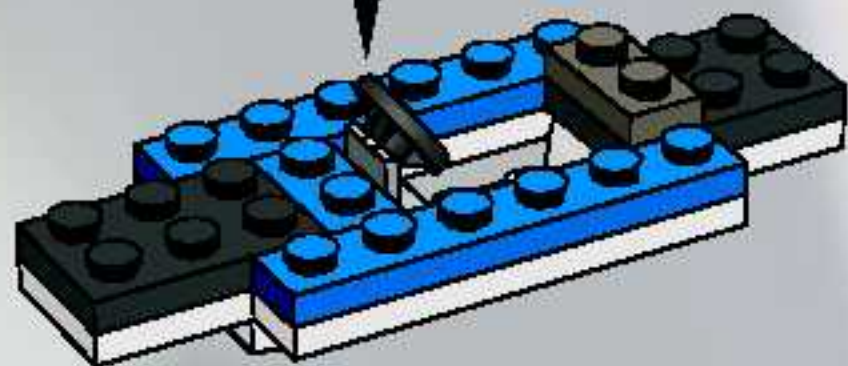

1

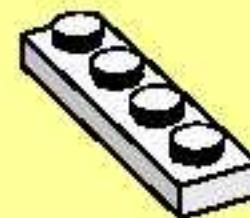

2

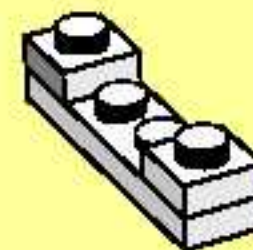

5

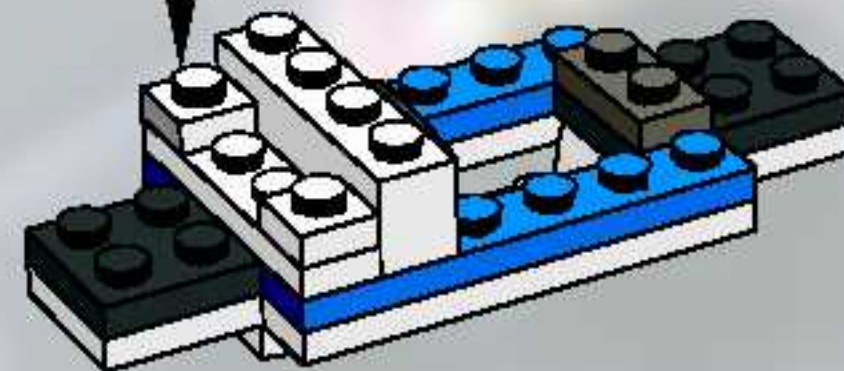

6

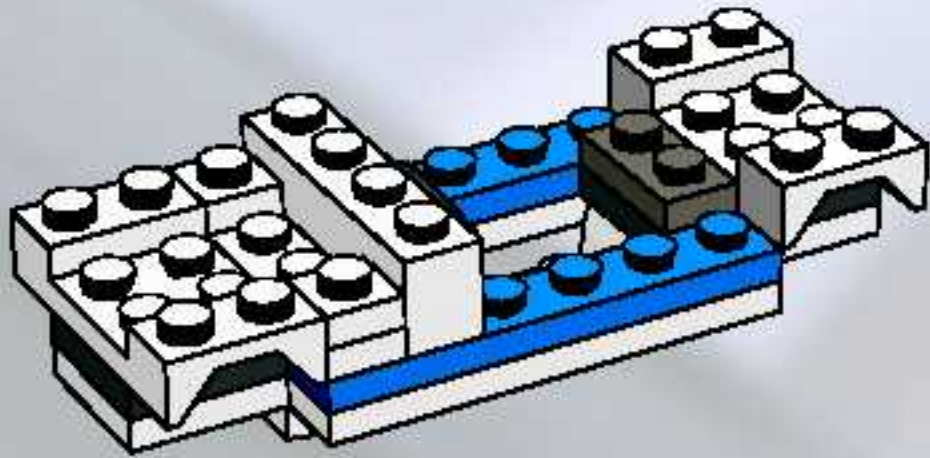

7

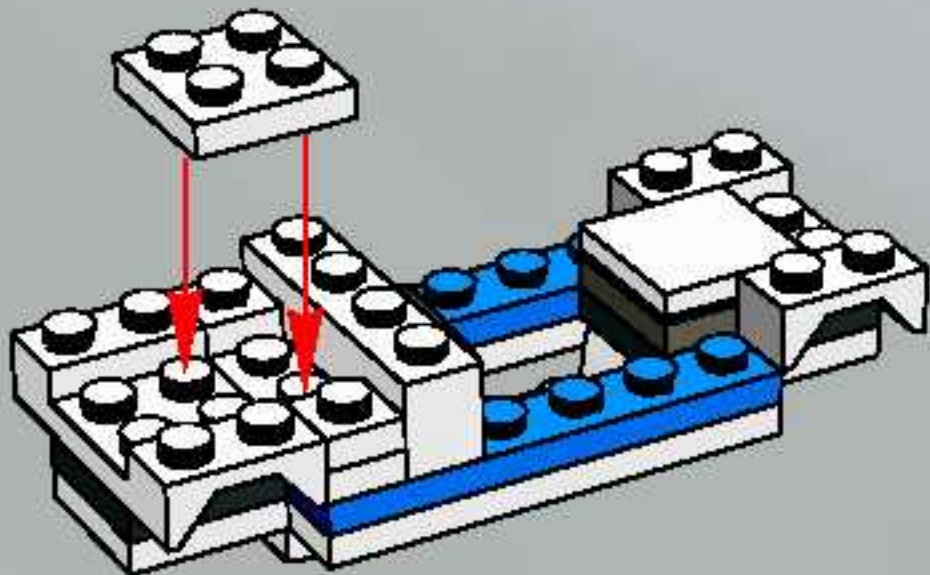

1

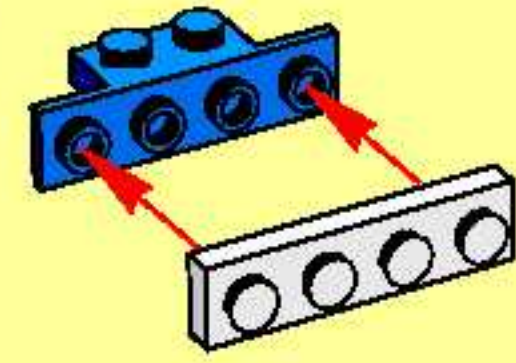

2

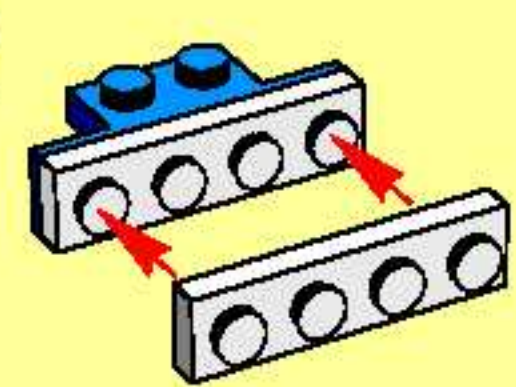

3

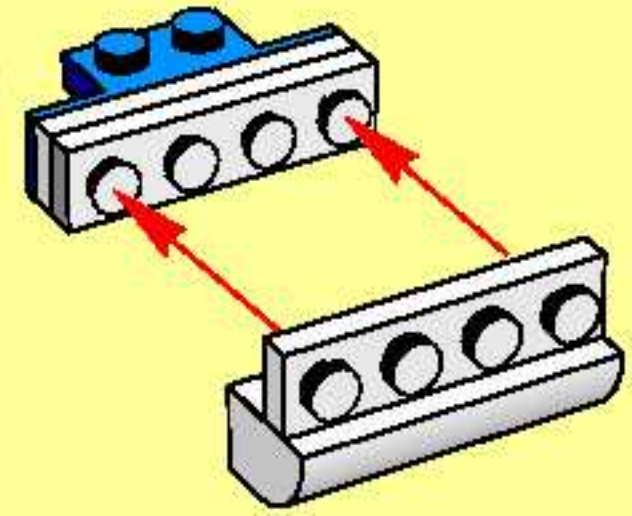

4

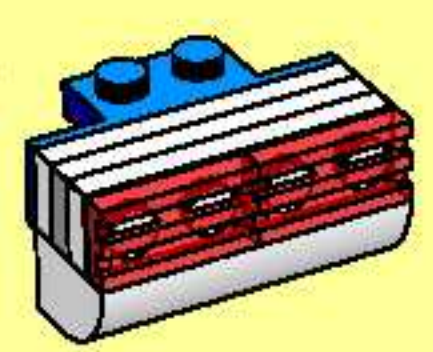

8

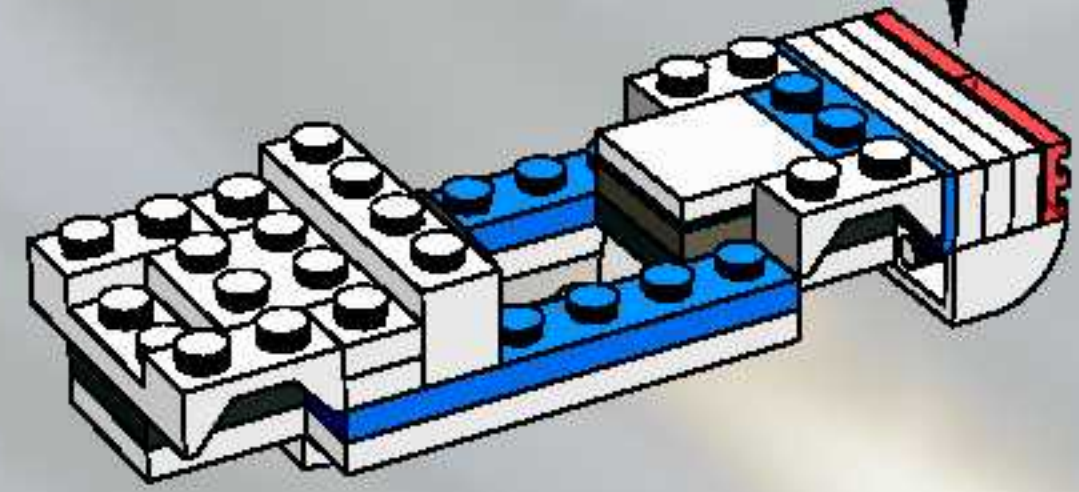

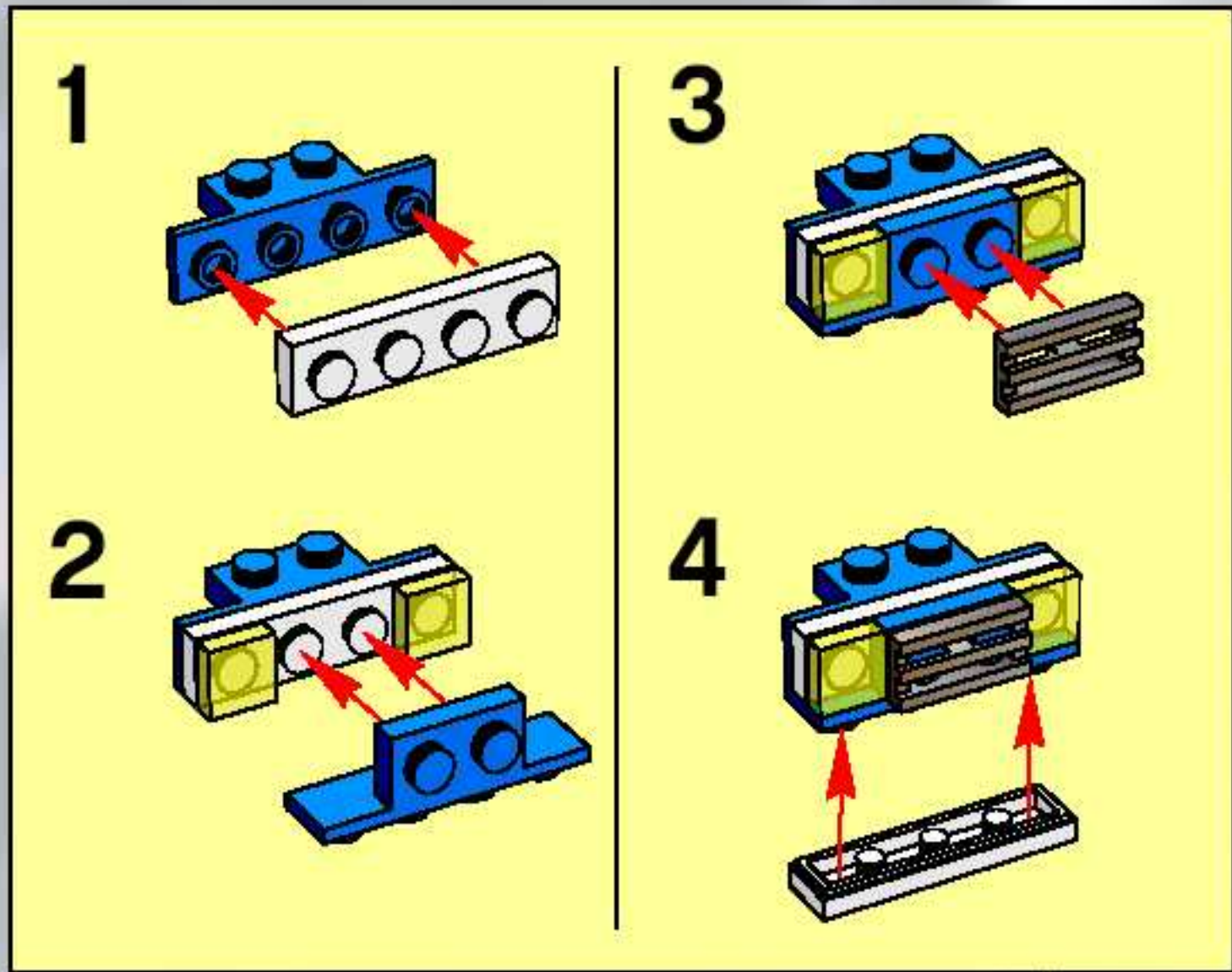

10

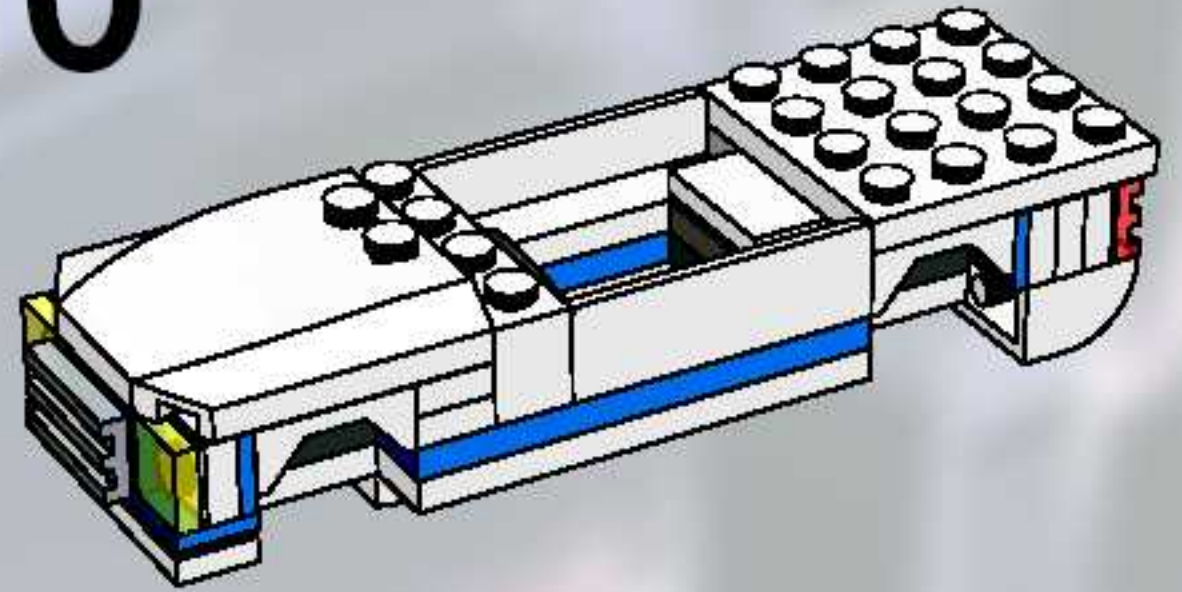

11

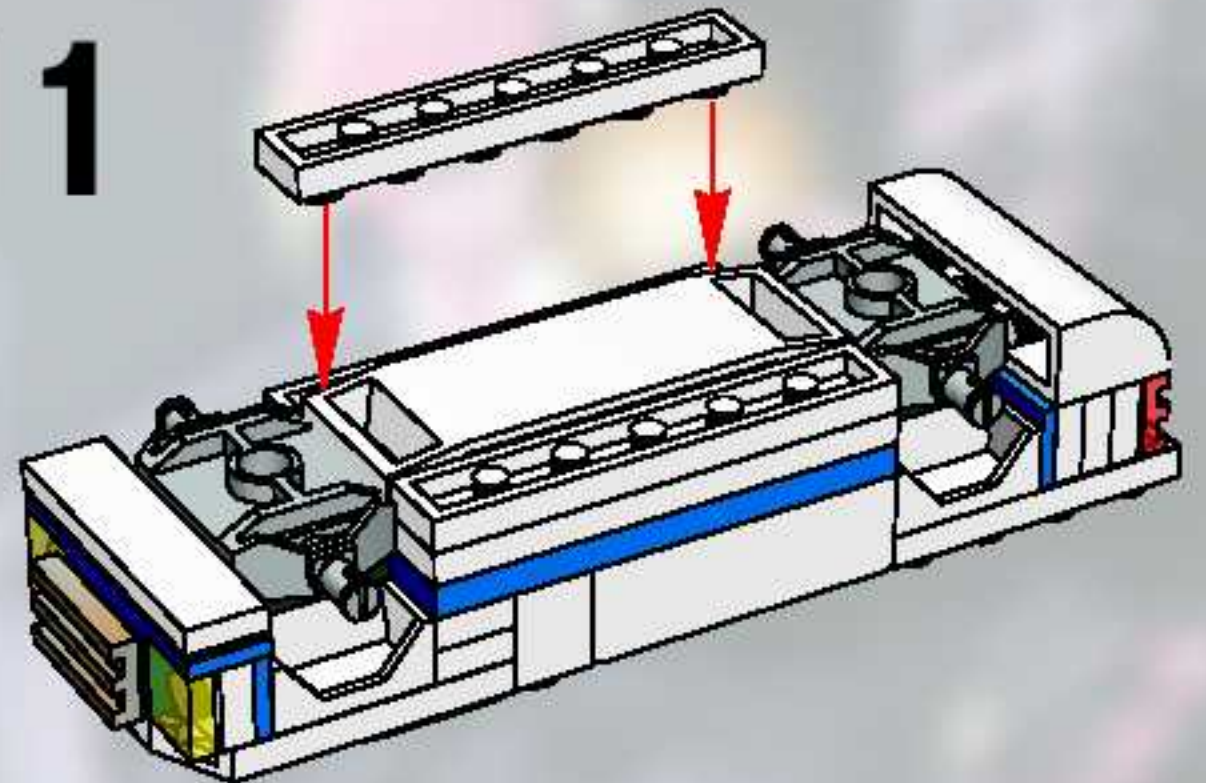

9

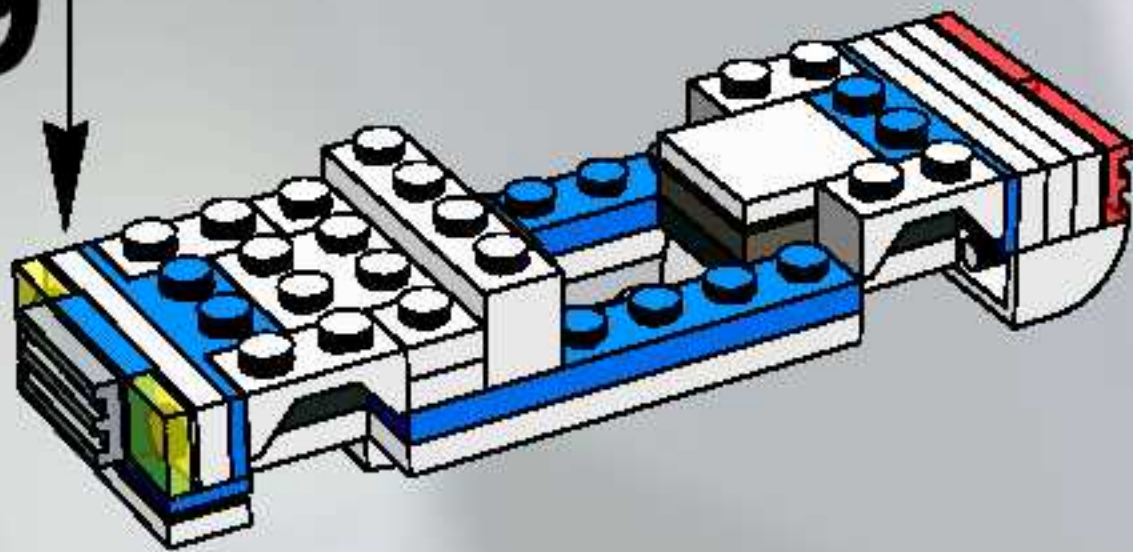

12

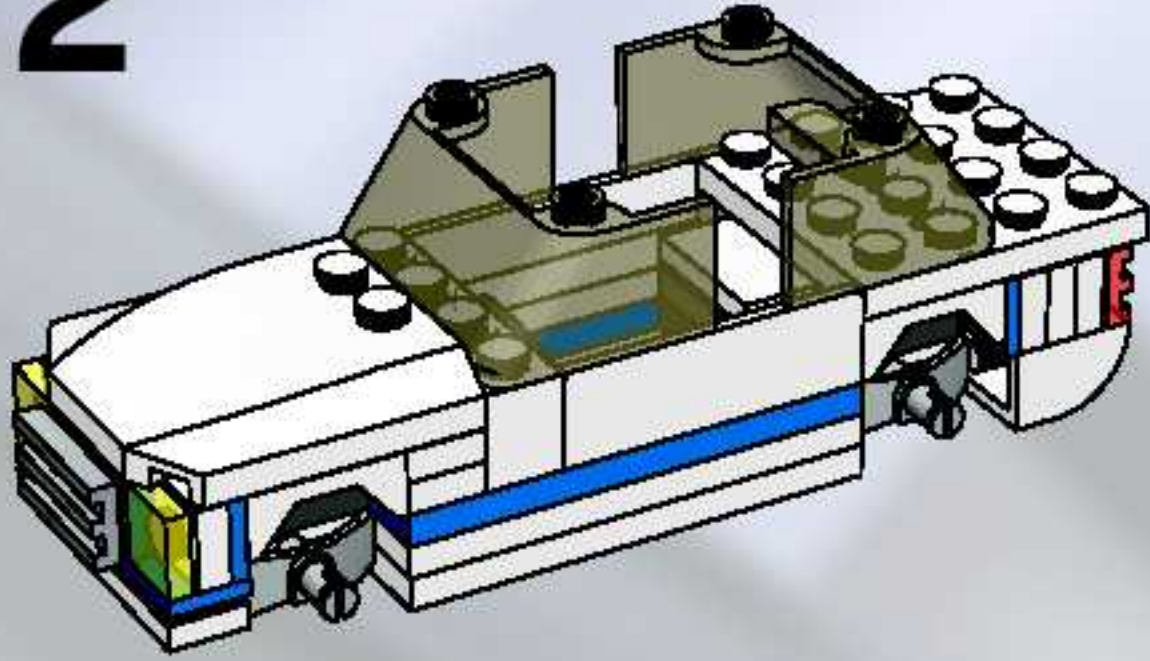

14

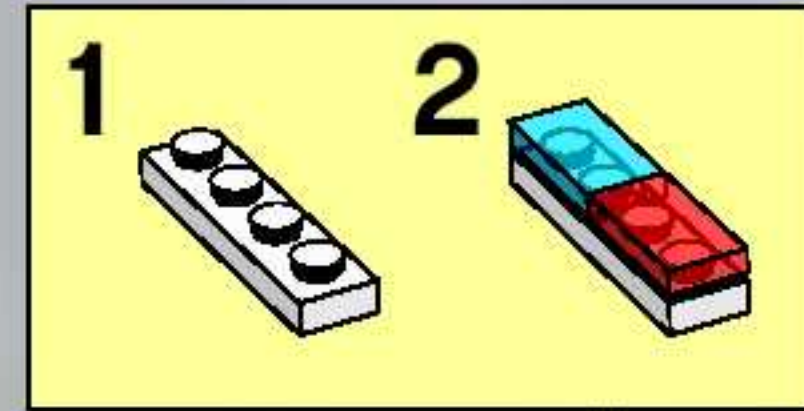
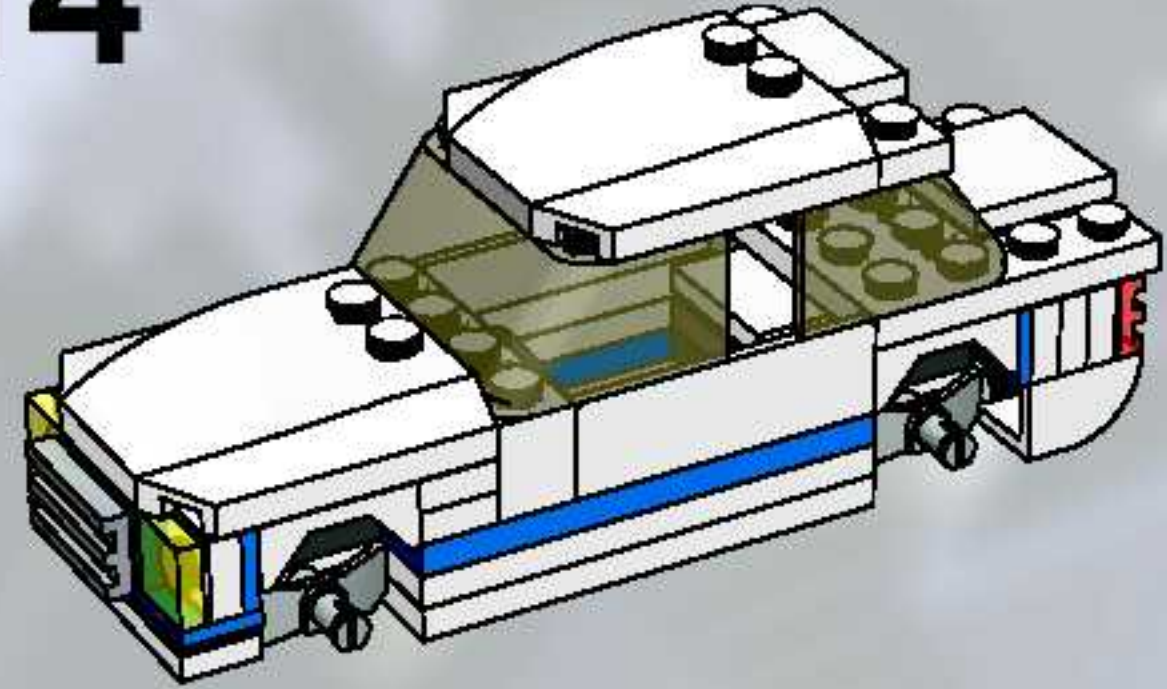

13

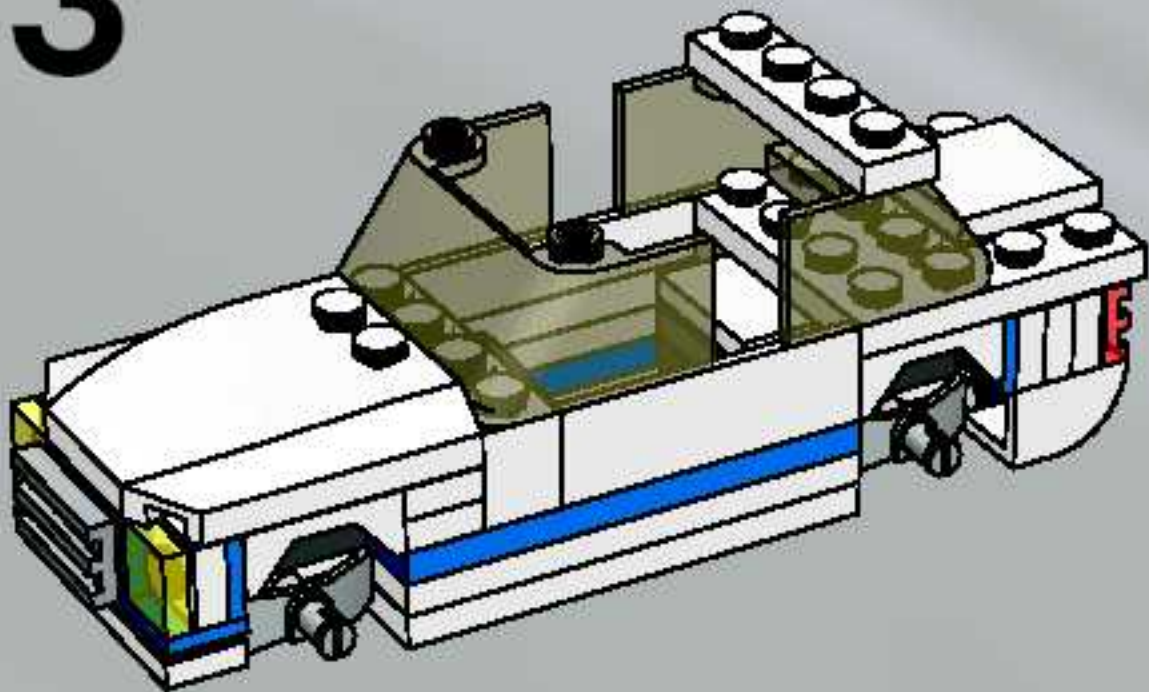

15



2

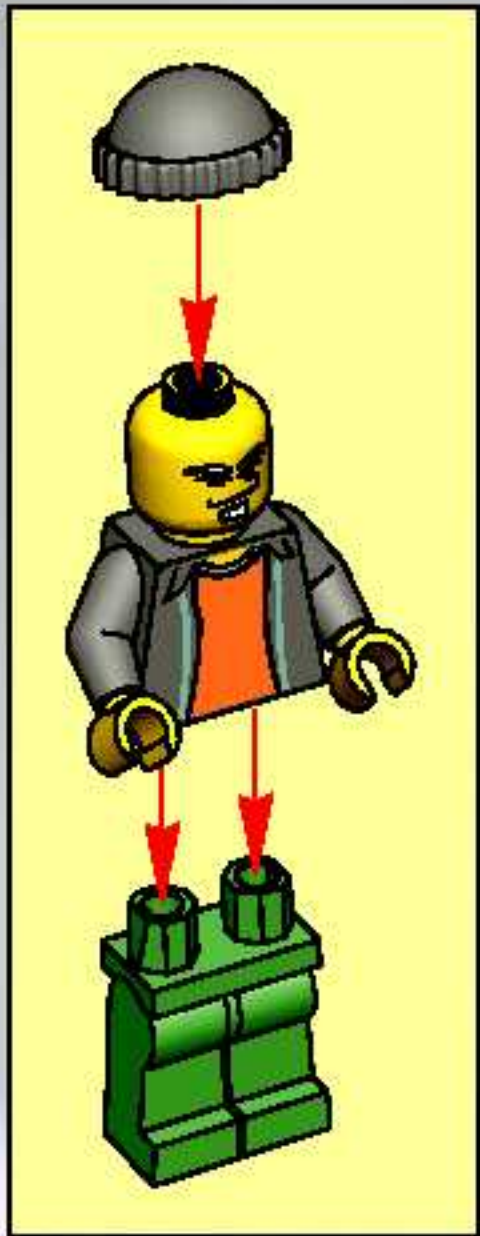

1

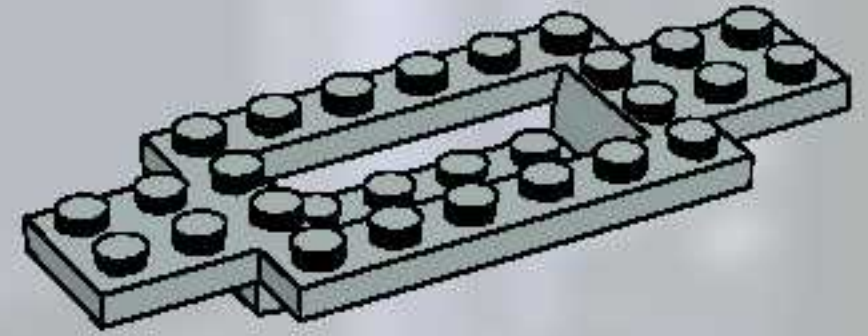

2



3

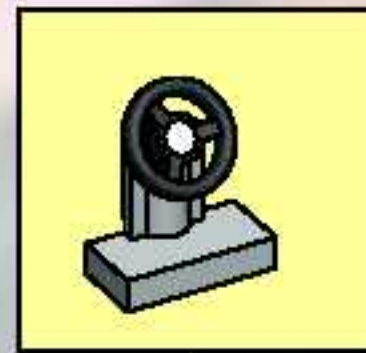

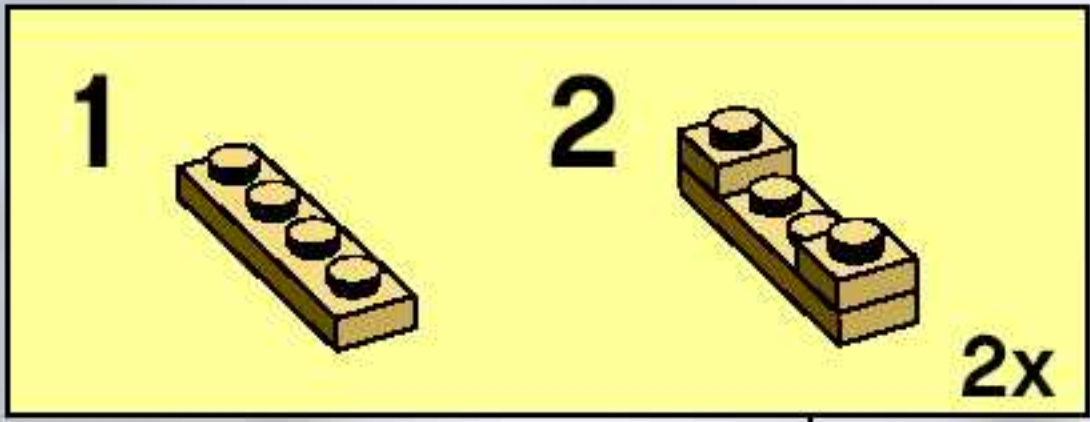

4

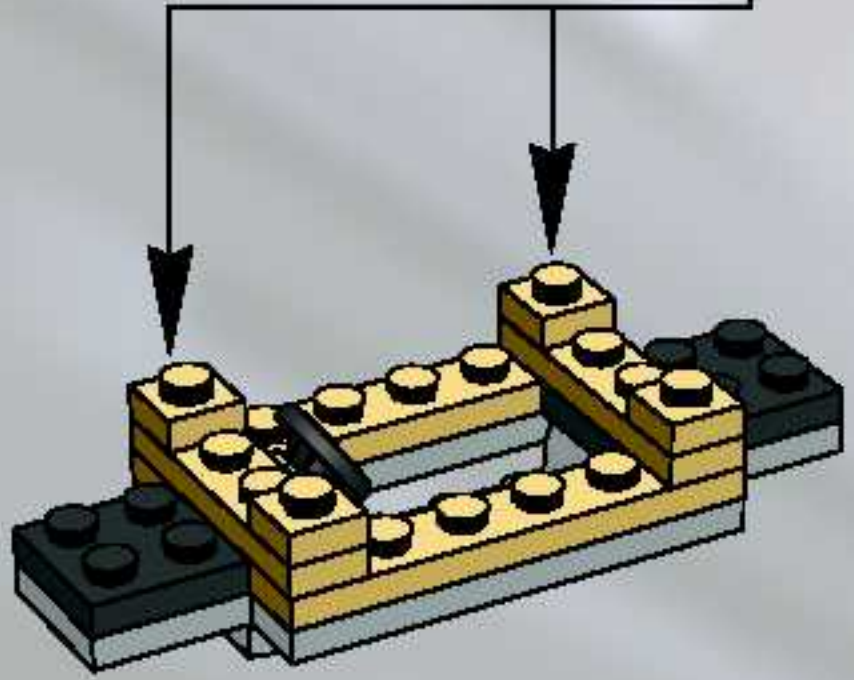

5

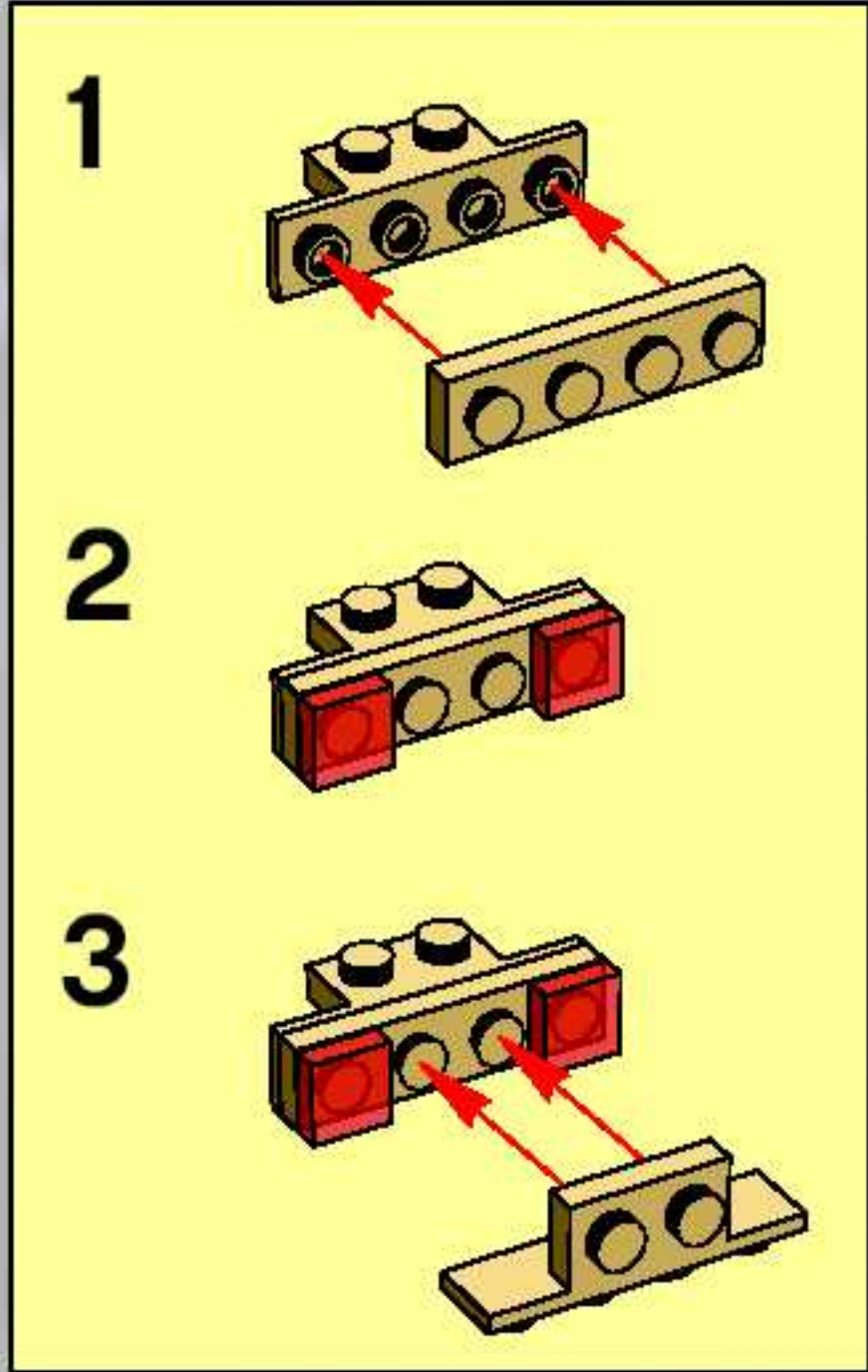
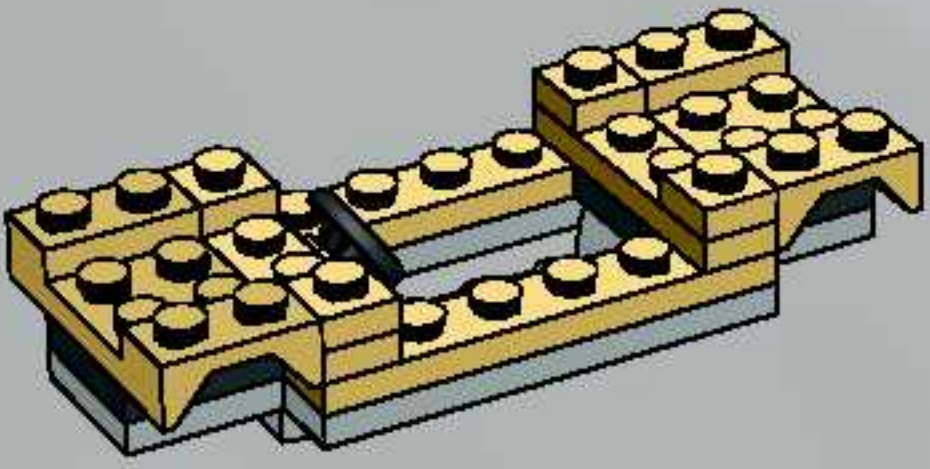

6

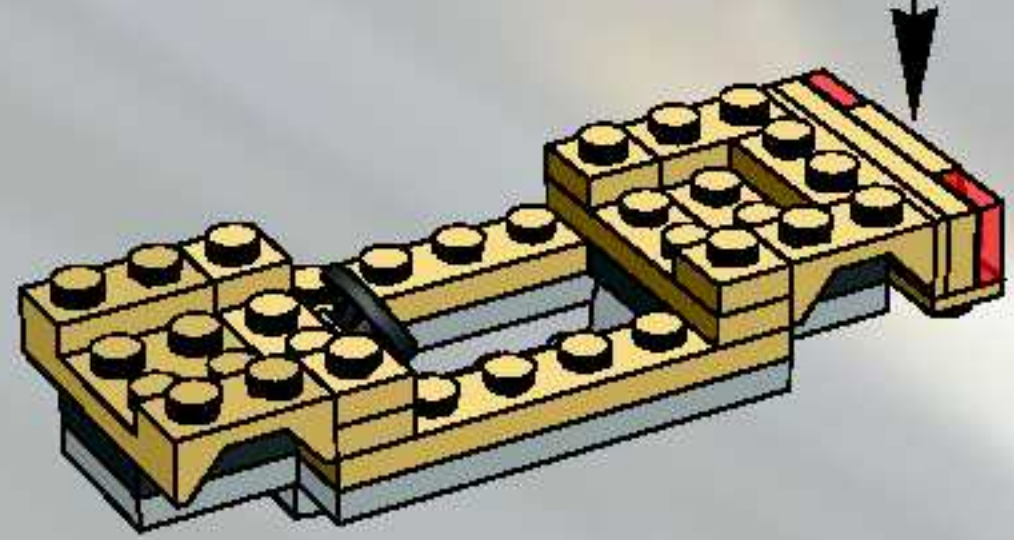

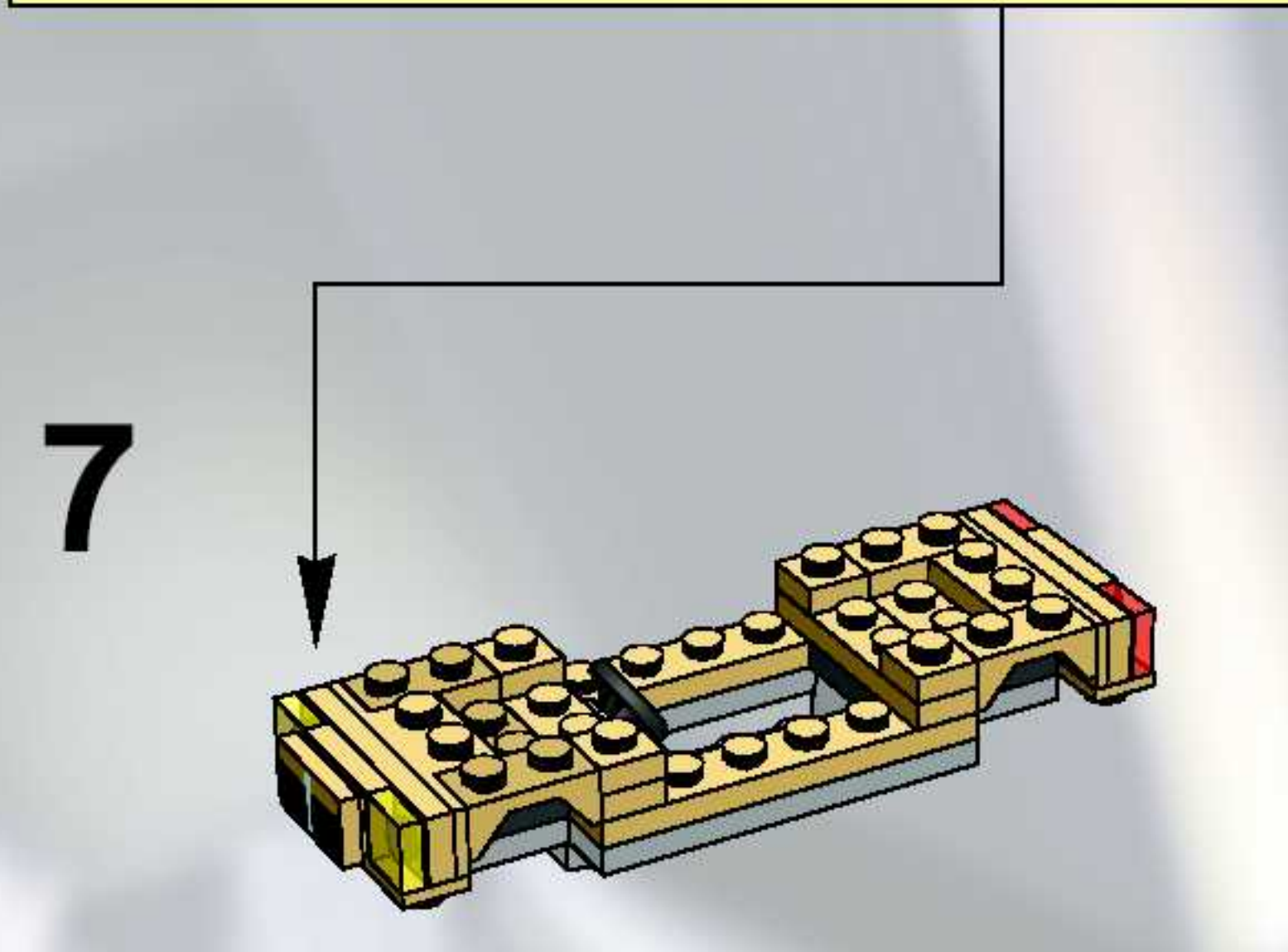
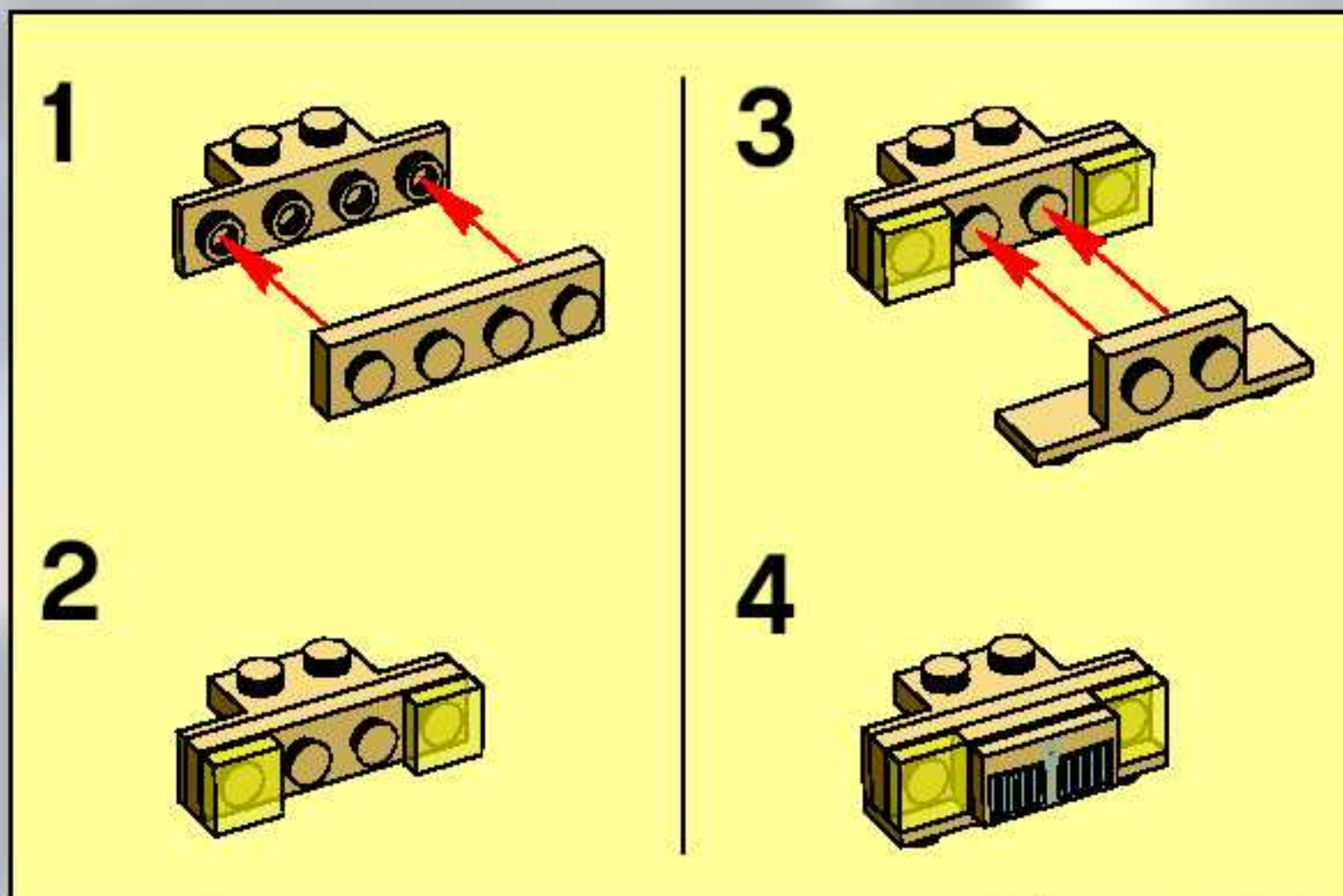

8

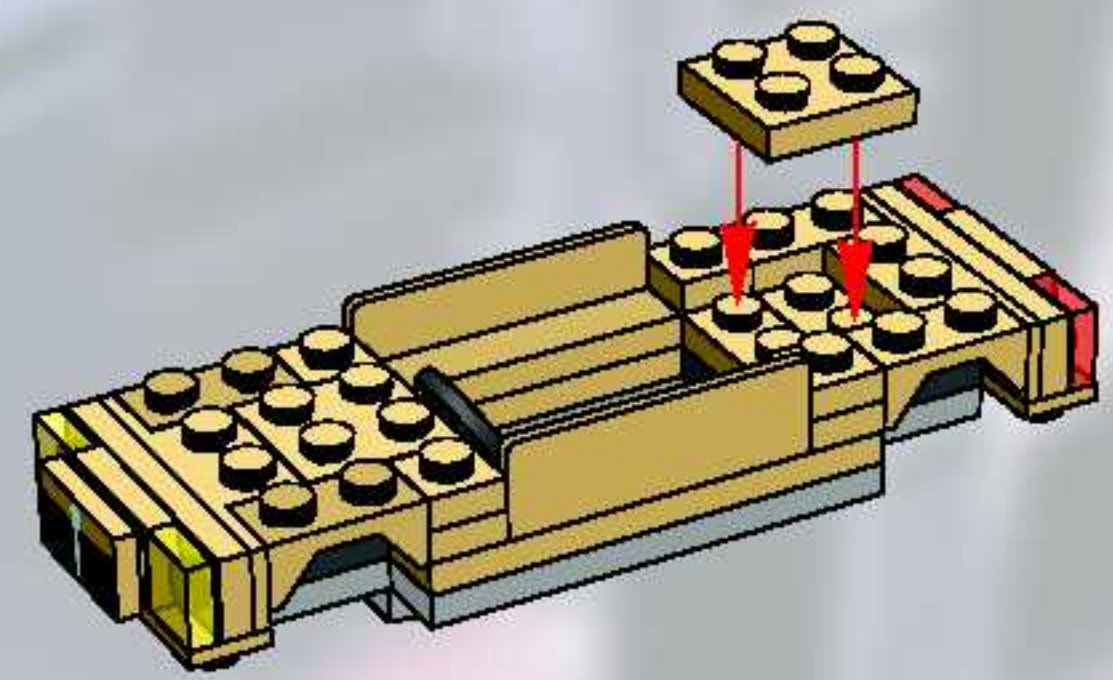

9

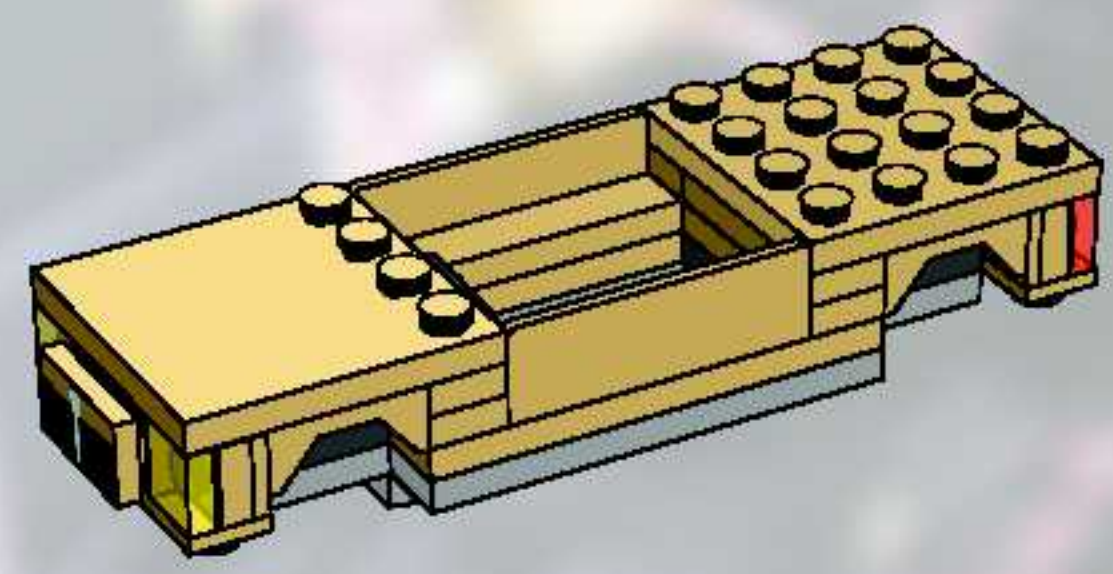

10

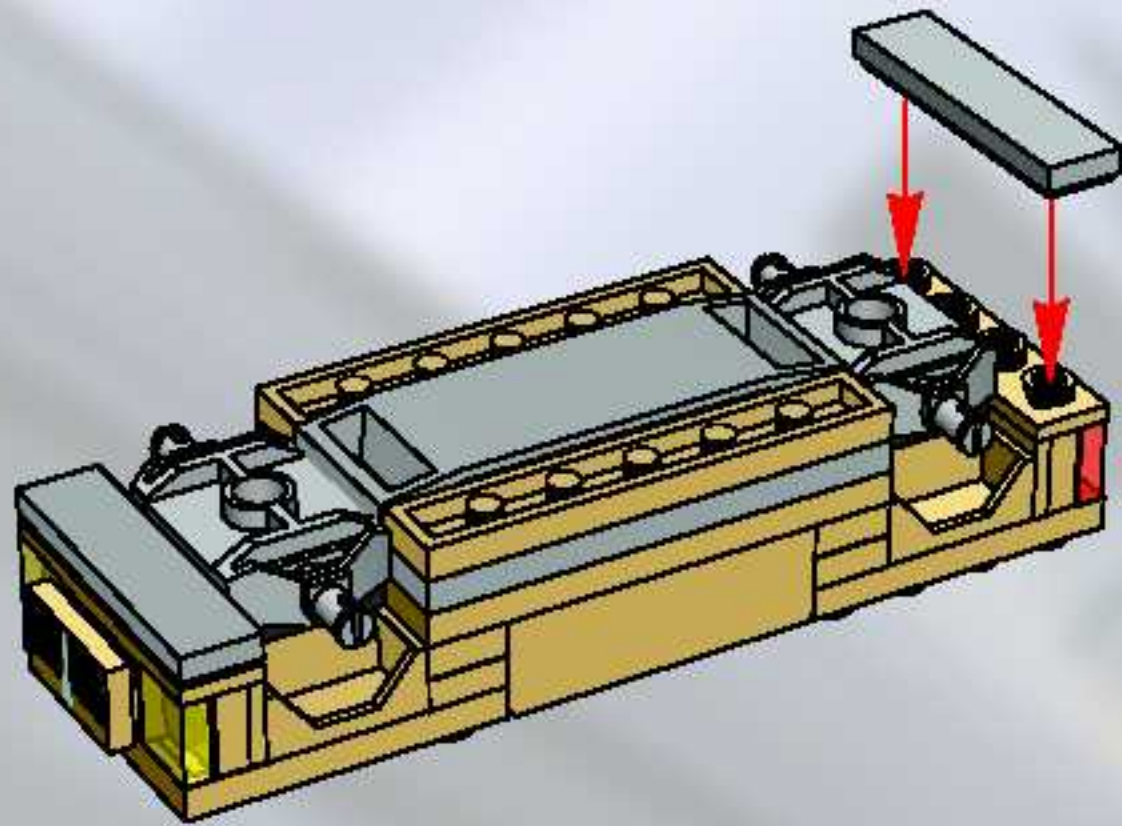

12

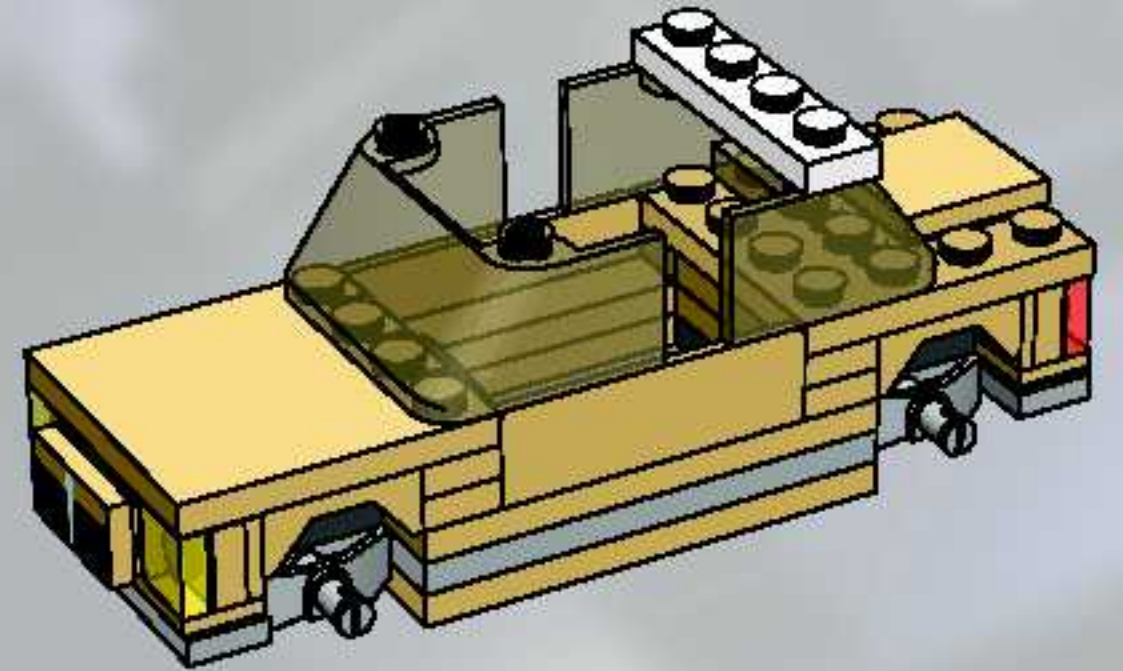

11

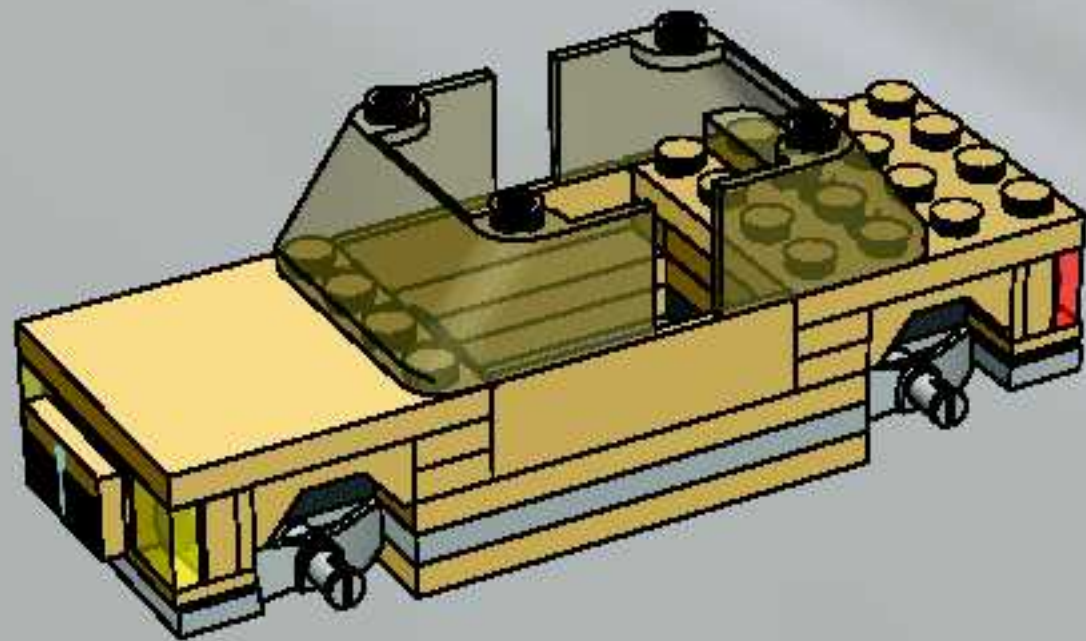

13

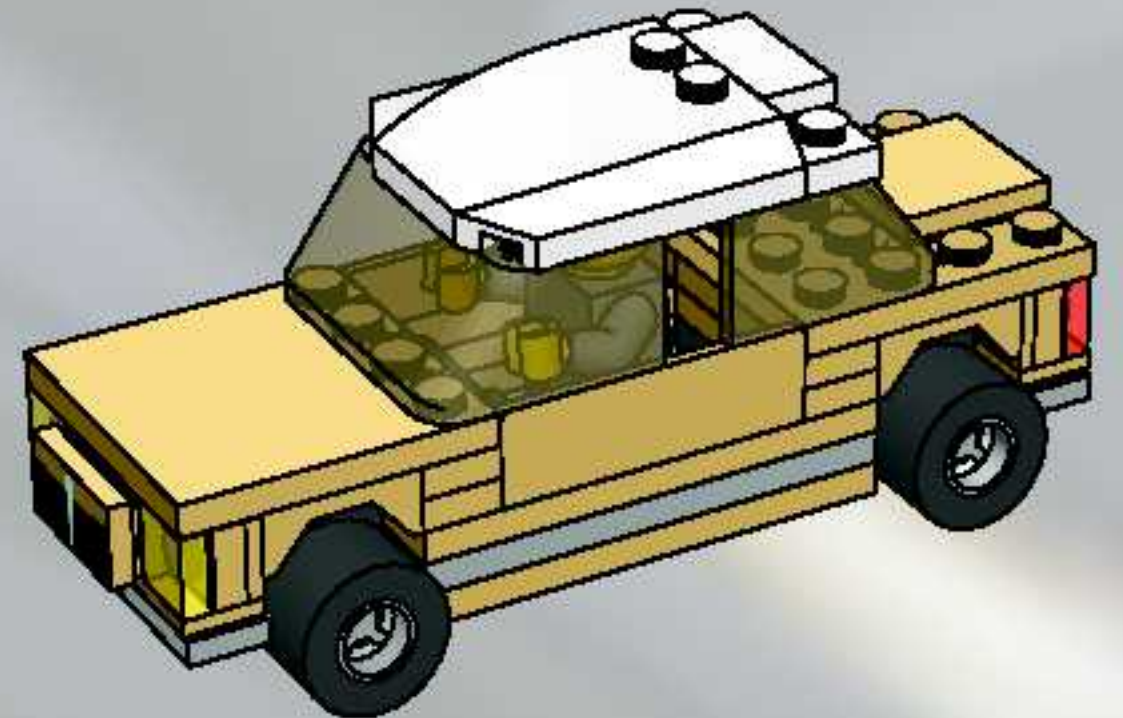

3

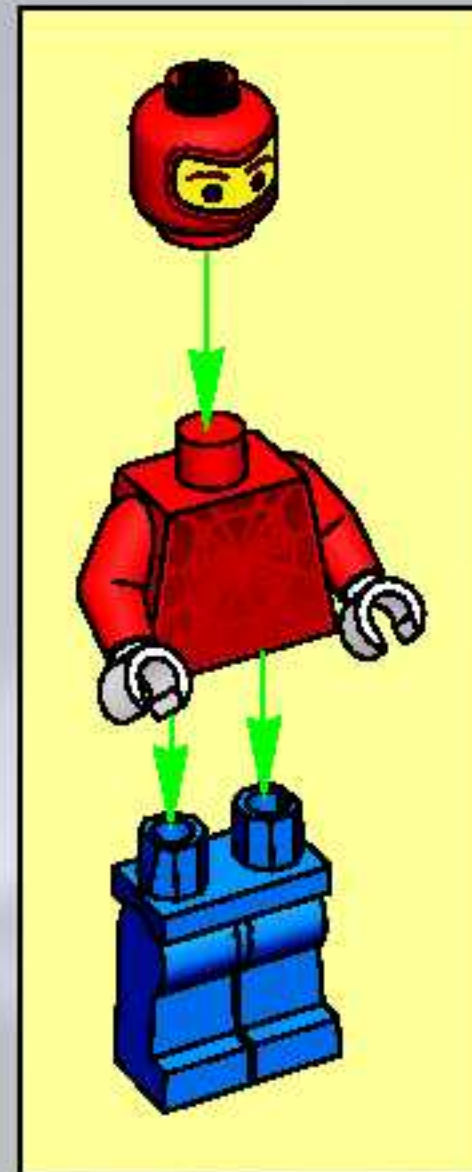
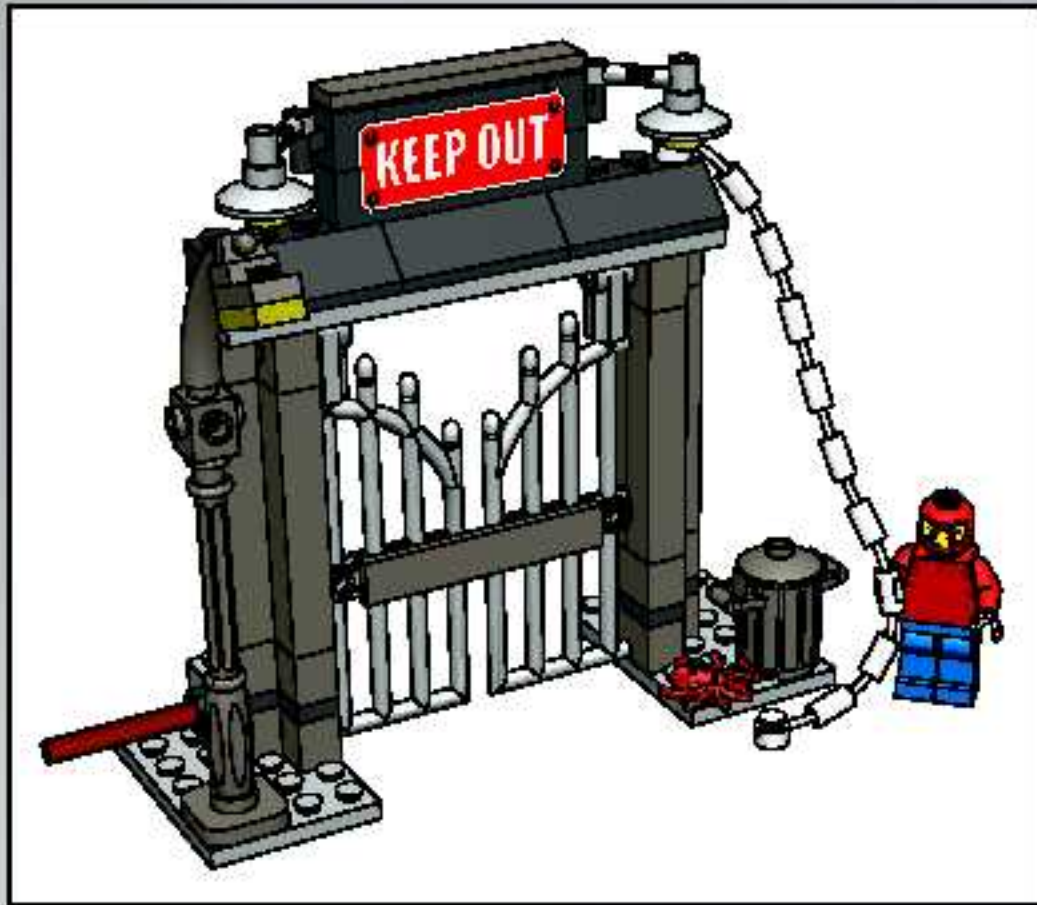

1

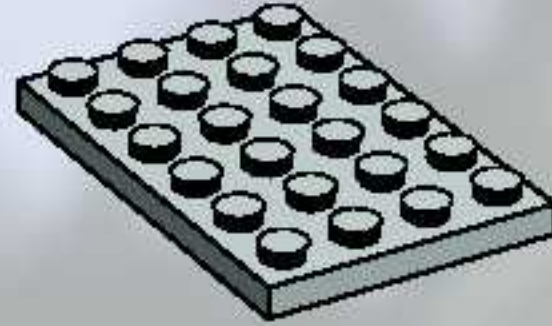
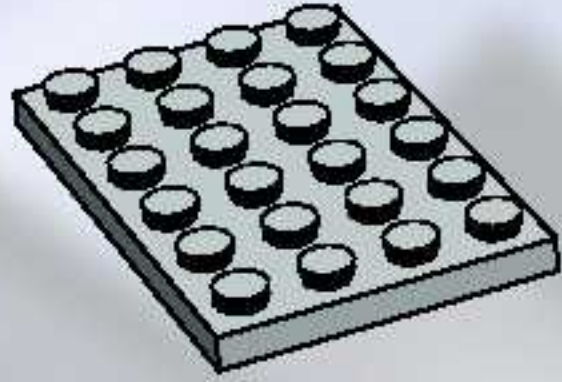

2

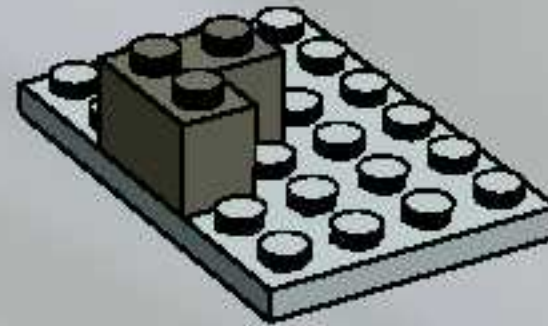
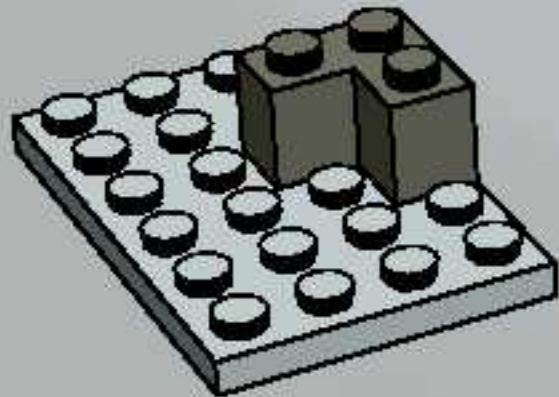

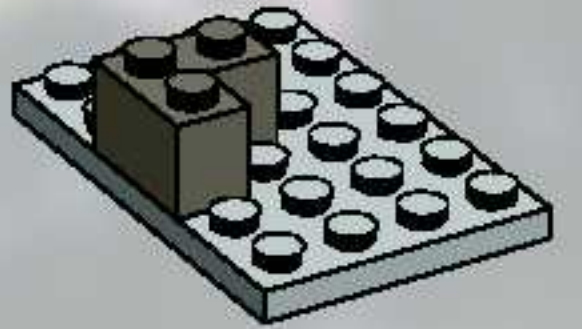
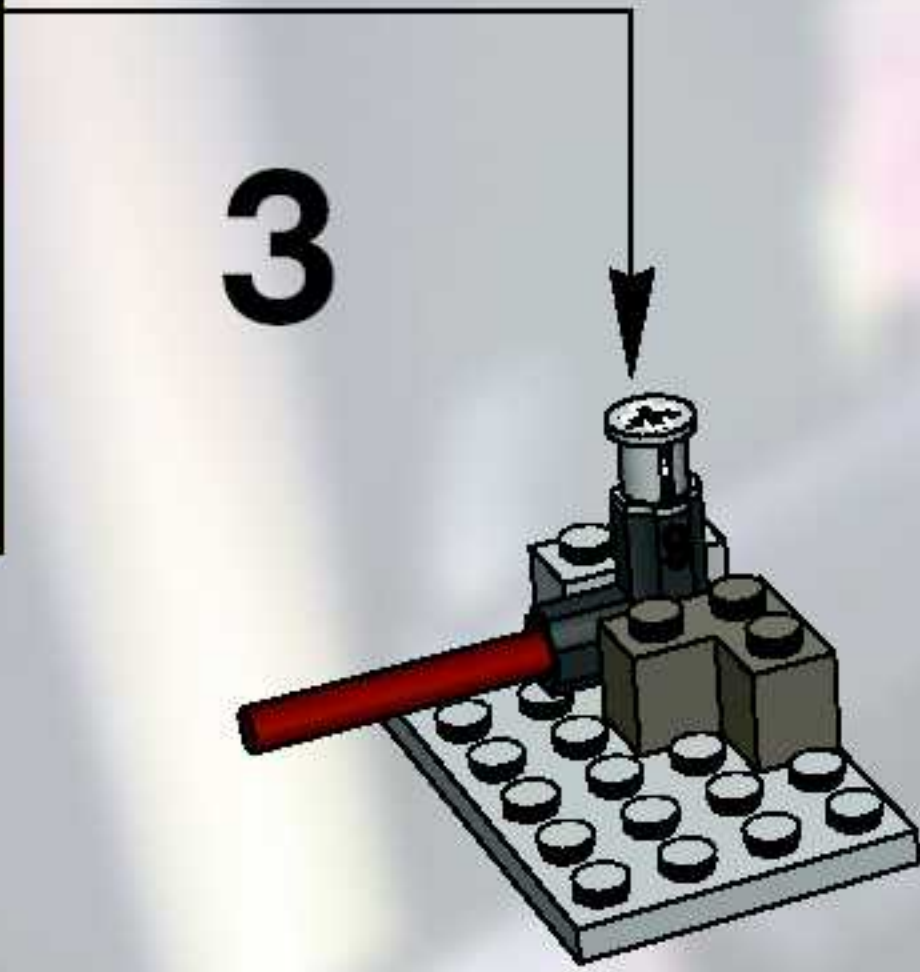
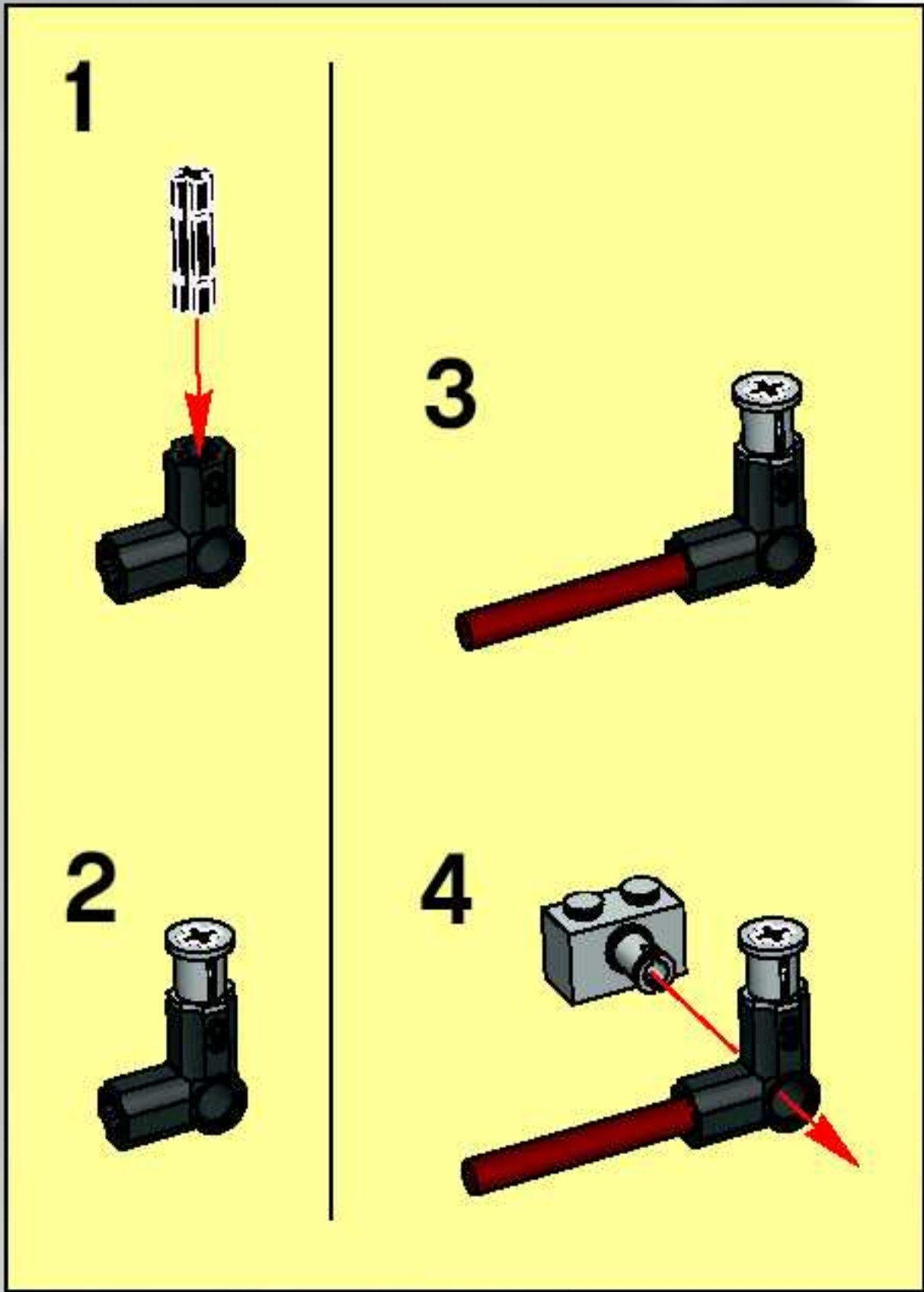

4

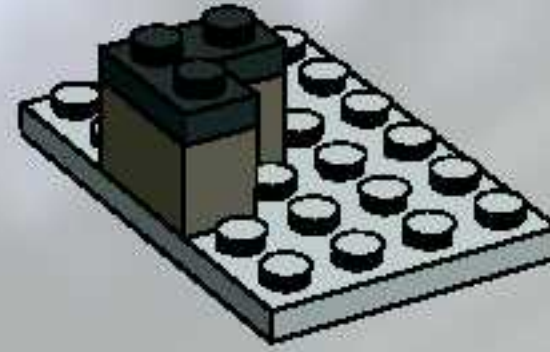
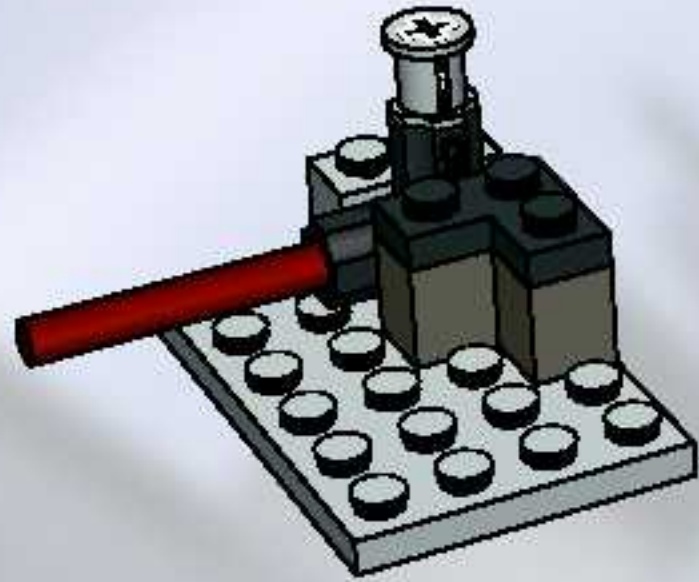

5

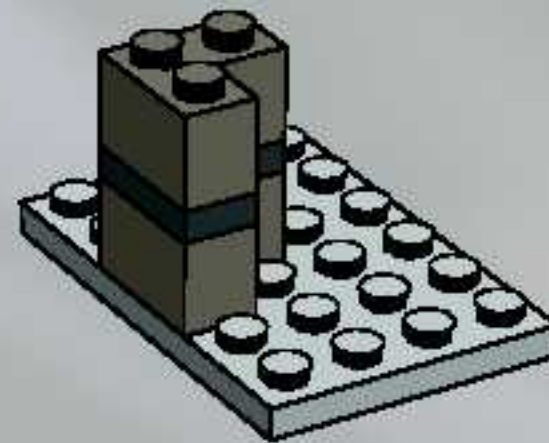
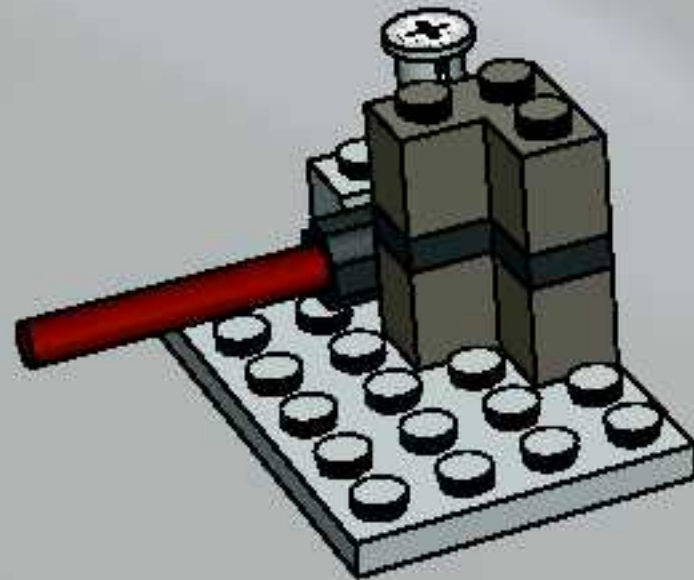

6

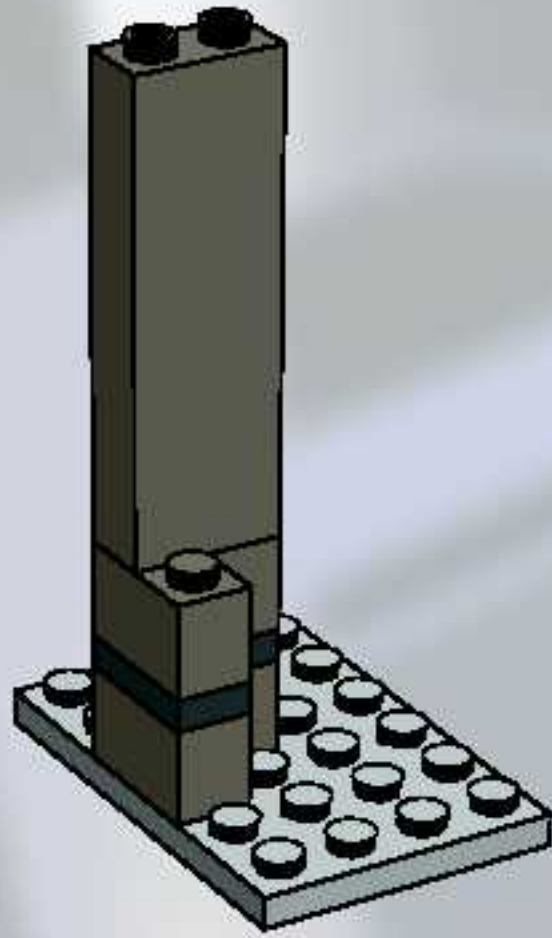
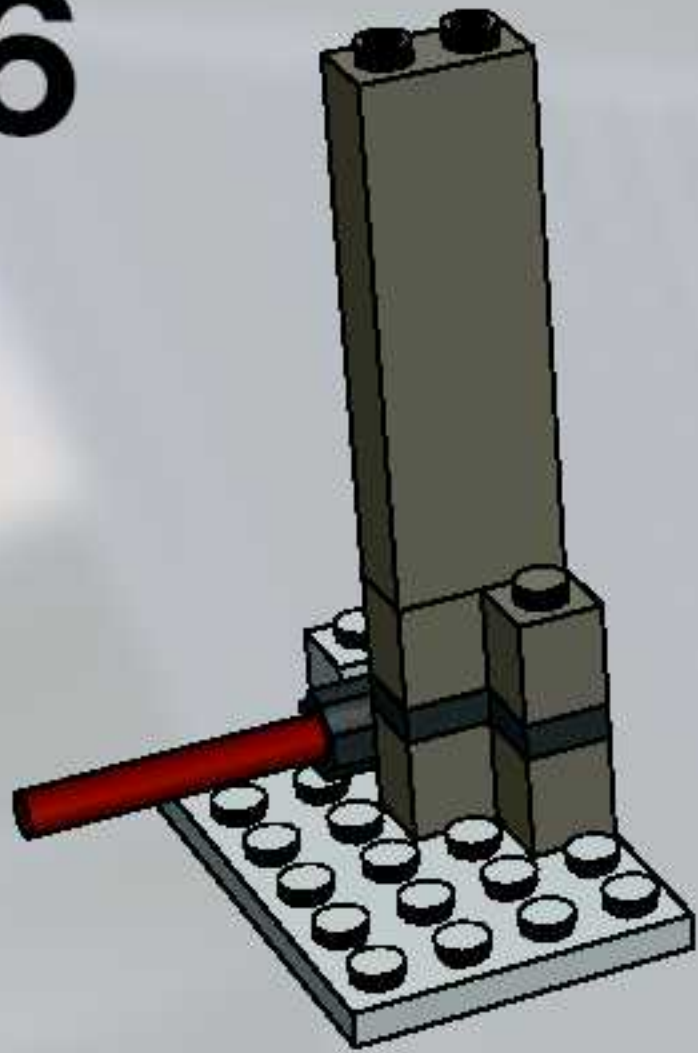

7

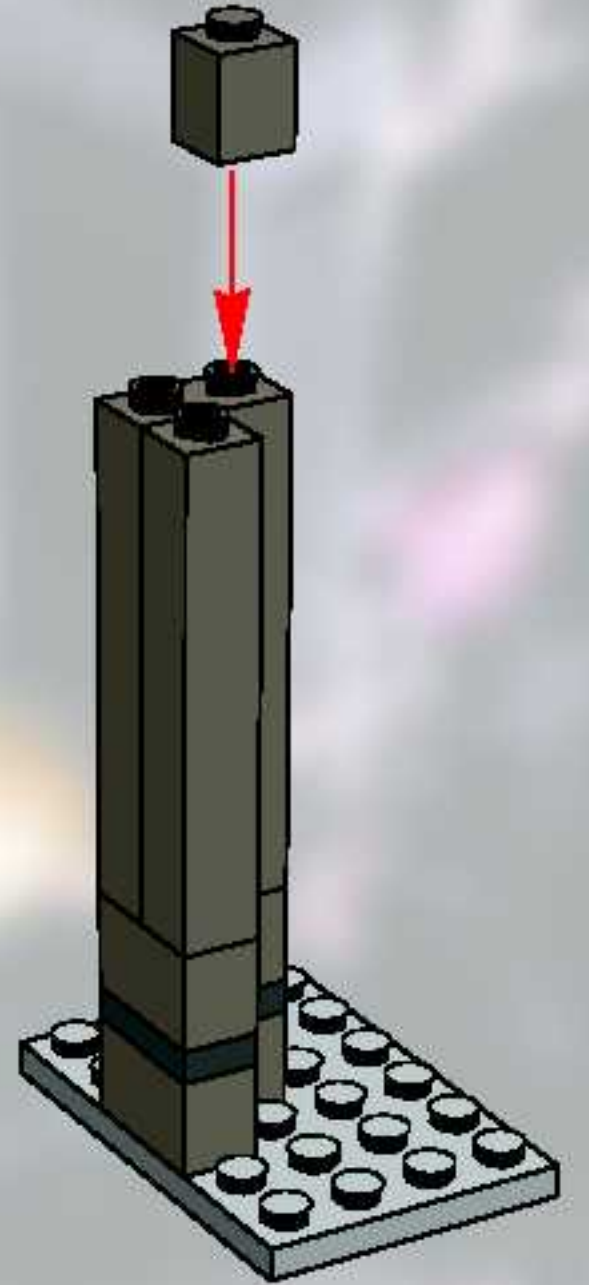
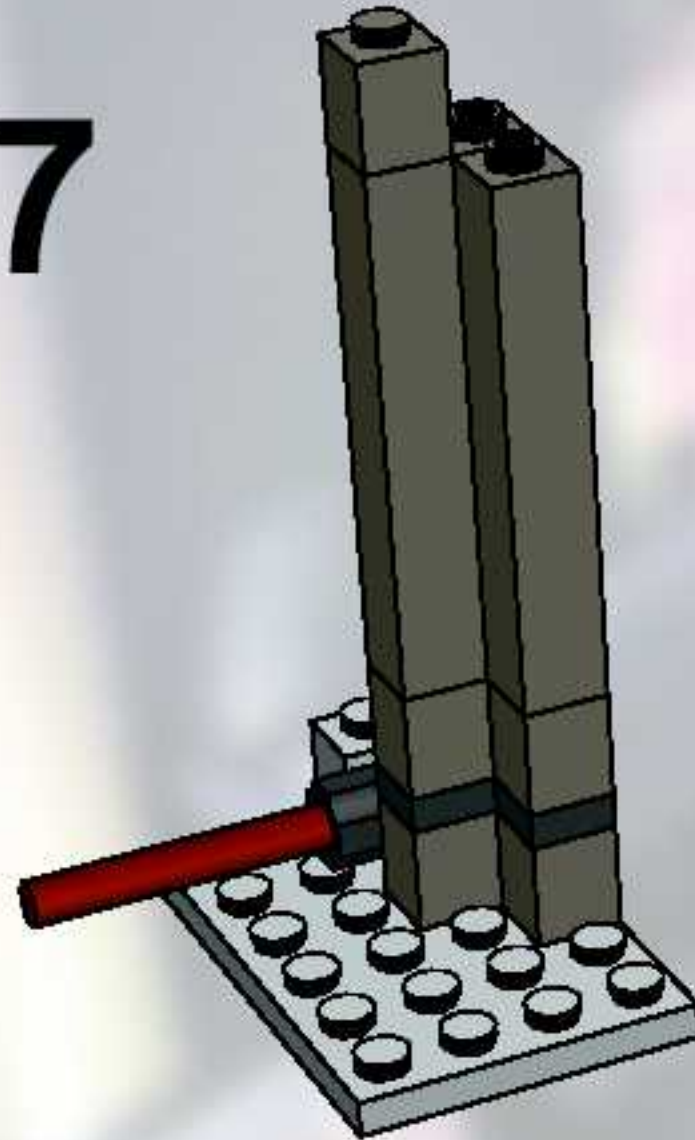

1

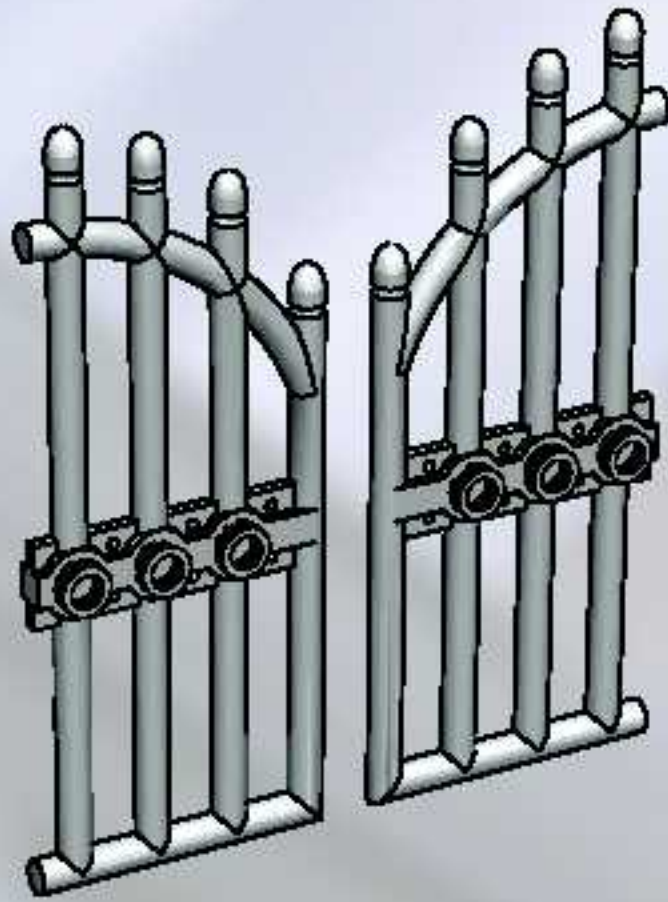

2

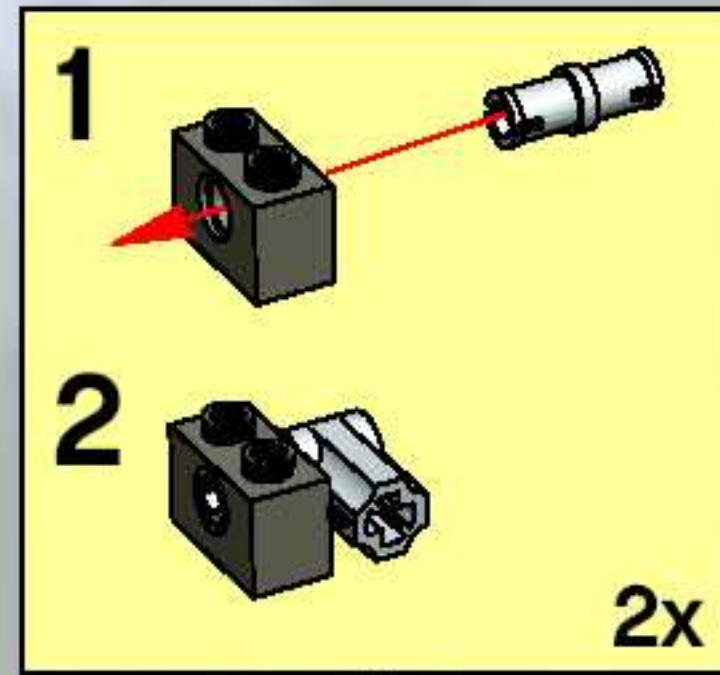
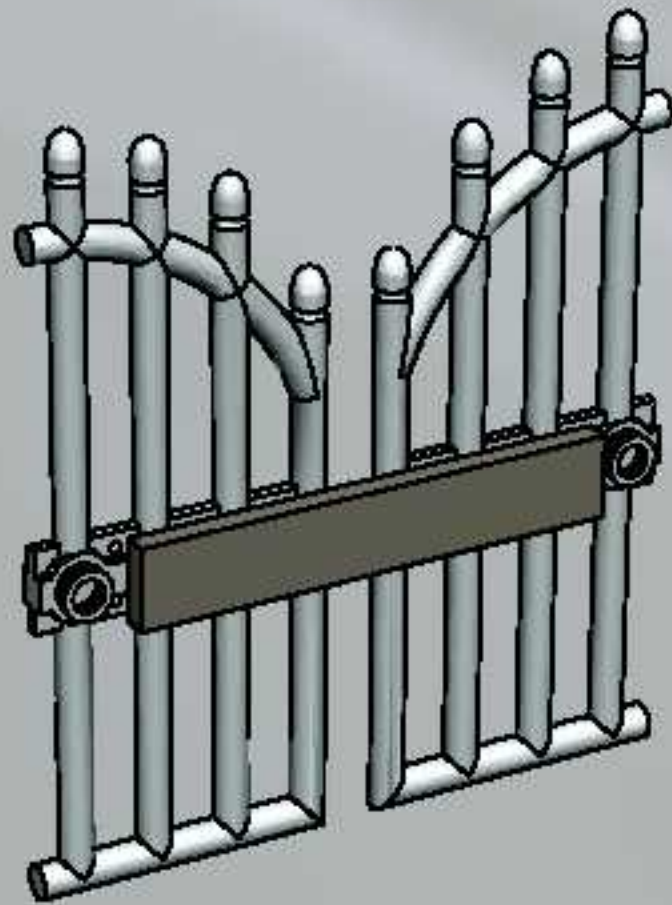

3

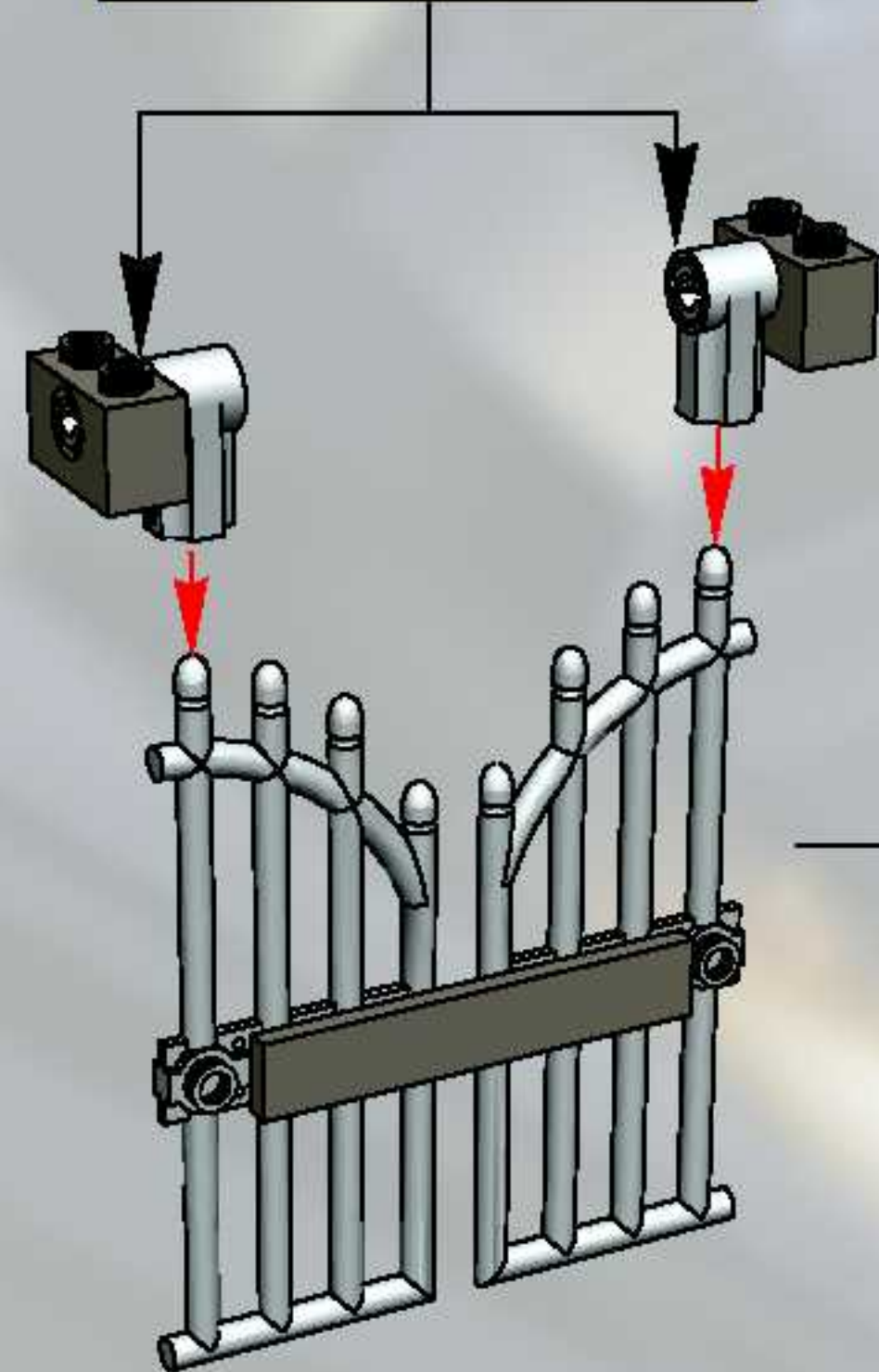

8

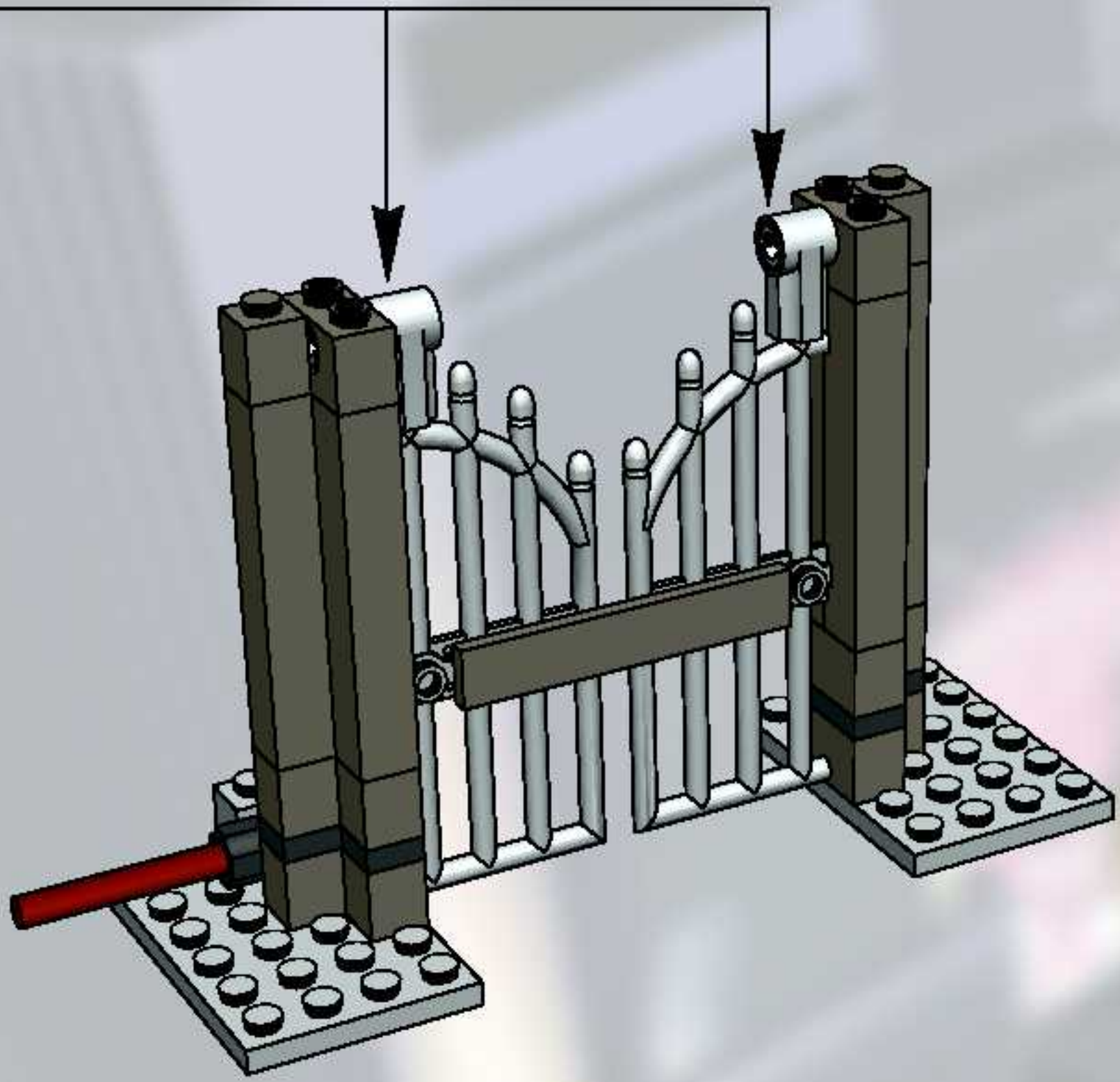

1

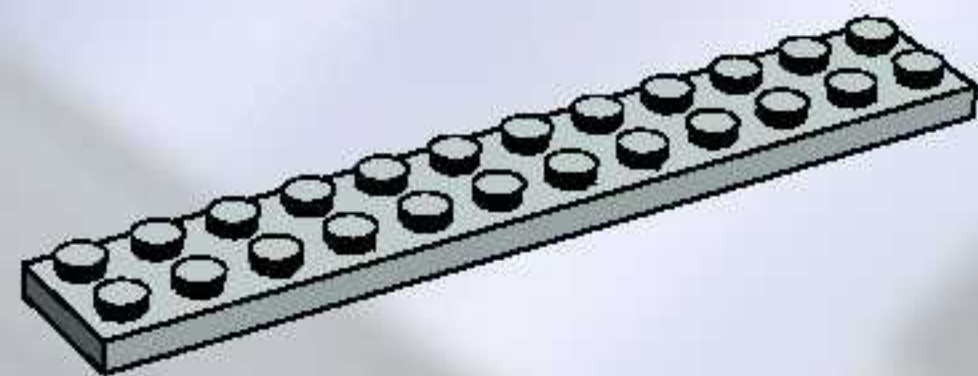

2

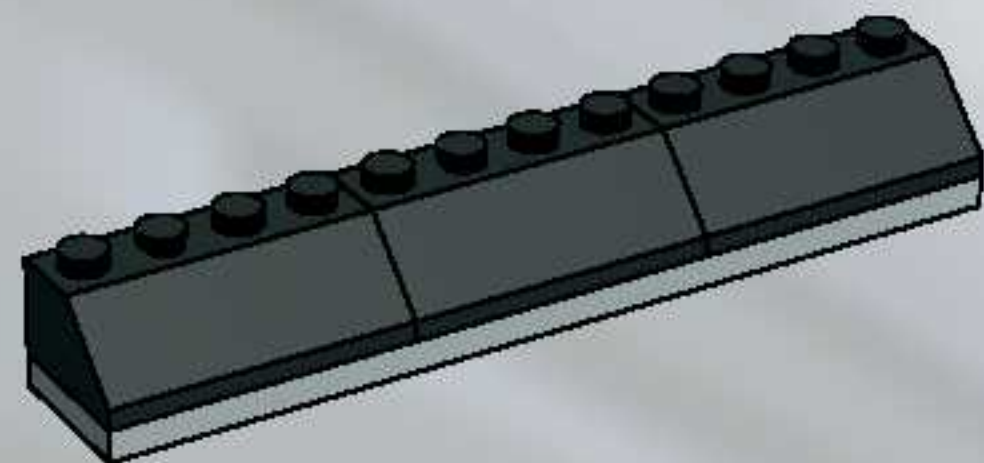

3

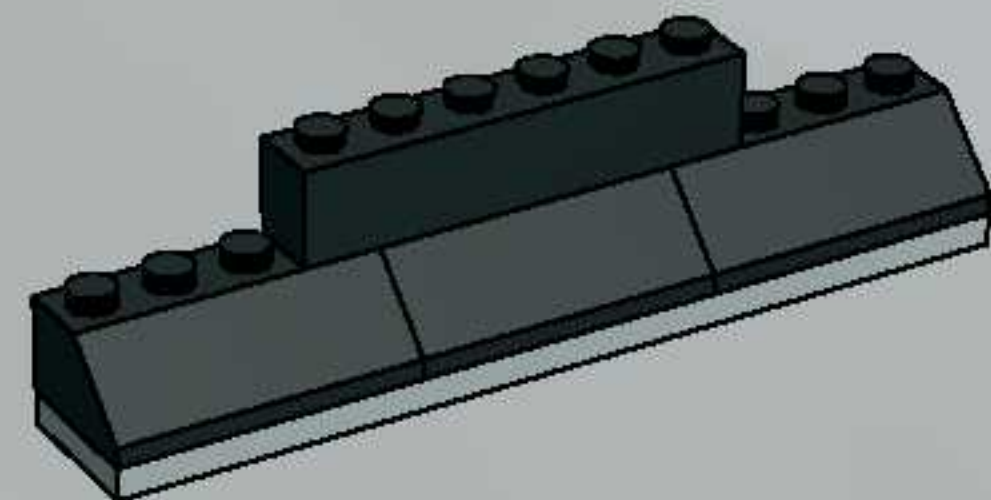

4

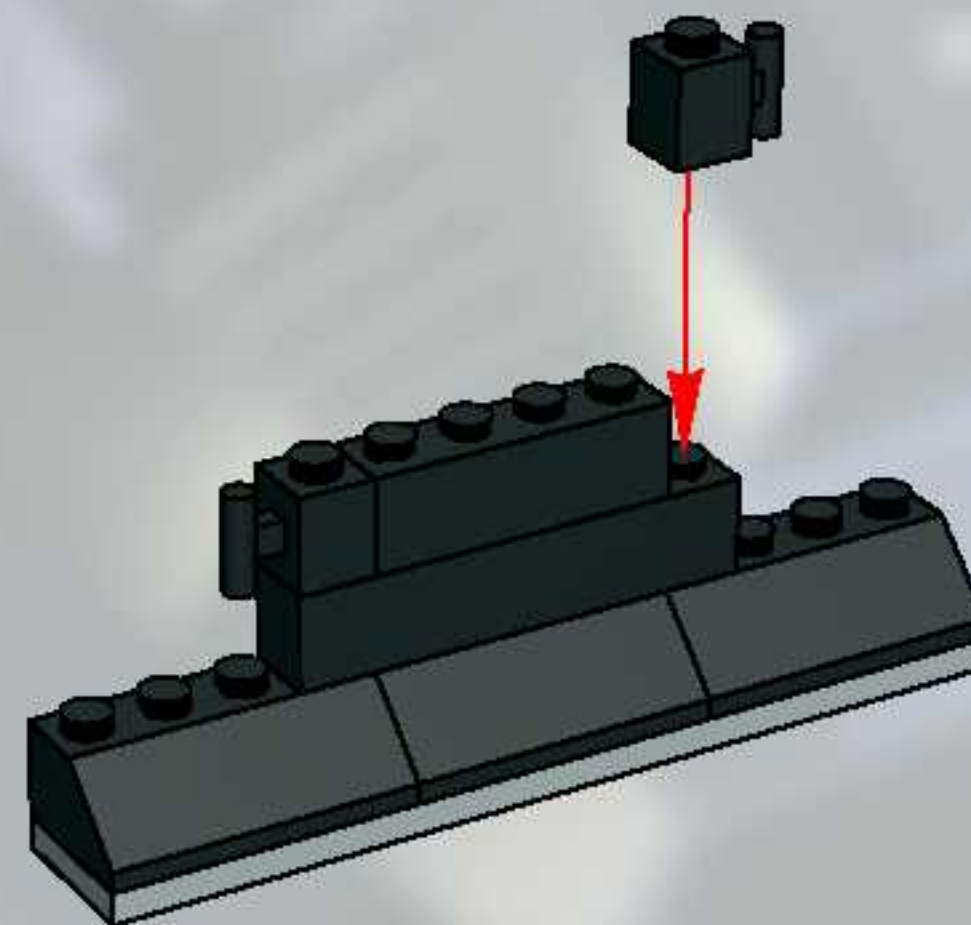

5

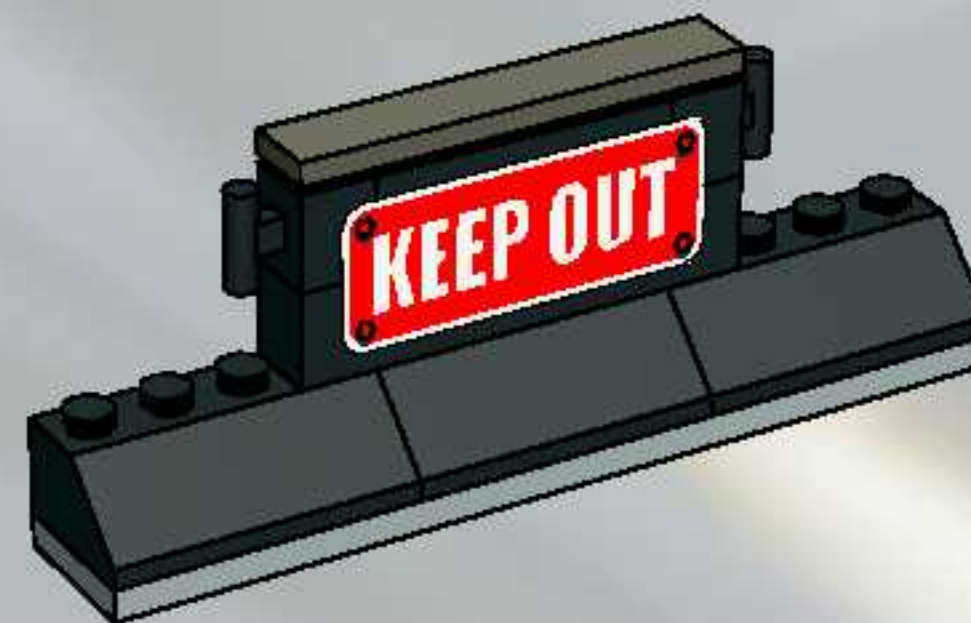

9

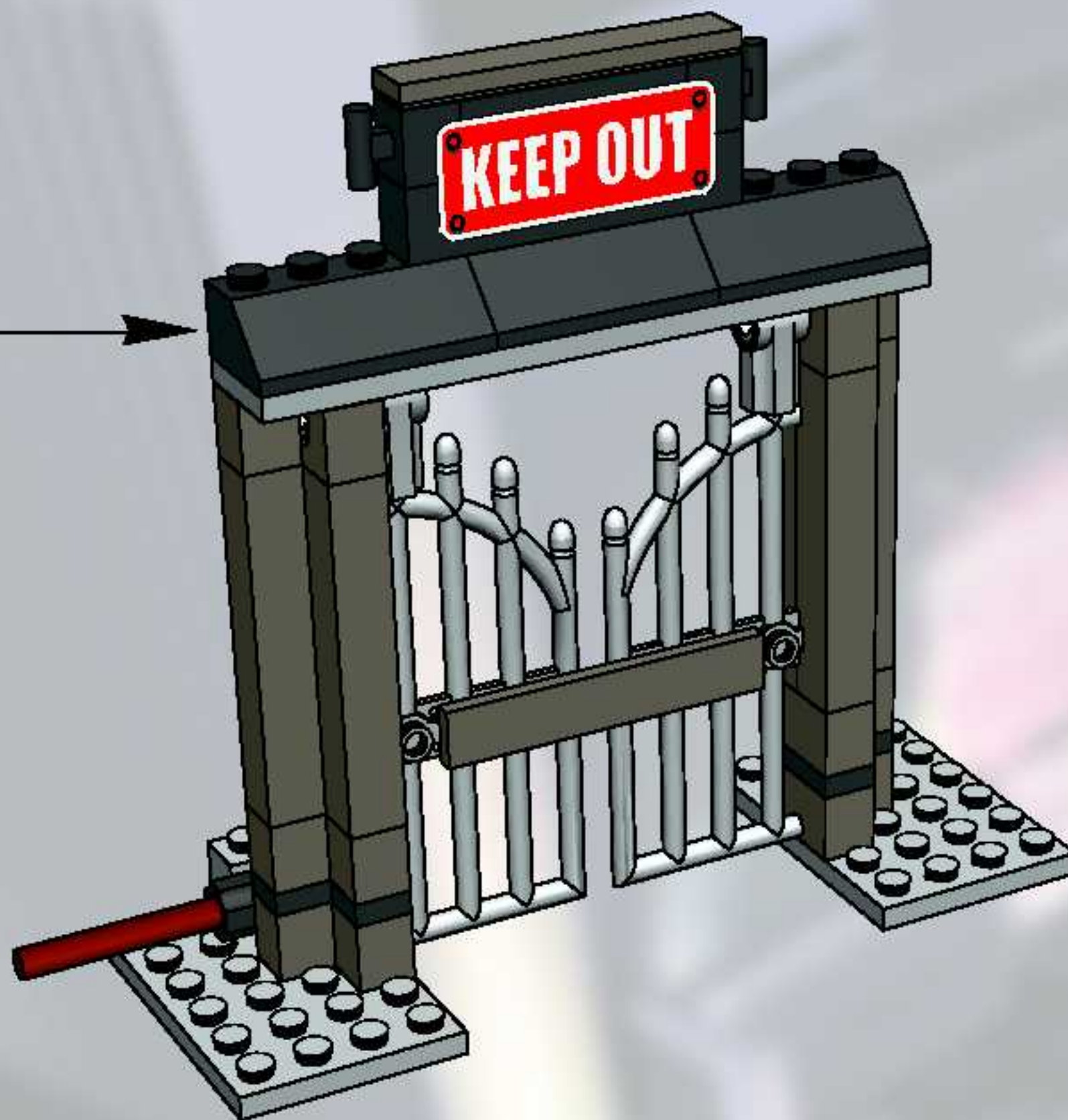

10

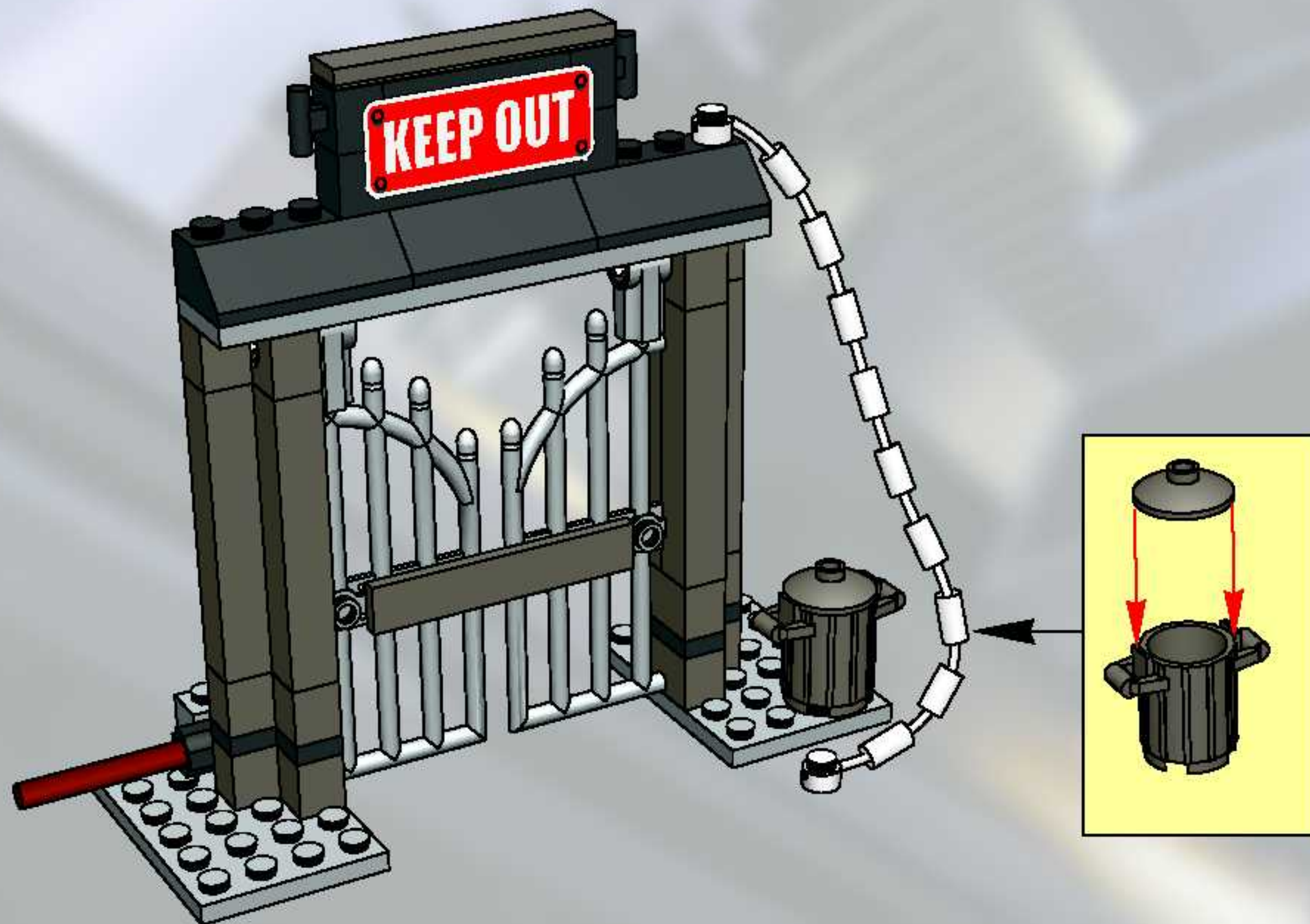

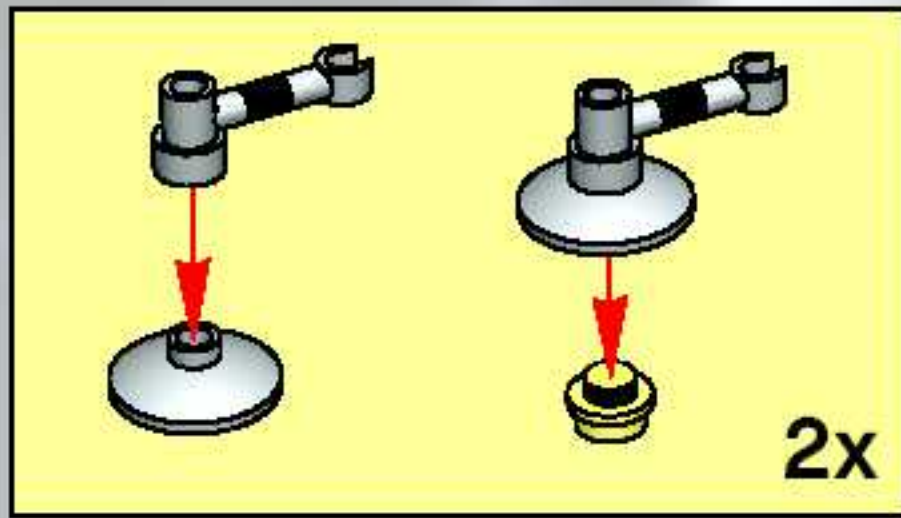

11

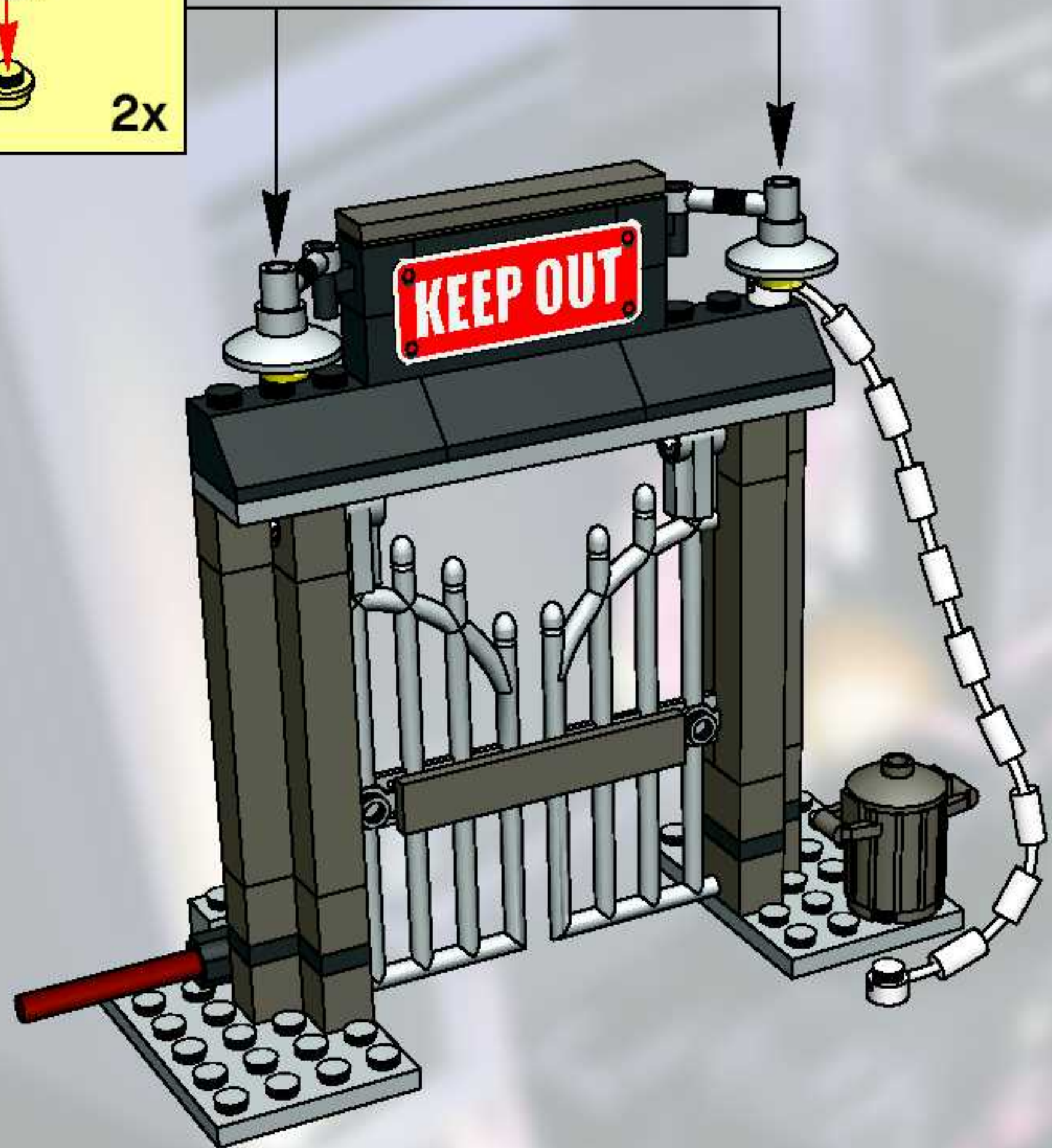

1



1



3



2



4



2

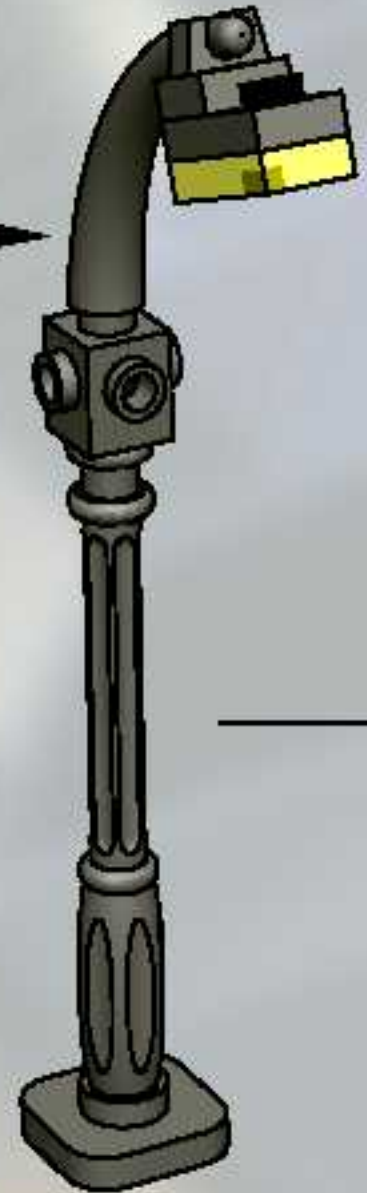

12

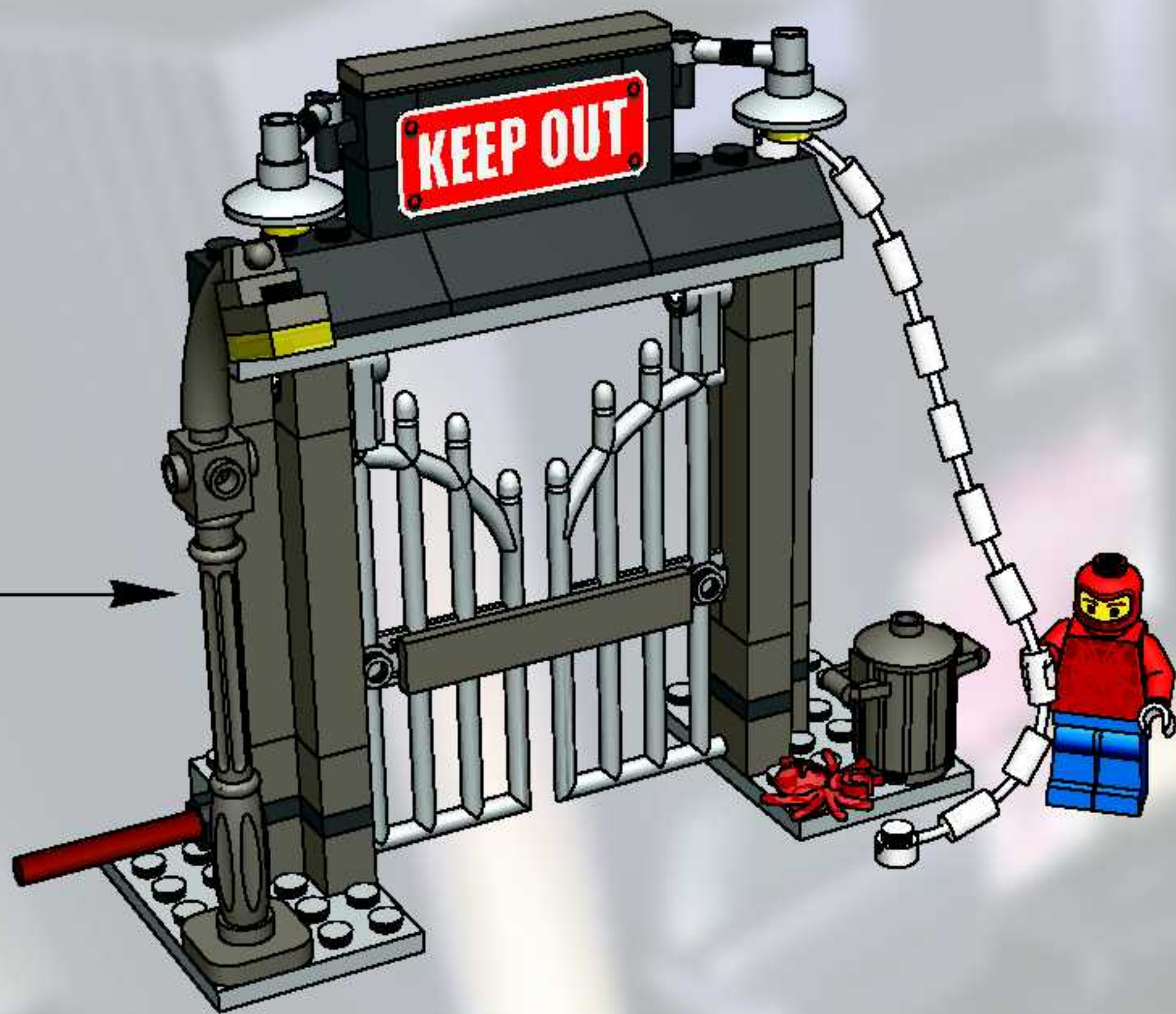

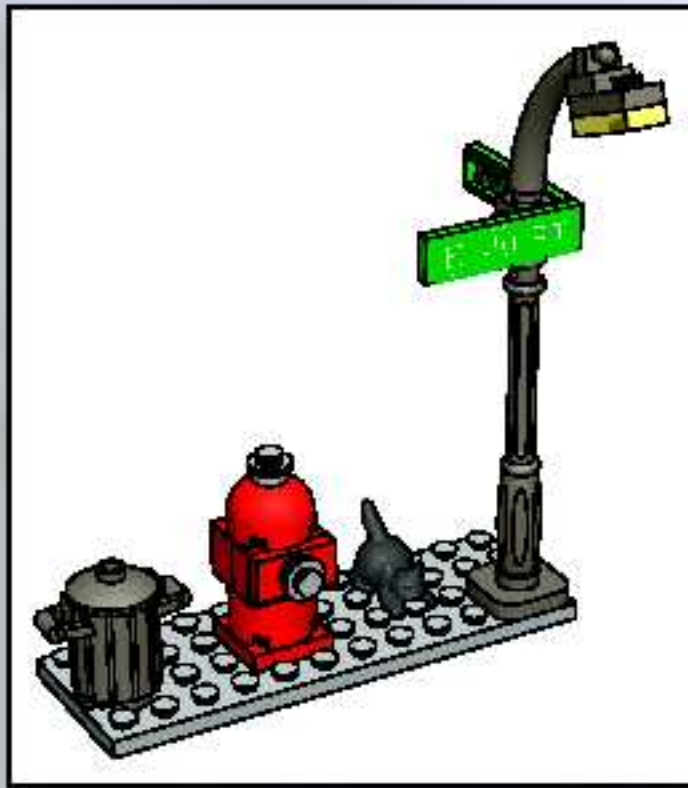

1



2

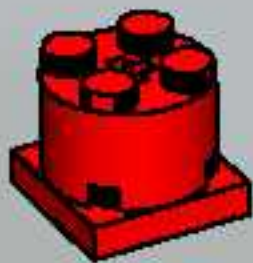

3

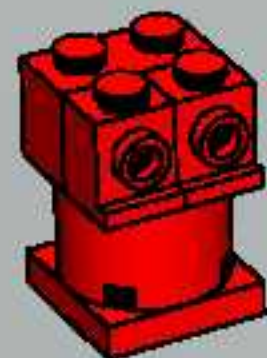

4

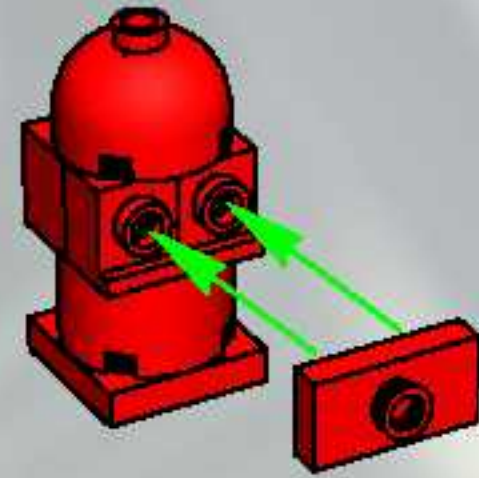

5



6

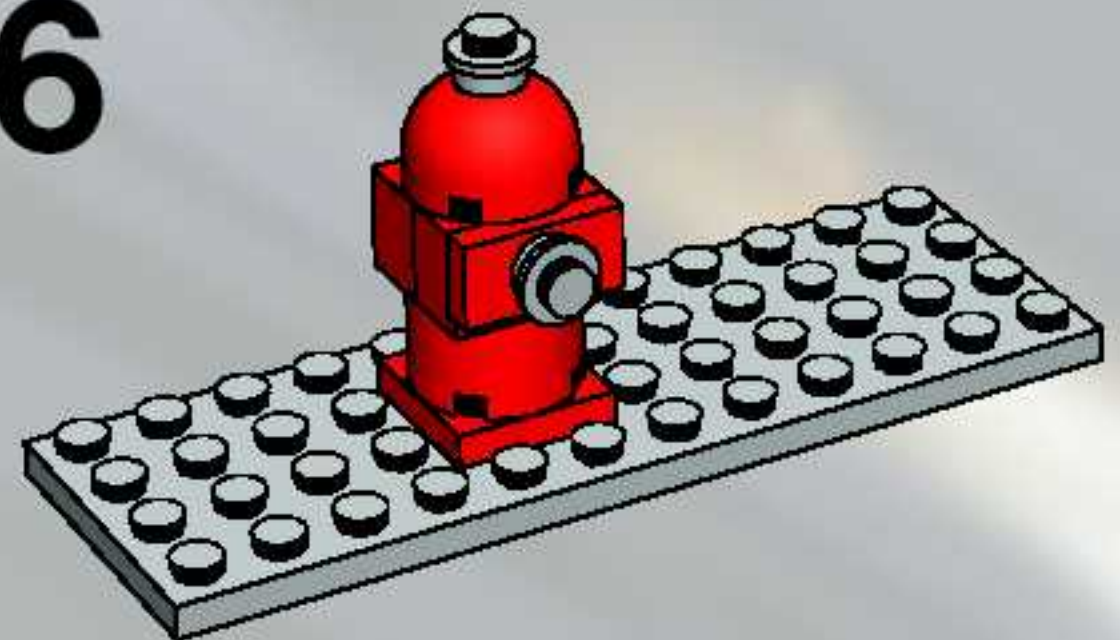

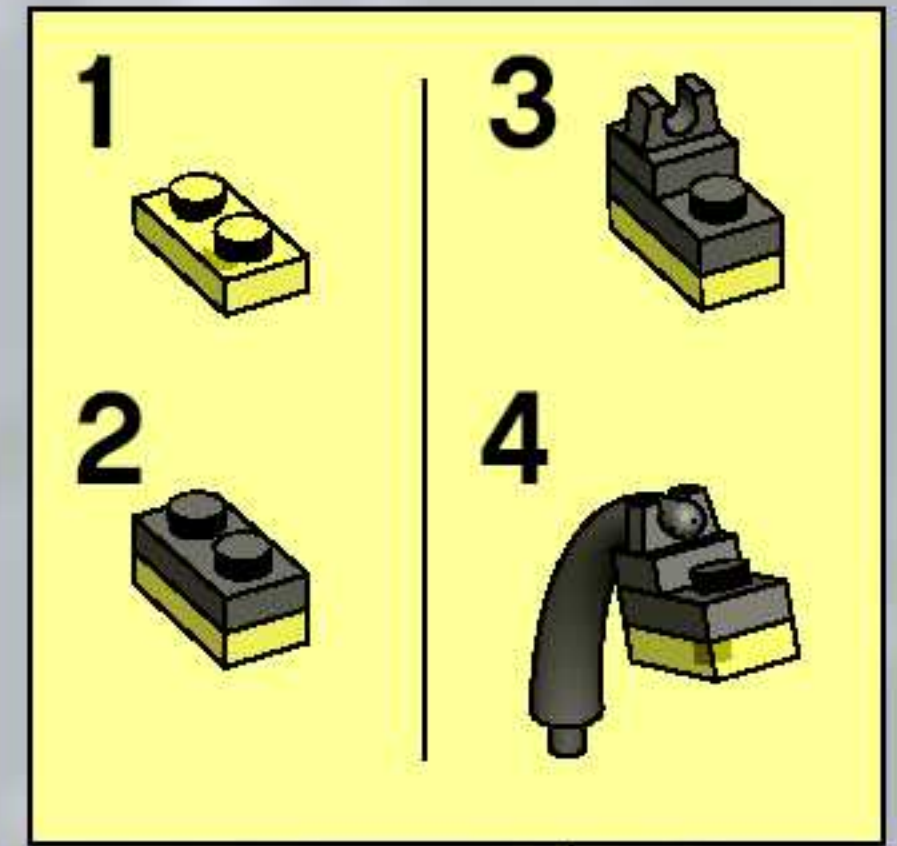
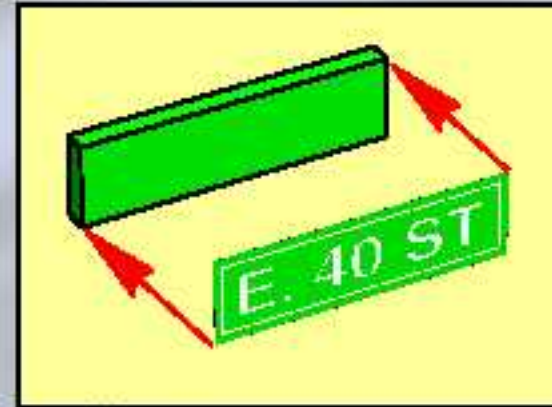
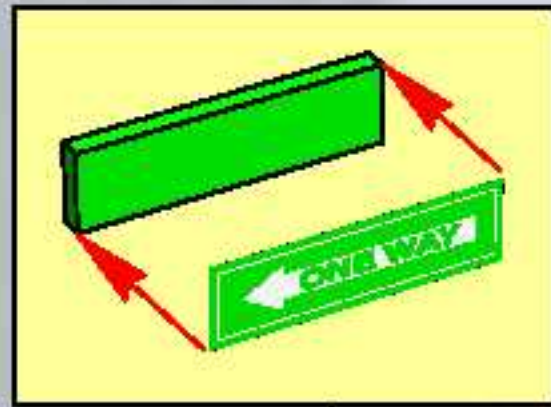

7

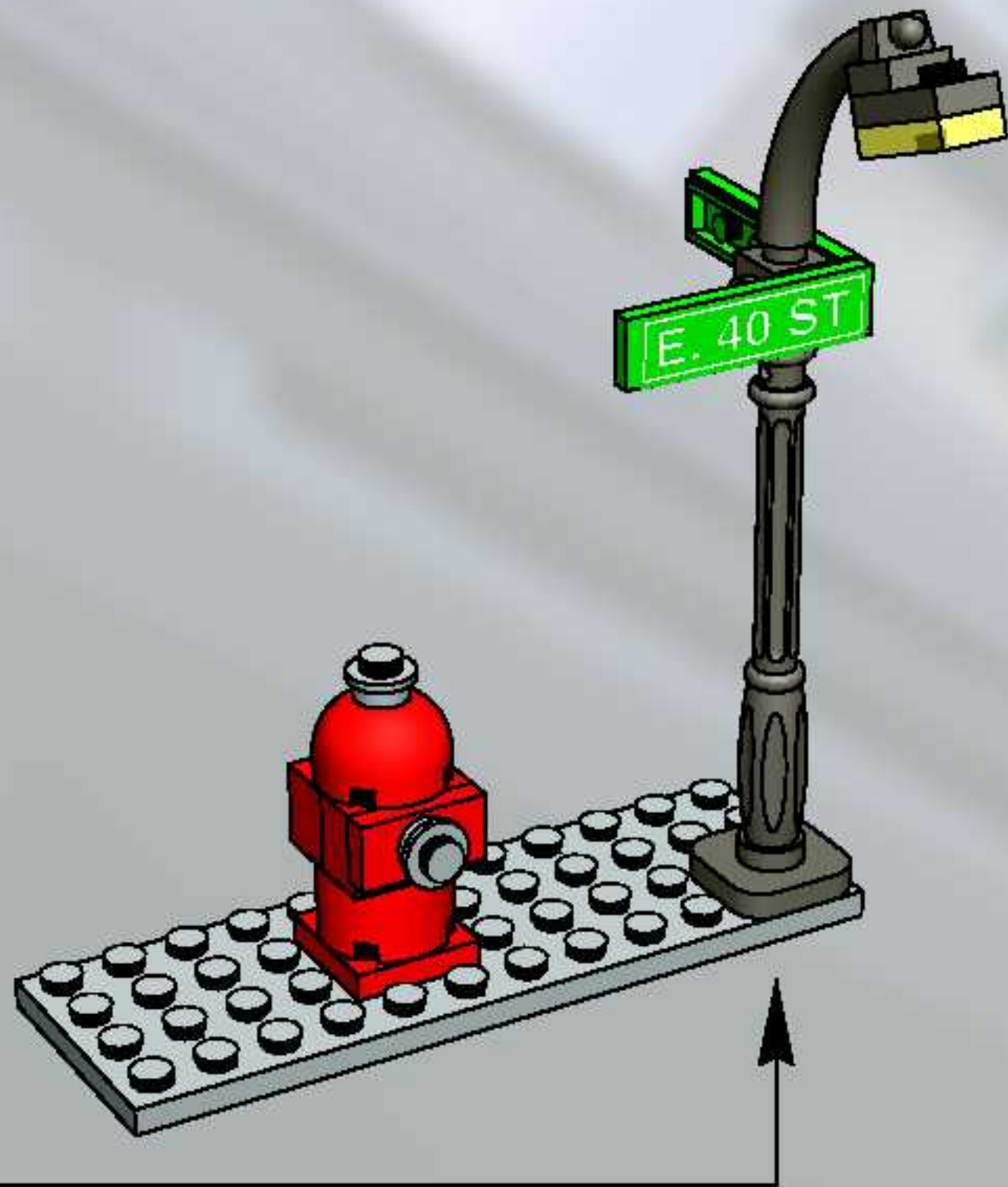

8

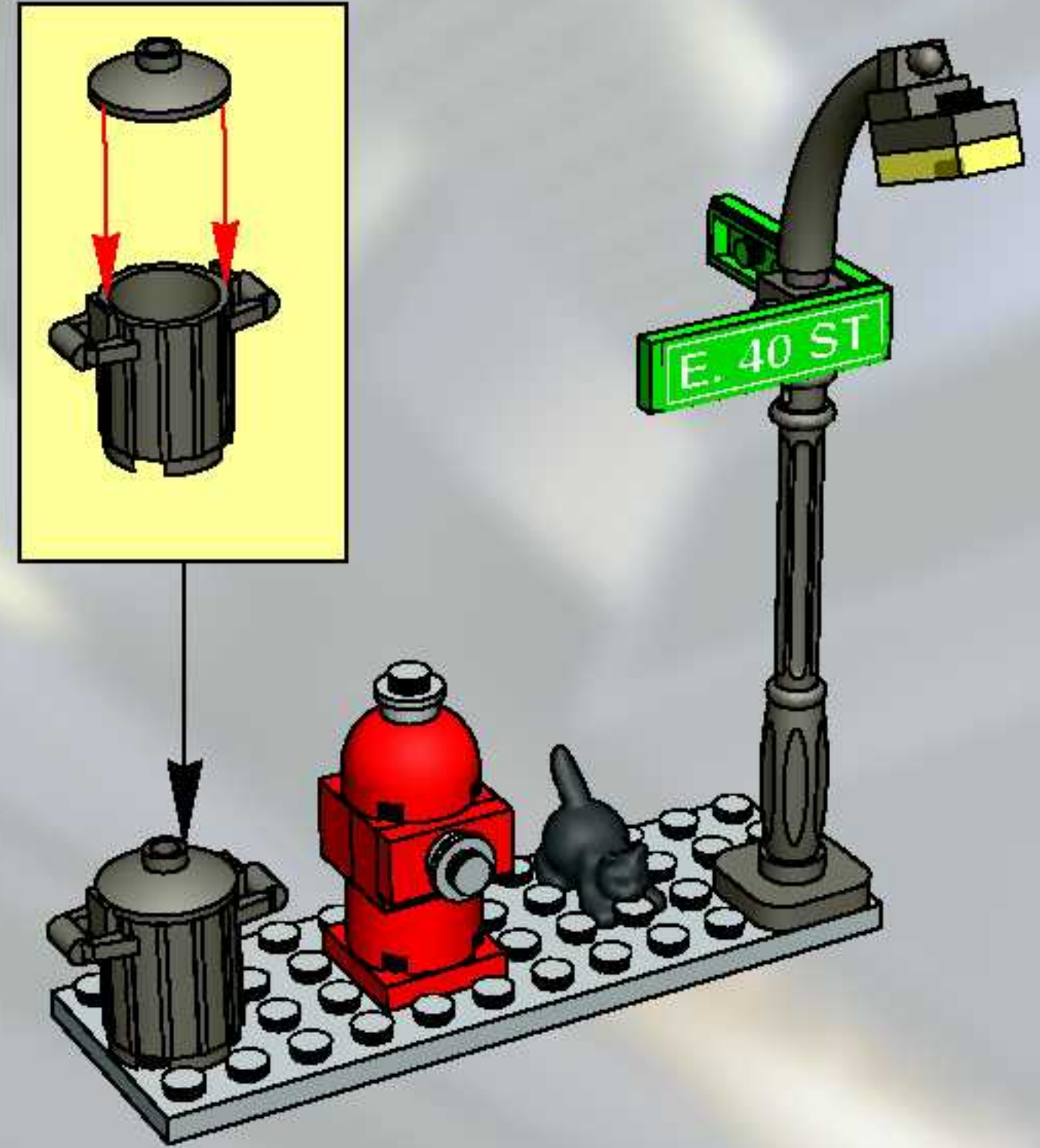

Win! Gagne! Gewinne! 当たります



Win LEGO® products

We would really like to know what you think about your new LEGO® product.

If you could help us by answering a few questions at www.acnielsen.alm.dk/lego then you are in with a chance of winning an exciting LEGO prize.

It will only take you about 3 minutes!



Estimado usuario LEGO®

Al contestar algunas preguntas en inglés, francés, alemán o japonés, en el sitio www.acnielsen.alm.dk/lego, podrás participar en el sorteo de algunas valiosas premios LEGO®.



Gagne des produits LEGO®

Nous aimerions beaucoup savoir ce que tu penses de ton nouveau produit LEGO®.

Si tu veux bien nous aider en répondant à quelques questions sur www.acnielsen.alm.dk/lego, tu recevras peut-être bientôt l'un des nombreux super-prix offerts par LEGO aux participants.

Et cela ne te prendra que 3 minutes environ !



Kedves ÚJ LEGO® Vásárló

Ha ellátogatasz a www.acnielsen.alm.dk/lego honlapra és ott angol, francia, német vagy japán nyelven megválaszolasz néhány kérdést, akkor részt vehetsz egy versenyben, amelyben értékes LEGO® díjakat nyerhetsz.



Gewinne LEGO® Produkte

Wir sind sehr an deiner Meinung über dein neues LEGO® Produkt interessiert.

Wenn du uns den Gefallen tust und unter www.acnielsen.alm.dk/lego Fragen beantwortest, kannst du einen tollen LEGO Preis gewinnen.

Das Ganze dauert nur etwa 3 Minuten!



Caro Consumidor da LEGO®

Ao responder a algumas perguntas em Inglês, Francês, Alemão ou Japonês no endereço www.acnielsen.alm.dk/lego irá participar num concurso para ganhar valiosos prémios da LEGO®.



抽選でレゴ製品が当たります

私たちは、皆さんがレゴ製品についてどんな感想をお持ちか、是非知りたいと思っています。

www.acnielsen.alm.dk/legoにアクセスいただき、質問にご回答いただくと、抽選で素晴らしいレゴ製品が当たります。

アンケートのご回答には、ほんの3分ほどしかかかりません!

22560

4852



LEGO
8-12
4852



LEGO
7-12
4851

4851



LEGO
6-12
1374

1374



LEGO, the LEGO logo and the Minifigure are trademarks of/son des marques de commerce de/son marcas registradas de LEGO Group. ©2002, 2003 The LEGO Group.

Spider-Man, the movie/the film/la película: ©2003 Columbia Pictures Industries Inc. Spider-Man, the character/le personnage/el personaje. TM & ©2003 Marvel Characters, Inc. All Rights Reserved/Tout droits réservés/Todos los derechos reservados.



GO FOR THE LA TENTE SOSTI
WWW.COPY.COM/SPIDER-1189

www.LEGO.com