

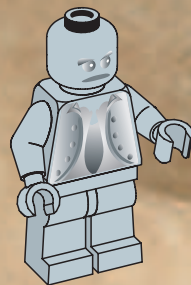

Harry Potter™

4705

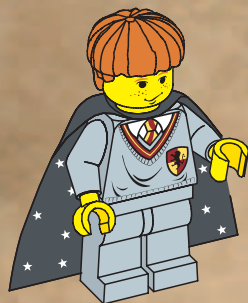

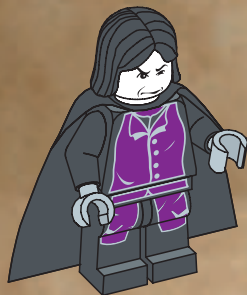
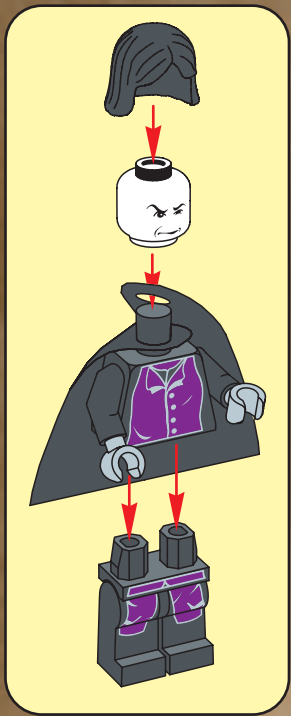

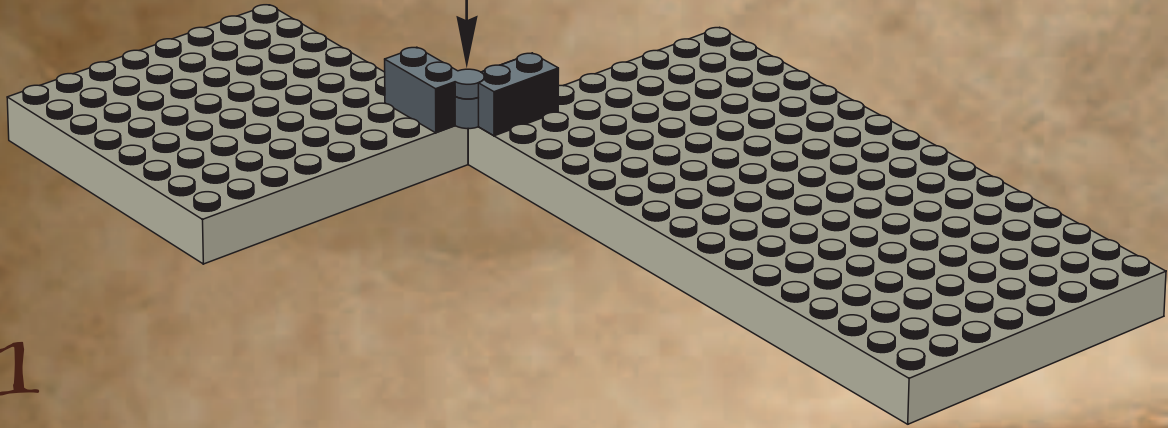
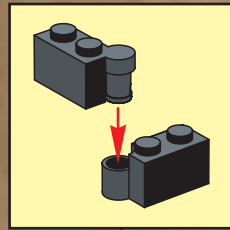

1





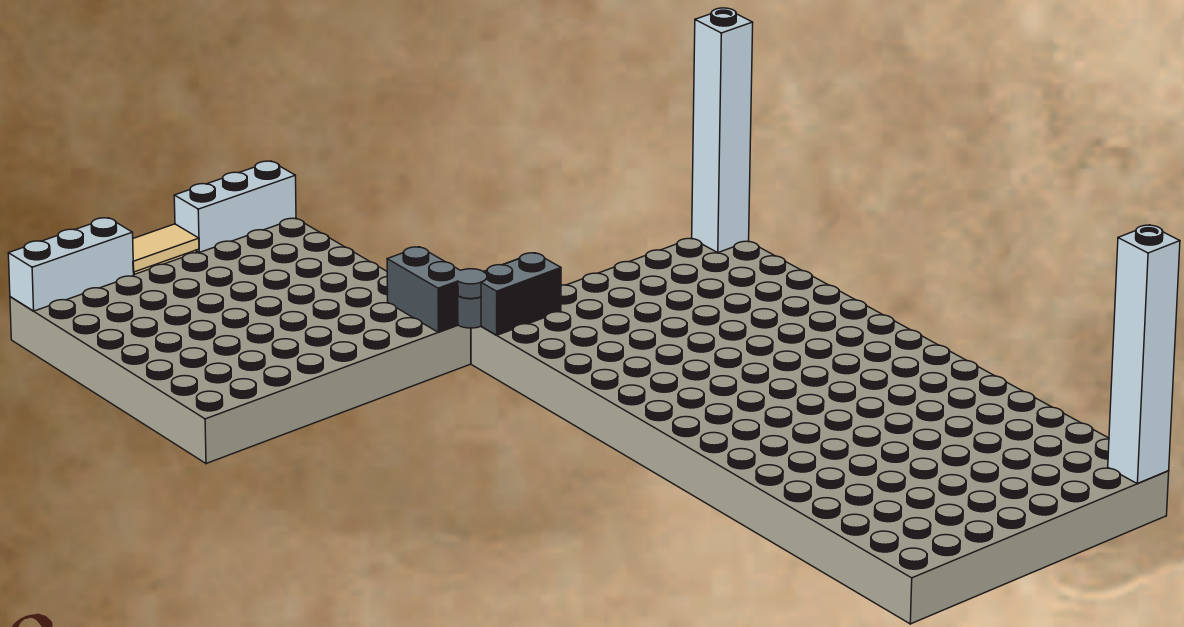

2

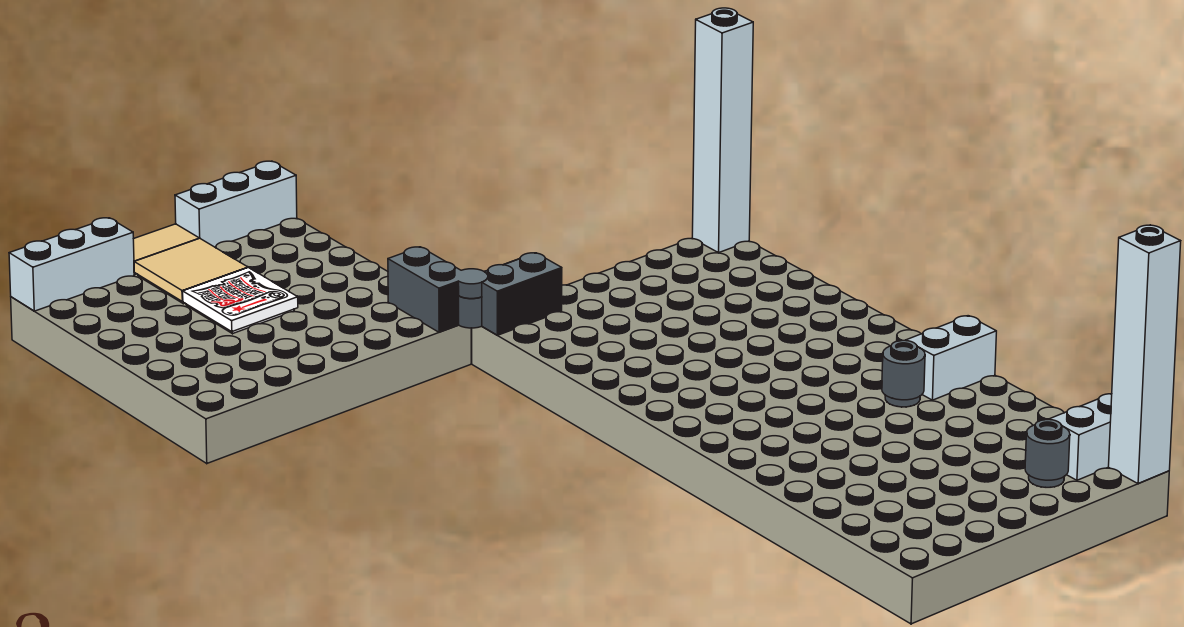

3

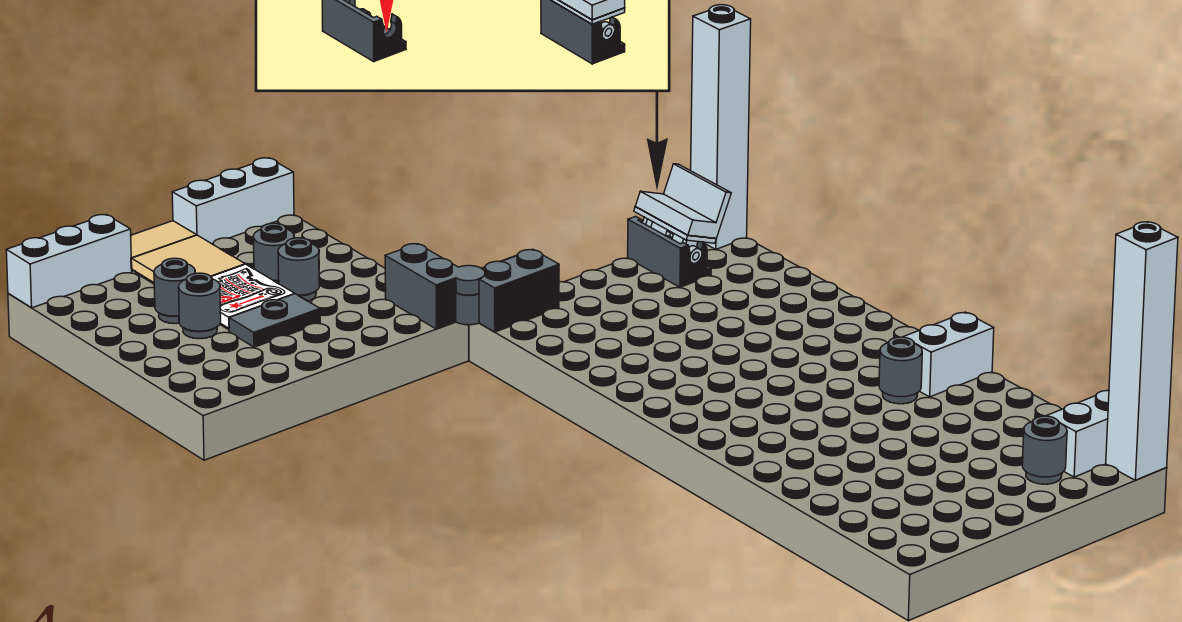
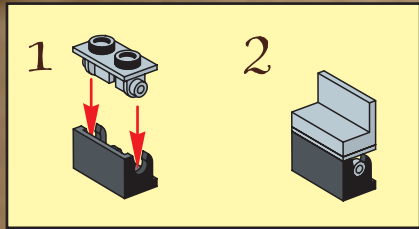

4



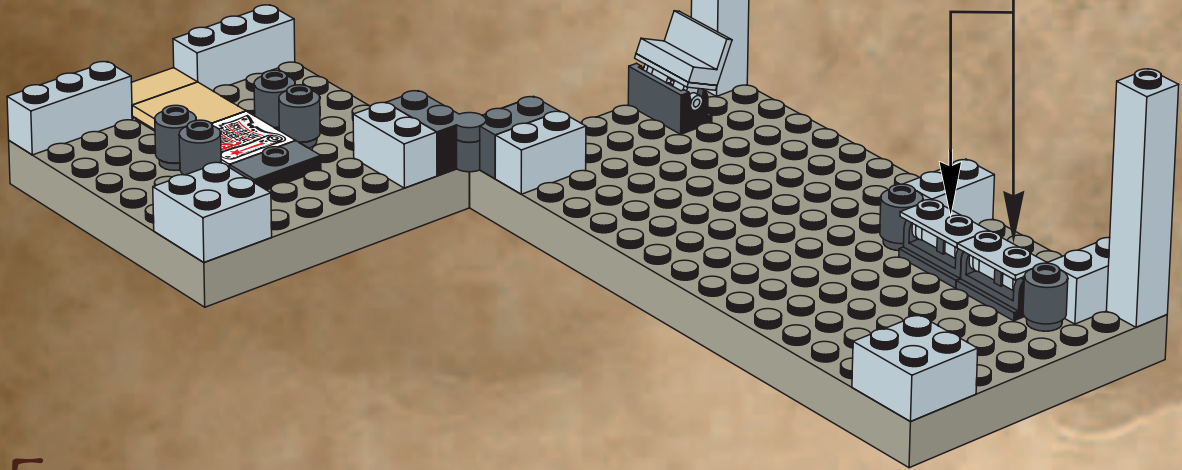

5



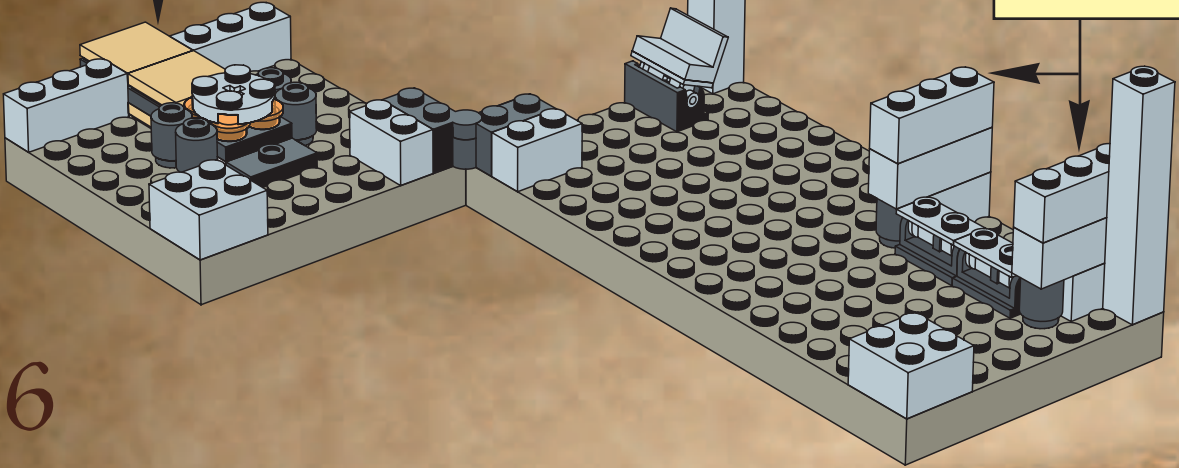
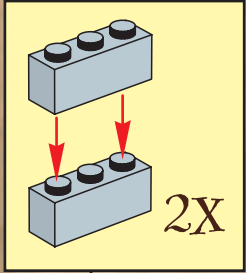
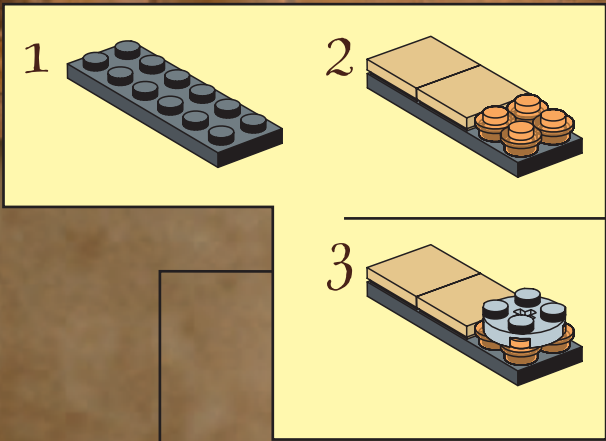



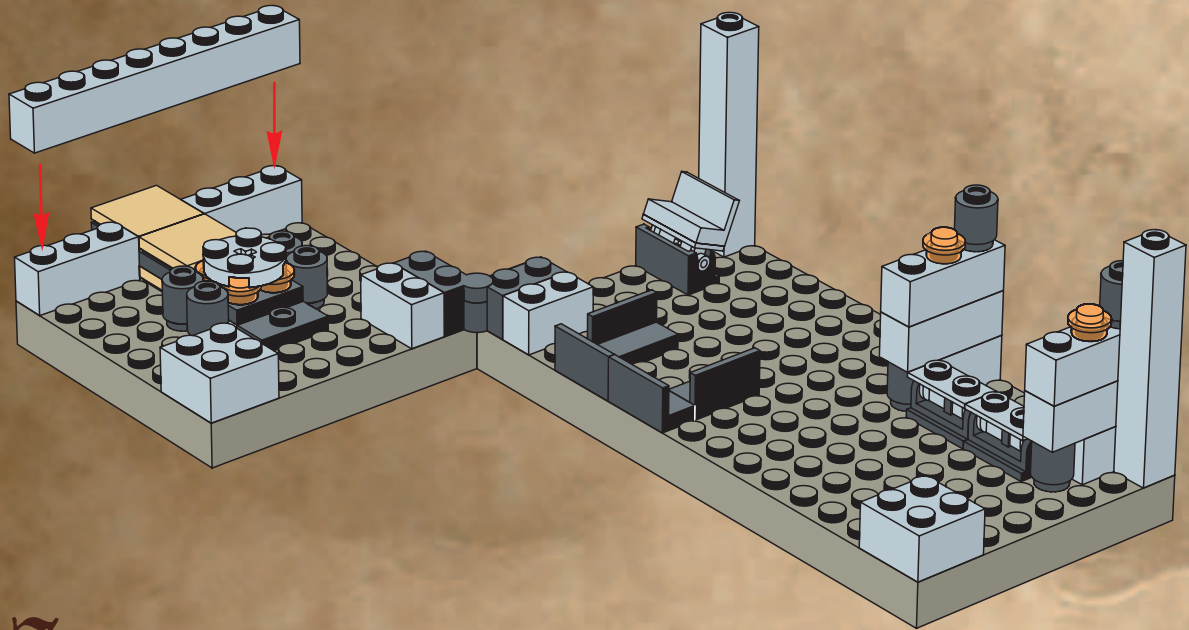

7

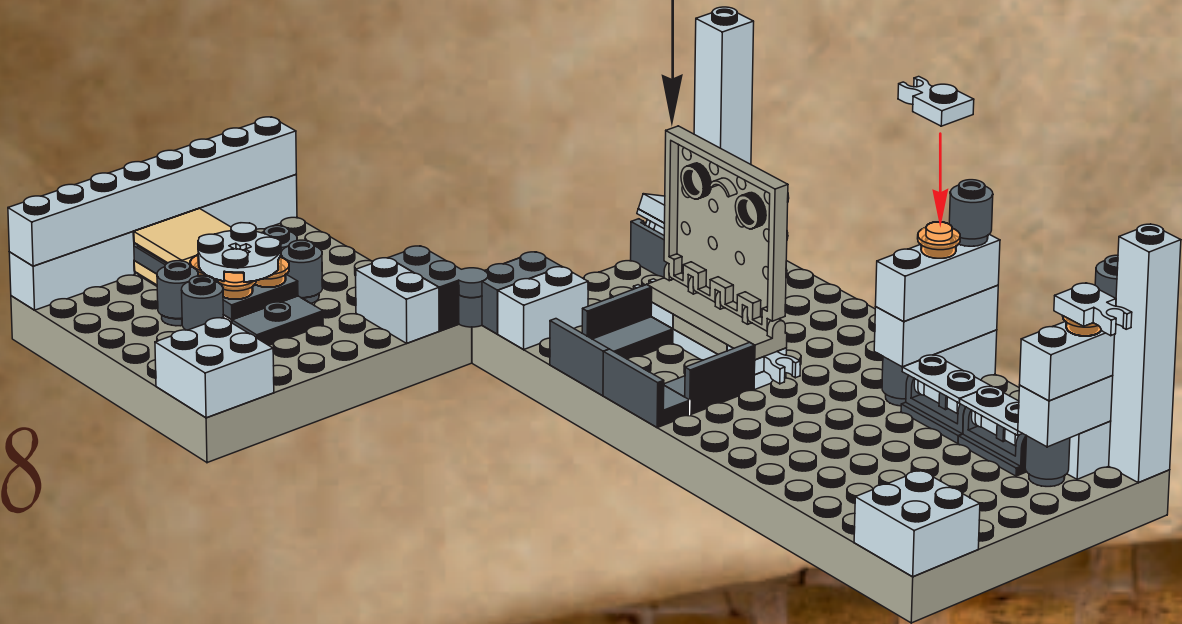
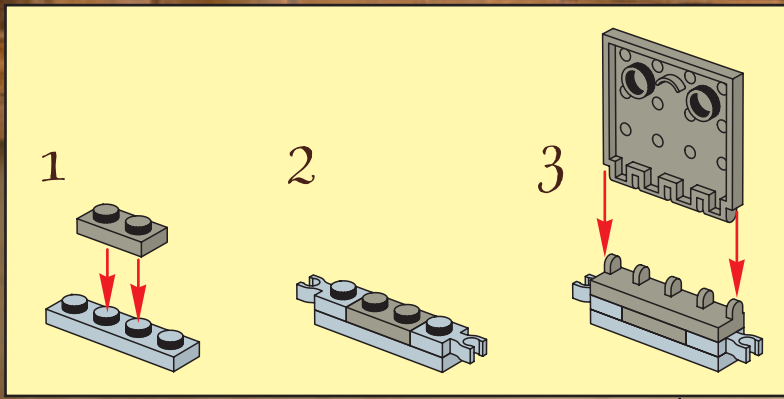

8

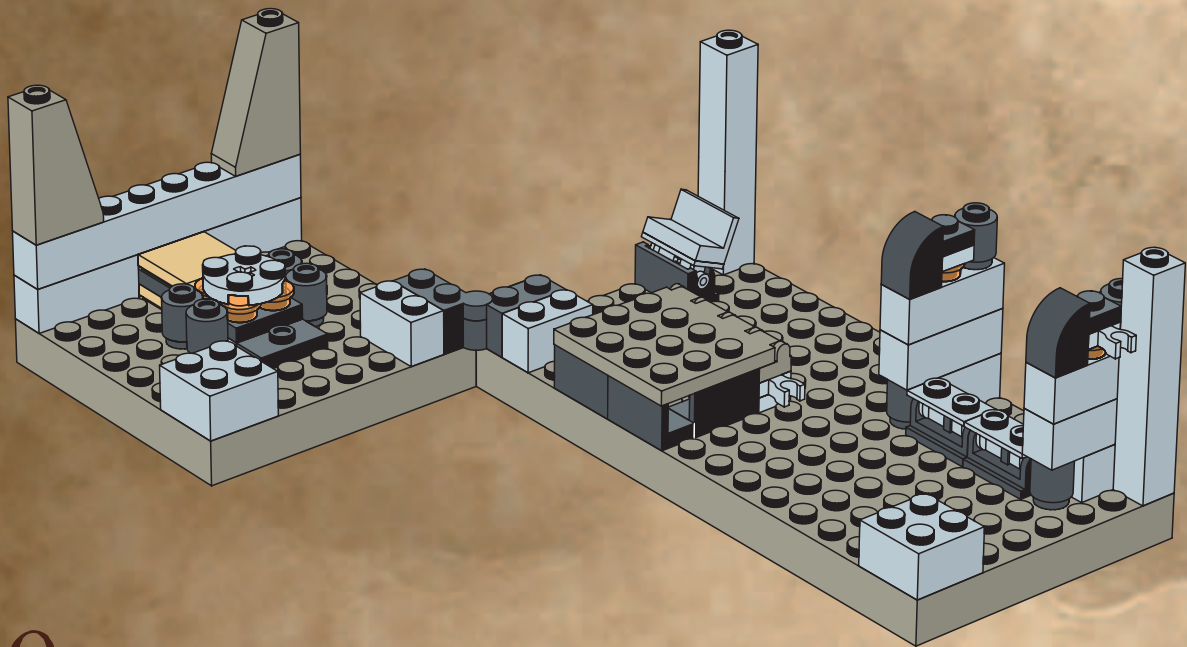

9



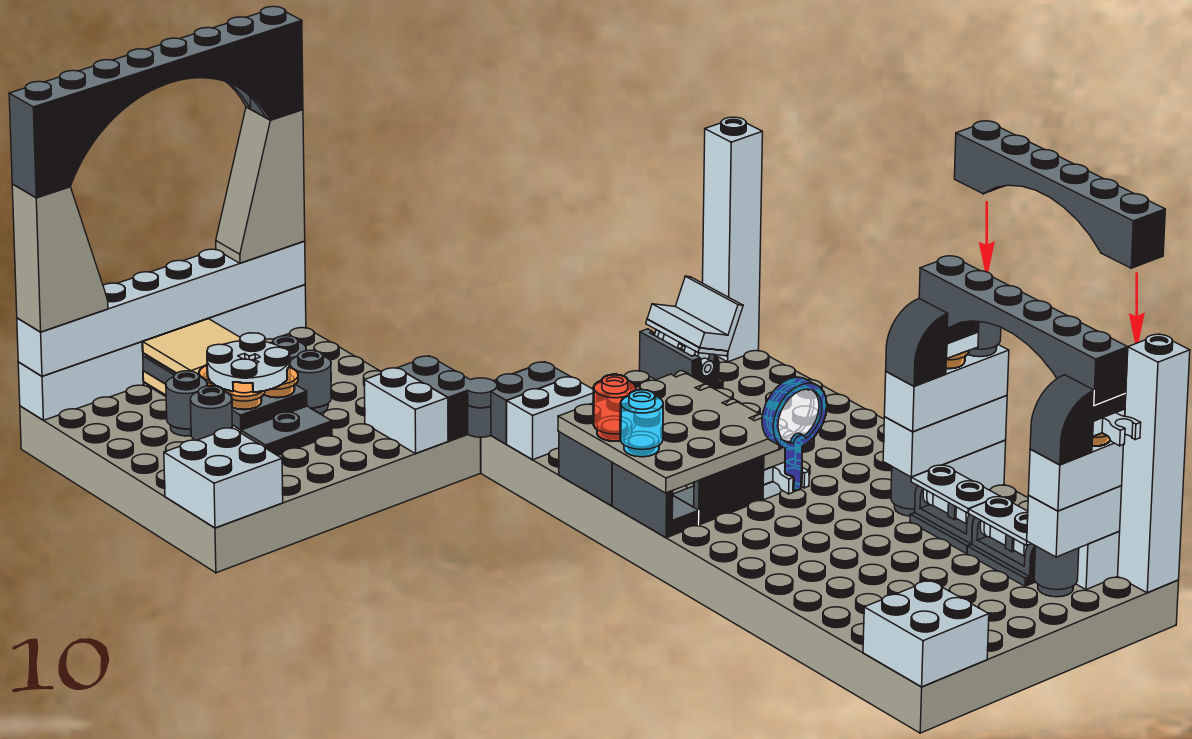

10



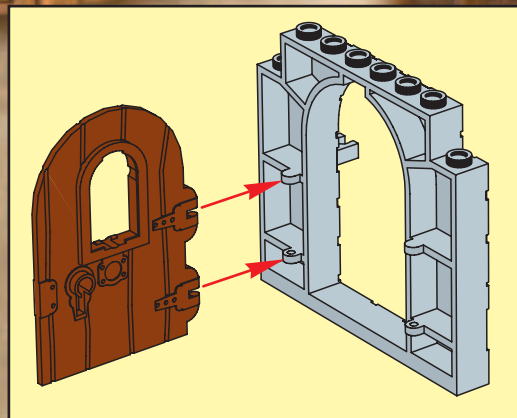
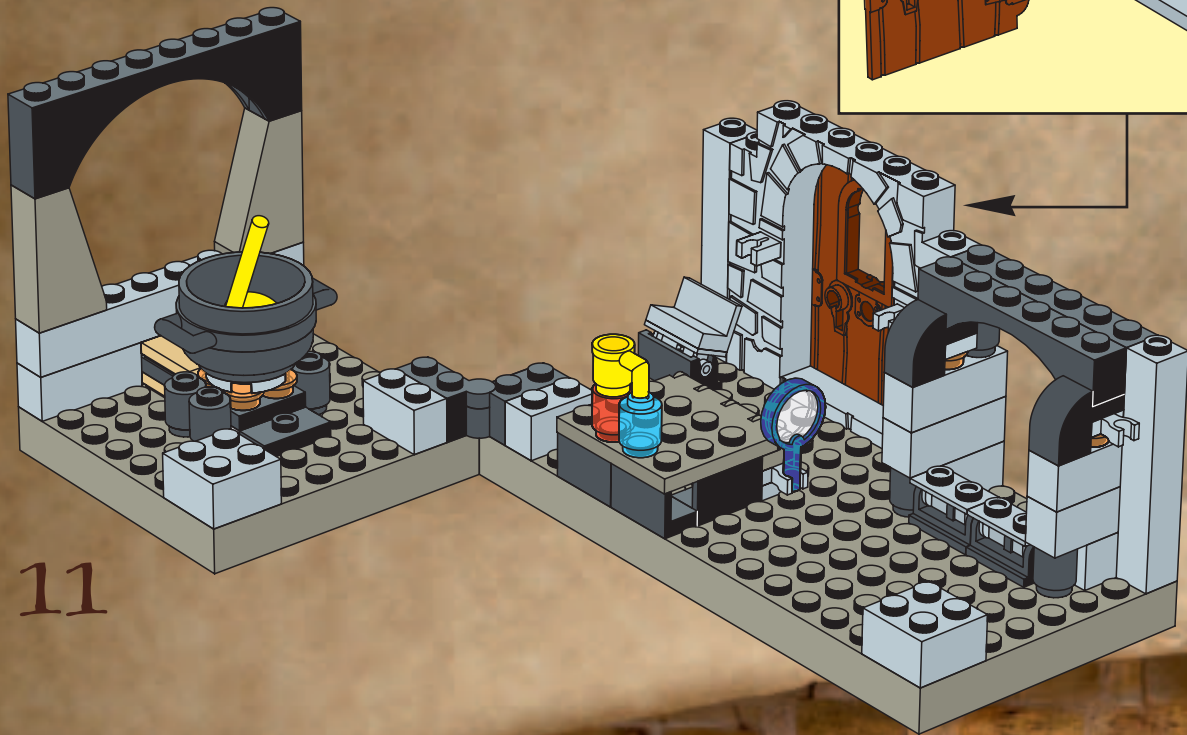

11

13

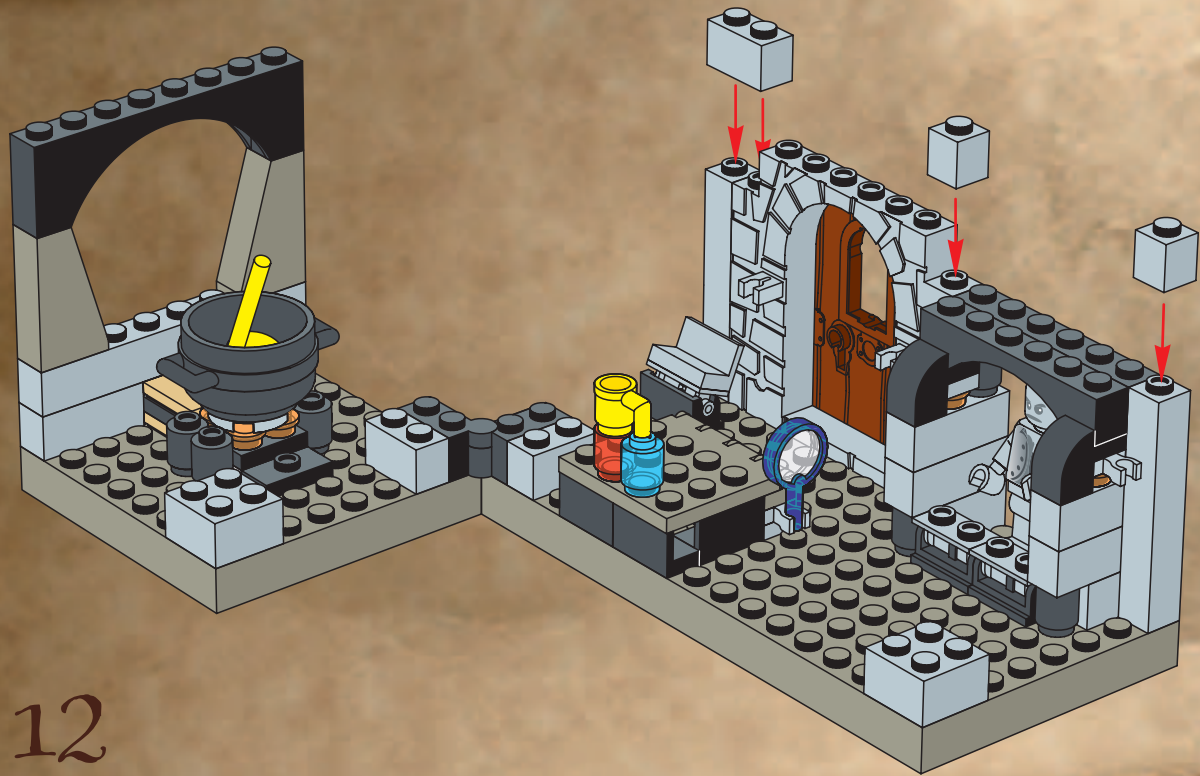

12



13



15

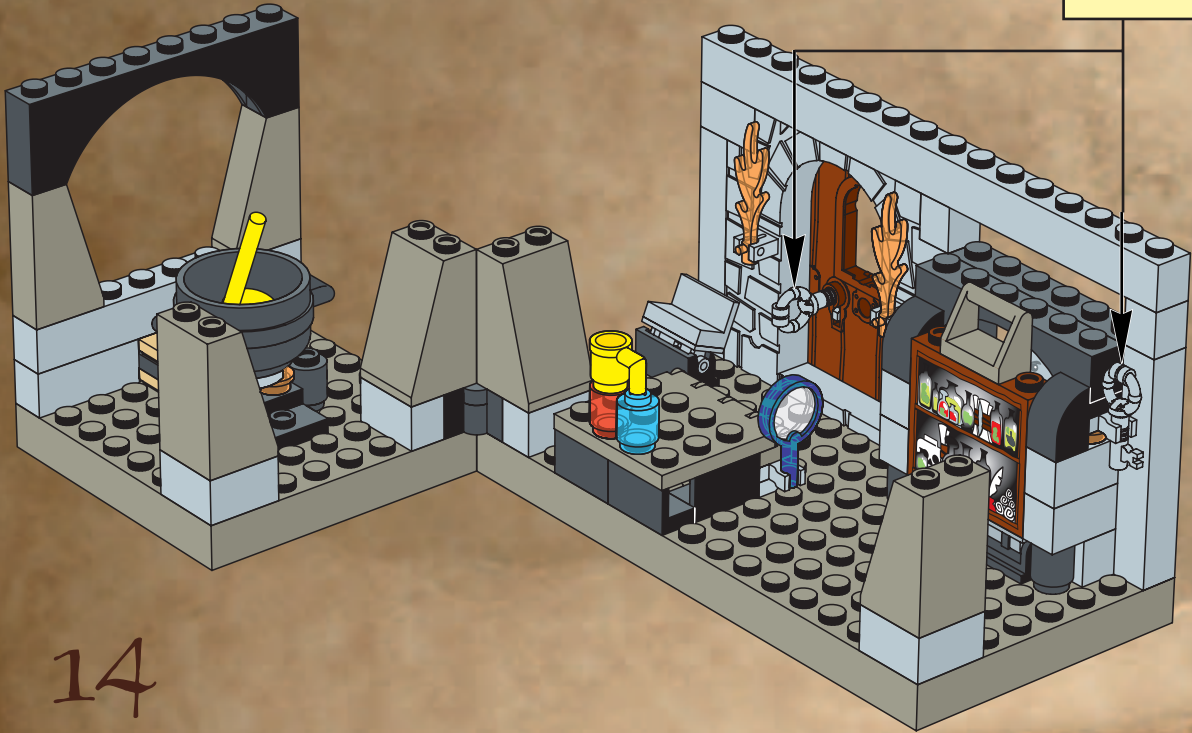
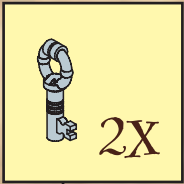

14

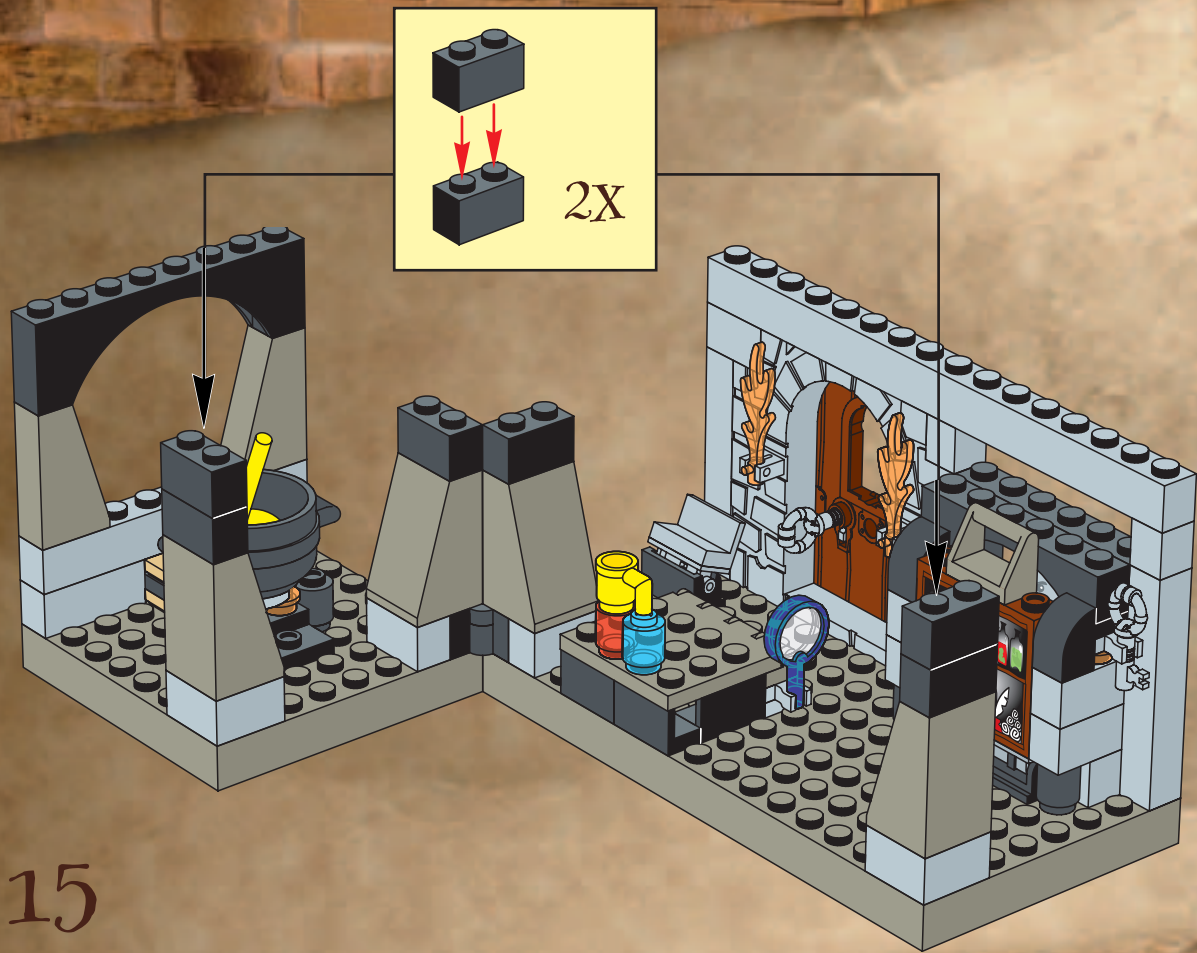

15



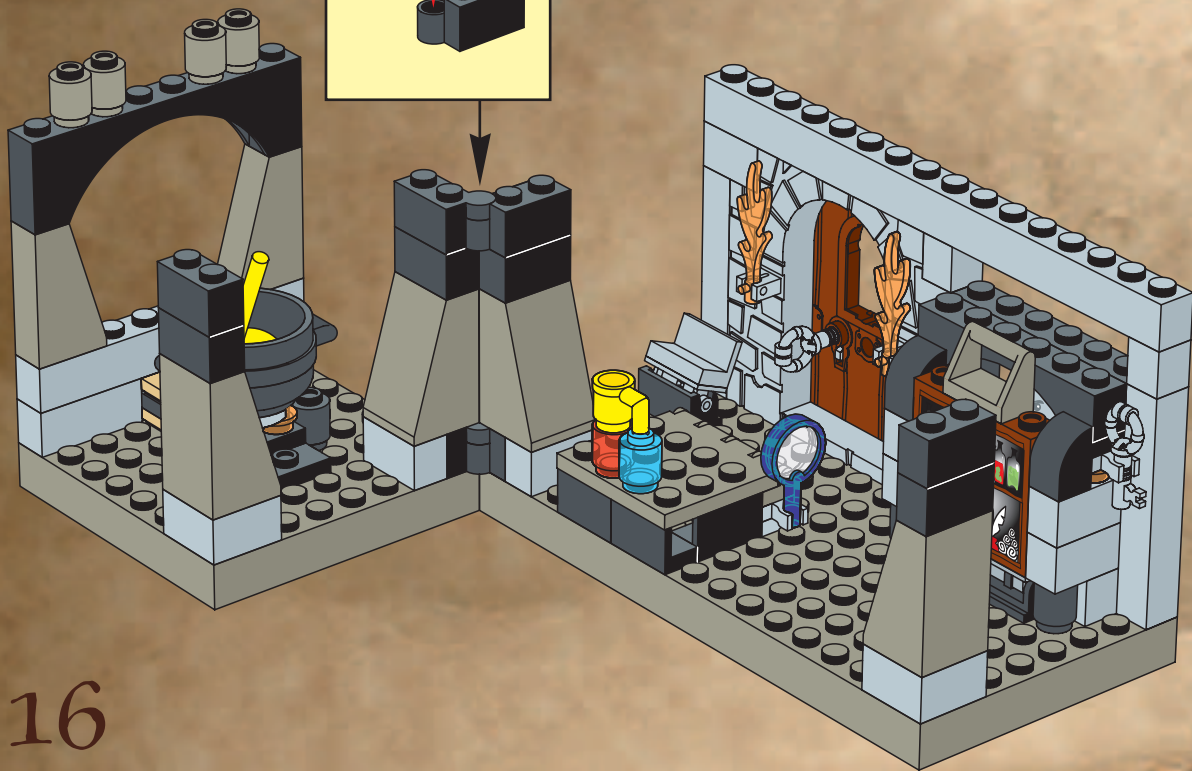
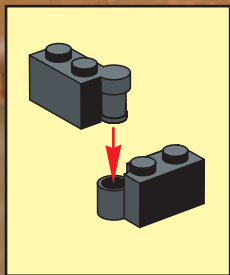

16

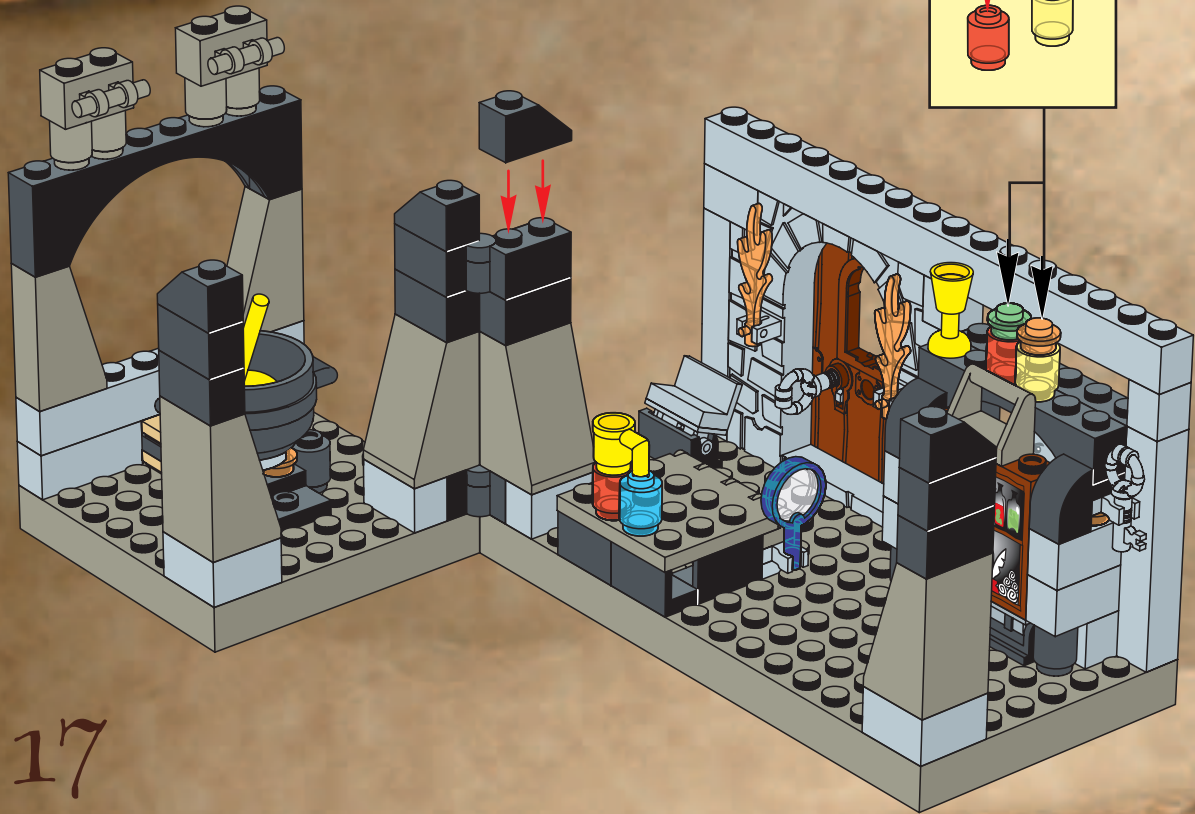

17

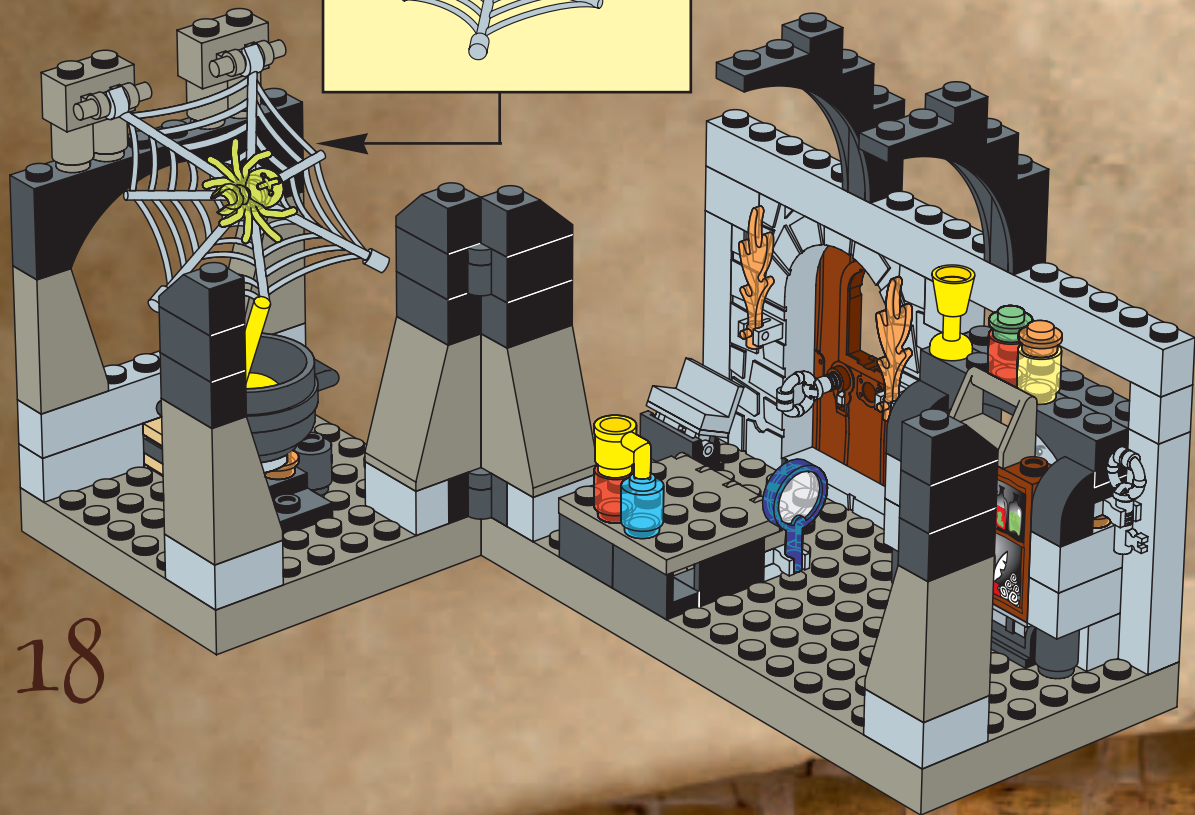
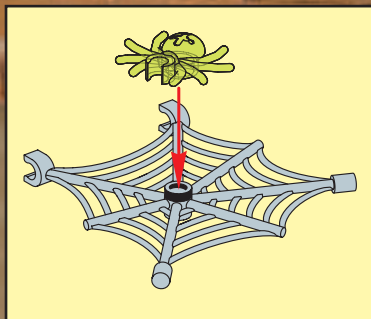

18



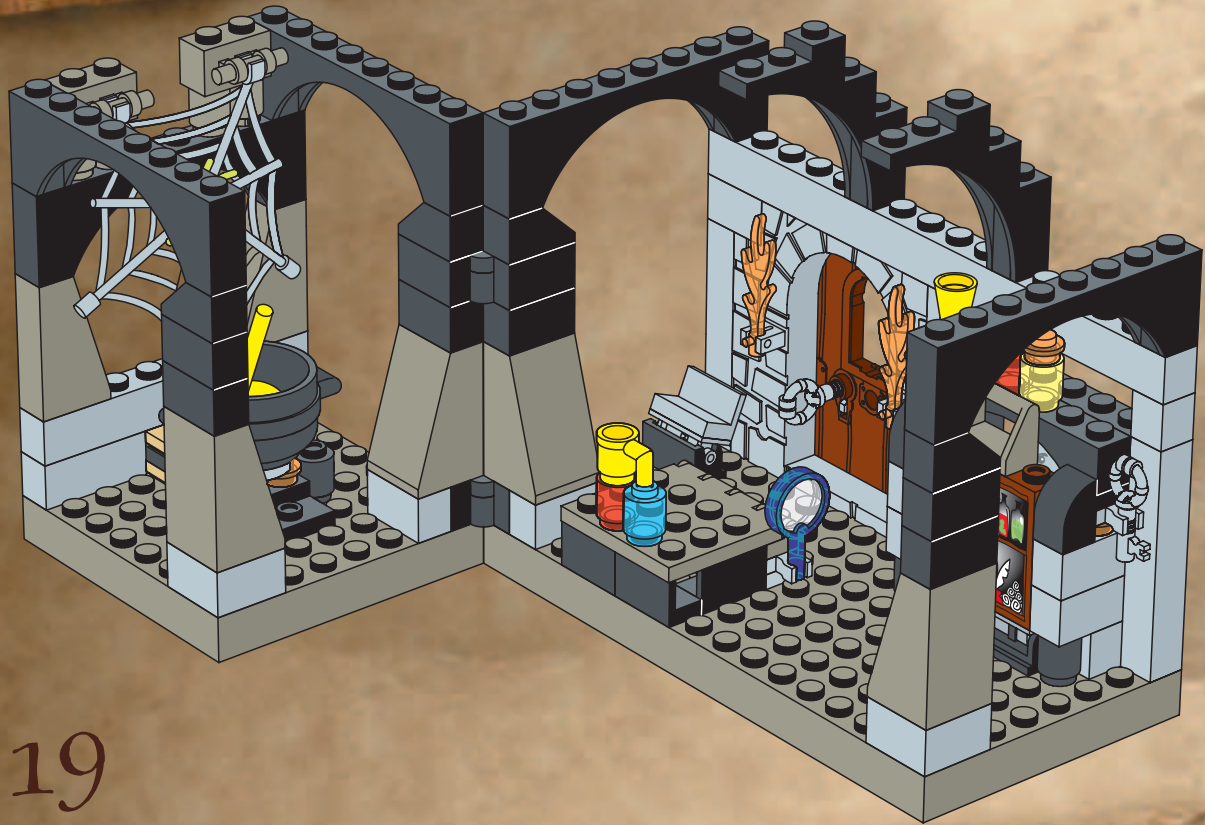

19



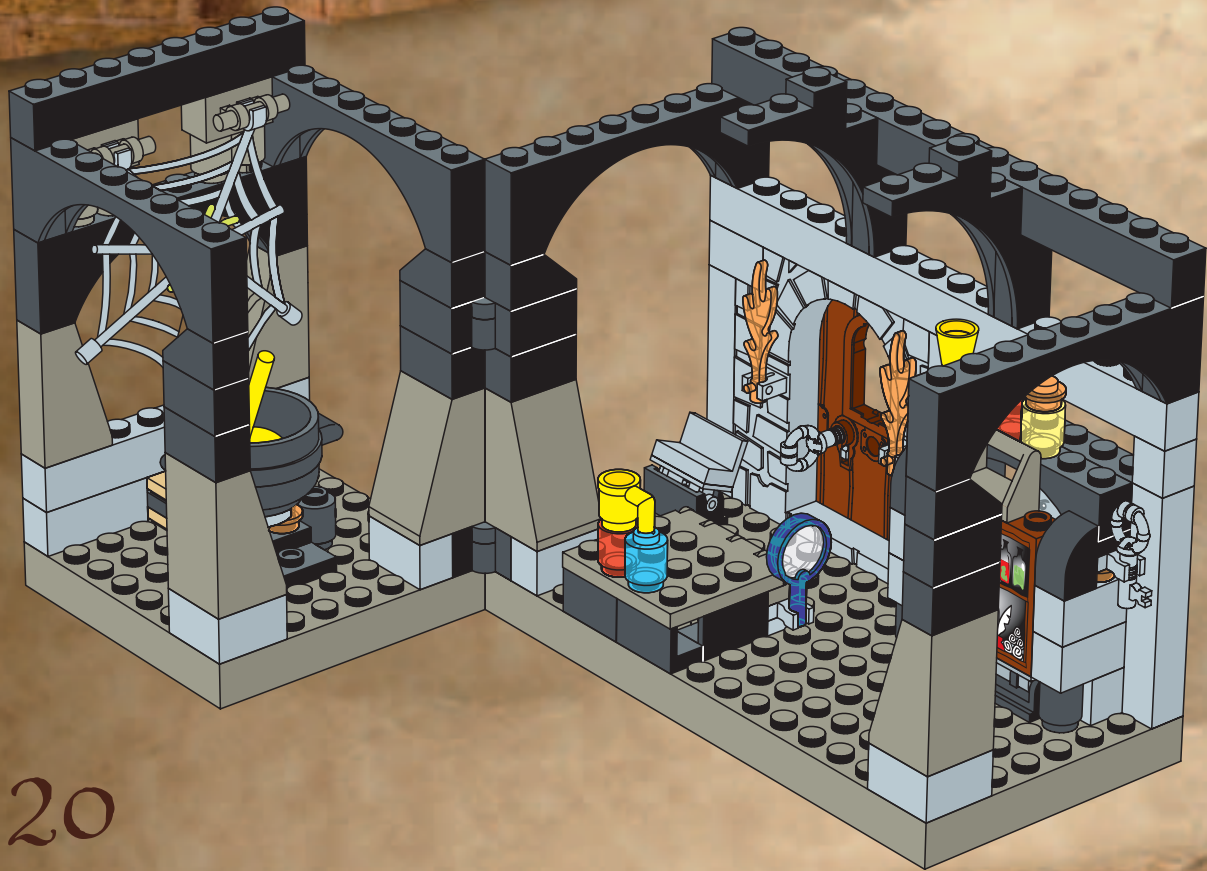

20

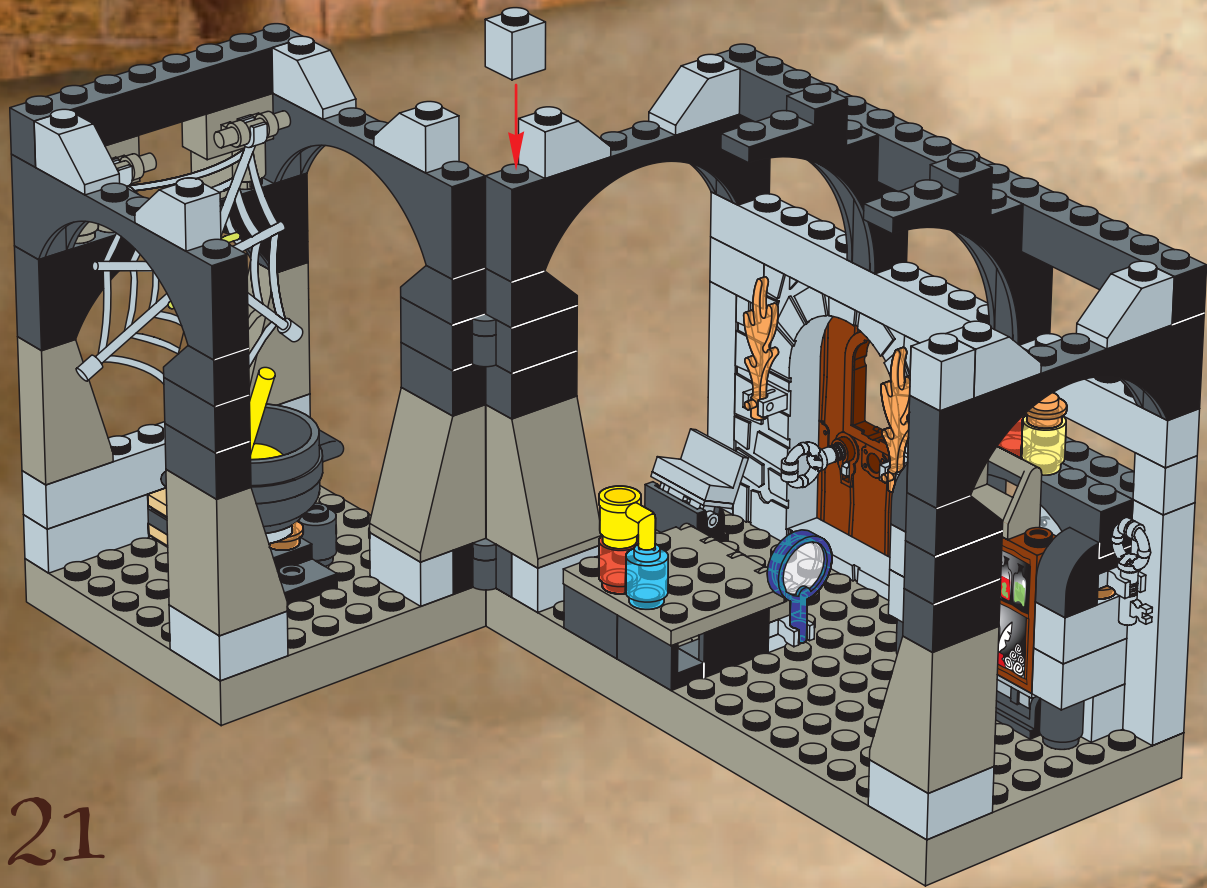

21

23



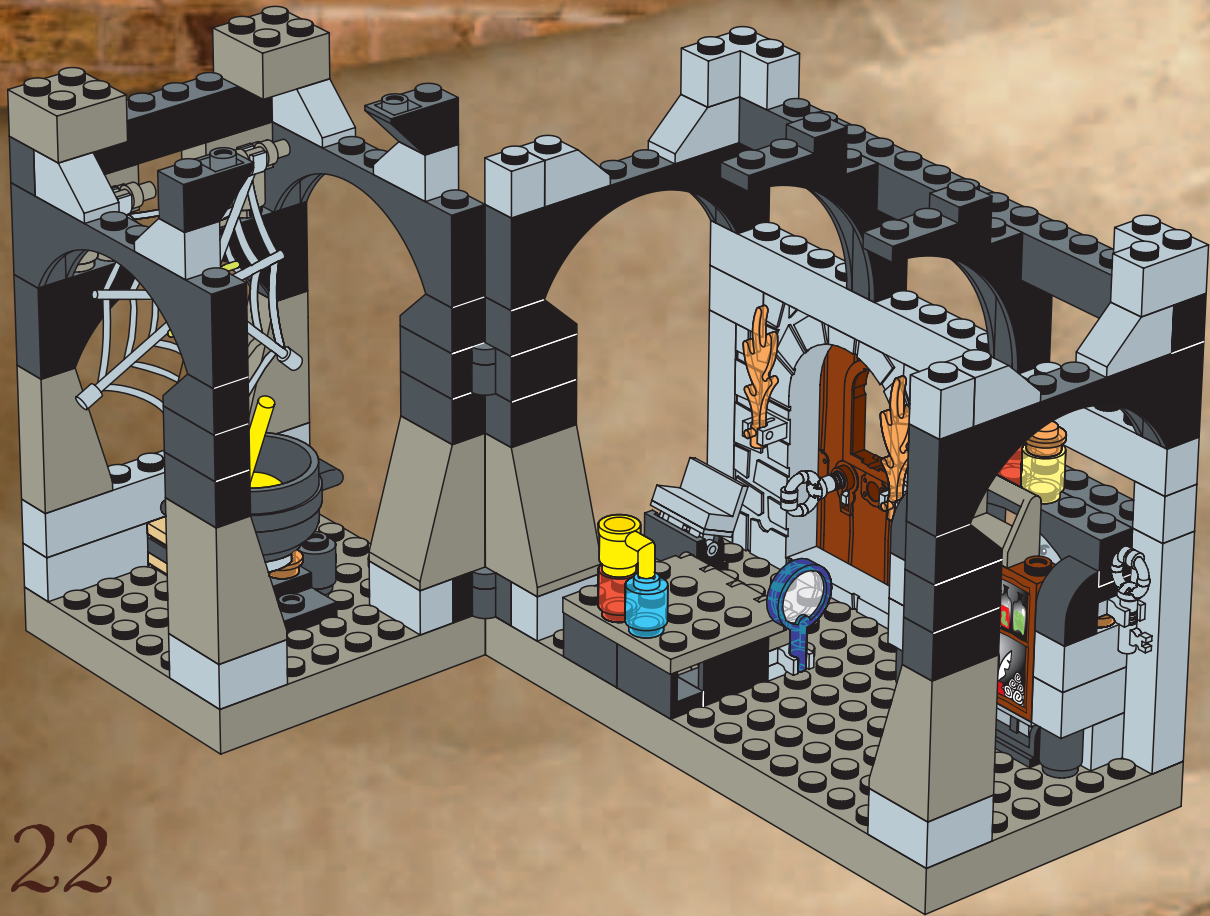

22

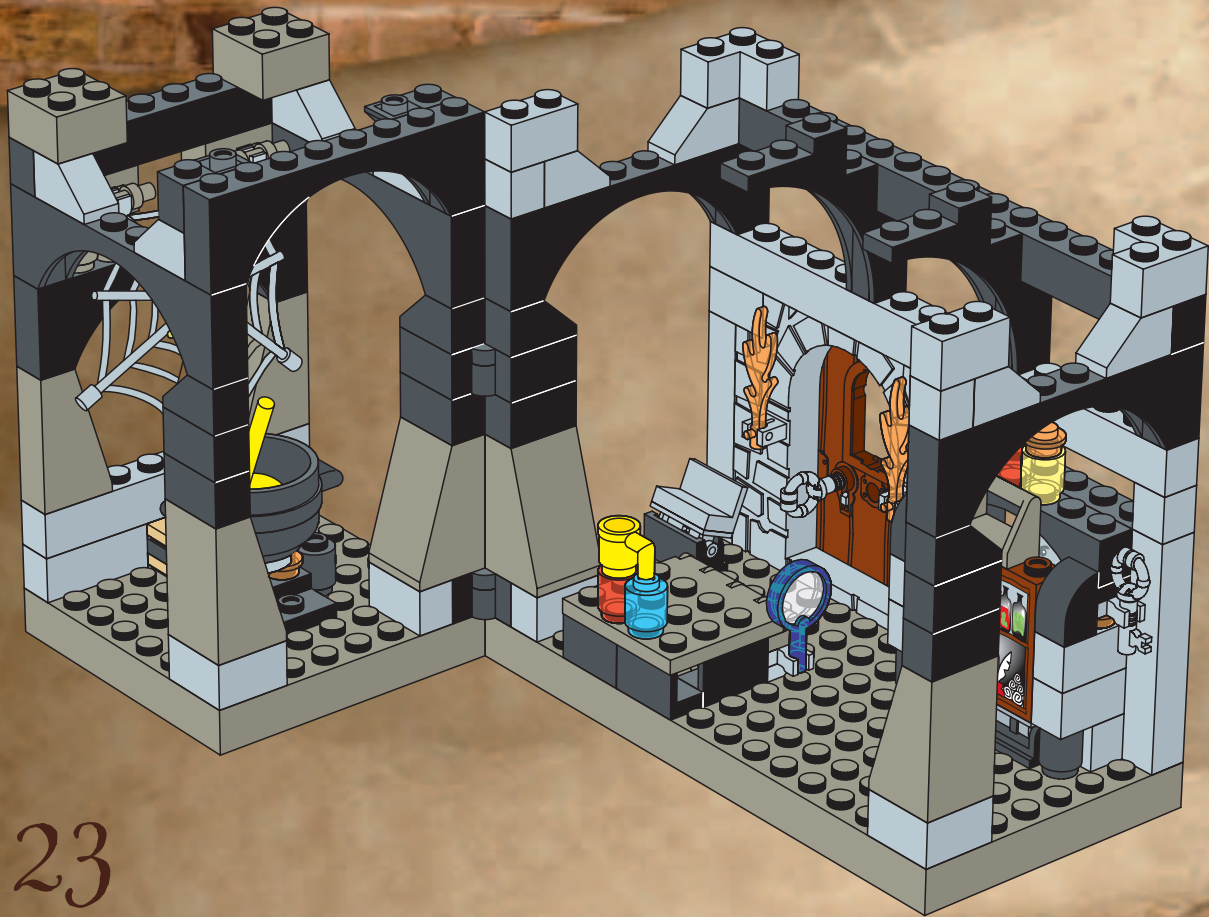

23

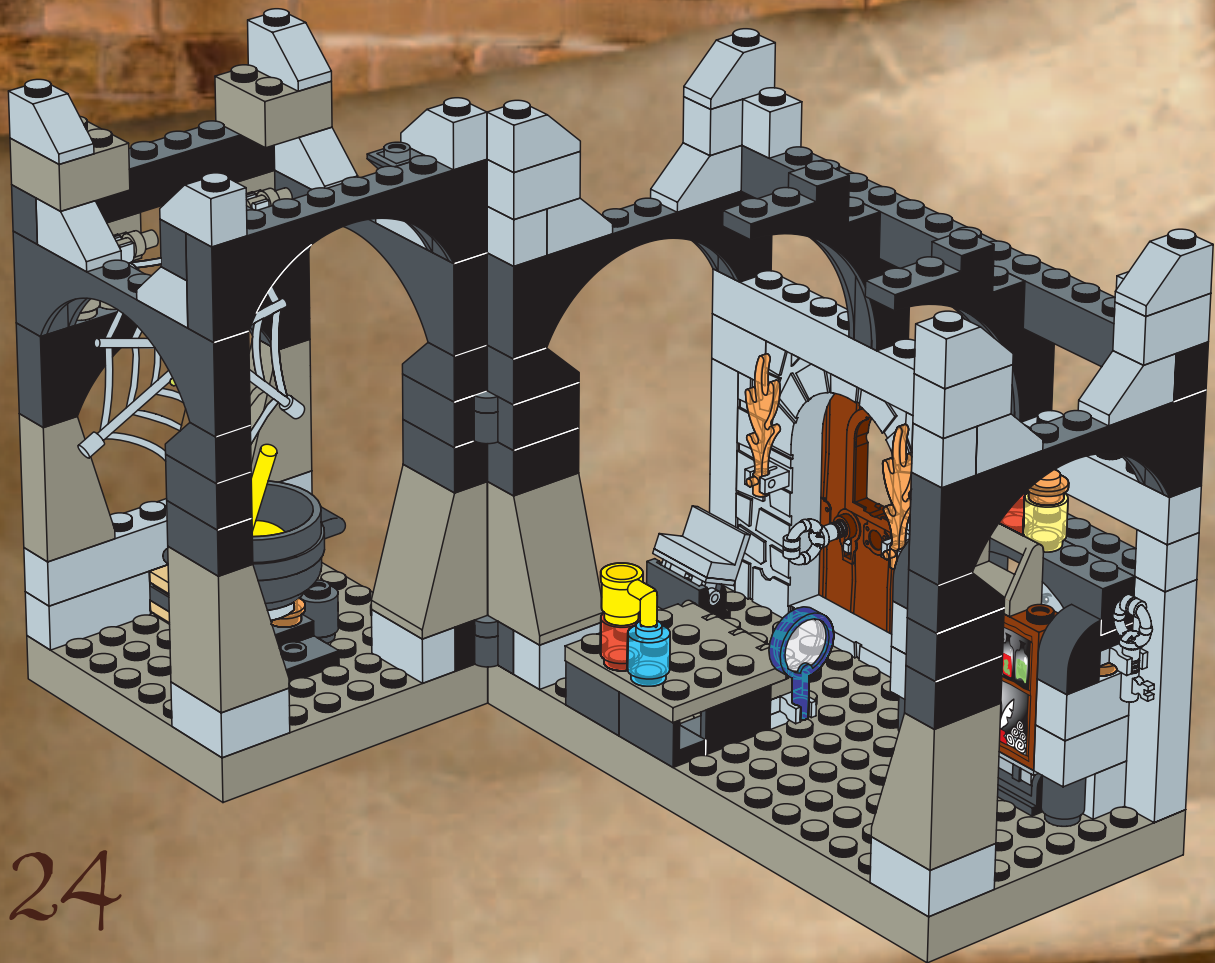

24



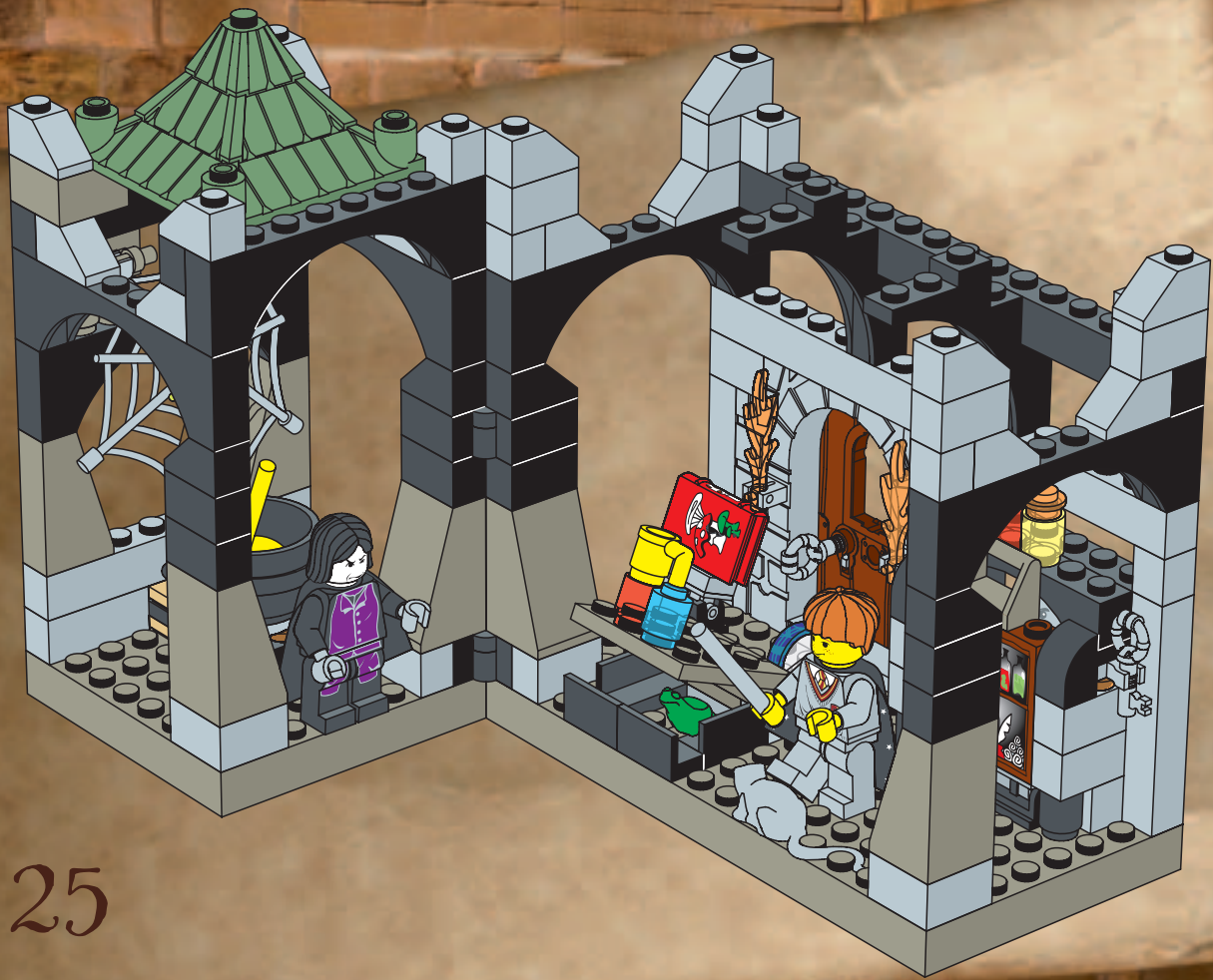



25

**LEGO** SOFTWARE



[www.harrypotter.com](http://www.harrypotter.com)



 HARRY POTTER, characters, names and related indicia are trademarks of Warner Bros. © 2001.  
HARRY POTTER, characters, names and related indicia are trademarks of and © Warner Bros.  
(s01)  
 WB SHIELD: TM & © 2001 Warner Bros.  
© 2001 The LEGO Group.

4163047