



# HERO FACTORY

44029







1



2



3



4



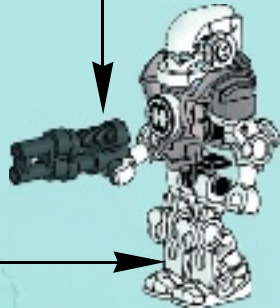
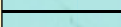
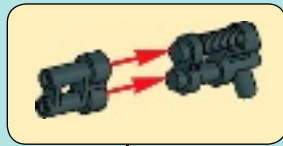
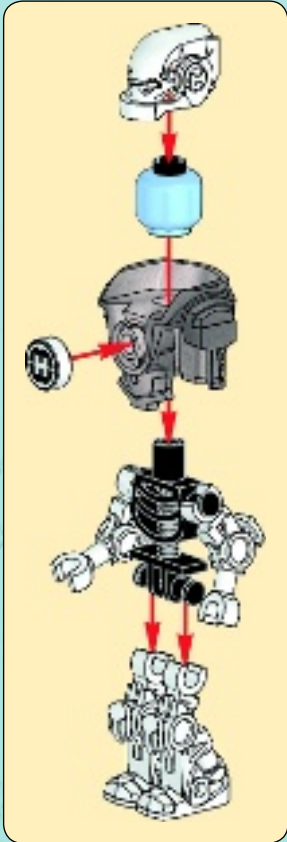
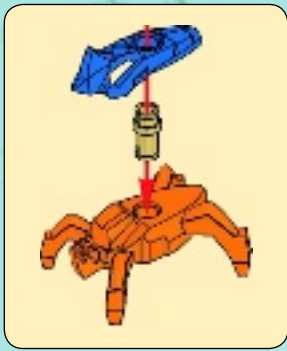

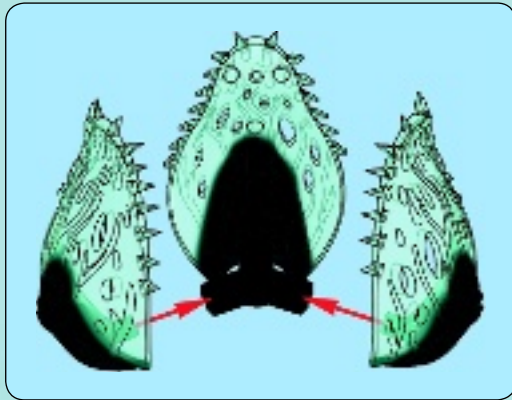
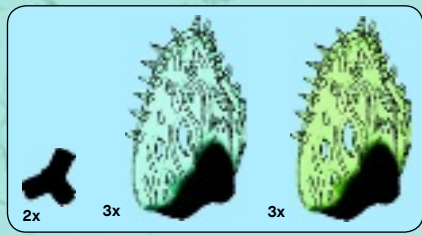

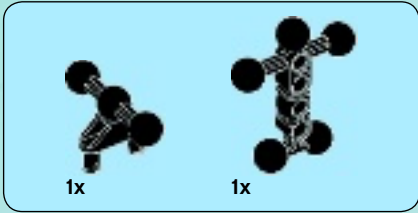

1

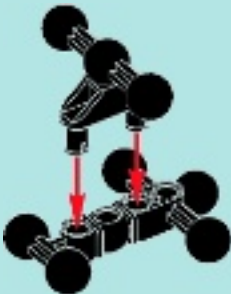

2



3



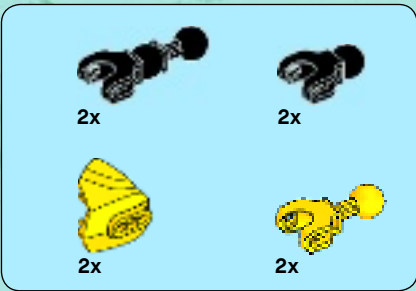

# 4

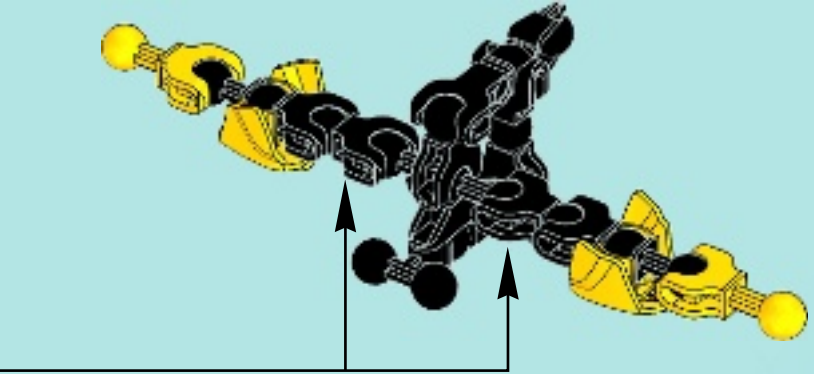
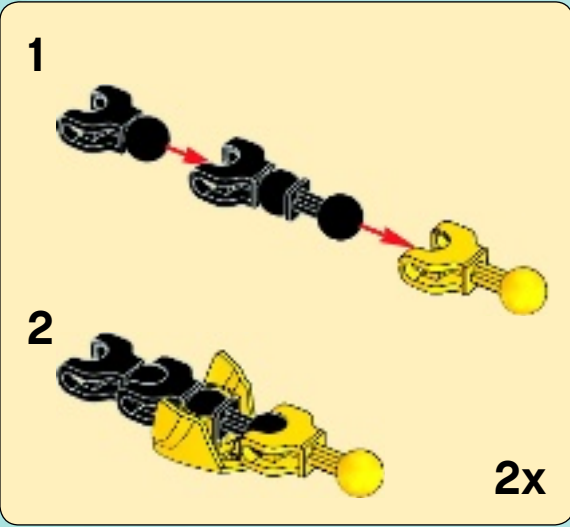





5

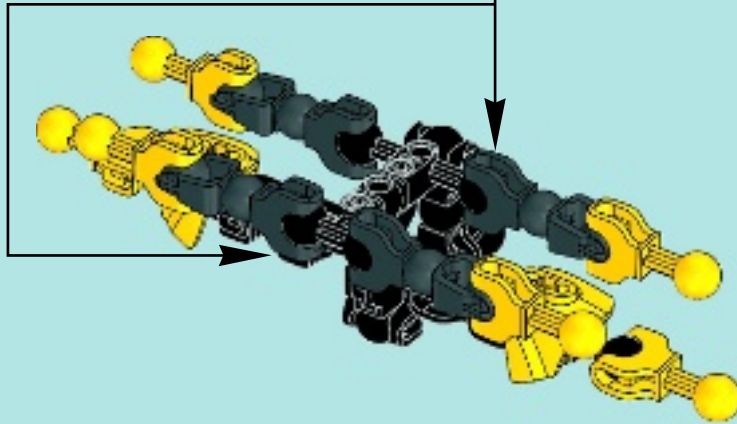
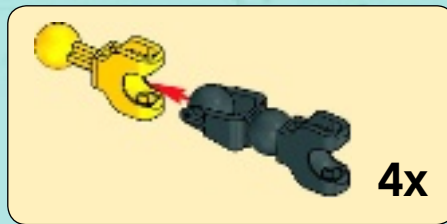
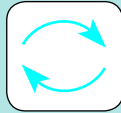

6

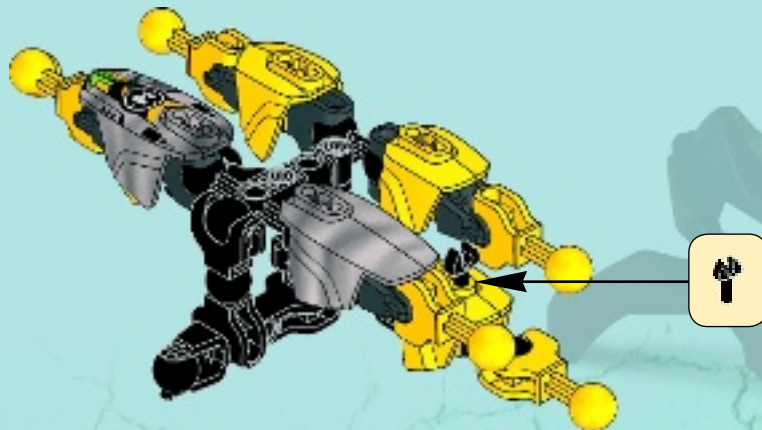

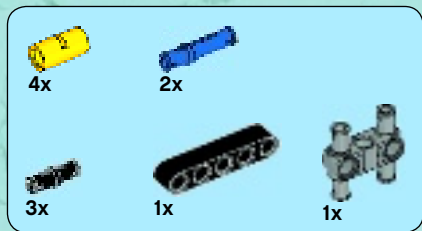

# 7

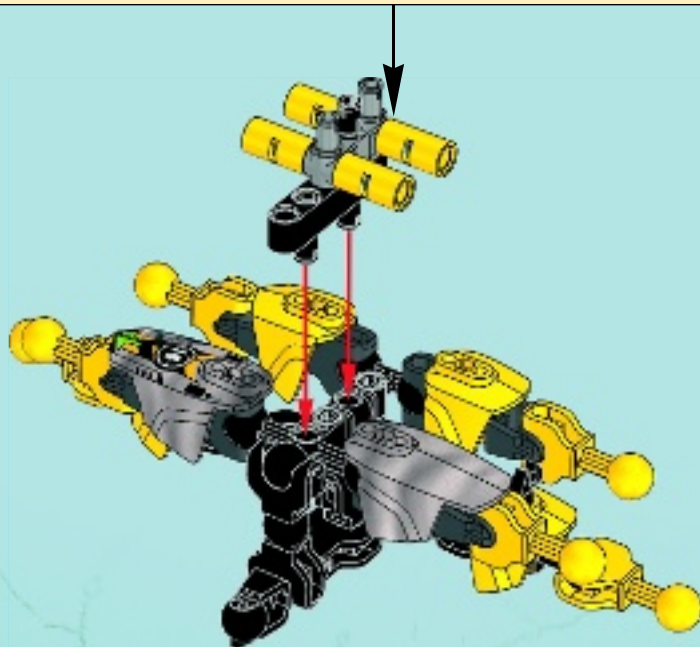
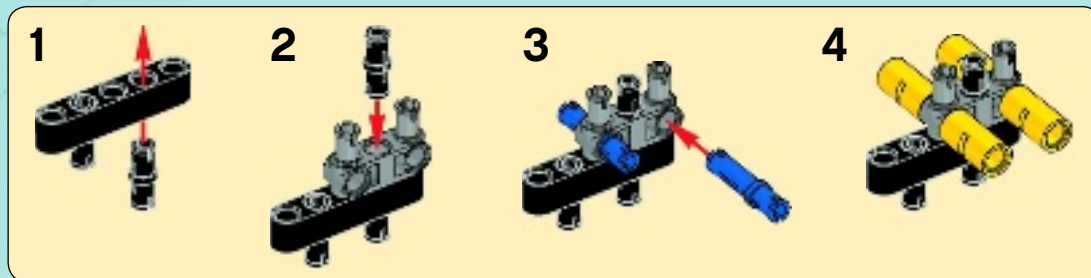

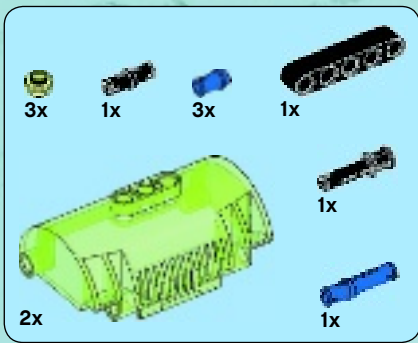

8

1

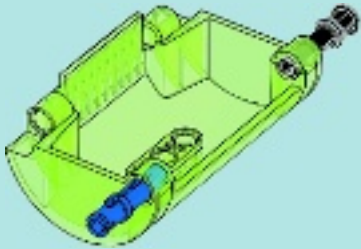

2

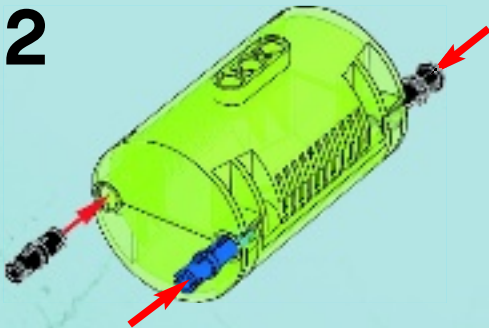

3

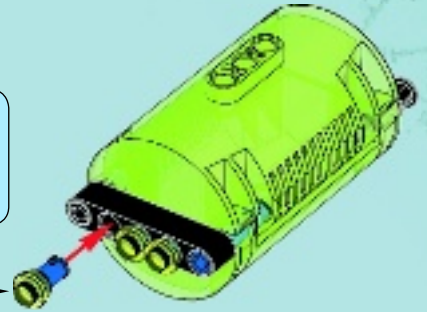

4

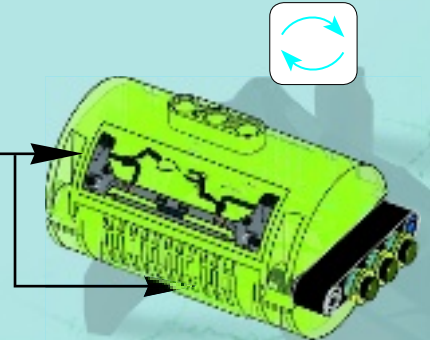
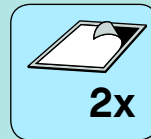

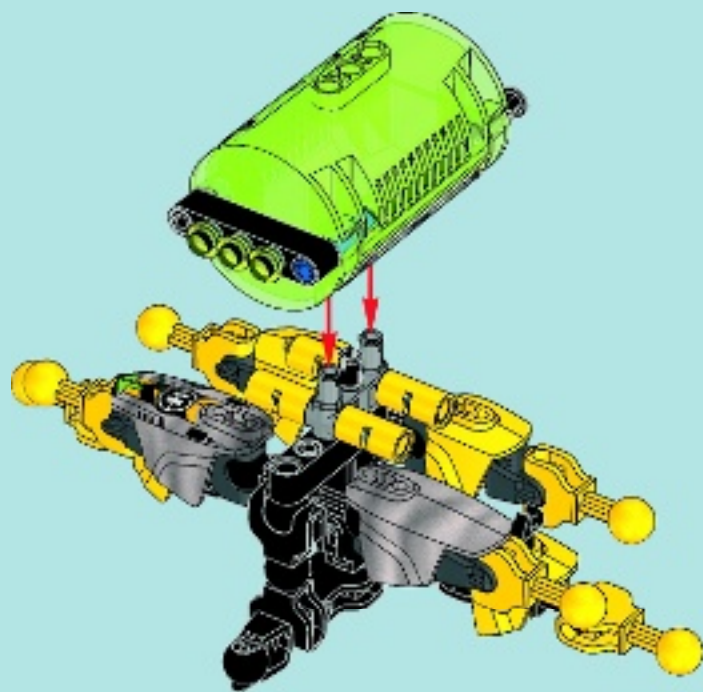

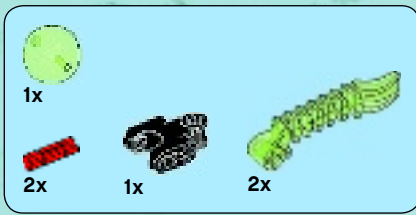

# 9

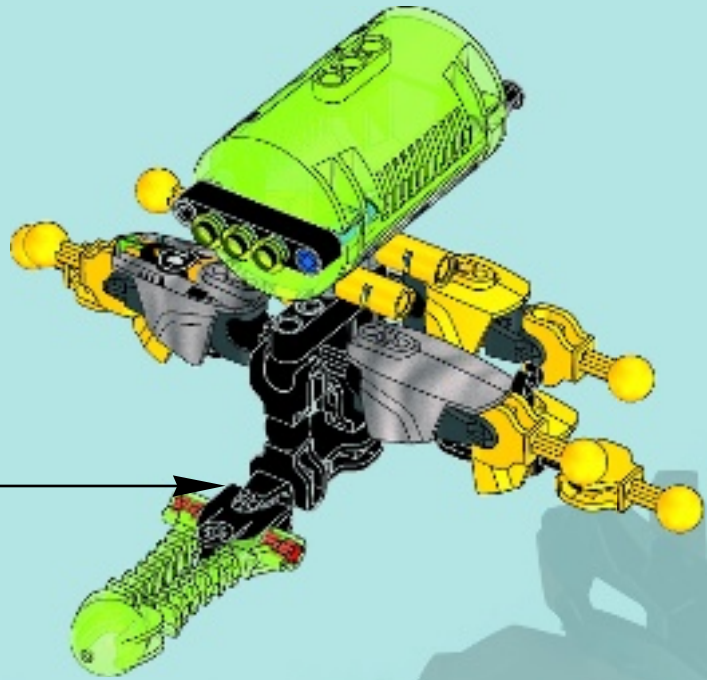
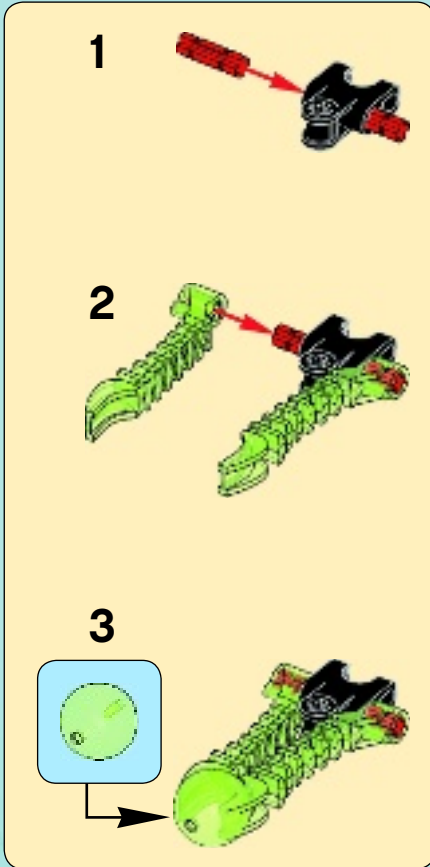

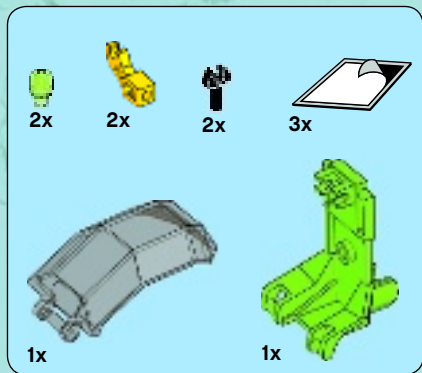

# 10

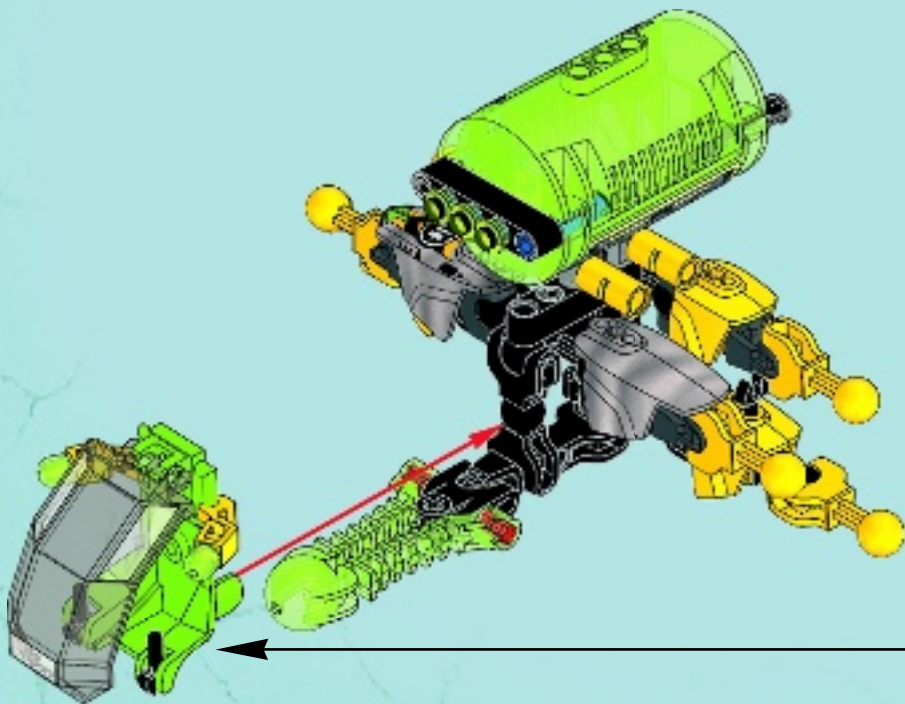

1

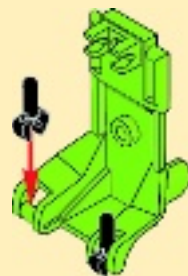

2x



2



3

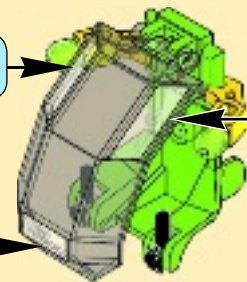
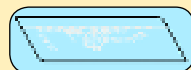

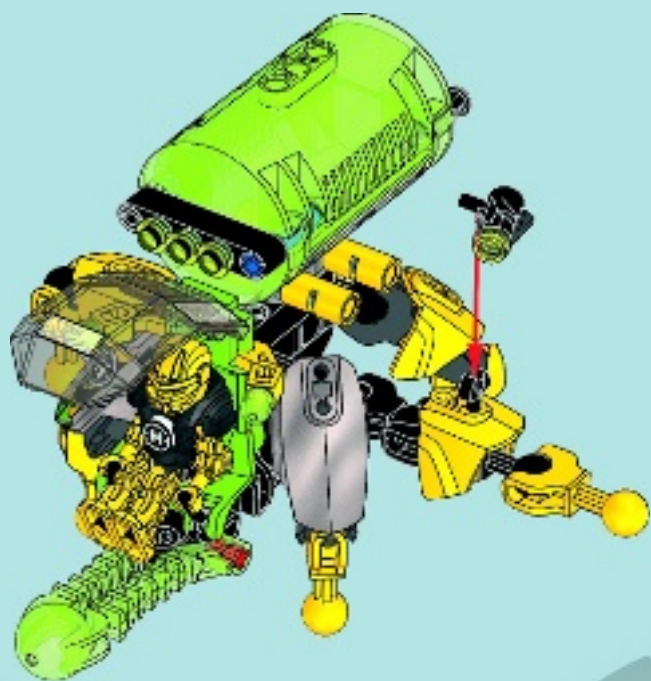

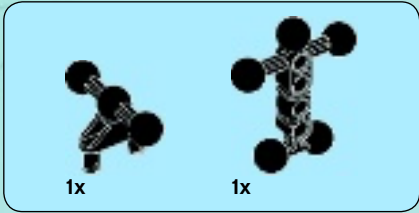
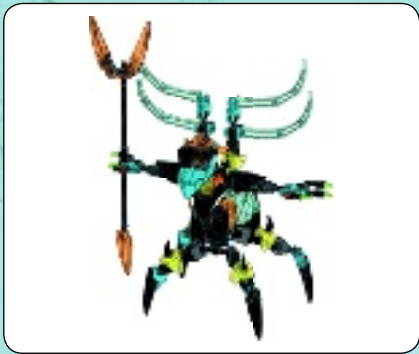

1

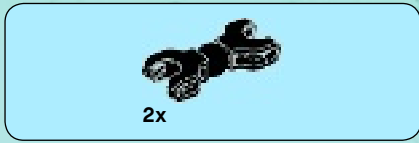
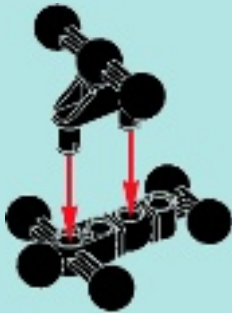

2

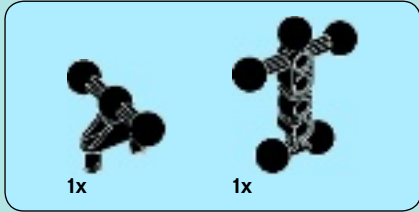

3

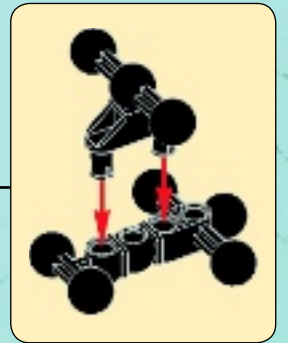



2x

1x

# 4

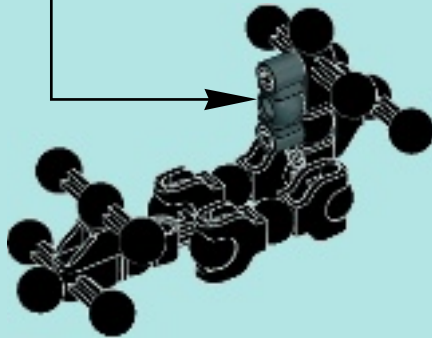

1x



1x

# 5

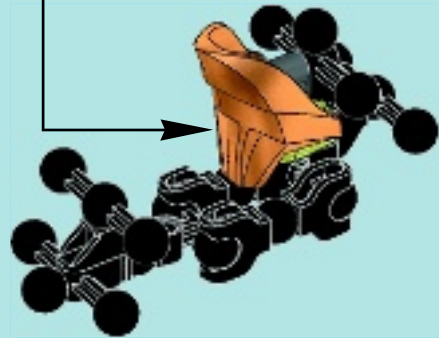
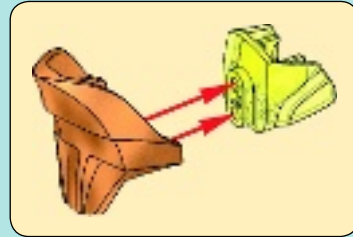



6

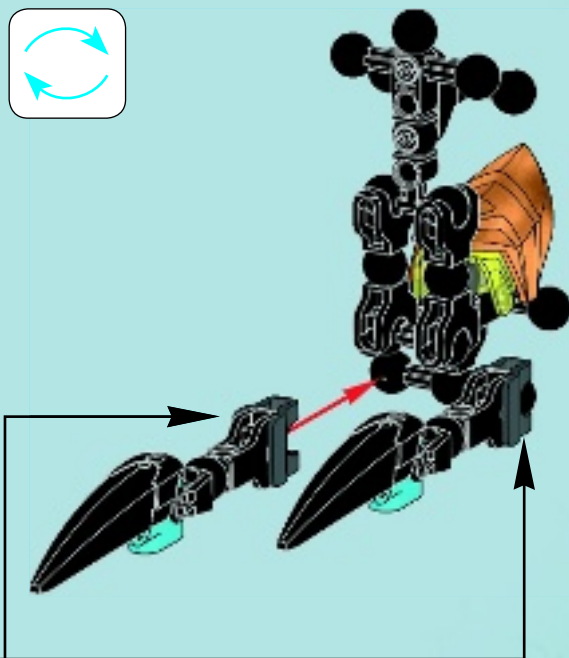
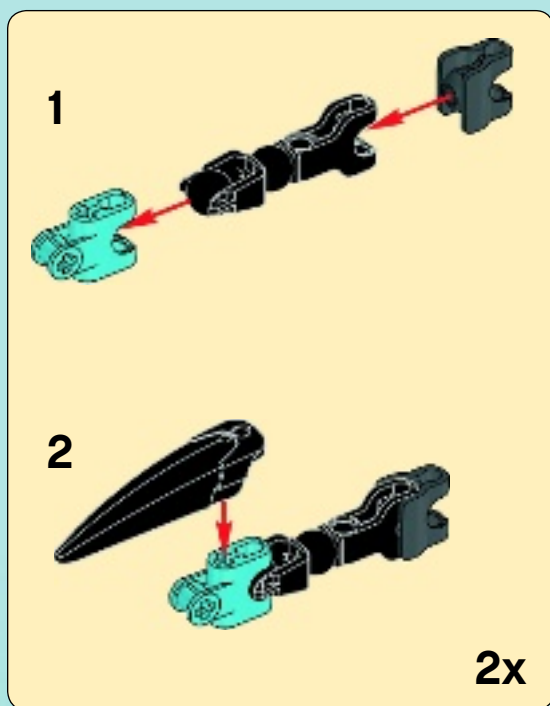



7

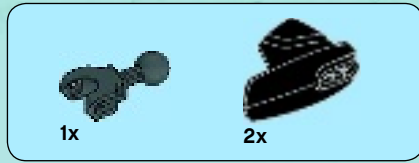
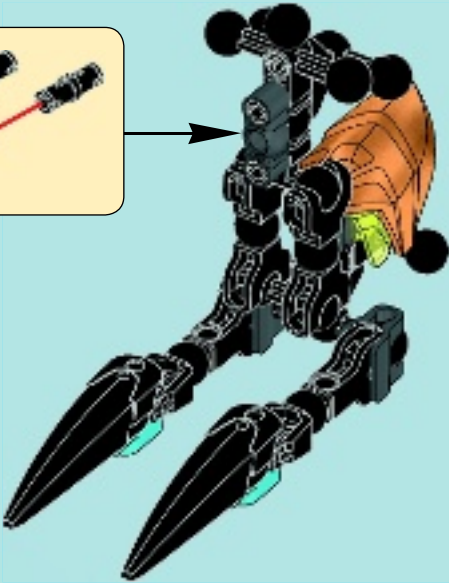

8

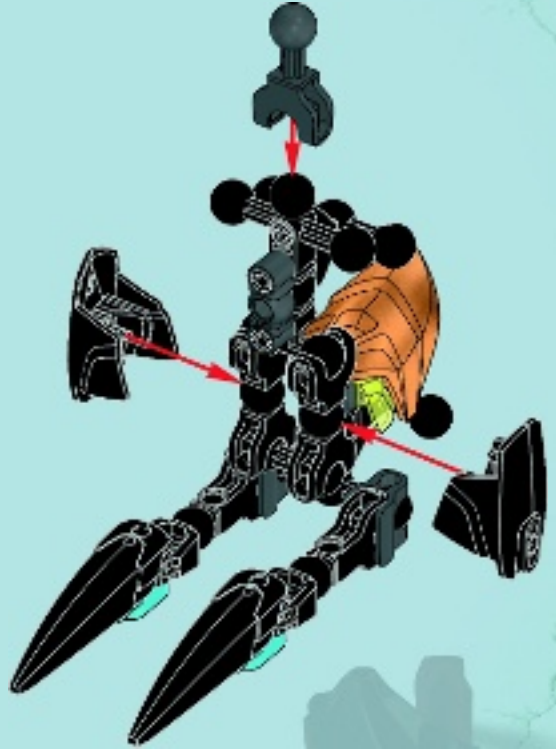

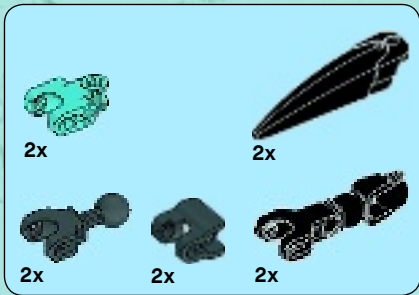

9

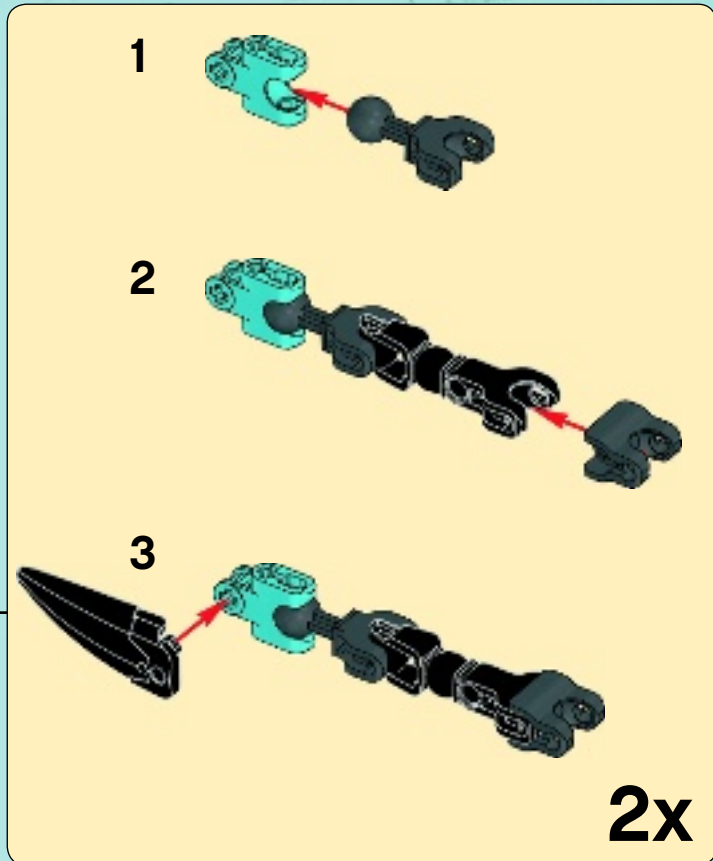
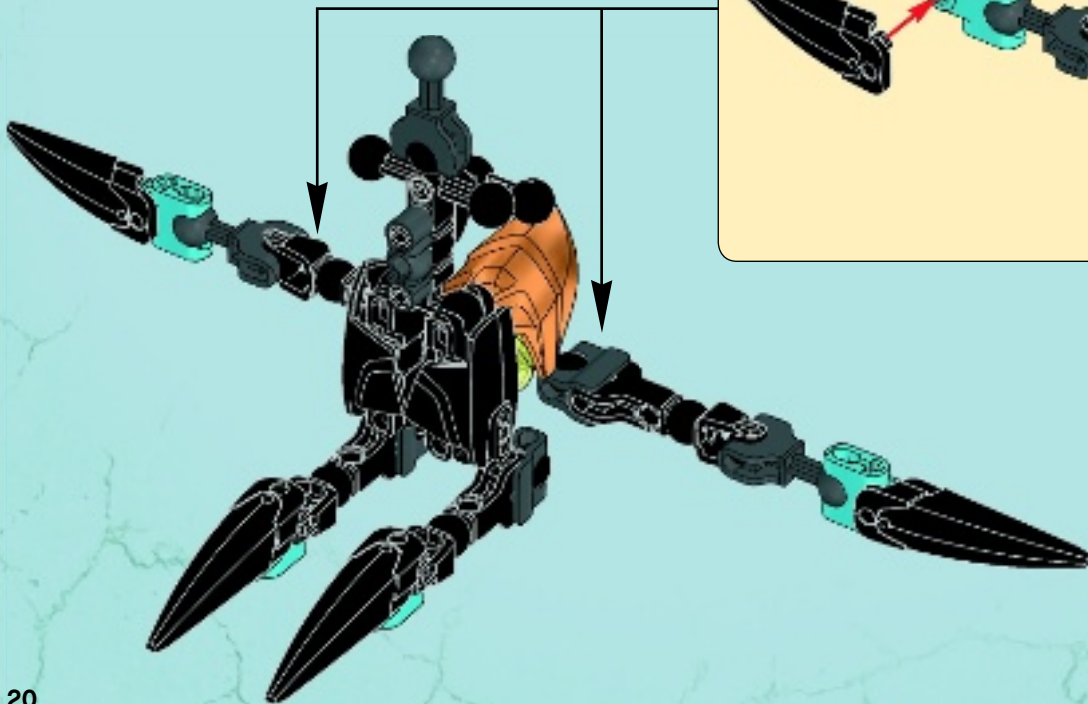

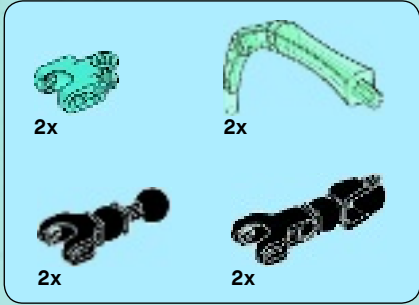

10

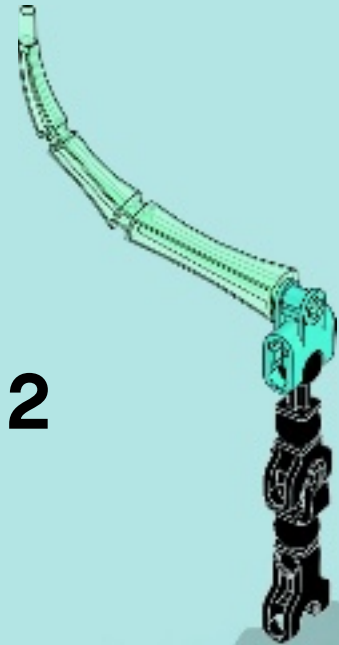
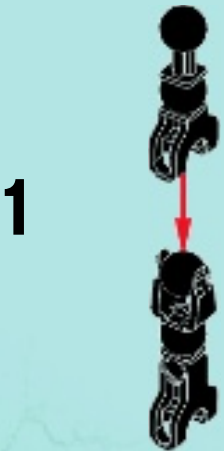

2x

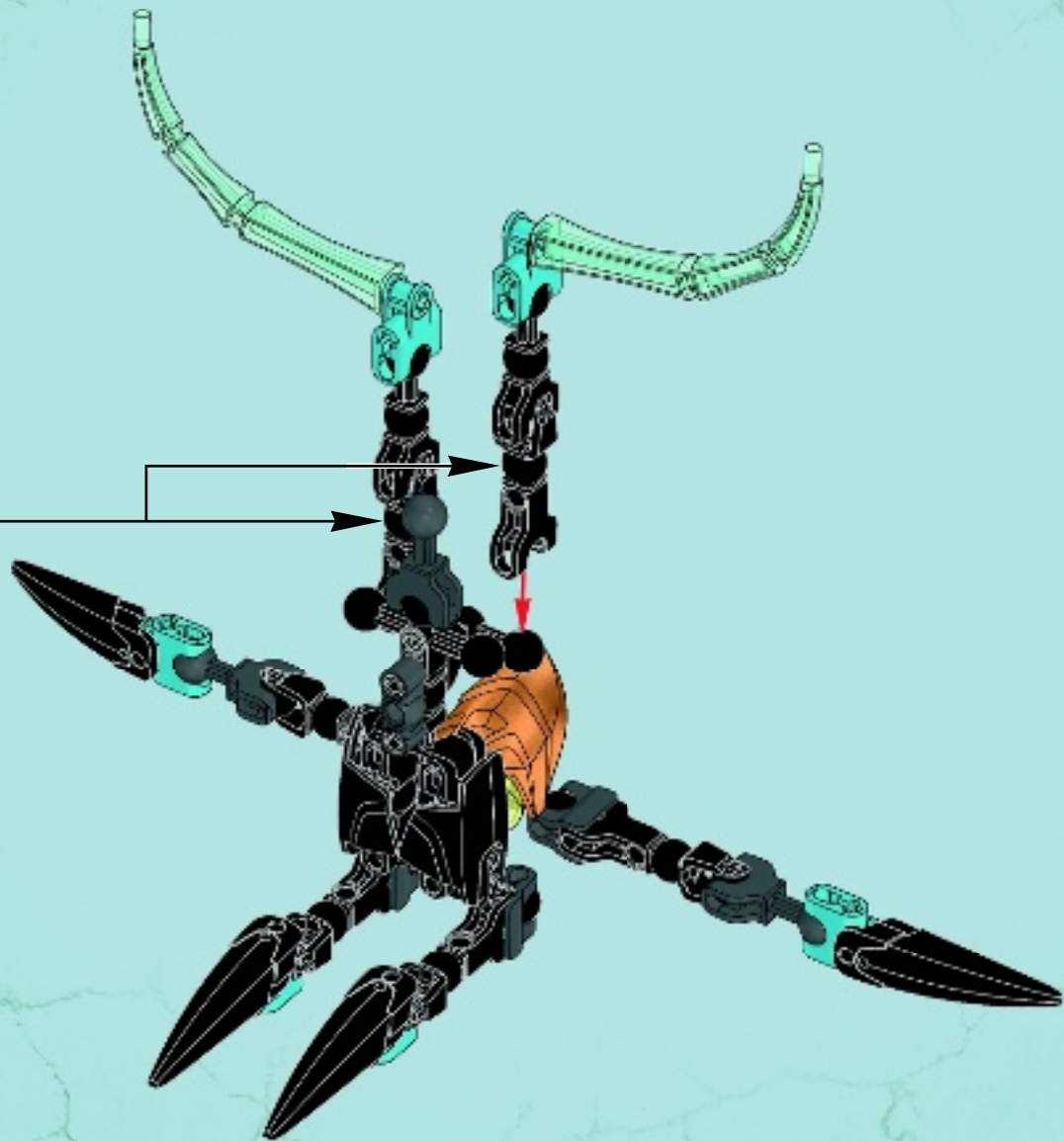

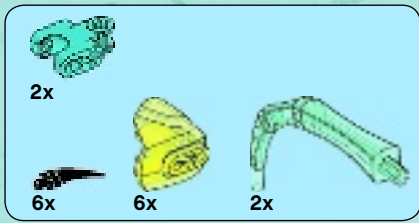

# 11

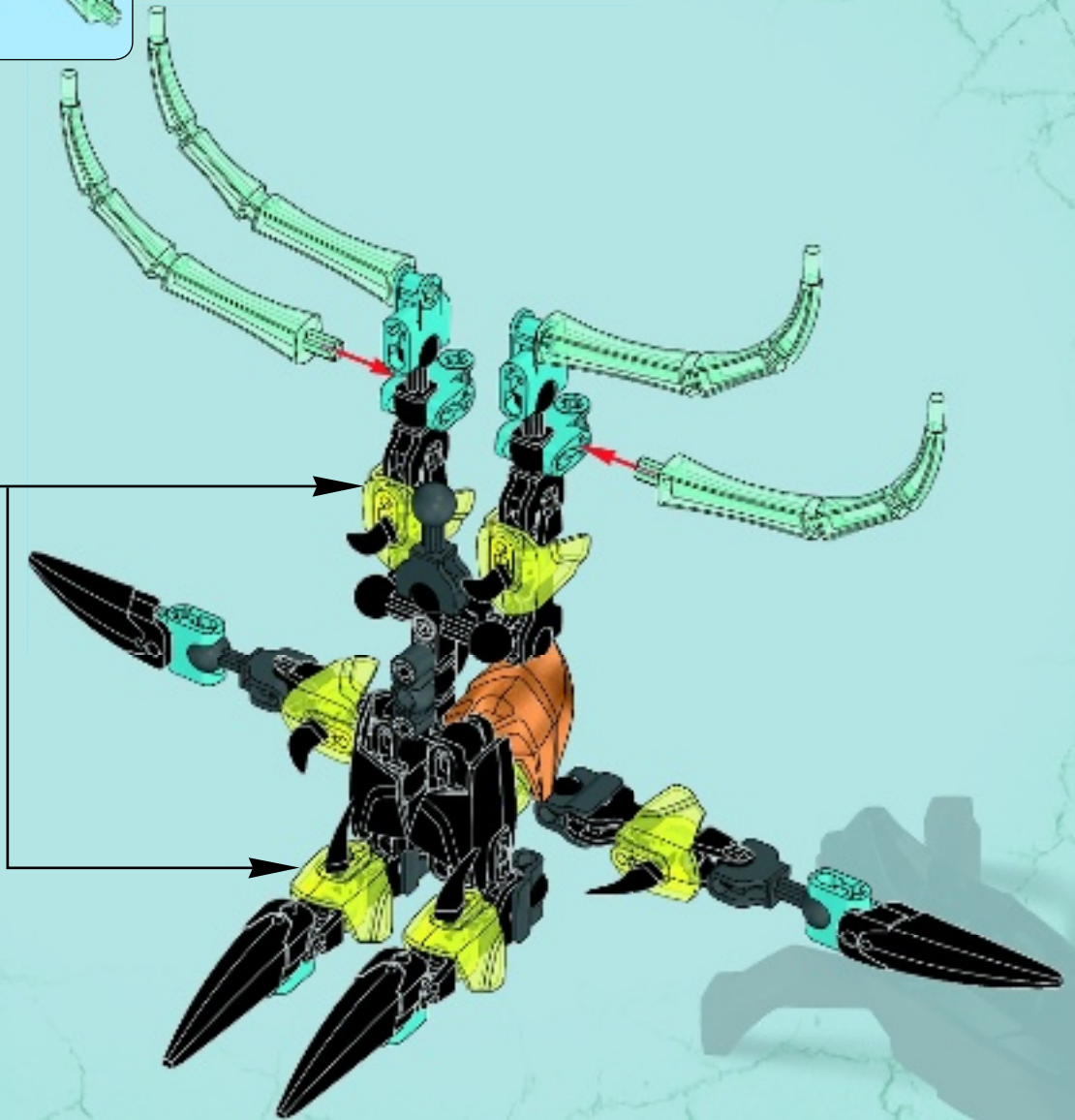
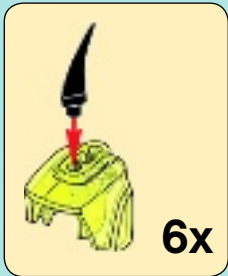

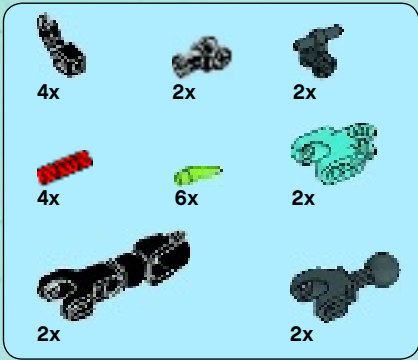

# 12

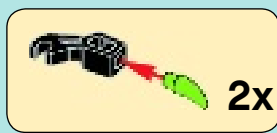
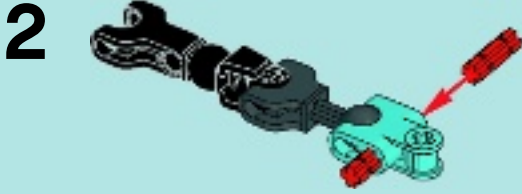

2x



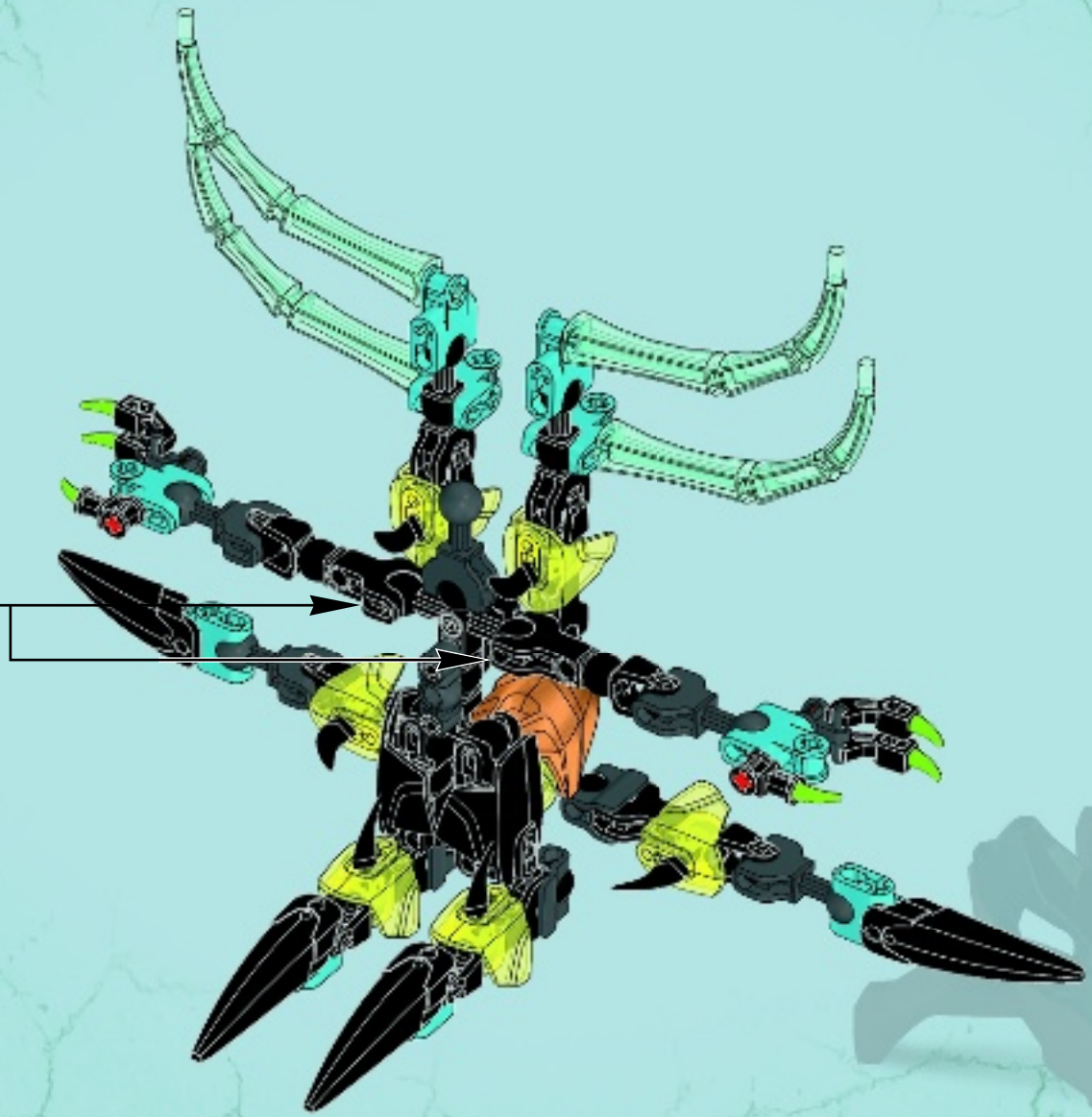



2x

13

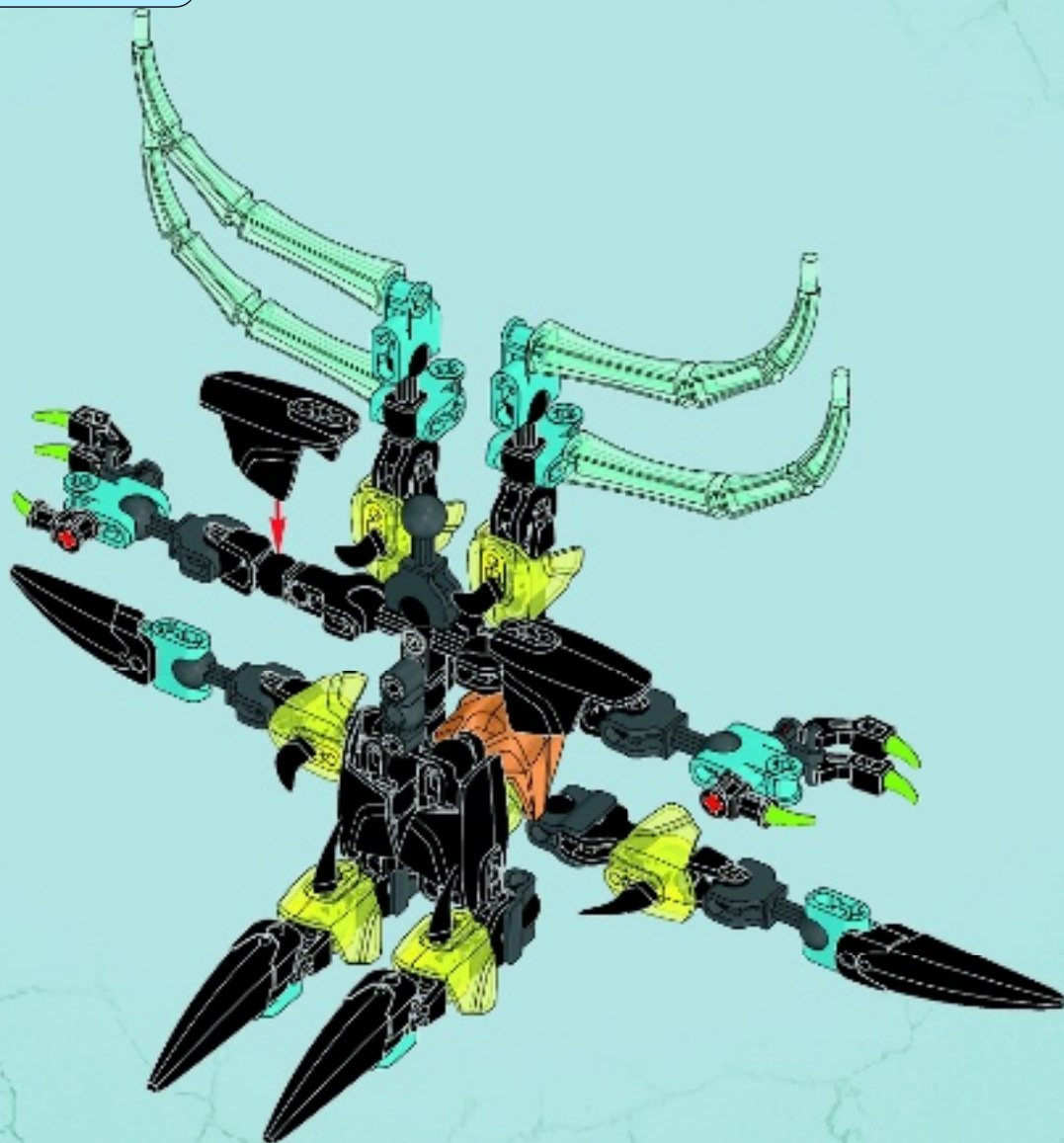

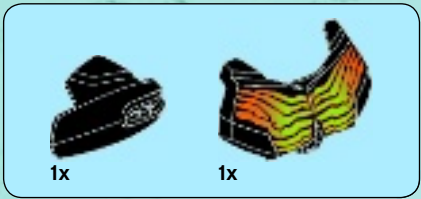

# 14

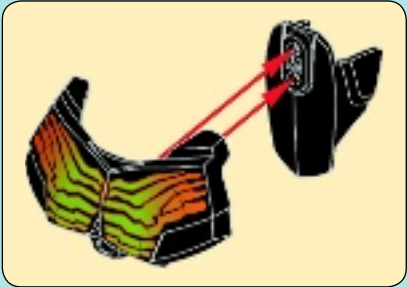

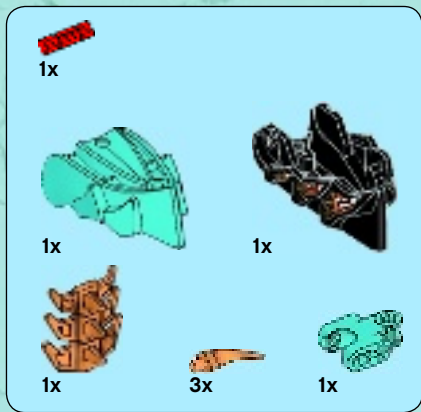

1



15

2

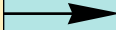
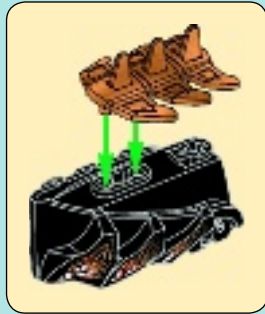

3

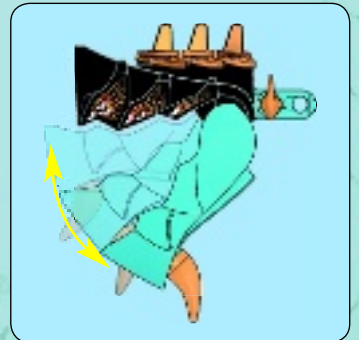
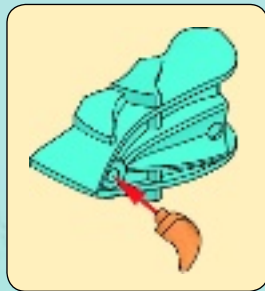

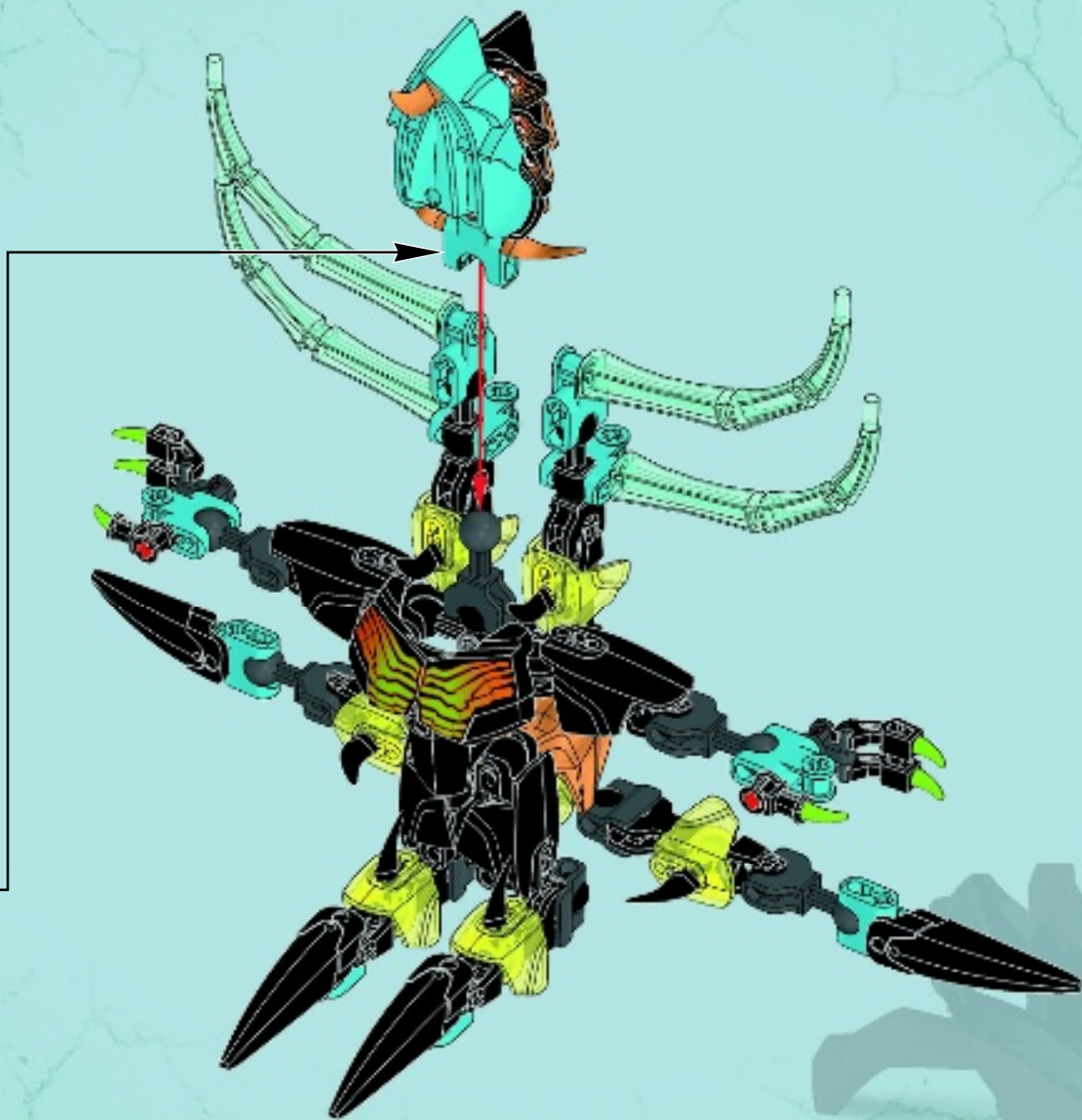

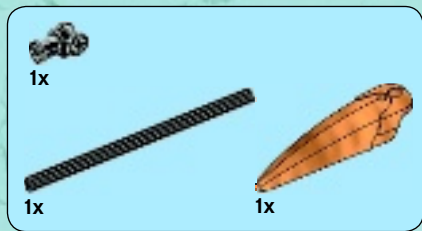

# 16

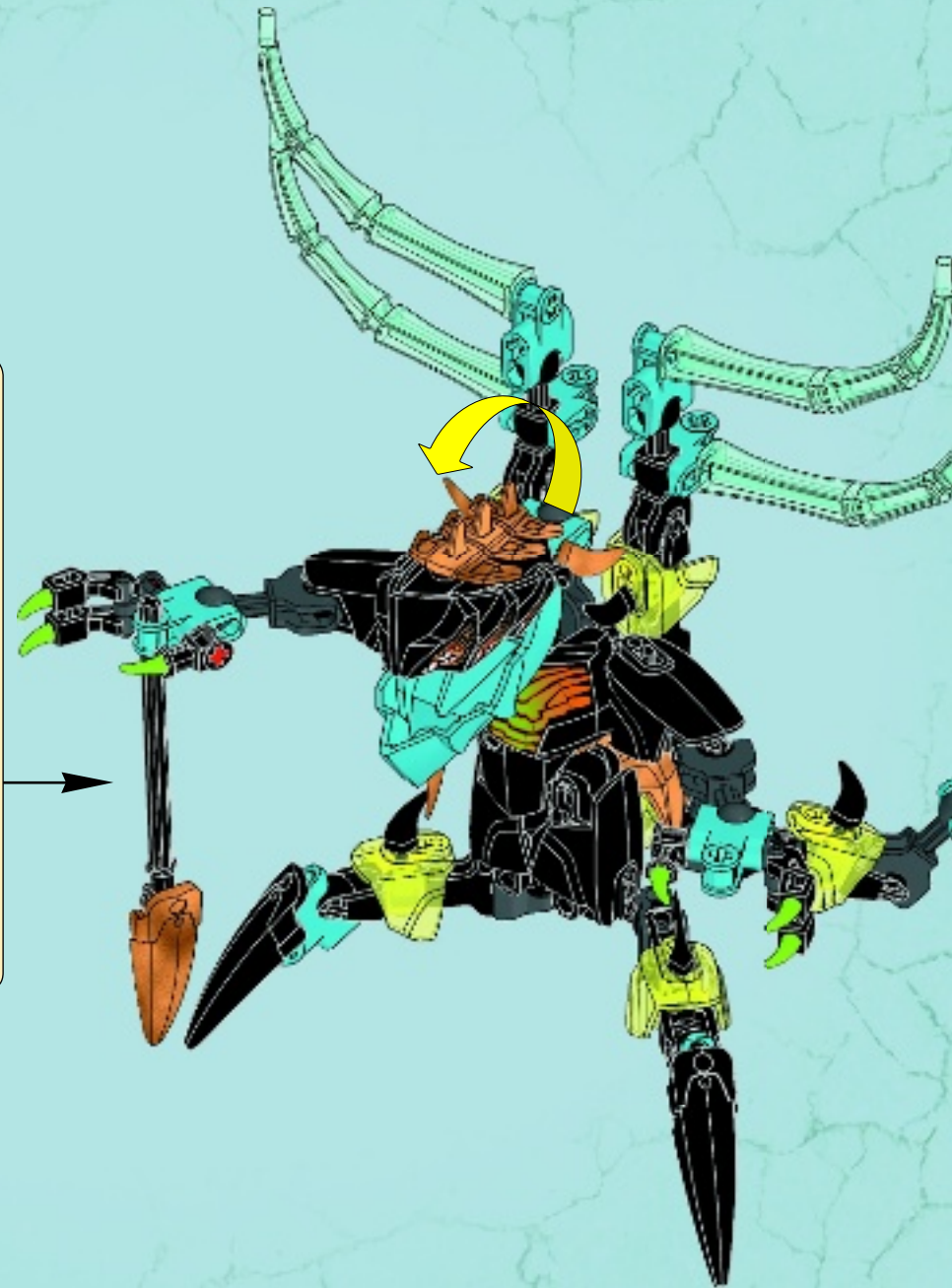
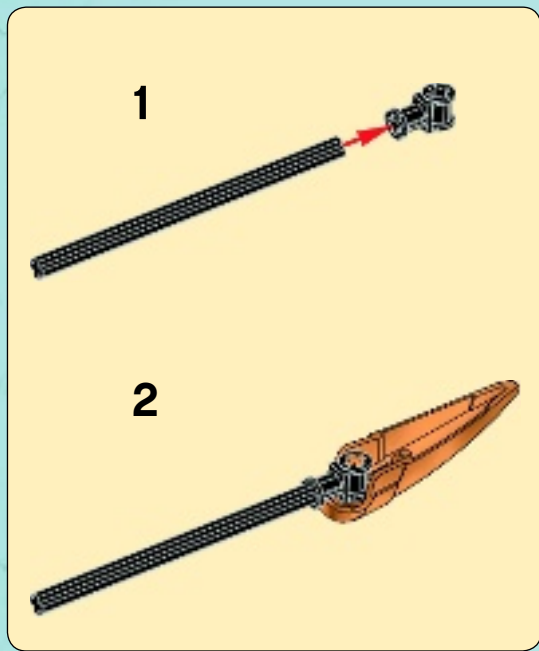

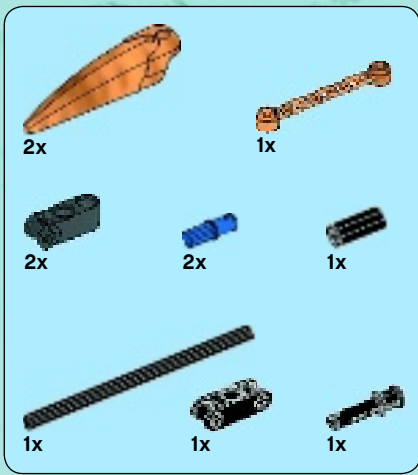

17

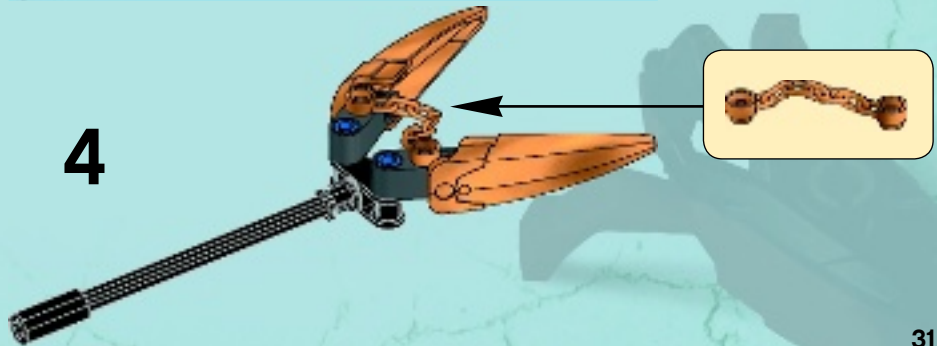
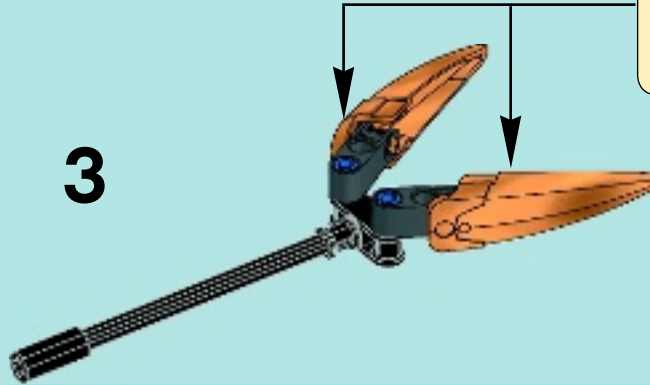
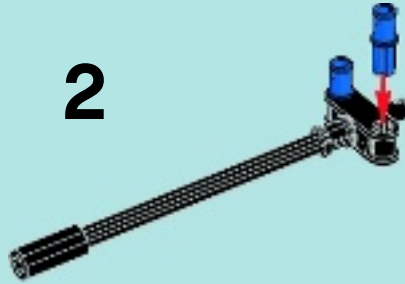
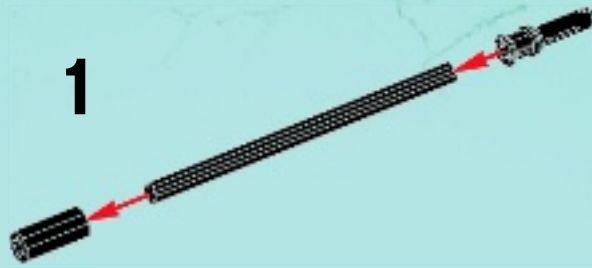







18

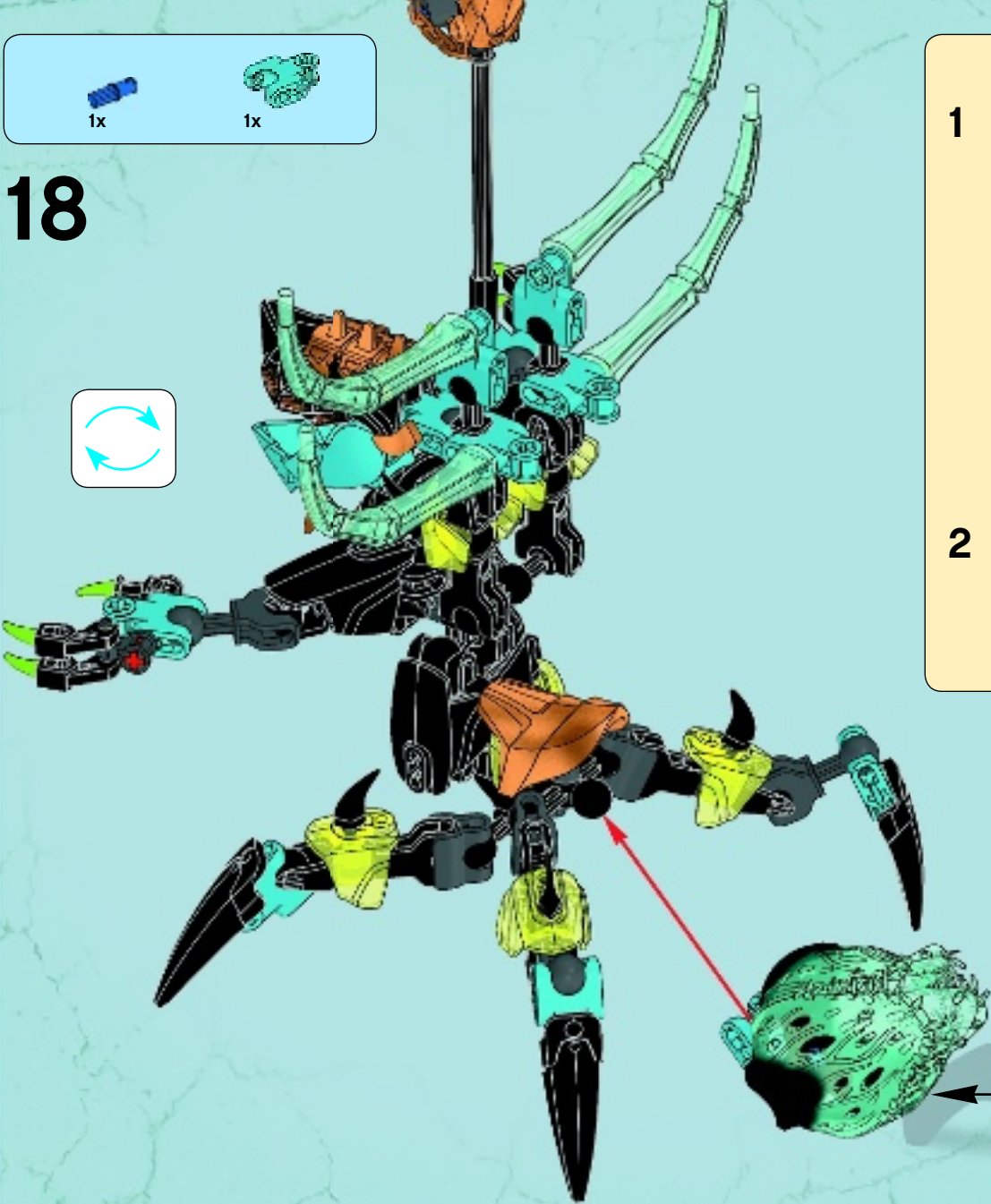

19





Customer Service

Kundenservice

Service Consommateurs

Servicio Al Consumidor

LEGO.com/service or dial



: 00800 5346 5555

: 1-800-422-5346





A laptop computer is shown in the upper right corner of the image, displaying the URL "LEGO.com/heroFactory/bi" on its screen. The laptop is open and appears to be on a desk in a dimly lit room with stone walls.

44024

+

44026

+

44029





44023

44023

+

44025

+

44027