



PIRATES of the CARIBBEAN

ON STRANGER TIDES



4195



1

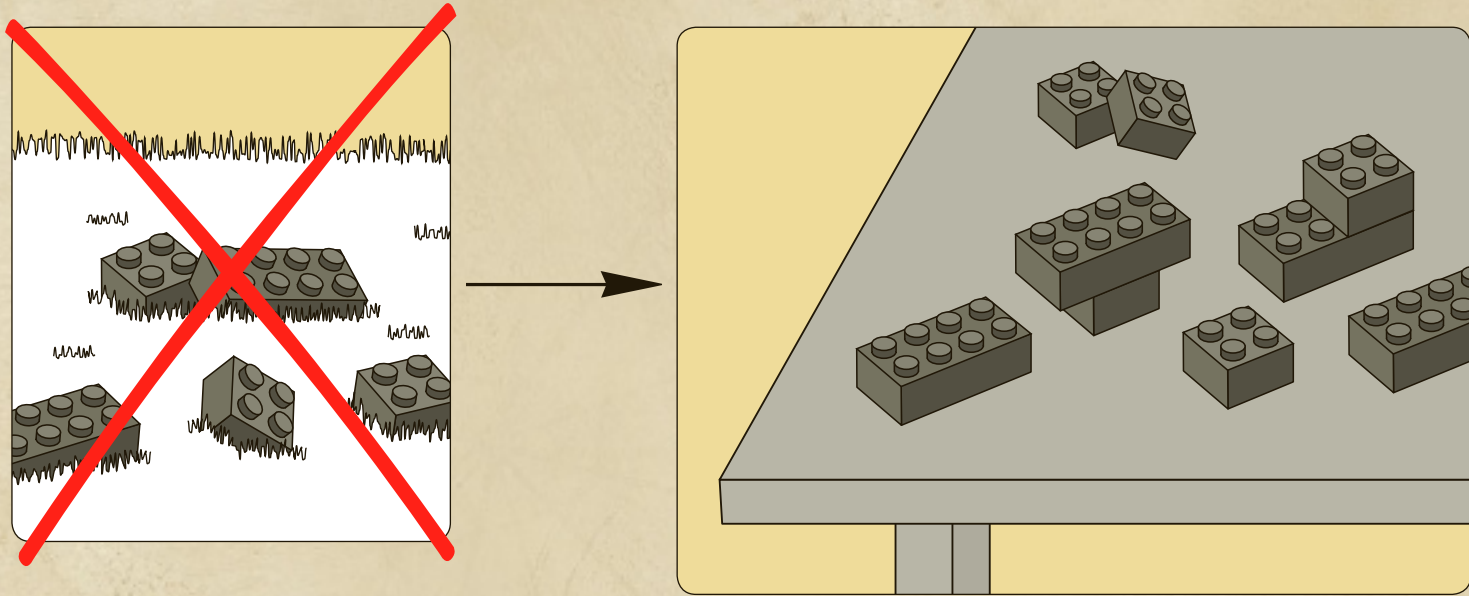

2

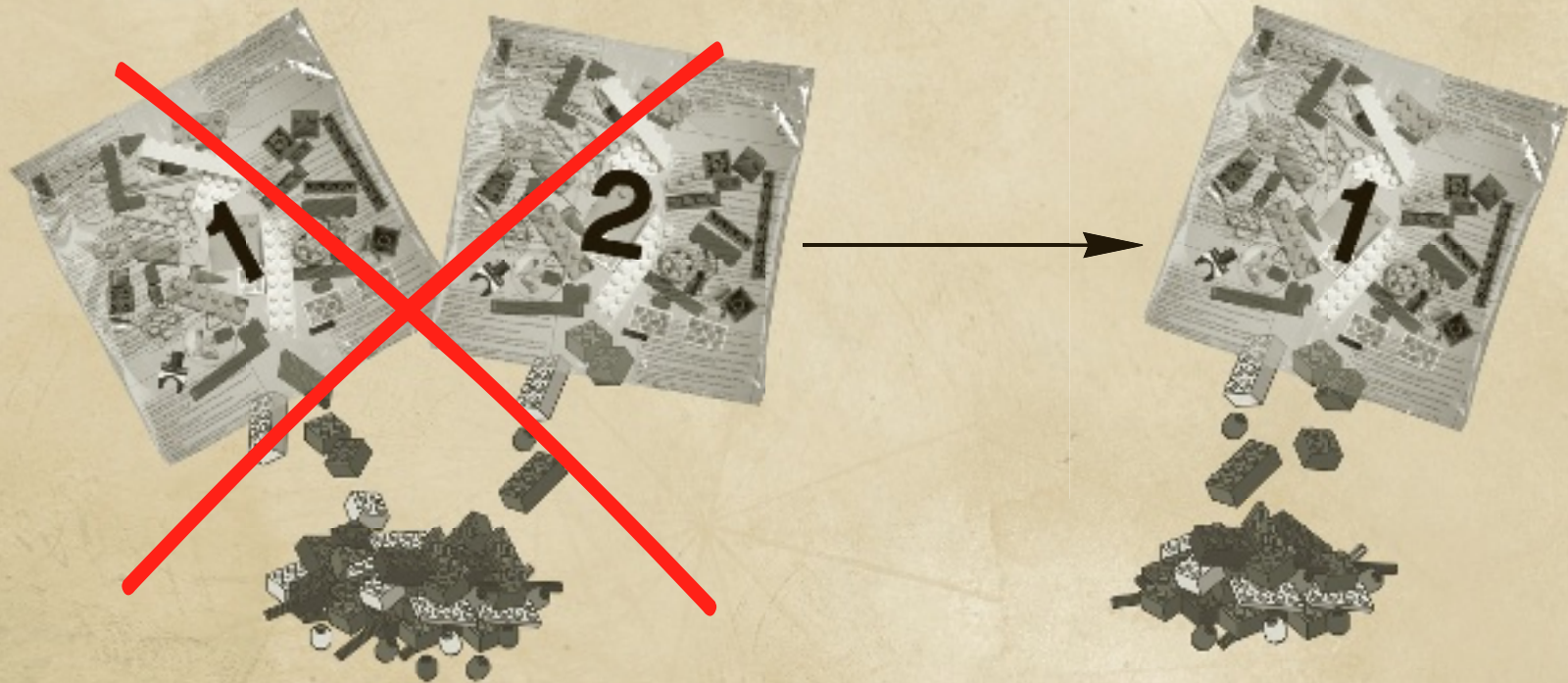



3





4

1



2

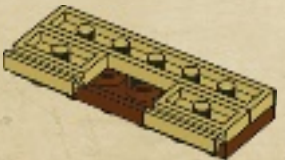

3

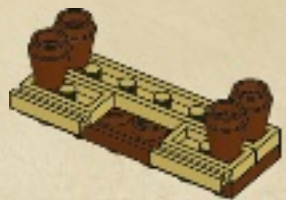

4

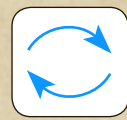

5



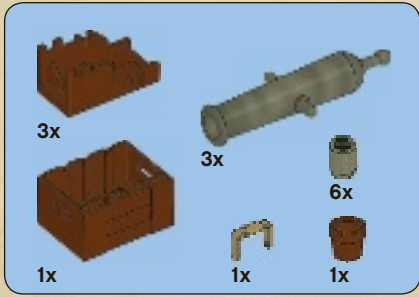
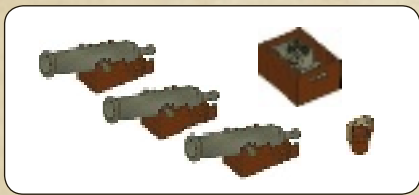

5

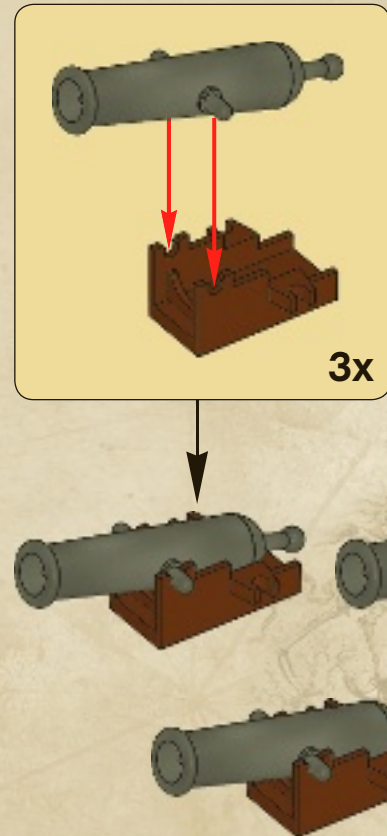
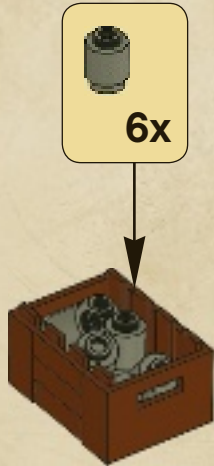

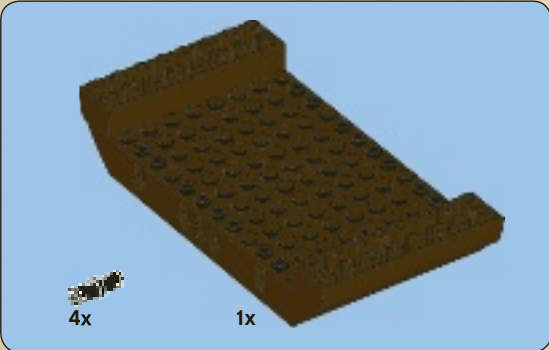
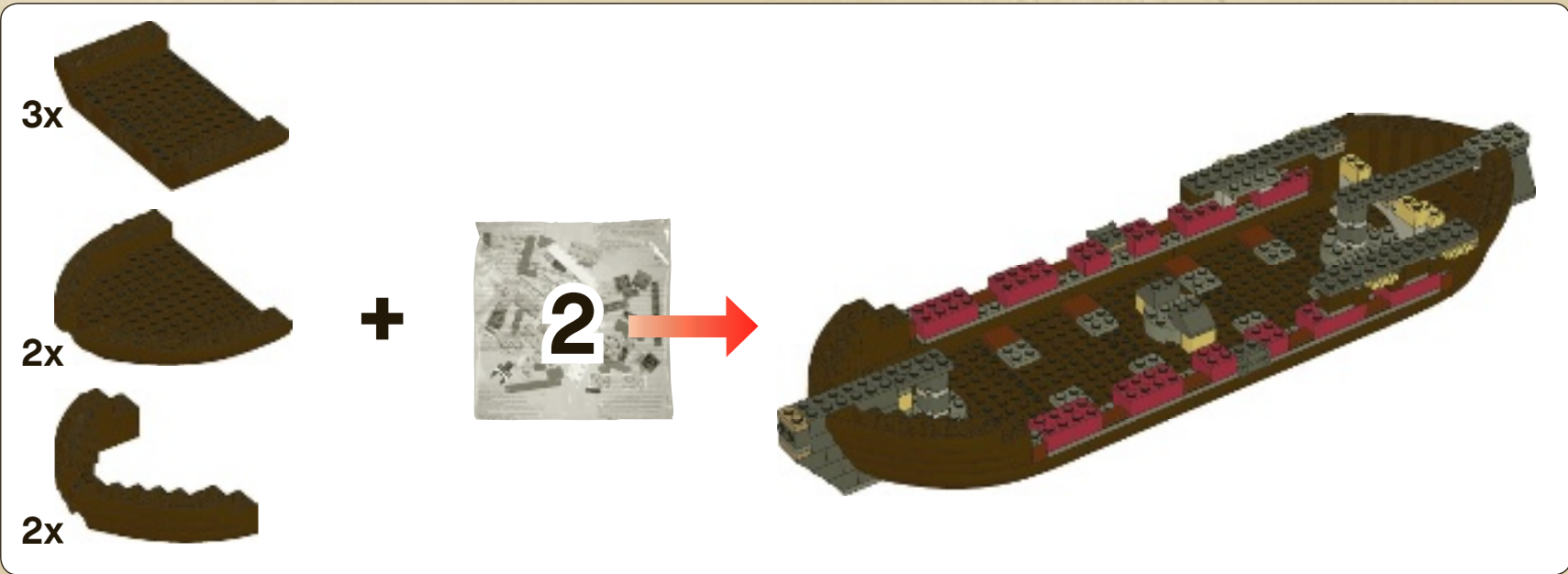

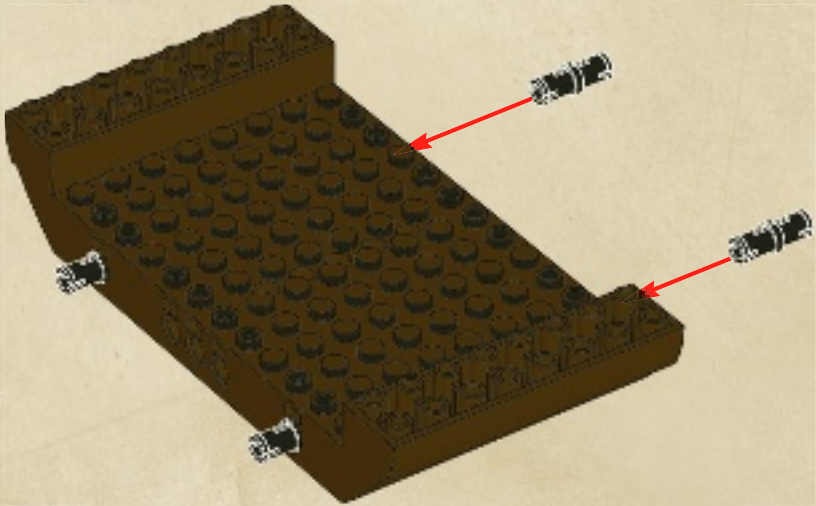

1

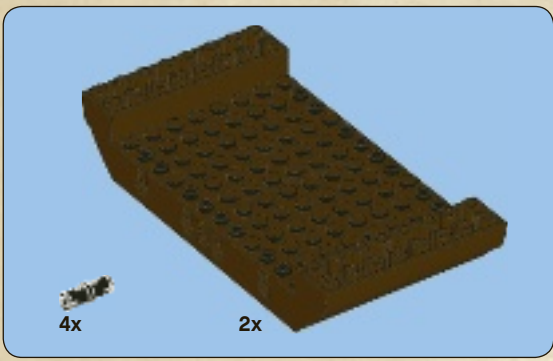

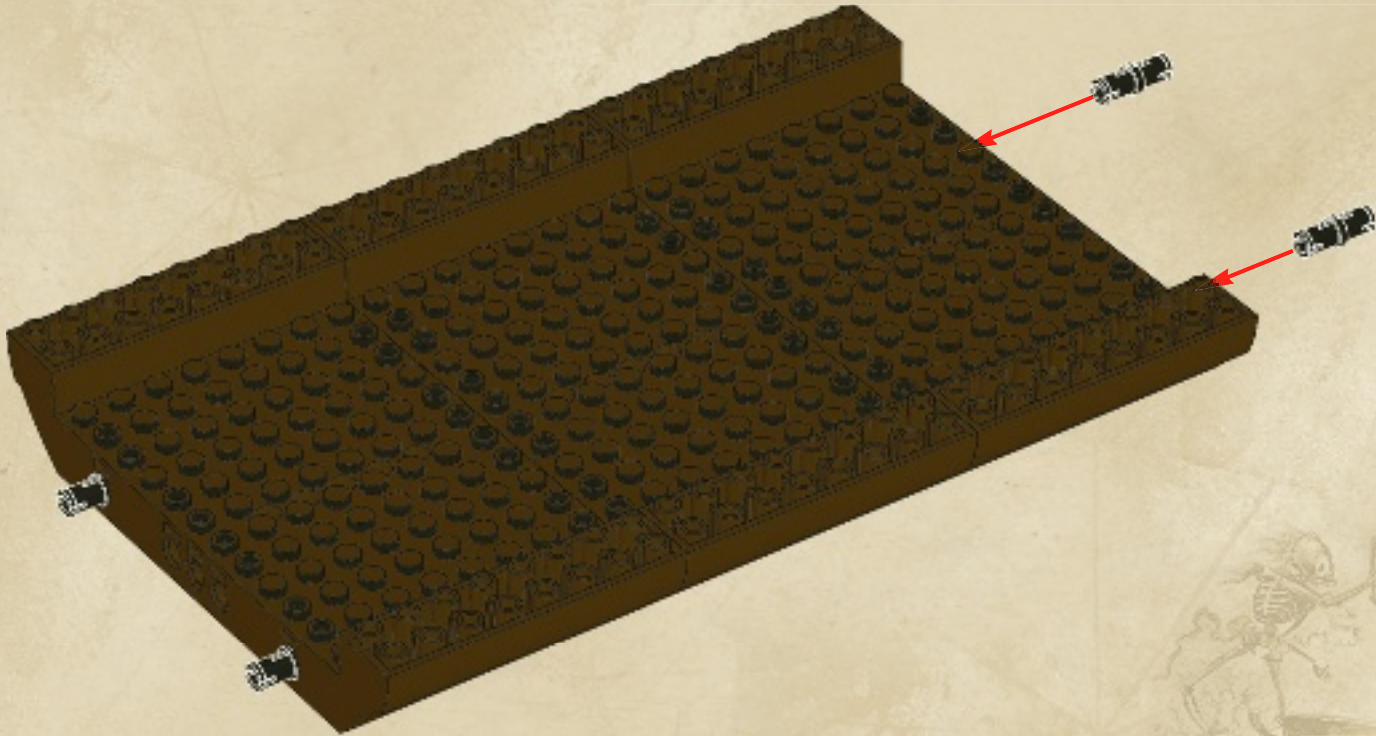

2



8x  8x 

3

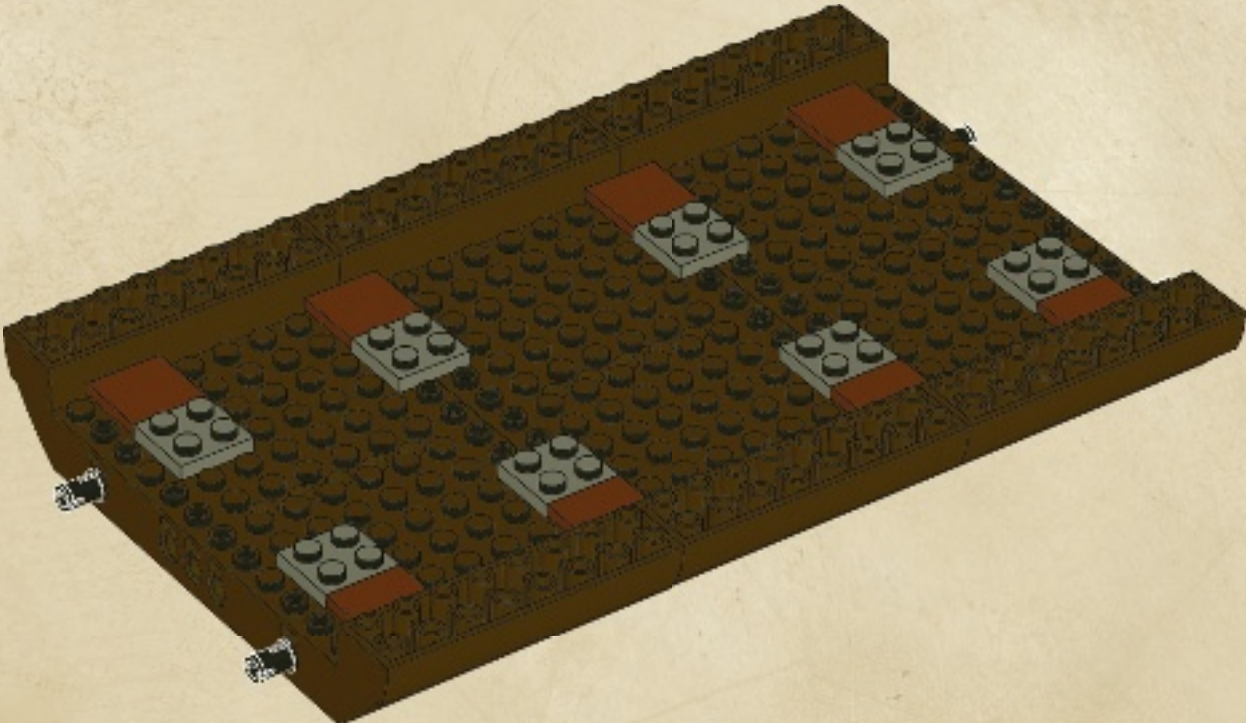

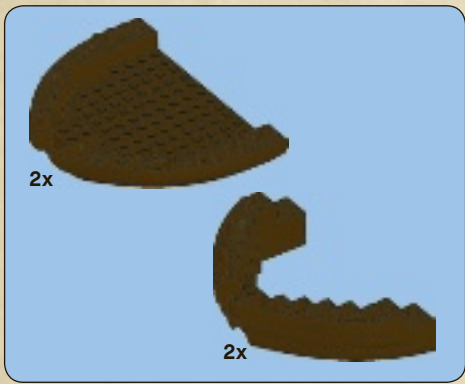

4

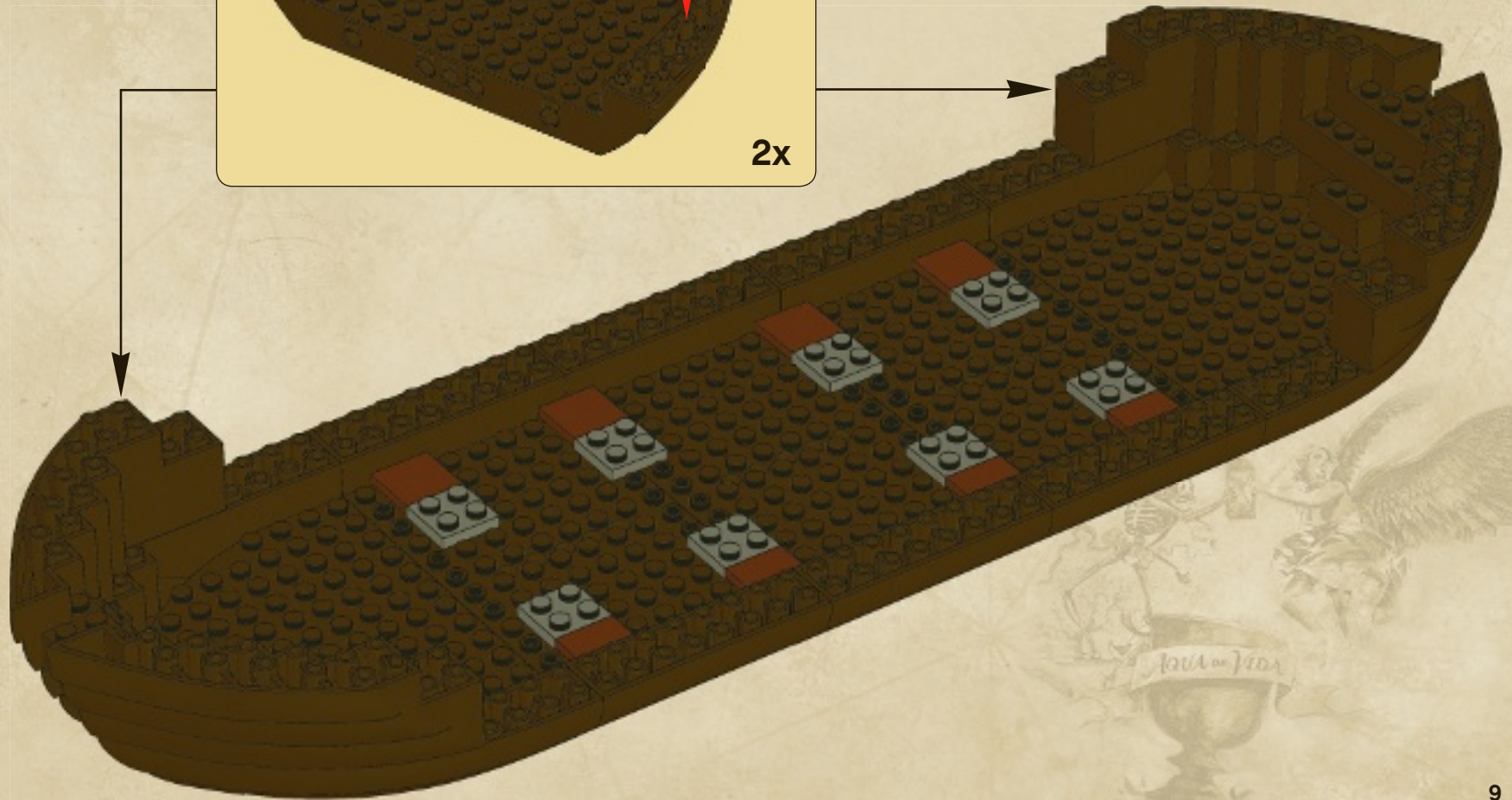
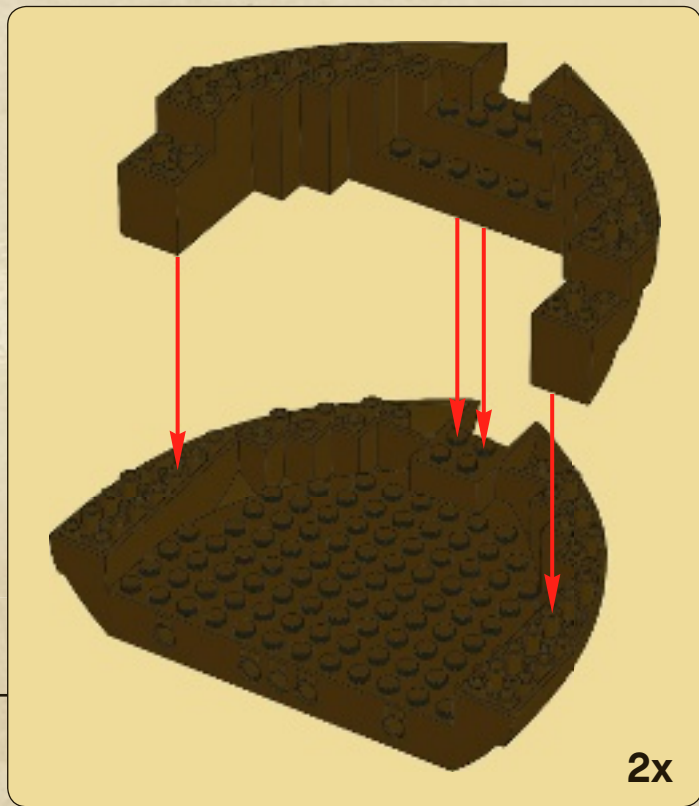

4x 4x

5

4x

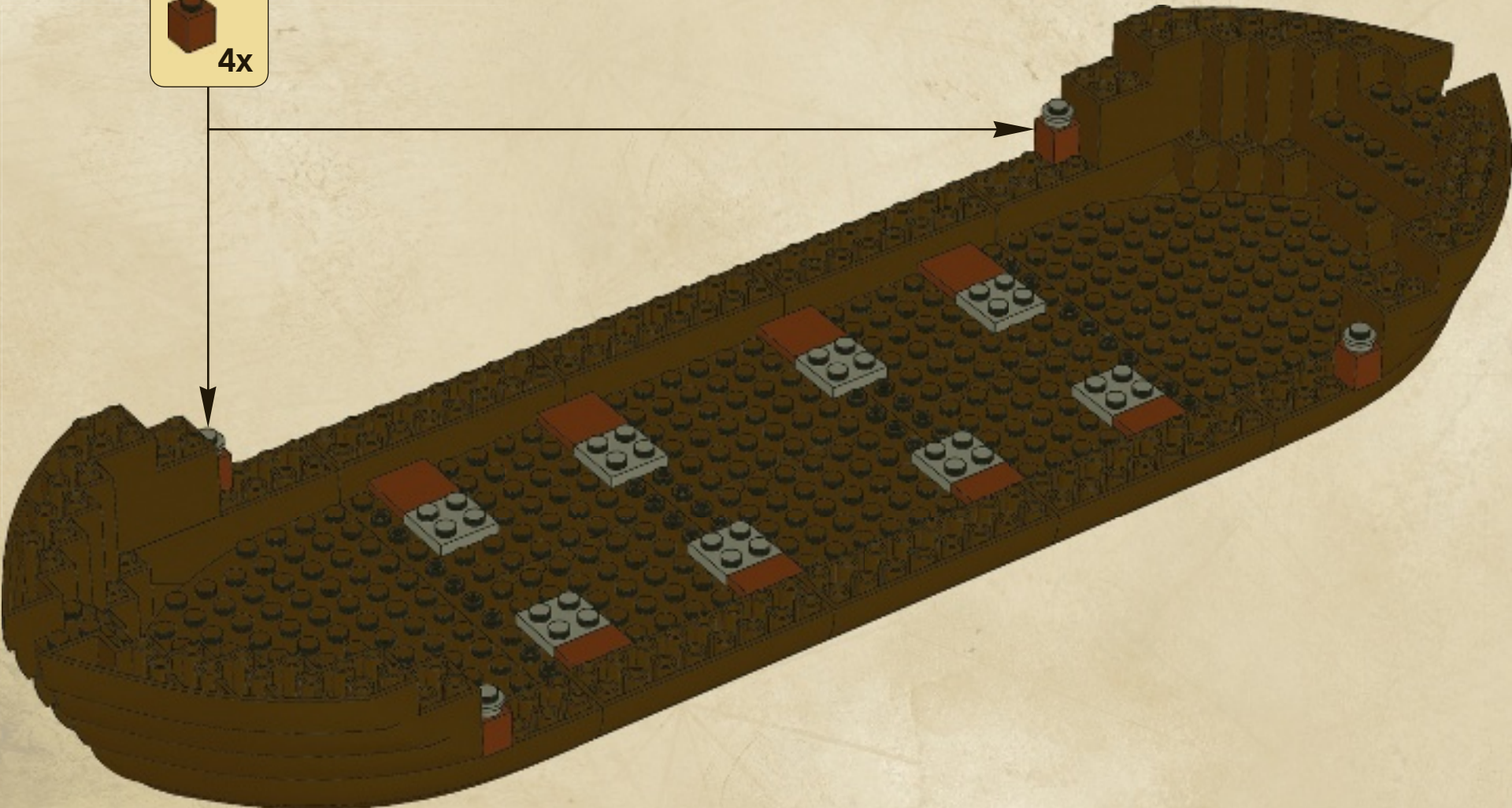

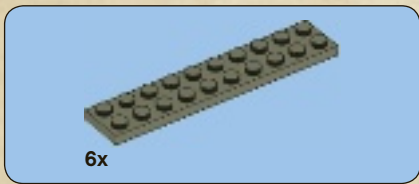

6

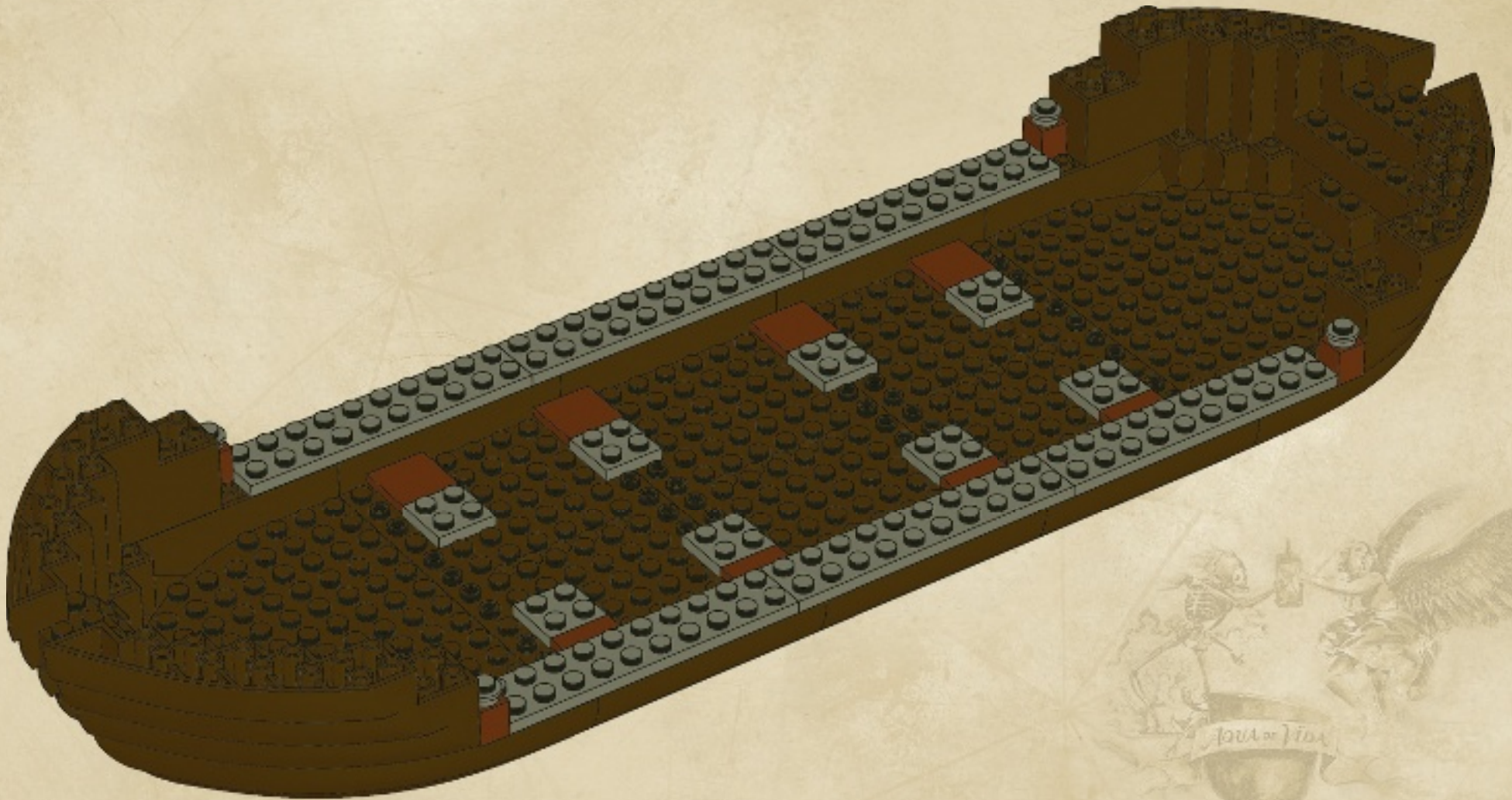



7

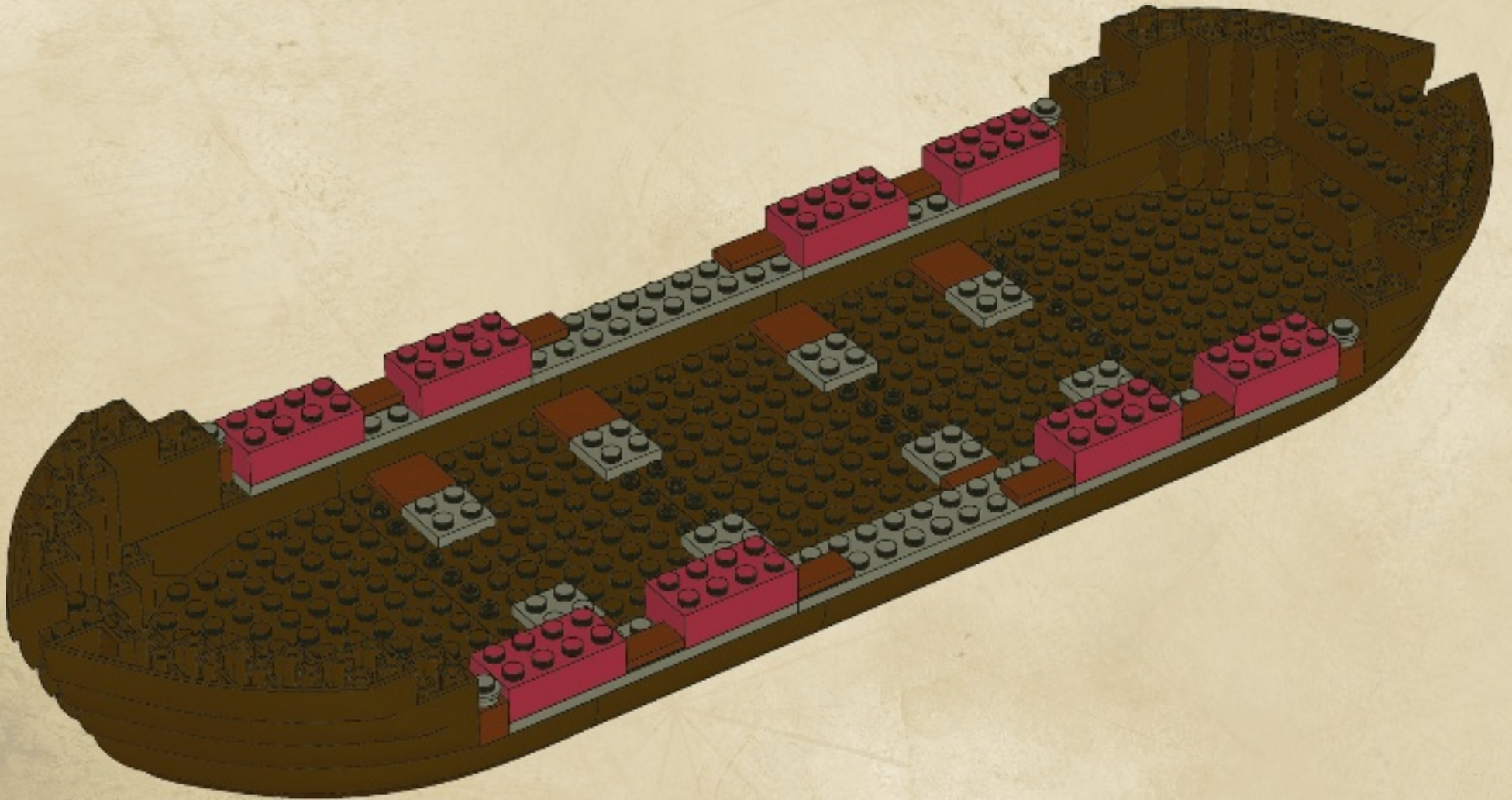



8

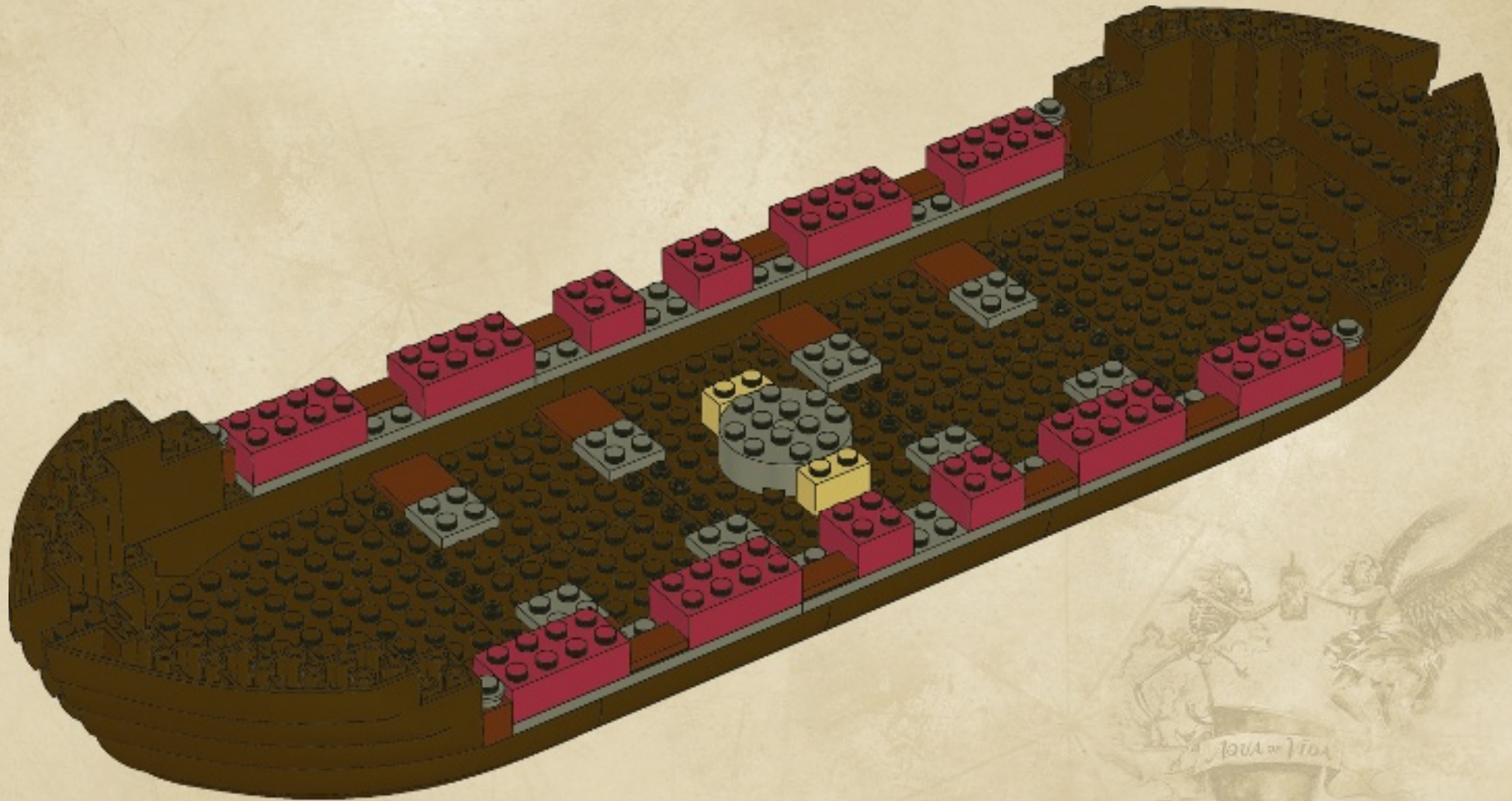

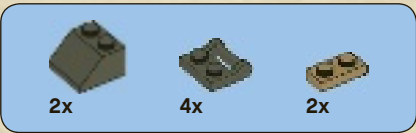

9

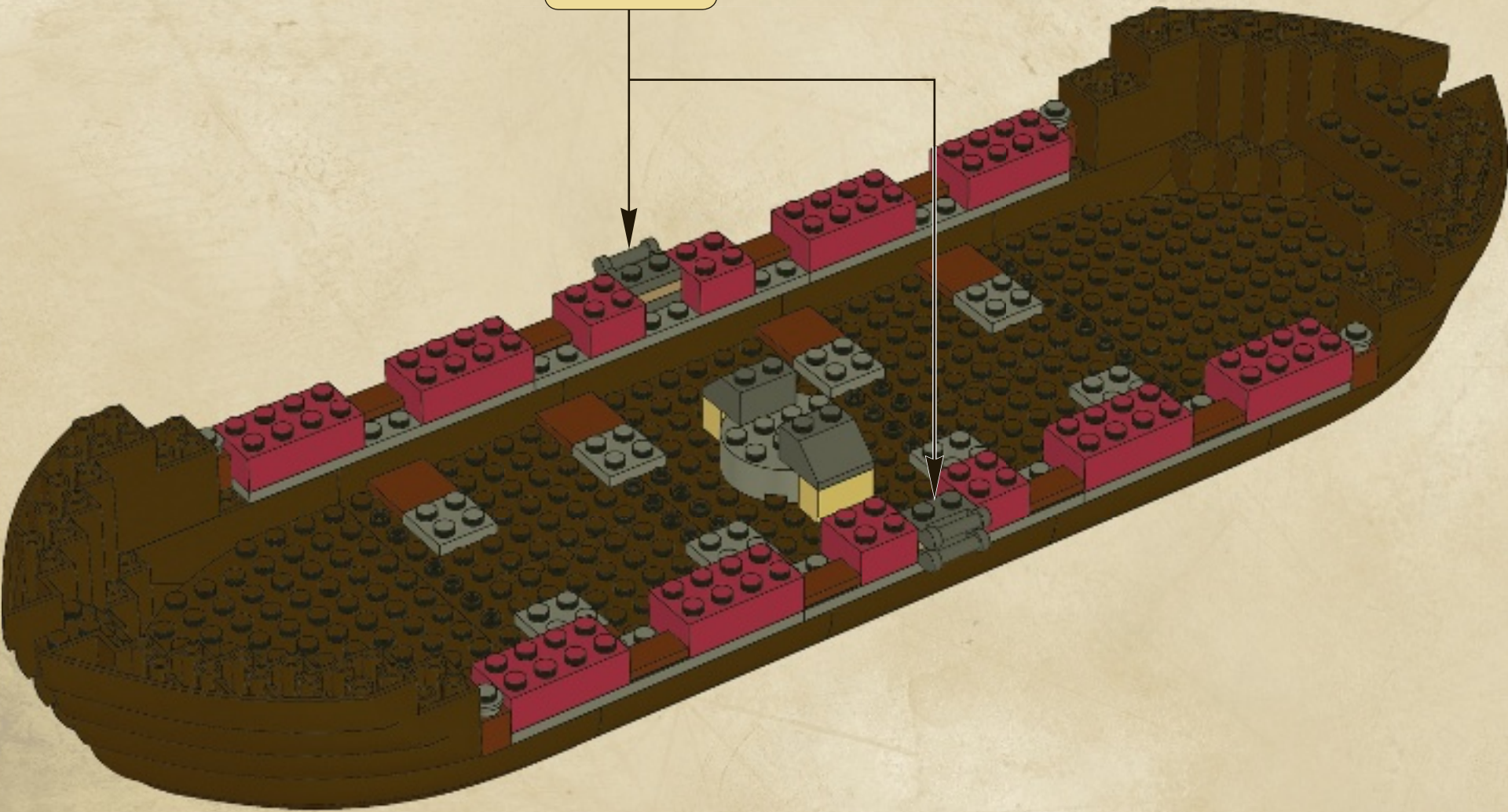
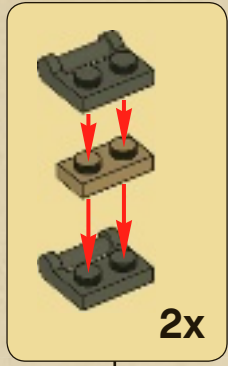



10

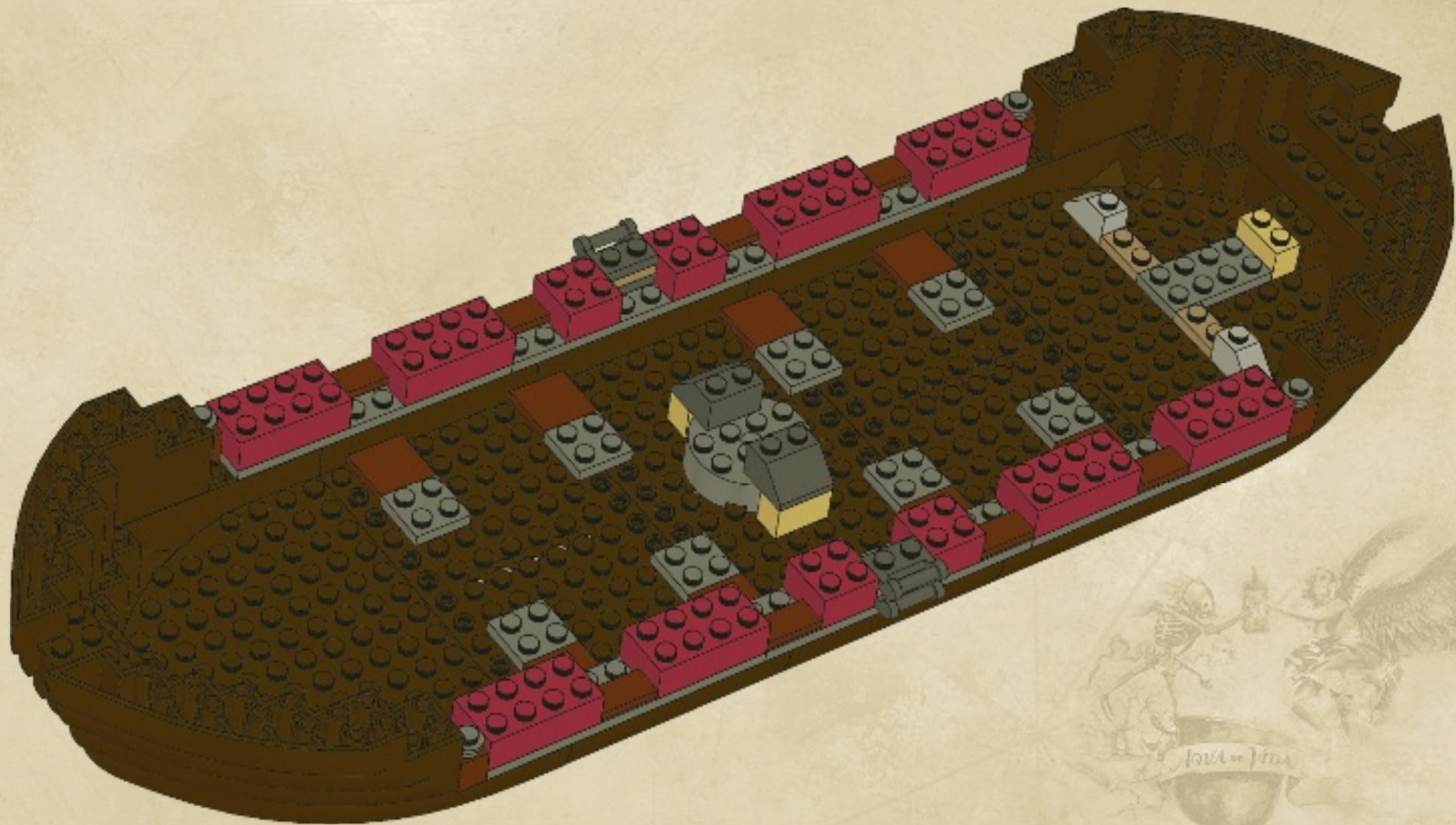

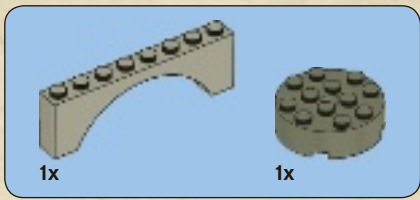

11

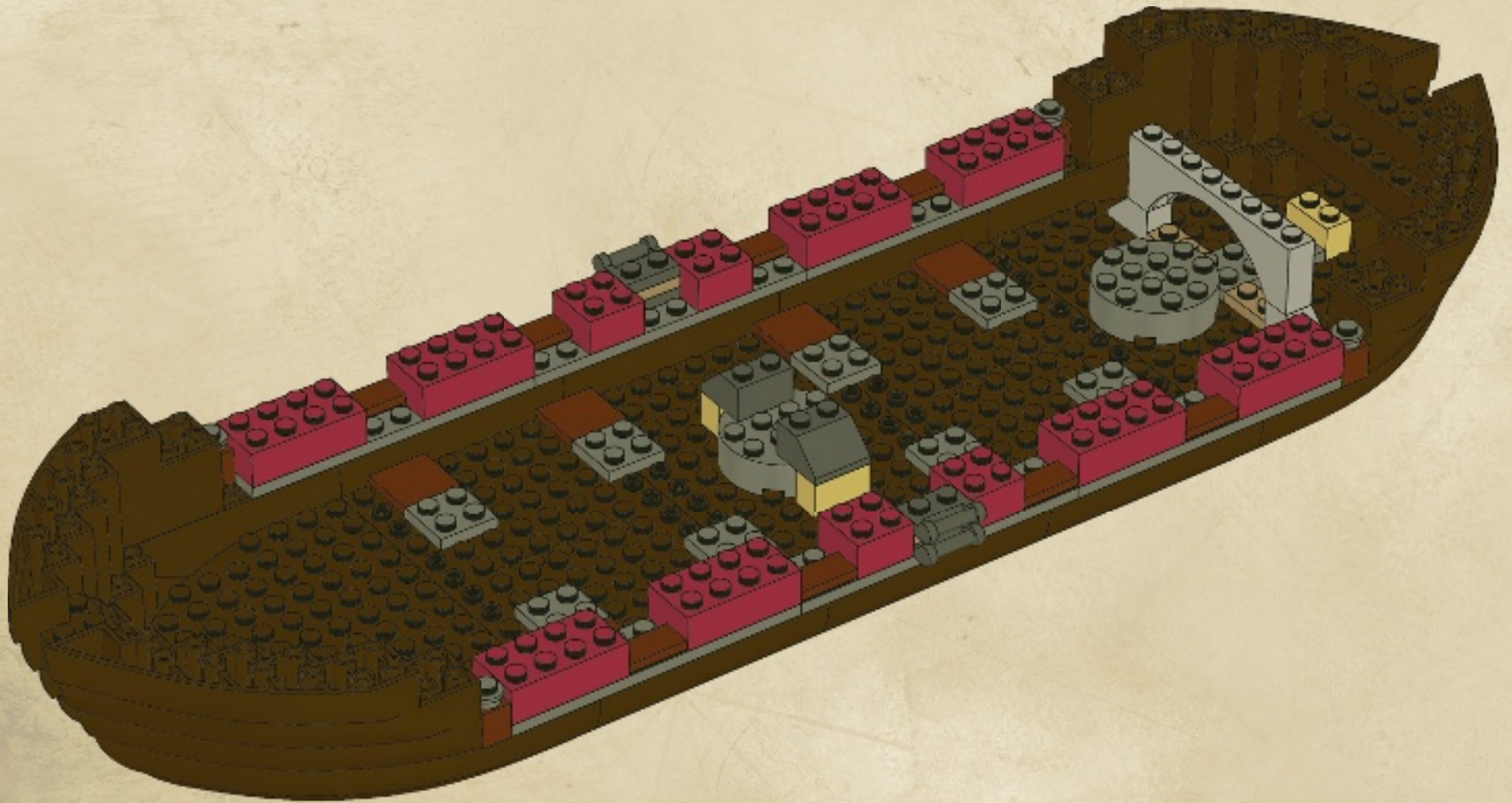

2x 1x 1x

12

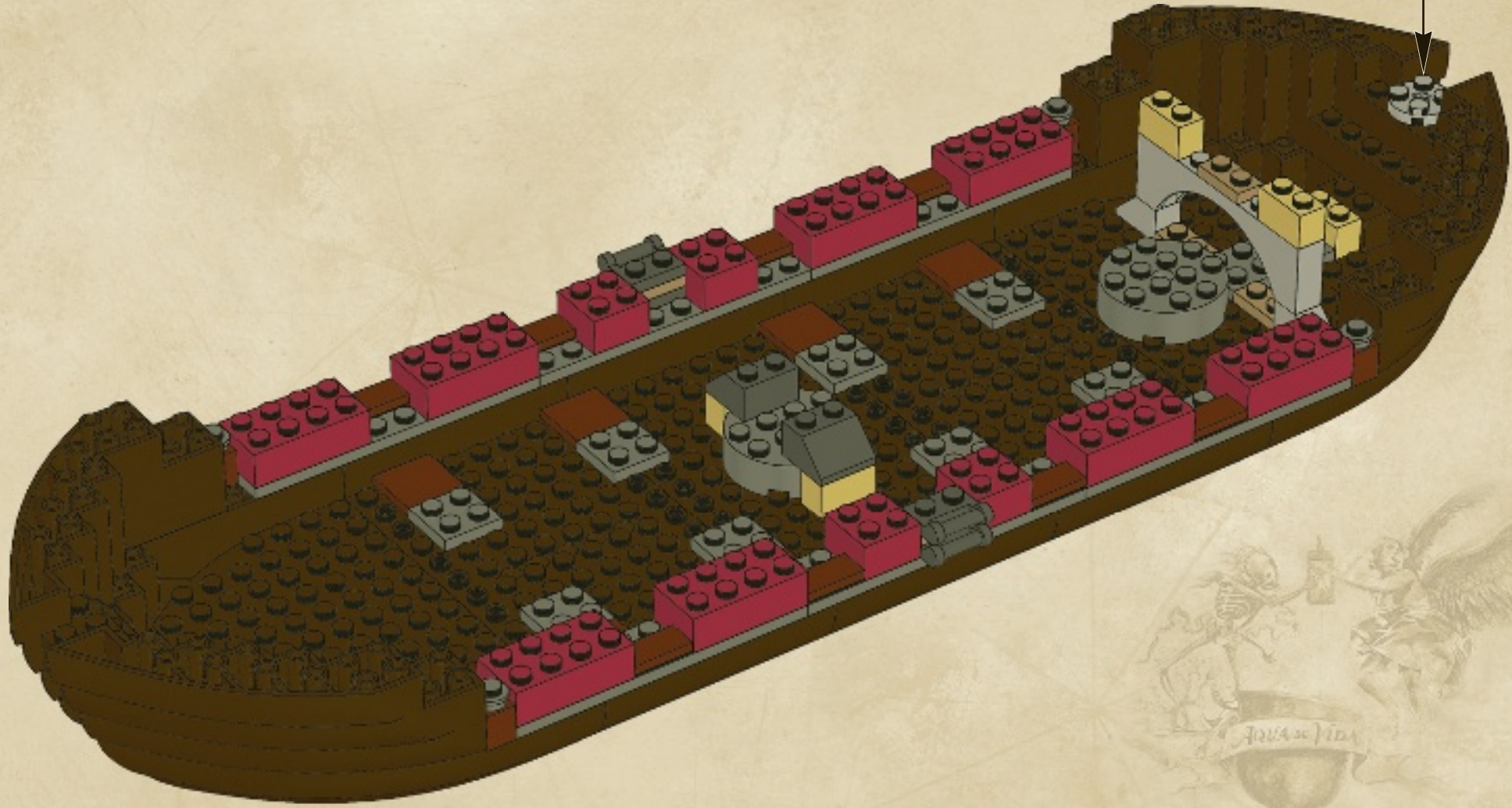

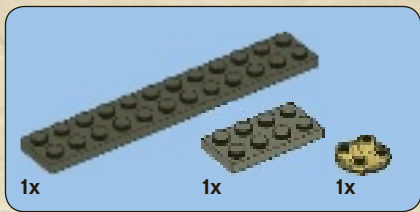

13

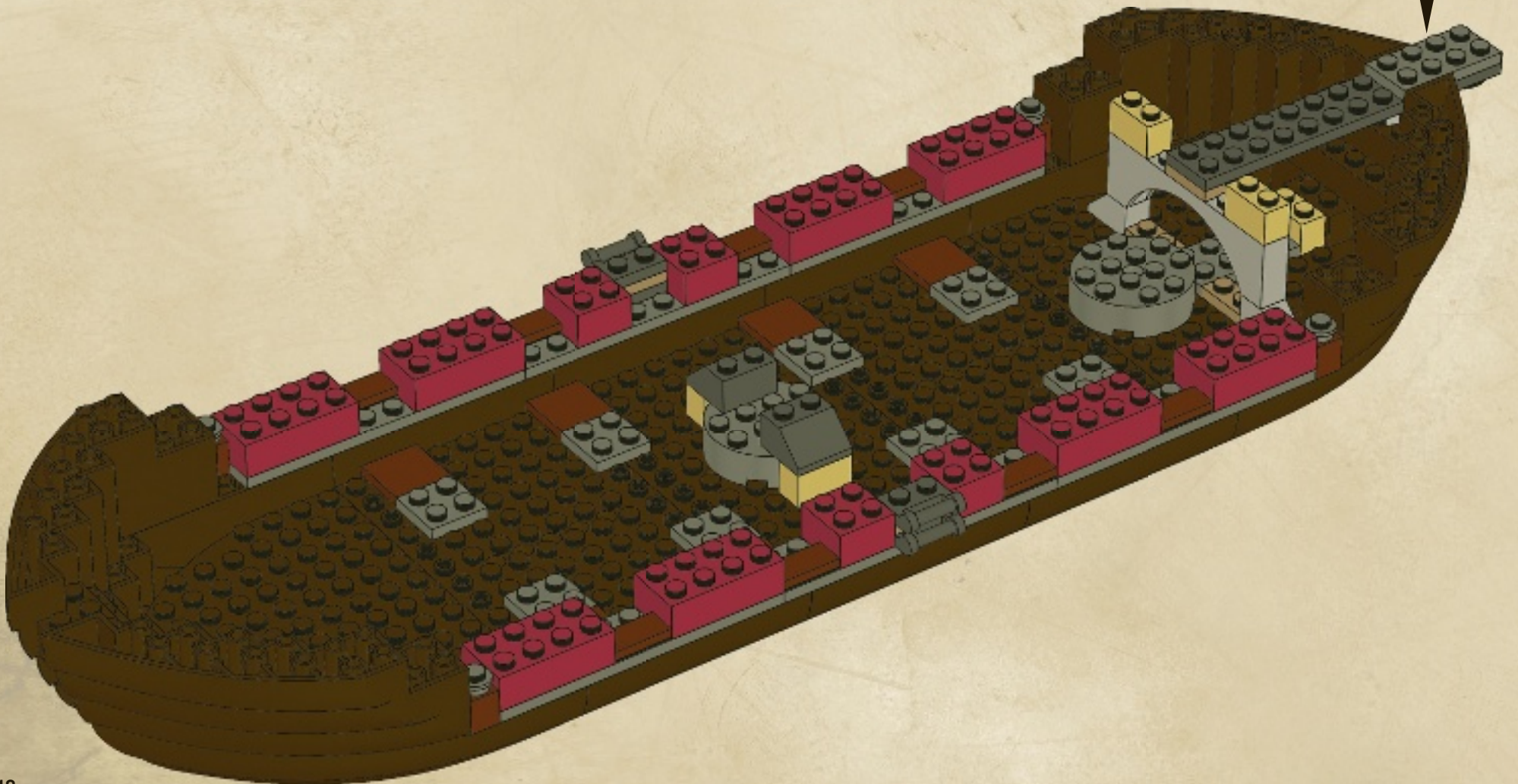
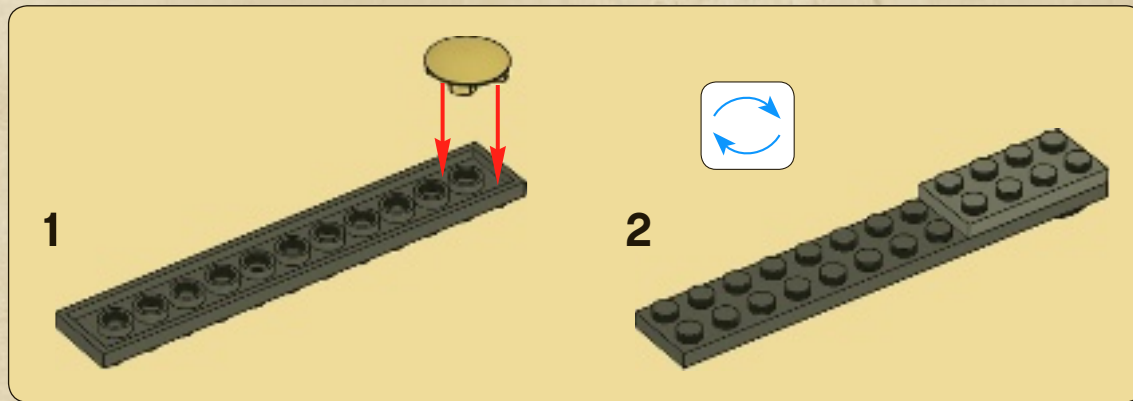

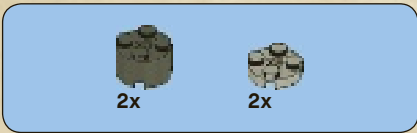

14

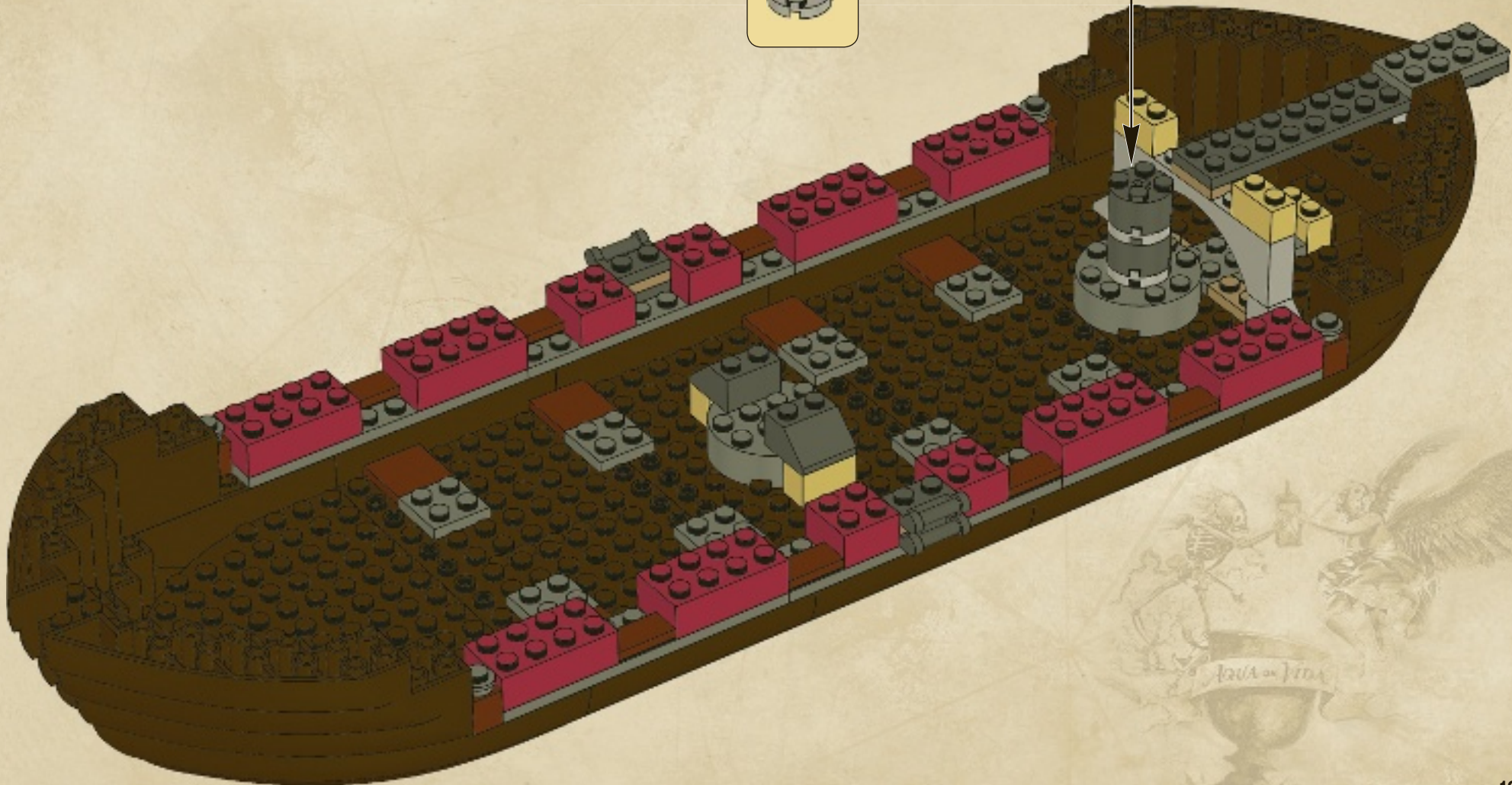
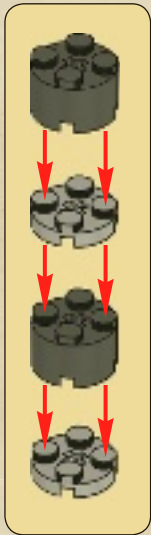



15

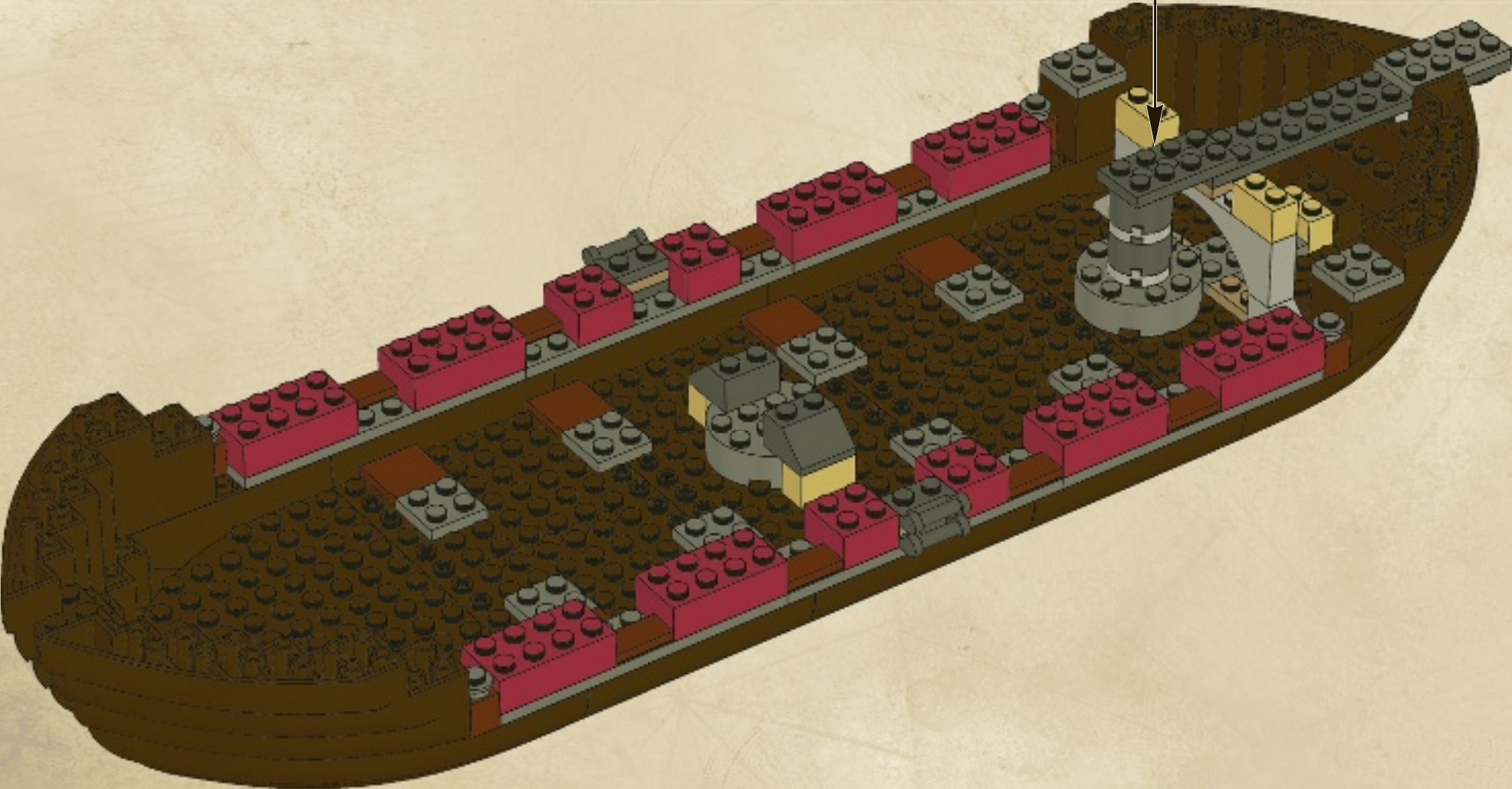

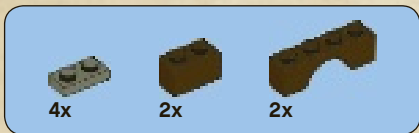

16

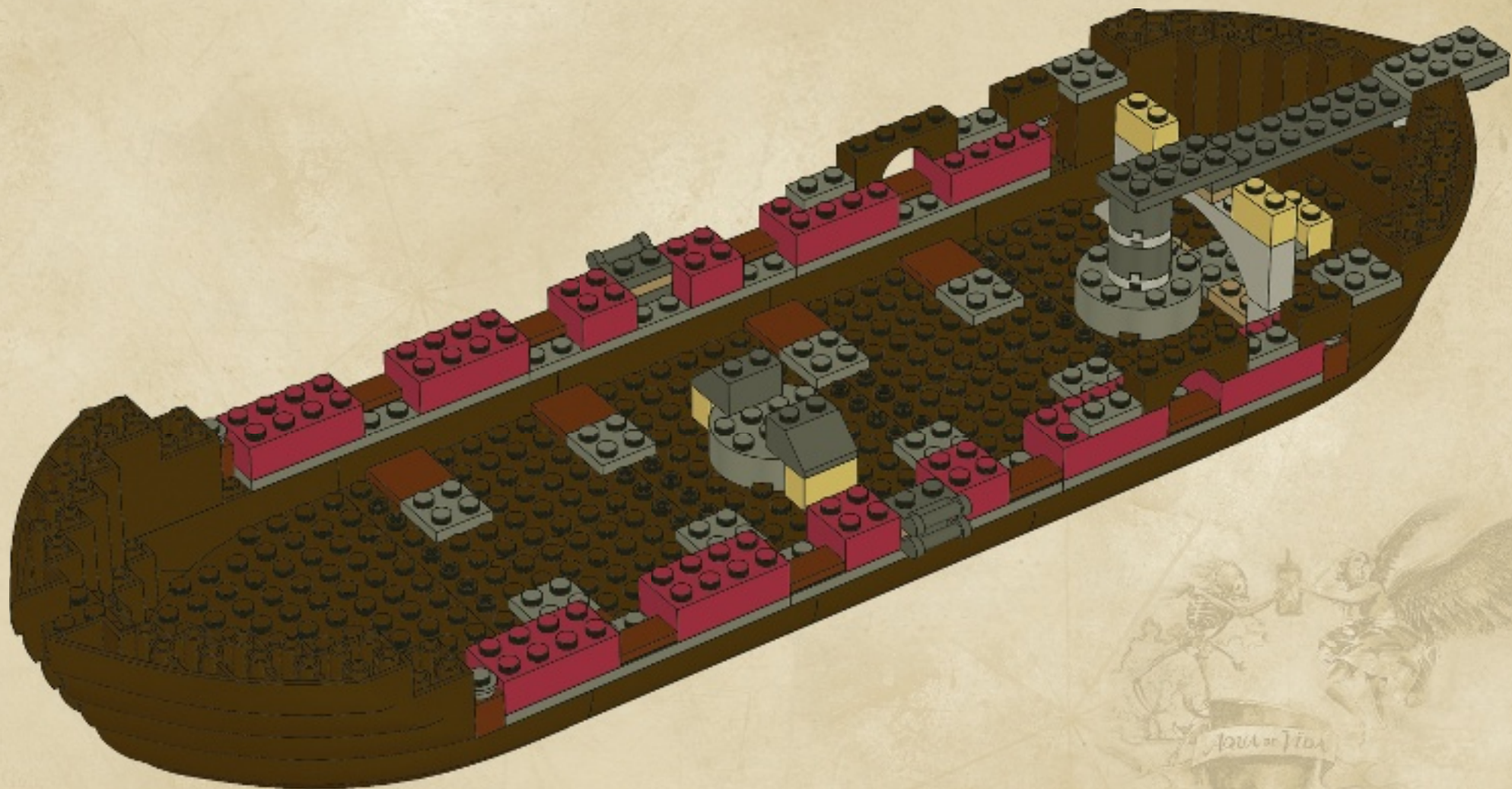



4x



4x

17

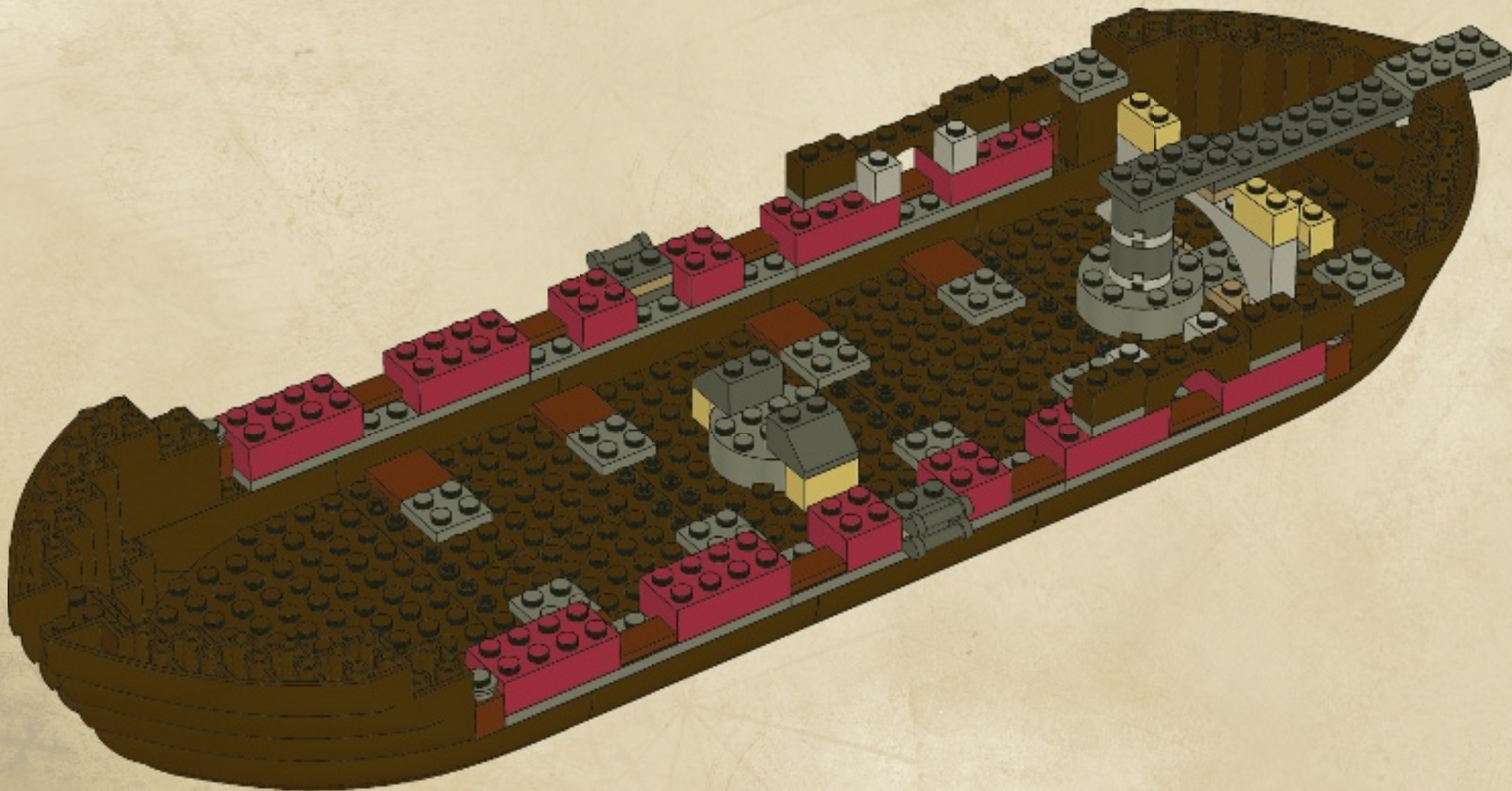

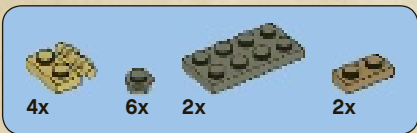

18

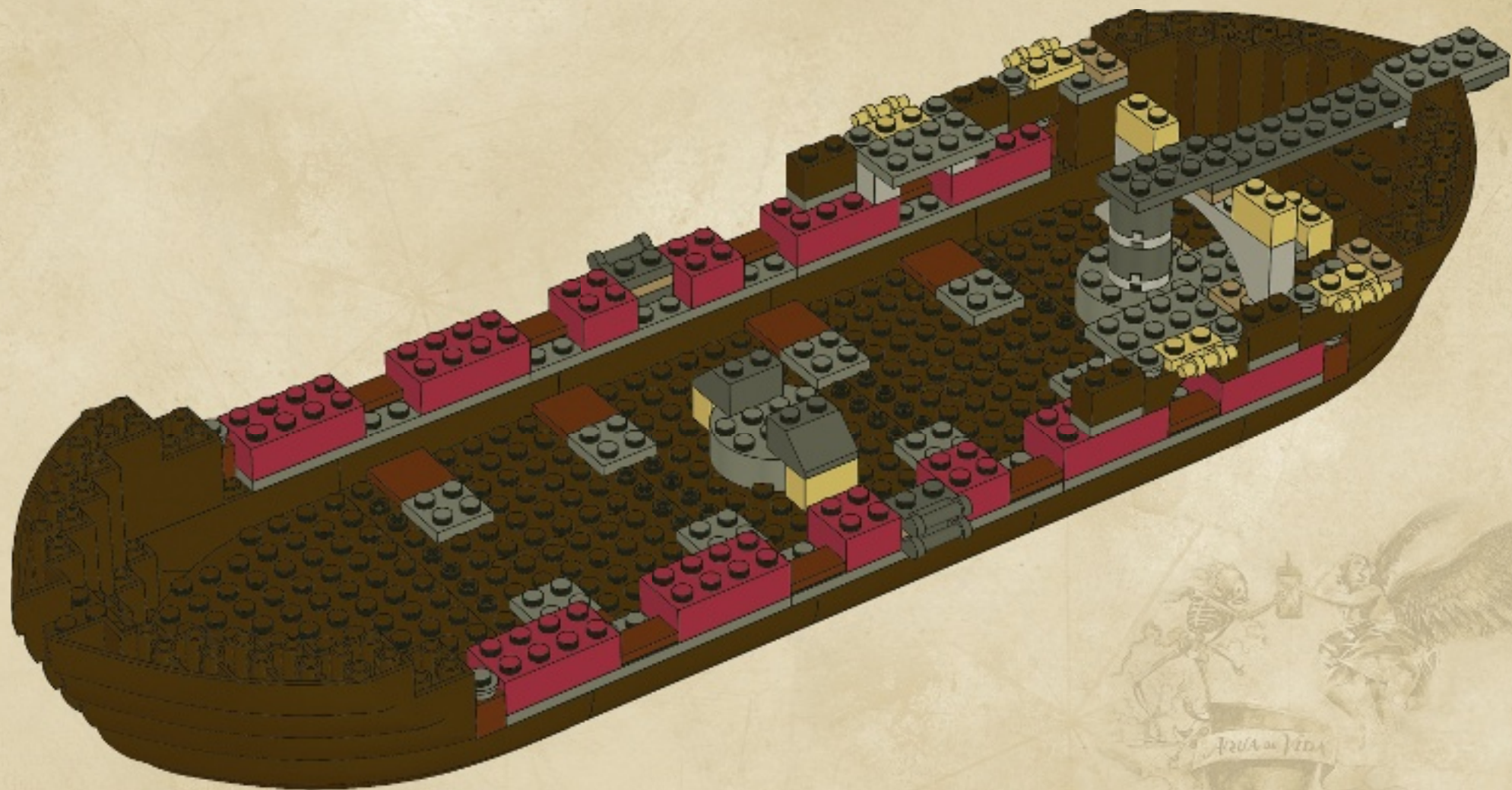

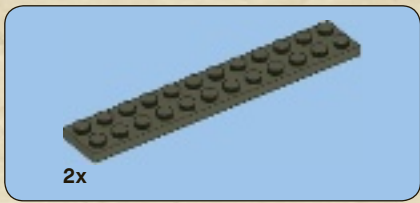

19

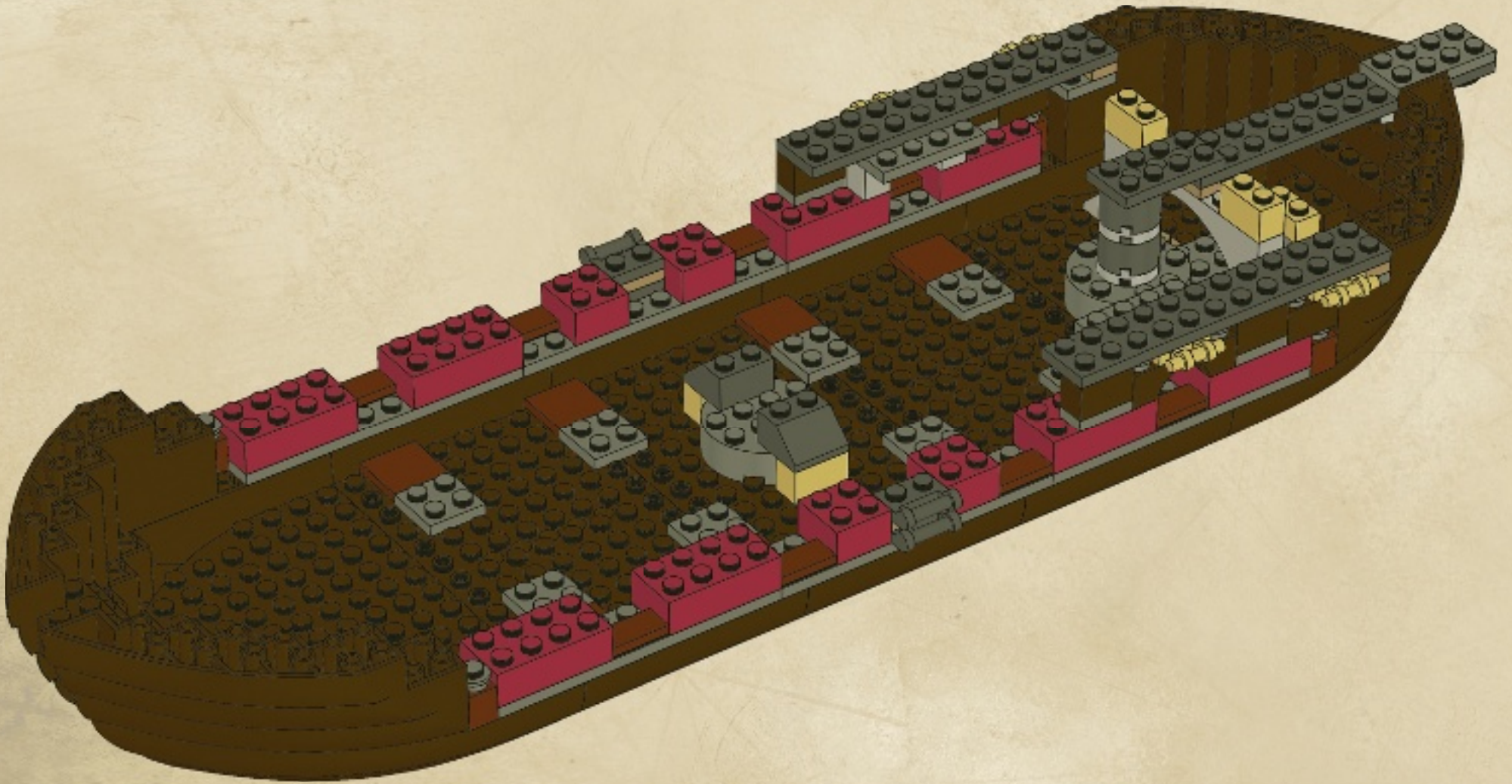

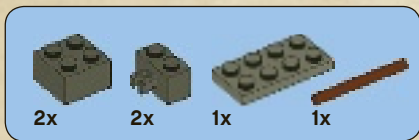

20

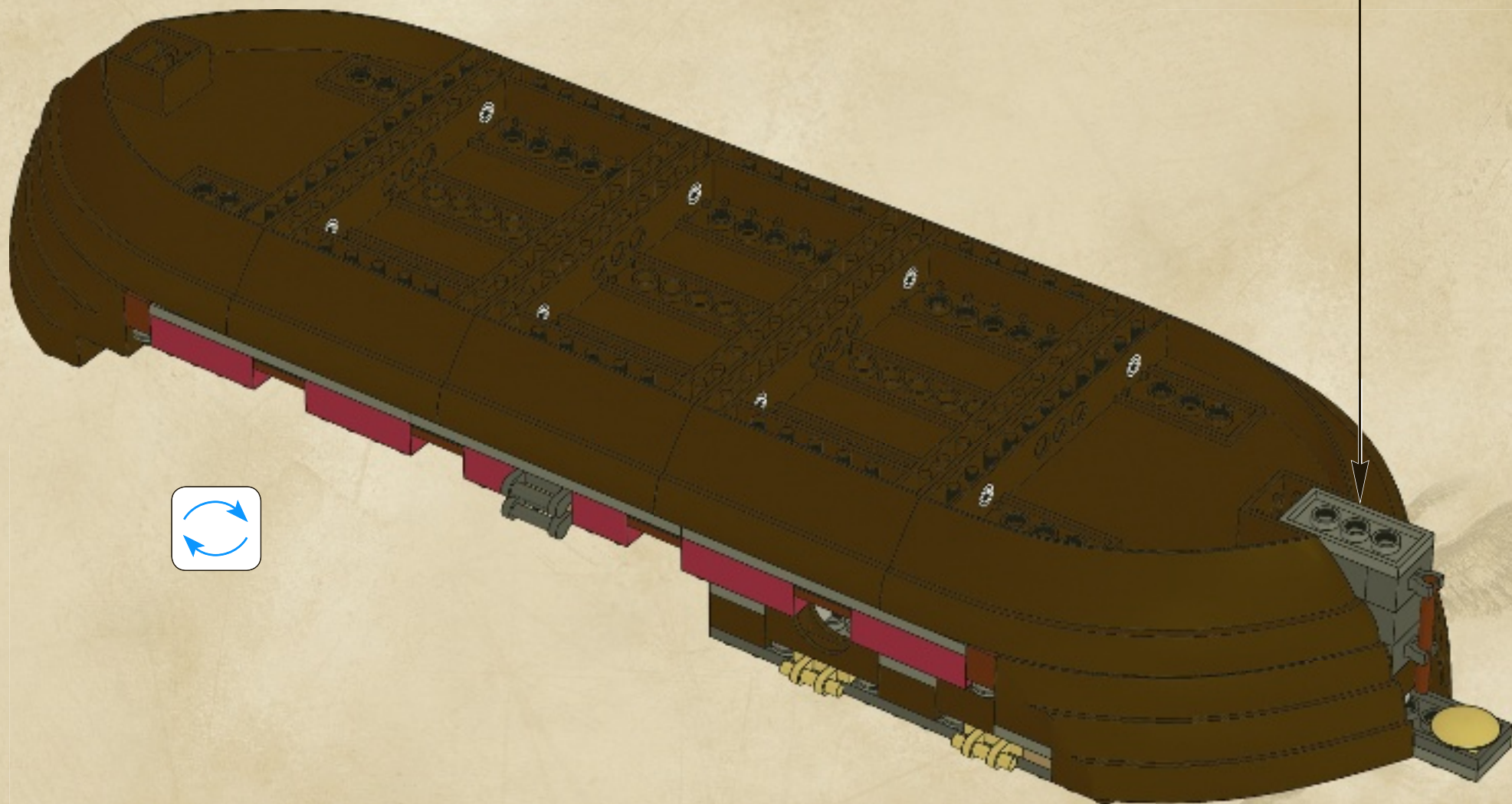
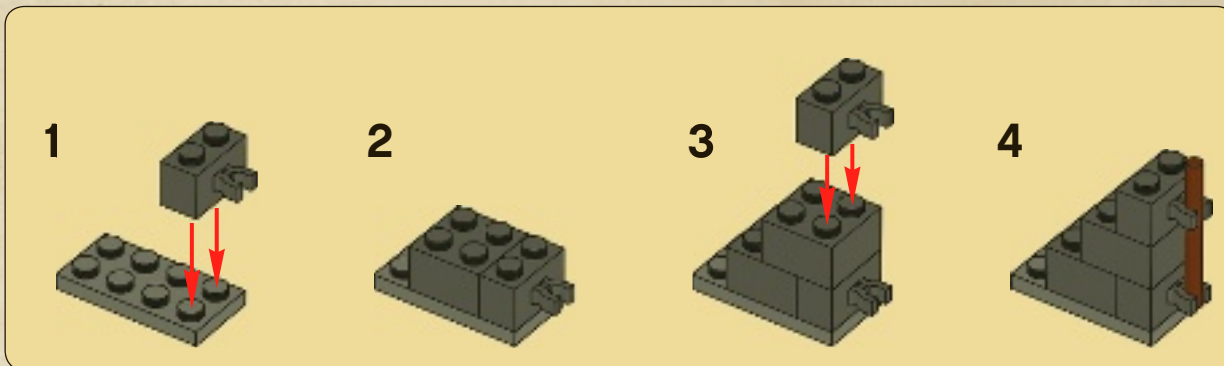

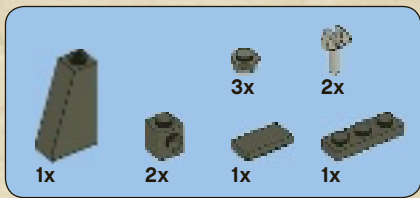

21

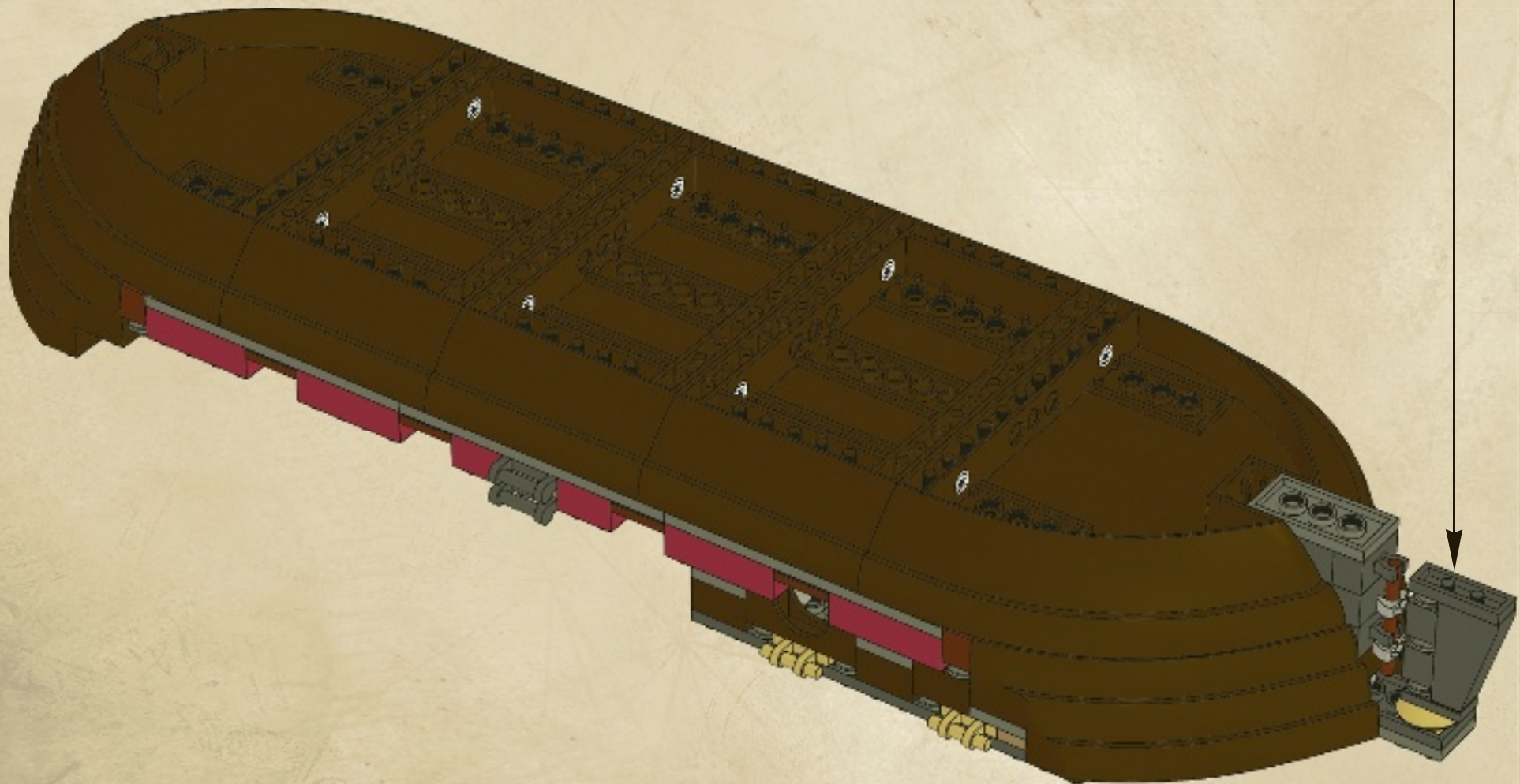

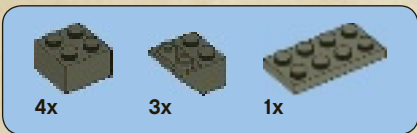

22

1

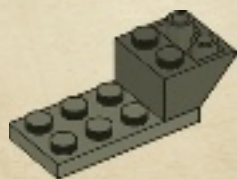

2

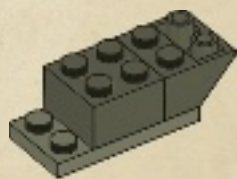

3

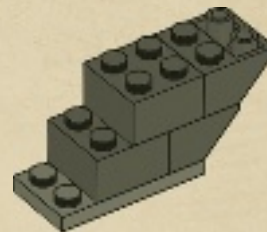

4

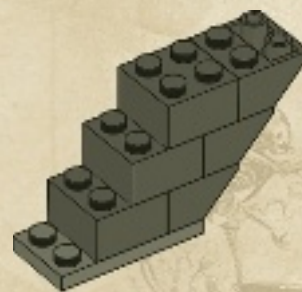

5

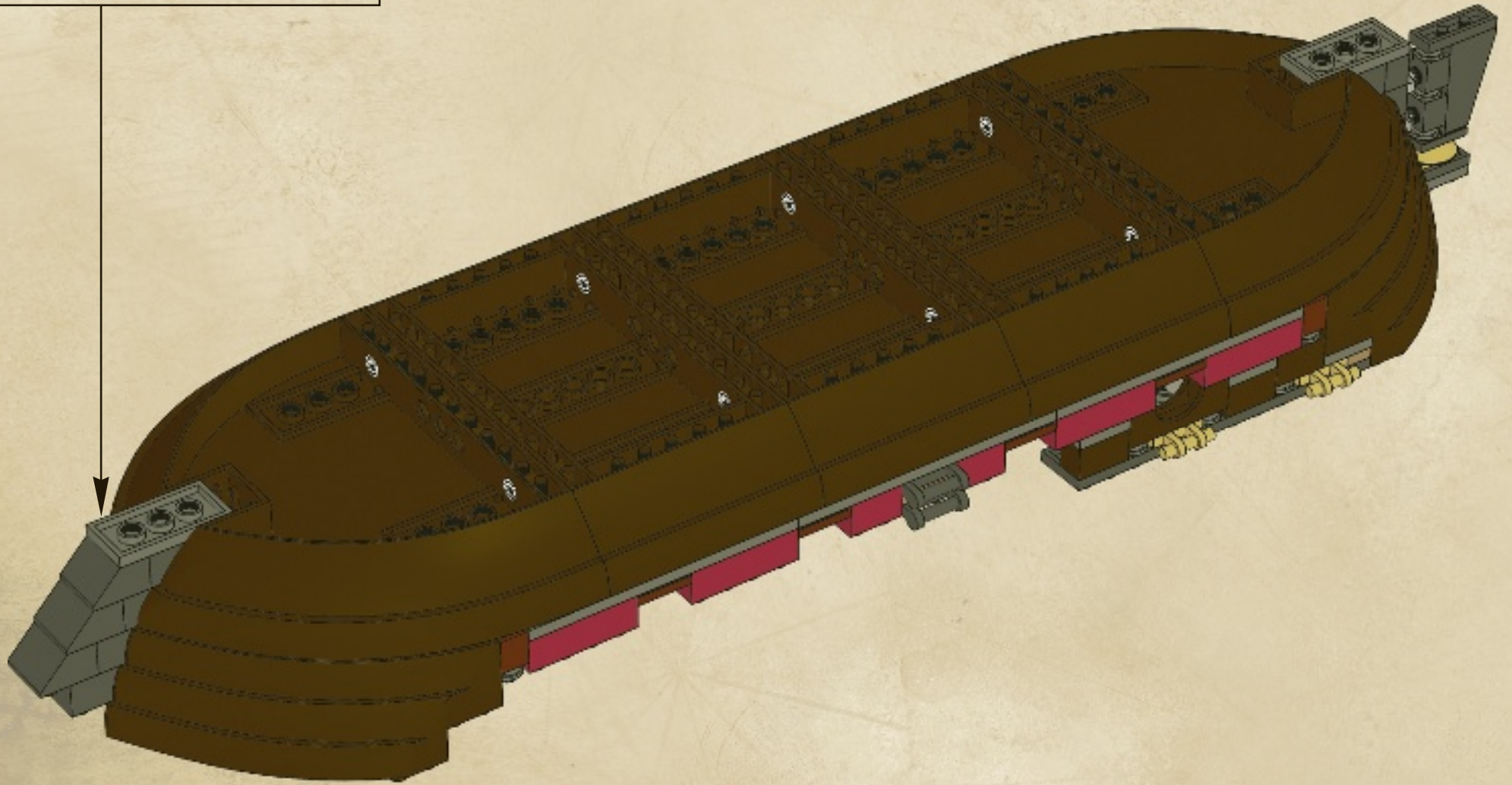
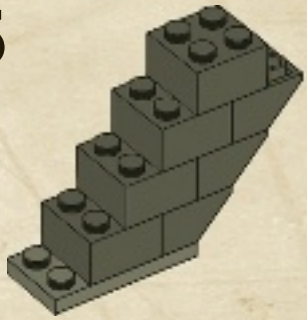



23

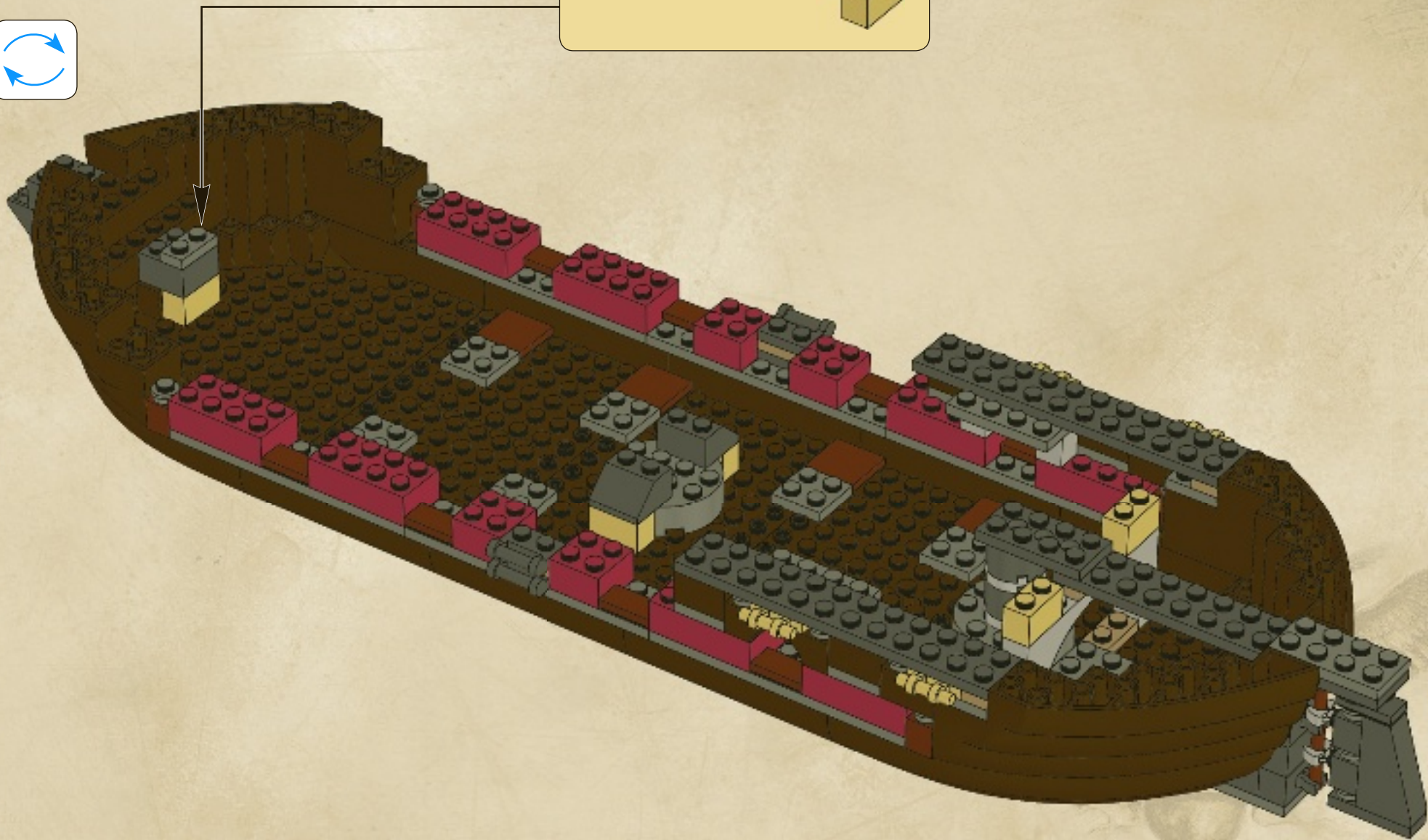
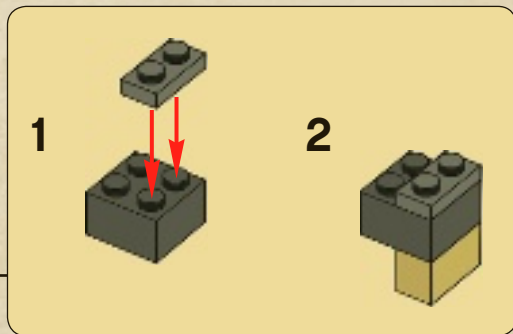

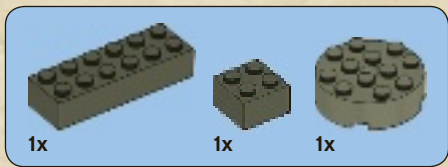

24

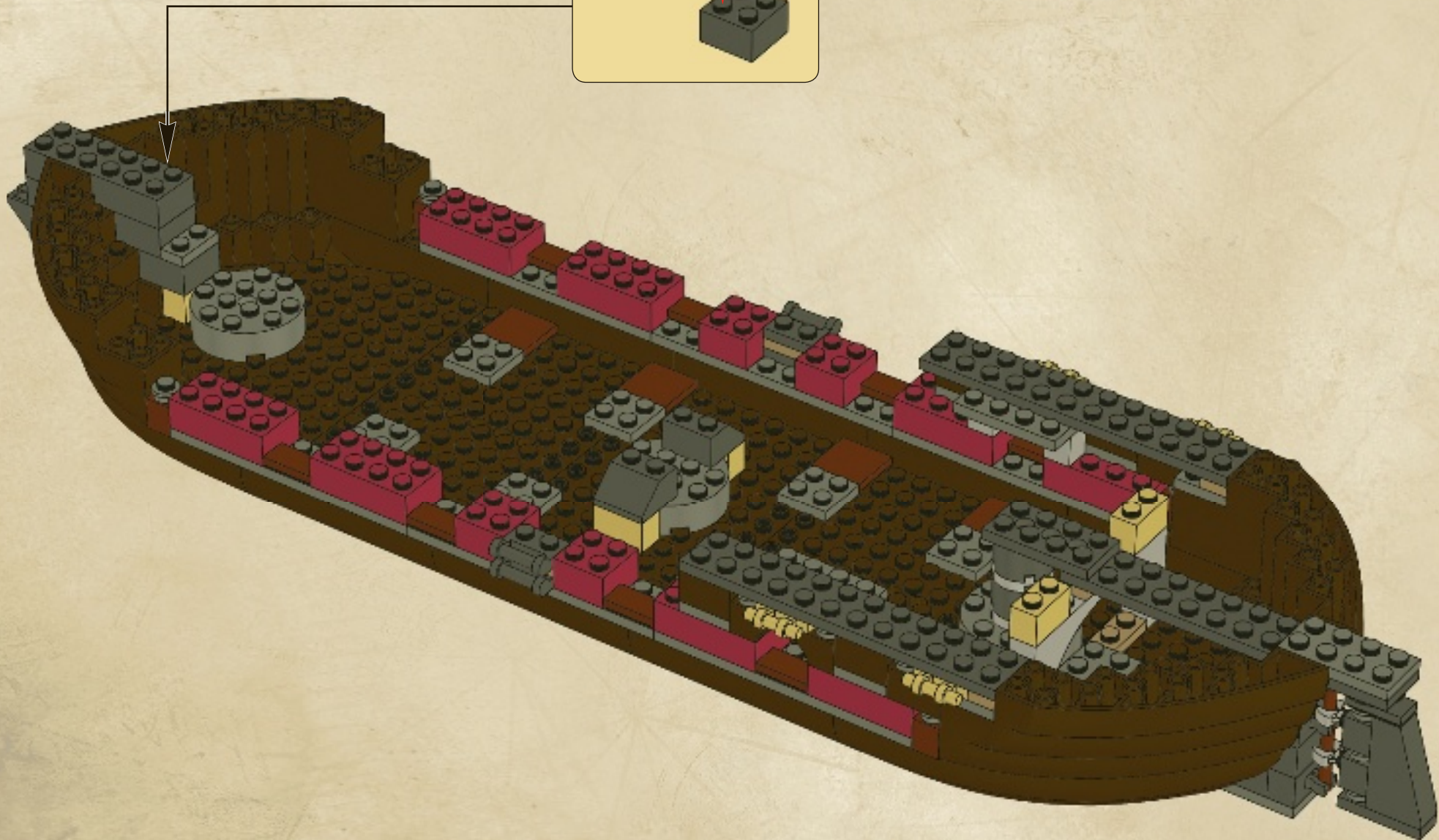
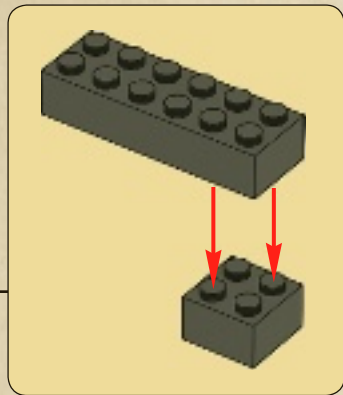

1x 2x 2x

25

1 2 3

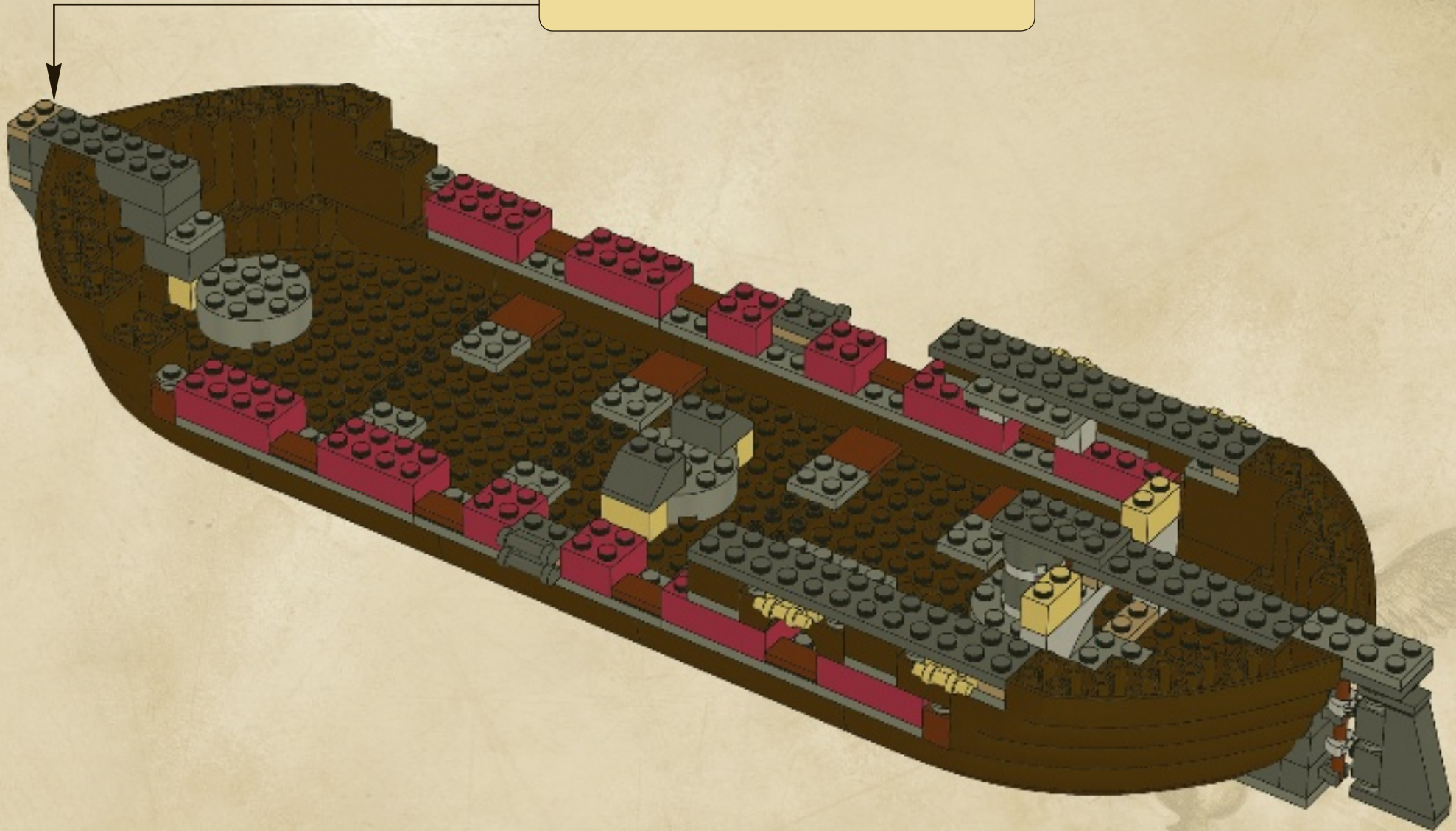

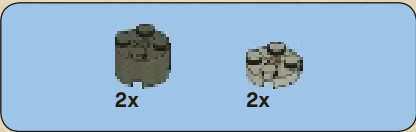

26

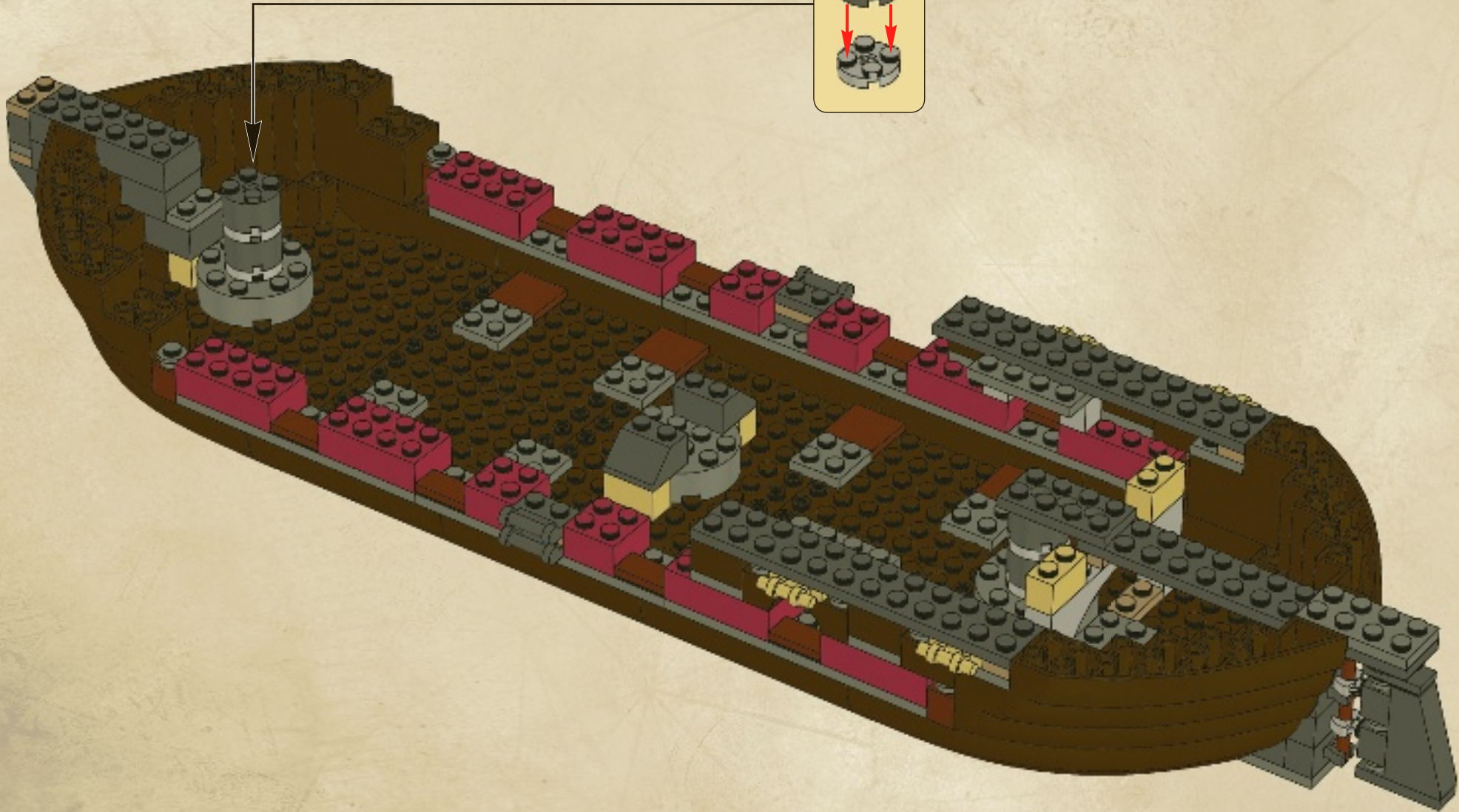



27

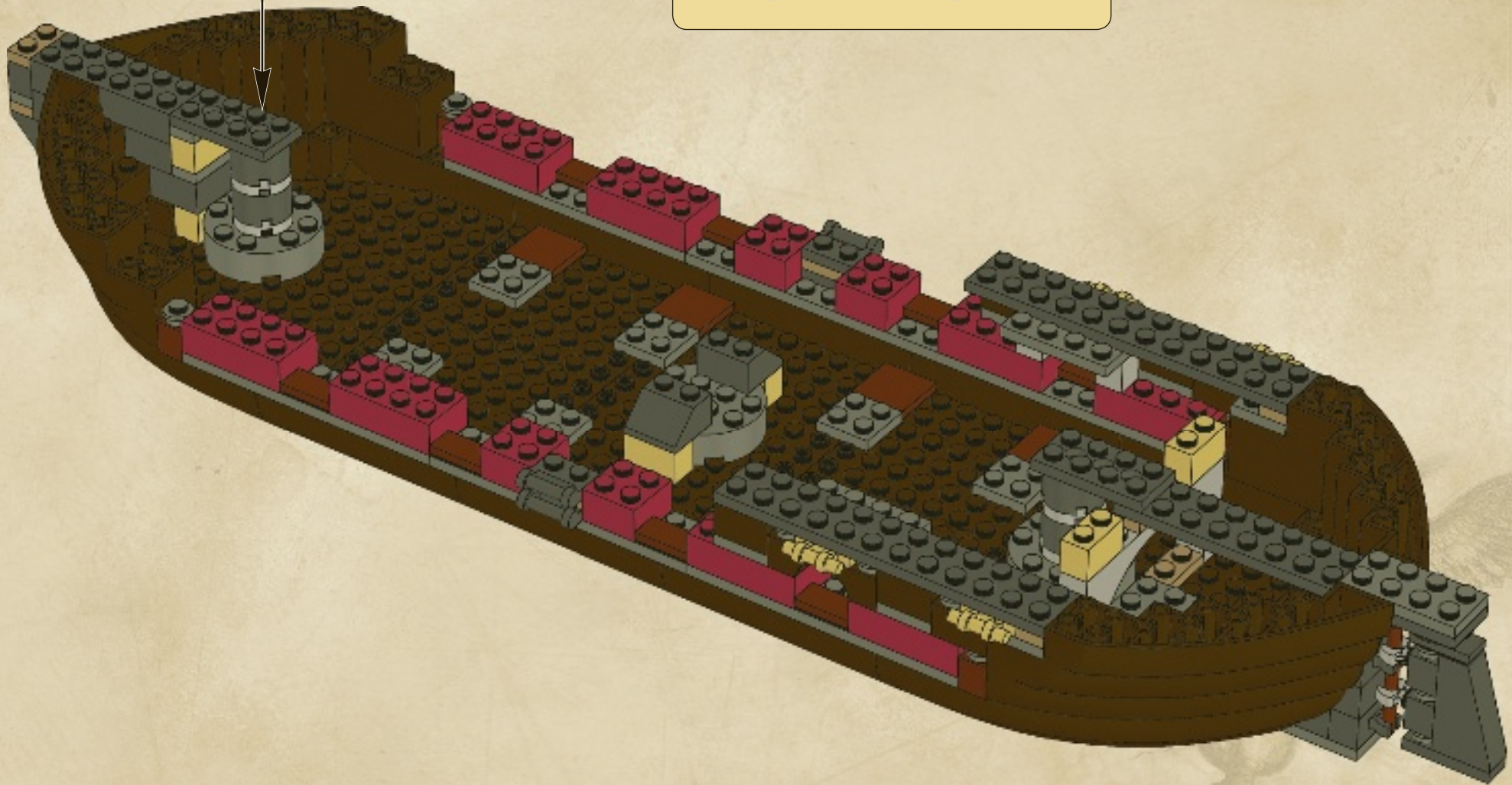
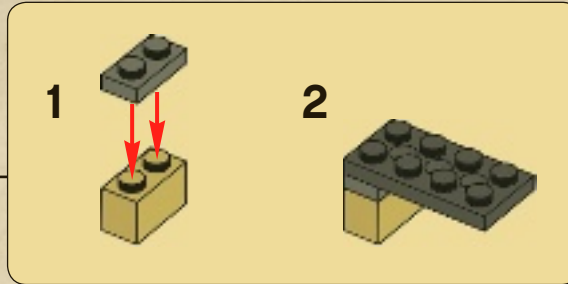



3

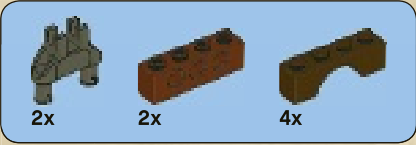
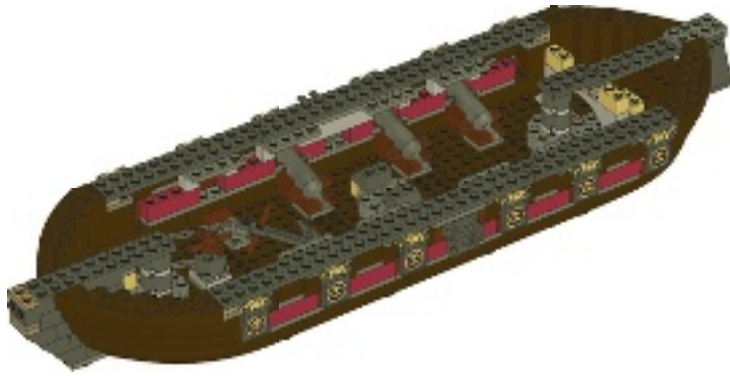

2x

2x

4x

28

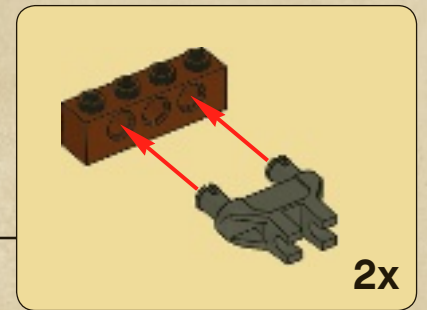
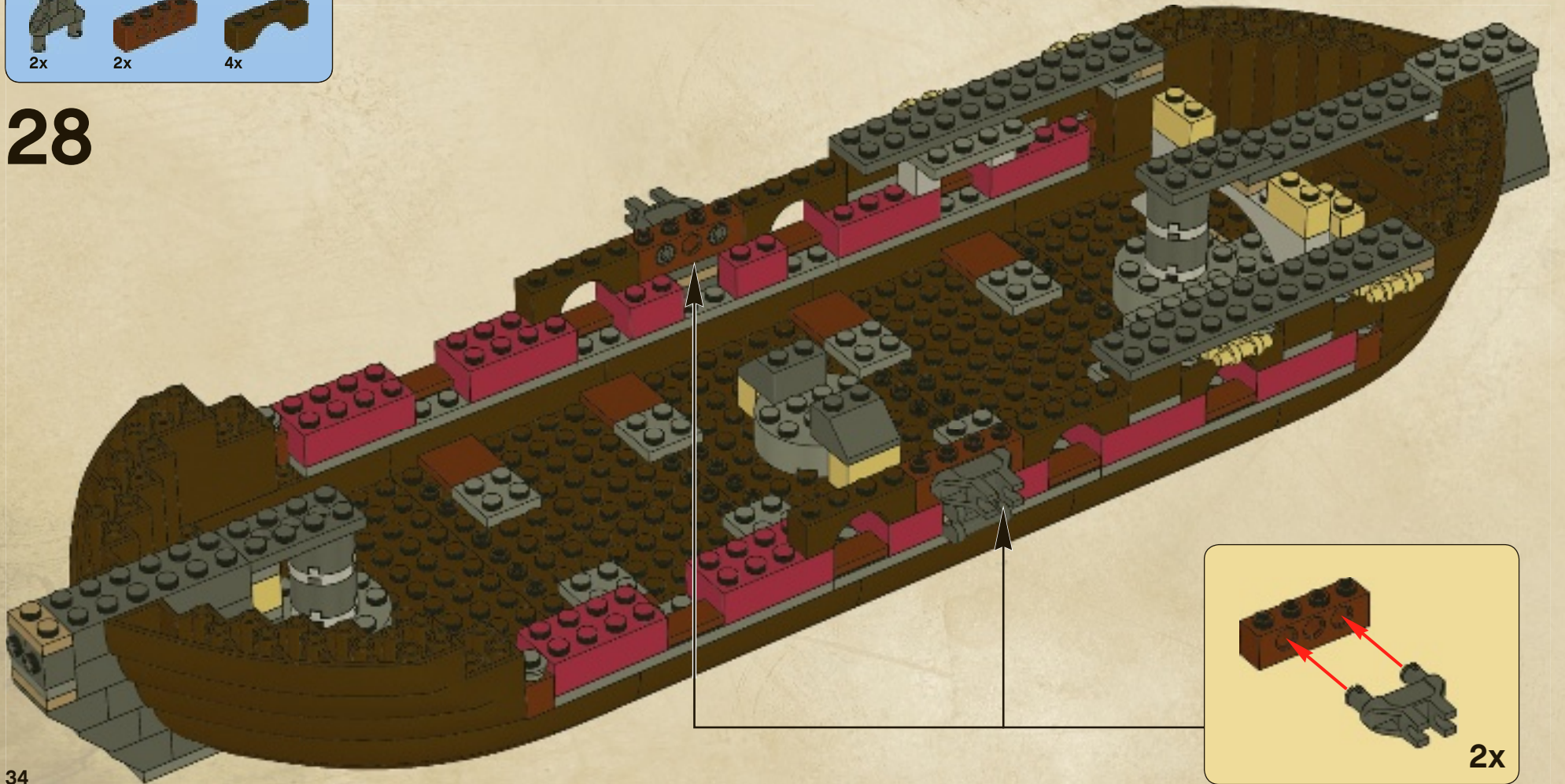

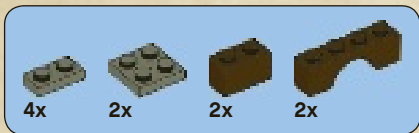

2x

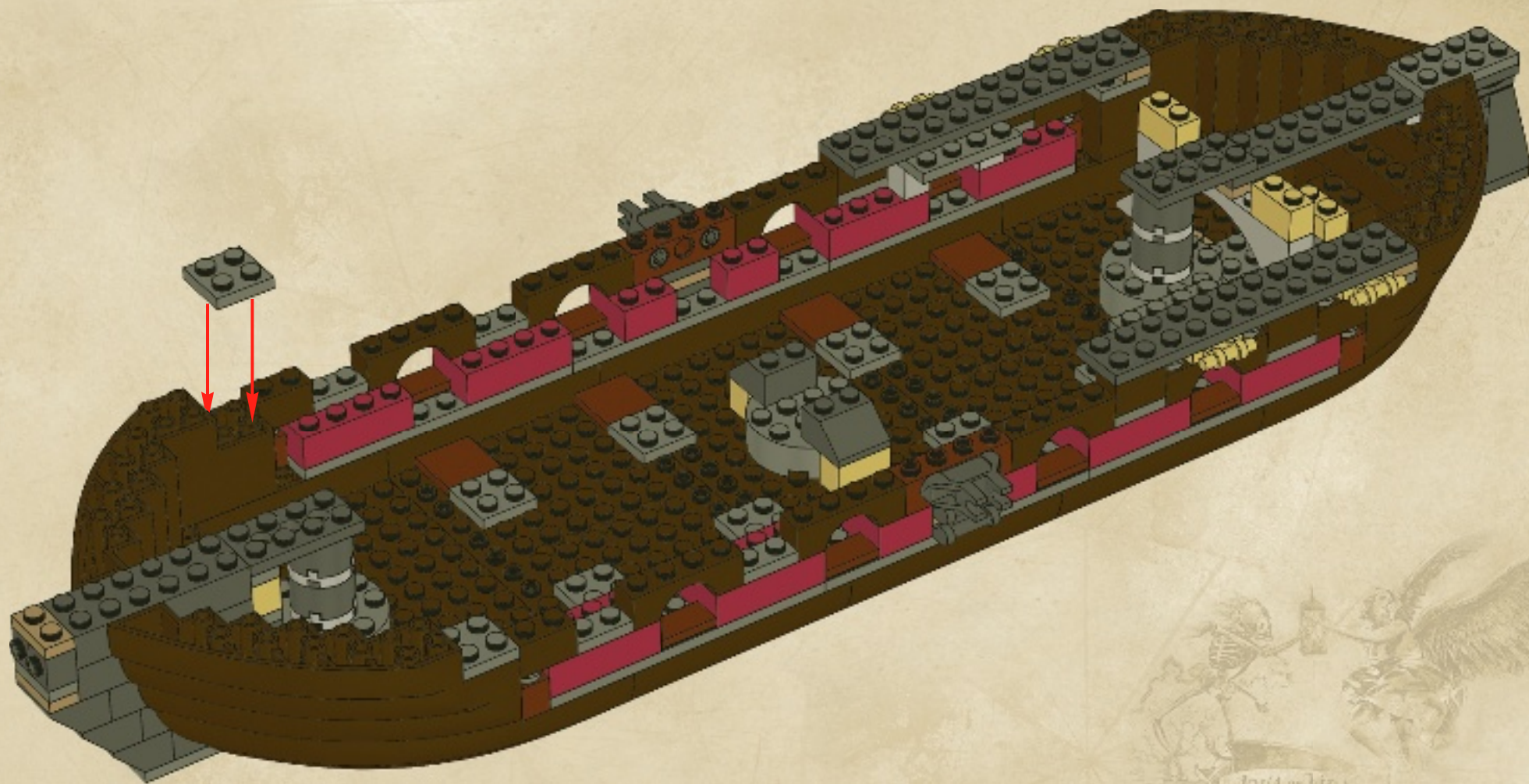

29



8x  2x 

30

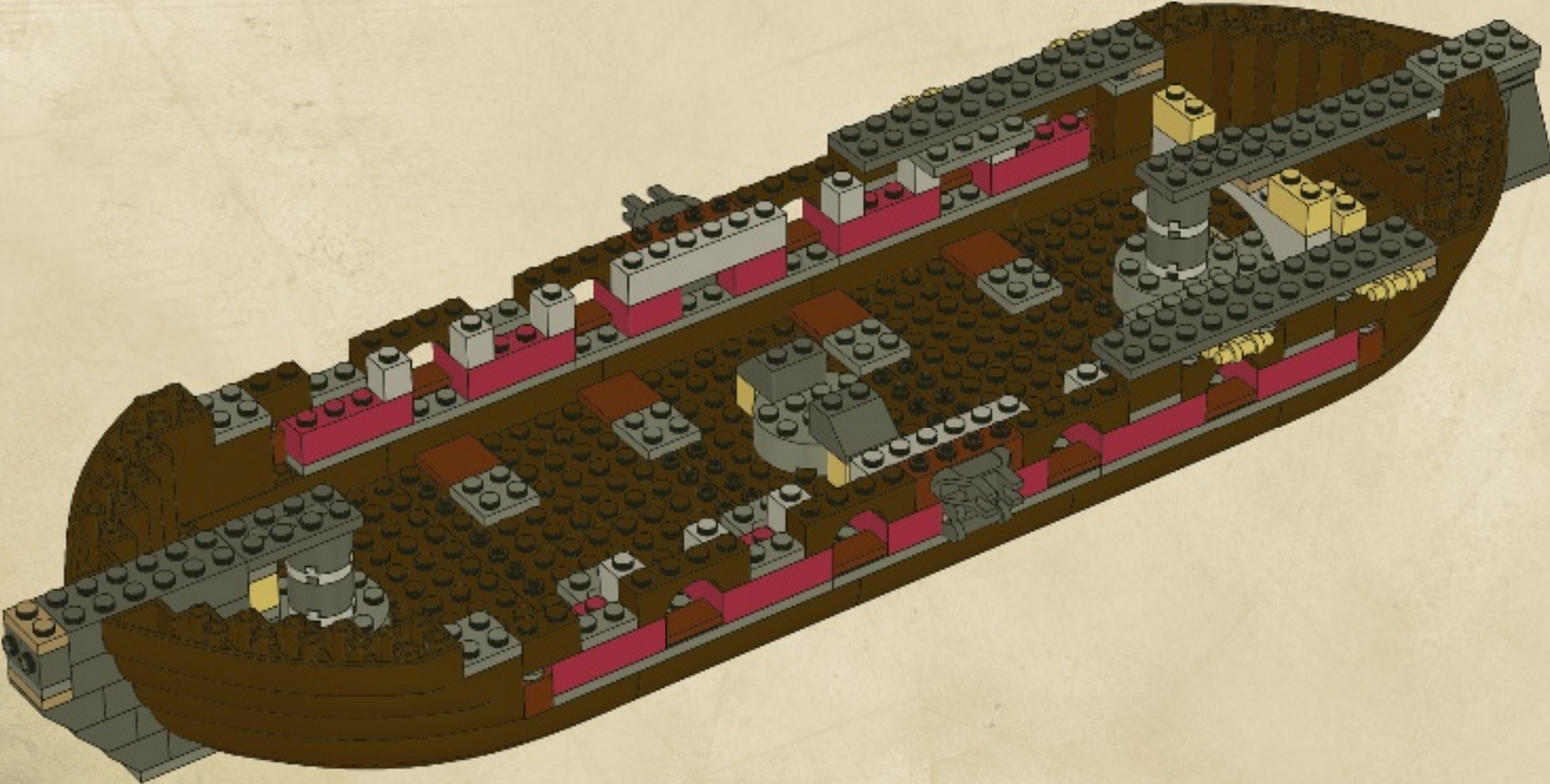

8x 14x 2x

31

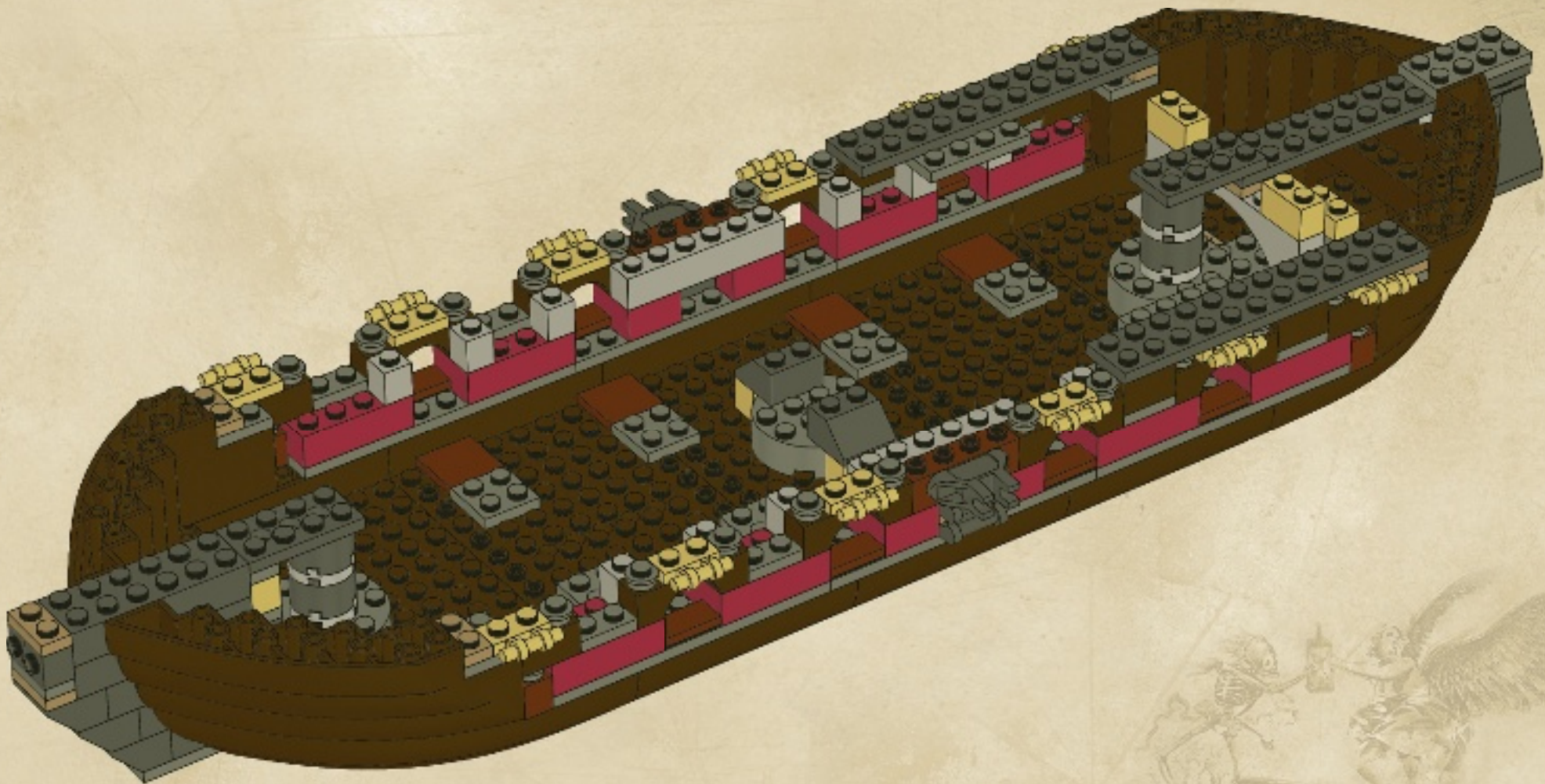

2x  4x 

32

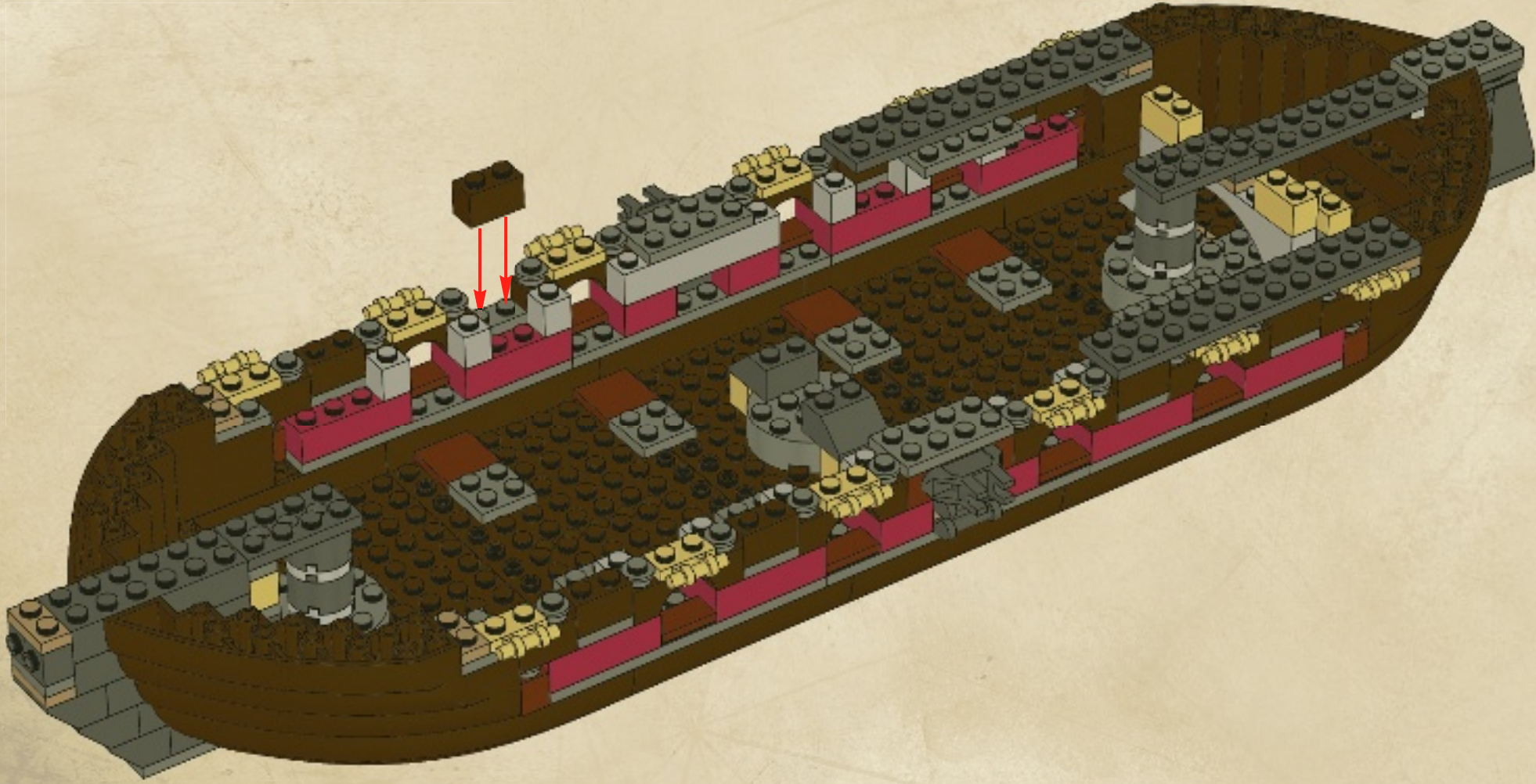



6x

33

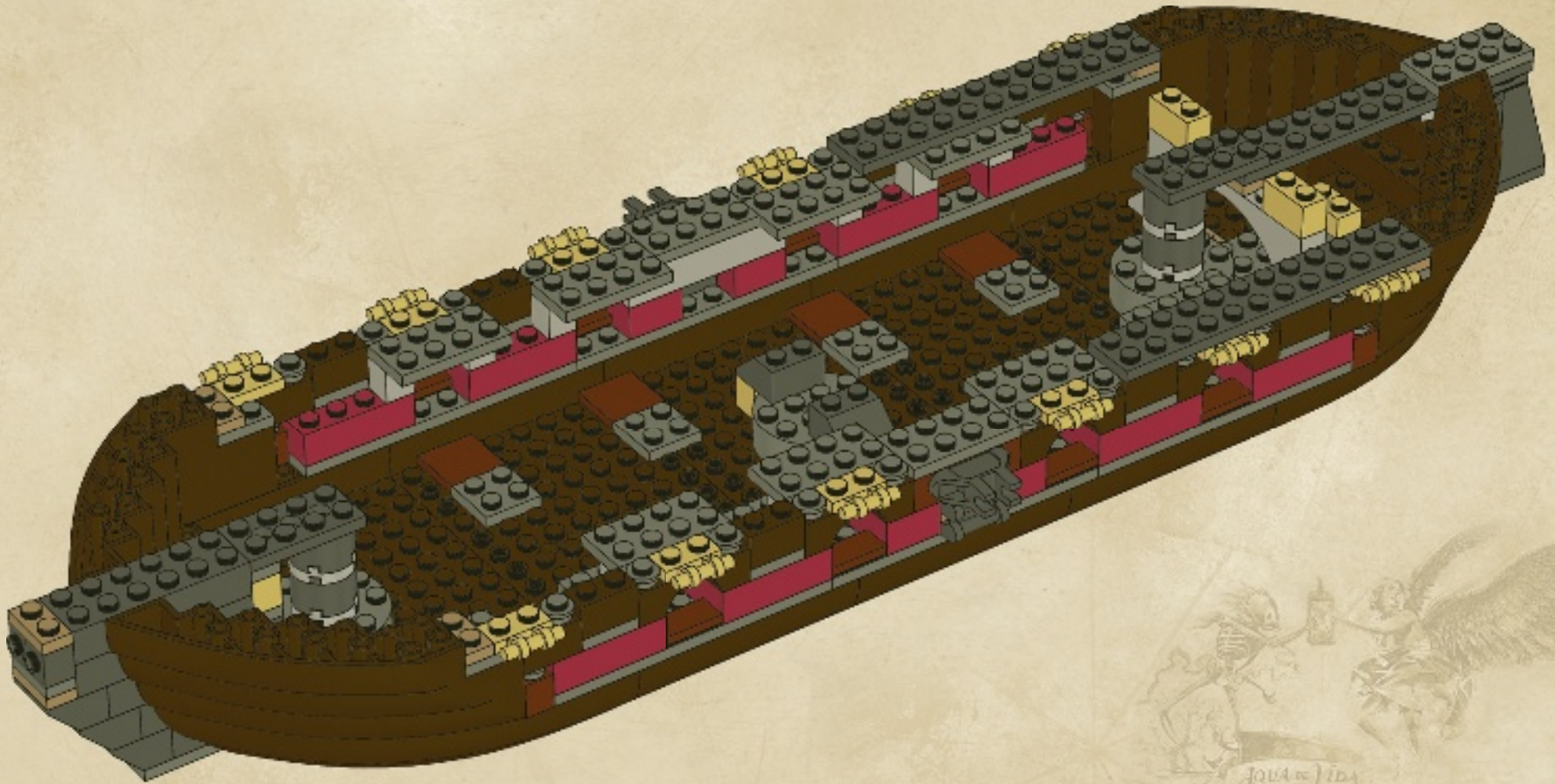

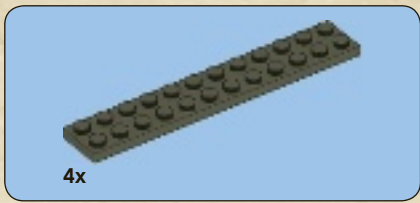

34

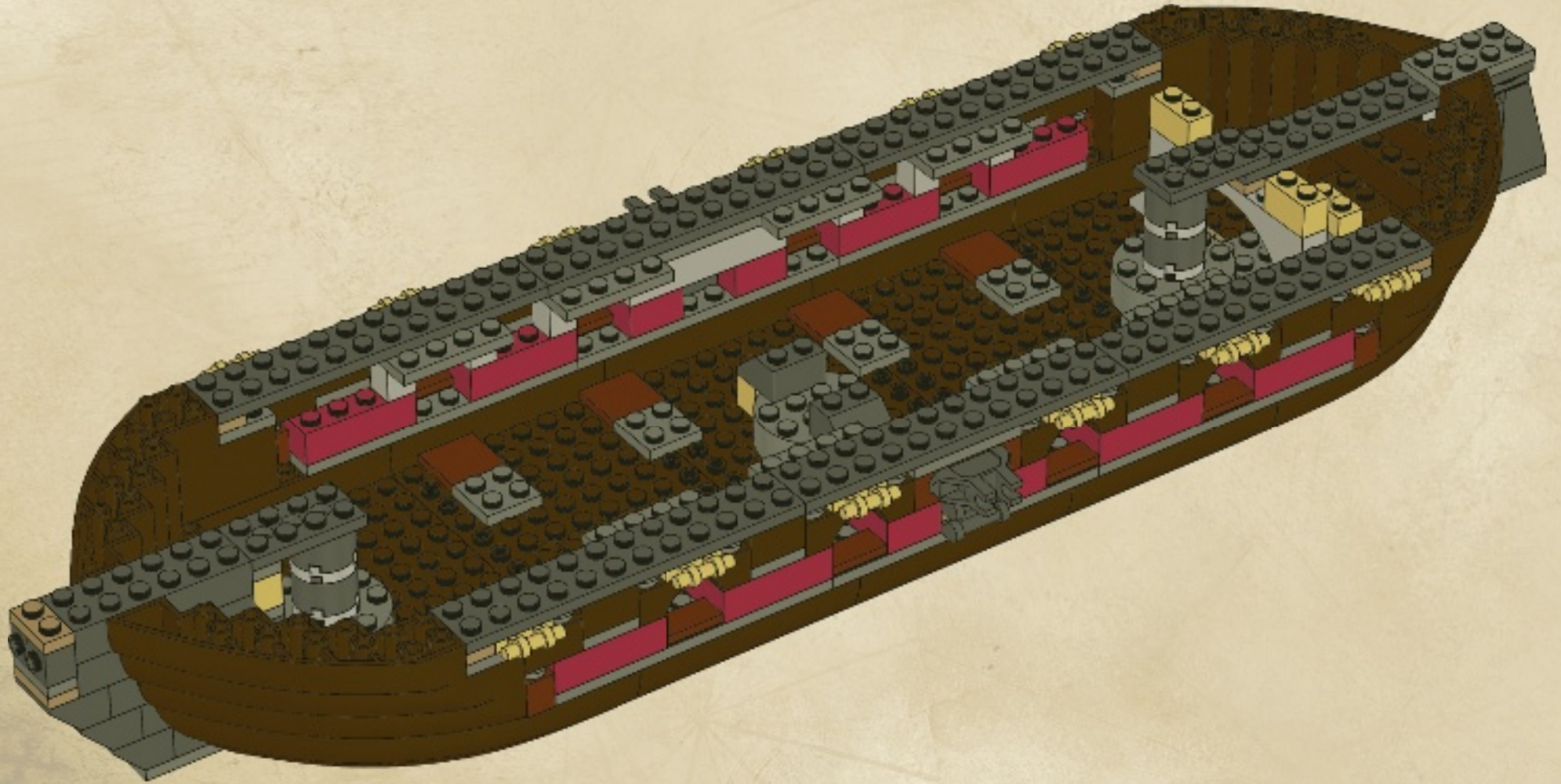



35

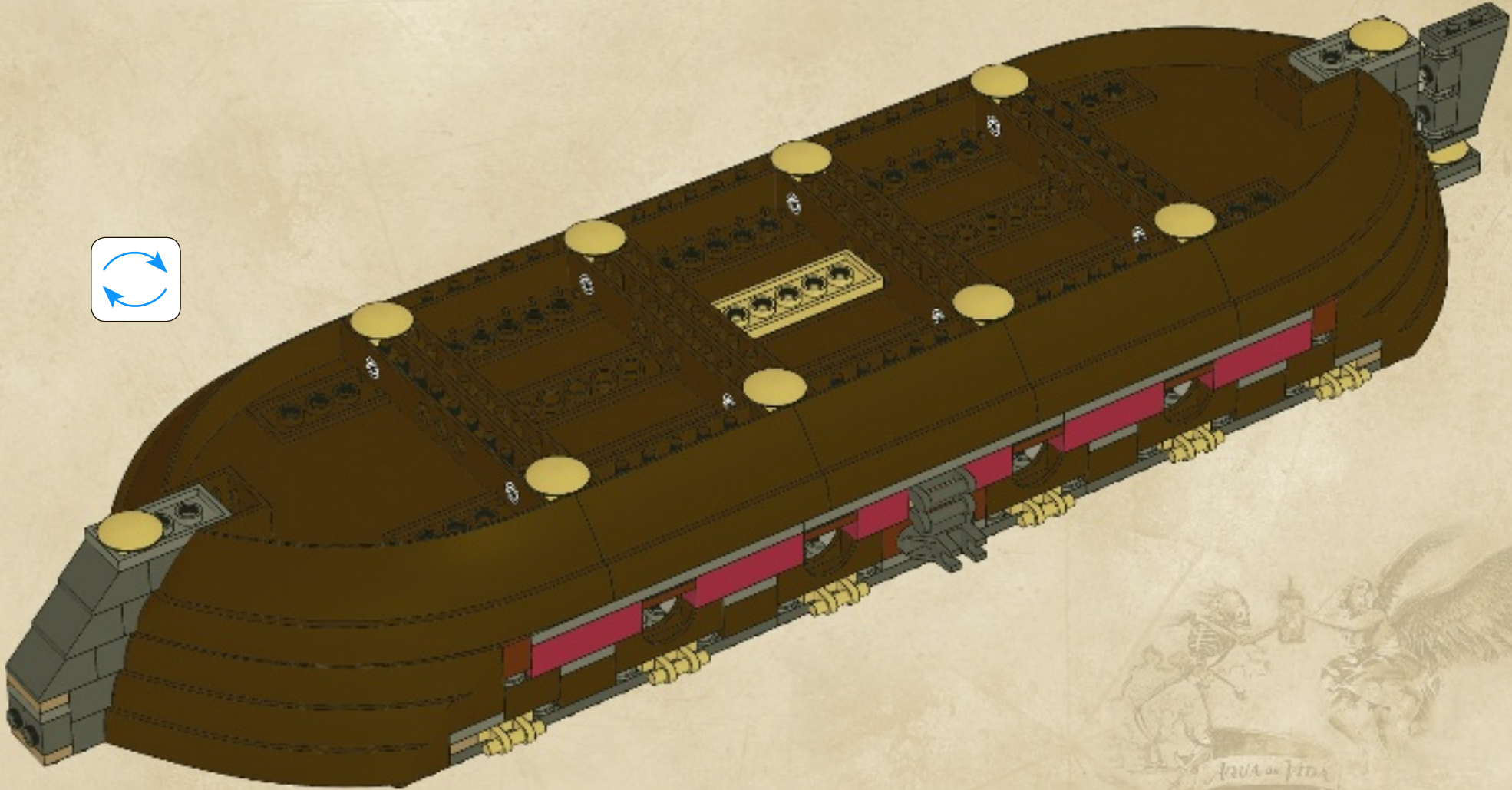

6

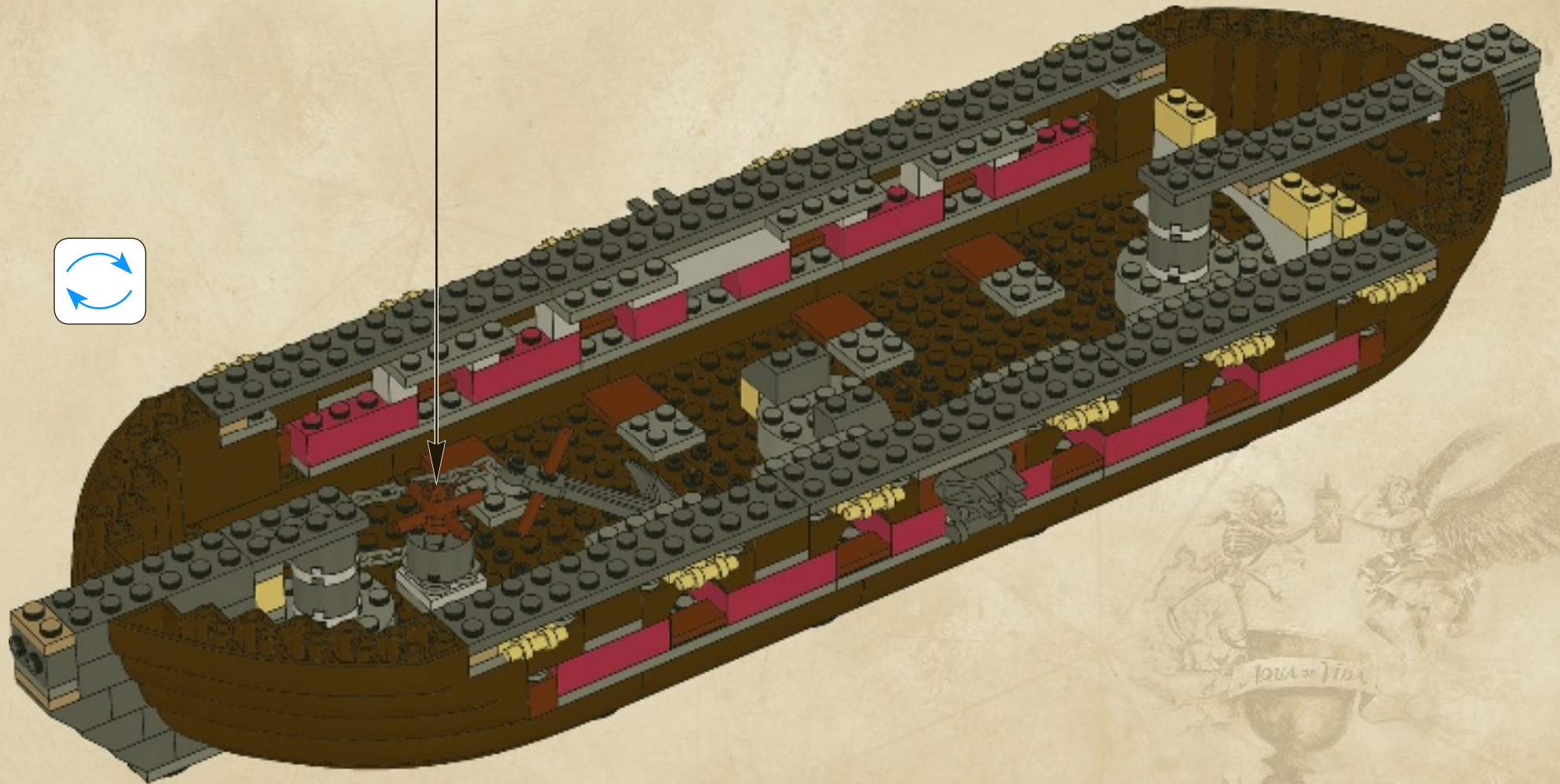
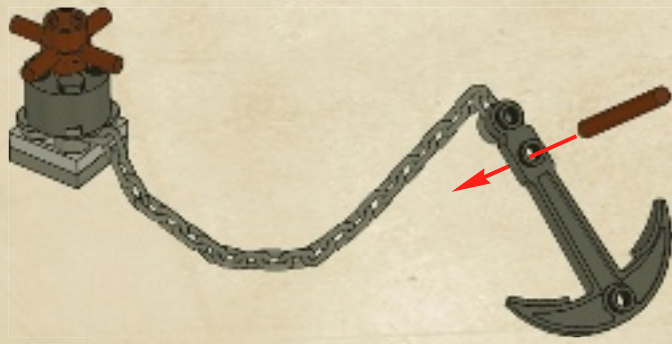



37

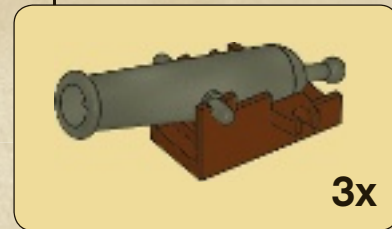
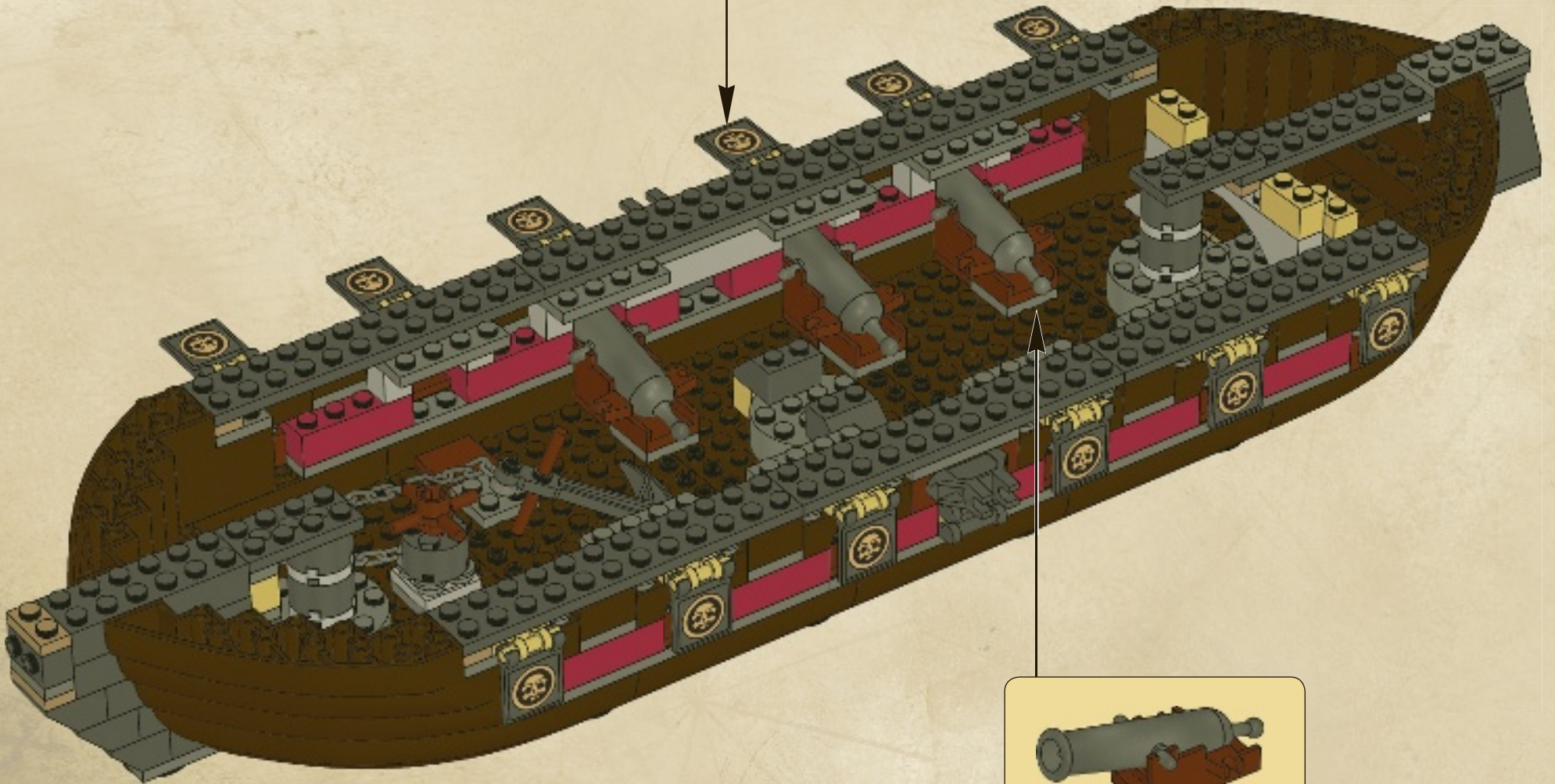
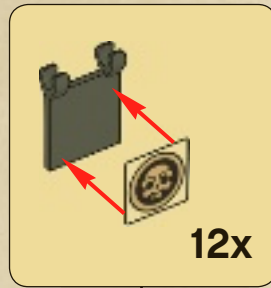

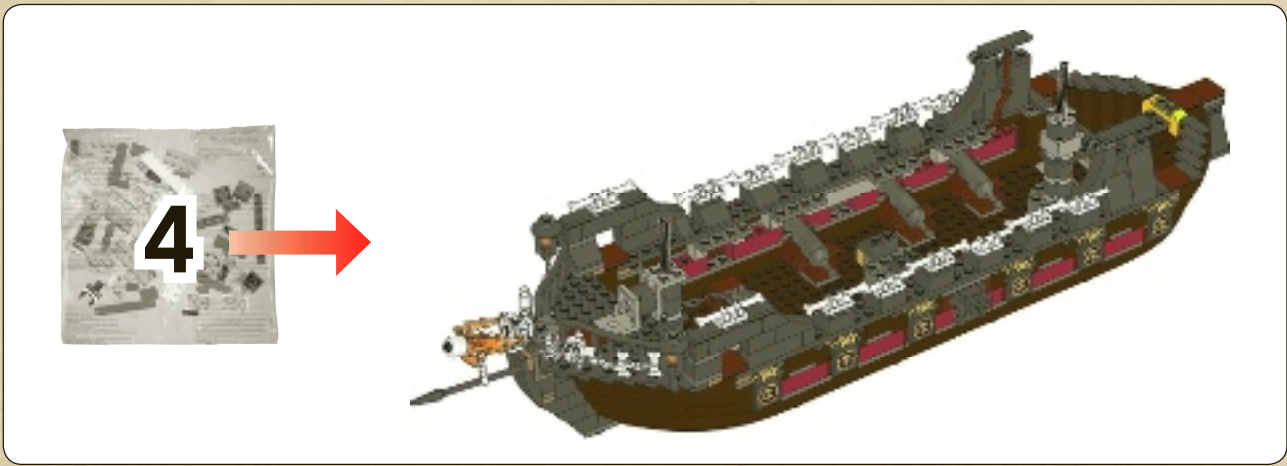

38

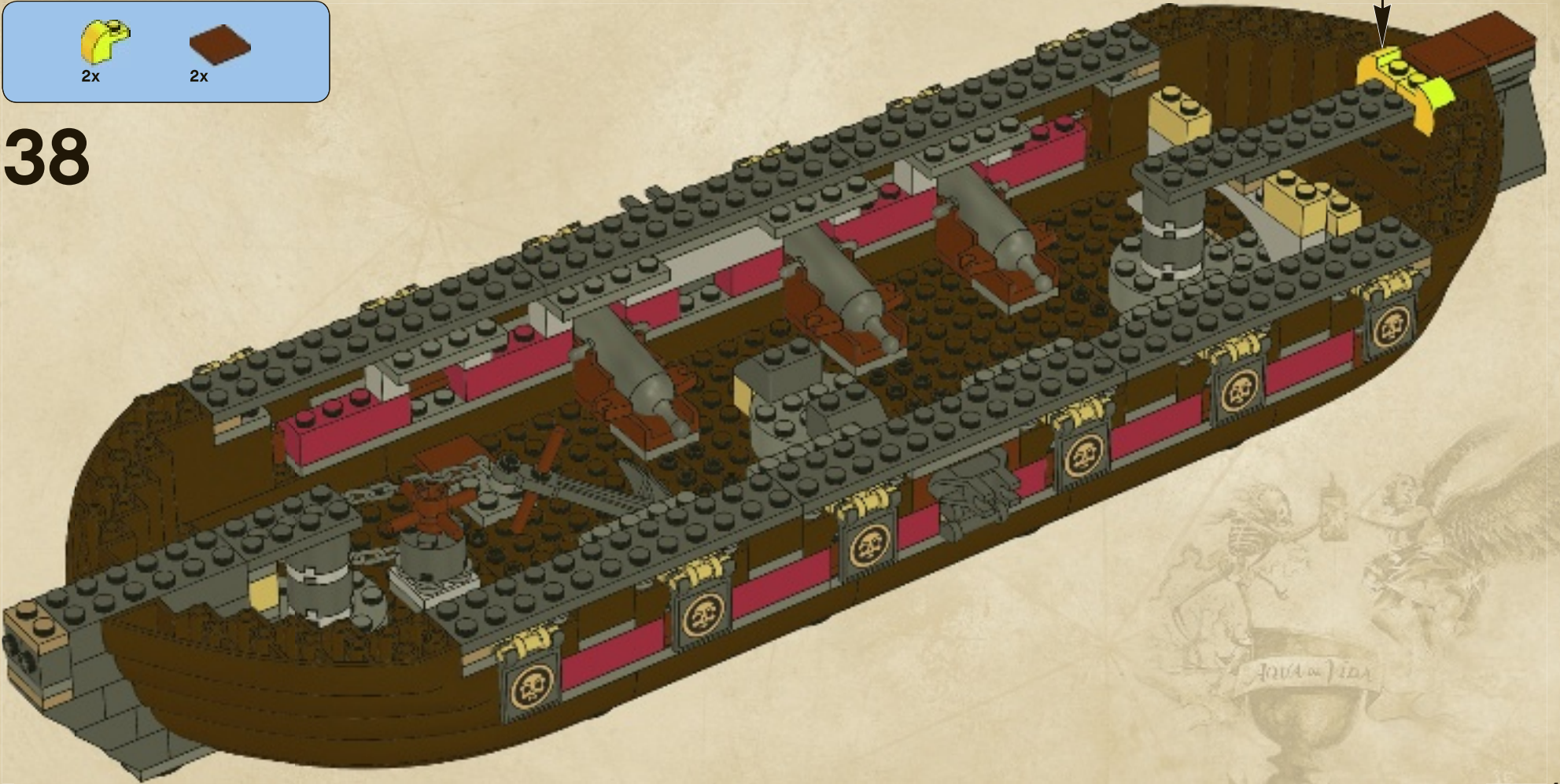

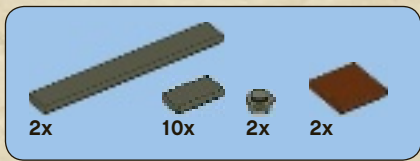

39

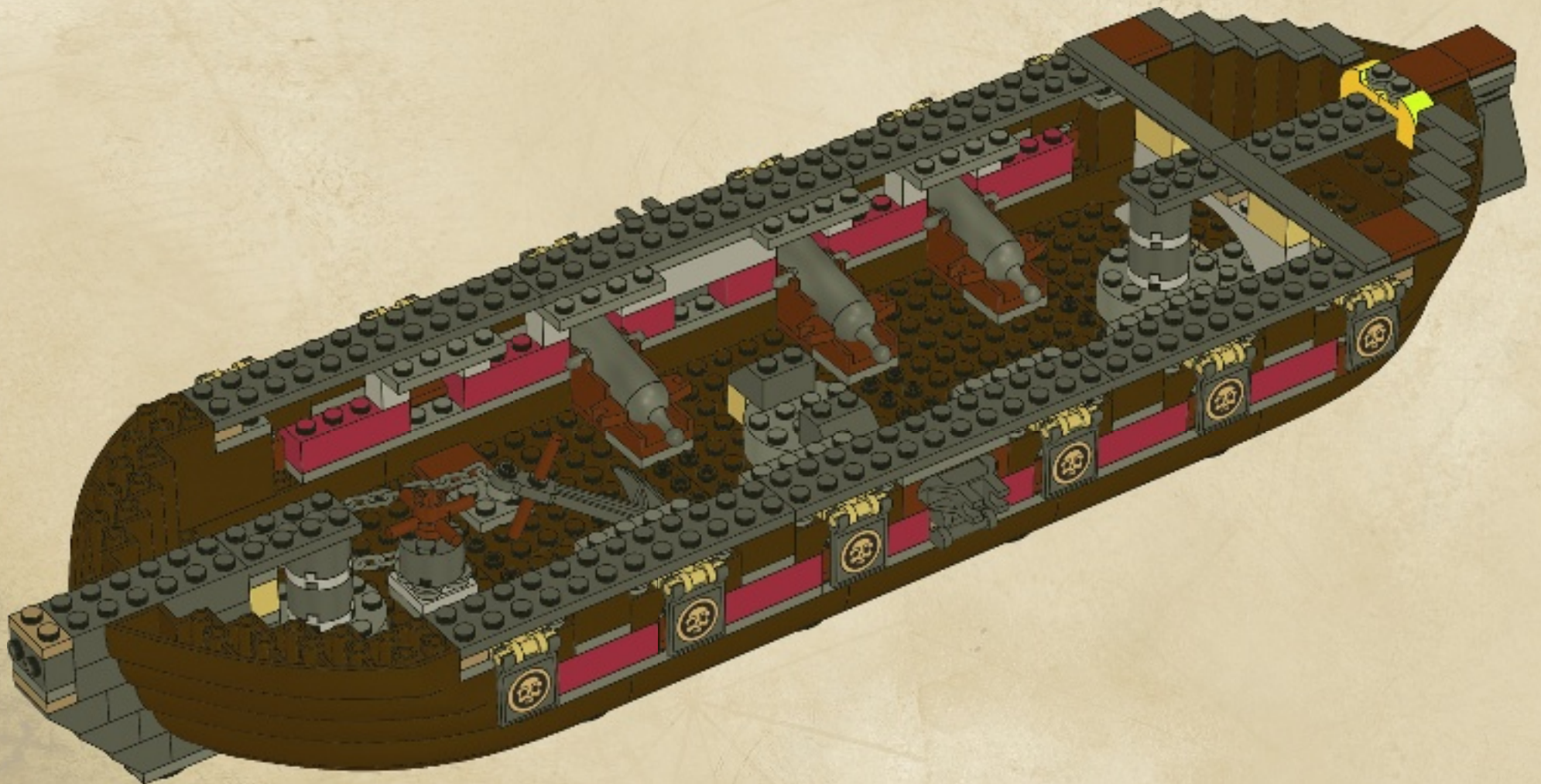

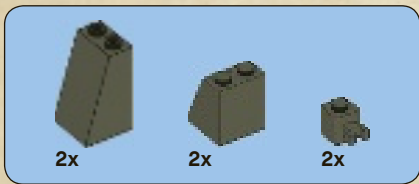

40

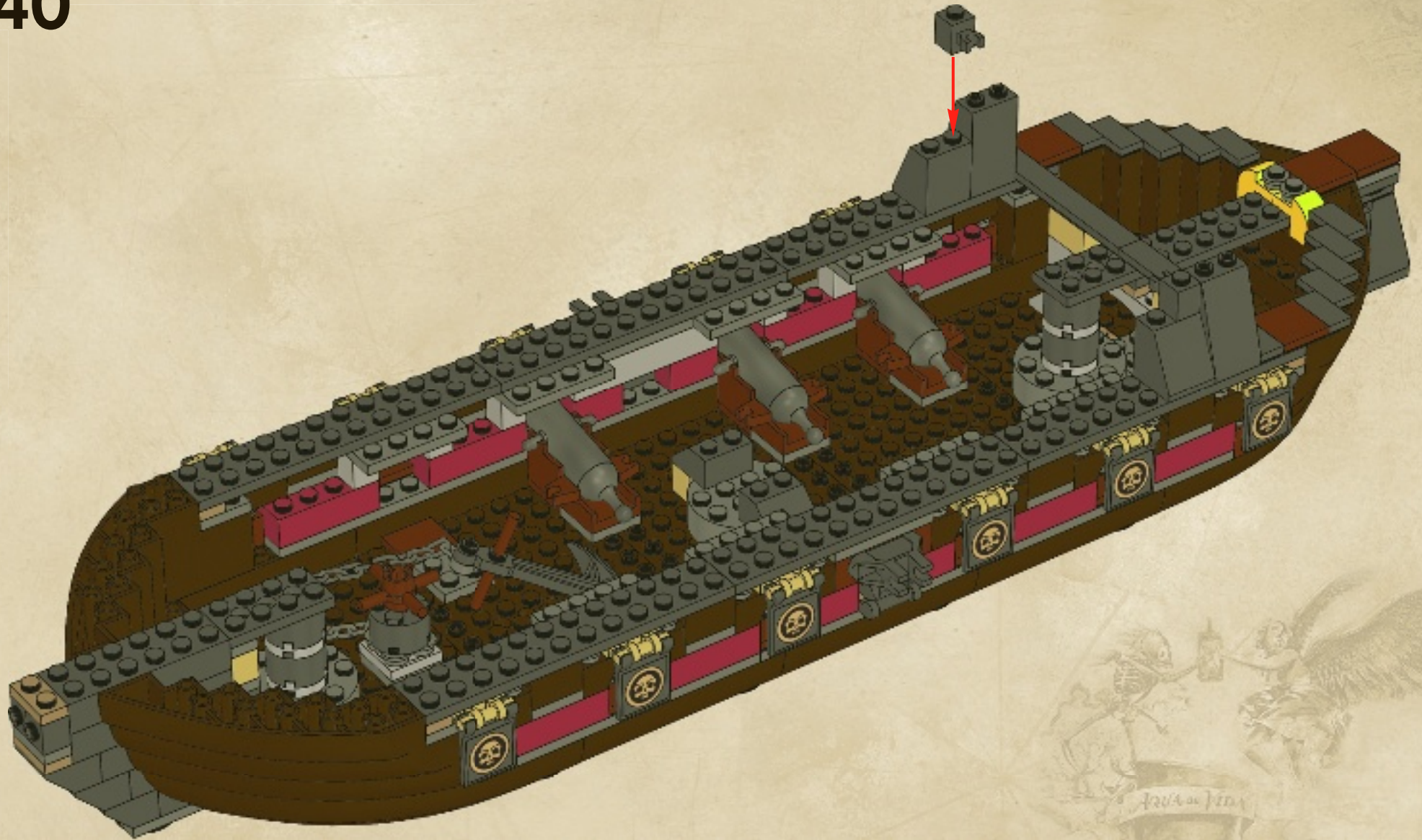

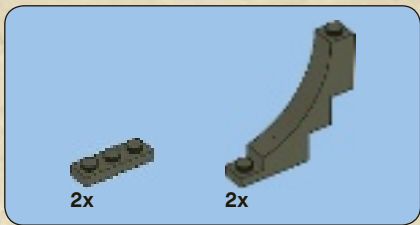

41

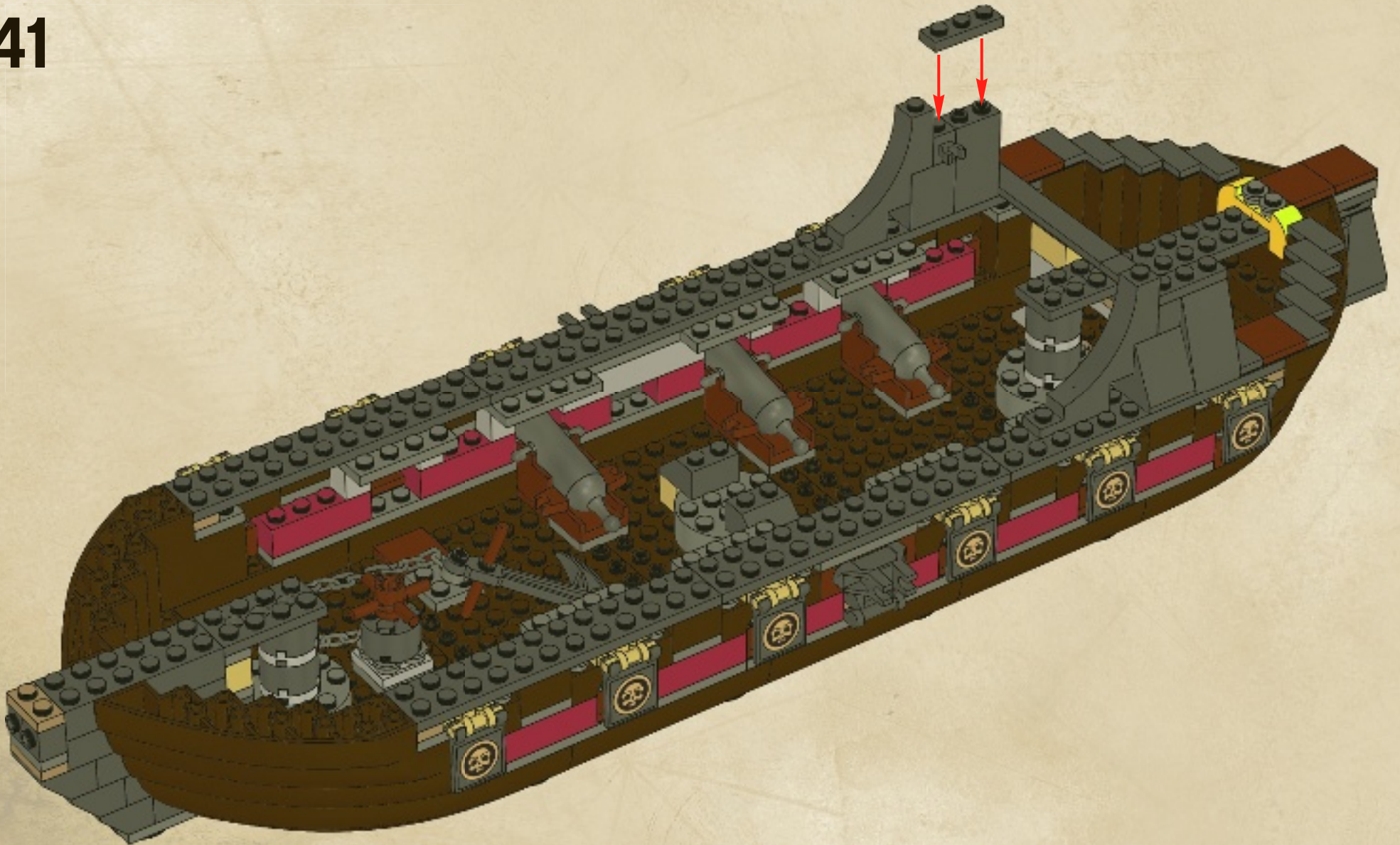

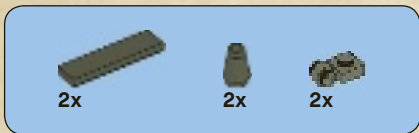

42

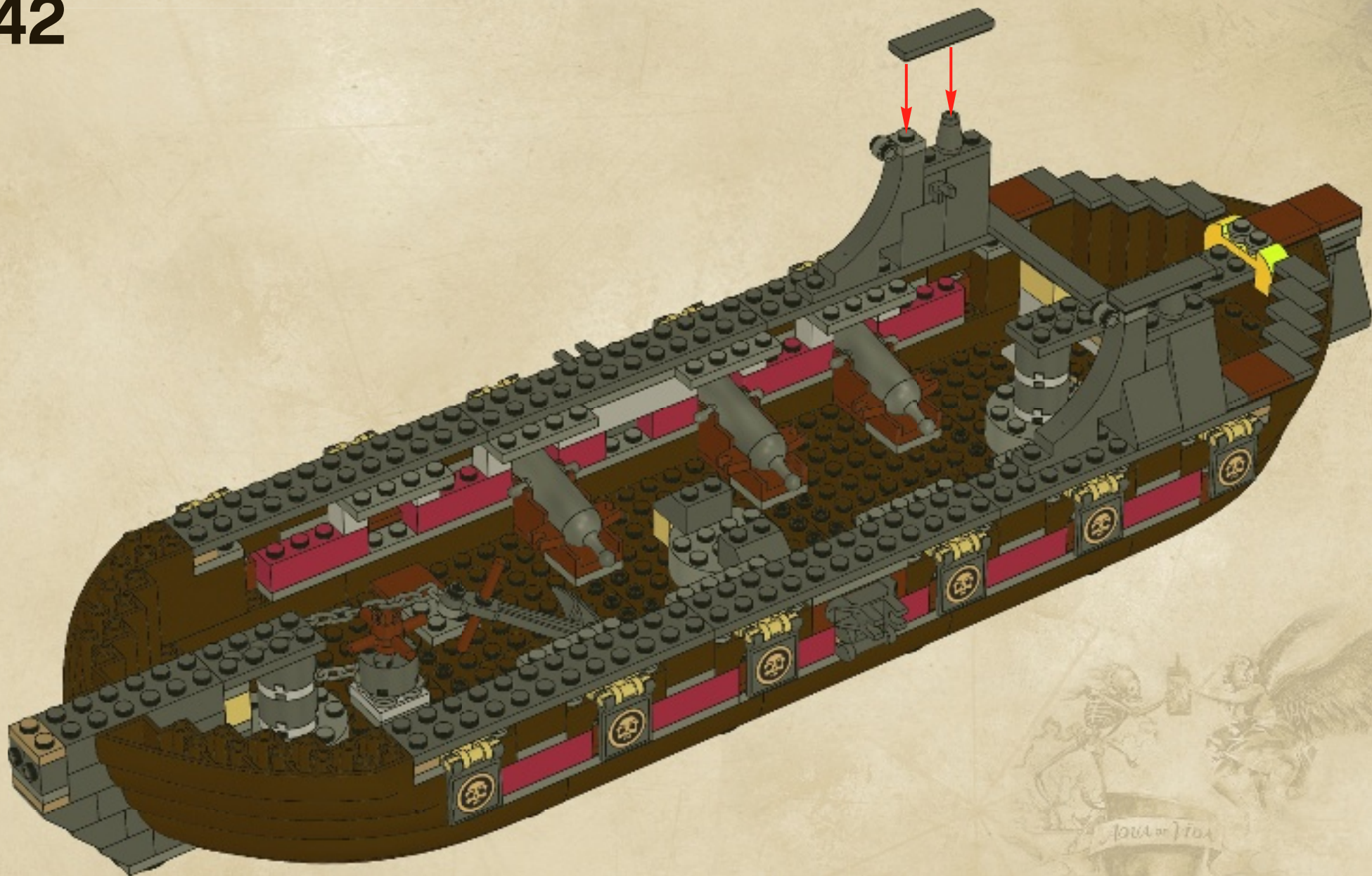

4x 2x 2x

43

1 2 2x

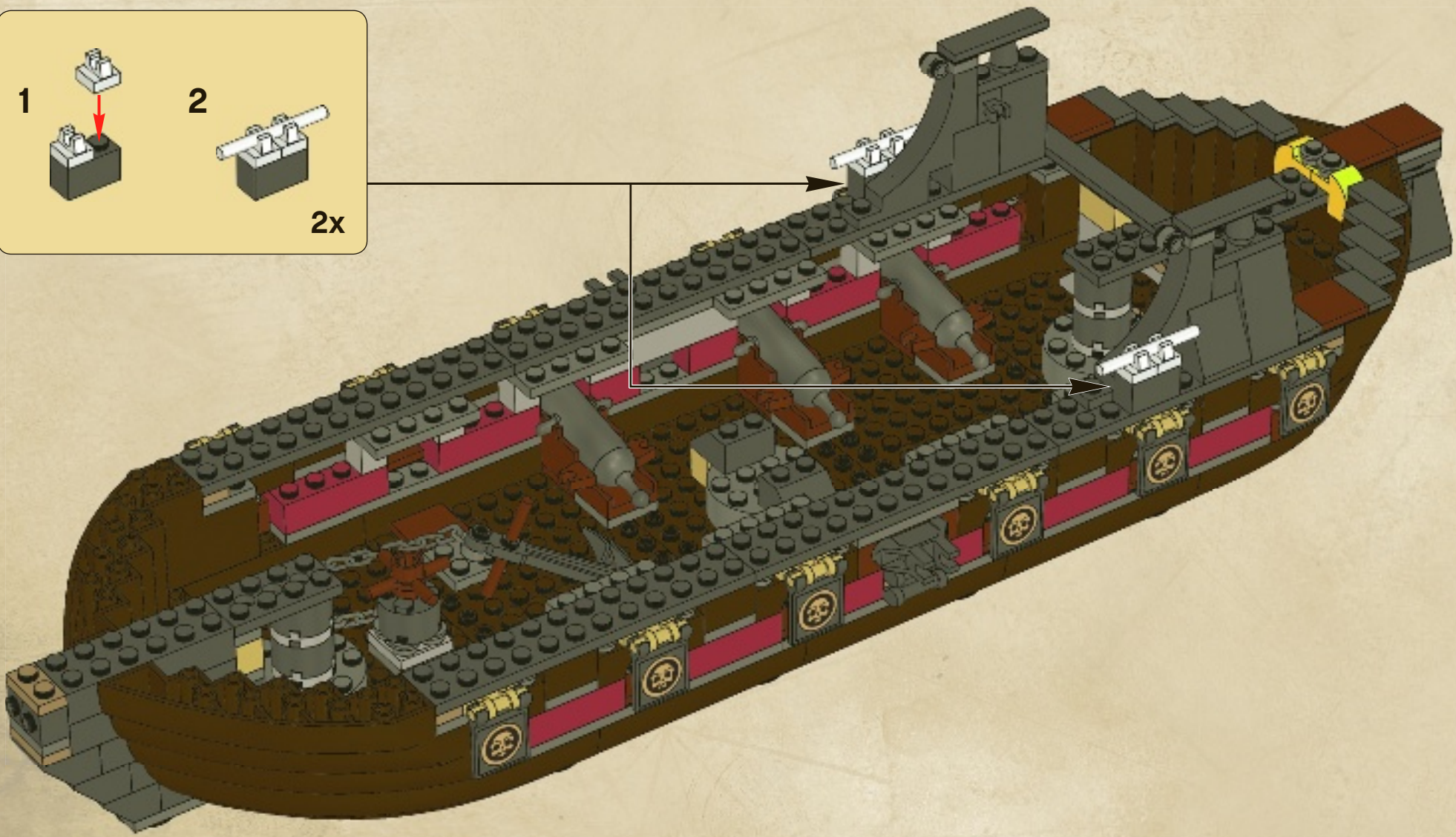

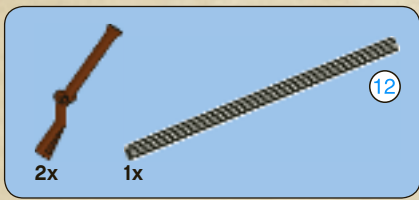

44

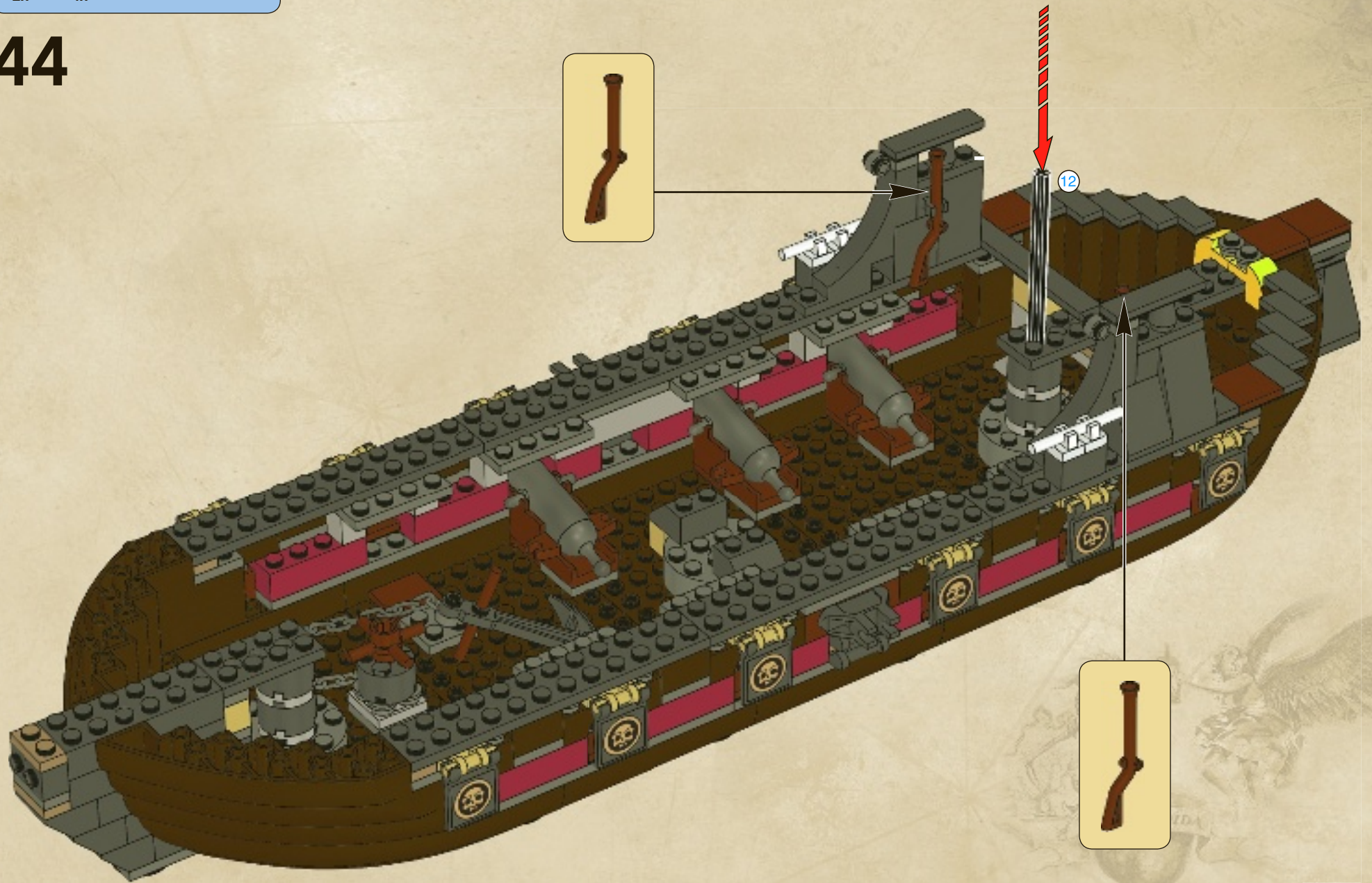

1x 1x

45

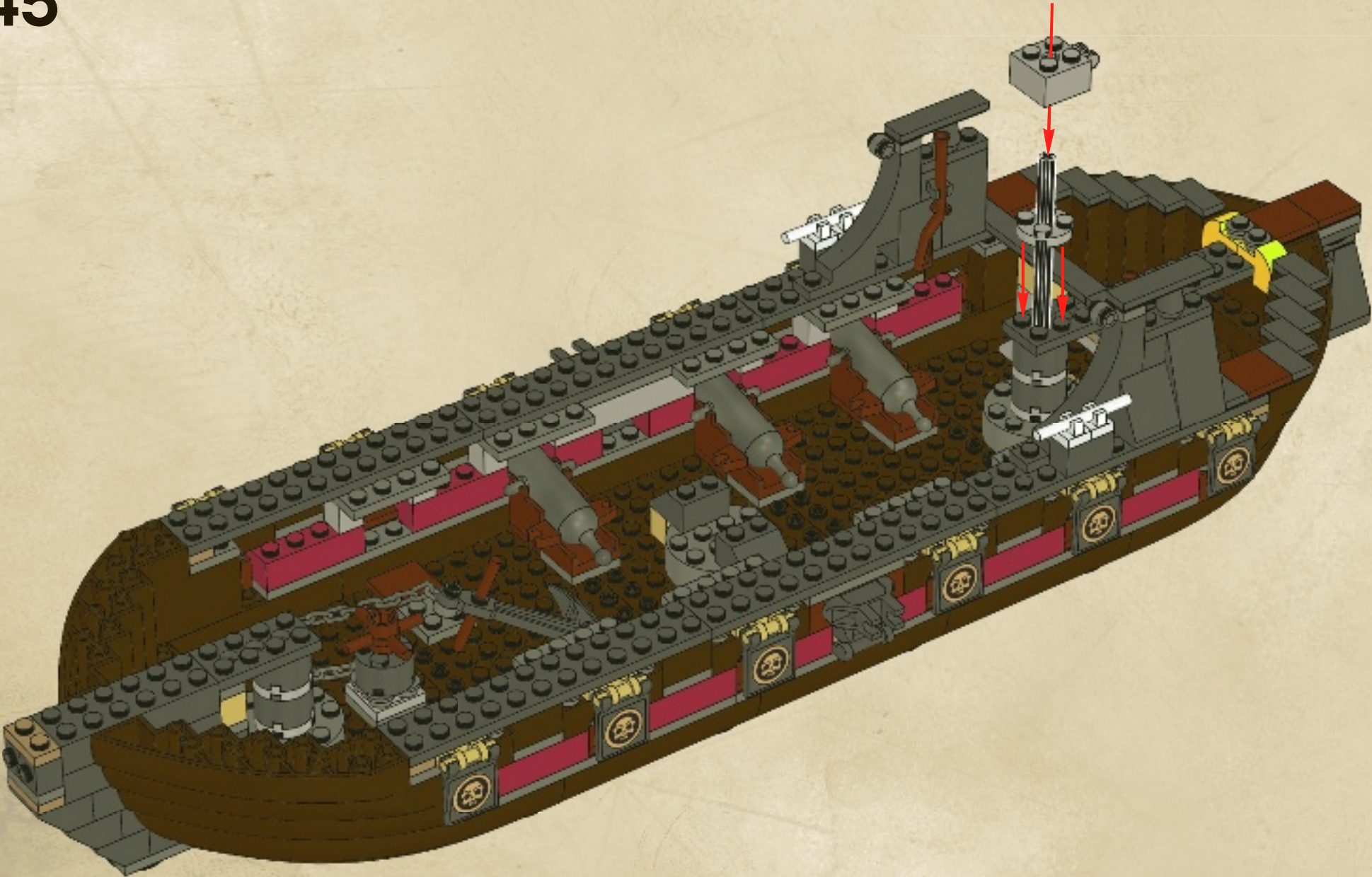

1x 1x

46

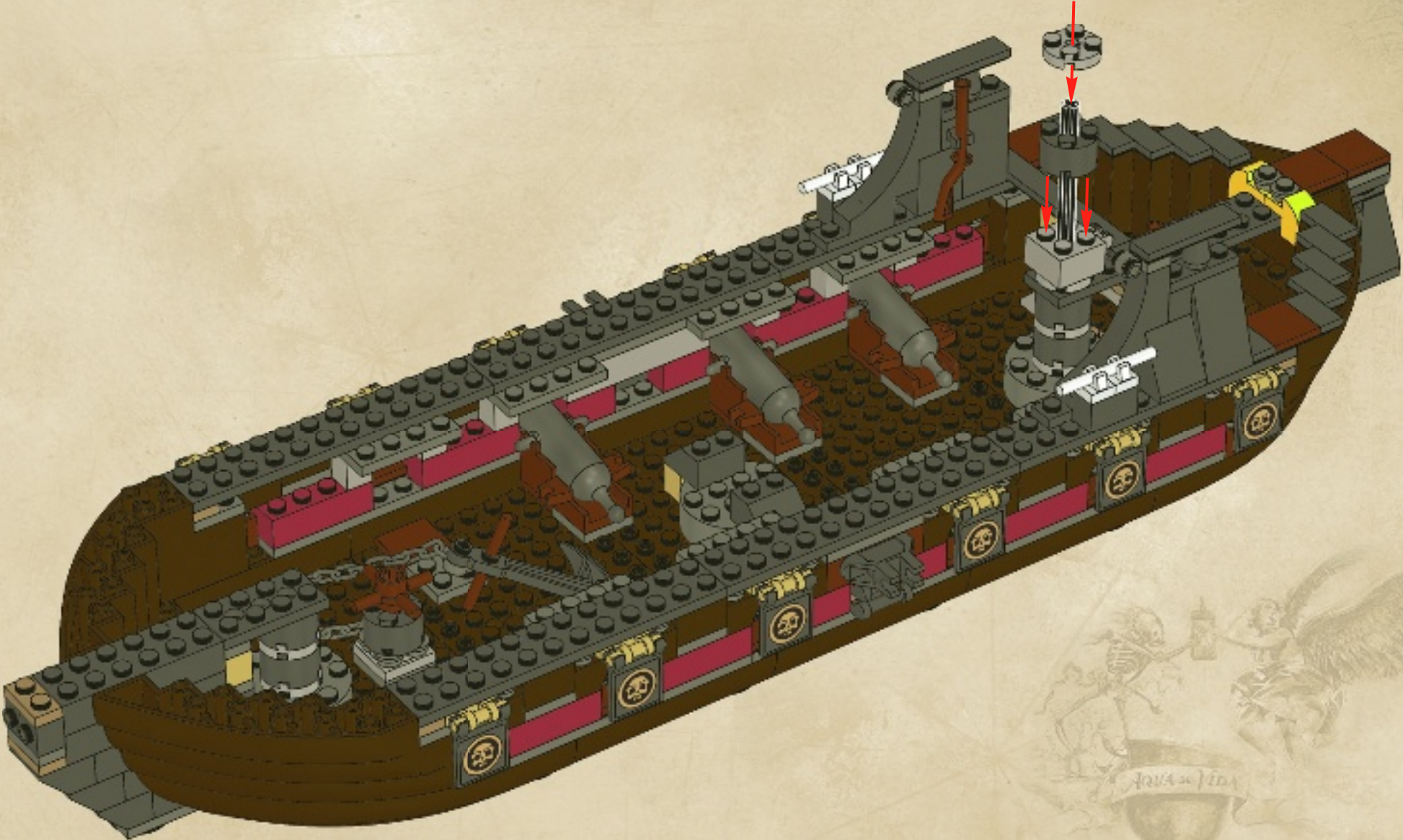



47

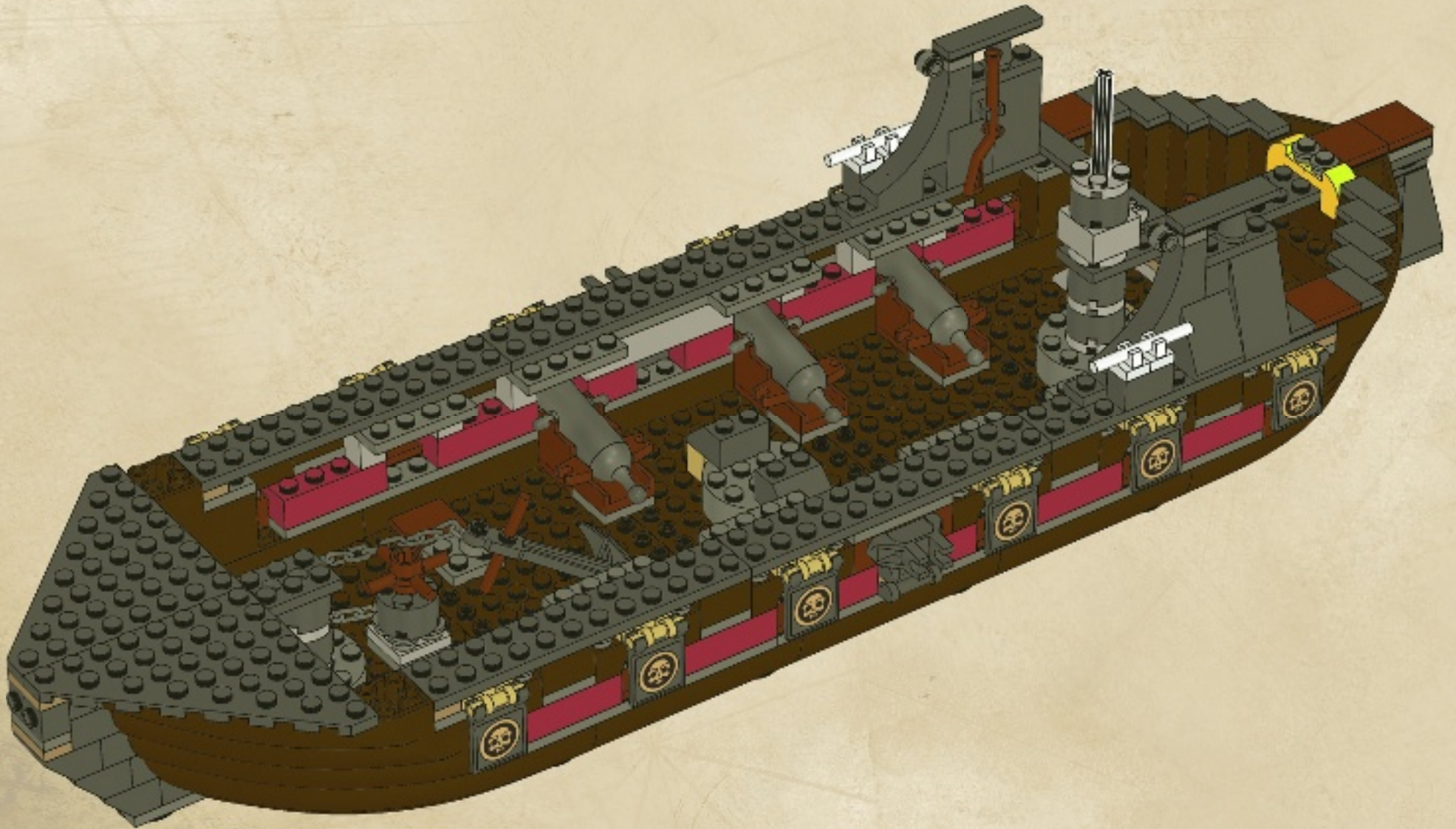



48

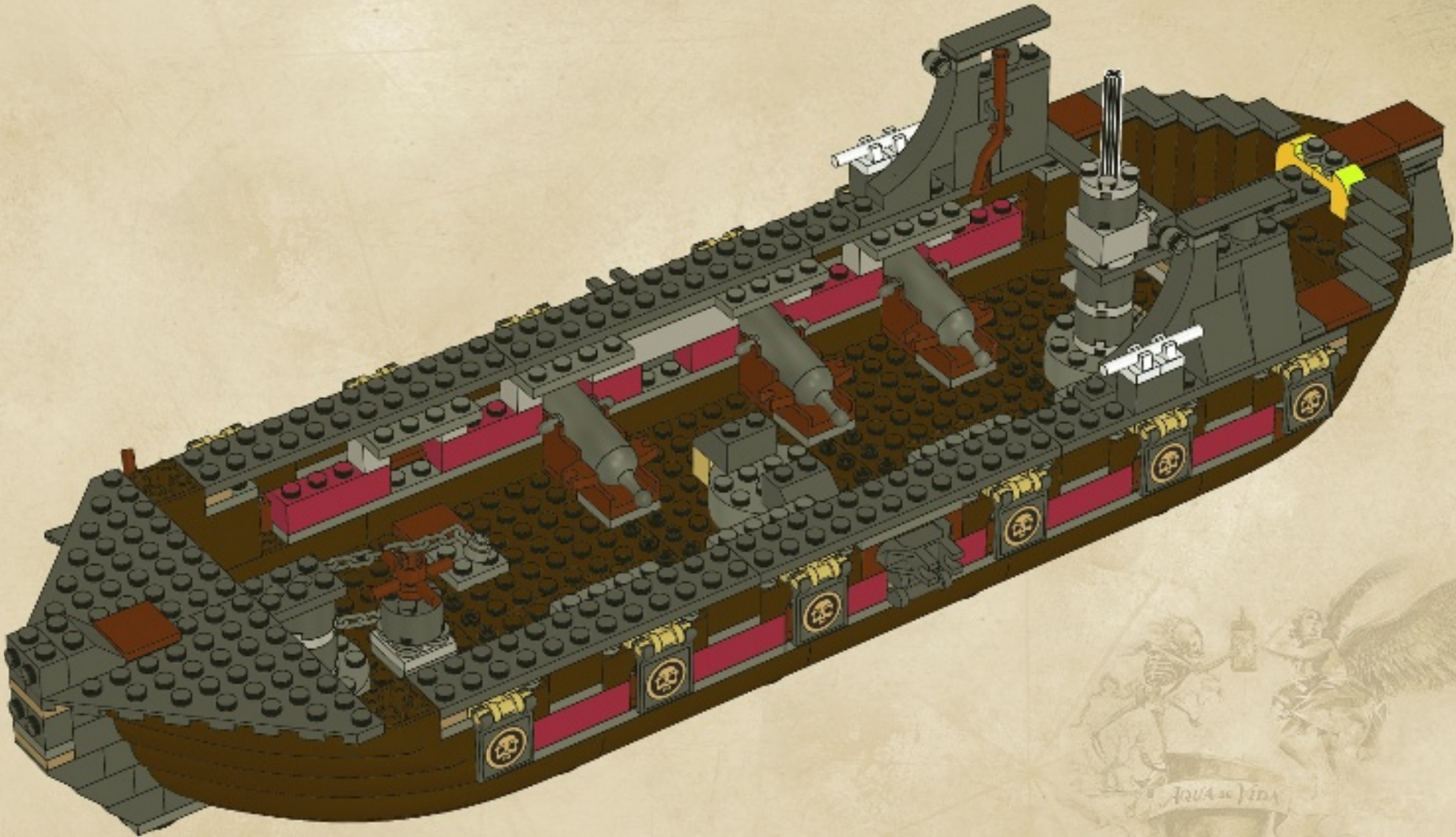



49

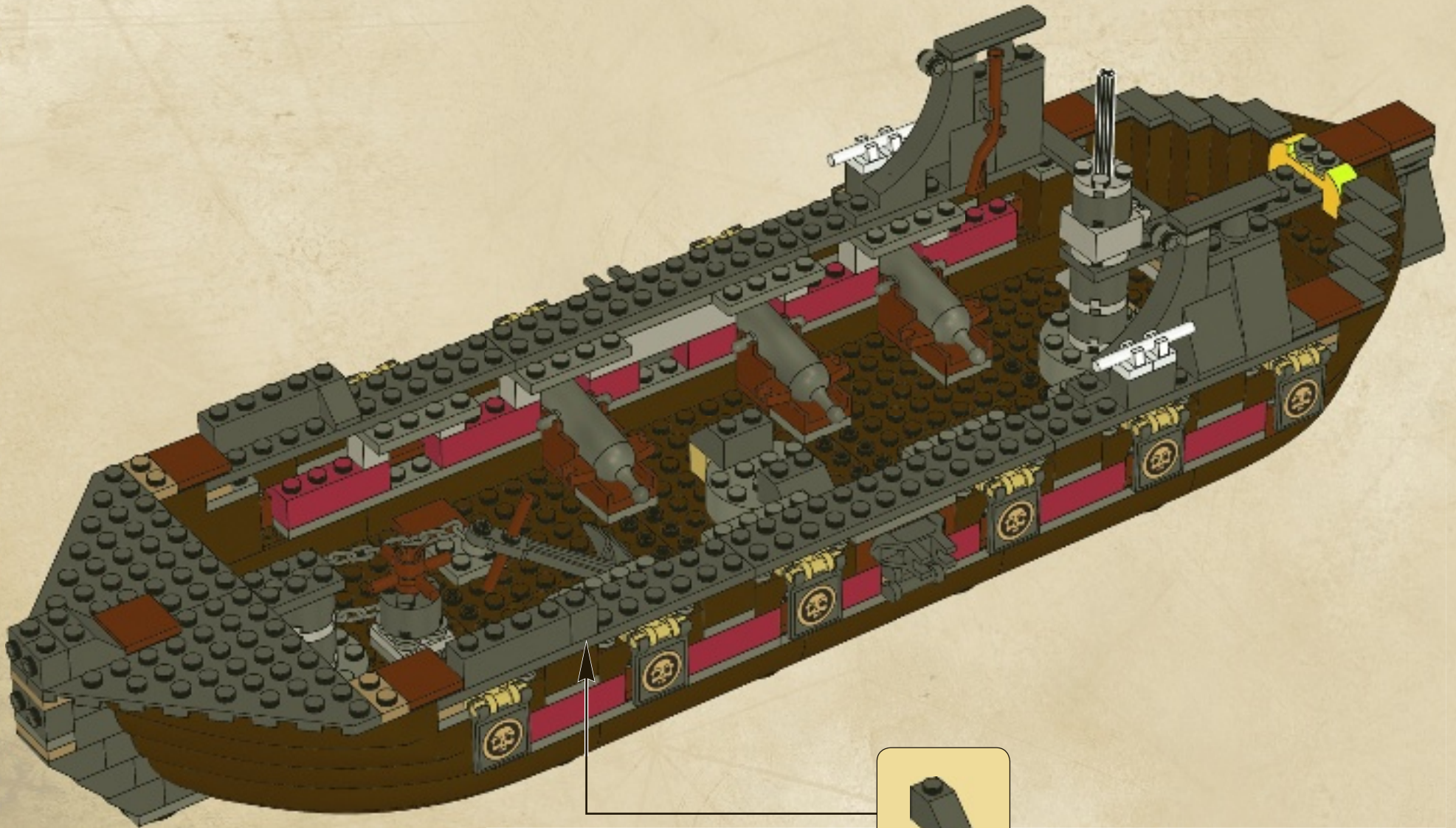



50

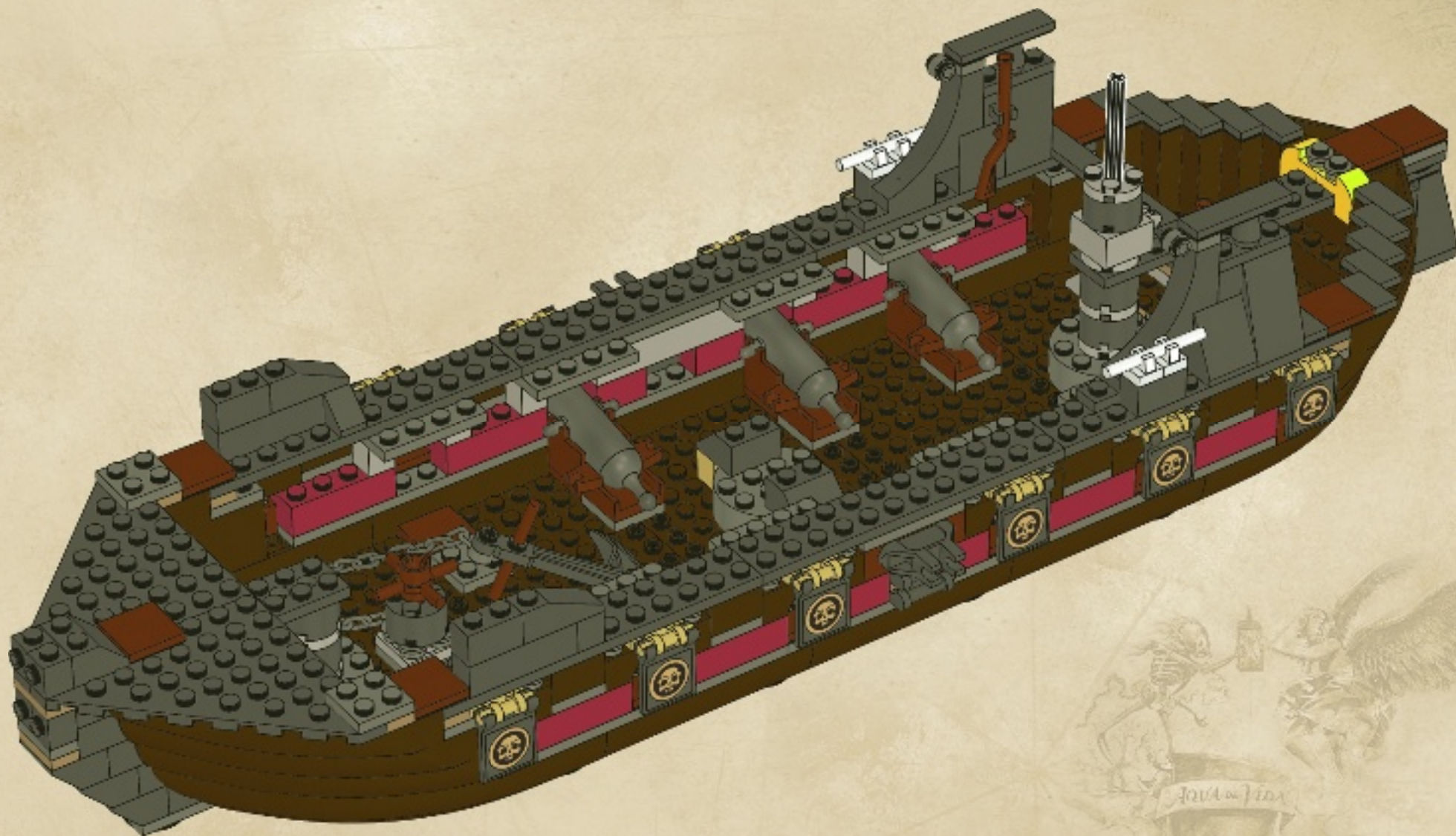

2x  2x 

51

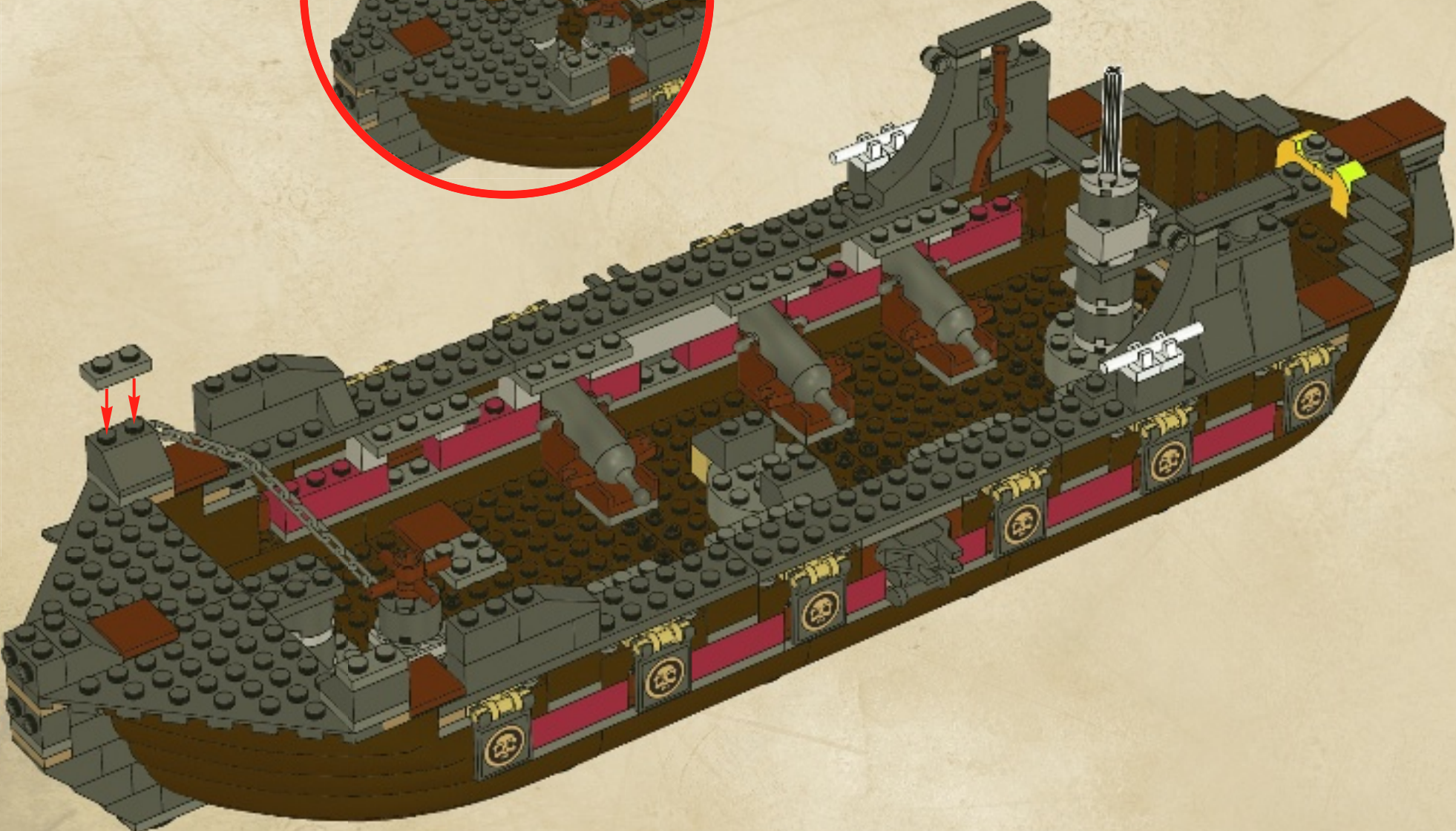
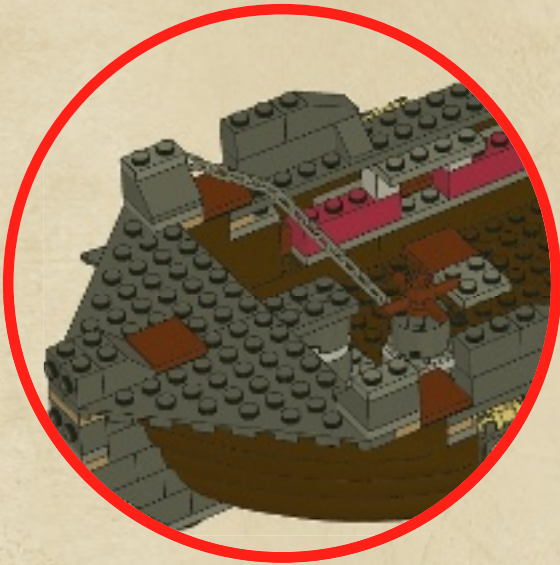

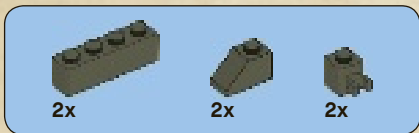

52

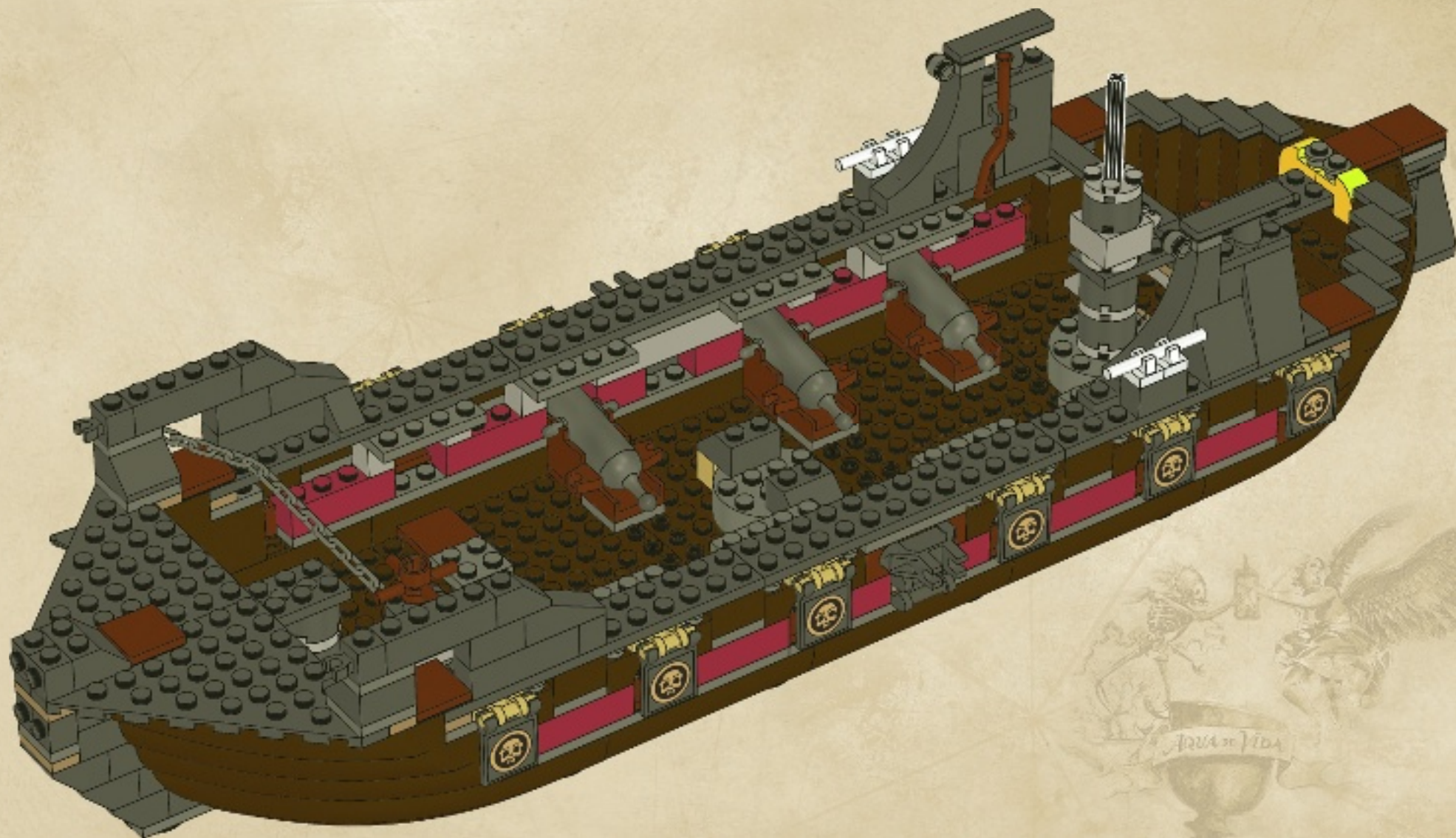





4x

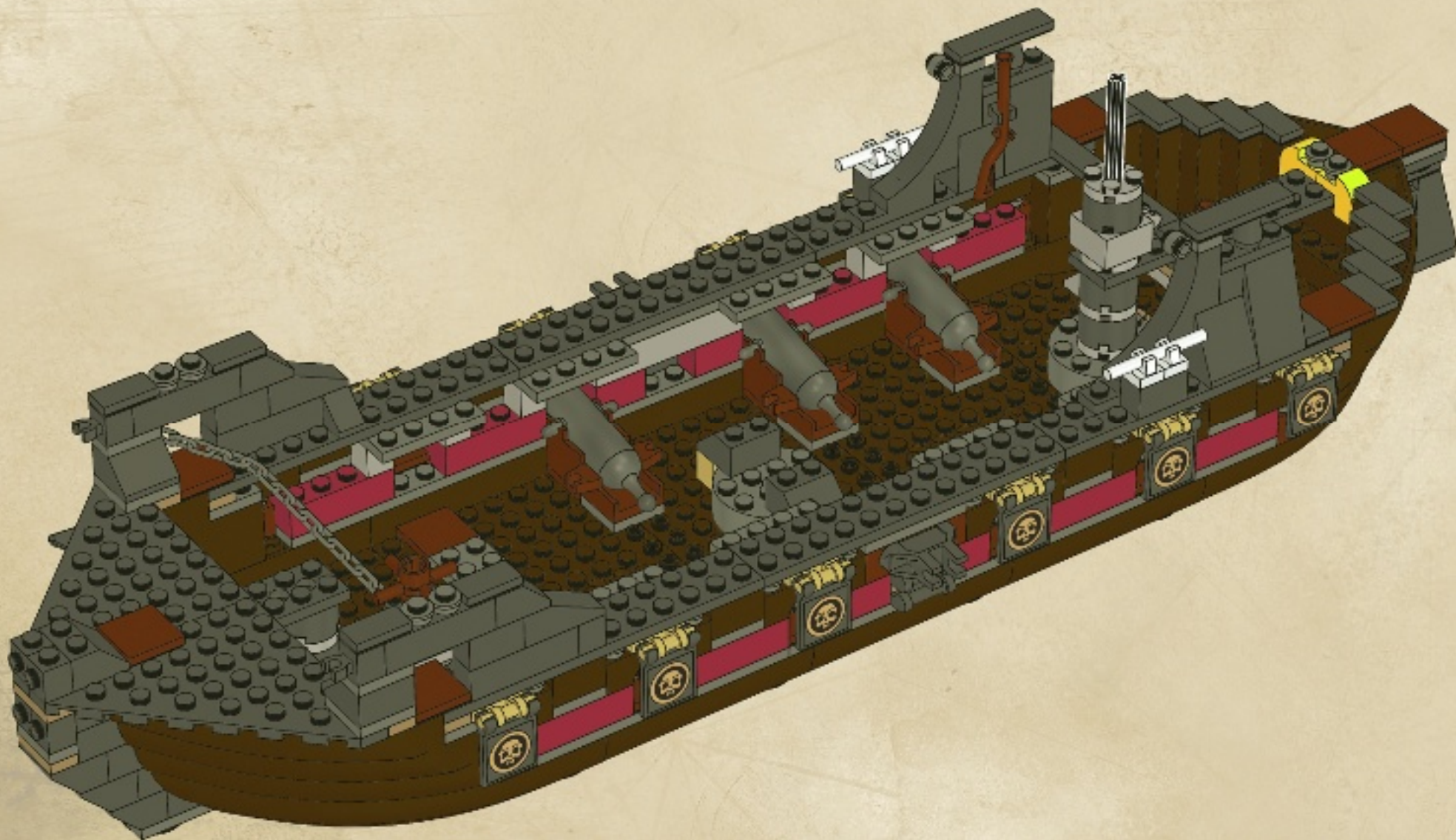

4x

53



4x  2x 

54

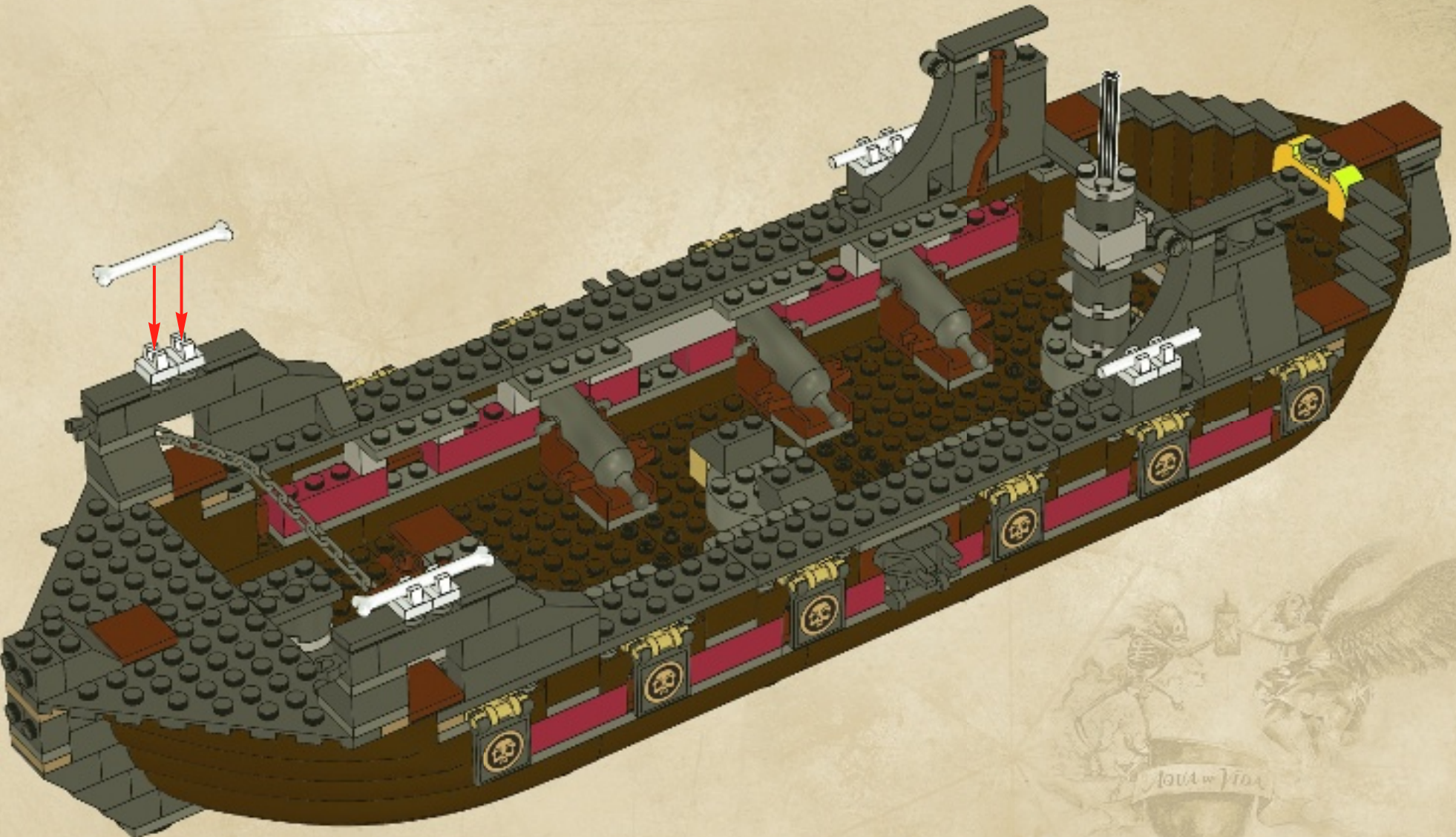



55

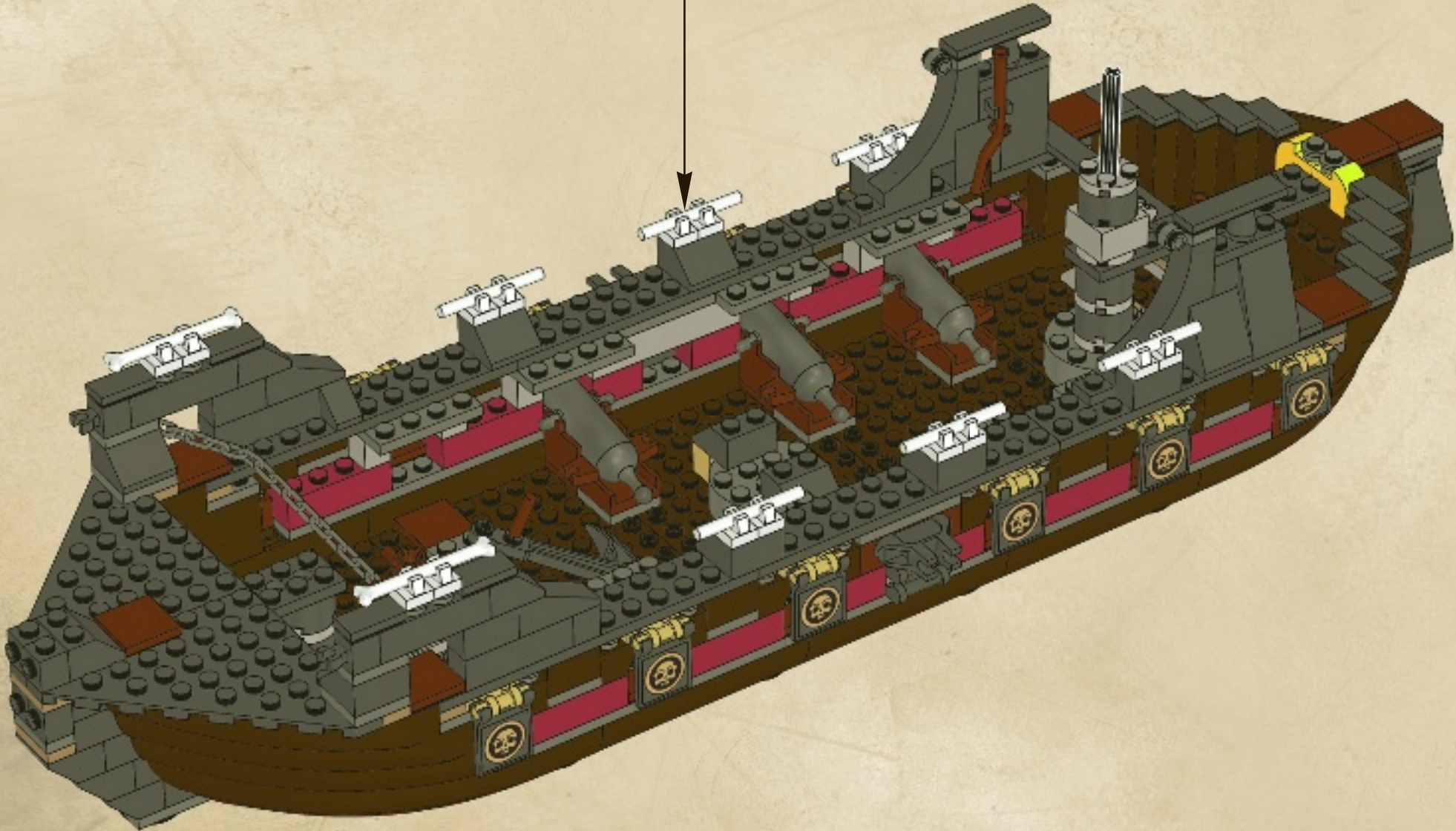
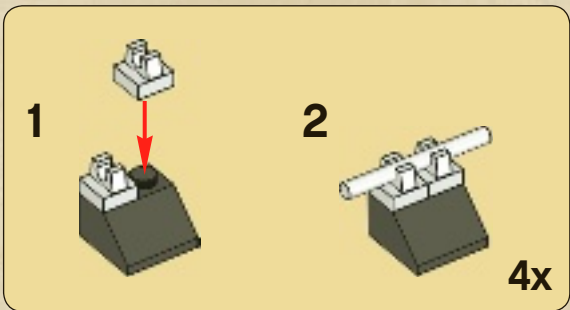

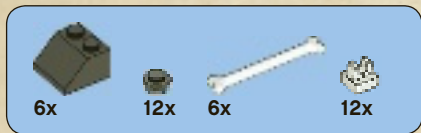

56

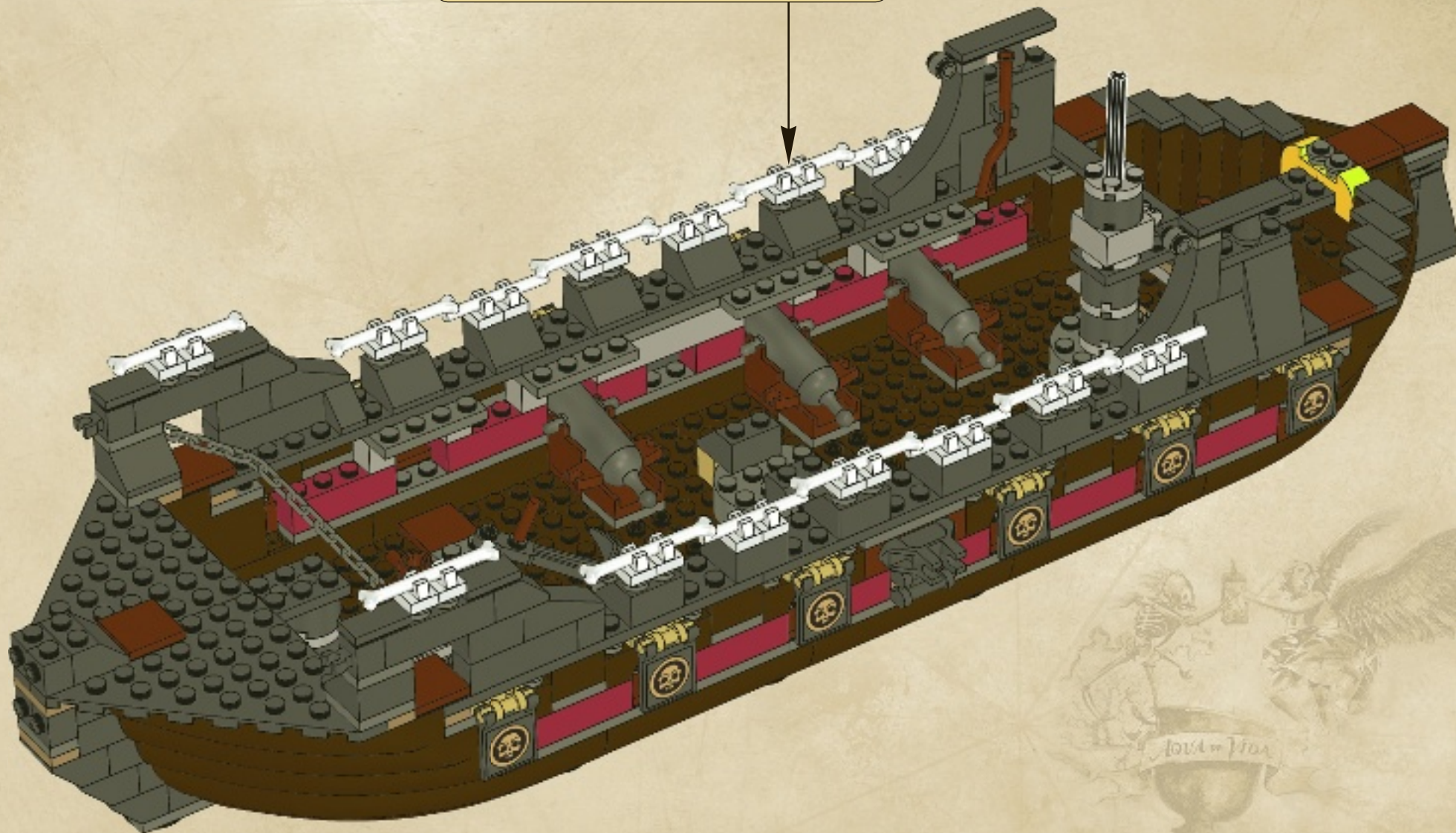
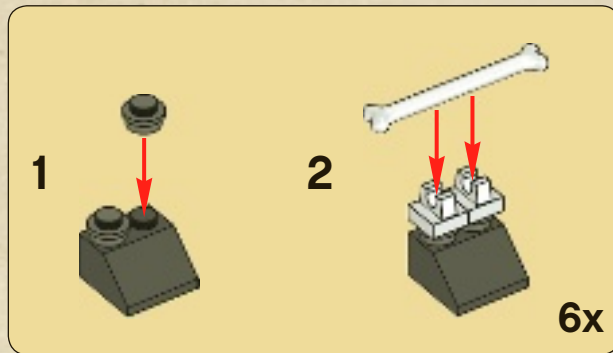

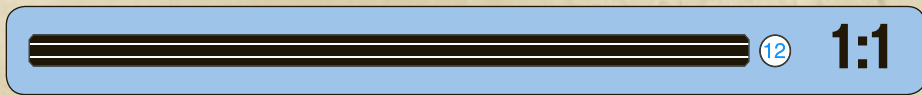
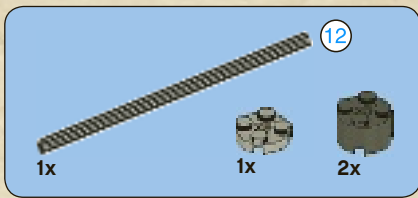

57

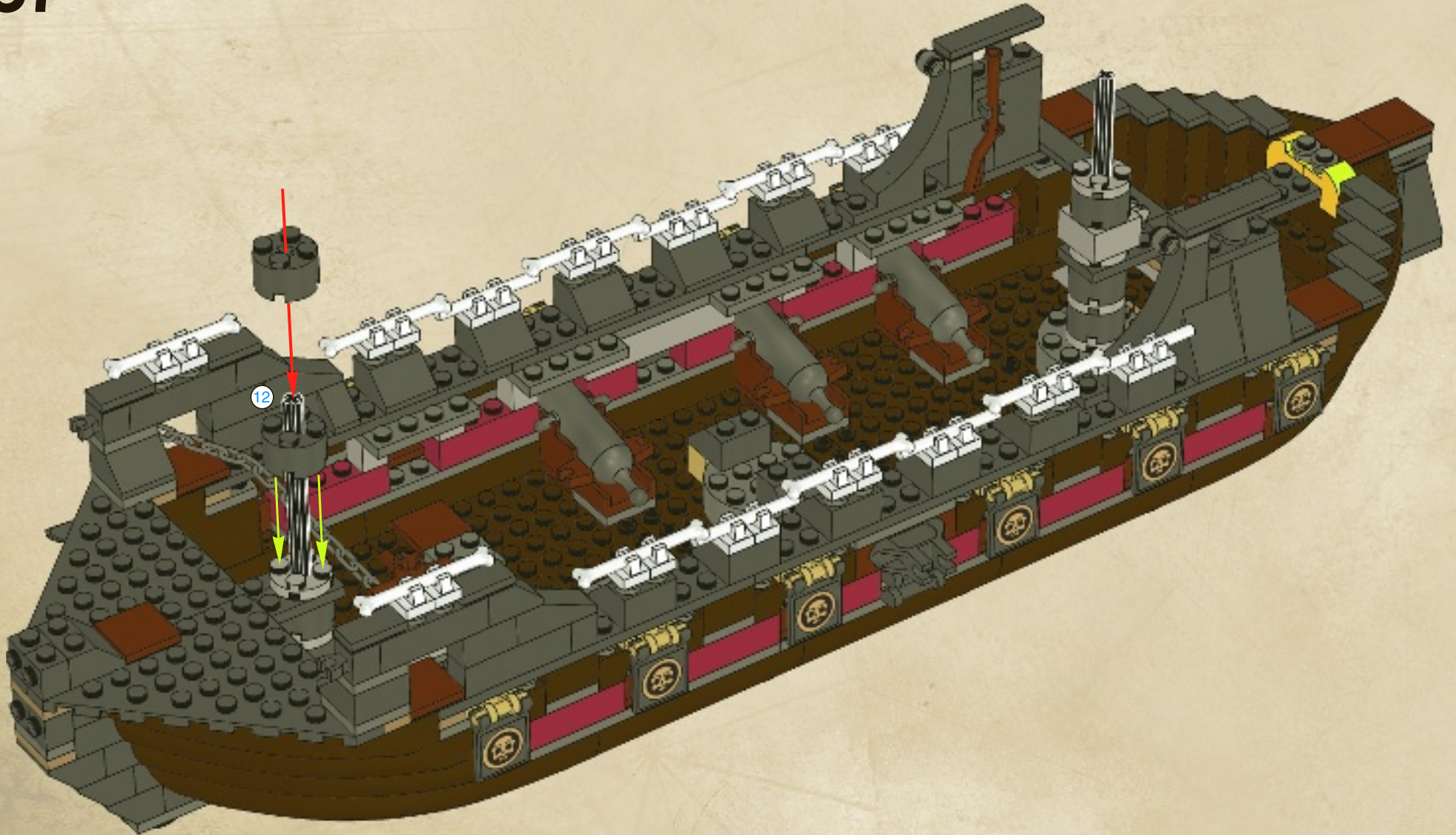

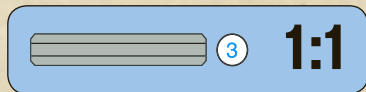

58

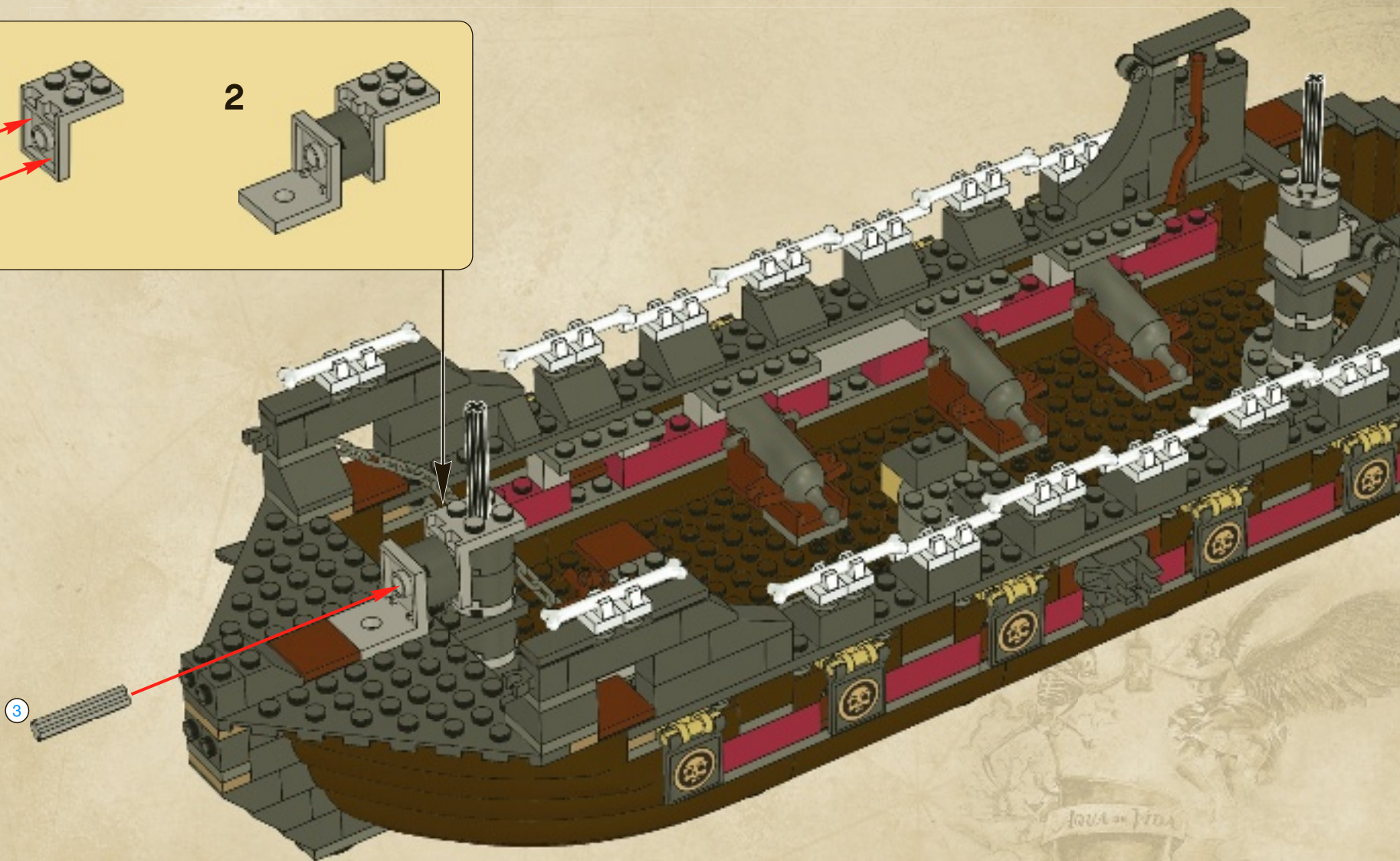
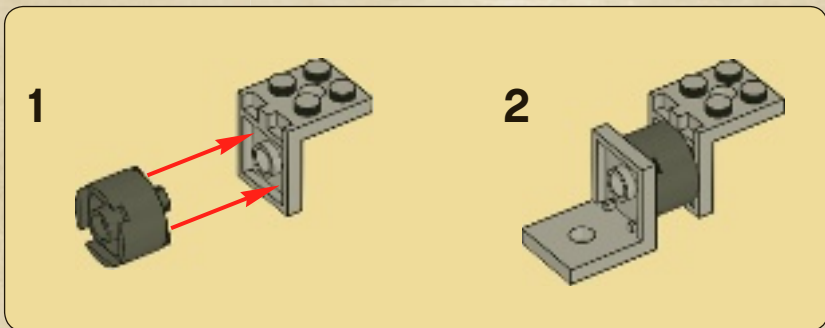



4x

59

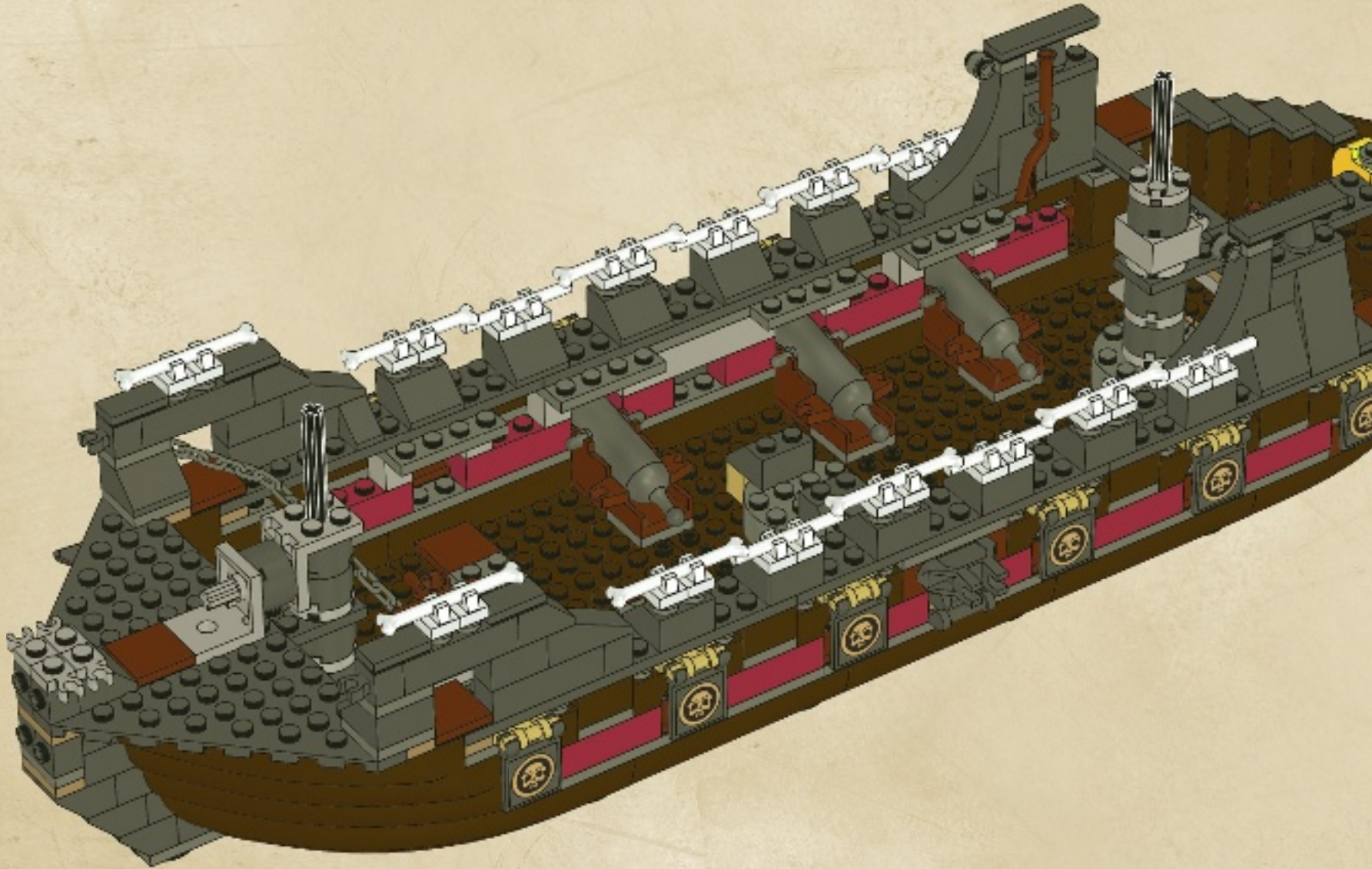



1x



2x

60

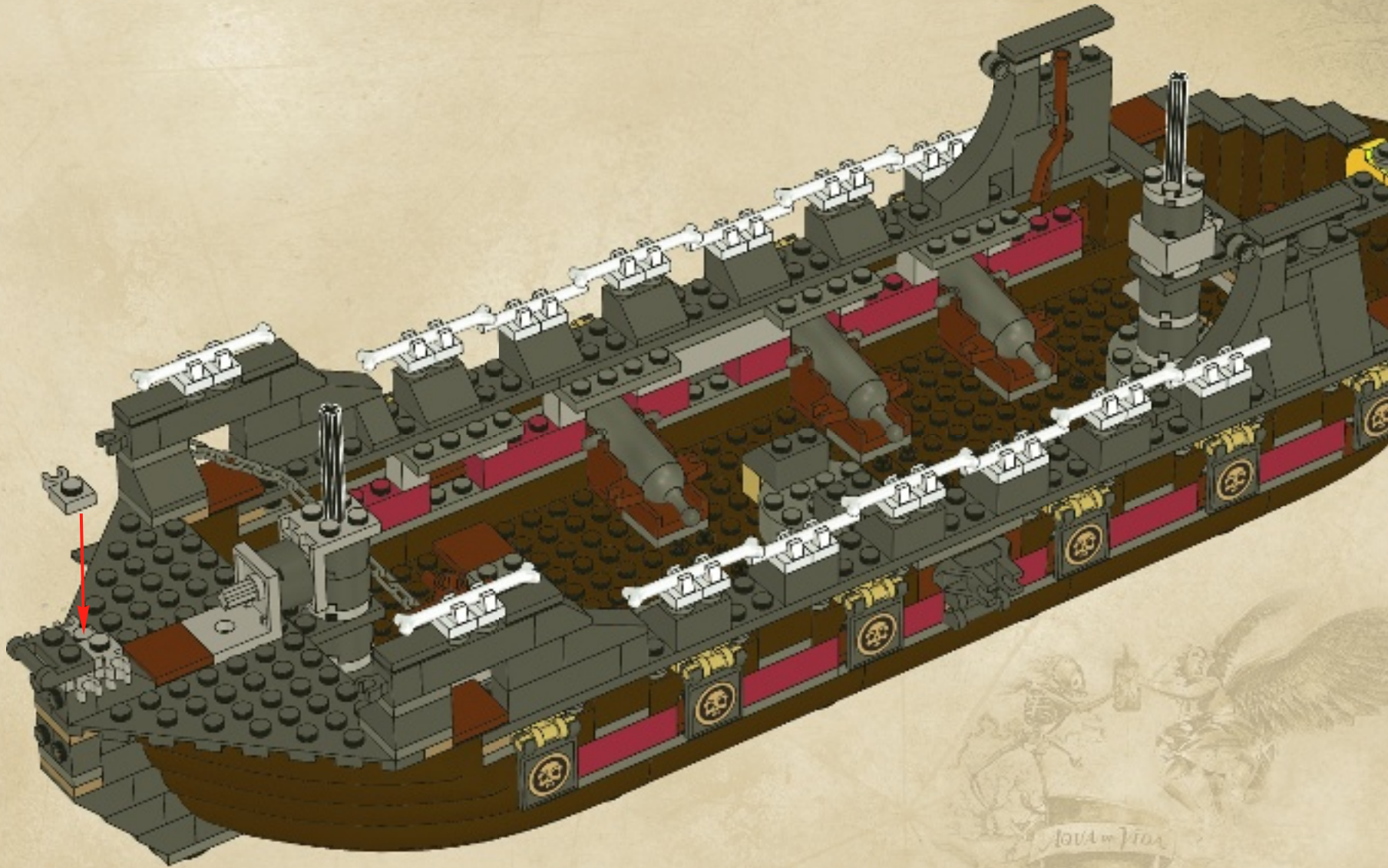

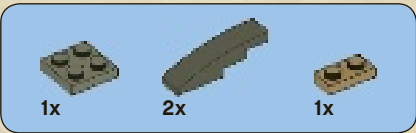

61

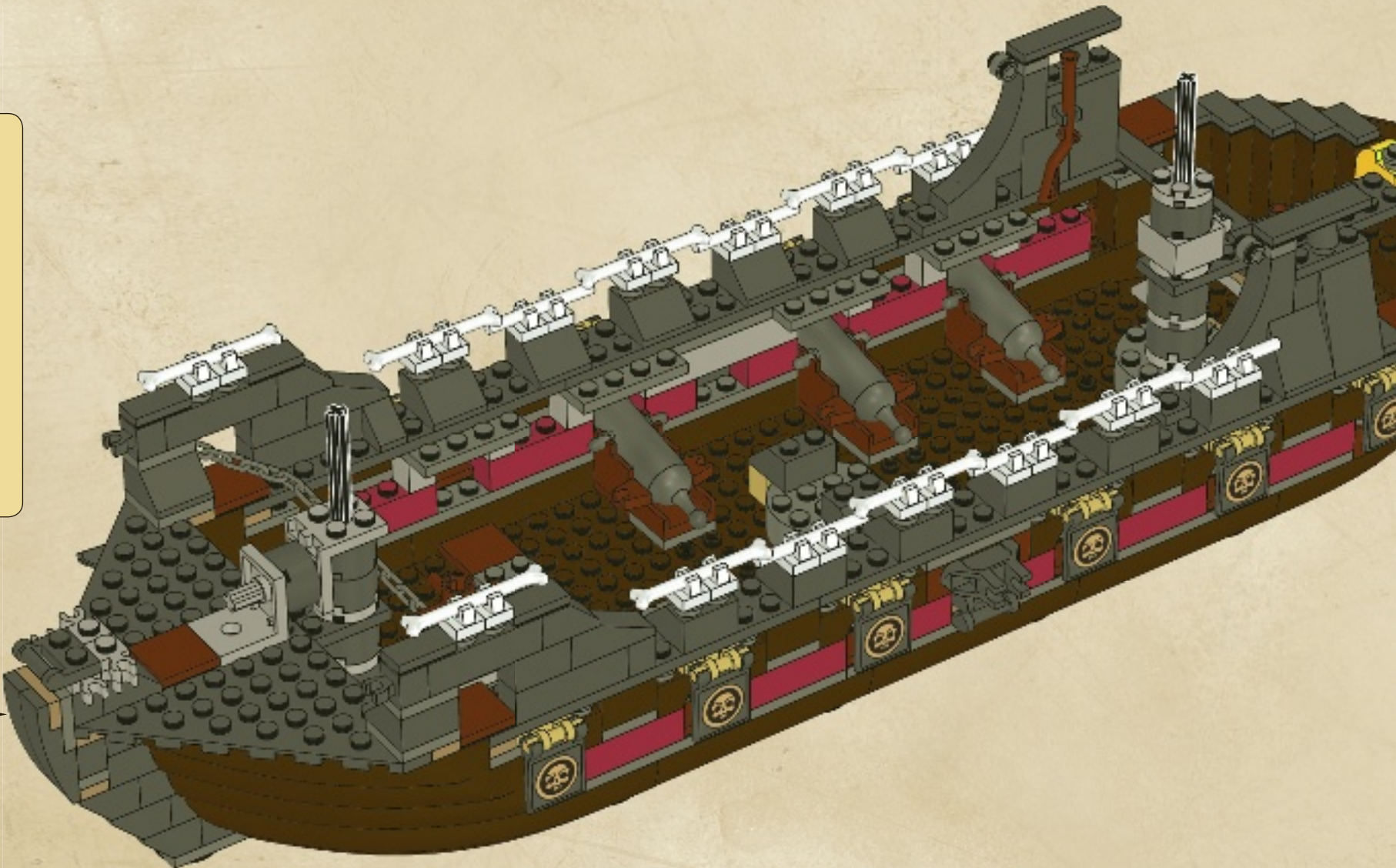
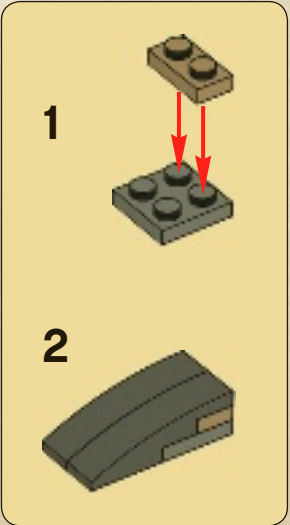

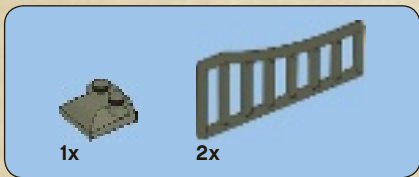

62

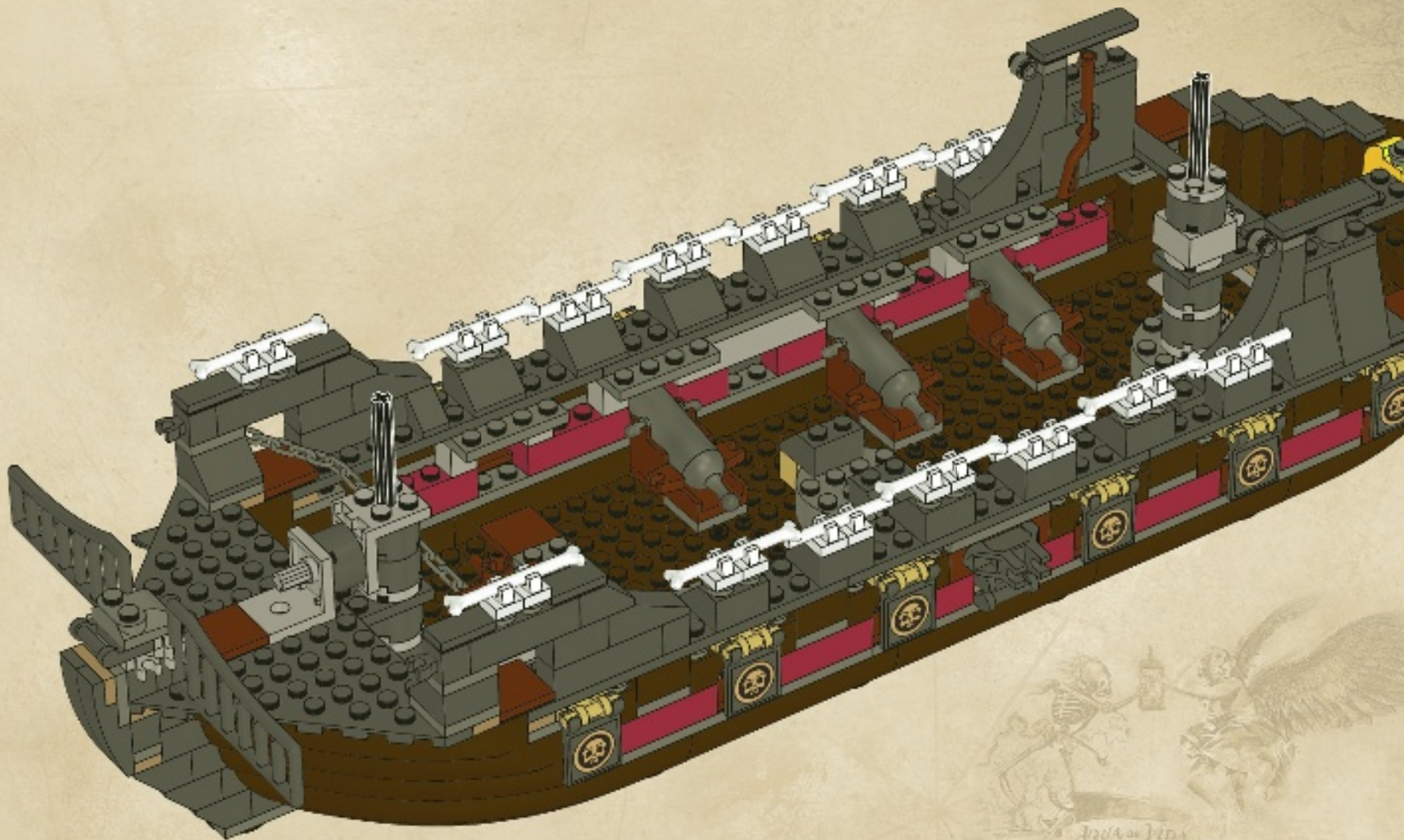

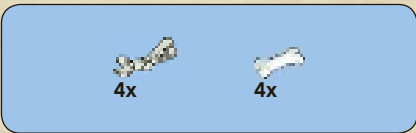

63

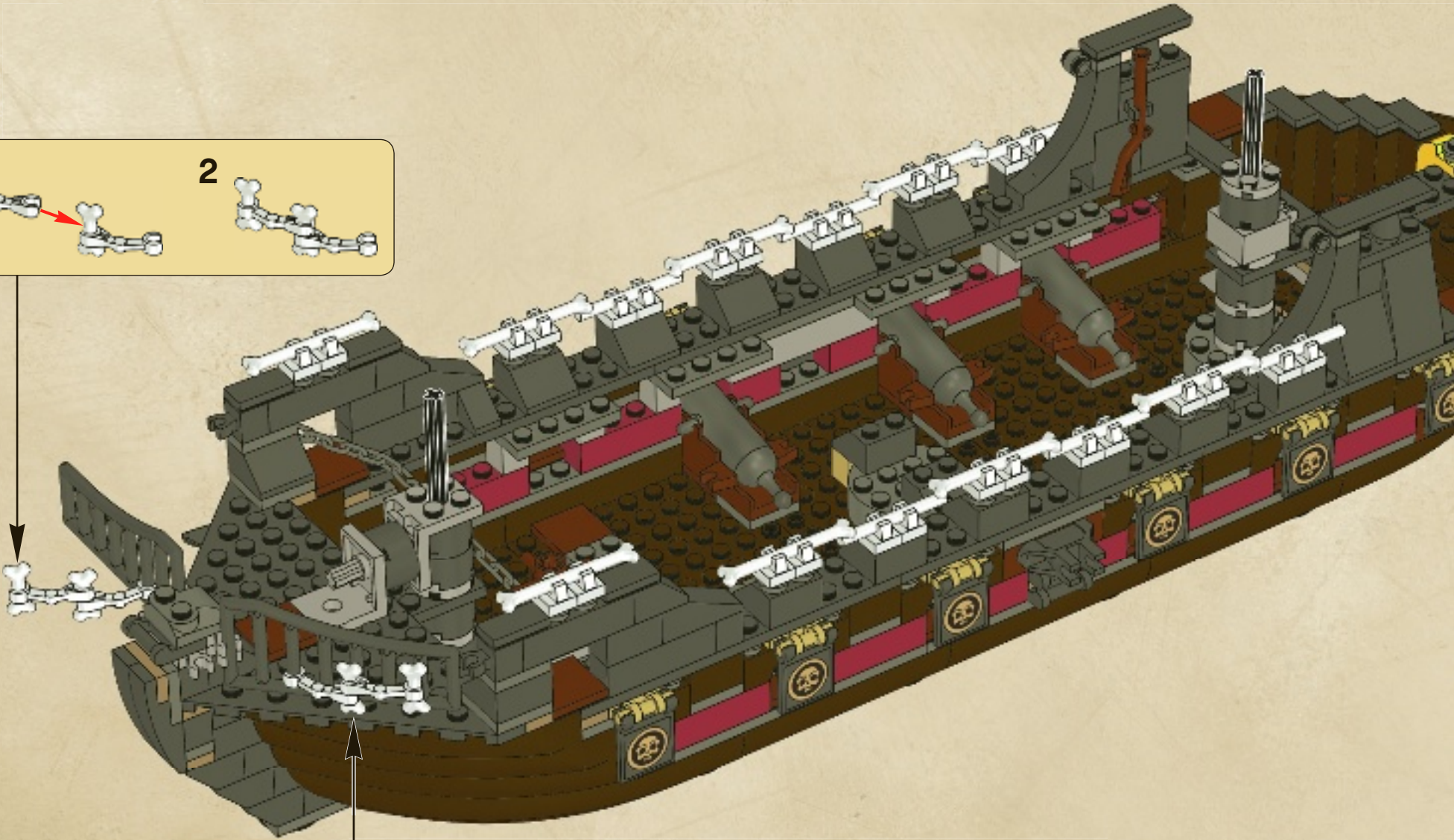



64

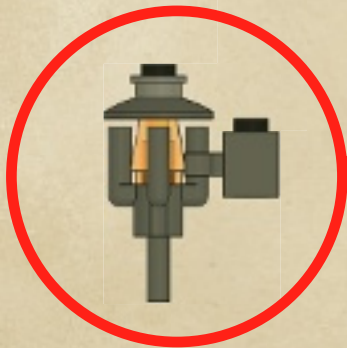
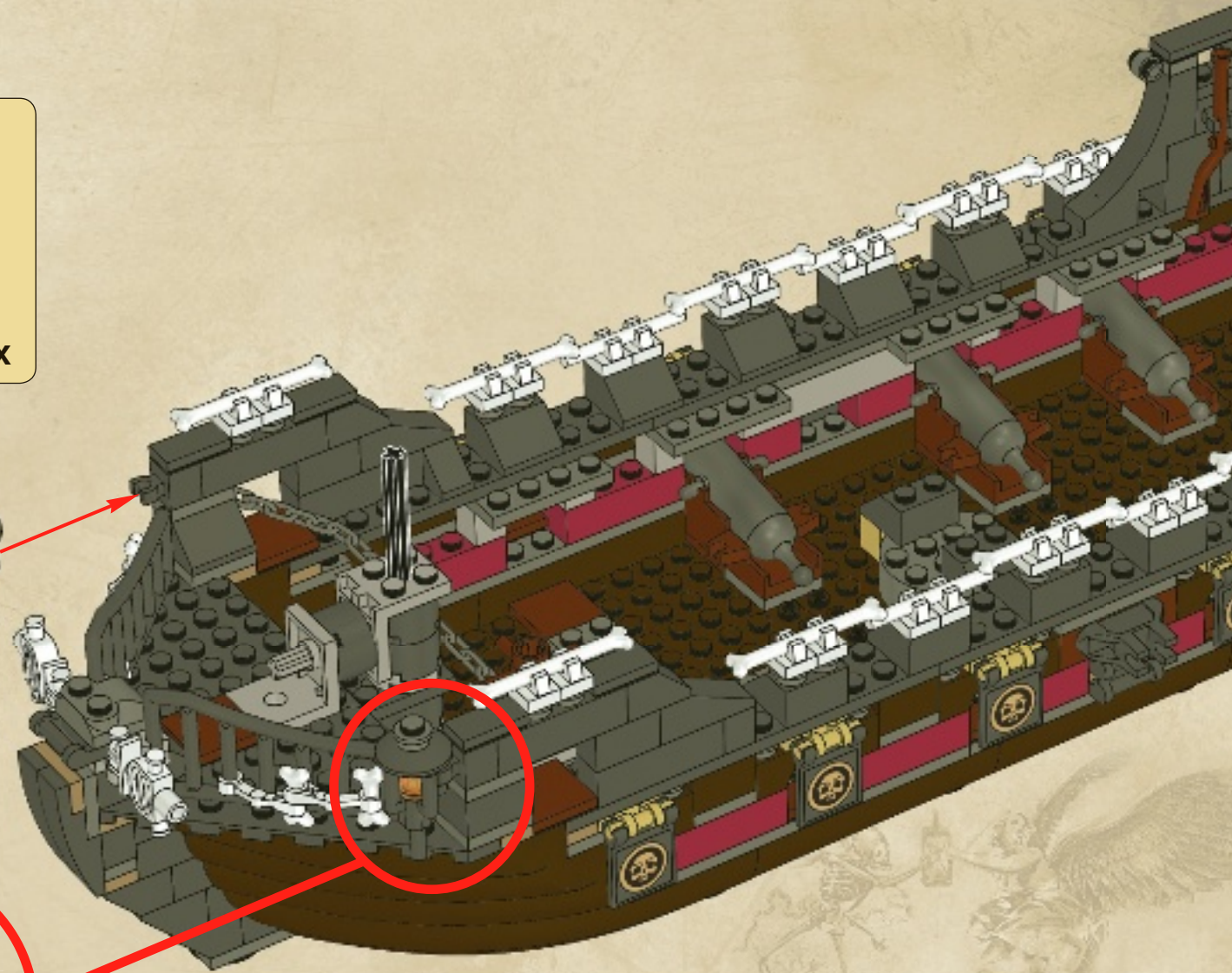
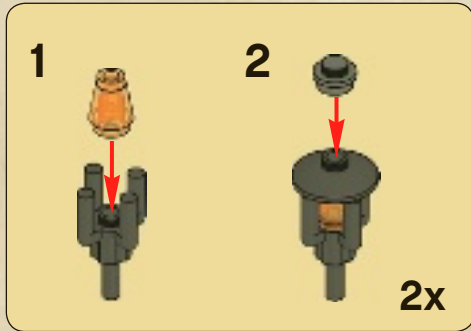

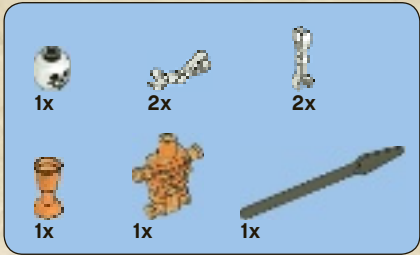

65

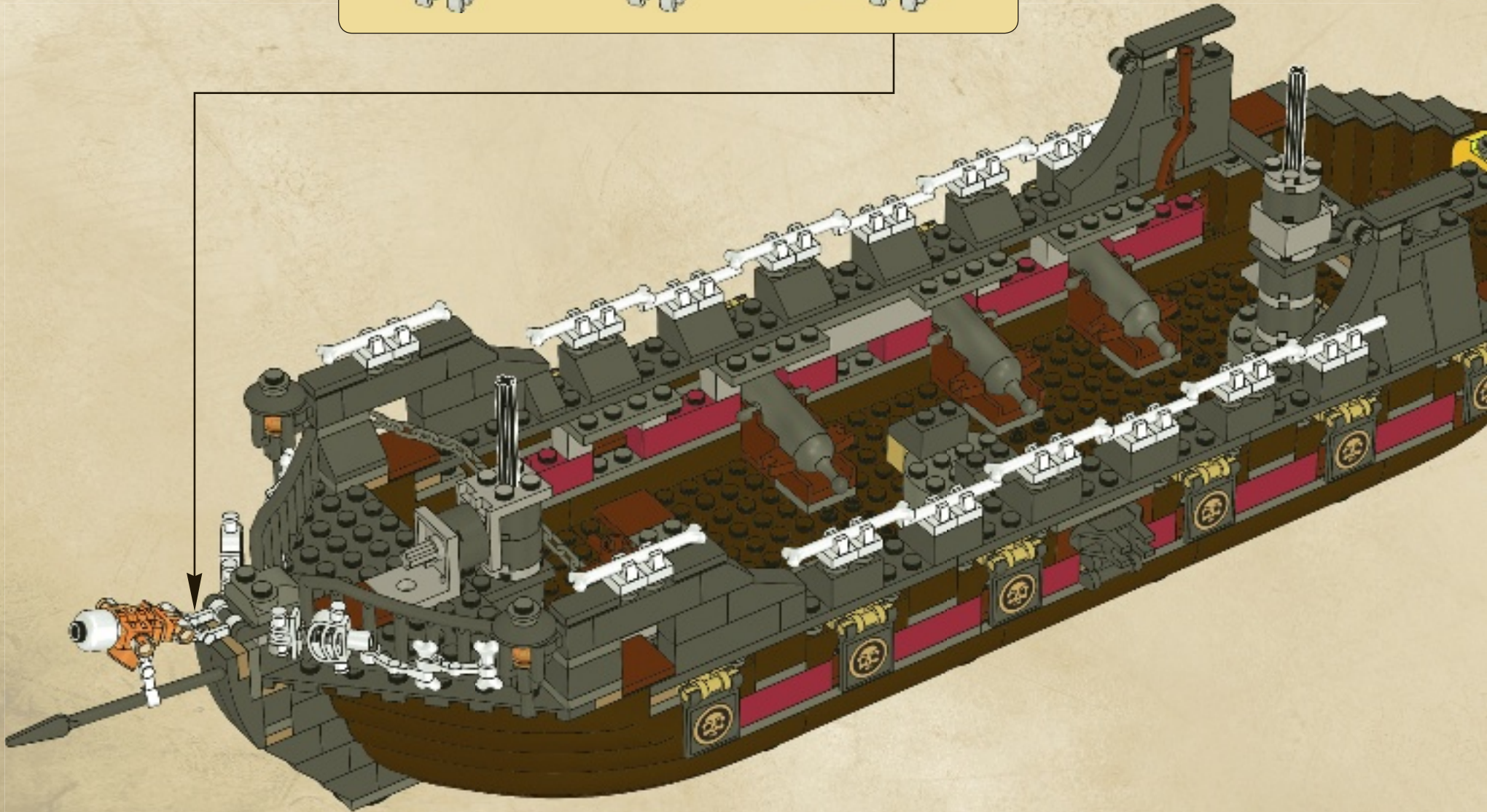
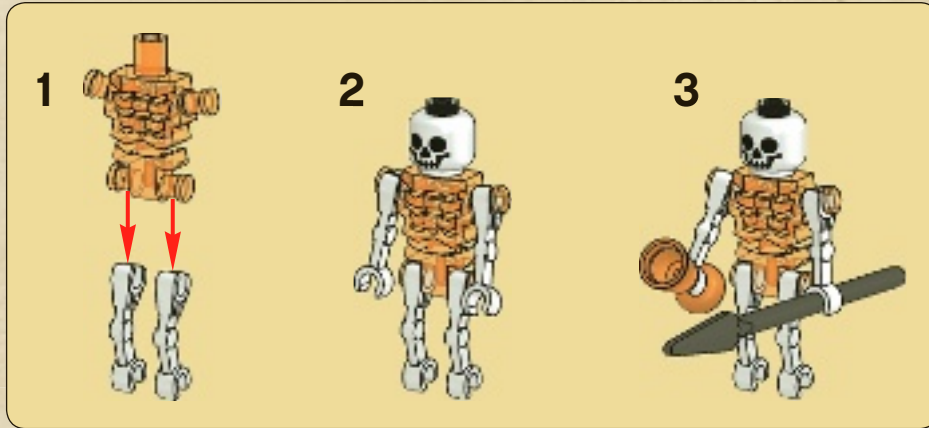

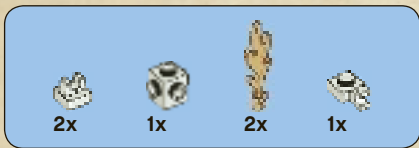

66

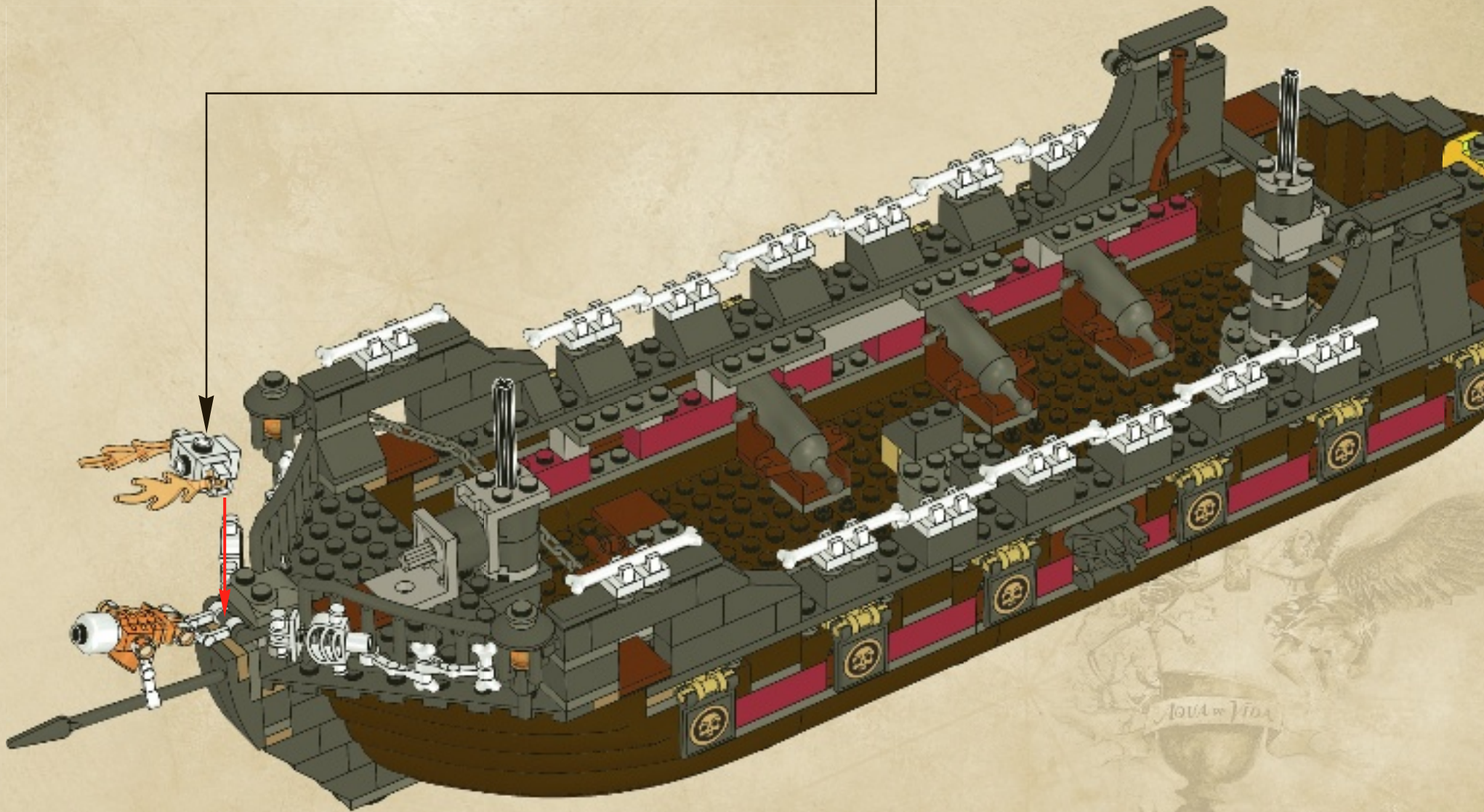
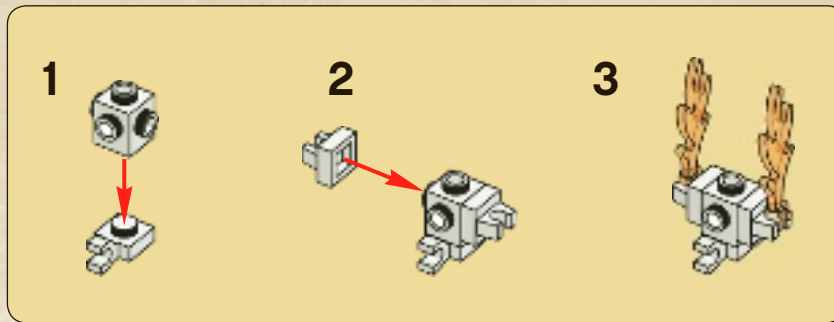

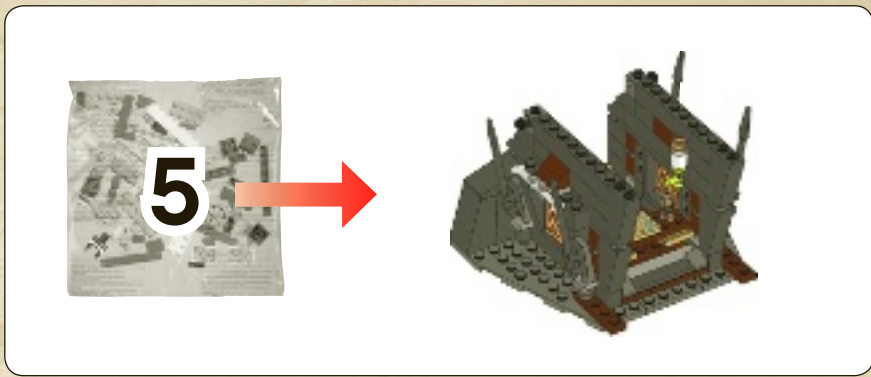

1

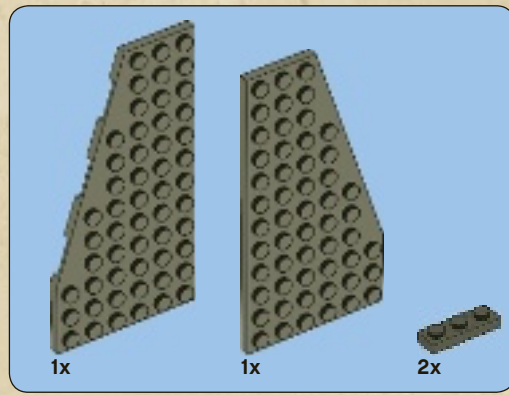
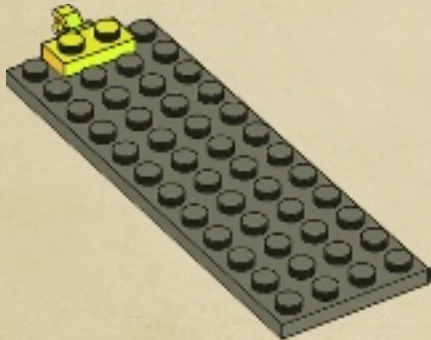

2

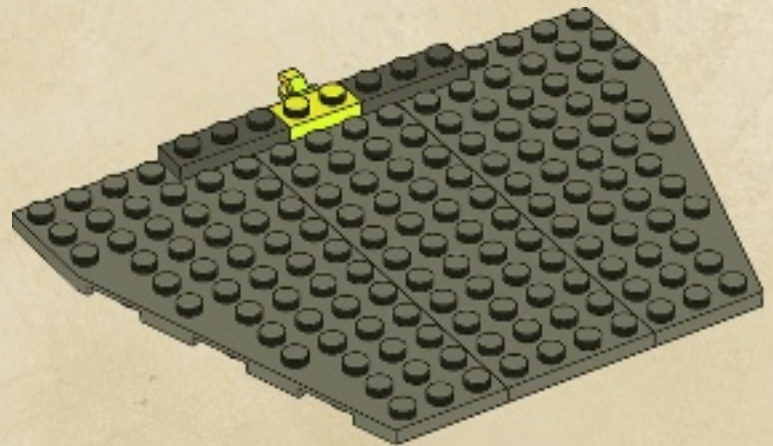

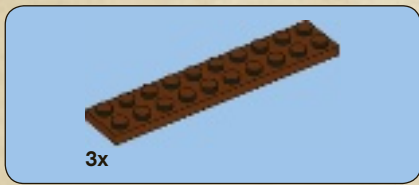

3

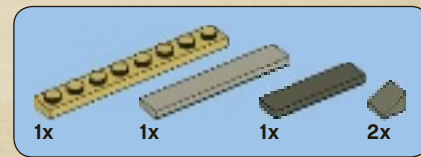
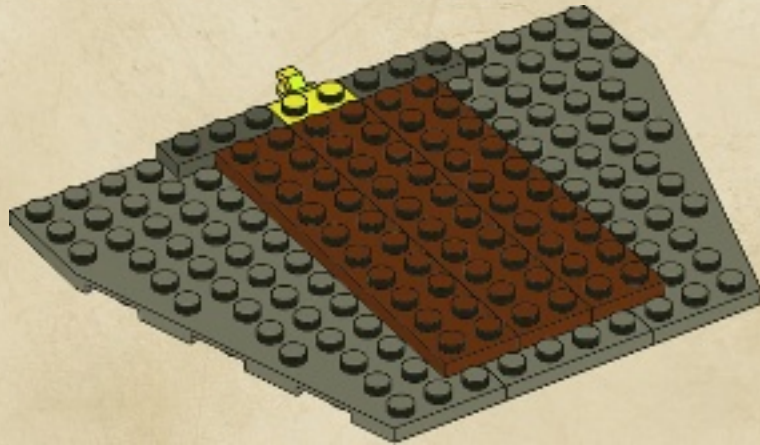

4

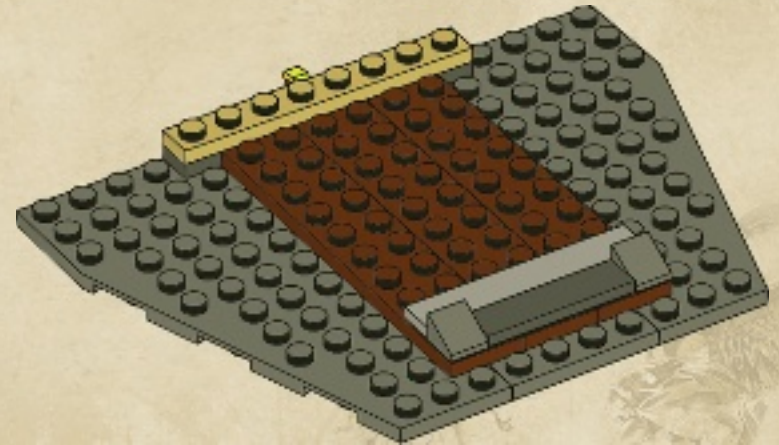

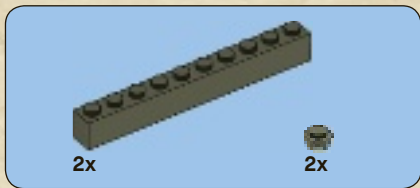

5

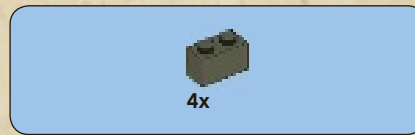
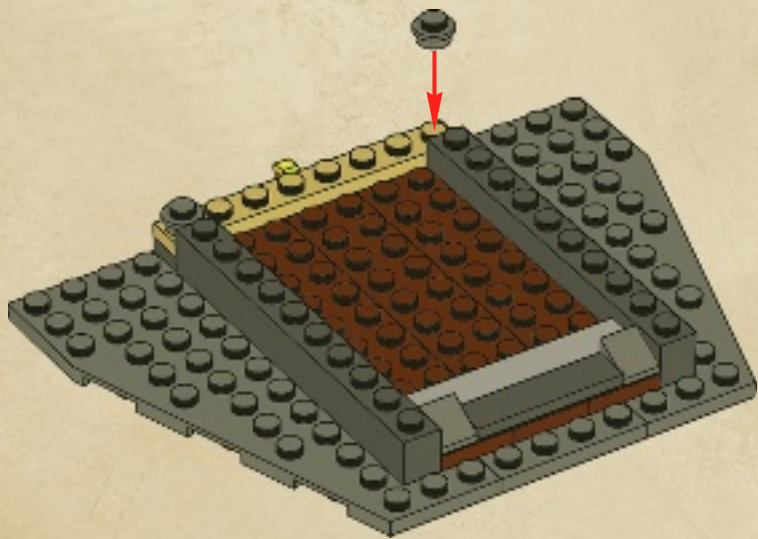

6

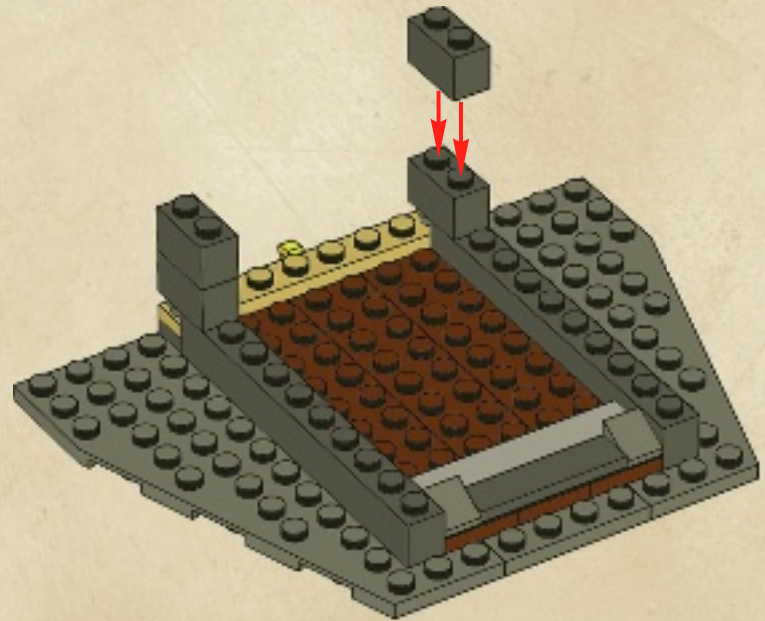

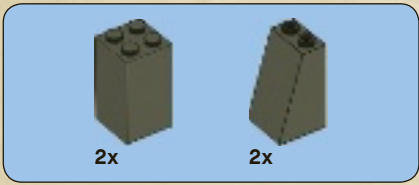

7

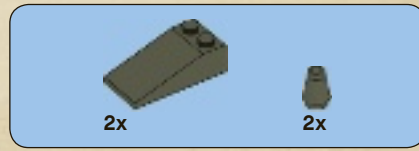
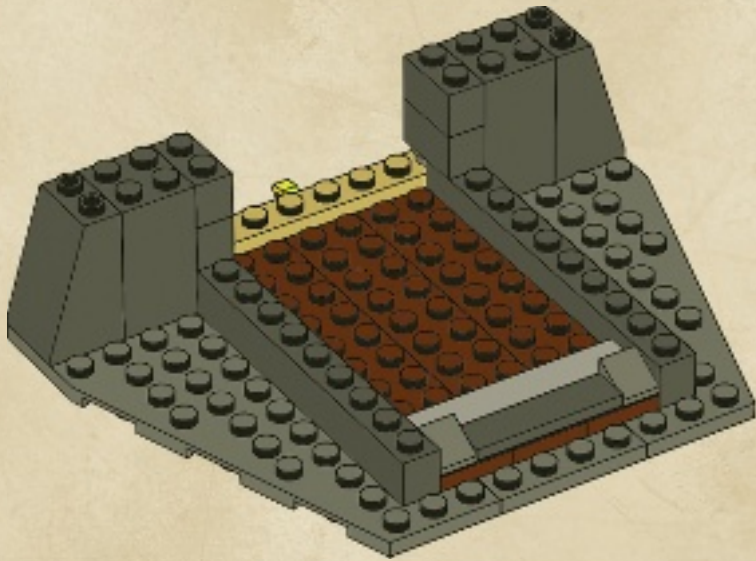

8

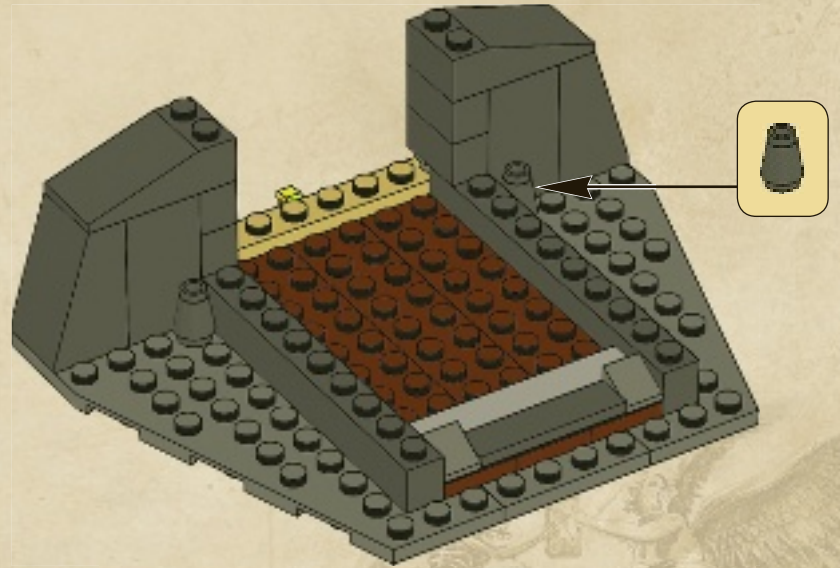



9

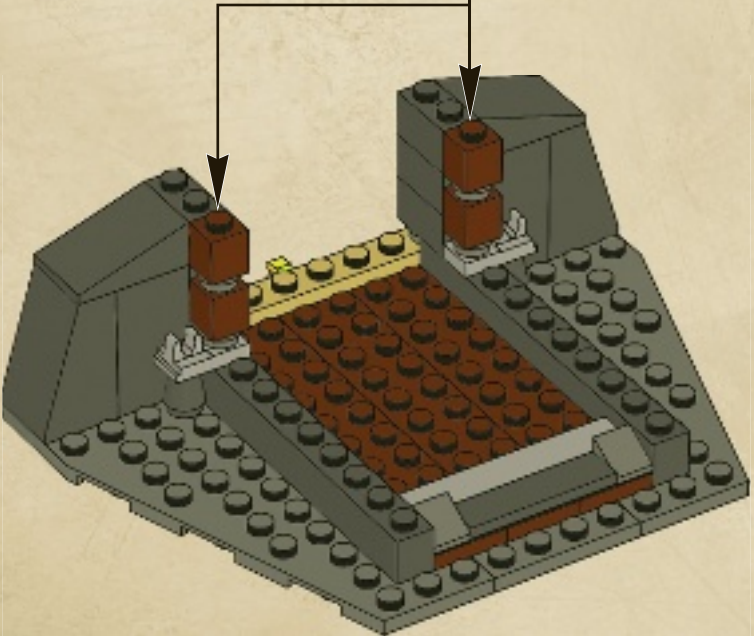
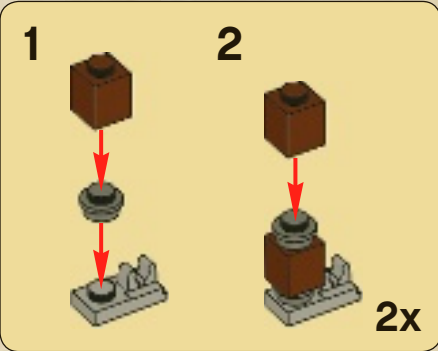

10



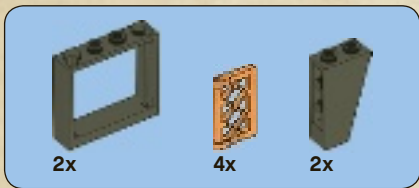

11

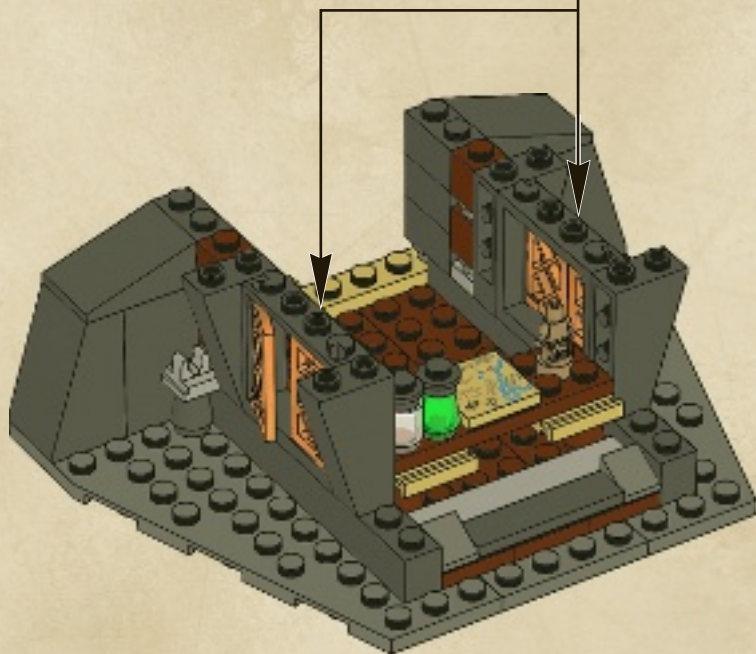
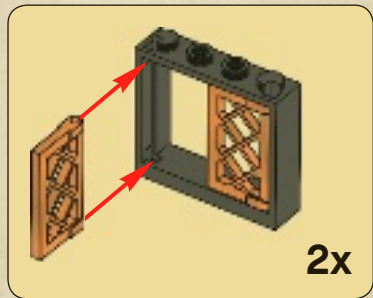

12

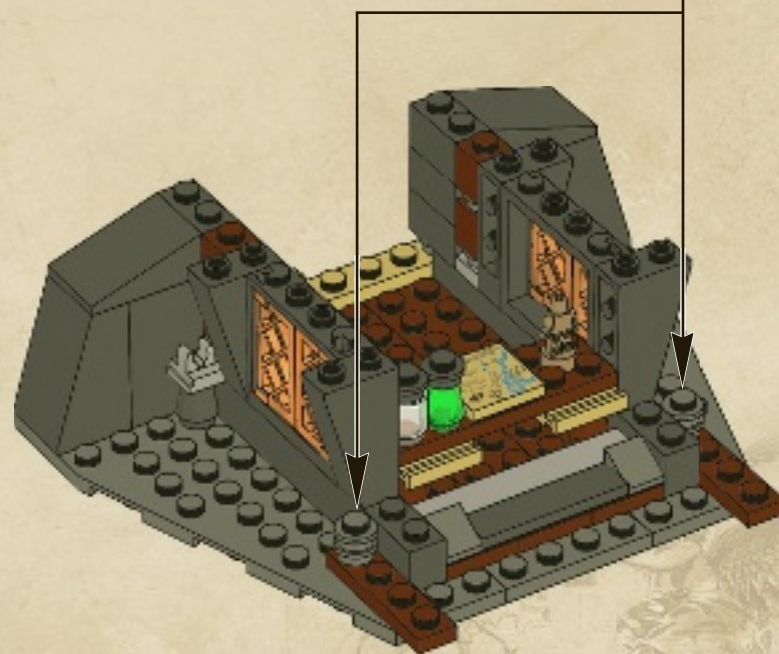
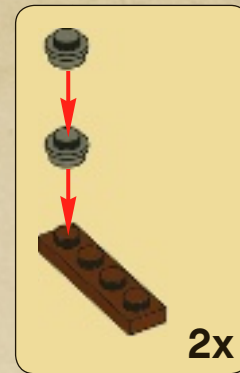



13

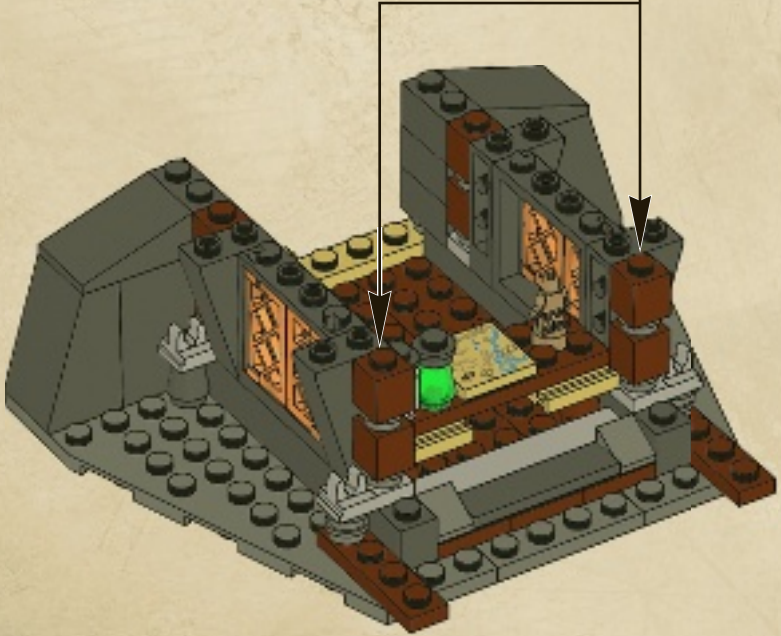
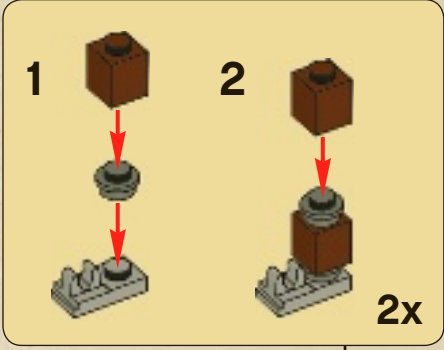

14

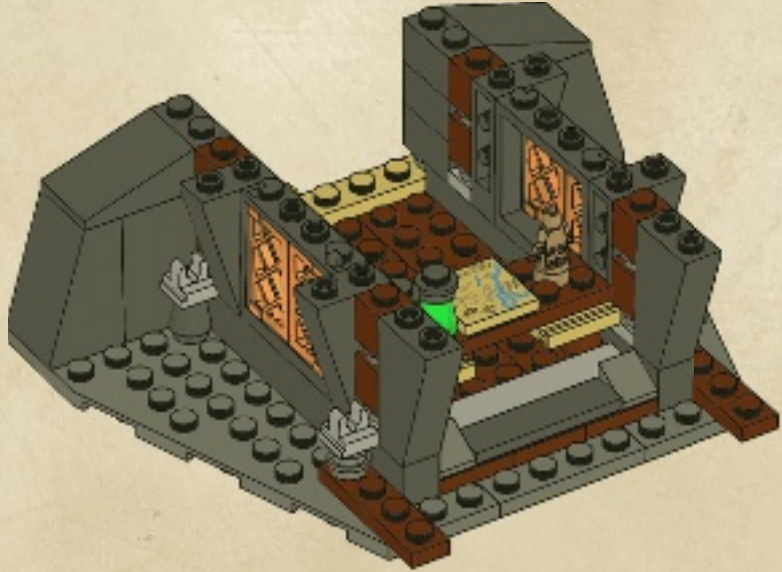

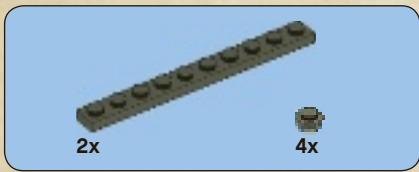

15

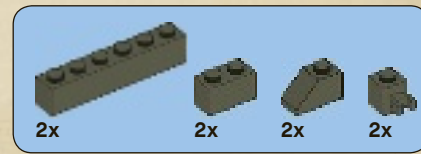
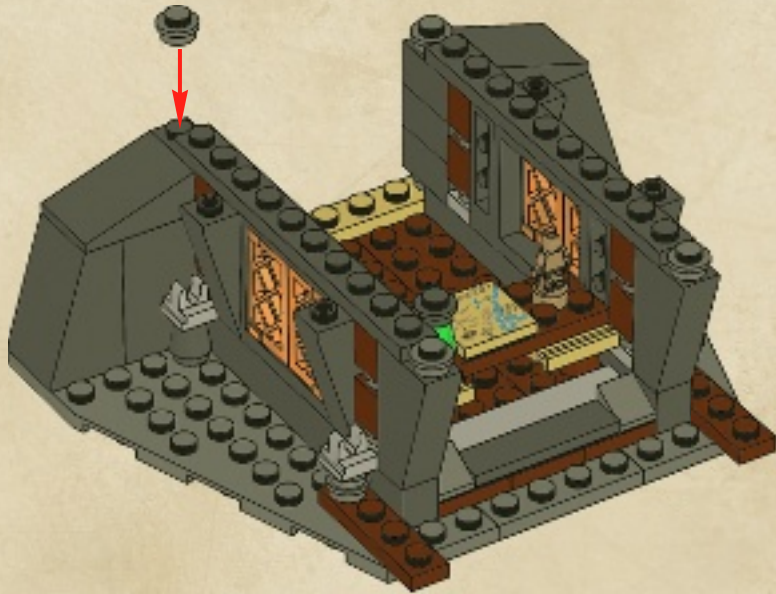

16

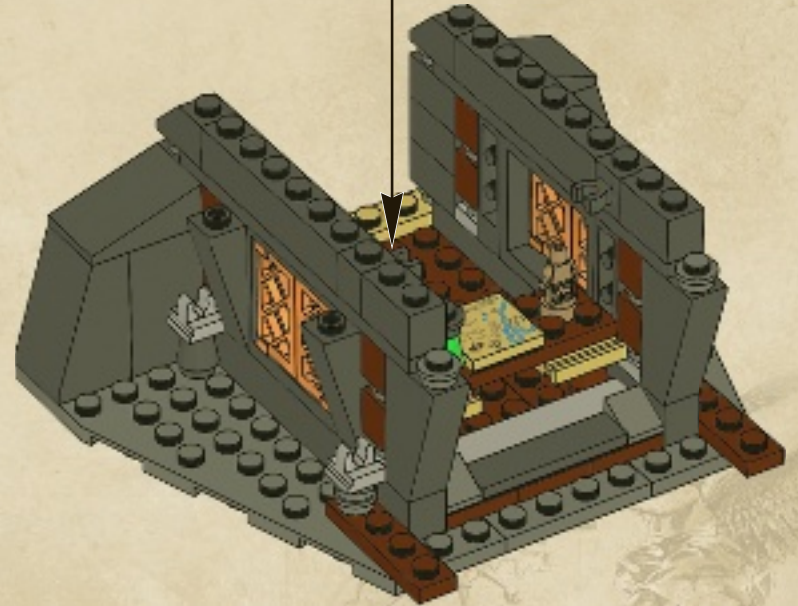

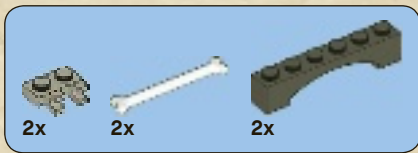



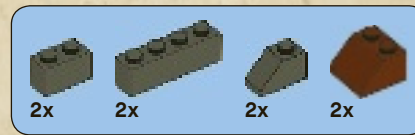
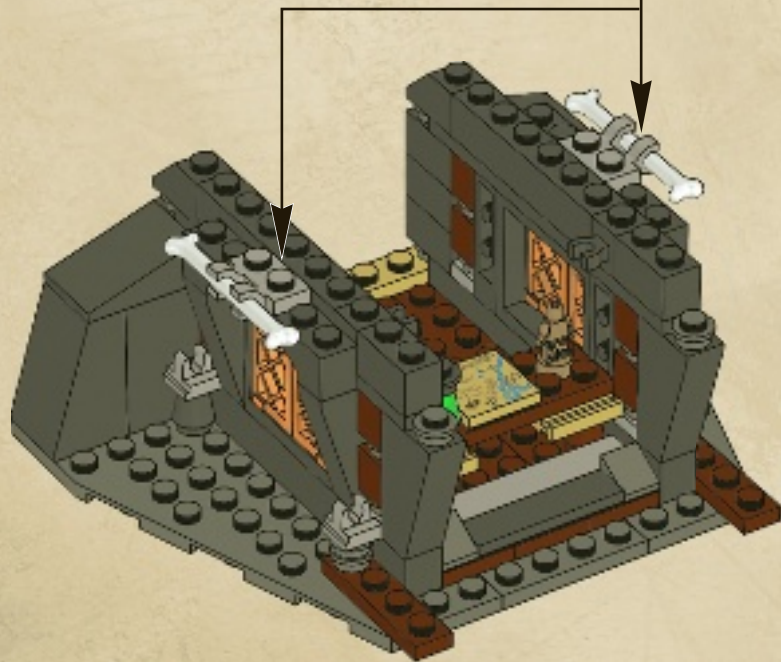
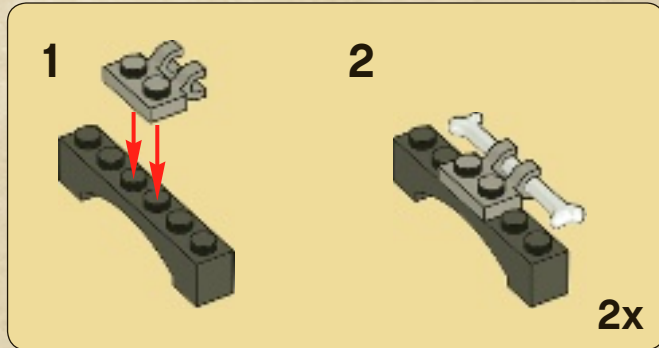

17

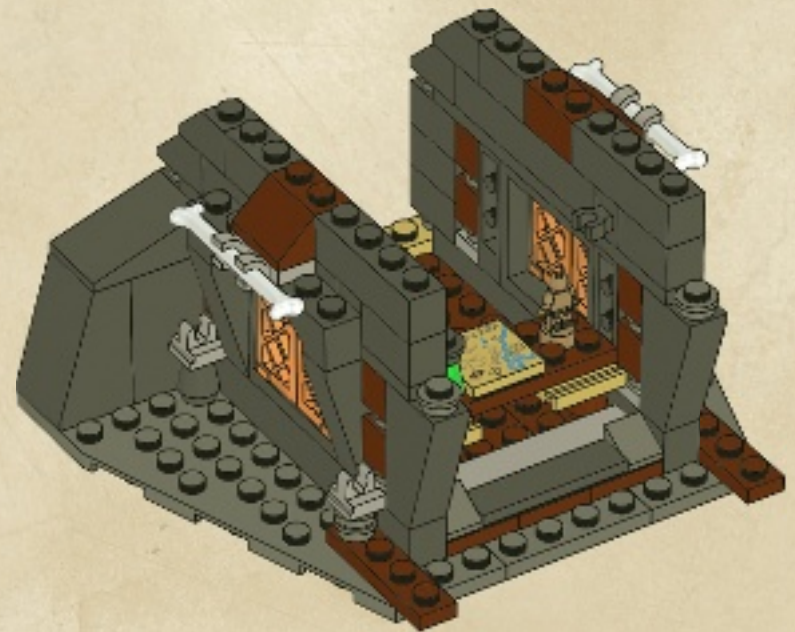



18







 2x
 2x
 2x

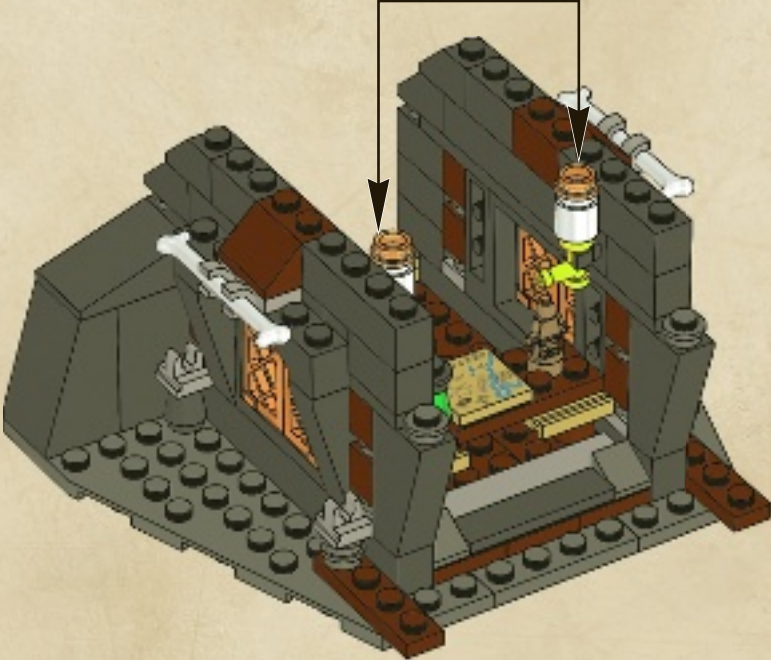

19



 2x



 2x
 2x
 2x
 2x
 2x

20

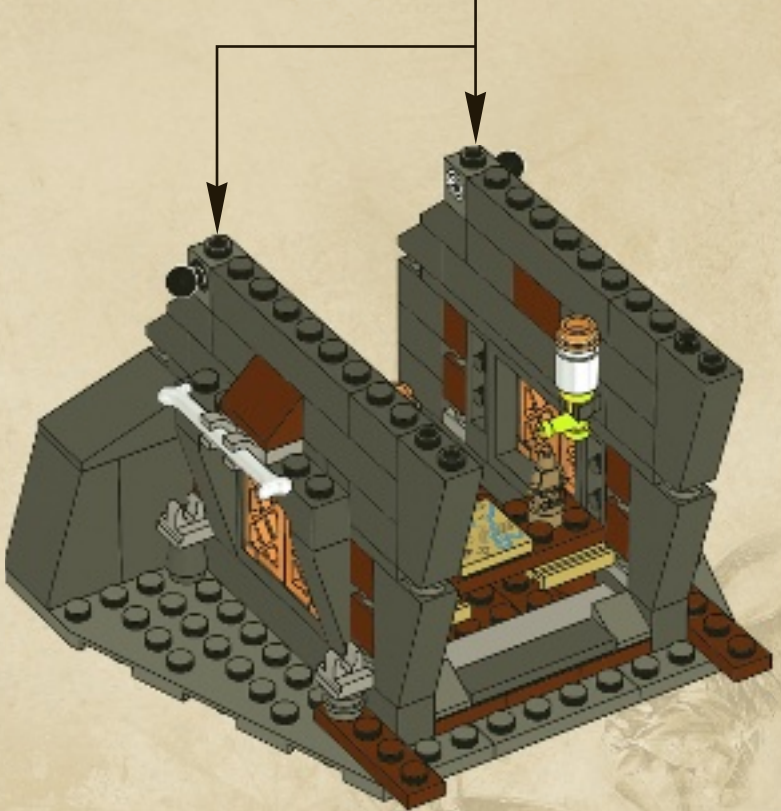
 2x



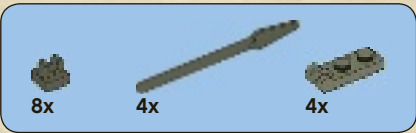

21

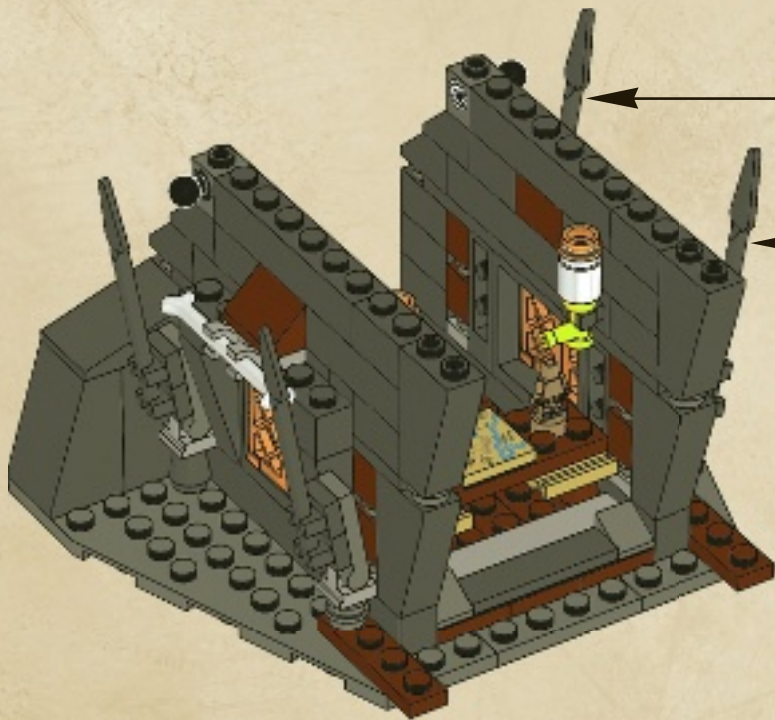

- 1
 - 2
 - 3
- 4x**

