



Mixels

41577



MYSTO



LEGO.com

6163222

1

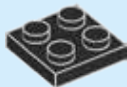

2



3

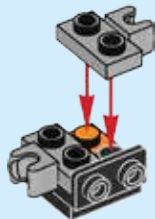

4



5

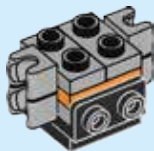

6

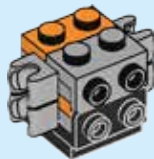

7

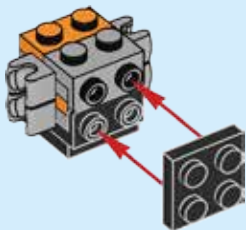

8

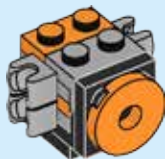

9

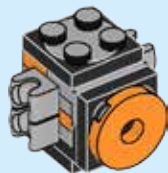
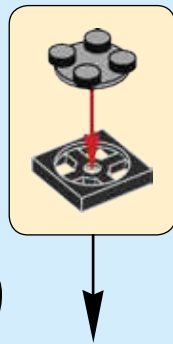



10

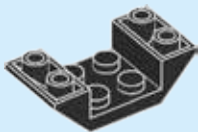

11

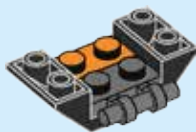

12

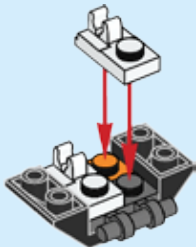

13

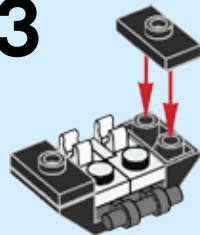

14

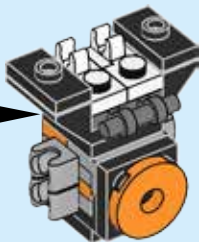

15

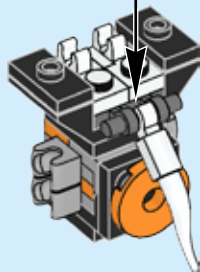
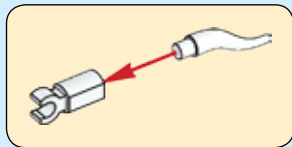



16

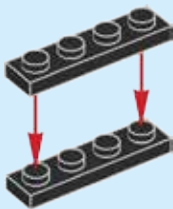

17



18



19

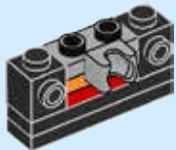

20

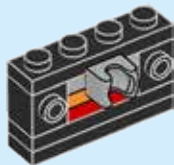

21

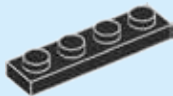

22



23

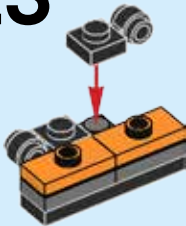

24



25

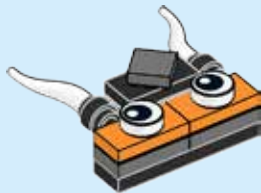

26

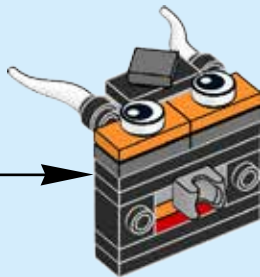

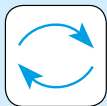

27

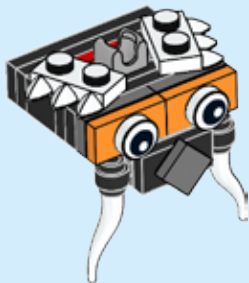

28

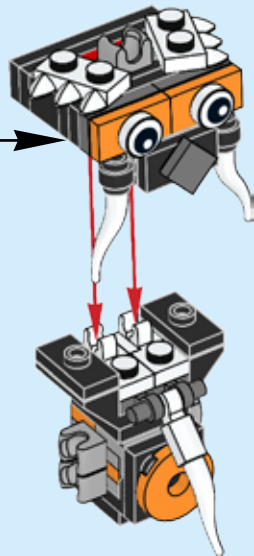



29

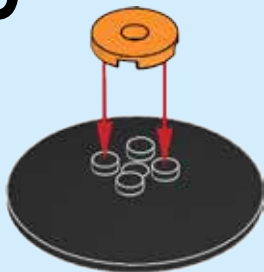

30

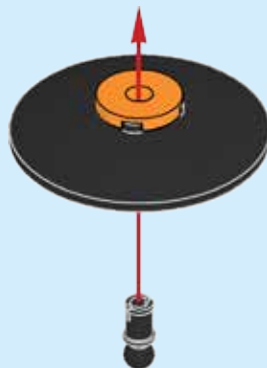

31

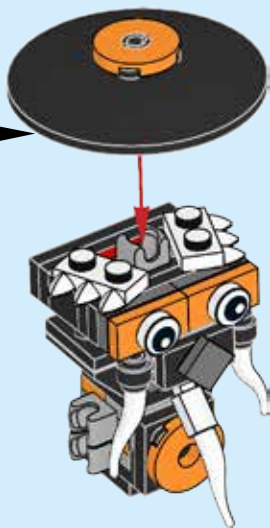



32

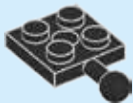

33



34



35



36



2x

37

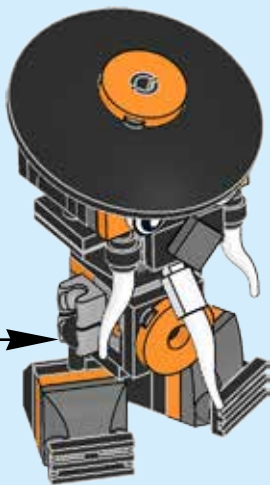

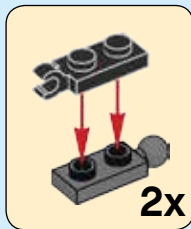

38

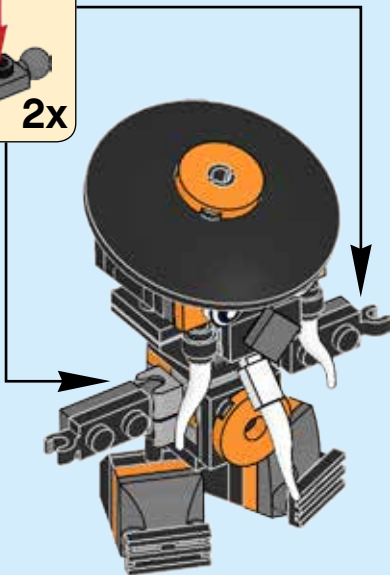

39

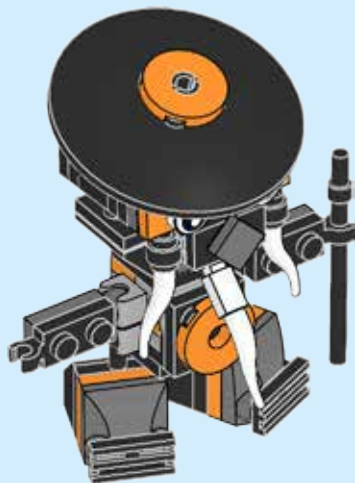



1x
4540203



3x
6032360



2x
4632571



2x
302226



4x
371026



1x
4210848



4x
4177932



5x
6043656



1x
4226876



2x
241226



1x
368026



2x
366026



1x
4210660



2x
6092599



2x
4558954



3x
6092585



2x
4535739



1x
4188534



2x
6123814



1x
6052824



1x
4654582



1x
4184169



1x
6020193



2x
6051038



1x
6081988



2x
4210635



2x
6029156



1x
6058341



3x
4159007



2x
4598527



2x
4218696



2x
6147052



2x
6046381



Customer Service

Kundenservice

Service Consommateurs

Servicio Al Consumidor

LEGO.com/service or dial



00800 5346 5555 :



1-800-422-5346 :





**COBRAX
41575**



**SPINZA
41576**



**MYSTO
41577**



**NINDJAS
MAX!**



LEGO.com/mixels





Mixels



COBRAX
41575



MYKE
41580



CAMSTA
41579

MYSTO
41577



SWEEPZ
41573

SCREENO
41578



SPINZA
41576



COMPAX
41574



GOBBOL
41572



Mixels™

CALLING ALL MIXELS
APPEL À TOUS LES MIXELS !
¡¡LLAMANDO A TODOS LOS MIXELS!



PLAY FOR FREE!
JOUE GRATUITEMENT !
¡JUEGA GRATIS!

Download on the
 App Store

Apple, the Apple logo, iPad, iPhone and iPod touch are trademarks of Apple Inc. Apple, le logo Apple, iPad, iPhone et iPod touch sont des marques de commerce d'Apple Inc. / Apple, el logotipo de Apple, iPad, iPhone e iPod touch son marcas comerciales de Apple Inc.

Mixels™ RUSH



PLAY FOR FREE!
JOUE GRATUITEMENT !
¡JUEGA GRATIS!

ANDROID APP ON
 Google play

Google Play is a trademark of Google Inc. Google Play est une marque de commerce de Google Inc. Google Play es una marca comercial de Google Inc.