



LEGO



Mixels



SHARK

41566



CN
CARTOON NETWORK



WARNING: CHOKING HAZARD.

Toy contains small parts and a small ball.
Not for children under 3 years.



LEGO.com

6157125

1

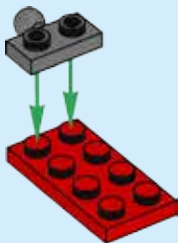

2

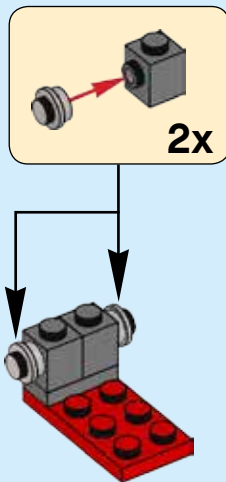

AVERTISSEMENT : RISQUE D'ÉTOUFFEMENT.

Le jouet contient des petites pièces ainsi qu'une petite boule.
Il ne convient pas aux enfants de moins de 3 ans.



ADVERTENCIA: PELIGRO DE ASFIXIA.

Juguete que contiene partes pequeñas y una pelota pequeña.
No recomendado para niños menores de 3 años.

3

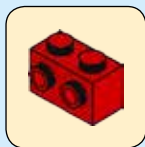
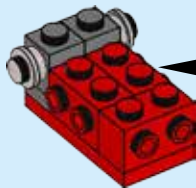

4

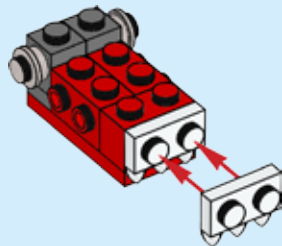

5

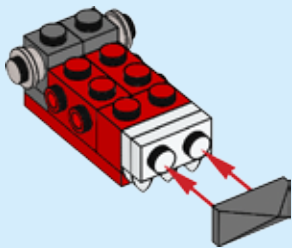

6

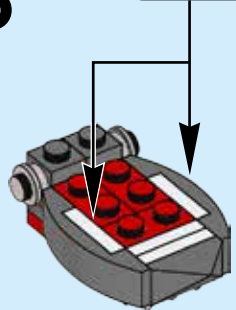
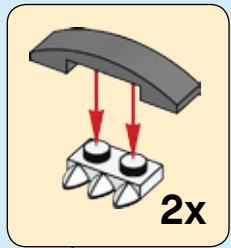

7

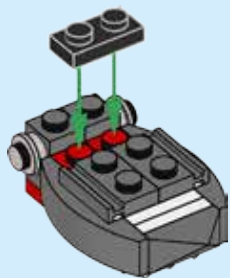

8

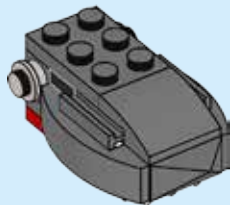

9

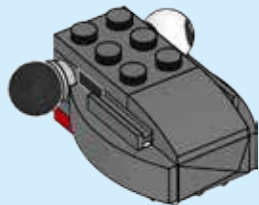



10

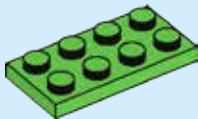

11

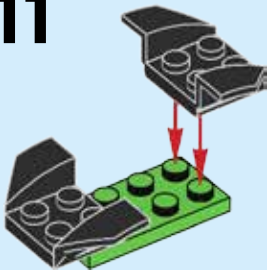

12

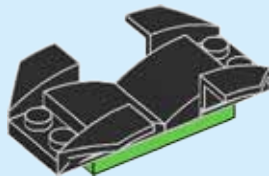

13

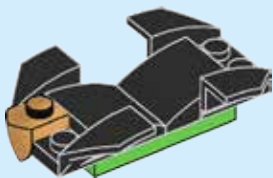

14

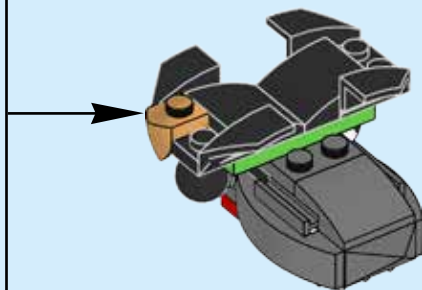

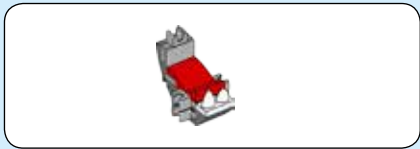

15

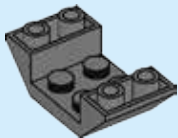

16

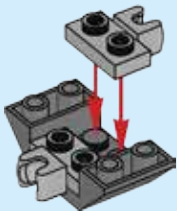

17

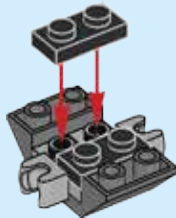

18

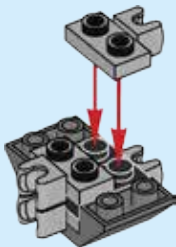

19

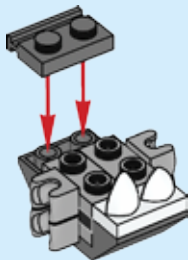

20

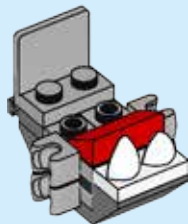

21

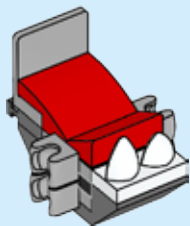

22

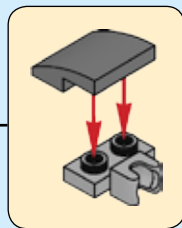
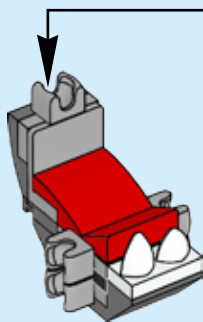

23

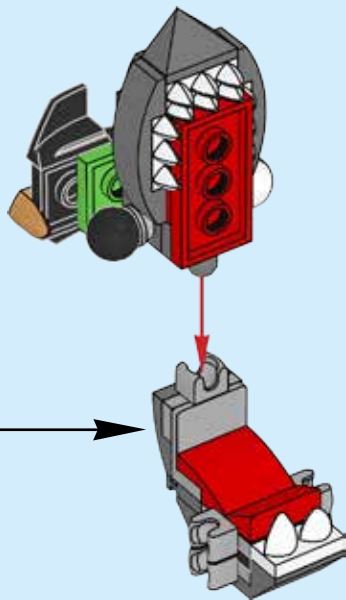

24

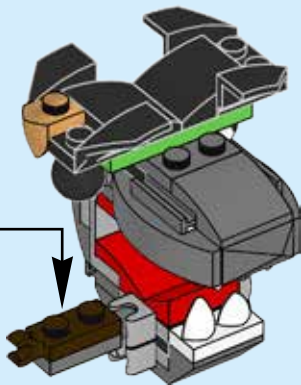
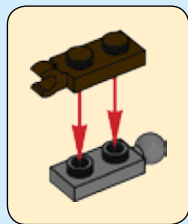

25

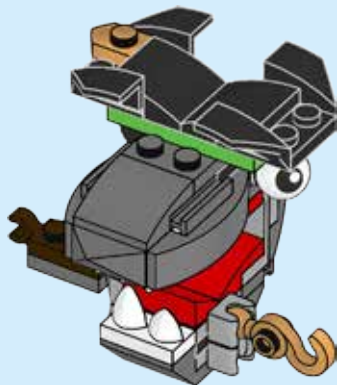



26



27

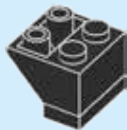

28



29



30



31

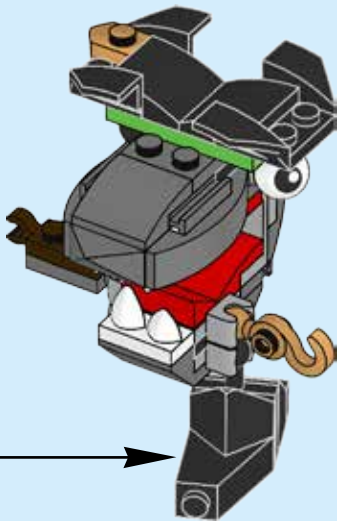



32



33



34



35

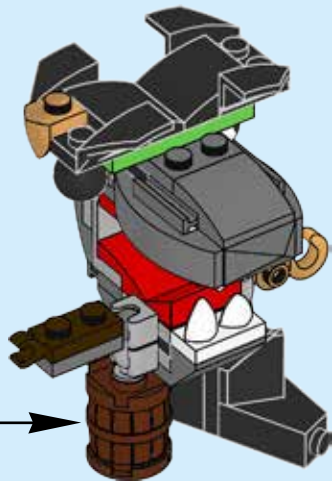

1x
4220539

1x
4515373

4x
302326

1x
366026

2x
6053077

1x
6051038

2x
4184813

1x
4290713

1x
6141590

1x
6075213

1x
4211147

2x
4558955

1x
6076203

1x
6039479

3x
4543086

1x
6123814

2x
6071261

1x
4211043

2x
4648256

1x
4211076

1x
6056225

1x
6046384

4x
6046381

1x
4211375

5x
6043656

1x
4654580

1x
4651524

3x
6019155

1x
6105976

1x
302021

1x
4649422

1x
6083975

1x
6114529

1x
6141589

2x
4633691

Customer Service

Kundenservice

Service Consommateurs

Servicio Al Consumidor

LEGO.com/service or dial





**SHARX
41566**



**SKULZY
41567**



**LEWT
41568**



**PYRRATZ
MAX!**

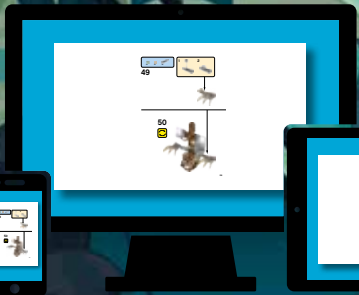

LEGO.com/mixels



LEGO **Mixels**

SERIES 8
SERIES 8
SERIES 8

SKULZY
41567



AQUAD
41564



SPLASHO
41563



SKRUBZ
41570



SURGED
41569



SHARK
41566



LEWT
41568



TUTH
41571



HYDRO
41565



LEGO.com/mixels



Mixels™

CALLING ALL MIXELS
APPEL À TOUS LES MIXELS !
¡¡LLAMANDO A TODOS LOS MIXELS!



NOW PLAY FOR FREE!
JOUE MAINTENANT GRATUITEMENT !
¡¡JUEGA GRATIS AHORA!

Download on the
 App Store

Apple, the Apple logo, iPad, iPhone and iPod touch are trademarks of Apple Inc. Apple, le logo Apple, iPad, iPhone et iPod touch sont des marques de commerce d'Apple Inc. / Apple, el logotipo de Apple, iPad, iPhone e iPod touch son marcas comerciales de Apple Inc.

Mixels™ RUSH



NOW PLAY FOR FREE!
JOUE MAINTENANT GRATUITEMENT !
¡¡JUEGA GRATIS AHORA!

ANDROID APP ON
 Google play

Google Play is a trademark of Google Inc. Google Play est une marque de commerce de Google Inc. Google Play es una marca comercial de Google Inc.



LEGO.com/mixels

