



**7+**  
**4094**





Quick Build  
 Schnellbaumodelle  
 Construction rapide  
 Costruzione rapida  
 Snel bouwen  
 Construcción rápida  
 Byg hurtigt  
 Nopeaan rakentamiseen  
 Bygg snabbt  
 Construção Rápida  
**Γρήγορες Κατασκευές**  
 Kísérletezőknek



Experienced Build  
 Könnnermodelle  
 Construction normale  
 Costruzione esperta  
 Bouwen voor gevorderden  
 Construcción experta  
 Byg videre  
 Kokeneelle rakentajalle  
 Bygg mer  
 Construção para Experimentados  
**Επιδέξιες Κατασκευές**  
 Haladóknak



Advanced Build  
 Profimodelle  
 Construction avancée  
 Costruzione avanzata  
 Geavanceerd bouwen  
 Construcción avanzada  
 Byg avanceret  
 Taitavalle rakentajalle  
 Bygg avancerat  
 Construção Avançada  
**Εξελιγμένες Κατασκευές**  
 Profiknak



28



41

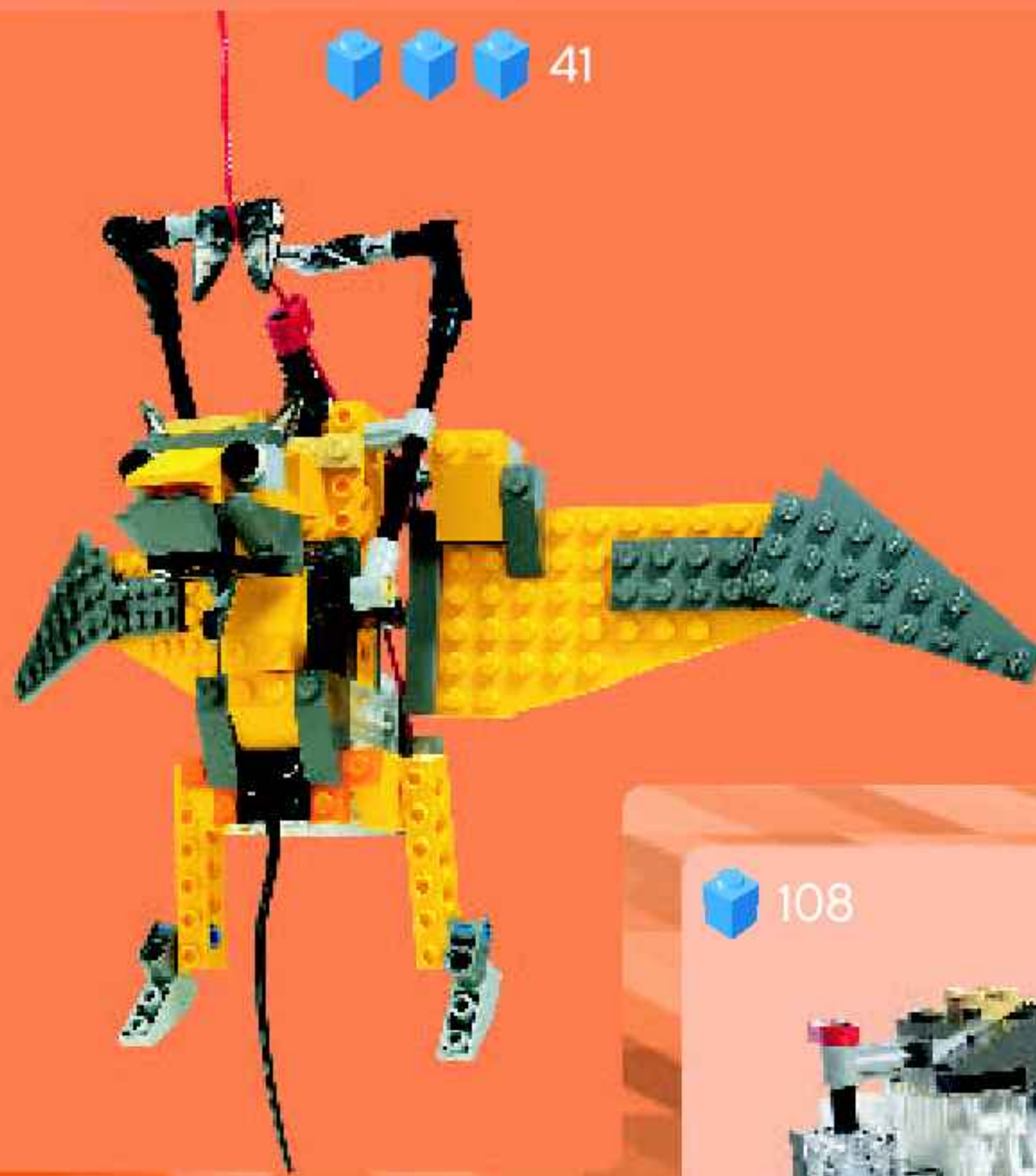

83



108

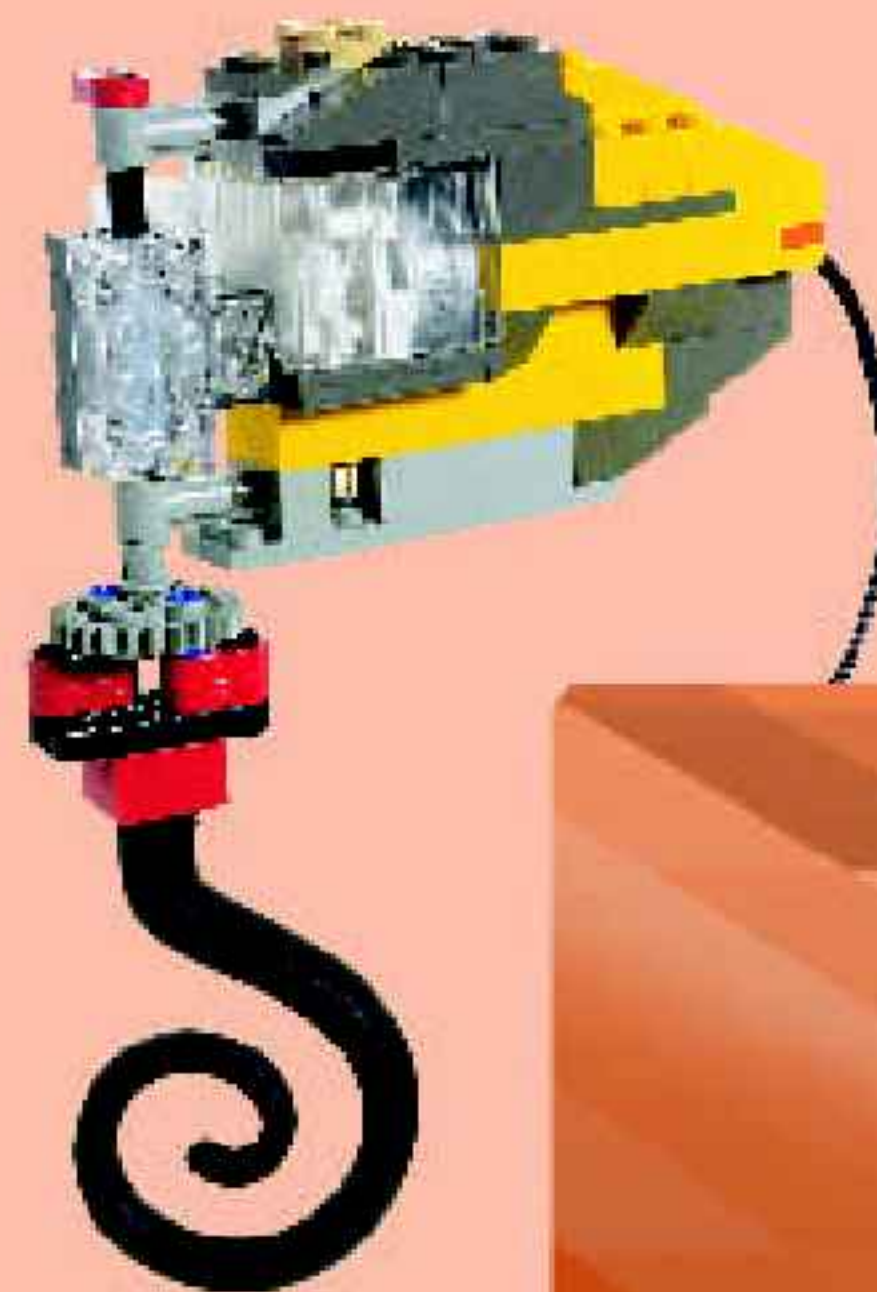

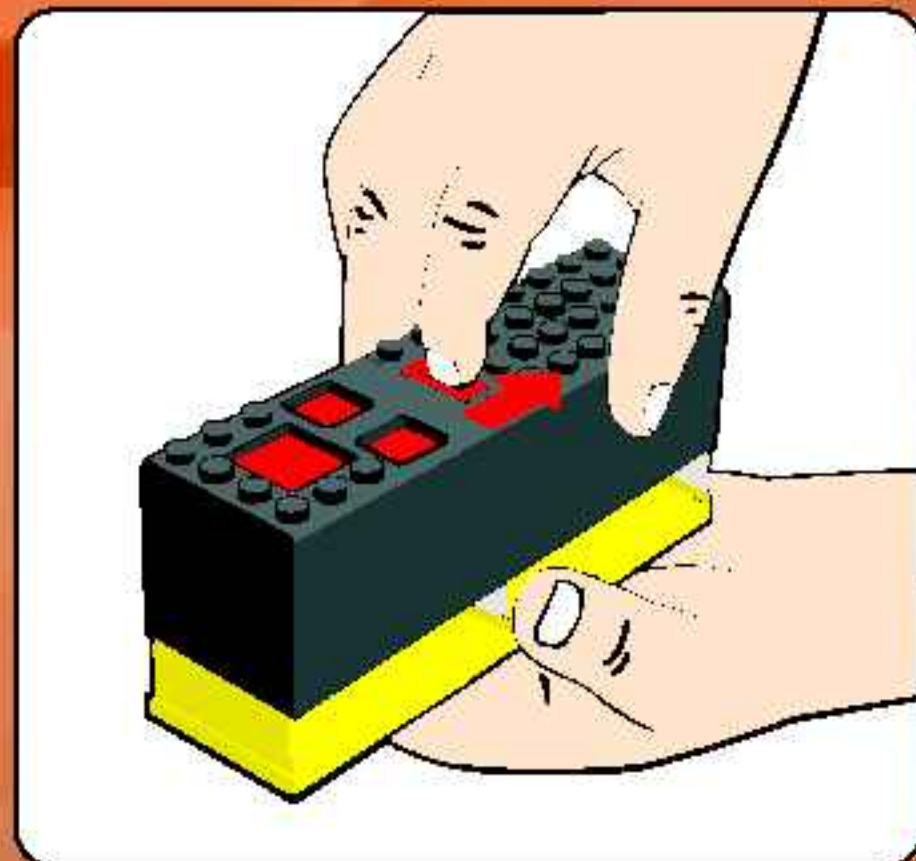
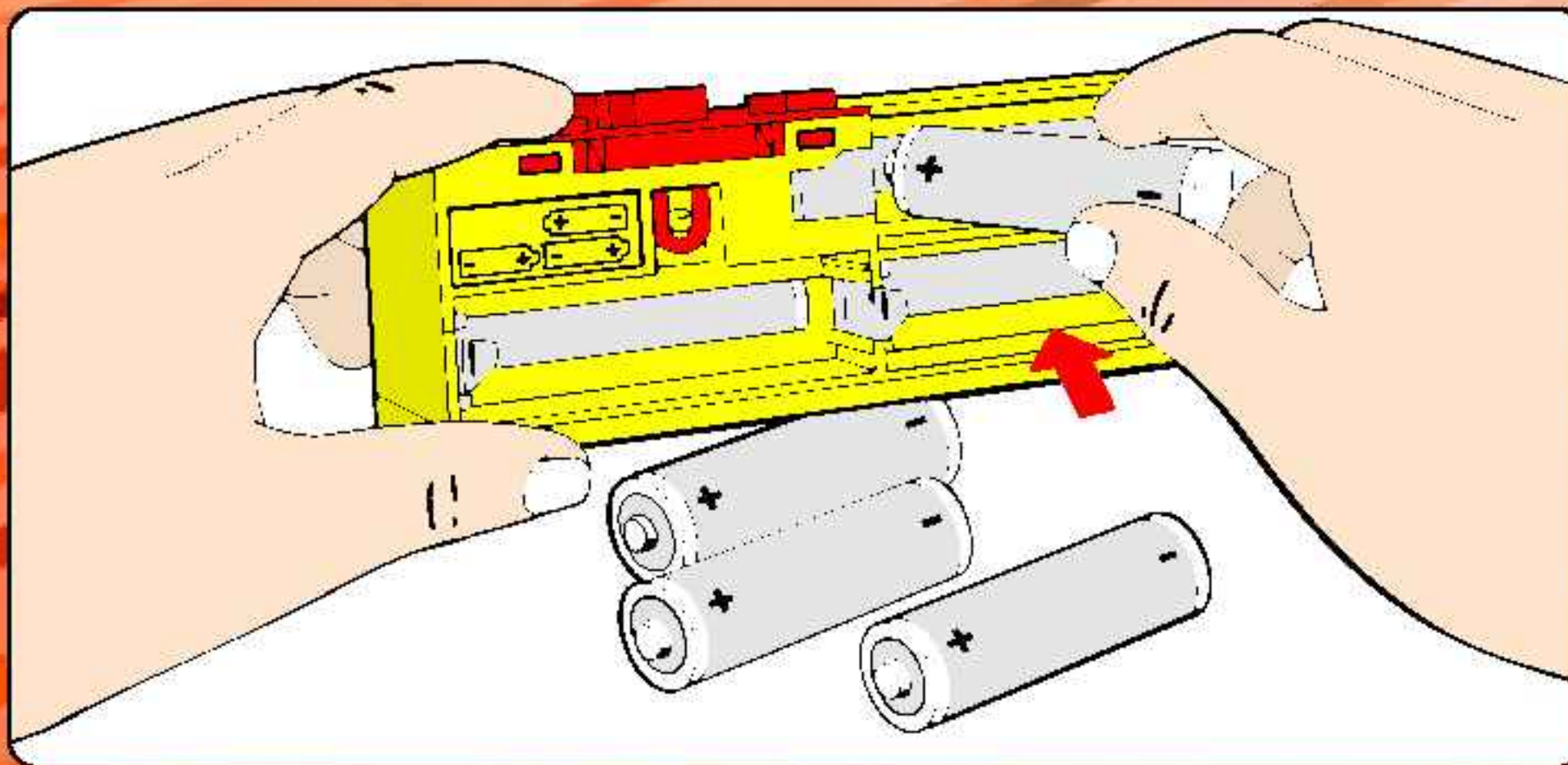
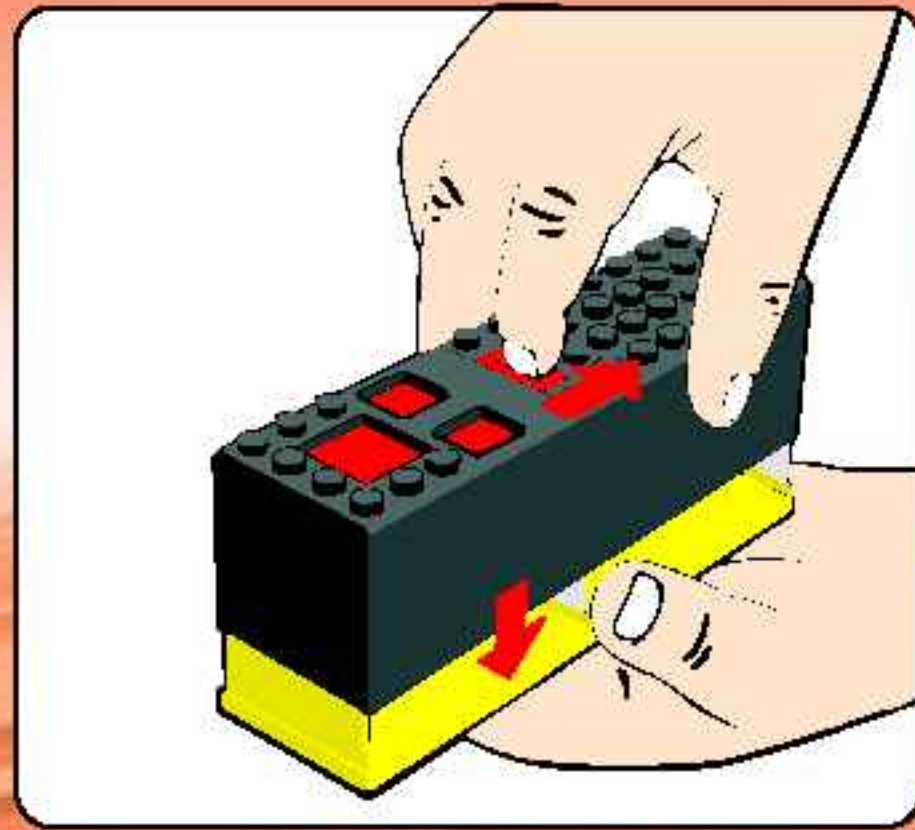
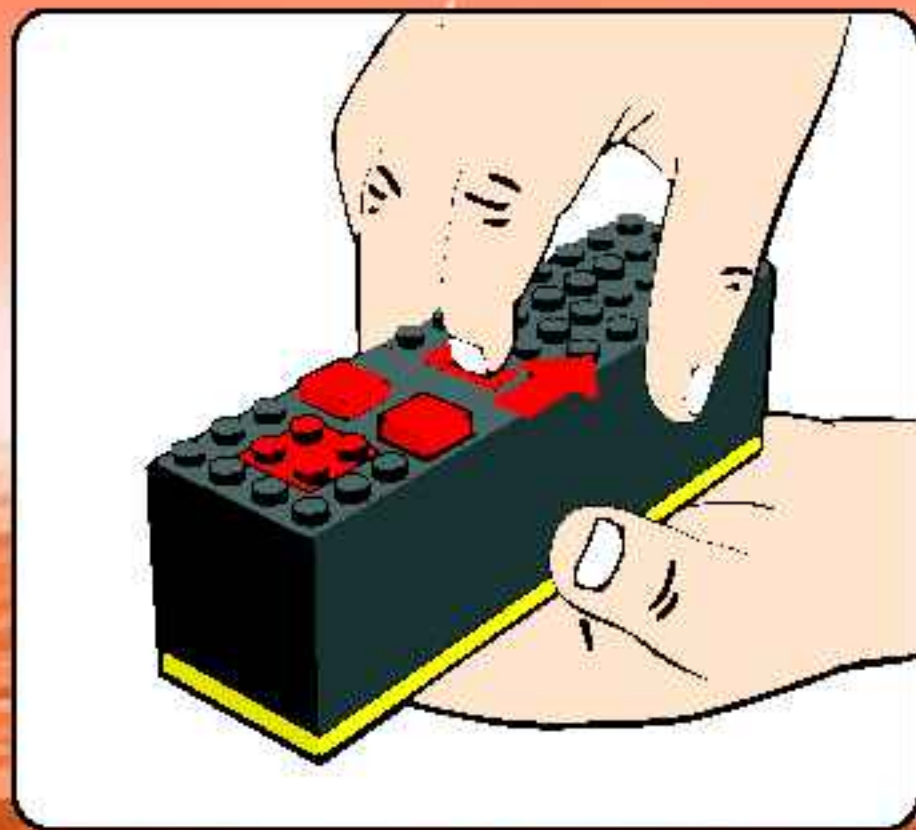

#### GB

##### Important information about batteries

Never use different types of batteries together, or a combination of old and new batteries. Always remove the batteries if the product is not to be used for a long time or if the batteries have run down. Never use damaged batteries. Only use batteries of the type recommended, or a corresponding type. Insert the batteries so that the poles are correctly positioned. Rechargeable batteries must be recharged using the correct battery charger under the supervision of an adult. You cannot recharge batteries while they are still in the product, and you must never try to do so. Never attempt to recharge non-rechargeable batteries. Never short-circuit the battery holder.

#### DE

##### Wichtige Information zu Batterien

Benutzen Sie niemals unterschiedliche Arten von Batterien oder alte und neue gleichzeitig. Nehmen Sie stets die Batterien heraus, wenn mit dem Modell längere Zeit nicht gespielt wird oder wenn die Batterien leer sind. Verwenden Sie niemals beschädigte Batterien. Verwenden Sie ausschließlich empfohlene bzw. geeignete Batterien. Achten Sie beim Einsetzen der Batterien auf die richtige Polung. Wiederaufladbare Batterien sollten mit einem geeigneten Ladegerät aufgeladen werden – unter der Aufsicht eines Erwachsenen. Batterien können und sollten niemals aufgeladen werden, während sie sich im Modell befinden. Versuchen Sie unter keinen Umständen, „normale“ Batterien wiederaufzuladen. Schließen Sie das Batteriefach niemals kurz.

#### FR

##### Informations importantes concernant les piles

Ne jamais utiliser un mélange de différents types de piles, ou de piles neuves et de piles anciennes ou déjà utilisées. Toujours retirer les piles si le produit n'est pas utilisé durant une période prolongée ou si les piles sont vides. Ne jamais utiliser de piles endommagées. Utiliser uniquement des piles du type recommandé ou d'un type équivalent. En insérant les piles, respecter scrupuleusement le sens d'orientation des pôles (+/-). Les piles rechargeables doivent être rechargées en utilisant un chargeur de piles adéquat et sous la surveillance d'un adulte. Il est impossible de recharger les piles quand elles sont installées dans le produit. Ne jamais tenter de le faire. Ne jamais essayer de recharger des piles non-rechargeables. Ne jamais court-circuiter le compartiment des piles.

#### IT

##### Importanti informazioni sulle batterie

Non usare mai contemporaneamente batterie di tipo diverso o batterie nuove e usate insieme. Rimuovere sempre le batterie qualora il prodotto non venga utilizzato per periodi prolungati, oppure se le batterie sono esaurite. Non utilizzare mai batterie danneggiate. Usare esclusivamente batterie del tipo raccomandato o un equivalente. Inserire le batterie avendo cura che la loro polarità sia corretta. Le batterie ricaricabili vanno ricaricate in un caricabatterie di tipo idoneo e con la supervisione di un adulto. Non è possibile e non bisogna mai tentare di ricaricare le batterie mentre queste sono inserite nel prodotto. Non tentare mai di ricaricare le batterie non ricaricabili. Non cortocircuitare mai il portabatterie.



## NL

### Belangrijke informatie over batterijen

Gebruik nooit verschillende soorten of nieuwe en oude batterijen tegelijkertijd. Verwijder de batterijen altijd als je het product lange tijd niet wilt gebruiken of als de batterijen leeg zijn. Nooit beschadigde batterijen gebruiken. Uitsluitend batterijen van het aanbevolen of overeenkomstige type gebruiken. Leg de batterijen met de polen in de juiste richting. Oplaadbare batterijen moeten in een voor dit doel bestemde oplader en onder toezicht van een volwassene opnieuw worden opgeladen. Oplaadbare batterijen kunnen niet in het product worden opgeladen en je mag dit ook niet proberen te doen. Probeer nooit niet-oplaadbare batterijen op te laden. Nooit de batterijhouder kortsluiten.

## ES

### Importante información sobre las baterías

No mezclar nunca diferentes tipos de baterías, ni utilizar baterías antiguas y nuevas a la vez. Sacar siempre las baterías, si el producto no se utiliza por un largo periodo de tiempo o si las baterías están descargadas. No utilizar nunca baterías dañadas. Utilizar solo el tipo de baterías recomendado o uno correspondiente. Colocar las baterías de manera que los polos estén en su posición correcta. Las baterías recargables deben cargarse con un cargador adecuado bajo la supervisión de un adulto. Las baterías no pueden, ni deben recargarse mientras permanezcan en el producto. No intentar nunca recargar baterías no recargables. Asegurarse que no se produzca un cortocircuito en el porta baterías.

## DK

### Vigtig information om batterier

Brug aldrig forskellige typer batterier sammen, eller nye og gamle batterier samtidig. Tag altid batterierne ud, hvis du ikke skal bruge produktet i længere tid, eller hvis batterierne er brugt op. Anvend aldrig beskadigede batterier. Der må kun anvendes batterier af samme eller tilsvarende type som anbefalet. Batterierne skal vendes rigtigt når de i sættes. Genopladelige batterier skal oplades i en dertil beregnet oplader under opsyn af en voksen. Genopladelige batterier kan og må ikke forsøges opladet i produktet. Forsøg aldrig at genoplade ikke-genopladelige batterier. Kortslut aldrig batterikassens kontaktpåder.

## FI

### Tärkeää tietoa paristoista

Älä koskaan käytä erityyppisiä paristoja yhdessä. Älä myöskään käytä samassa laitteessa sekä vanhoja että uusia paristoja. Poista paristot tuotteesta aina, kun se on pitkään aikaa käyttämättä, tai kun paristot ovat tyhjentyneet. Älä koskaan käytä viallisia paristoja. Käytä vain tuotteessa suositeltuja tai vastaavantyyppisiä paristoja. Aseta paristot siten, että ne ovat oikein suuntaan. Ladettavat paristot on ladettava oikealla tavalla laiturilla aikuisen valvonnassa. Ne on poistettava tuotteesta lataamisen ajaksi. Älä koskaan yritä ladata paristoja, joita ei ole tarkoitettu ladattaviksi. Älä koskaan yritä oikoa sulkeutuneita pariston kosketuspintoja.

## SE

### Viktig information om batterier

Använd aldrig olika sorters batterier samtidigt, och inte heller en kombination av gamla och nya batterier. Ta alltid ur batterierna om produkten under en längre tid inte ska användas eller om batterierna är slut. Använd aldrig skadade batterier. Använd bara batterier av den typ som rekommenderats, eller av en motsvarande typ. Sätt i batterierna så att polerna hamnar i rätt läge. Laddningsbara batterier måste laddas med rätt slags batteriladdare och under en vuxens övervakning. Du kan inte ladda batterierna medan de fortfarande sitter i produkten, och du får heller aldrig försöka göra det. Försök aldrig ladda icke-laddningsbara batterier. Kortslut aldrig batteriutrymmets kontaktpåsar.

## PT

### Informações importantes acerca das pilhas

Nunca use tipos diferentes de pilhas em conjunto, nem uma combinação de pilhas velhas e novas. Retire sempre as pilhas se o produto não vai ser utilizado durante muito tempo ou se as pilhas se estiverem gastas. Nunca use pilhas danificadas. Use apenas pilhas do tipo recomendado ou de um tipo correspondente. Introduza as pilhas de forma e que os seus polos fiquem correctamente posicionados. Pilhas recarregáveis deverão ser recarregadas utilizando o recarregador de pilhas correcto sob a supervisão de um adulto. Não é possível recarregar pilhas recarregáveis enquanto elas ainda se encontram dentro do produto, e nunca devem ser feitas tentativas nesse sentido. Nunca tente recarregar pilhas não recarregáveis. Nunca faça curto-circuito do compartimento das pilhas.

## GR

### Σημαντικές πληροφορίες για τις μπαταρίες

Μη χρησιμοποιείτε ποτέ διαφορετικούς τύπους μπαταριών, ή παλιές και καινούριες μπαταρίες μαζί. Βγάλτε πάντα τις μπαταρίες αν δεν χρησιμοποιήσετε το προϊόν για αρκετό καιρό ή αν οι μπαταρίες έχουν αδειάσει. Ποτέ μη χρησιμοποιείτε χαλασμένες μπαταρίες. Χρησιμοποιείτε μόνο μπαταρίες του συνιστώμενου τύπου, ή αντίστοιχου τύπου. Βάλτε τις μπαταρίες με την σωστή πολικότητα. Θα πρέπει να φορτίζετε τις επαναφορτιζόμενες μπαταρίες χρησιμοποιώντας τον κατάλληλο φορτιστή μπαταριών υπό την επίβλεψη ενός ενήλικου. Δεν μπορείτε να επαναφορτίσετε τις μπαταρίες όταν αυτές βρίσκονται μέσα στο προϊόν, και ποτέ μην επιχειρήσετε να κάνετε κάτι τέτοιο. Μην επιχειρήσετε ποτέ να επαναφορτίσετε μη επαναφορτιζόμενες μπαταρίες. Ποτέ μη βραχυκυκλώνετε τη θήκη των μπαταριών.

## JP

### 電池の取り扱いに関する注意

異なるタイプの電池や、古い電池と新しい電池を混ぜて使用しないで下さい。長時間商品を 사용하지 않거나 電池が空になった場合は、必ず電池を取り外してください。電池は推奨されている種類か、もしくは充電する種類のみを使用してください。充電器を使用して正しい方向に電池を入れてください。充電電池を使用する場合は充電器の指示の元、正しく充電器を使用してください。商品の中に入れたまま電池を充電することは絶対に避けてください。充電器ではない電池を充電したり、電池をショートさせたりしないでください。

## KR

### 간편지 사용시 주의 사항

다른 건지끼리, 또는 새 건지와 구 건지를 혼용해서 사용하지 마십시오. 장기간 제품을 사용하지 않을 경우에는 건지를 제품에서부터 제거해 주십시오. 재충전가능건지(rechargeable battery)는 어떤의 종류 하여 충전이 가능해야 합니다. 또한 재충전가능건지(rechargeable battery)는 제품 안에서 충전을 할 수 없으므로, 별도로 충전에서는 인공구동, 그리고, 재충전가능건지(rechargeable battery)가 아닌 건지를 충전에서는 인공구동입니다.

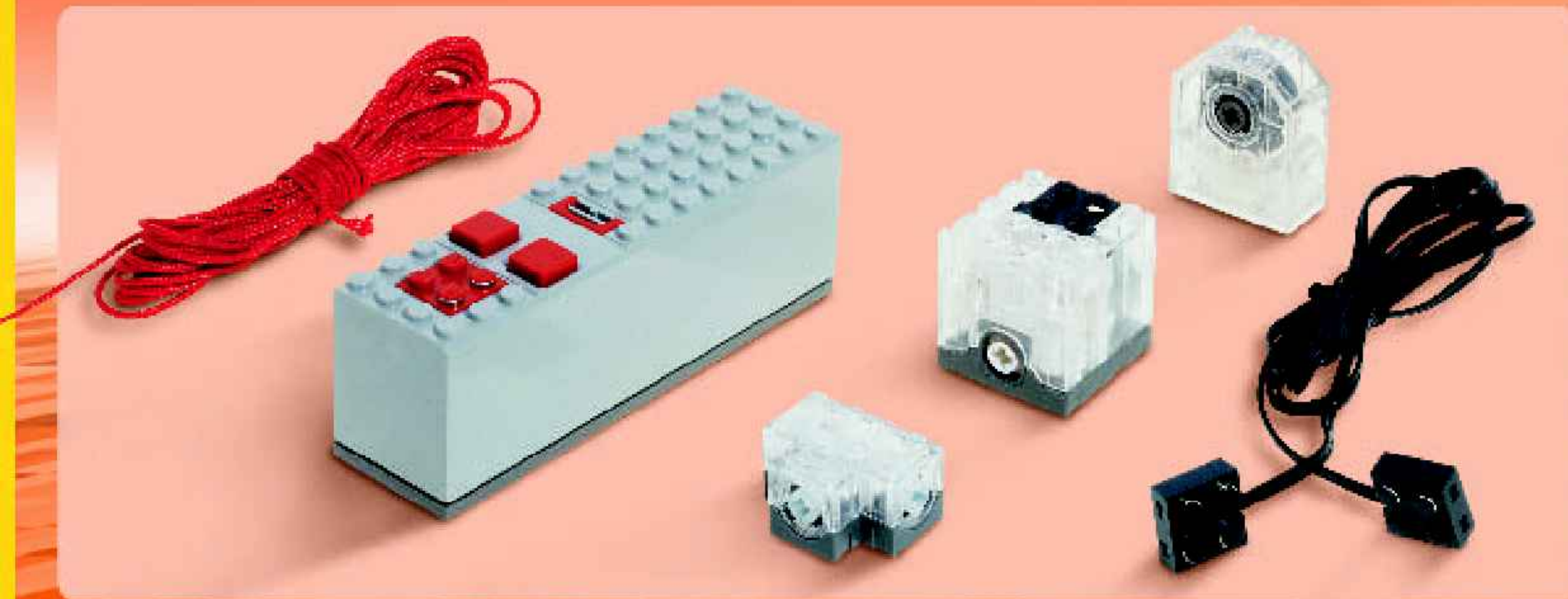

## CN

### 電池使用須知

切勿將不同種類的電池一起使用，亦不要把舊電池與新電池混合使用。如有一段長時間不會使用本產品或電池已耗盡，請把電池拆除。切勿使用已損壞之電池。只可使用建議中之電池型號，或其他等效式型號。請根據指示安裝電池。

你可以使用充電的循環電池，但必須採用適當的充電器，並在成年人的指導下方可進行充電。電池仍在產品內是不夠充電的，請勿自行嘗試。切勿試圖為非循環電池充電。亦切勿自行拆毀電池箱的兩蓋，以免產生短路。

## RU

### Необходимая информация об элементах питания

Ни в коем случае не используйте одновременно элементы питания различных типов, а также элементы питания с разным сроком годности. В обязательном порядке вынимайте элементы питания из термоячей в случае, если вы не пользуетесь прибором в течение долгого времени либо в случае, если в элементах питания закончился заряд. Ни в коем случае не используйте поврежденные элементы питания. Используйте только рекомендованные элементы питания, либо элементы питания соответствующего типа. Установите элементы питания, соблюдая указанную полярность. Аккумуляторные элементы питания должны подзарядиться в соответствующем зарядном устройстве под наблюдением взрослого. Ни в коем случае не пытайтесь подзарядить элементы питания, находящиеся в приборе. Ни в коем случае не пытайтесь подзарядить непровариваемые элементы питания. Ни в коем случае не пытайтесь замкнуть полюса в устройстве для элементов питания.

## PL

### Ważne informacje dotyczące baterii

Nigdy nie należy stosować razem różnych rodzajów baterii ani stosować równocześnie starych i nowych baterii. Jeżeli produkt nie jest używany przez dłuższy czas lub jeżeli baterie się wyczerpały, należy wyjąć baterie. Nigdy nie należy stosować uszkodzonych baterii. Należy stosować wyłącznie zalecany rodzaj baterii lub rodzaj mu odpowiadający. Przy wielokrotnu baterii należy zwrócić uwagę na właściwe położenie biegunów. Baterie akumulatorowe należy ładować w odpowiedniej ładowarce pod nadzorem osoby dorosłej. Nie można nadszukać baterii bez wyjęcia ich z produktu i nigdy nie należy tego próbować. Nigdy nie należy próbować ładowania baterii jednorazowych. Nigdy nie należy doprowadzać do zwarcia w gnieździe baterii.

## CZ

### Důležité informace o bateriích

Nikdy nepoužívejte najednou různé typy baterií nebo kombinaci starých a nových baterií. Nebude-li výrobek delší dobu používán nebo jsou-li baterie vybité, vždy je vyjměte z výrobku. Nikdy nepoužívejte poškozené baterie. Používejte pouze doporučené nebo odpovídající typy baterií. Baterie instalujte se správnou orientací pólu. Nabíjecí baterie musí být nabity ve vhodné nabíječce pod dohledem dospělé osoby. Nabíjecí baterie nelze nabíjet, jsou-li umístěny ve výrobku, a nesmíte se o to ani pokoušet. Nikdy se nesnažte nabít baterie, které nejsou nabíjecí. Nikdy nedotýkejte kontakty v prostoru pro baterie.

## SK

### Dôležitá informácia o batériách

Nikdy nepoužívajte naraz odlišné typy batérií ani nekombinujte staré batérie s novými. Batérie vždy vyberte, ak sa výrobok nebude dlhšie používať, alebo ak sa batéria vybitá. Nikdy nepoužívajte poškodené batérie. Používajte len odporúčané alebo zodpovedajúce typy batérií. Batérie vkladajte so správnou orientáciou pólov. Dobíjateľné batérie sa musia nabíjať vo vhodnom nabíjači pod dozorom dospeléj osoby. Dobíjateľné batérie sa nesmú nabíjať, ak sú umiestnené vo výrobku, a nesmíte sa o to ani pokúšať. Nikdy sa nesnažte nabíjať batérie, ktoré nie sú dobíjateľné. Nikdy nedotýkajte kontakty v priestore pre batérie.

## HU

### Fontos tudnivalók az elemekről

Soha ne használjunk különböző típusú elemeket, illetve ne használjunk új és használt elemet egyszerre. Mindig távolítsuk el az elemeket, ha a készüléket előre láthatóan hosszú ideig nem fogjuk használni, vagy ha az elemek lemerültek. Soha ne használjunk megromlottakat. Soha ne használjunk megromlottakat. Csak az ajánlott típusú, vagy annak megfelelő elemet használjuk. Az elemeket a polaritásuknak megfelelő módon helyezzzük be. Az akkumulátorokat csak a megfelelő akkumulátortöltővel szabad feltölteni, egy felnőtt segítségével felügyelet mellett. Az akkumulátorokat nem tölthetjük fel úgy, hogy azok a termékben vannak, ezt meg sem szabad próbálnunk. Soha ne próbáljuk meg feltölteni a nem tölthető elemeket. Soha ne használunk létrehozhatatlanul az elemtartó kivételével köztét.

## UA

### Необхідна інформація про батареї

Ніколи не використовуйте одночасно батареї різних типів або батареї з різним строком експлуатації. Обов'язково вилучайте батареї з пристрою якщо довгочасно не користуєтесь їм, або якщо в батареях вже сиднівся заряд. Ніколи не використовуйте пошкоджені батареї. Використовуйте батареї лише рекомендованого або відповідного типу. Вставляйте батареї, враховуючи задану полярність. Акумуляторні батареї повинні зарядитись у відповідному зарядному пристрої під наглядом дорослого. В будь-якому випадку не намагайтесь підзарядити батареї, що знаходяться в пристрої. В будь-якому випадку не намагайтесь підзарядити батареї, що не підлягають підзарядці. В будь-якому випадку не намагайтесь зробити коротке замикання в пристрої для батарей.

## HR

### Važne informacije o baterijama

Nikada ne koristite različite vrste baterija zajedno, kao ni kombinaciju starih i novih baterija. Uvijek izvadite baterije ako uređaj neće biti korišten duže vrijeme ili ako su baterije prazne. Nikada ne koristite oštećene baterije. Upotrebljavajte samo preporučenu vrstu baterija ili njima ekvivalentni tip. Umetnite baterije tako da su im polovi ispravno orijentirani. Baterije koje se mogu puniti moraju biti punjene u odgovarajućem punjaču baterija pod nadzorom odrasle osobe. Ne možete puniti baterije dok su umetnute u uređaj i to nikada niti ne pokušavajte. Nikada ne pokušavajte napuniti baterije koje se ne mogu puniti. Nikada kratkim spojem ne spajate polove baterija.



## SR

### Важне информације о батеријама

Никада не користите различите типове батерије заједно, и не мешајте старе батерије са новима. Увек извадите батерије уколико производ нећете користити дуго време или ако су се батерије истрошавале.

Никада не употребљавајте оштећене батерије. Користите искључиво тип батерија који се препоручује или одговарајућу замену. Преправом стављање батерије напунити да поново буду правилно постављени. Батерије на пуњењу се морају пуњити уз употребу одређеног пуњача и под надзором одрасле особе. Батерије се не могу пуњити док су у производу, и то не смате на да покушавате. Никада не покушавајте да напуните батерије које се не пуње. Никада не прагајте полове кућишта за батерије.

## SI

### Pomembna informacija o baterijskih vložkih

Nikoli ne uporabite različne vrste baterijskih vložkov skupaj ali pa nove vložke skupaj z rabljenimi. Če so se baterijski vložki izpraznili ali če izdelki ne bodo uporabljali dlje časa, morate vložke vedno odstraniti. Nikoli ne uporabite poškodovanih baterijskih vložkov. Uporabite samo priporočen tip baterijskih vložkov ali enakovredne vložke. Baterijske vložke vstavite tako, da sta pola plus in minus pravilno usmerjena. Baterijske vložke za ponovno polnjenje morajo otroci polniti z ustreznimi polnilcem samo pod nadzorom odrasle osebe. Pred polnjenjem morate vložke vedno izvlči iz igrače. Nikoli ne smete polniti baterijskih vložkov, medtem ko so še vedno v igračah. Nikoli ne poskušajte polniti baterijskih vložkov, ki niso namenjeni za ponovno polnjenje. V prostoru za baterijske vložke ne smete nikoli povzročiti kratkega stika.

## RO

### Informații importante cu privire la baterii

Nu folosiți niciodată împreună tipuri diferite de baterii și nici combinații de baterii noi și vechi. Îndepărtați întotdeauna bateriile dacă produsul nu este folosit timp îndelungat sau dacă bateriile s-au epuizat. Nu folosiți niciodată baterii deteriorate. Folosiți numai baterii de tipul recomandat, sau de un tip corespunzător. Introduceți bateriile astfel ca poli ai să fie în poziție corectă. Bateriile reîncărcabile trebuie reîncărcate utilizând un dispozitiv de încărcare adecvat, sub supravegherea unui adult. Bateriile nu pot fi reîncărcate cât timp sunt încă în produs, și nu încercați niciodată să le încălcați astfel. Nu încercați niciodată să reîncălcați baterii care nu sunt reîncărcabile. Nu scurcircuitați niciodată bornele suportului bateriei.

## BG

### Важна информация за батериите

Не използвайте различни типове батерии едновременно, нито комбинации от стари и нови батерии. Винаги изваждайте батериите, ако изделието няма да се използва продължително време или ако батериите се са източили. Не използвайте повредени батерии. Използвайте само батерии от препоръчания тип или съответстващ на него тип. Поставяйте батериите така, че полите да се разположат правилно. Аккумуляторните батерии трябва да се зареждат с подходящо зареждащо устройство под надзора на възрастни. Батериите не могат да се заредят, докато са поставени в изделието, така че не трябва да се опитвате да правят това. Не се опитвайте да заредите батерии, които не са акумулаторни. Не свързвайте в късо съединение клемите на батериите.

## LV

### Svarīga informācija par barošanas elementiem

Nekad vienlaikus nelietojiet dažādu tipu, kā arī jaunus un vecus barošanas elementus. Arvien izņemiet barošanas elementus, ja tie izžūdušies vai to darbības laiks izbeidzies ilgāku laiku nedek lietots. Nekad nelietojiet bojātus barošanas elementus. Lietojiet tikai ieteiktā tipa barošanas elementus vai tiem atbilstošus analogus. Ievietojiet barošanas elementus, ņemvērā parēža to pievienojuma polaritāte (+/-). Uzlādējamu barošanas elementu lādēšanai jāizmanto atbilstošs barošanas elementu lādētājs, uzlādēšana jāveic piesargāto uzraudzībā. Izstrādājumā ievietotus barošanas elementus uzlādēt nev iespējams, mēģinājumi to darīt nev pieļaujami. Nekad nemēģiniet uzlādēt neuzlādējamus barošanas elementus. Nekad nepieļaujiet saskārtumu starp barošanas elementu tipnes kontaktiem.

## EE

### Oluline teave patareide kohta

Mitte kunagi lisa sama märguga sisse koos erinevat tüüpi patareid, samuti vanu ja uusi patareid. Kui märguga ei kasutata pikka aega jooksul, võta patareid sellest välja. Ka tähtsusetu patareid tuleb märgusajast välja võtta. Ära kasuta kahjustatud patareid. Kasuta ainult ettenähtud tüüpi või nendele samaväärseid patareid. Pene patareid märguga sisse nii, et pluss- ja miinusidammi asend oleks õige. Akuid tuleb laadida ainult nendele ettenähtud akulaadija abil täiskasvanu järelevalve all. Akuid ei saa laadida sel ajal, kui need on märguga sees. Ära kunagi püüa nii teha. Ära mitte kunagi proovi ühendada sisse laadida teinud patareid. Patareipoolseid klemmeid vahel ei tohi tekkida lühisid.

## LT

### Svarbi informacija apie elementus

Nesinaudokite vienu metu skirtingų tipų elementais, taip pat su naujais elementais nenaudokite senų elementų. Išimkite elementus iš įdėdė, jeigu nesinaudoosite gaminiu ilgą laiką arba jeigu elementai išsikrovė. Nesinaudokite sugadintais elementais. Naudokite tik rekomenduojamo arba atitinkamo tipo elementais. Įdėkite elementus taip, kad atitiktų teigiami ir neigiami poliūs. Akumuliatorinius elementus galima įkūsti tik tinkamu elementų krūvėdė, prizūrint suaugusiesiems. Elementų negalima įkrauti, nebūmus jų iš įdėdė, ir nebandykite to daryti. Nebandykite įkrauti nesakumuliatorinio tipo elementų. Nedarykite trumpo jungimo elementų įdėdė.

## TR

### Piller haldanda önemli bilgiler

Hiçbir zaman değişik tipte pilleri ya da eskid pillerle yeni pilleri bir arada kullanmayın. Pilleri uzun süre kullanımayacaksa ya da piller bitmişse, pilleri çıkarın. Hiçbir zaman zedelemiş piller kullanmayın. Yalnız önerilen tipte piller ya da bunların dengi olan piller kullanın. Pilleri kutupları doğru konumde olacak şekilde yerleştirin. Bitince yeriden doldurulabilen piller doğru pil doldurucuyu kullanarak, bir yetişkinin denetiminde doldurulmalıdır. Doldurulebilir pilleri ürünün içindeyken dolduramazsınız; hiçbir zaman bunu yapmaya çalışmayın. Hiçbir zaman, bitince doldurulamayan tip pilleri yeniden doldurmaya çalışmayın. Hiçbir zaman pil kutusuna kısa devre yaptırmayın.









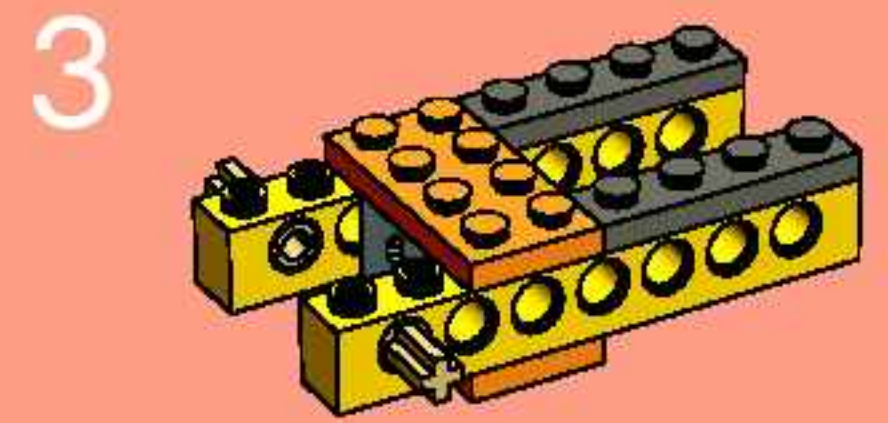
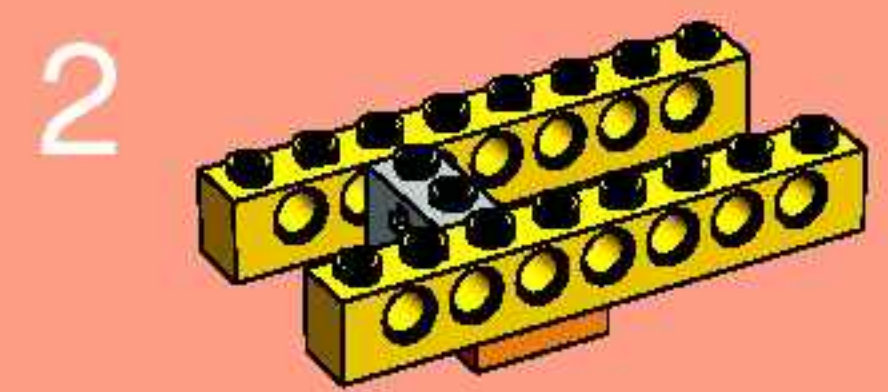
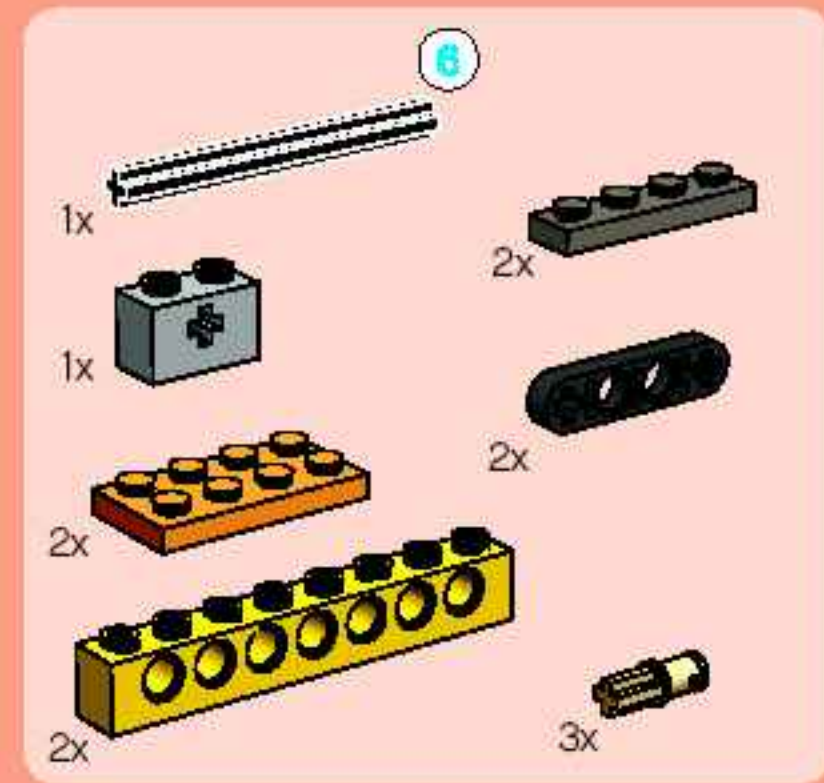
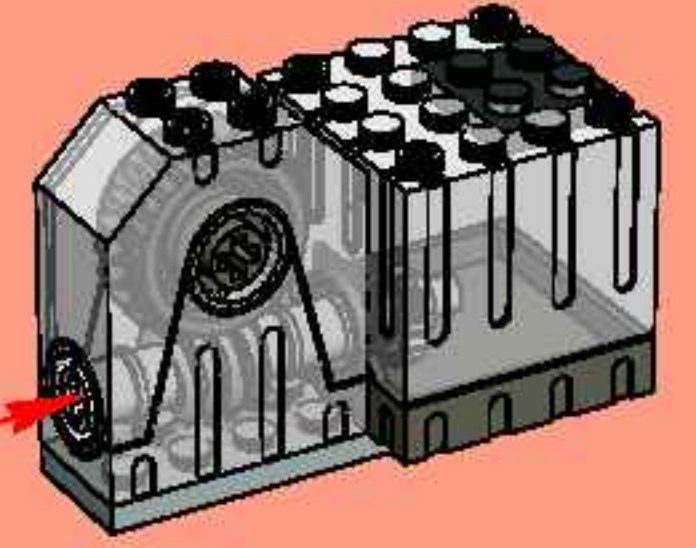
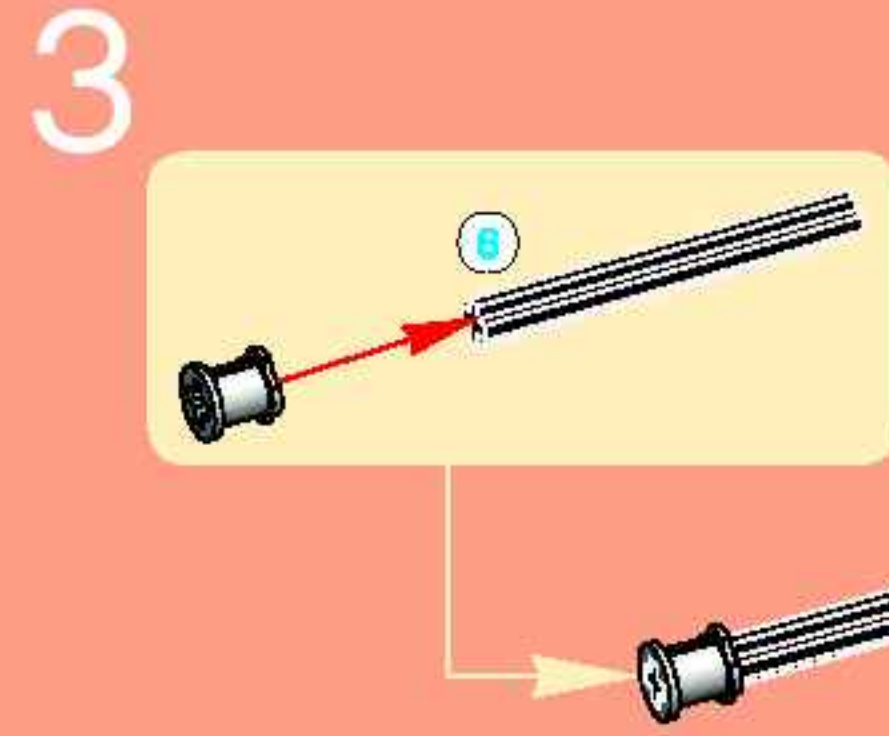
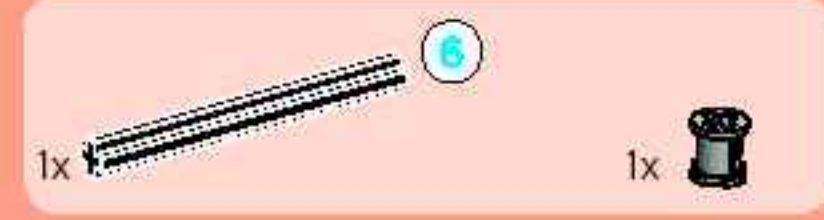
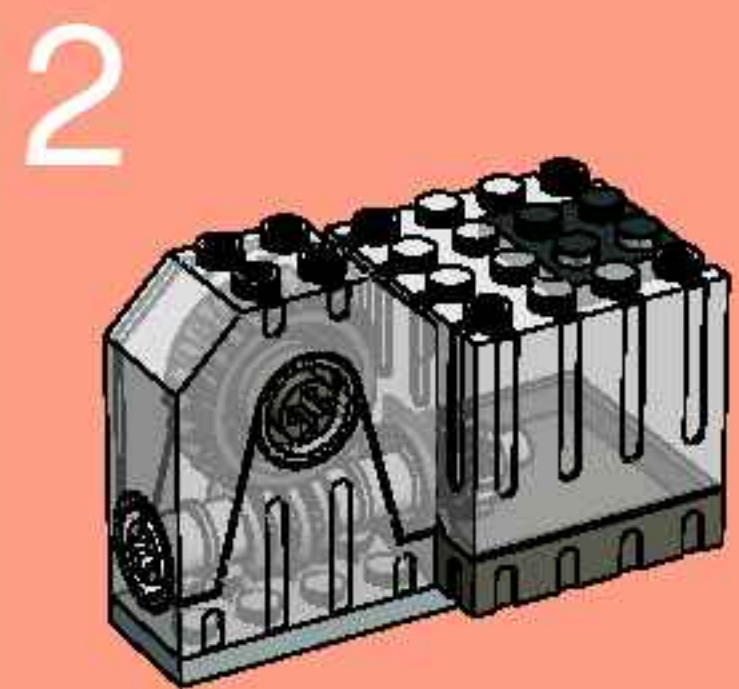
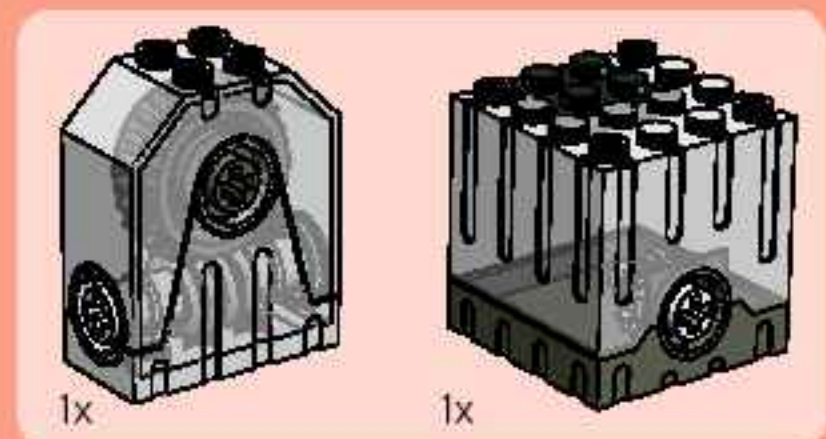
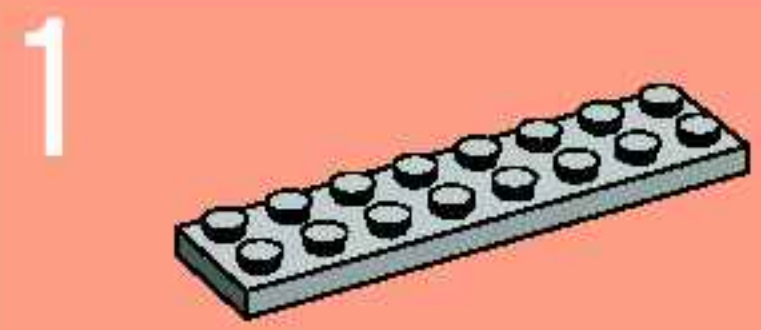
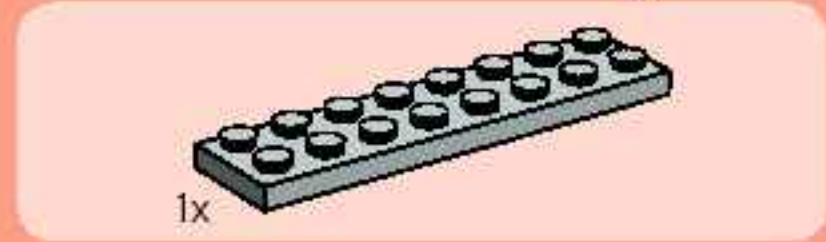
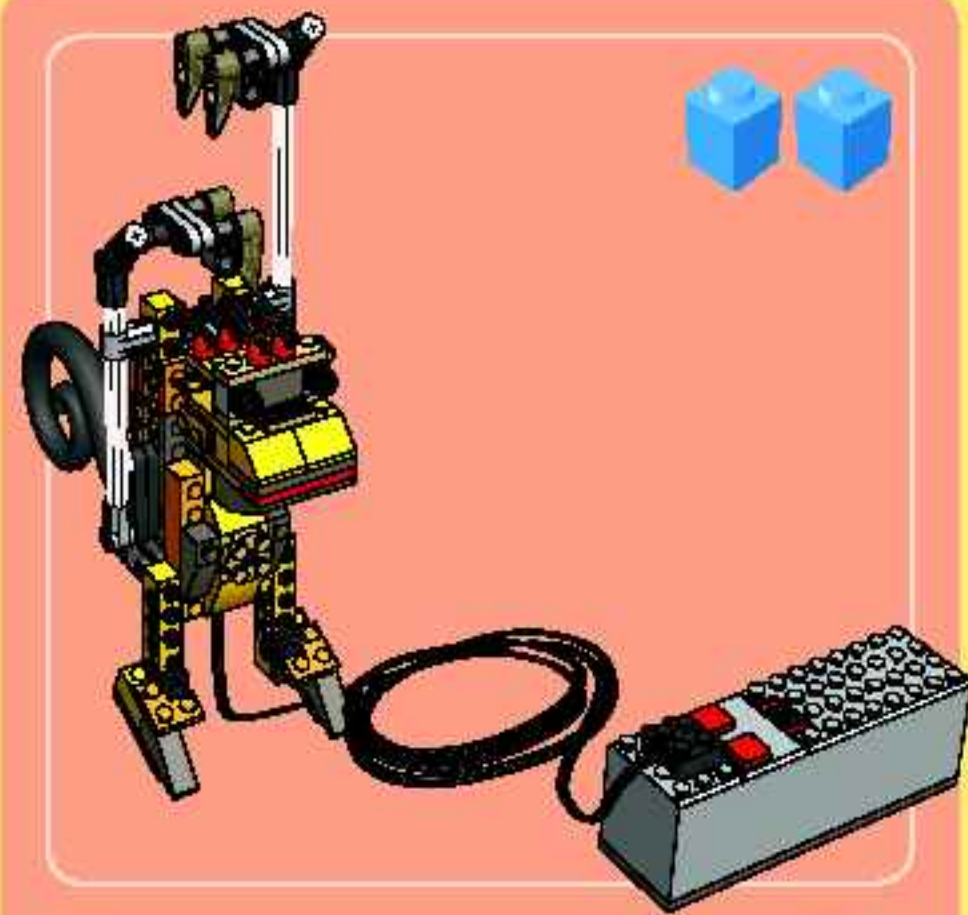

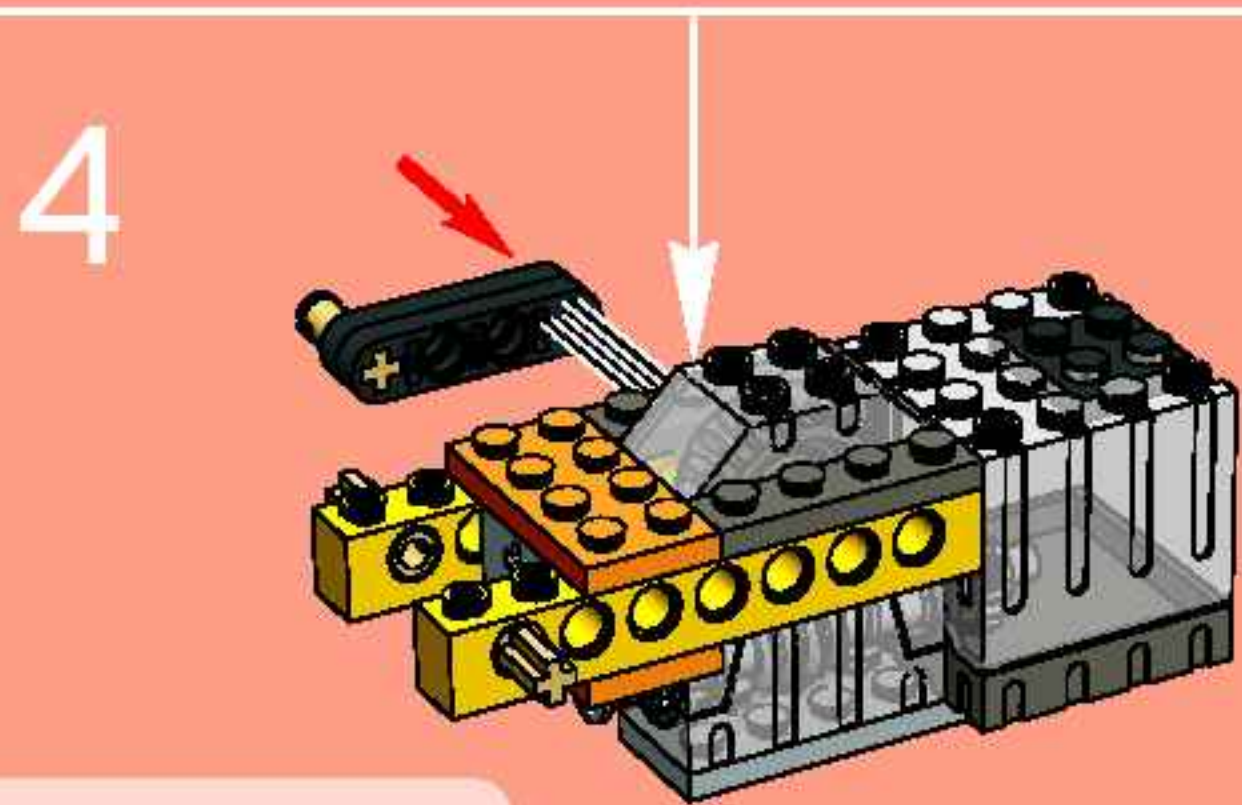
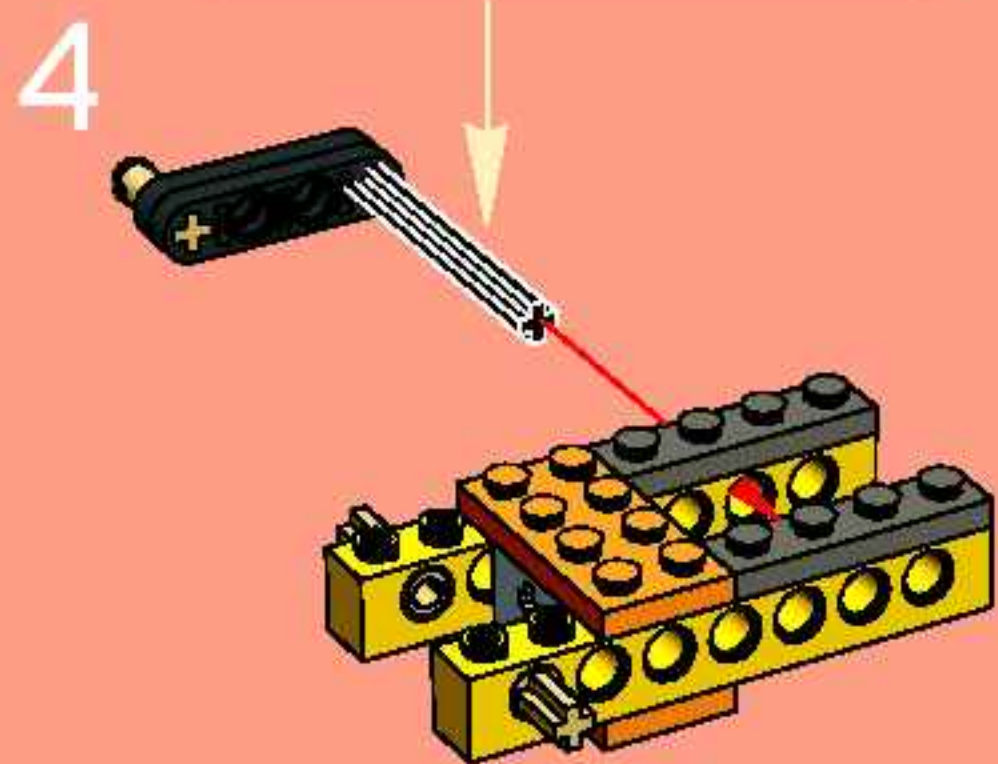
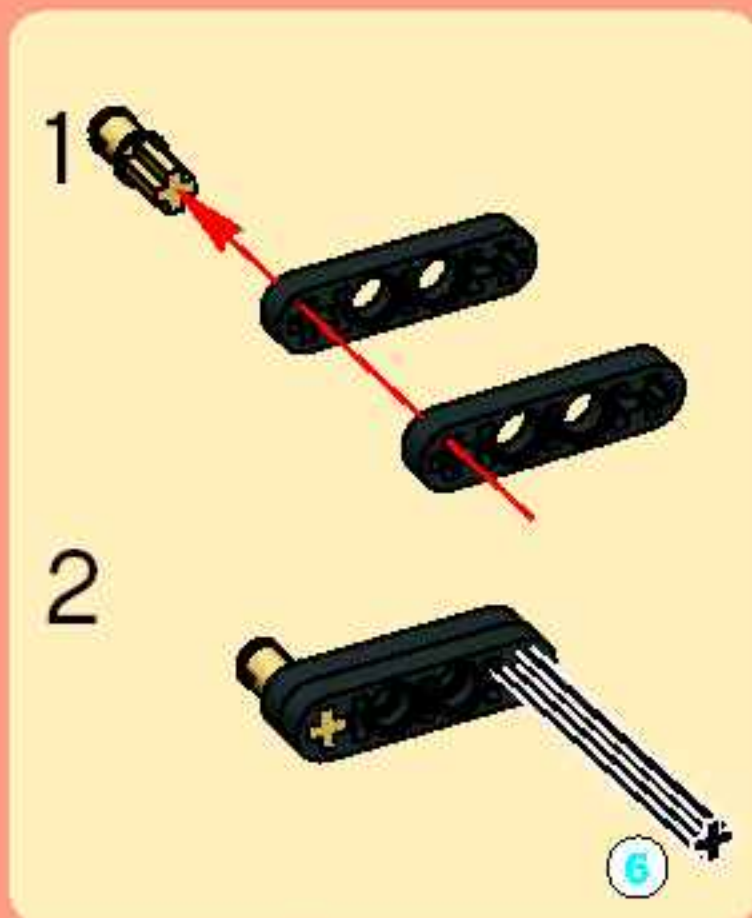

1:1



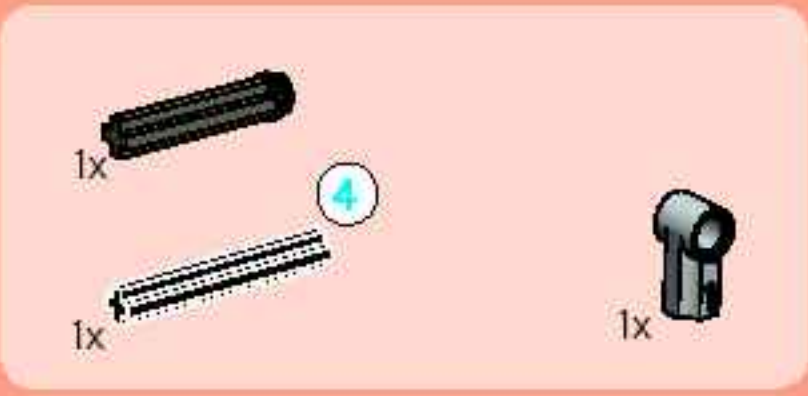

5

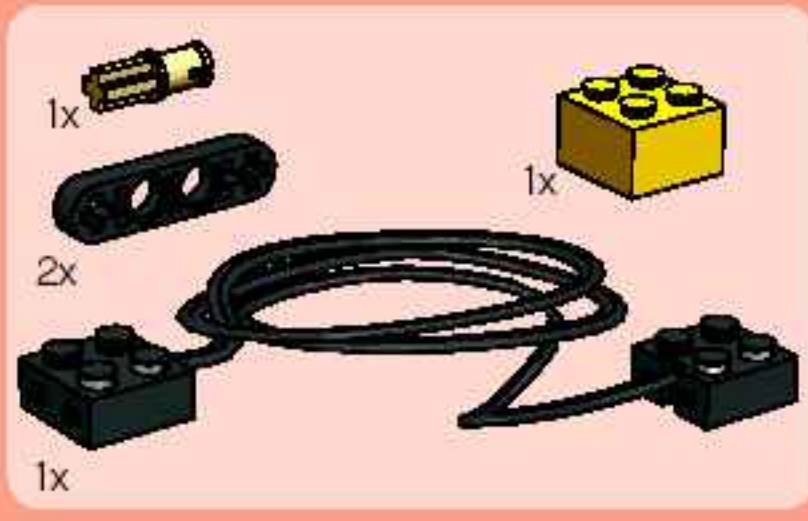
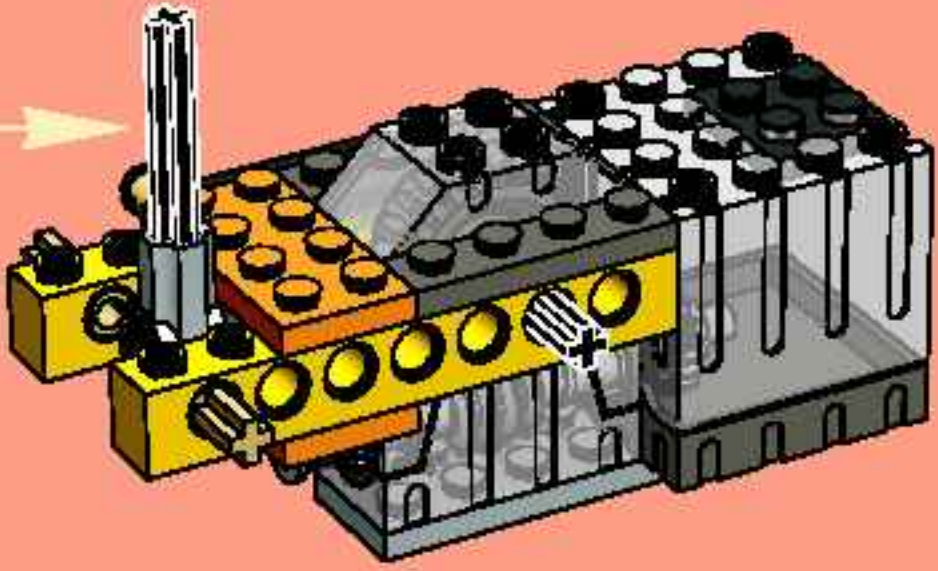
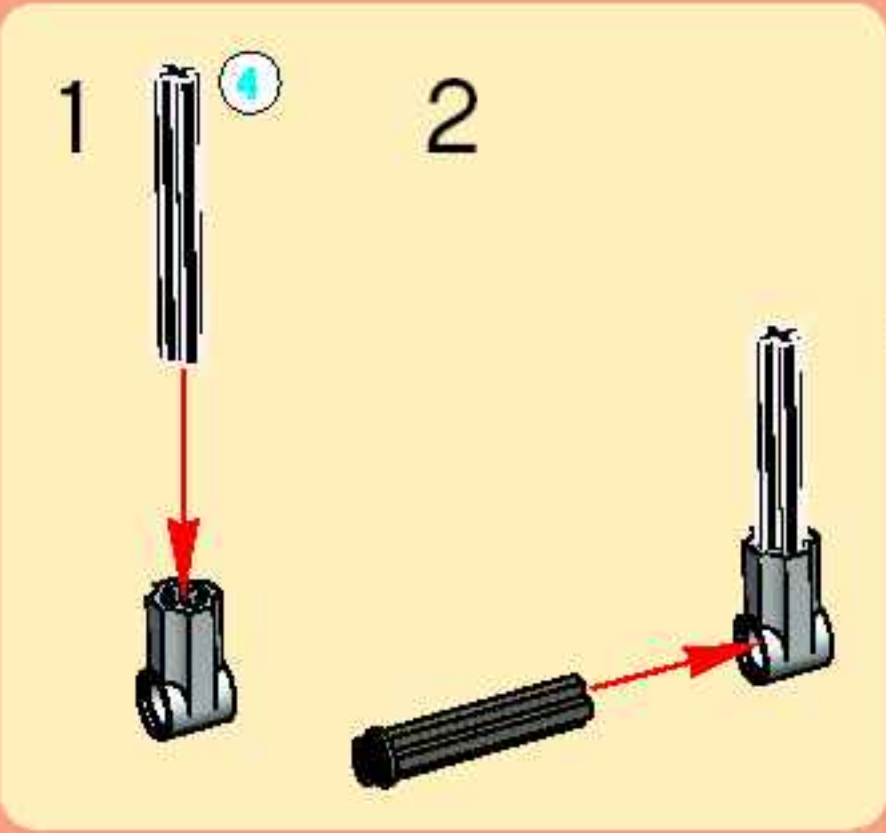

6

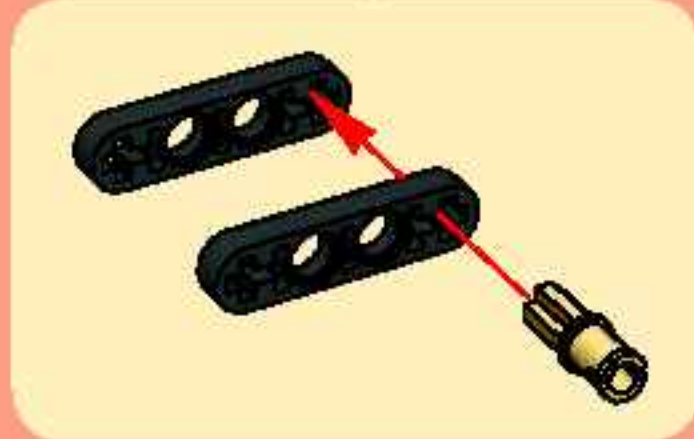
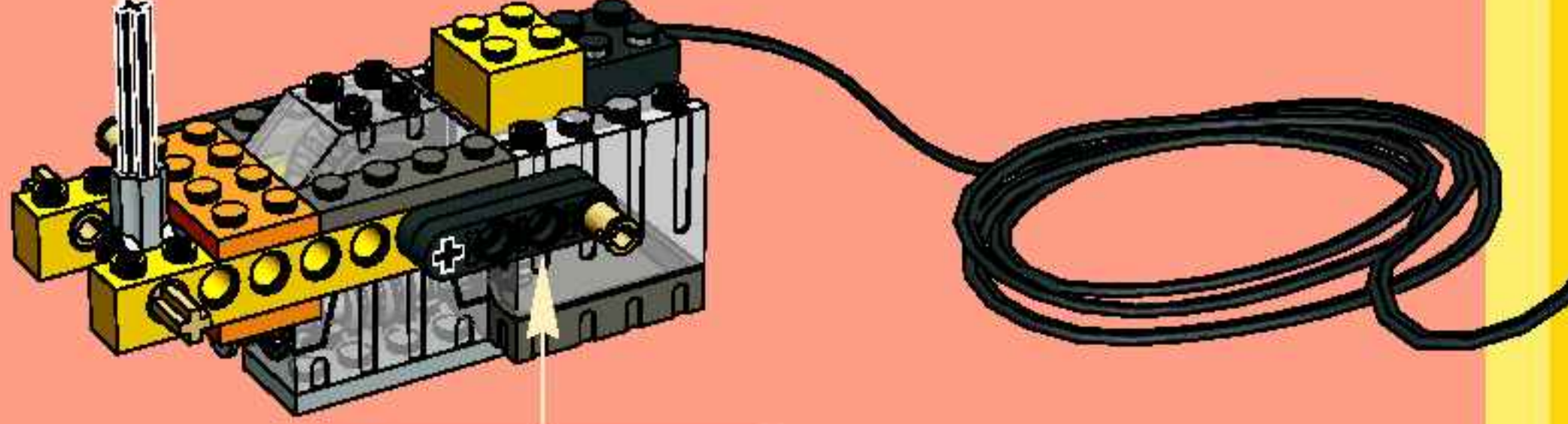

7

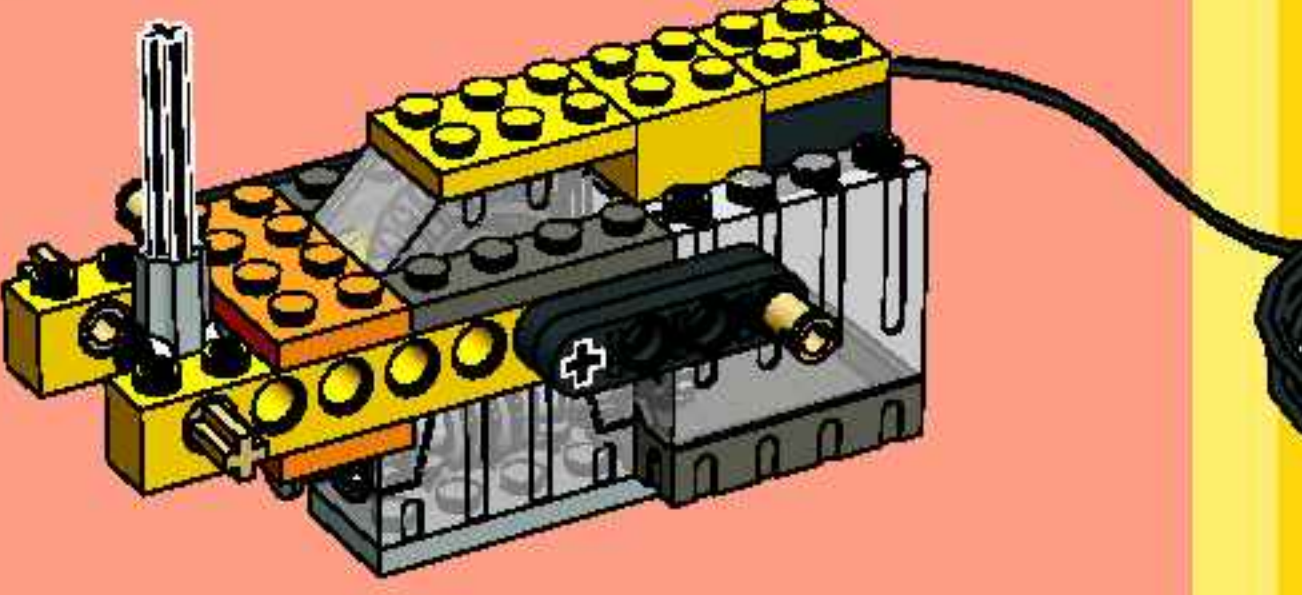

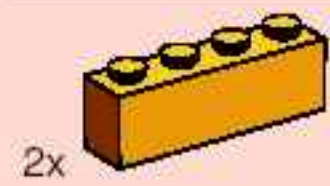

8

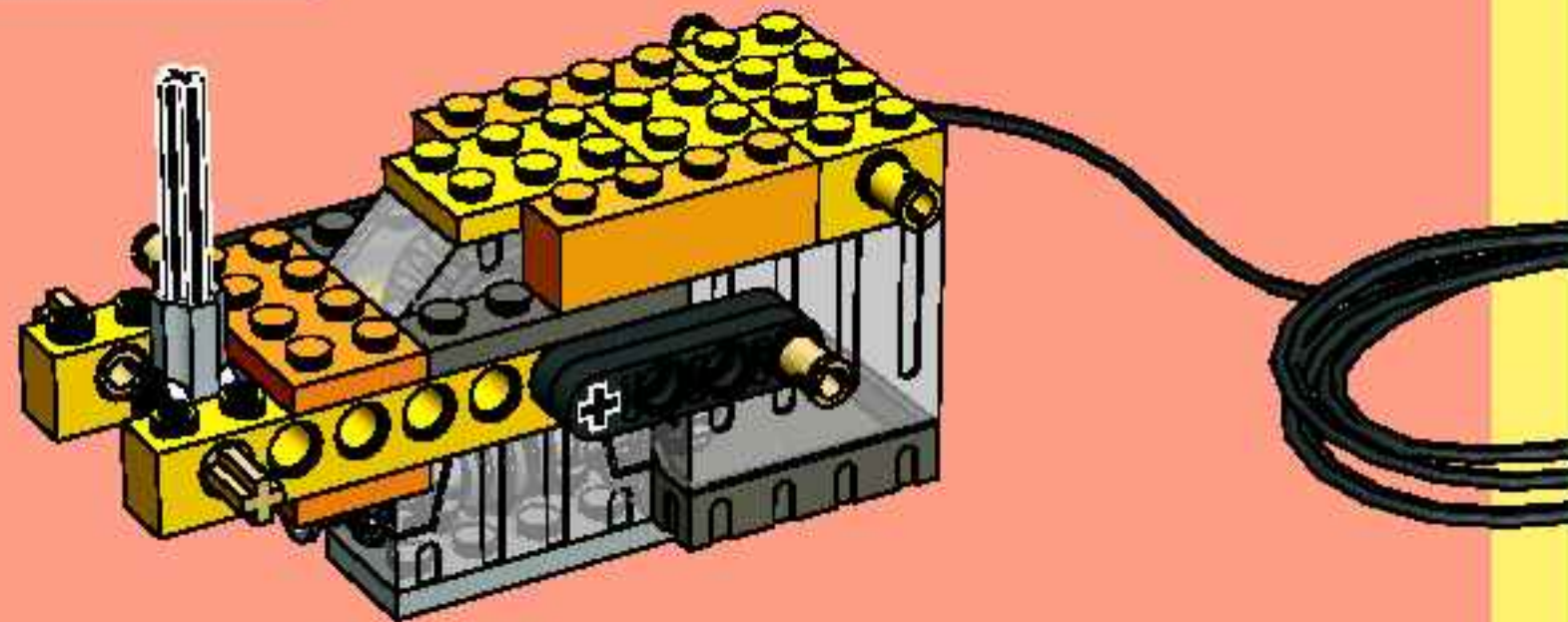

9

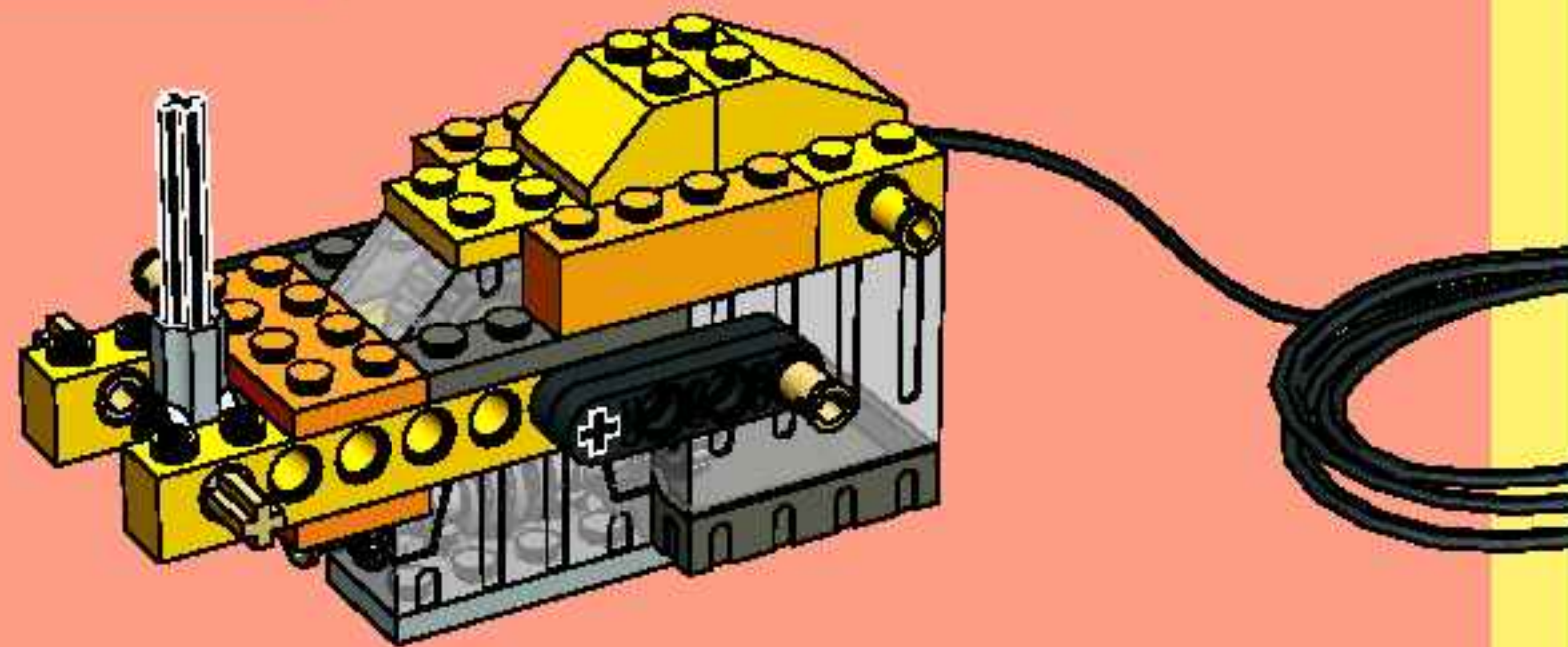

10

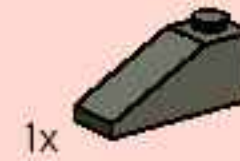
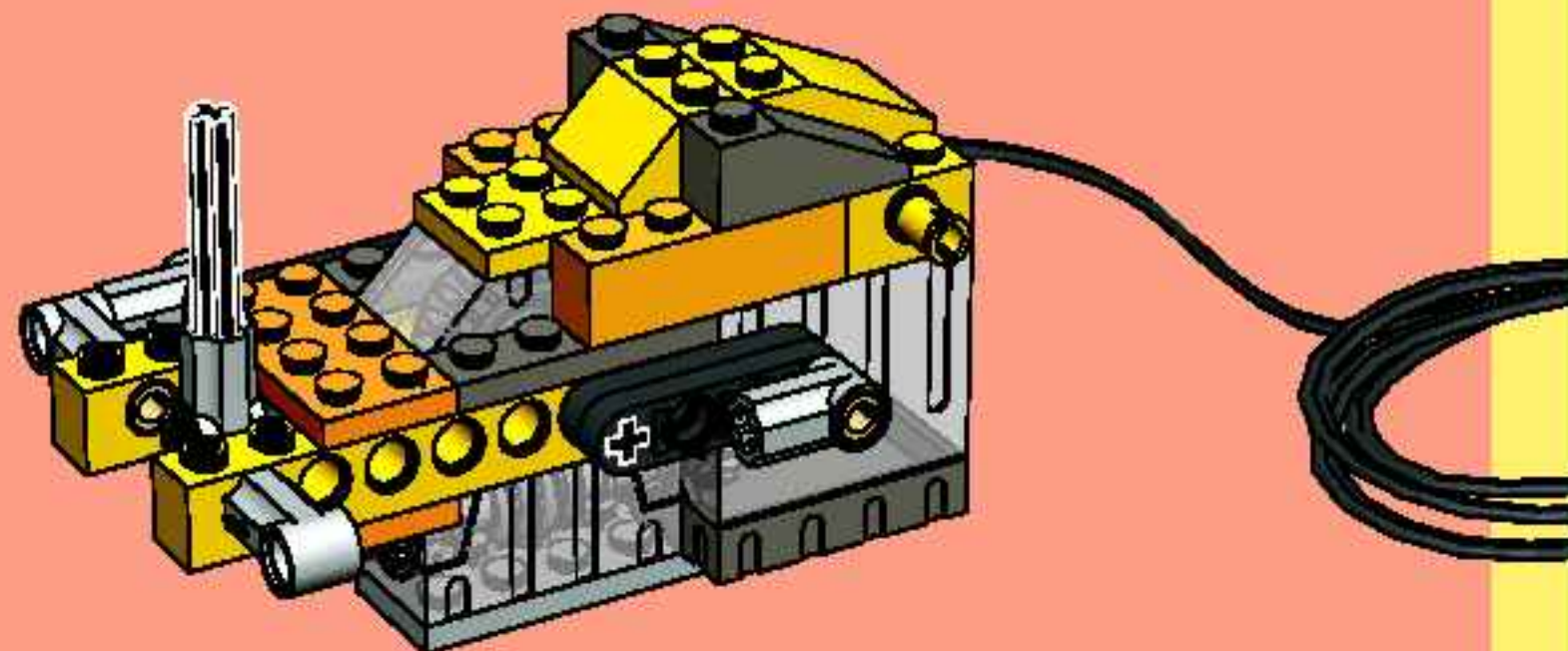

11

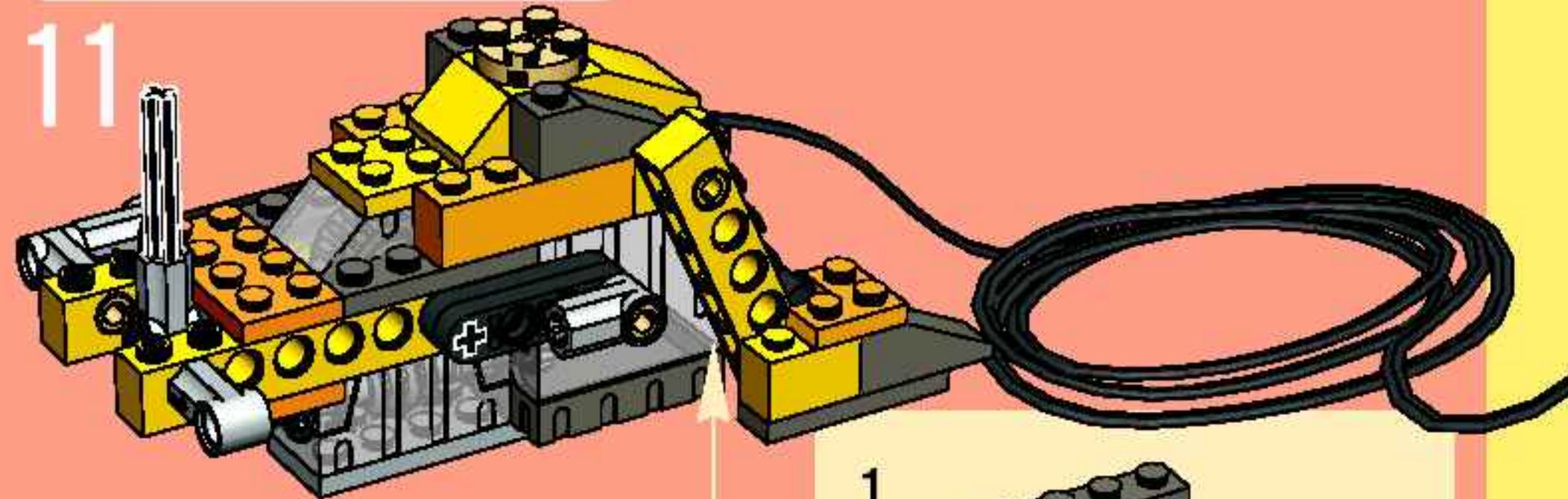

4

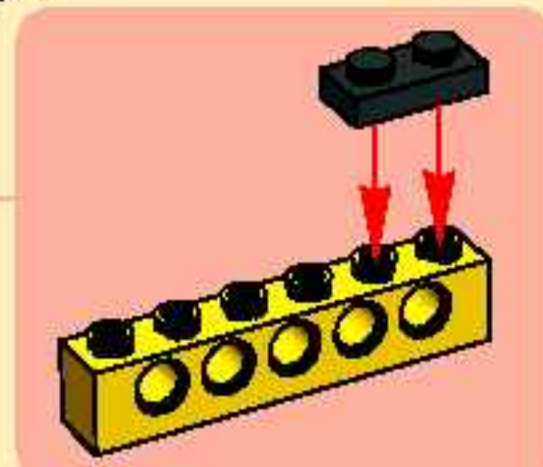
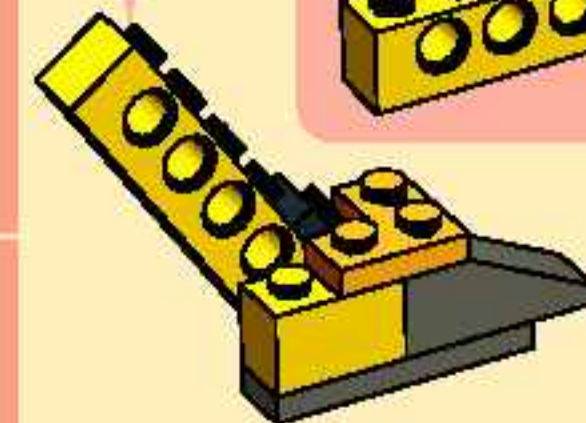

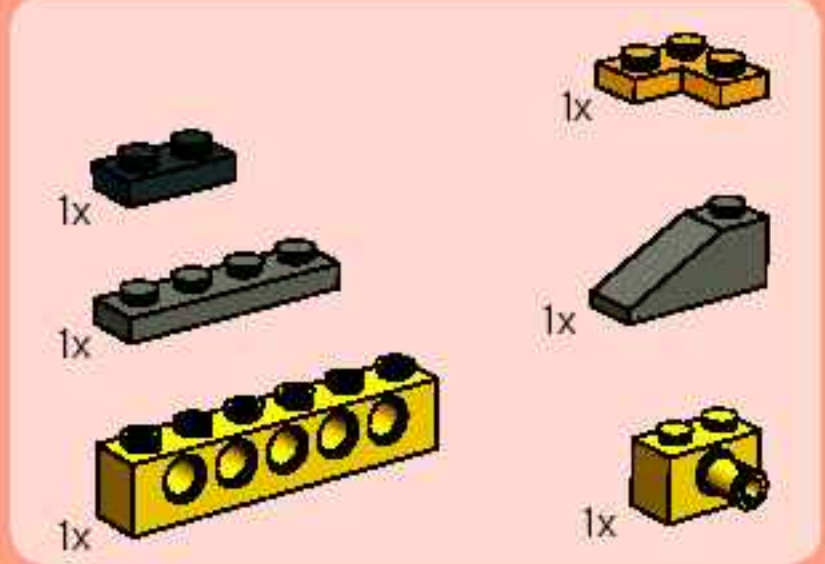

12

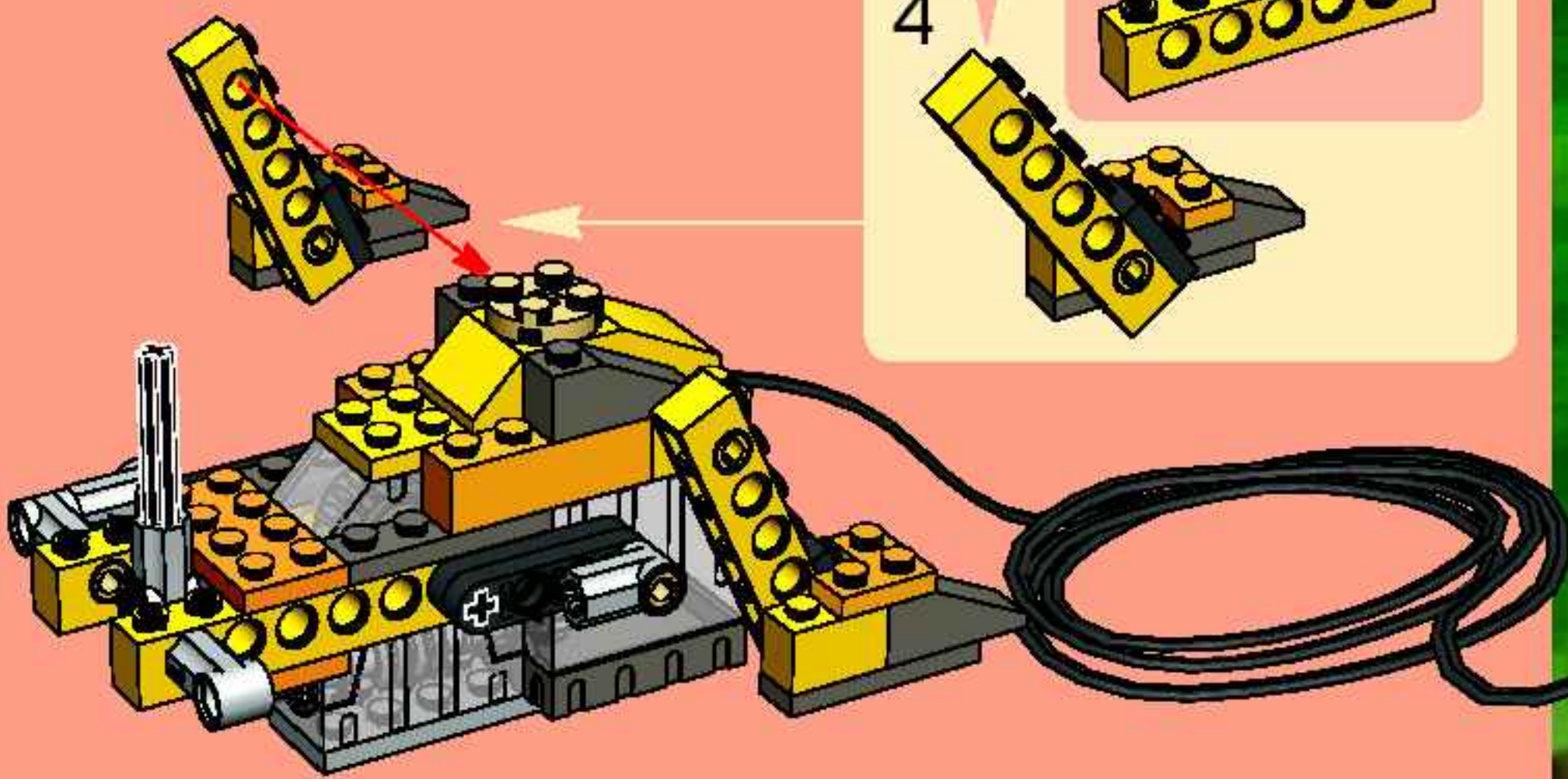
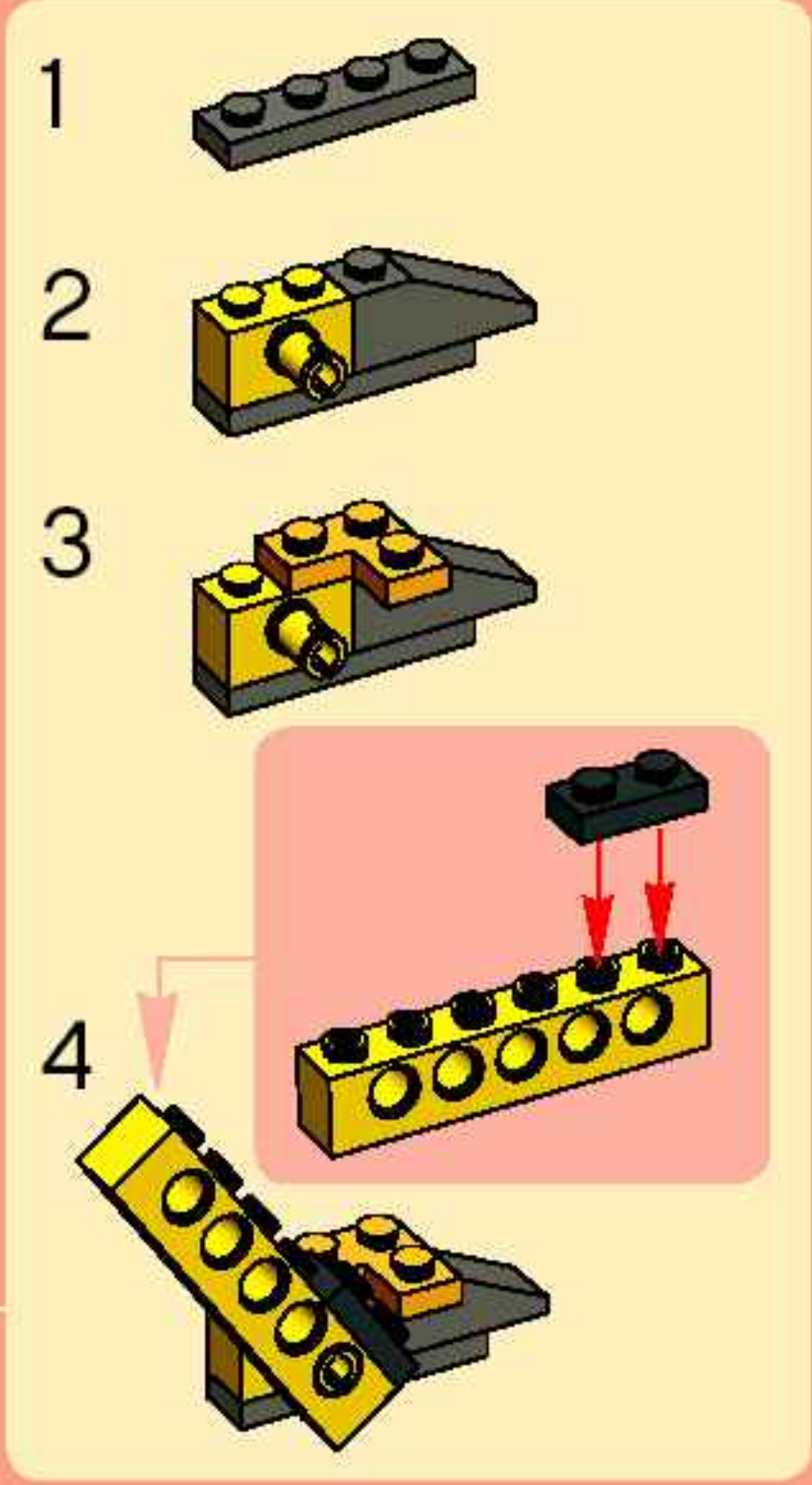

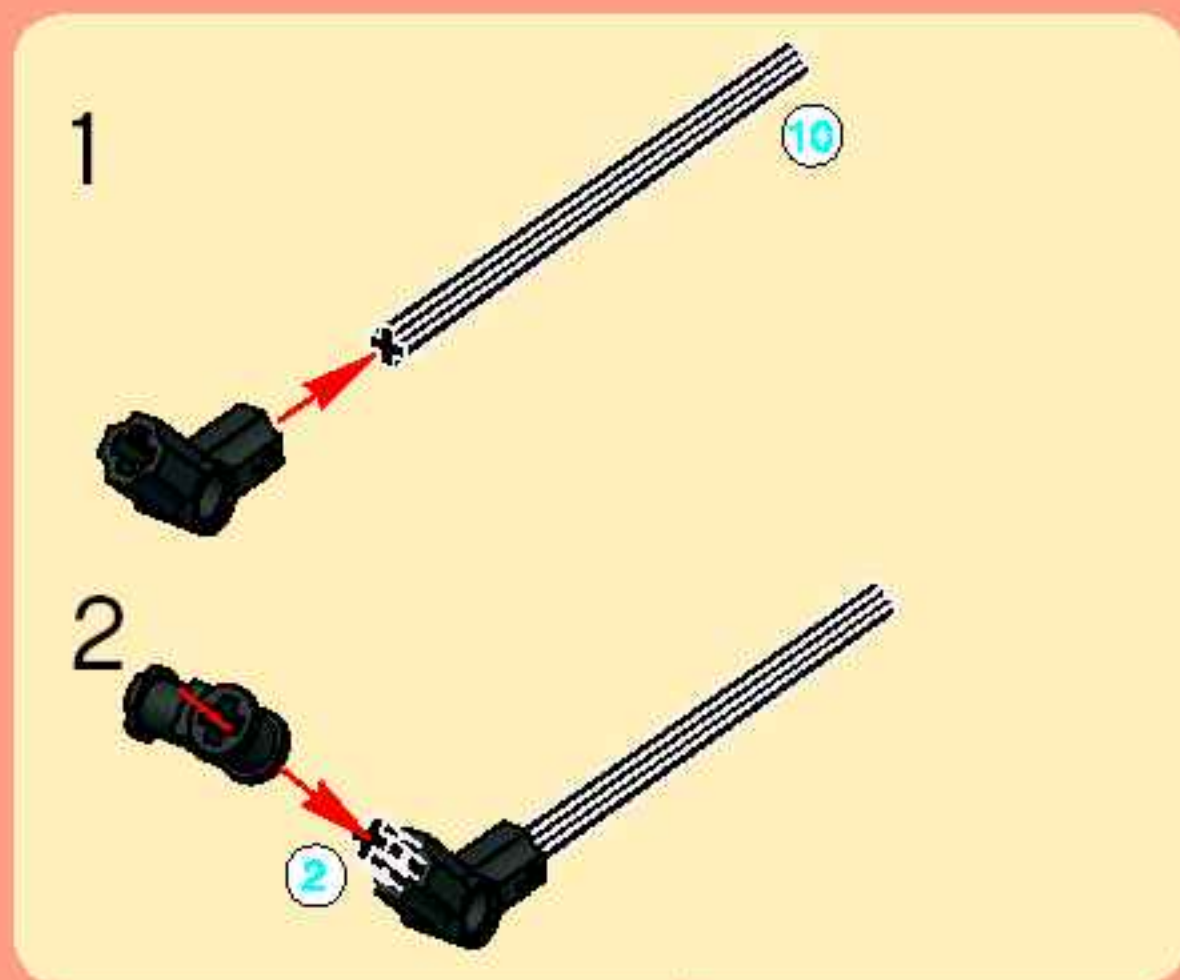
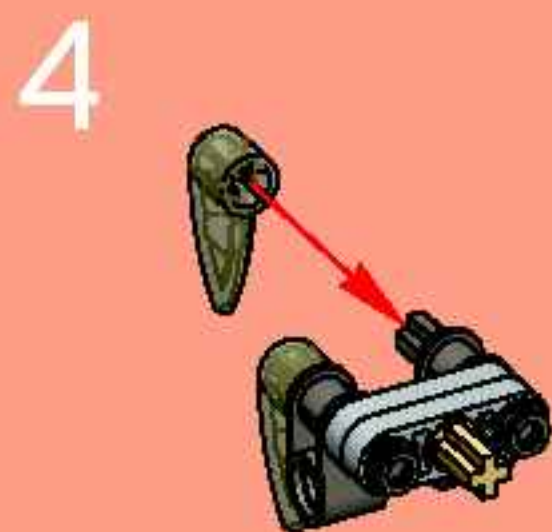
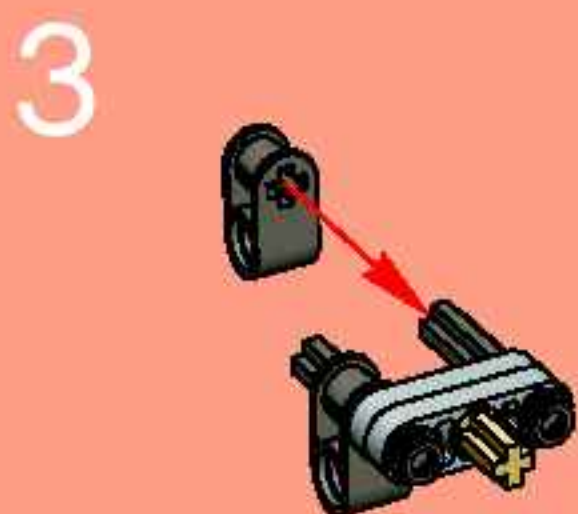
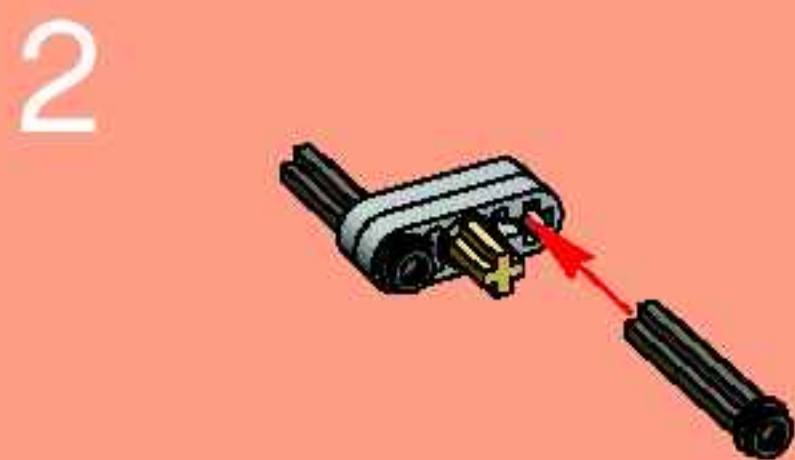
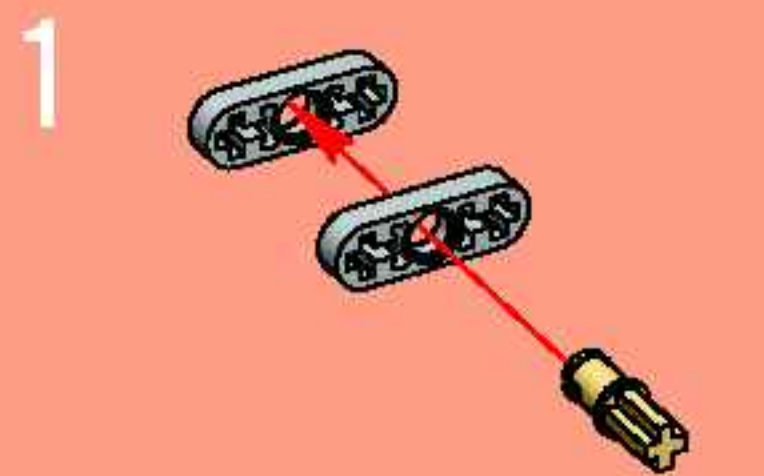

13

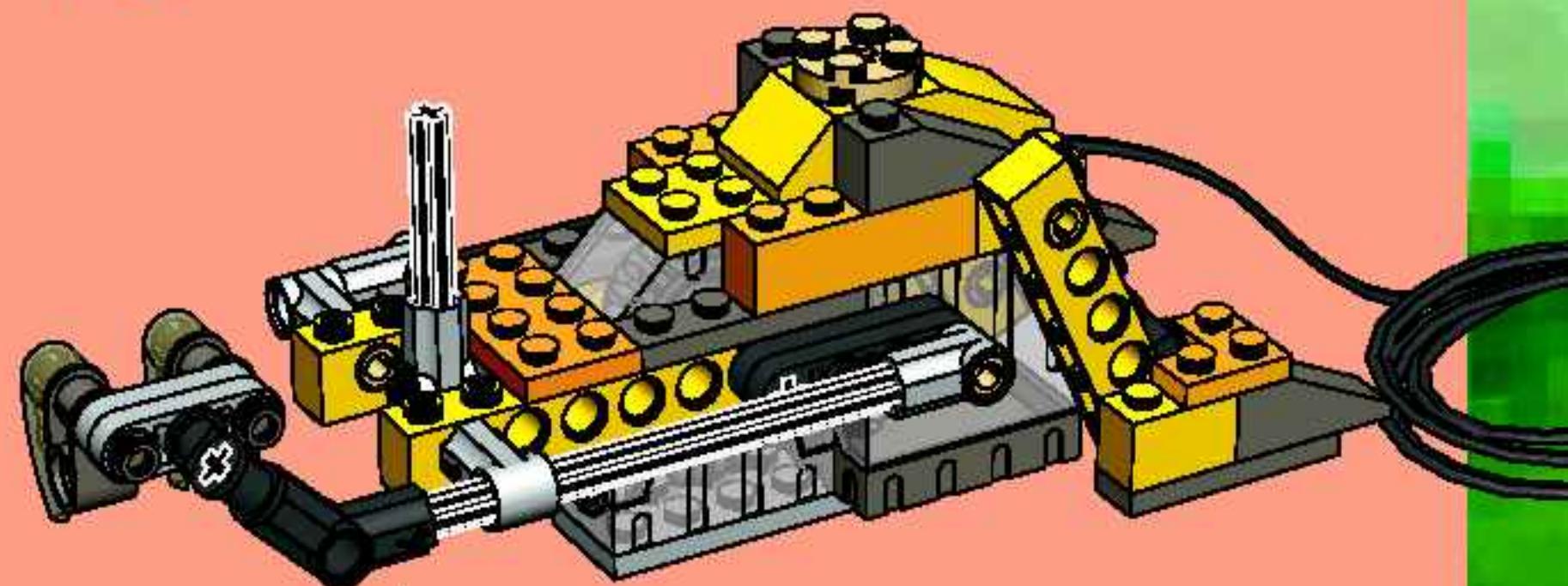



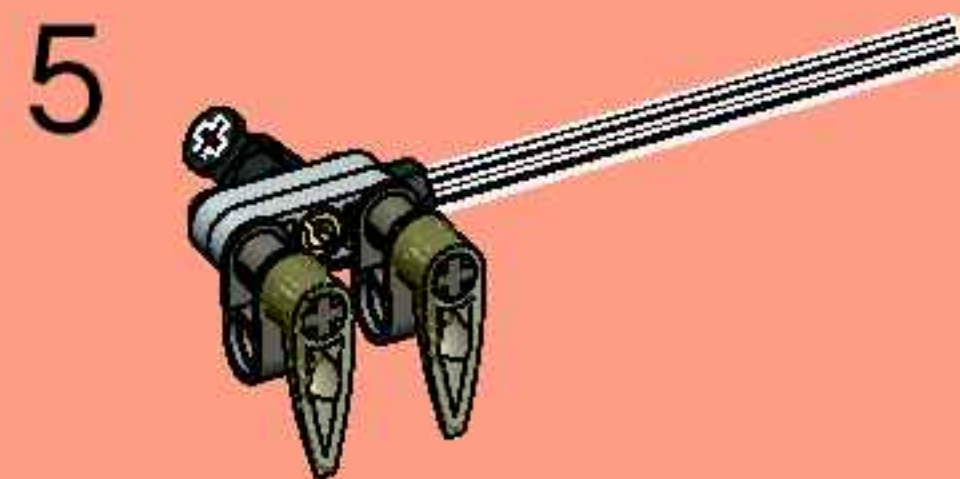
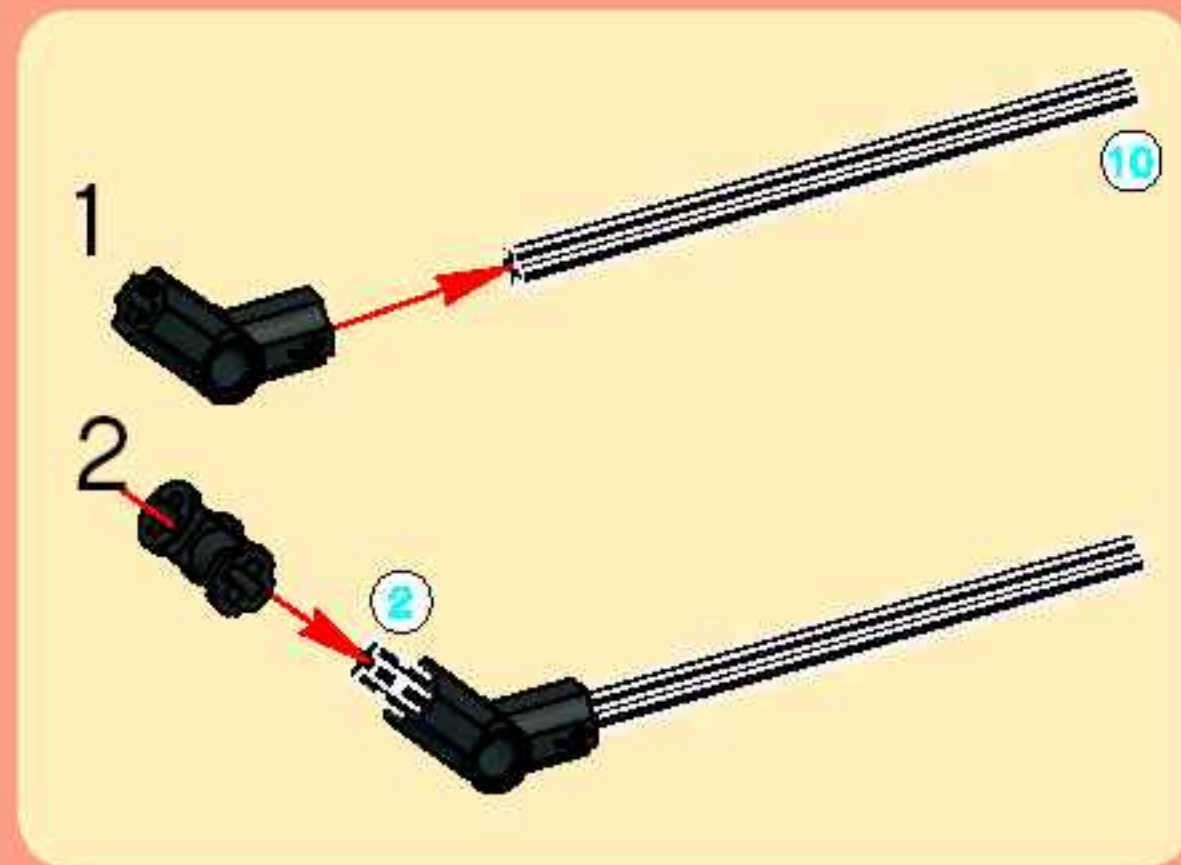
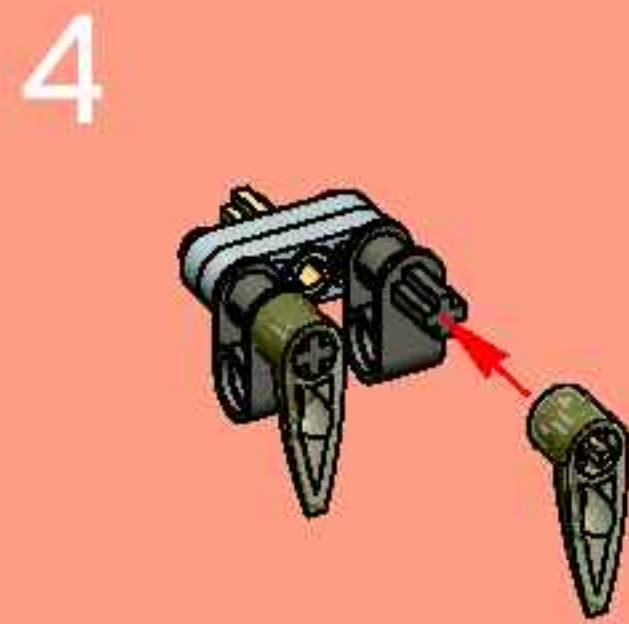
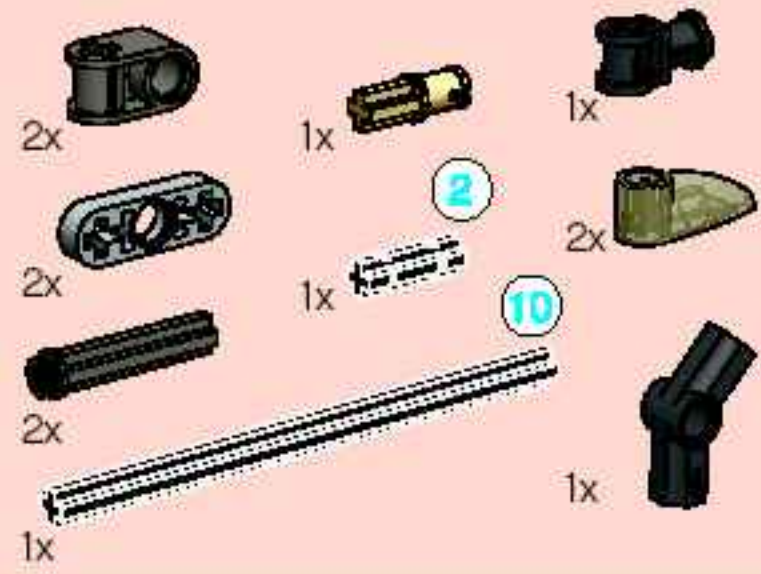

14

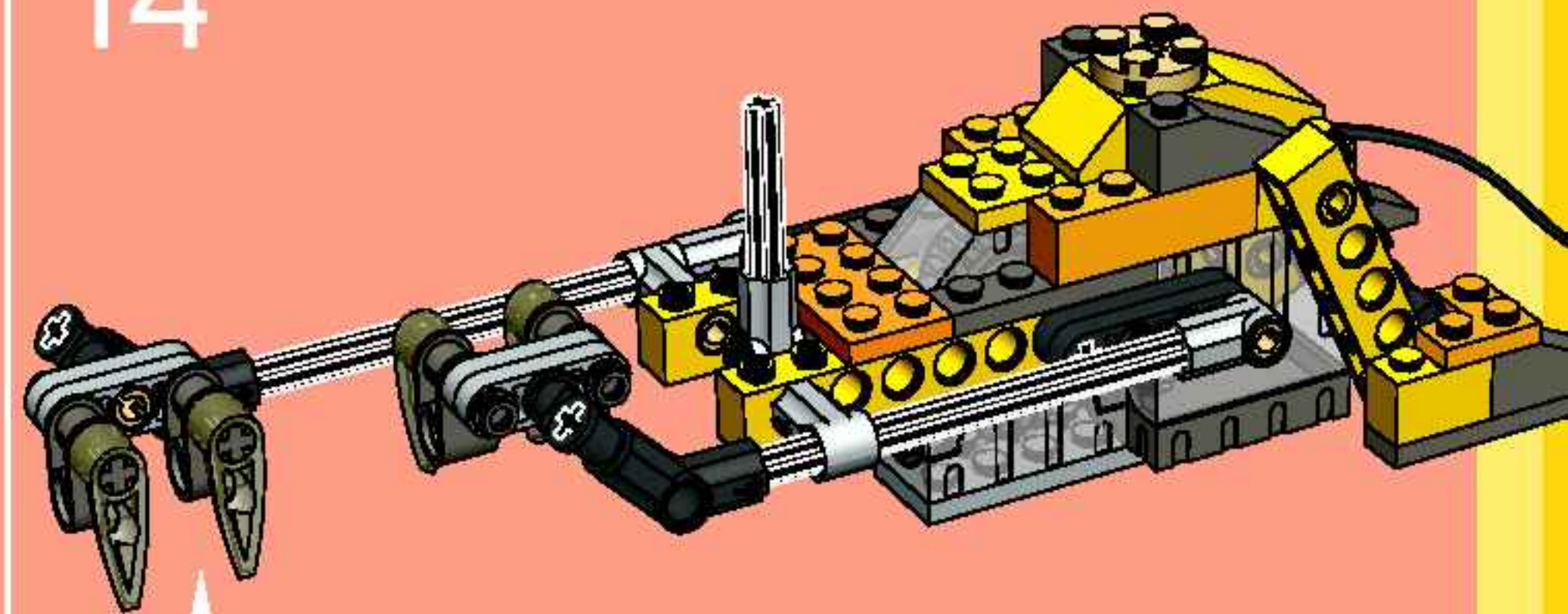

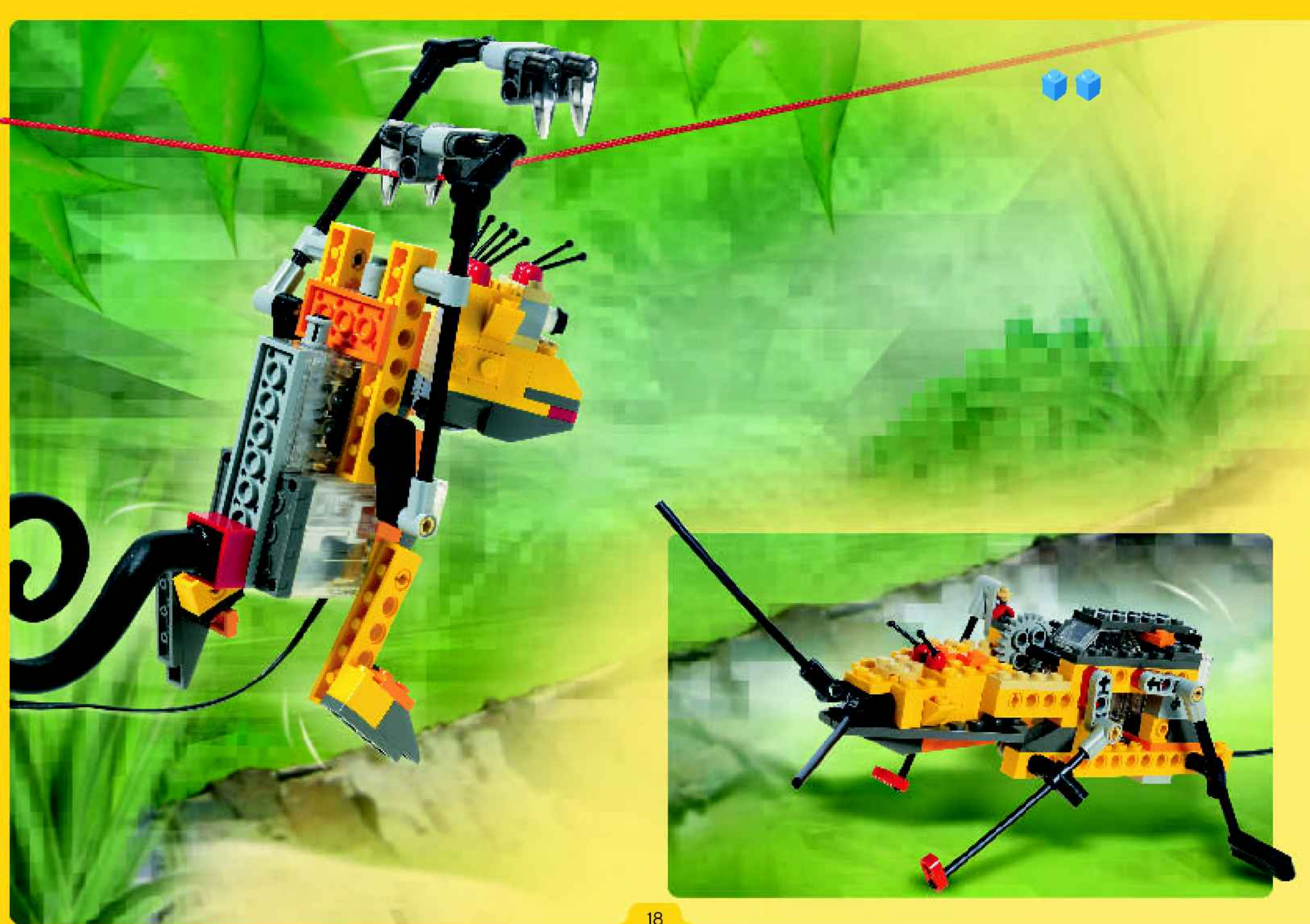

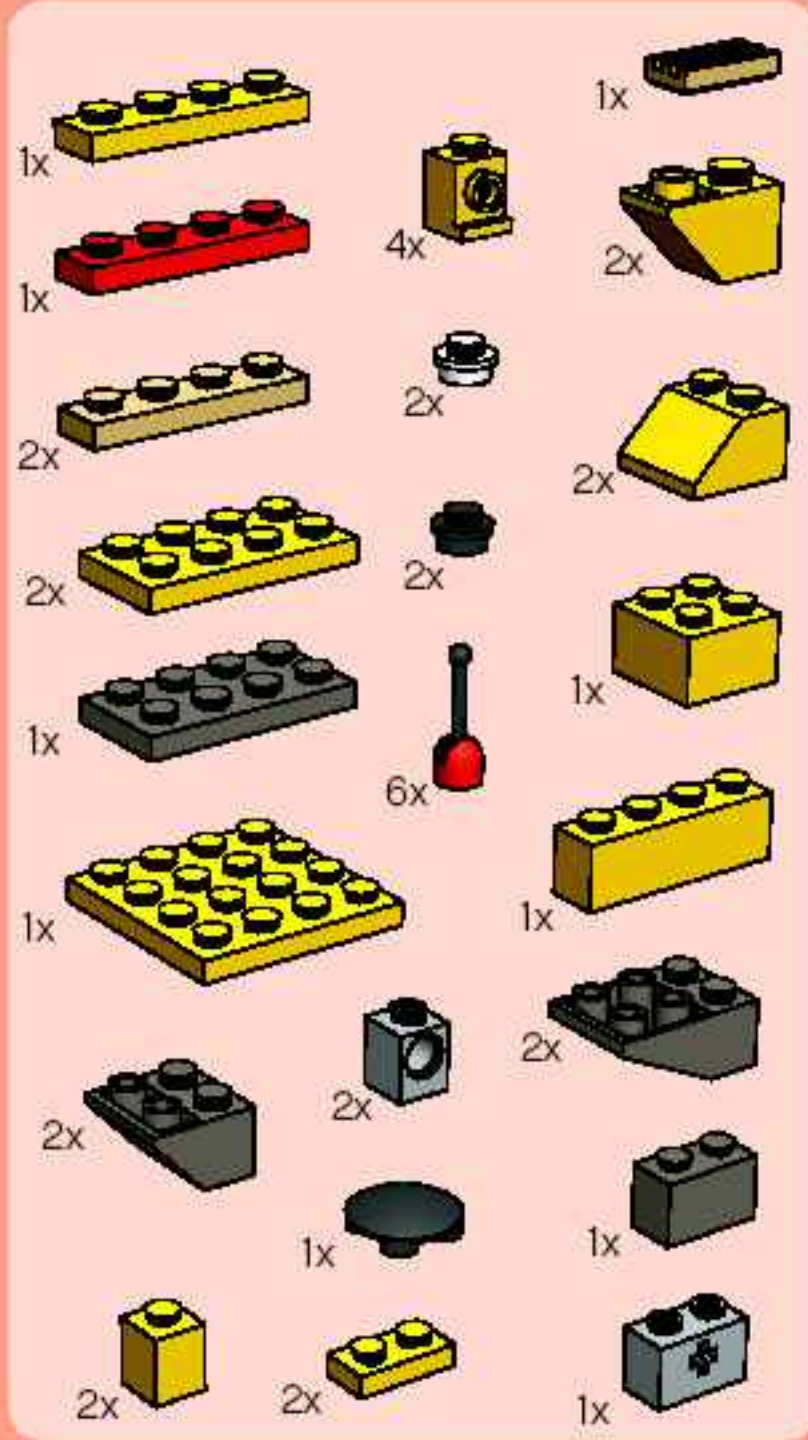

15

1



2

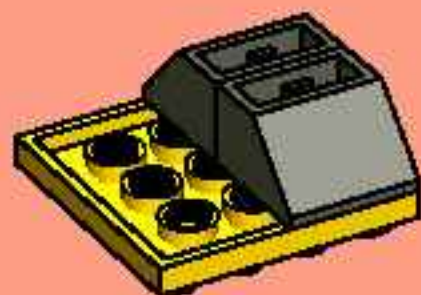

3

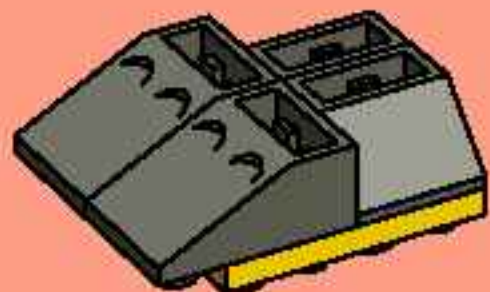

4

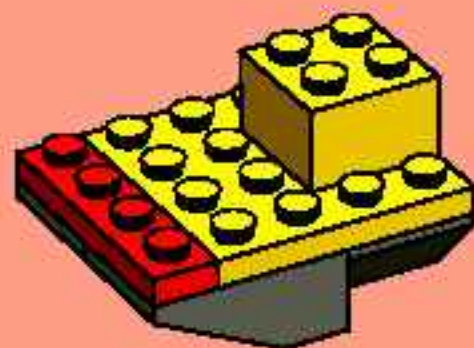

5

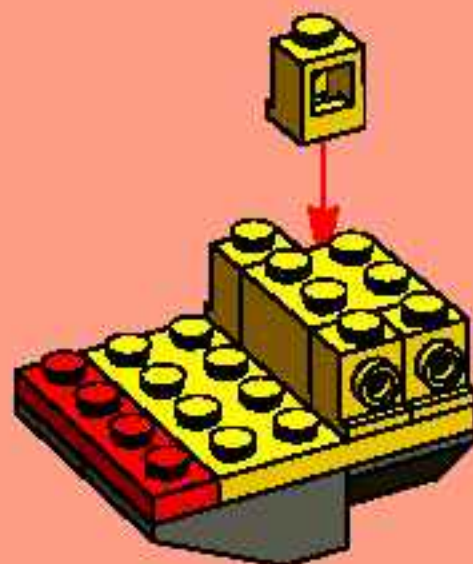

6



7

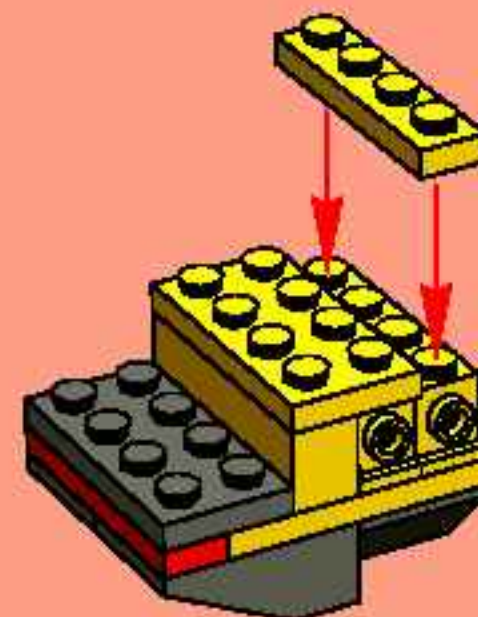

8

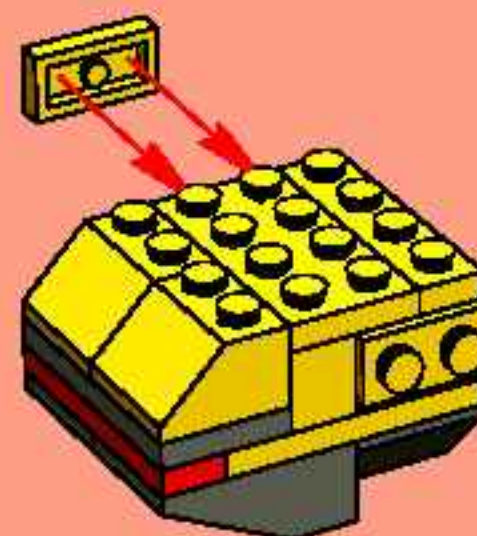

9

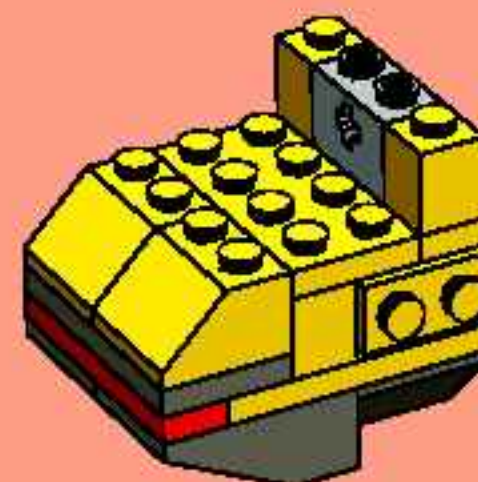

10

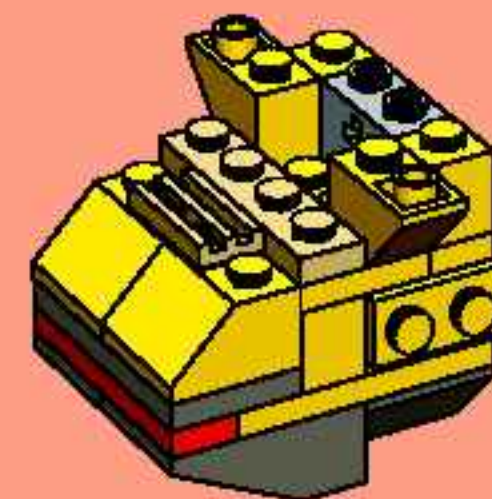

11

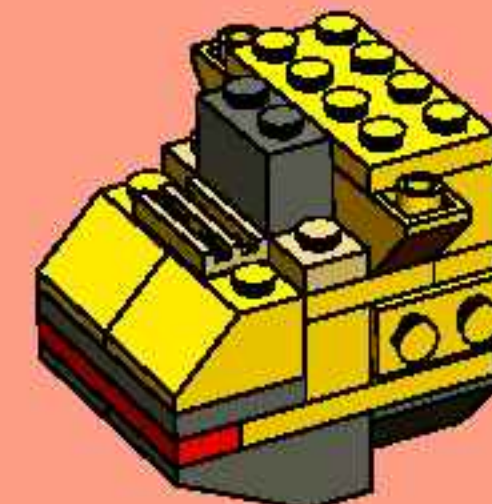

12

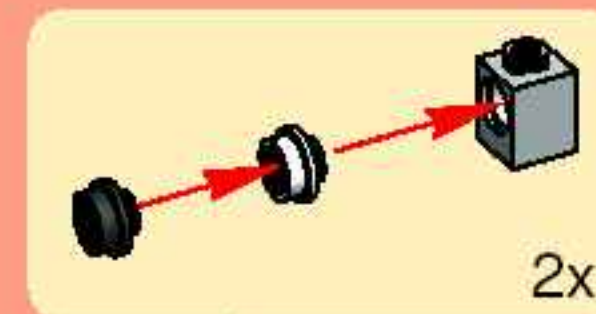

13



14

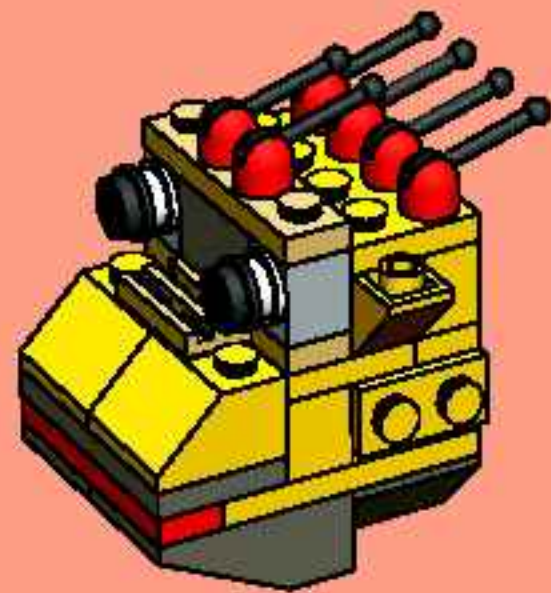

15

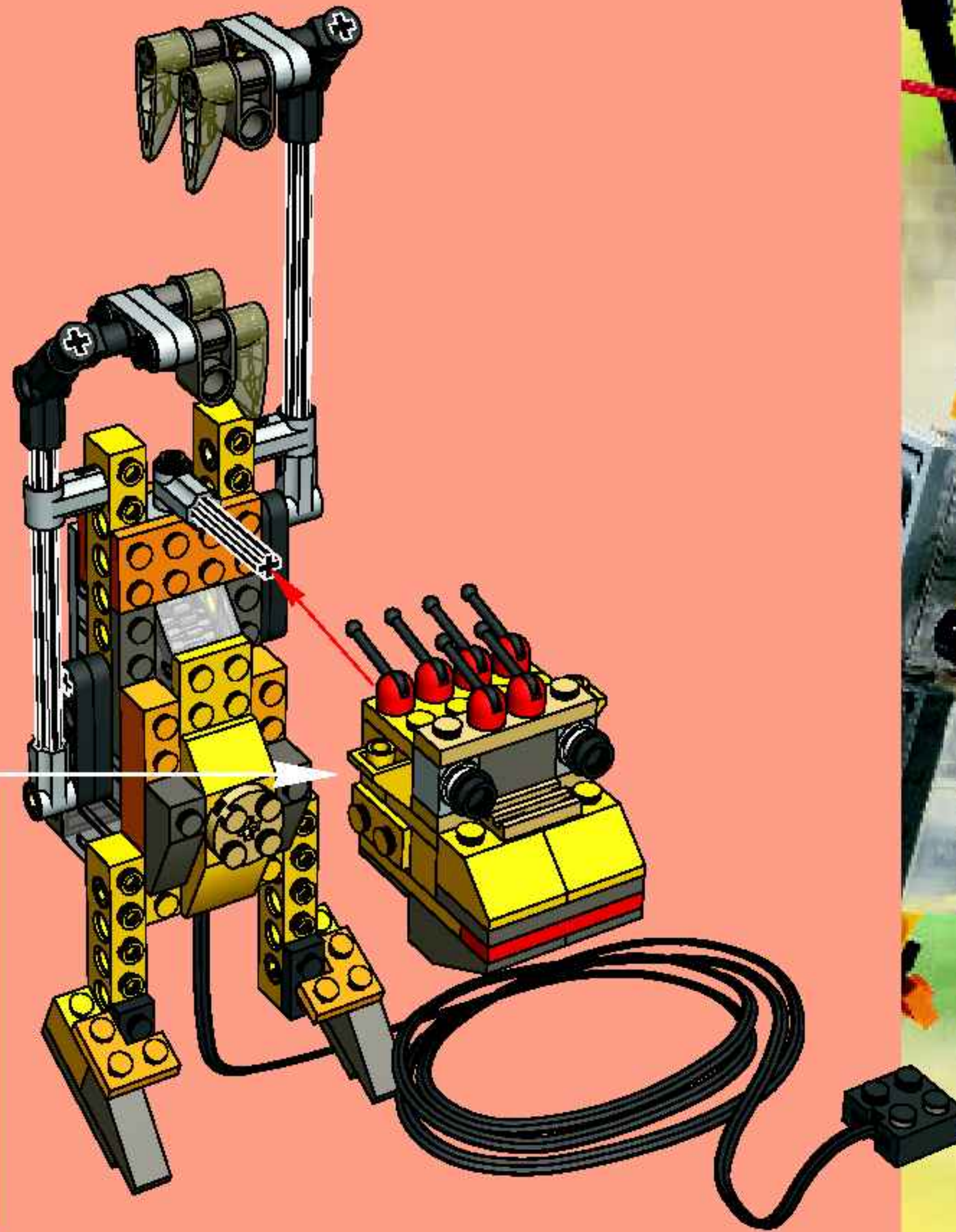
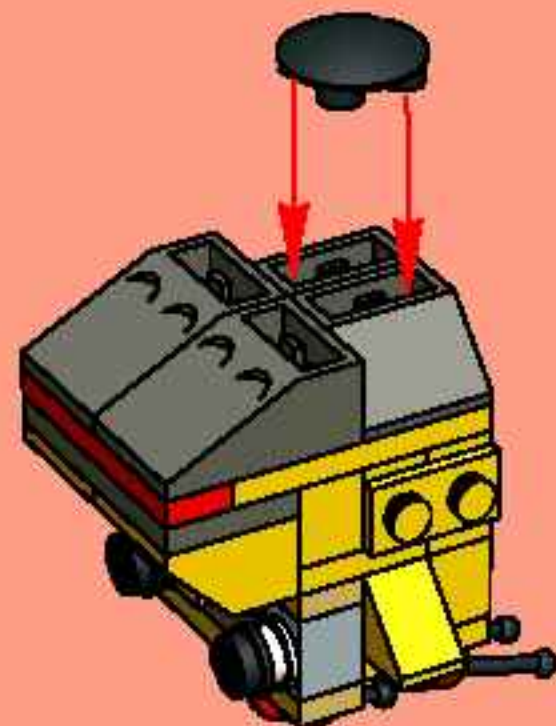

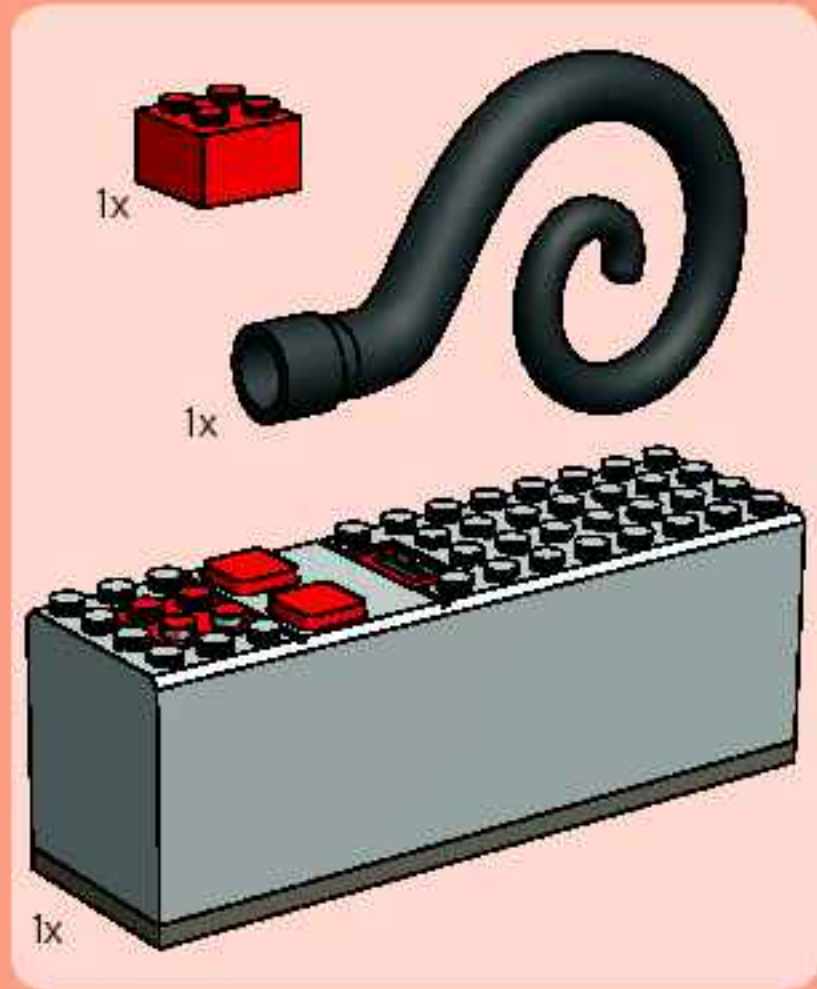

16

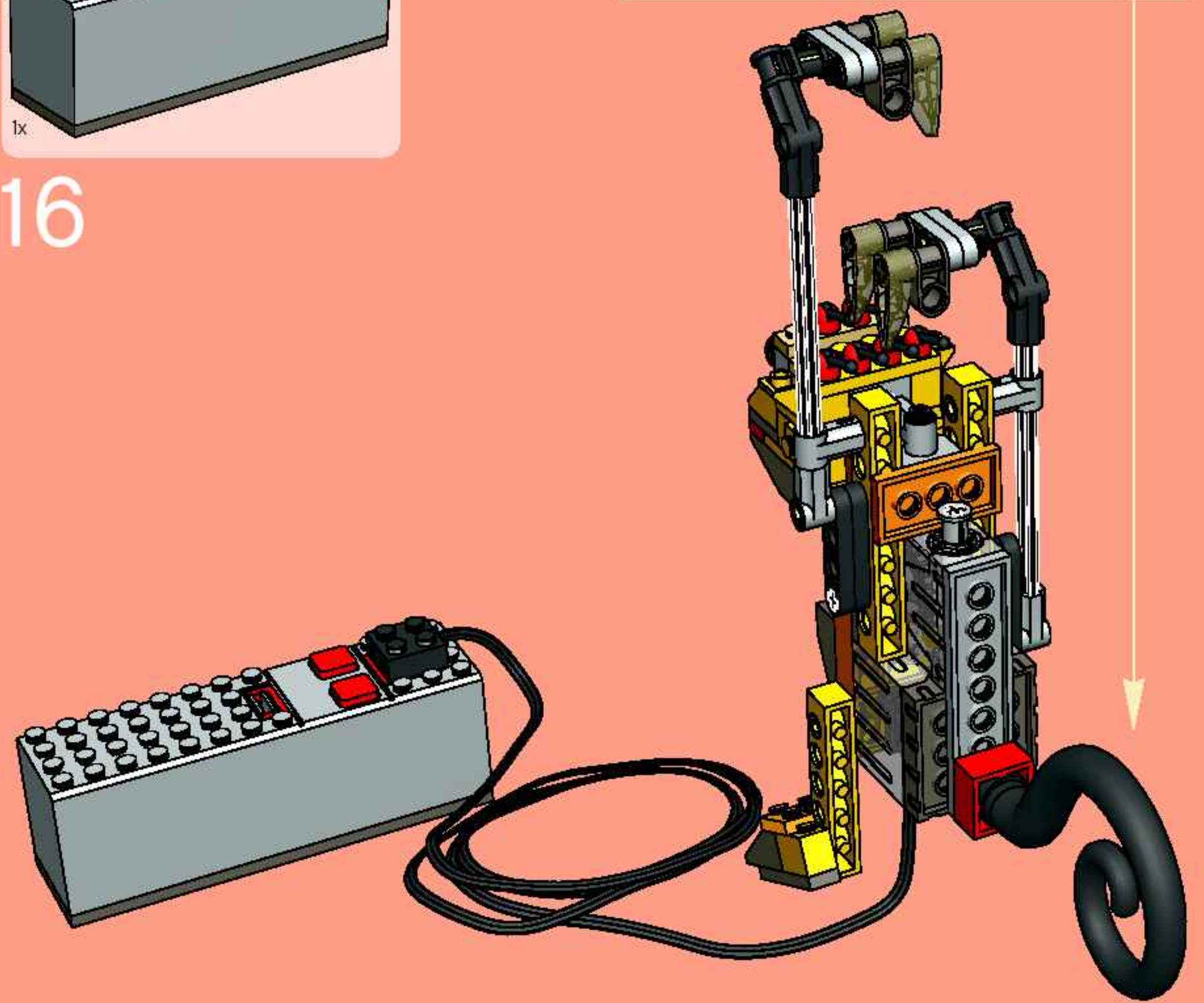















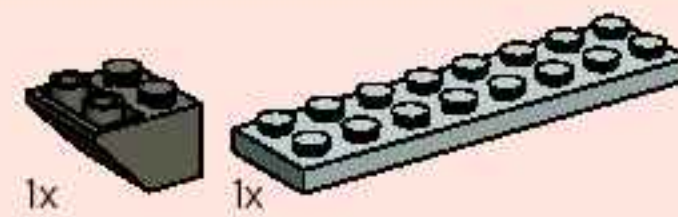
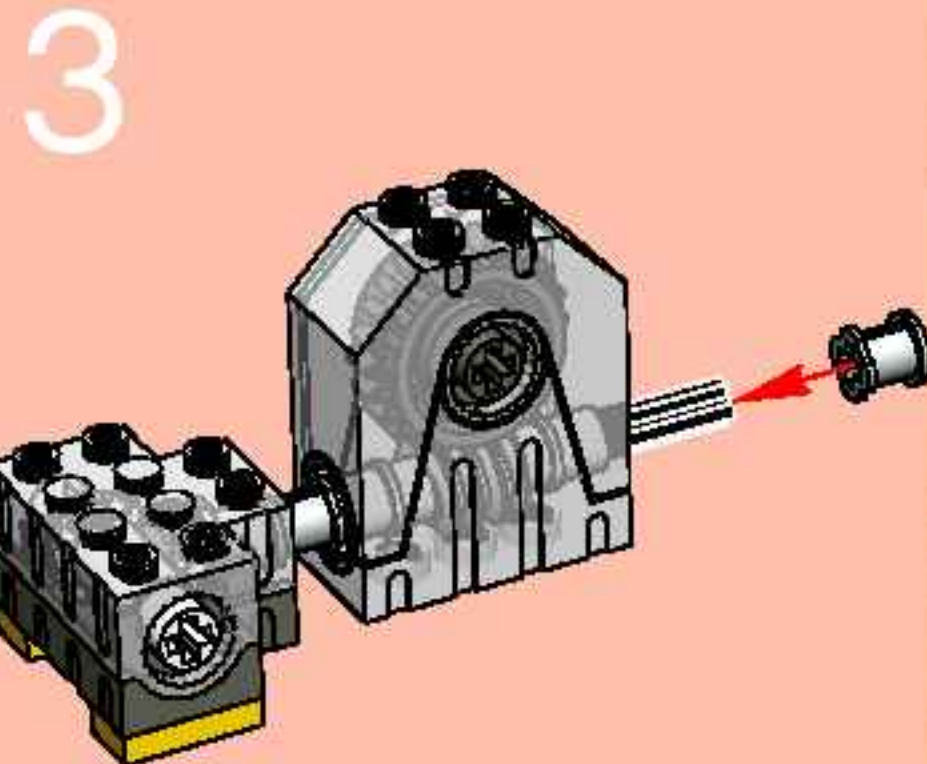
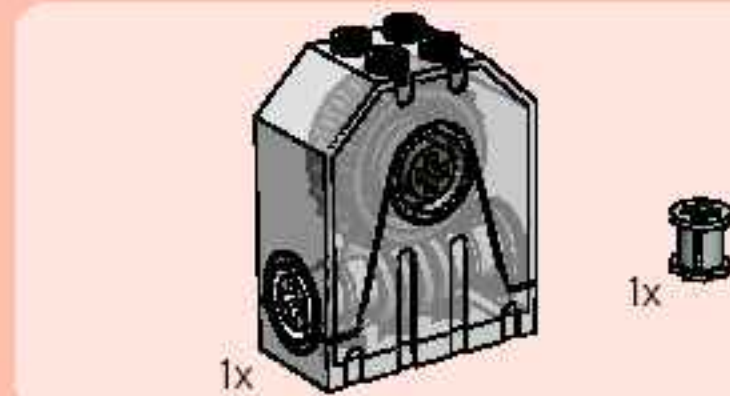
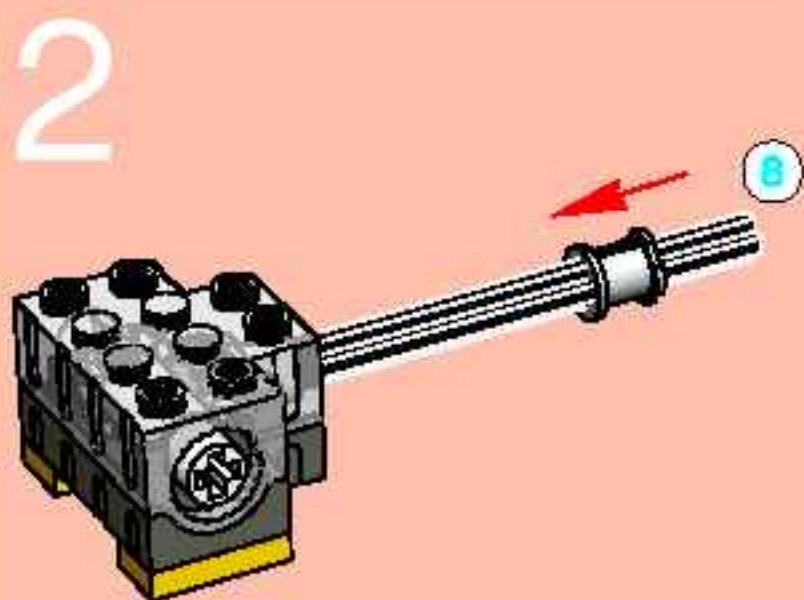
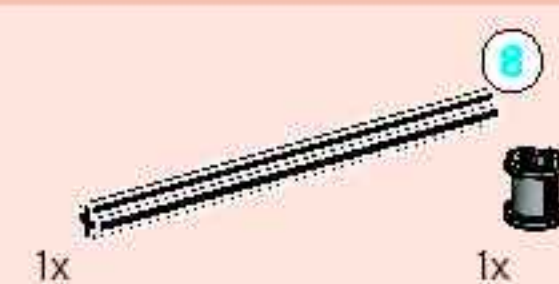
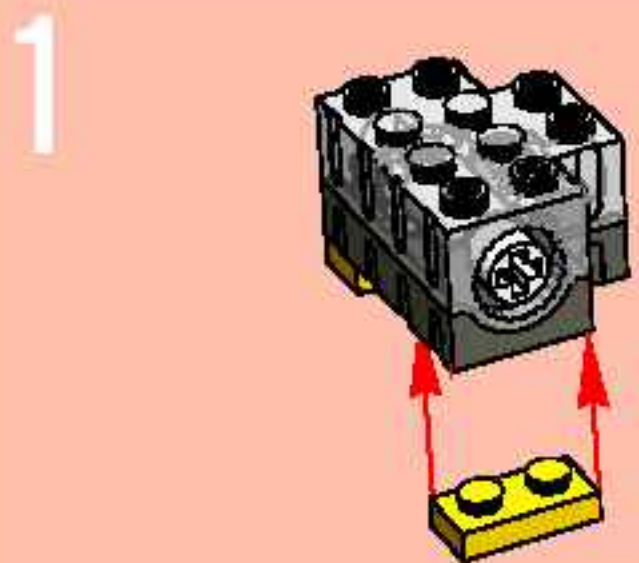
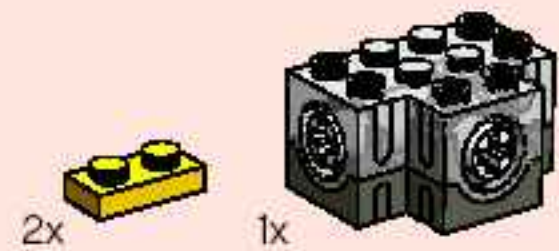
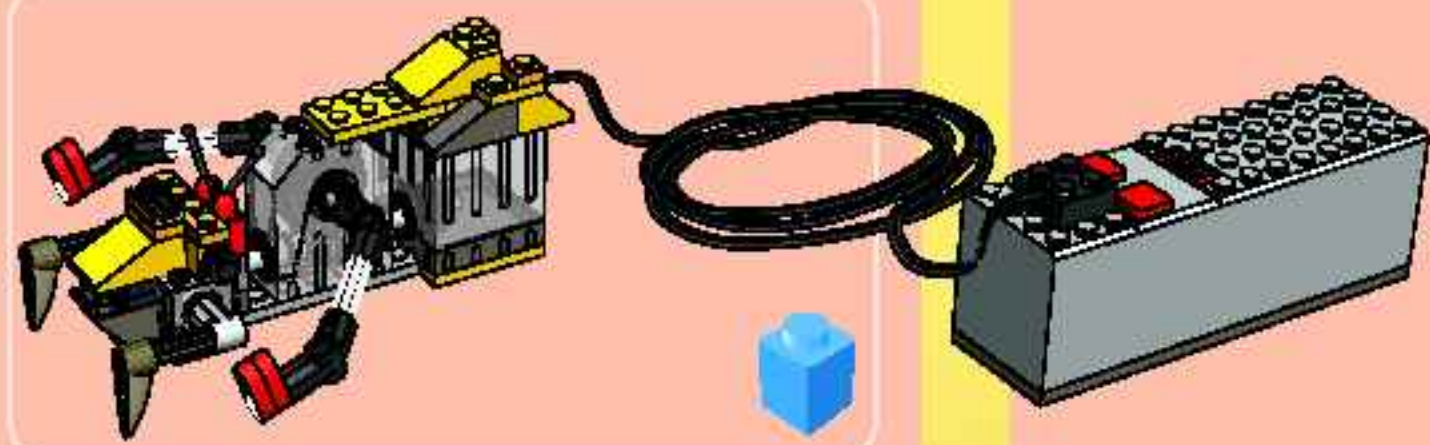

4

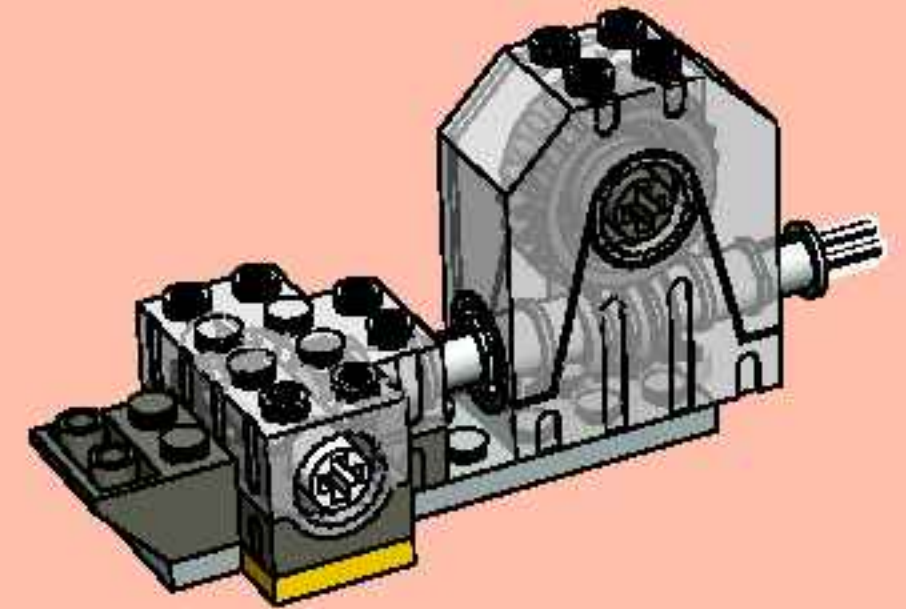
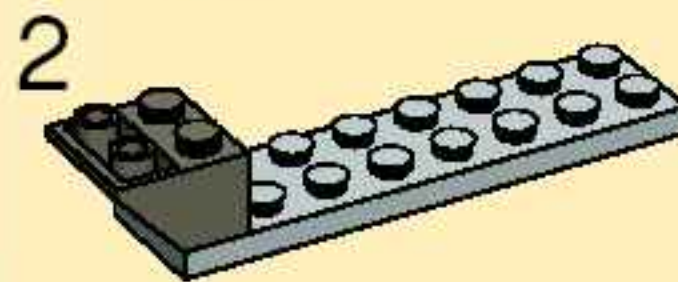
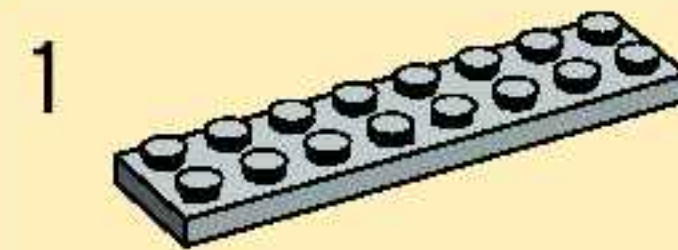

5

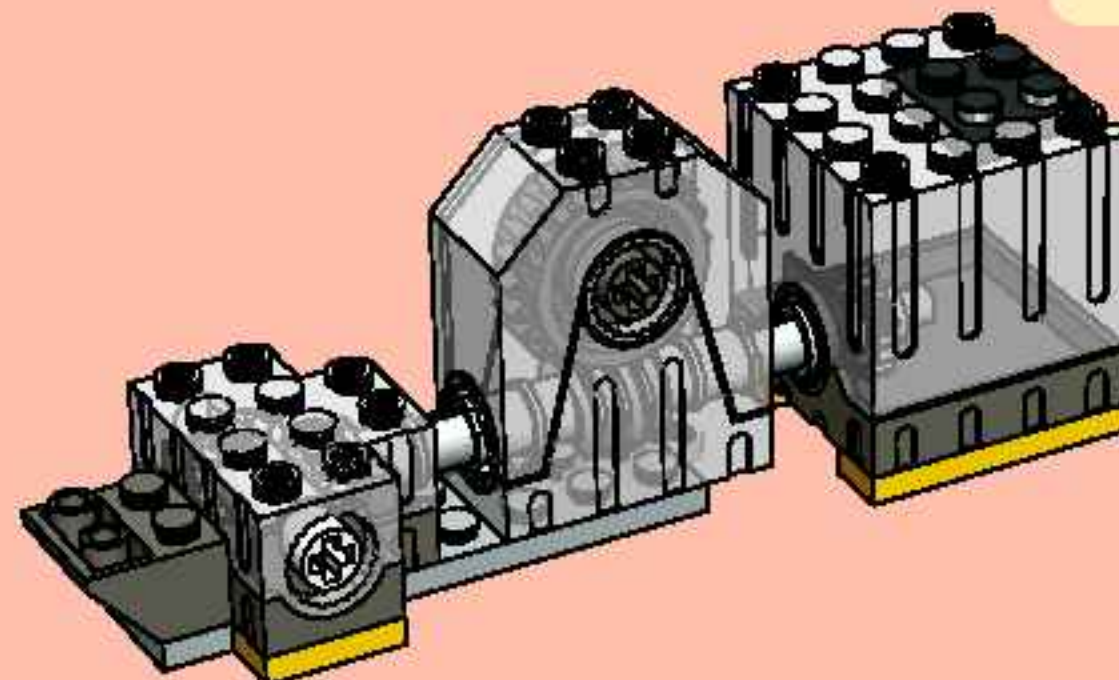
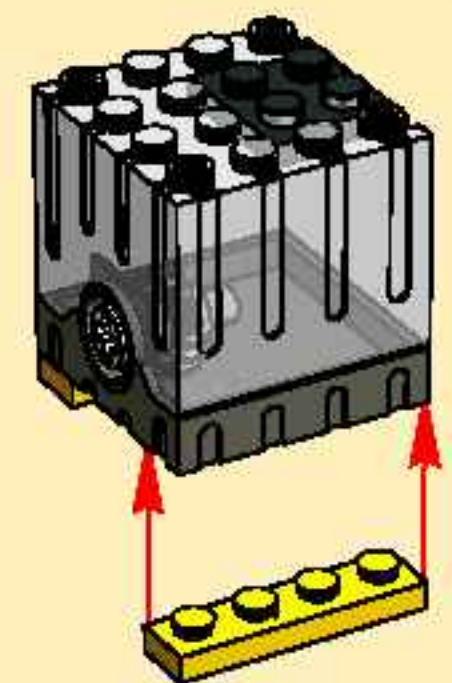



1x

6

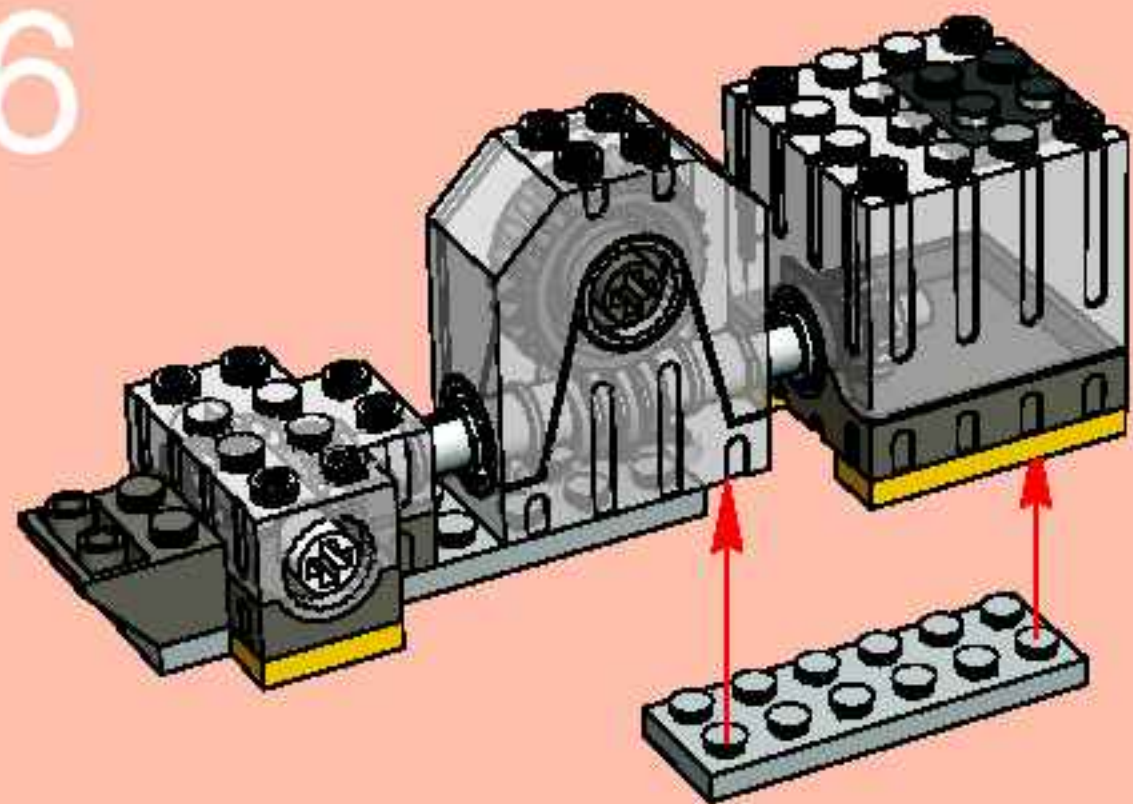

1x



1x

7

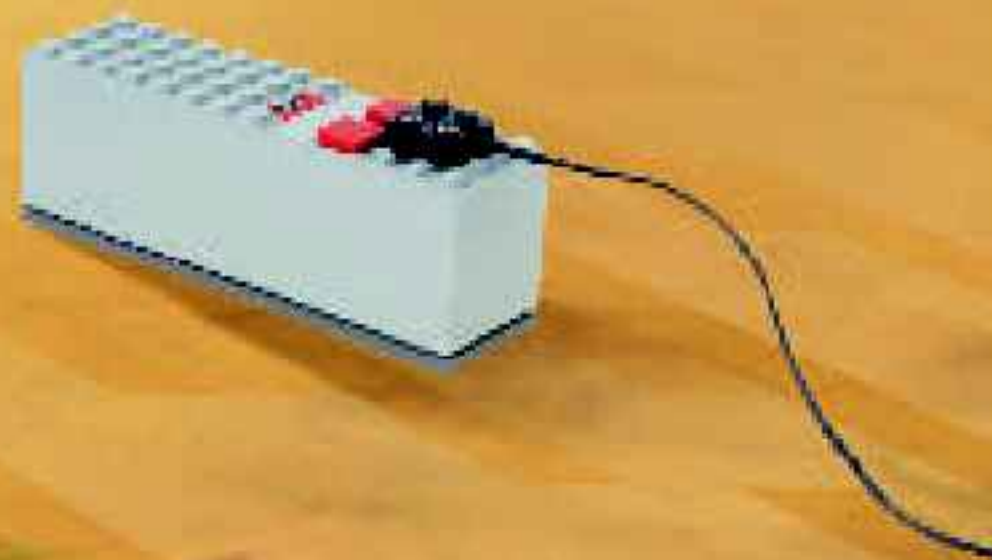
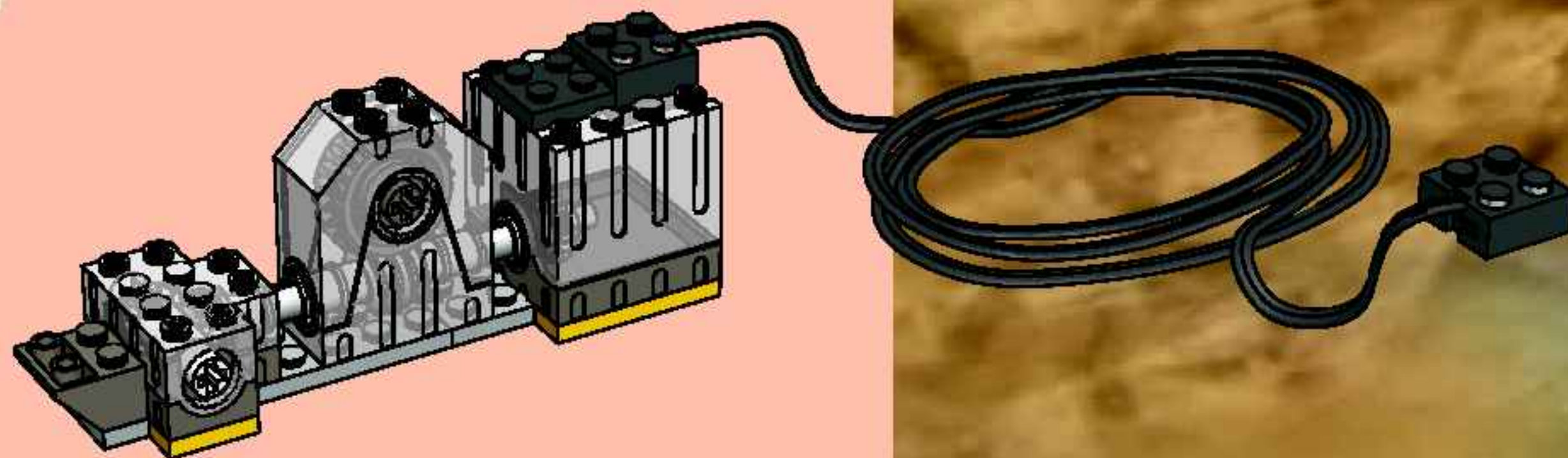

2x



2x

8

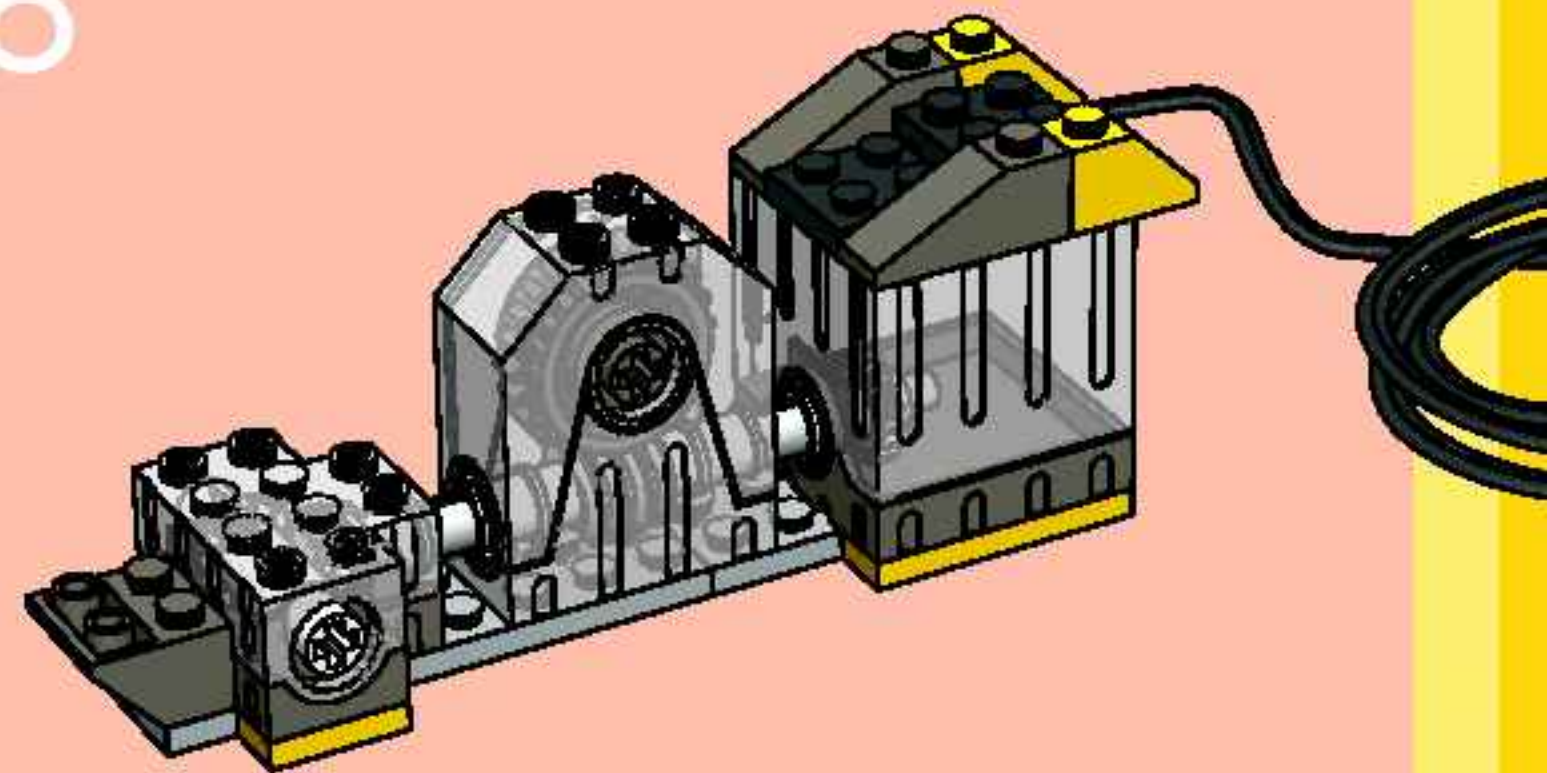

2x



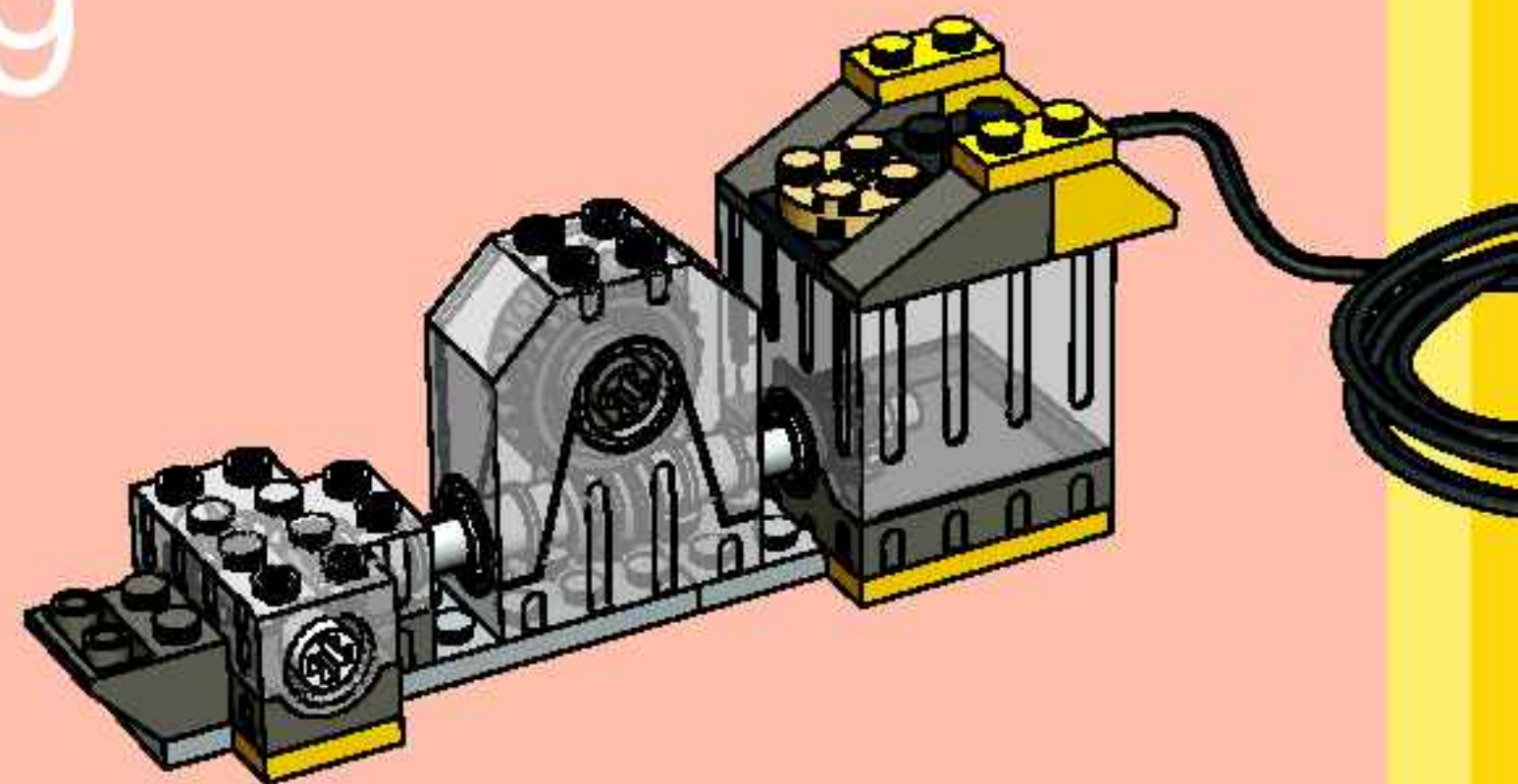

1x

9



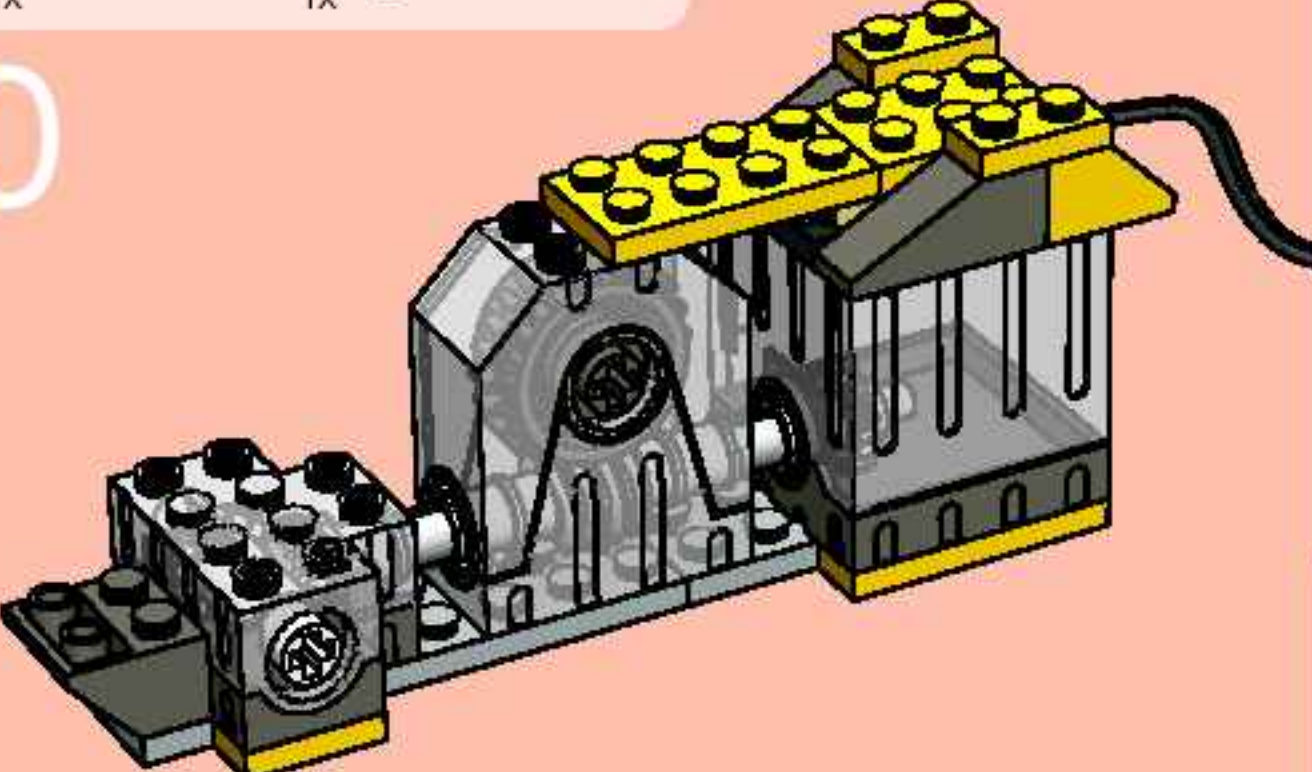

10

1x  1x 



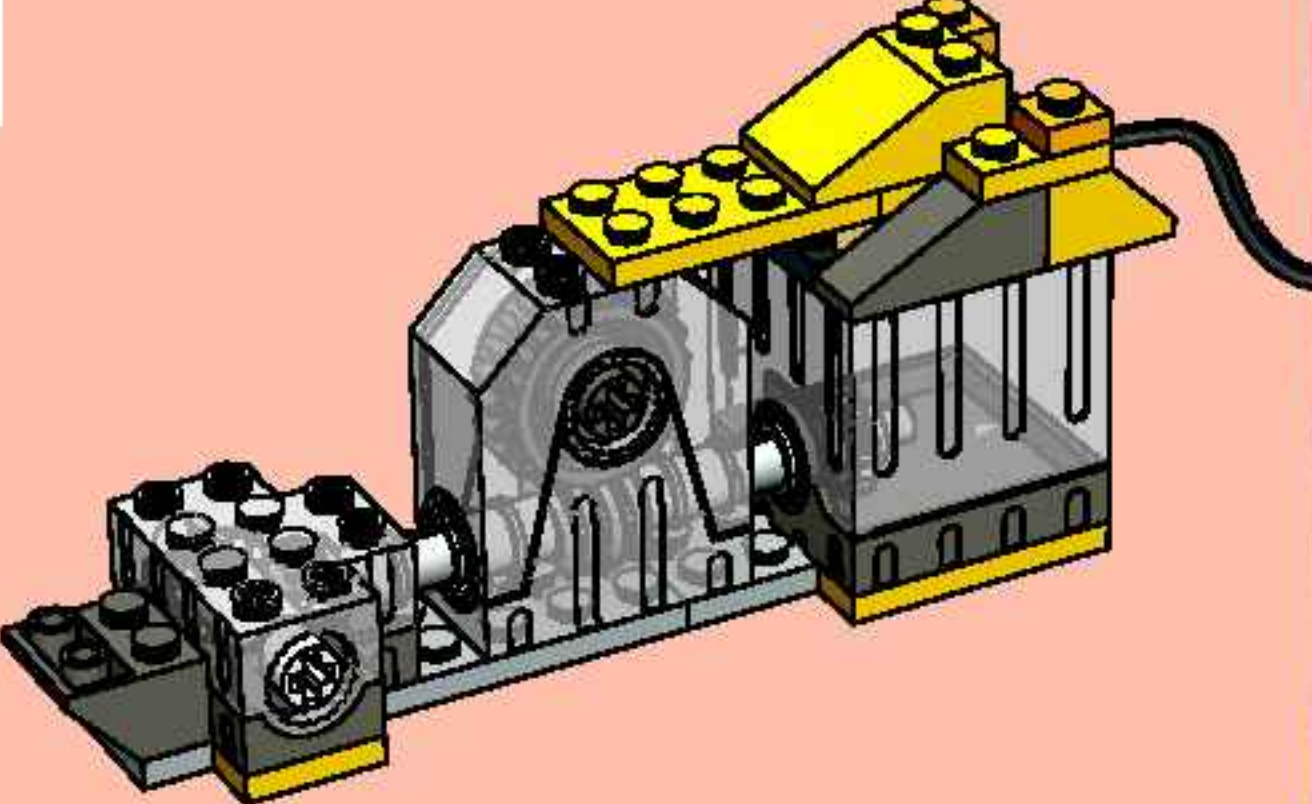

11

2x  1x 





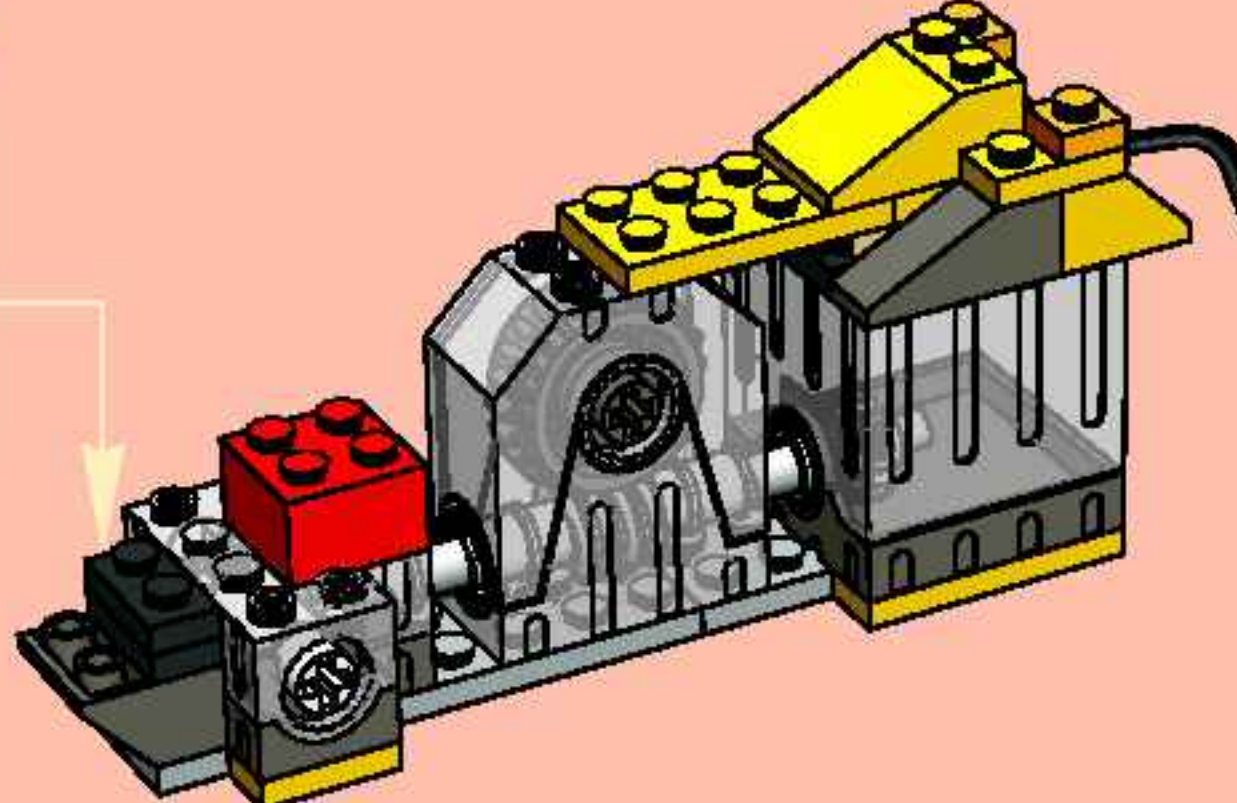

12

2x  1x 



13

2x  2x  1x  2x 

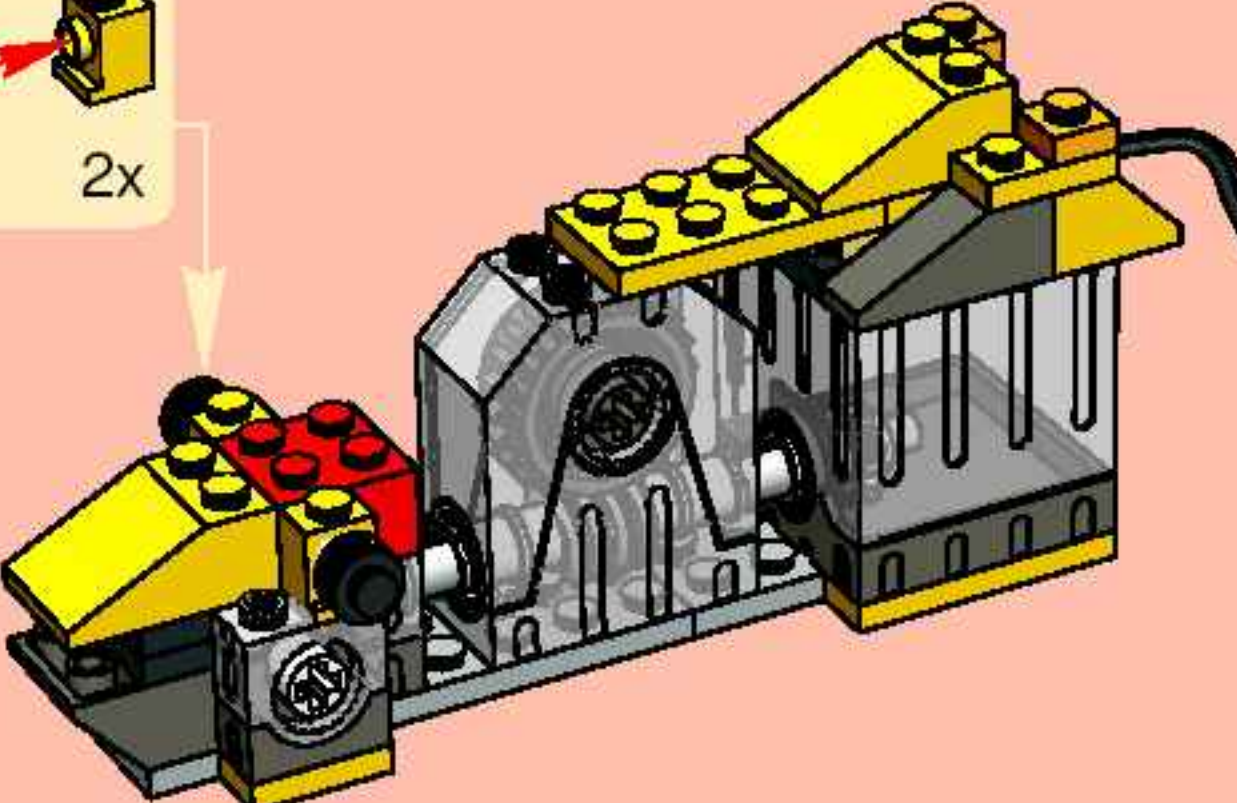
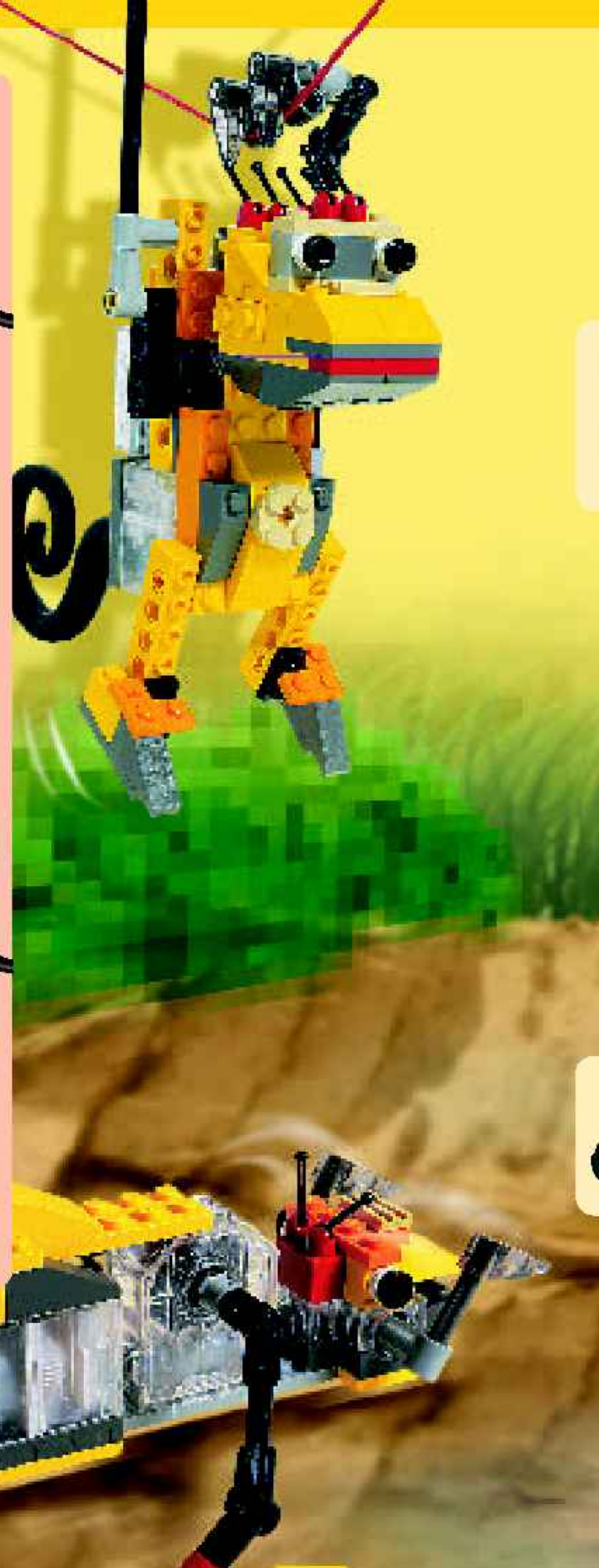

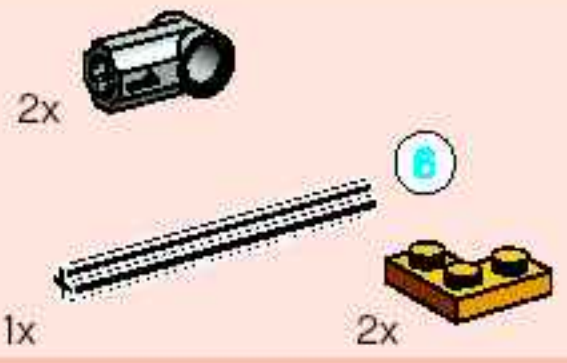

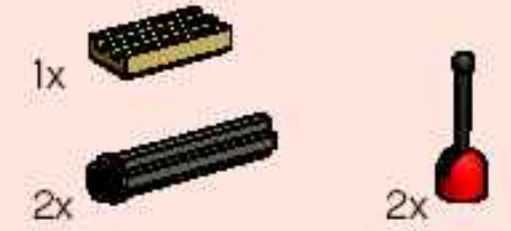
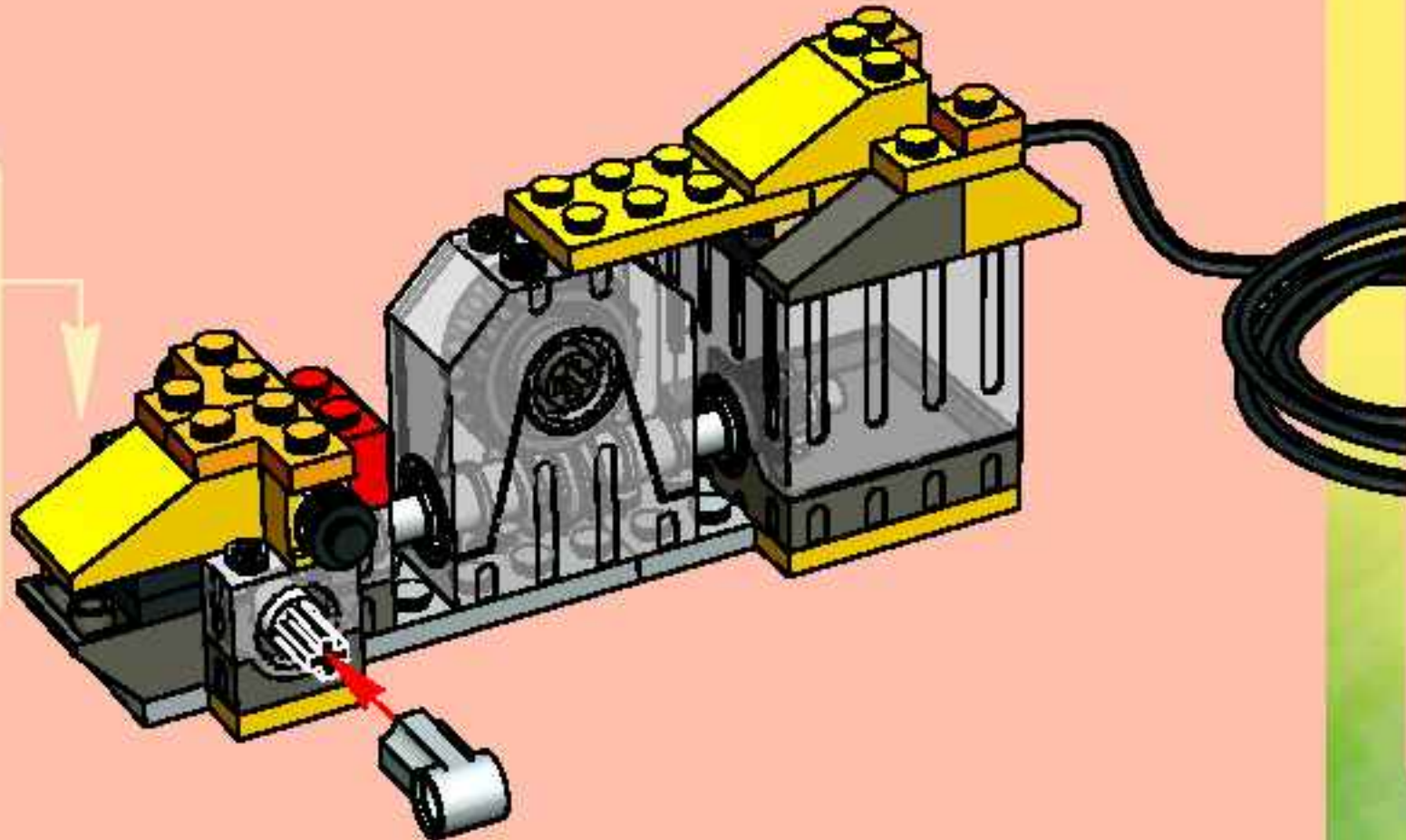

14

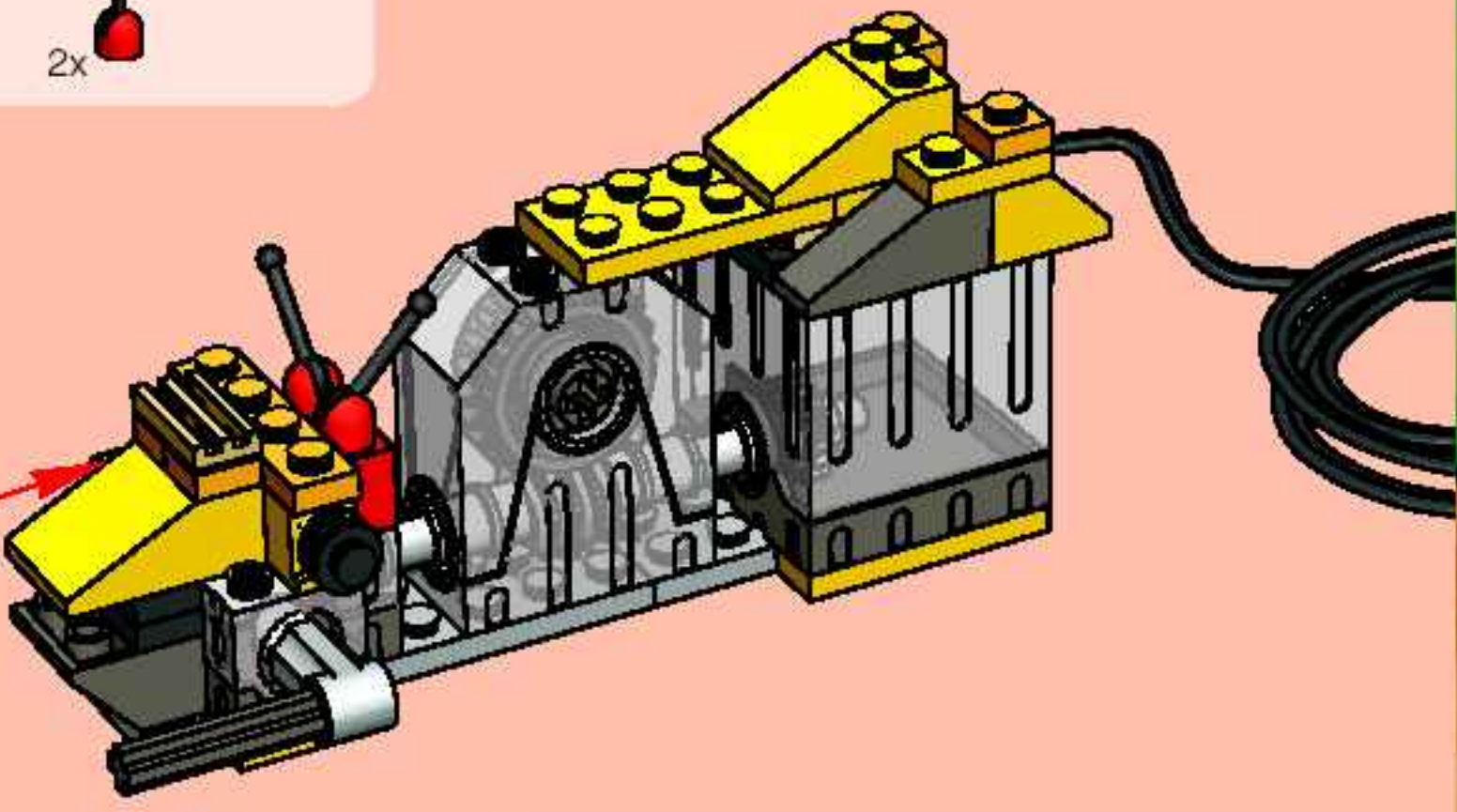

15



16

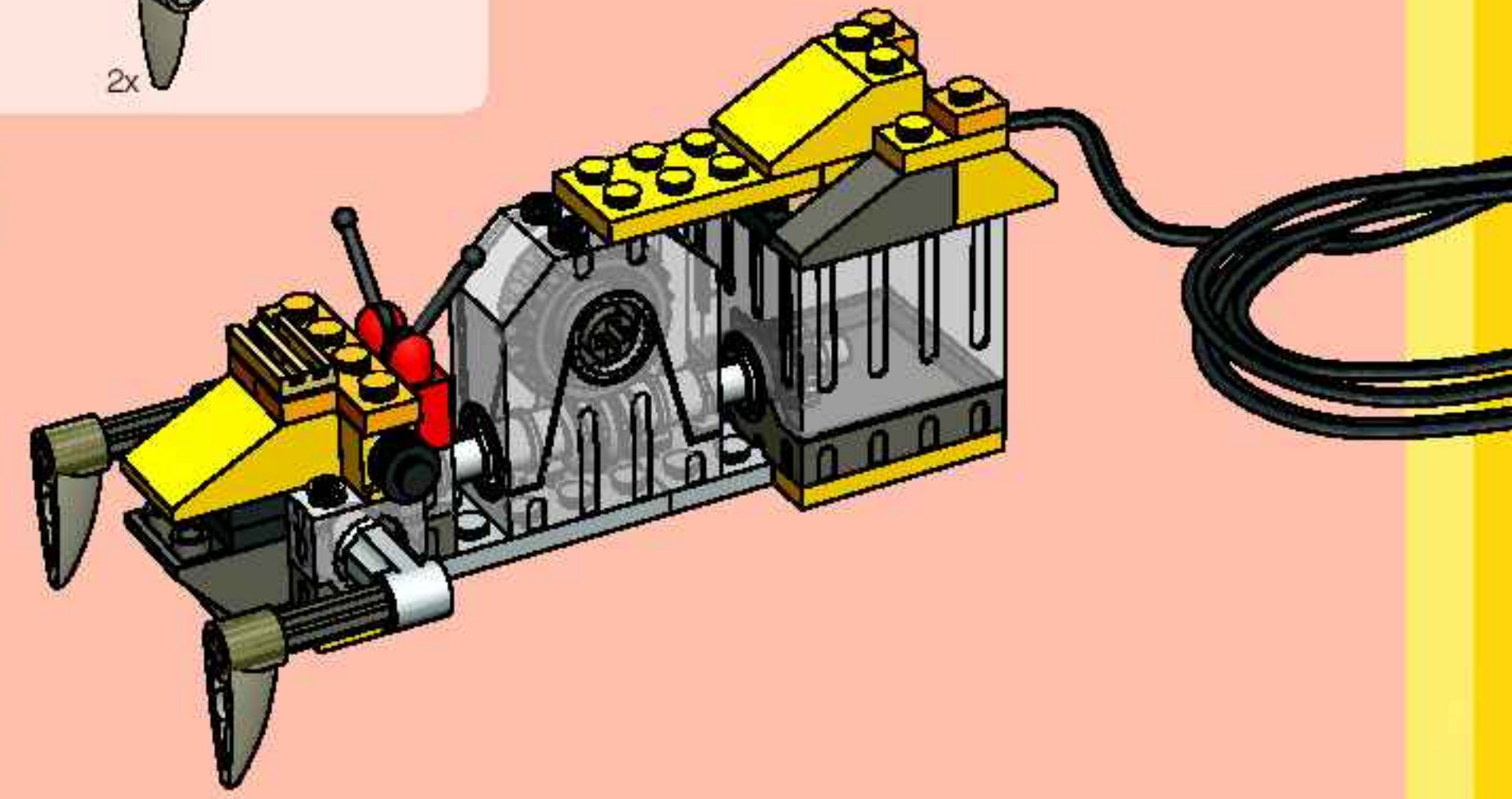

17

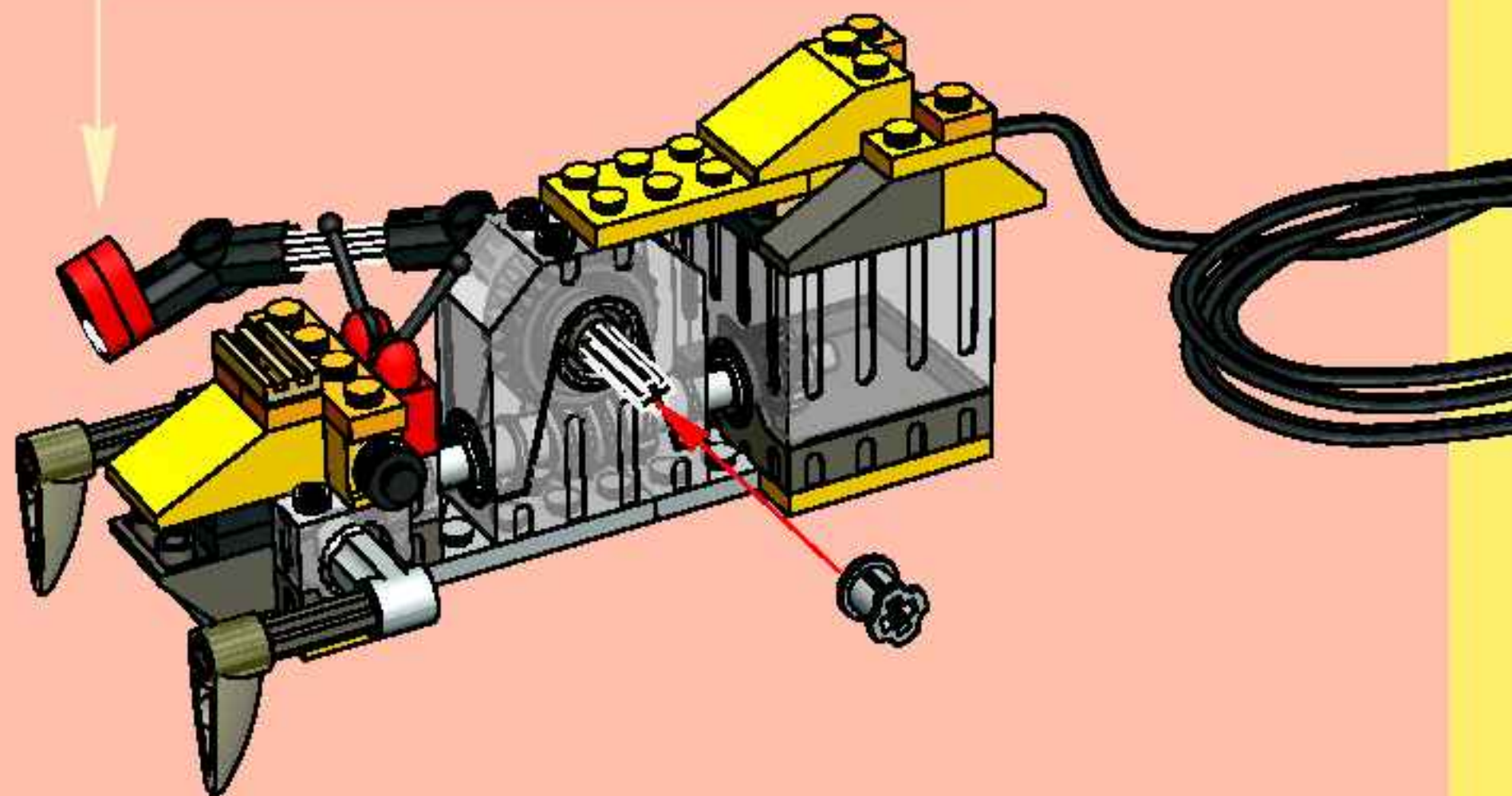
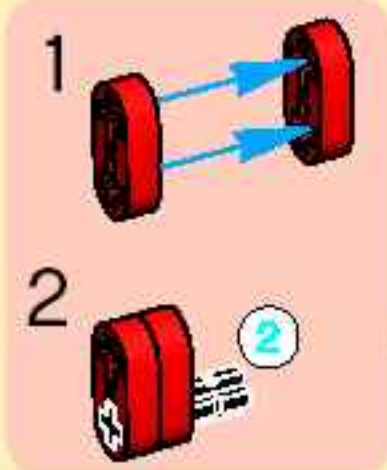
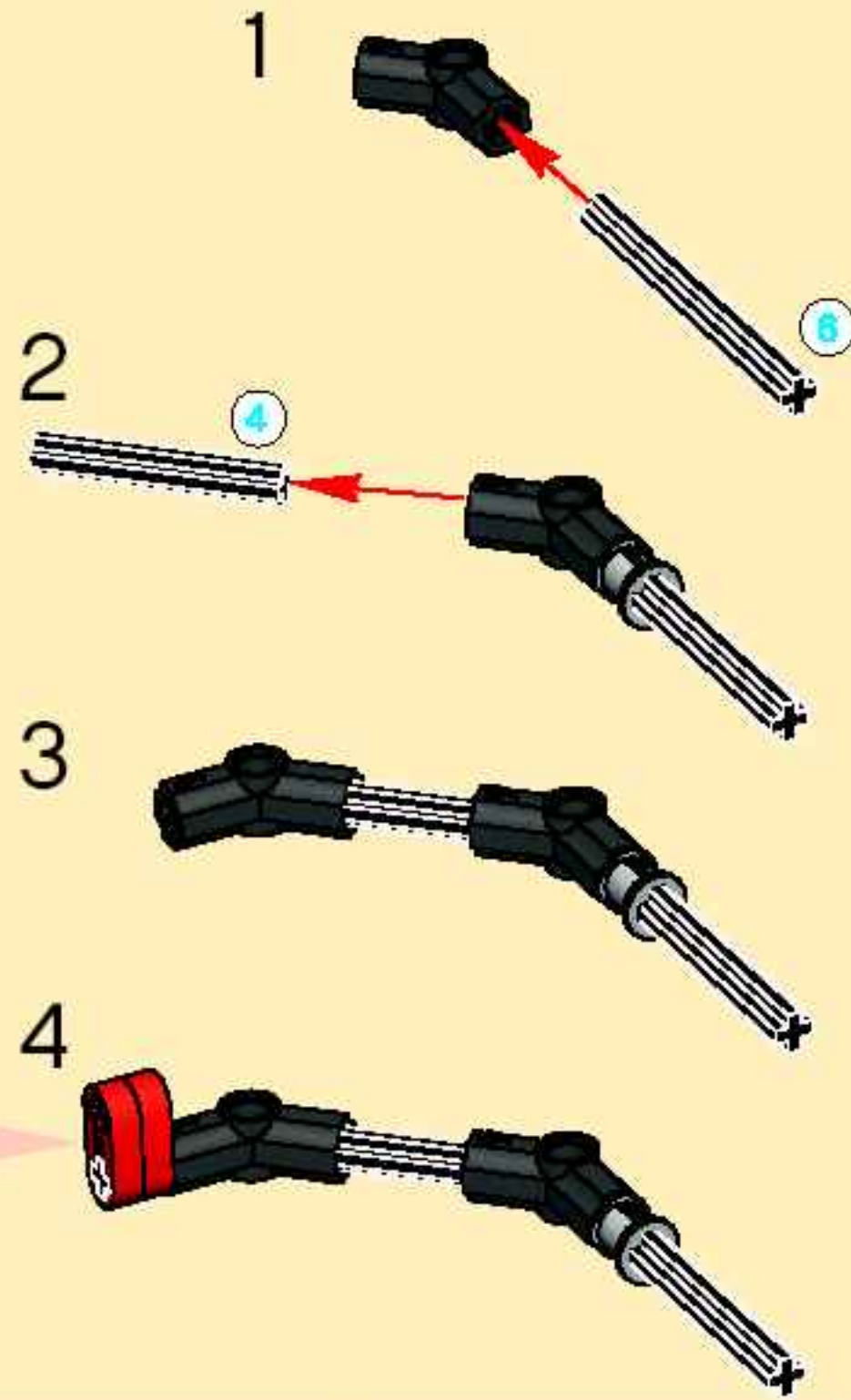
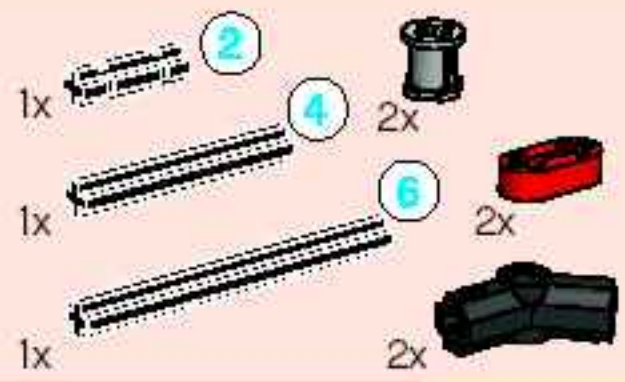

18

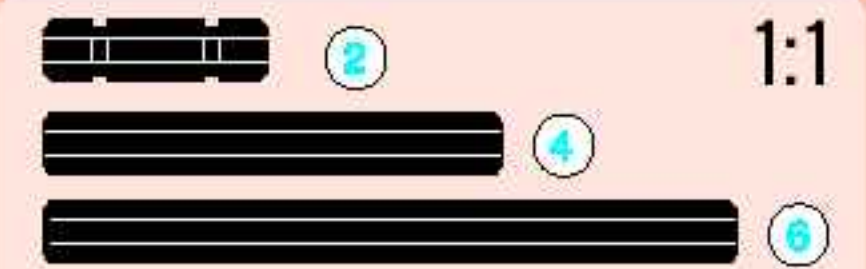
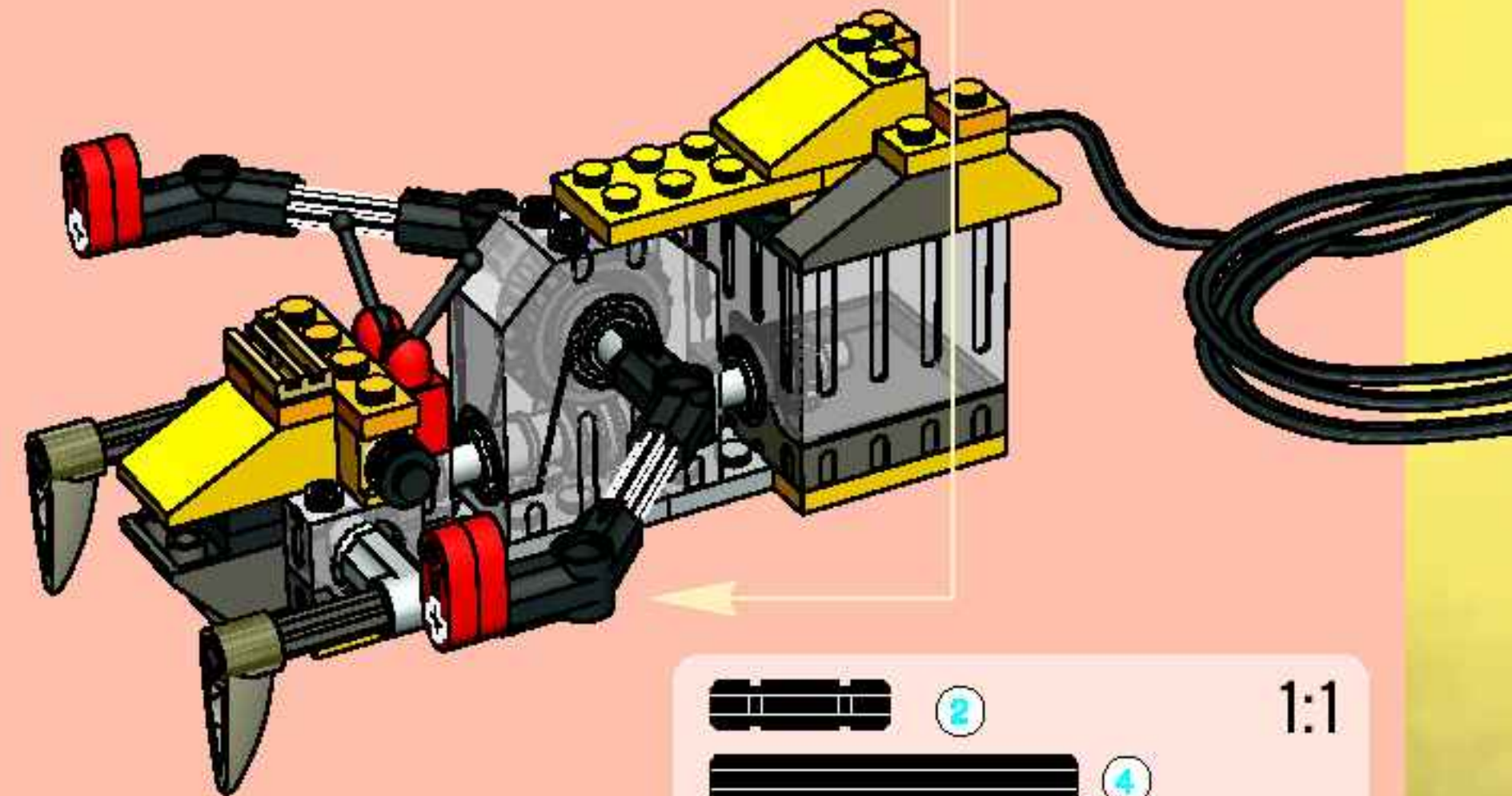
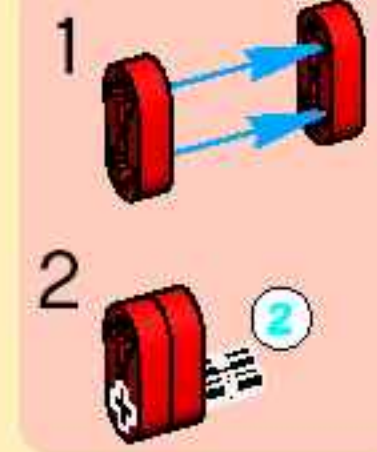
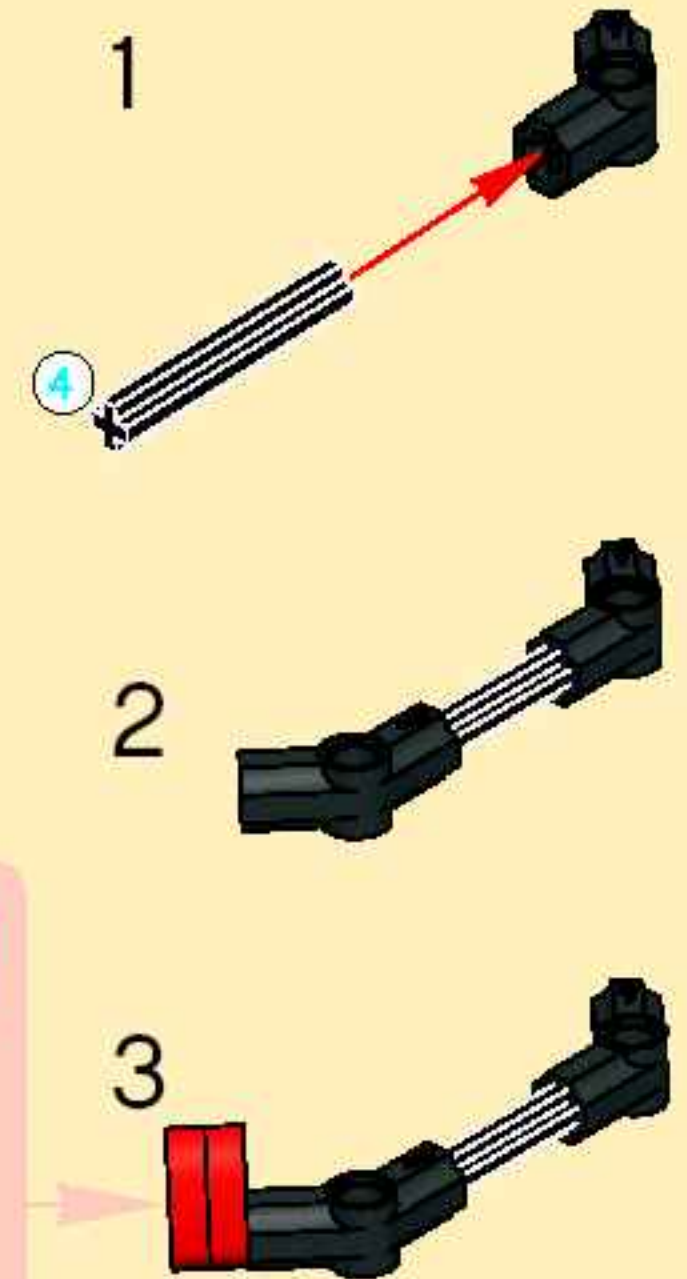



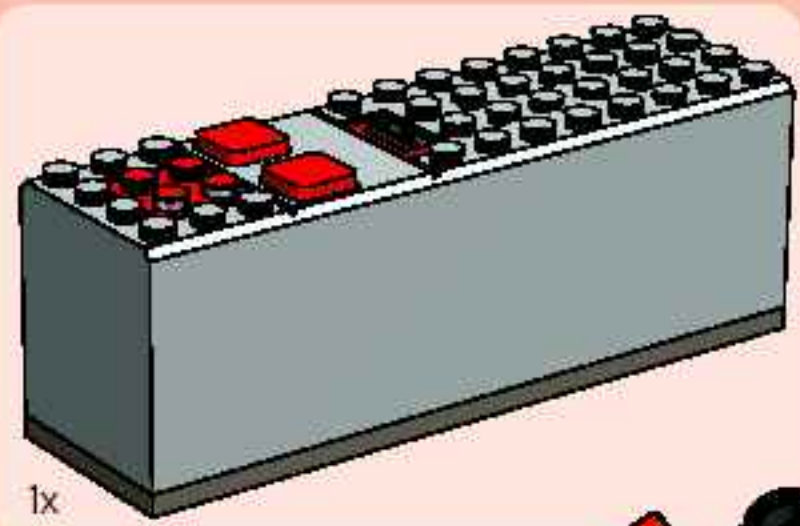

1x

19

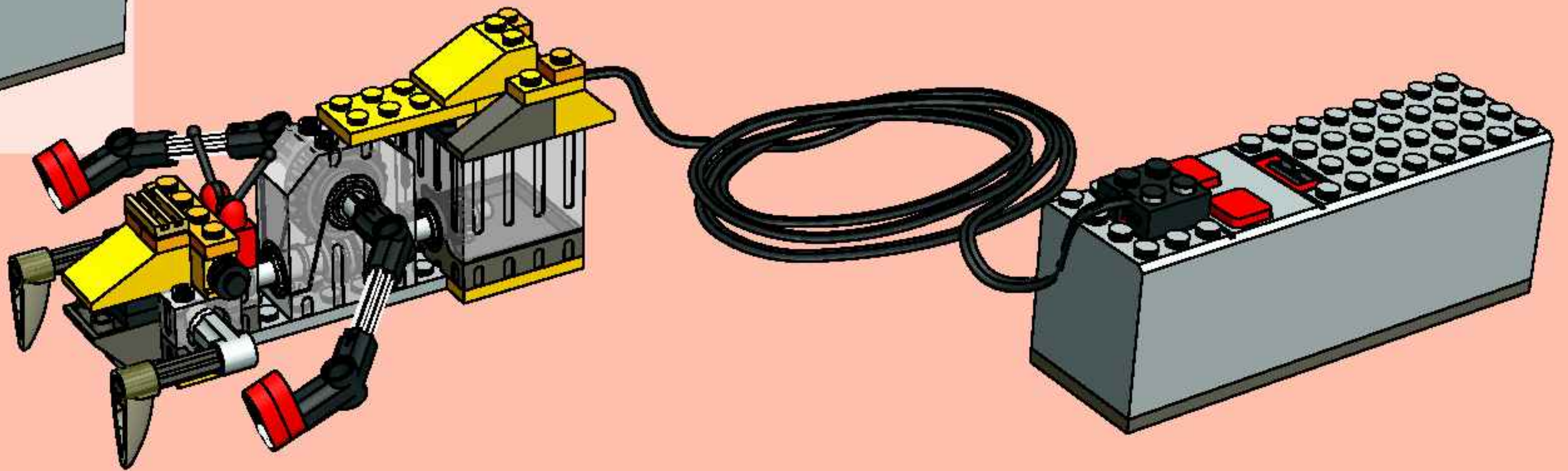

















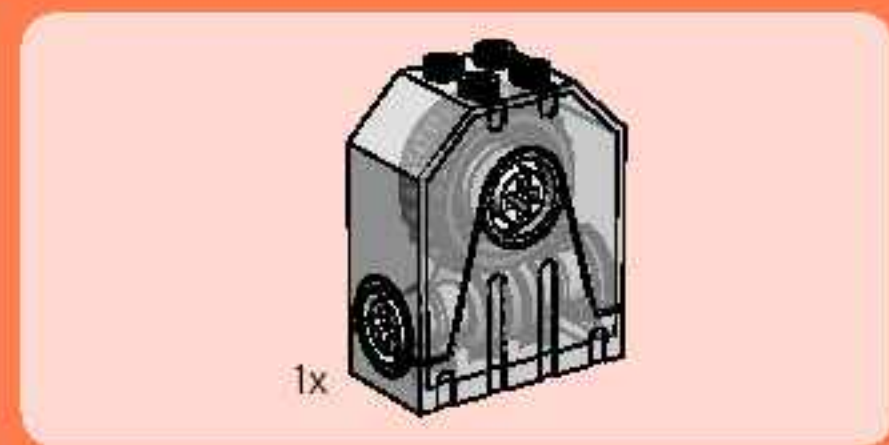
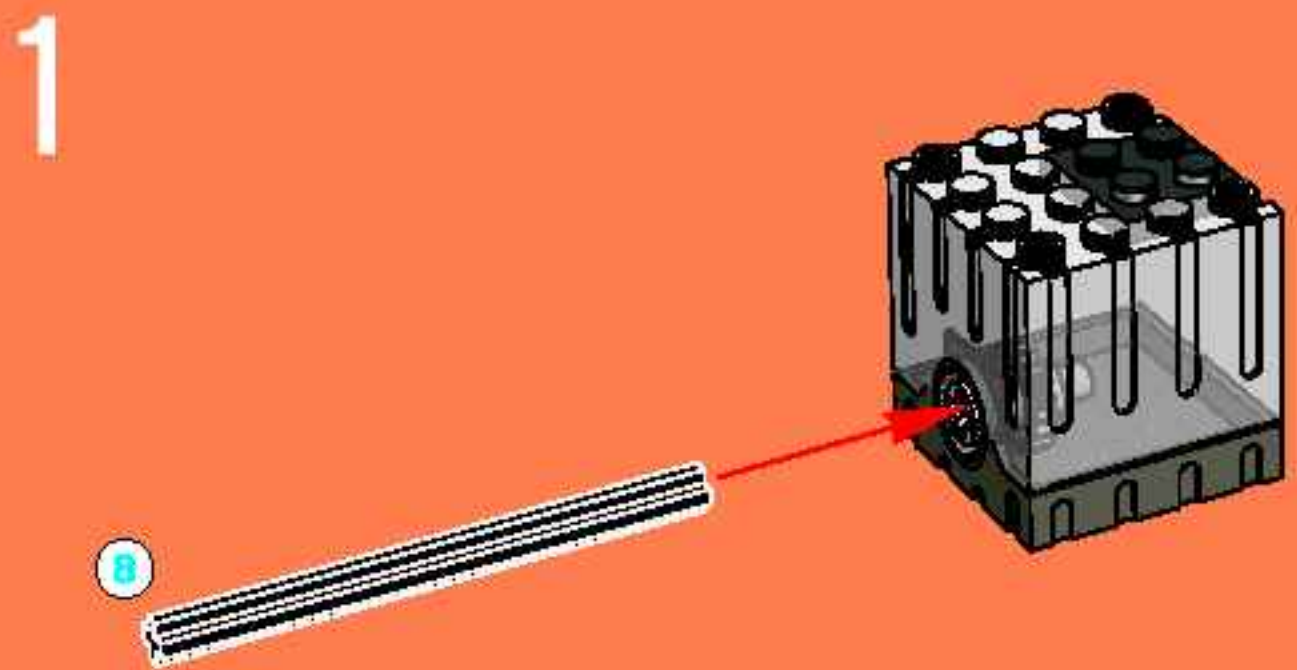
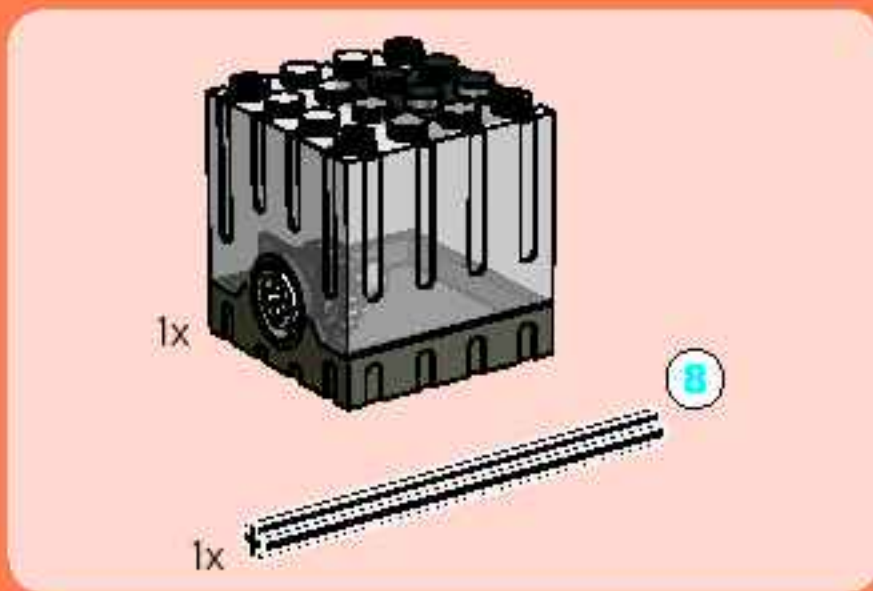

2



3



2x 

4



1x 

1x 

5

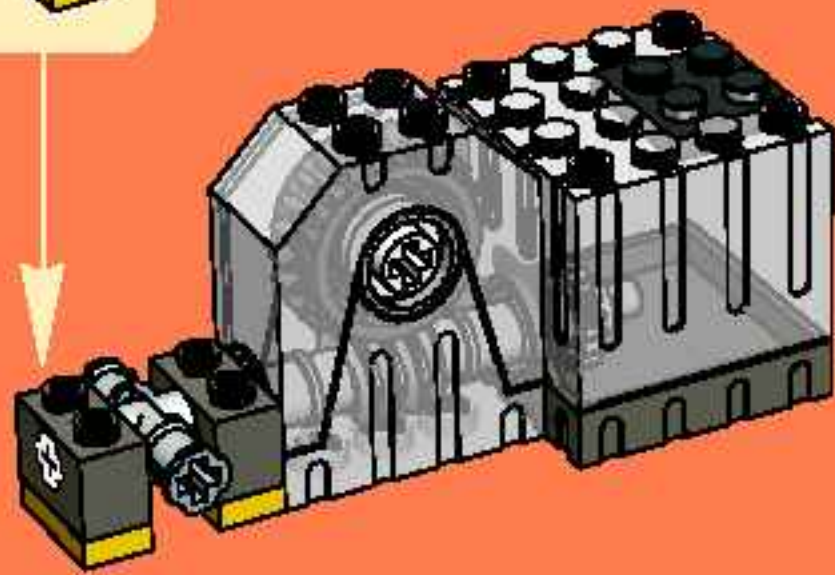

1x 

6

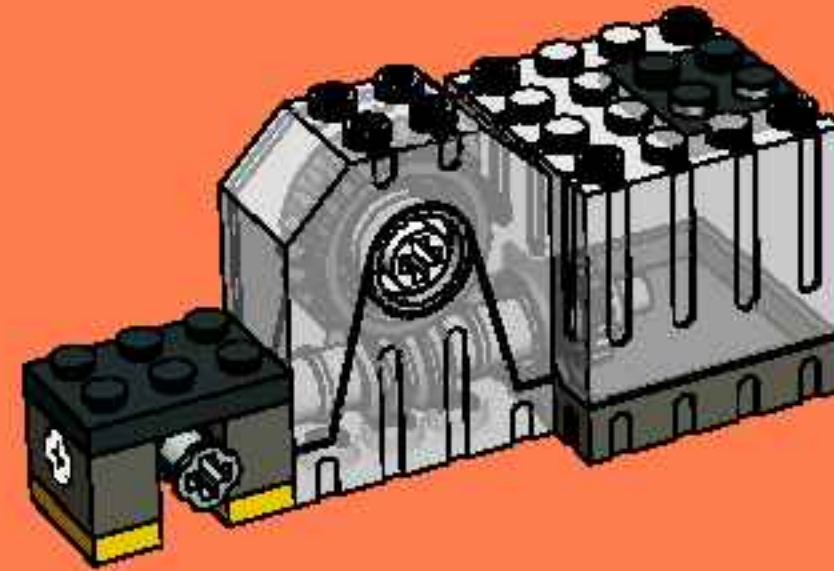

1x 

1x 

7

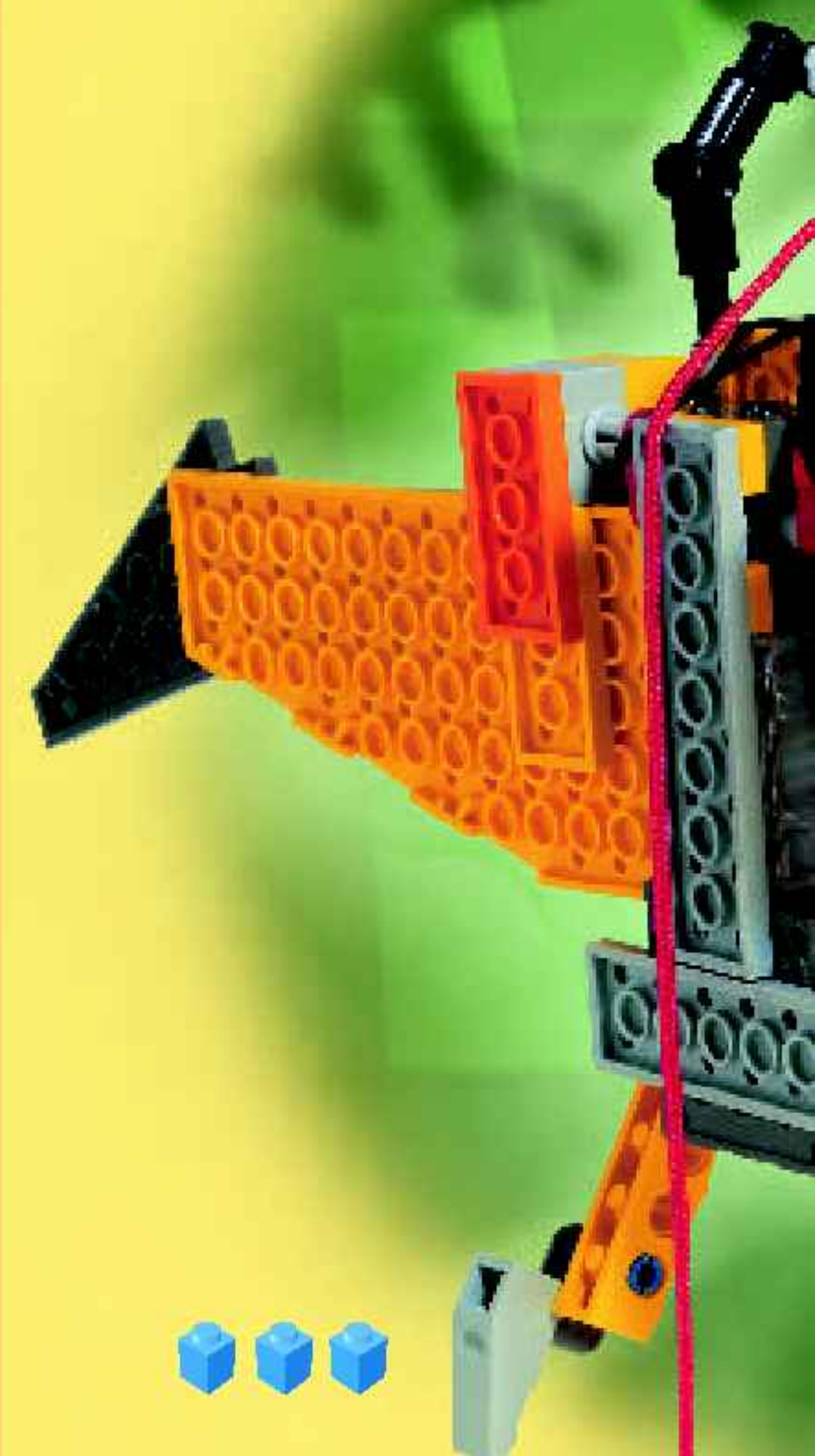
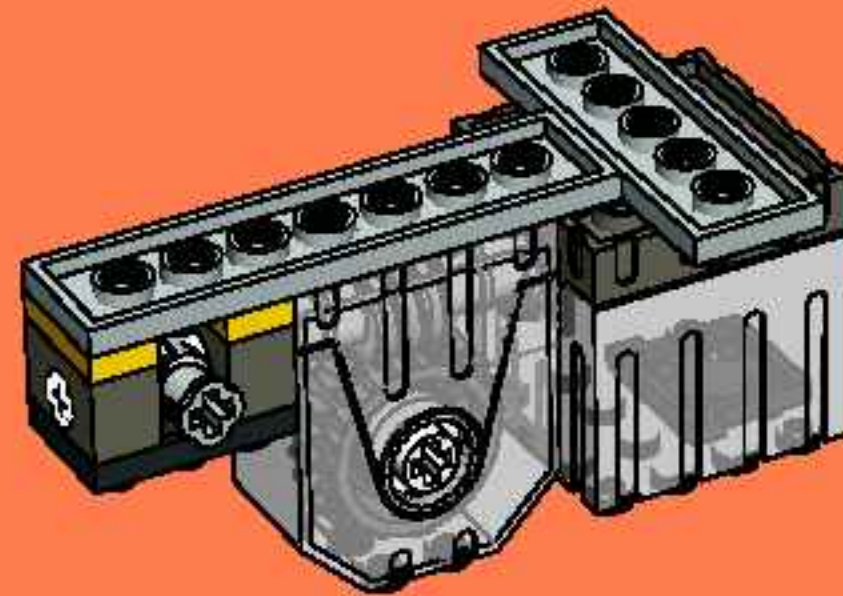



- 2x
- 2x
- 4x
- 2x

# 8

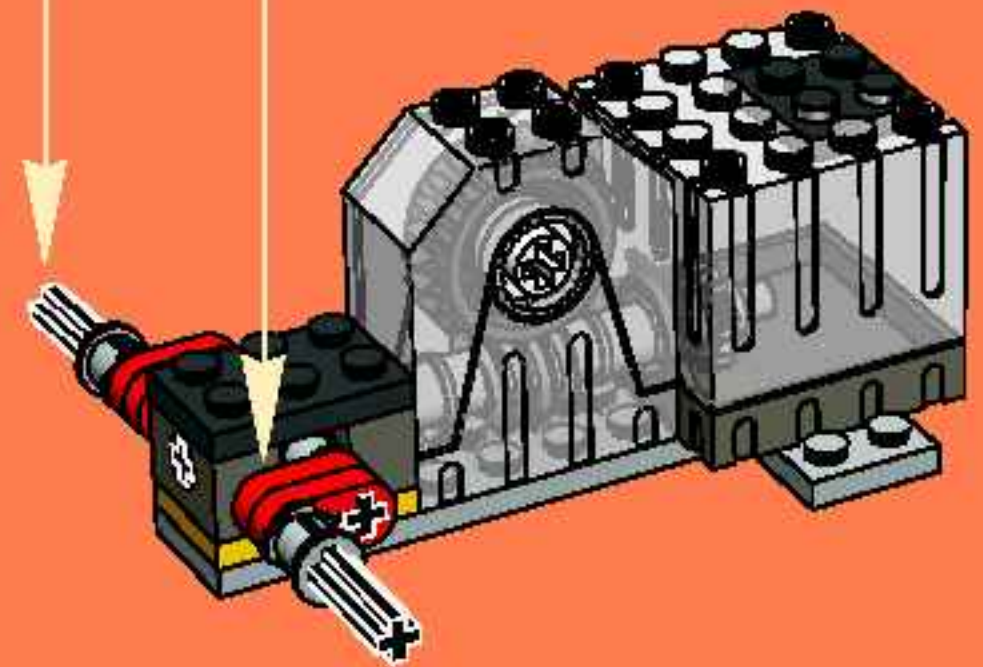
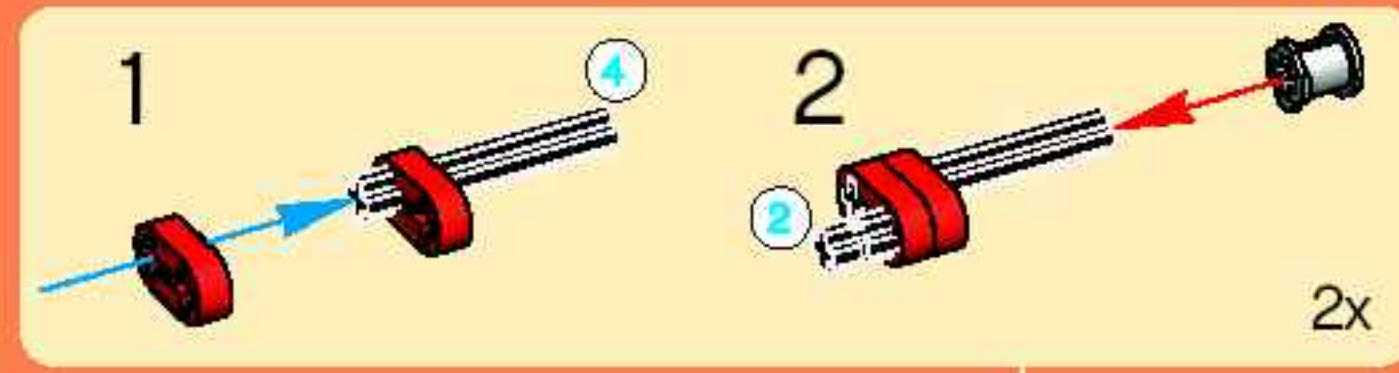

- 2 1:1
- 4

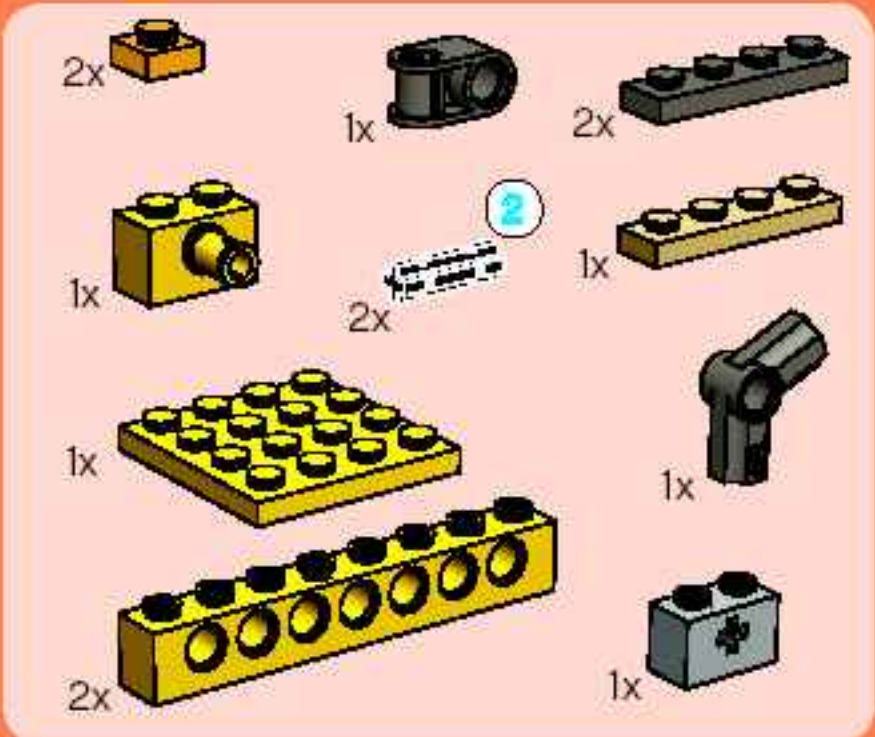

# 9

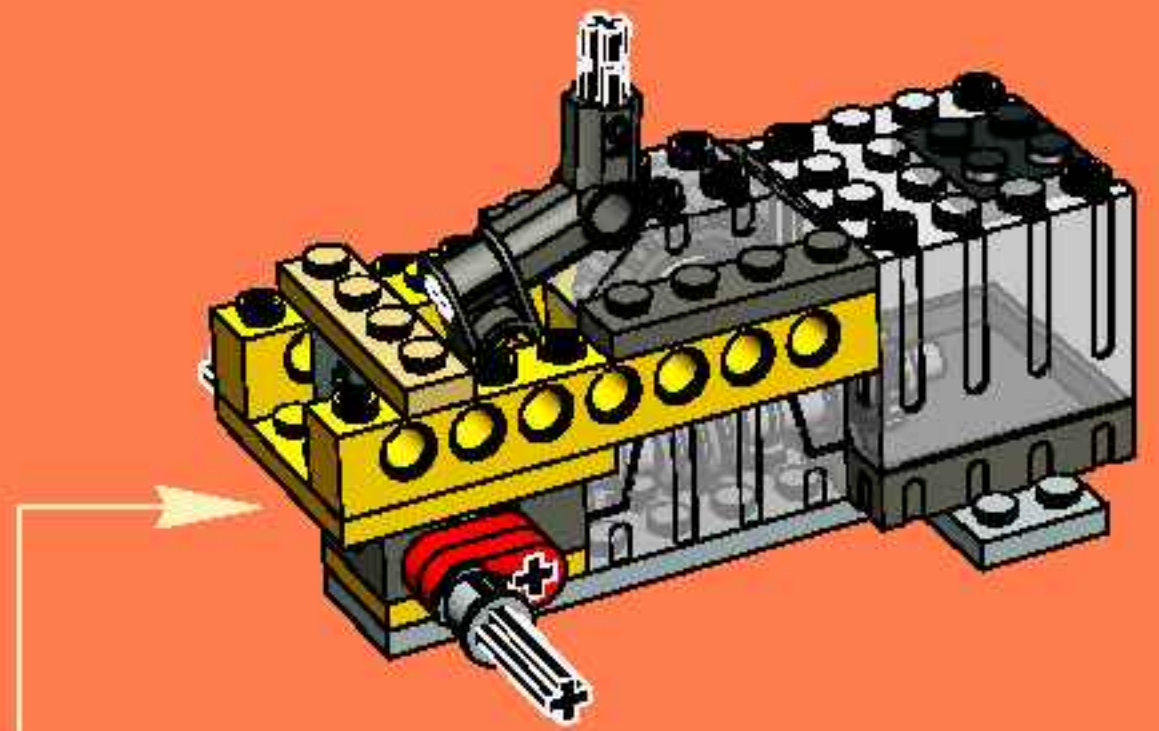
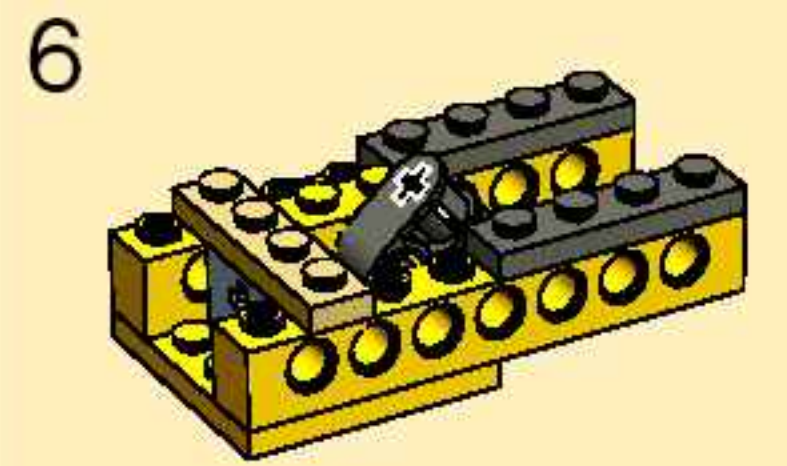
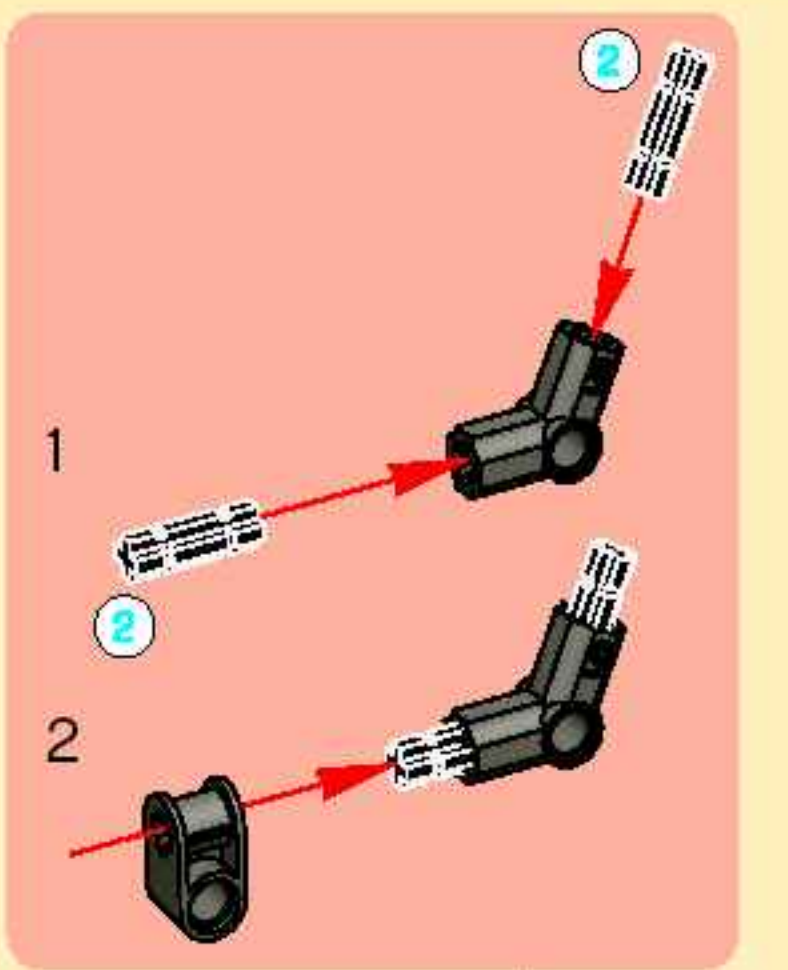
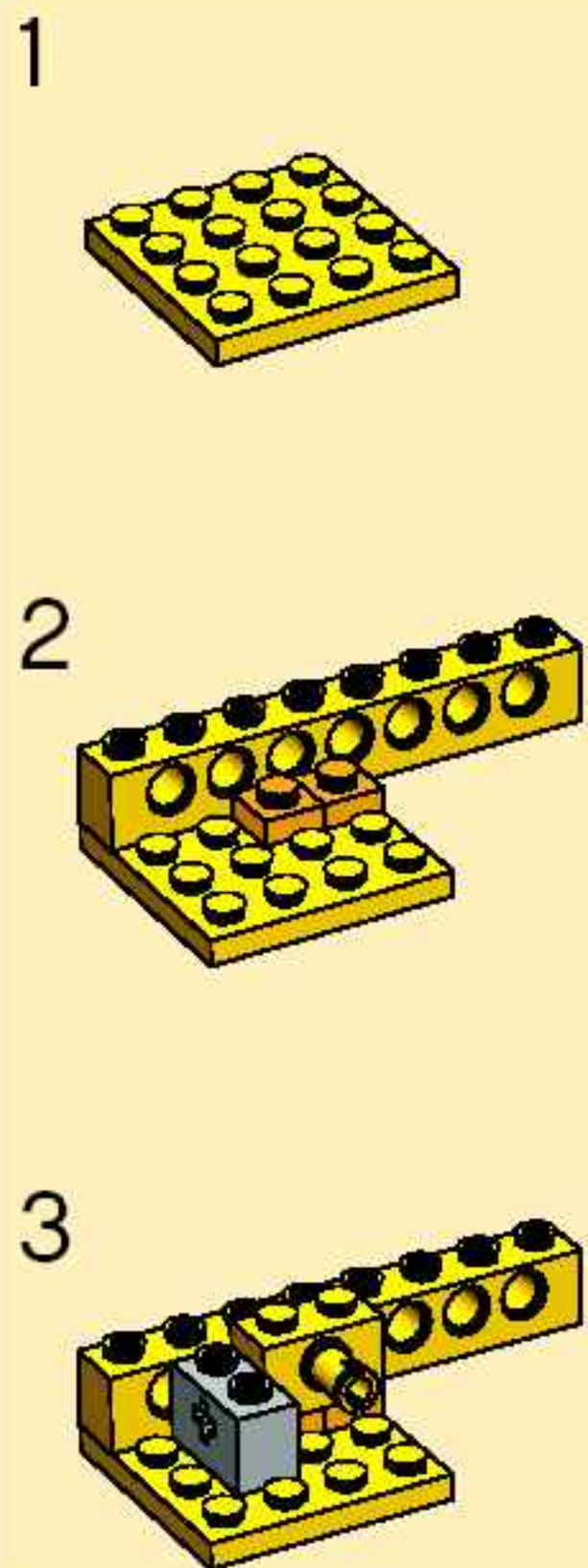

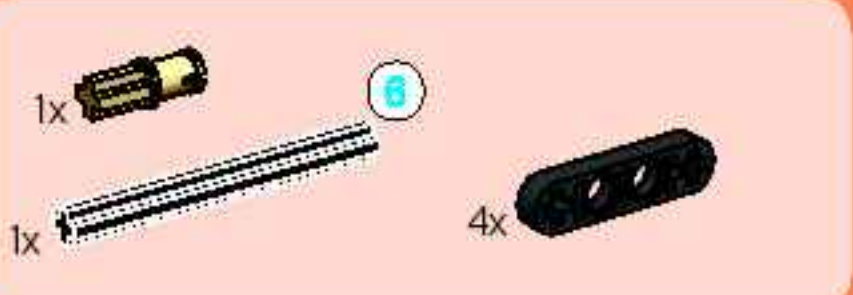

10

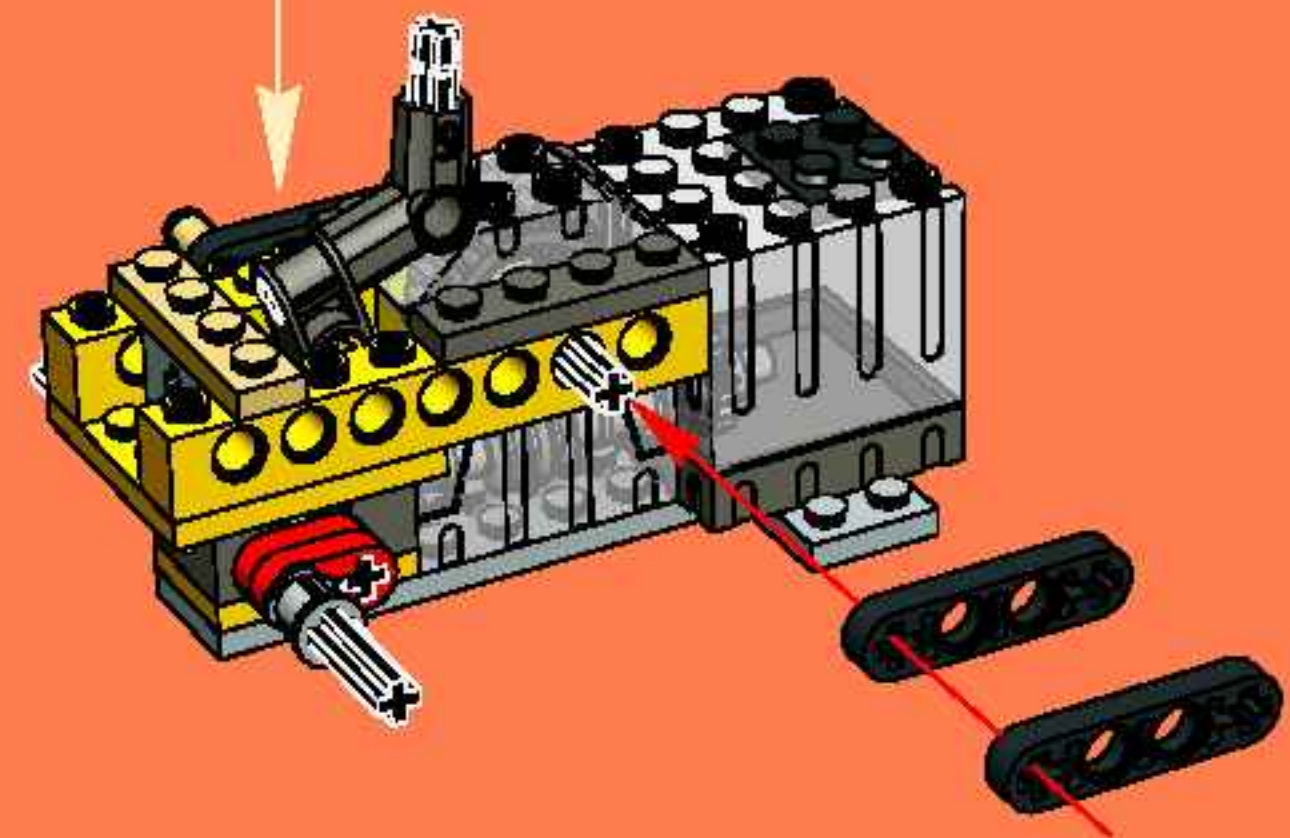
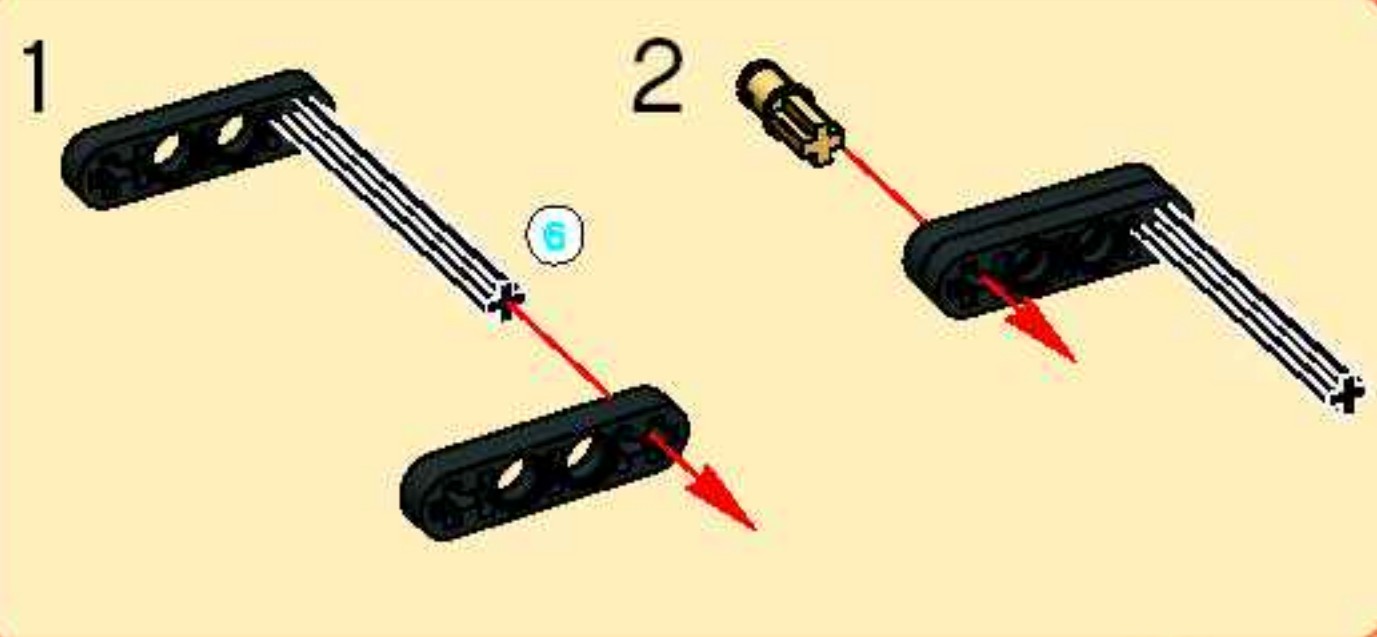

11

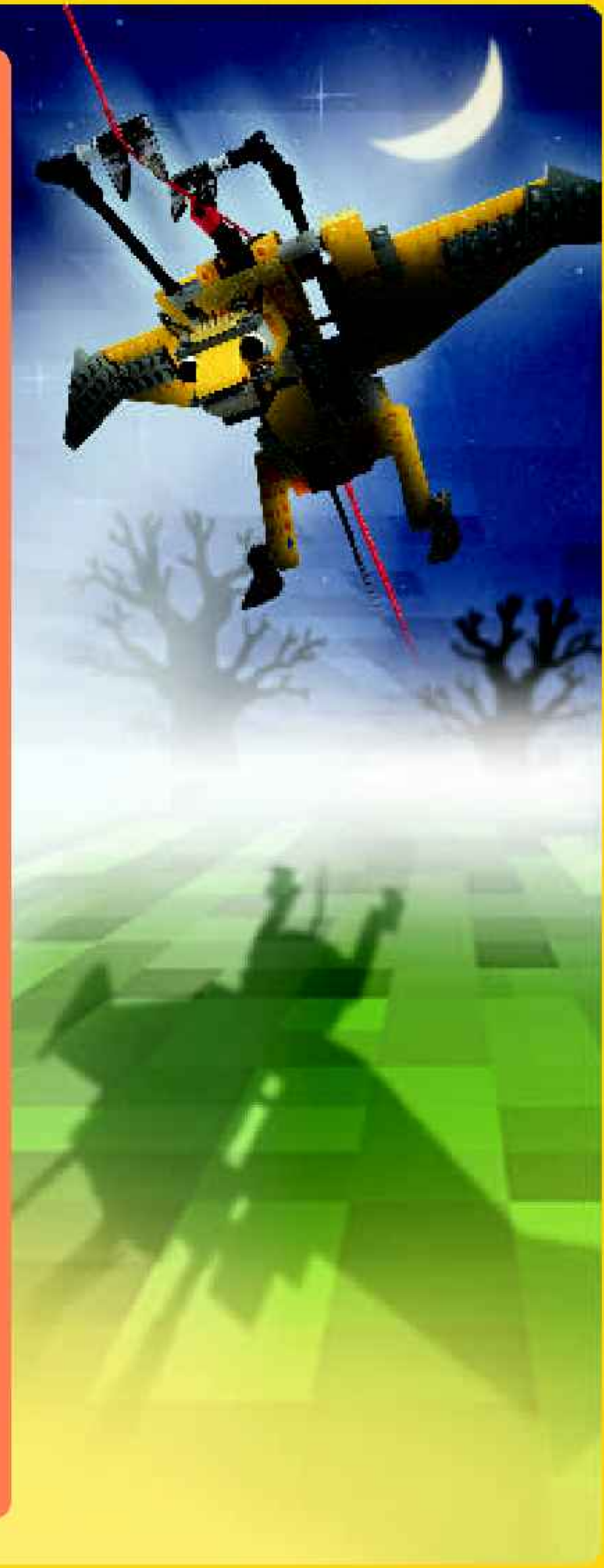
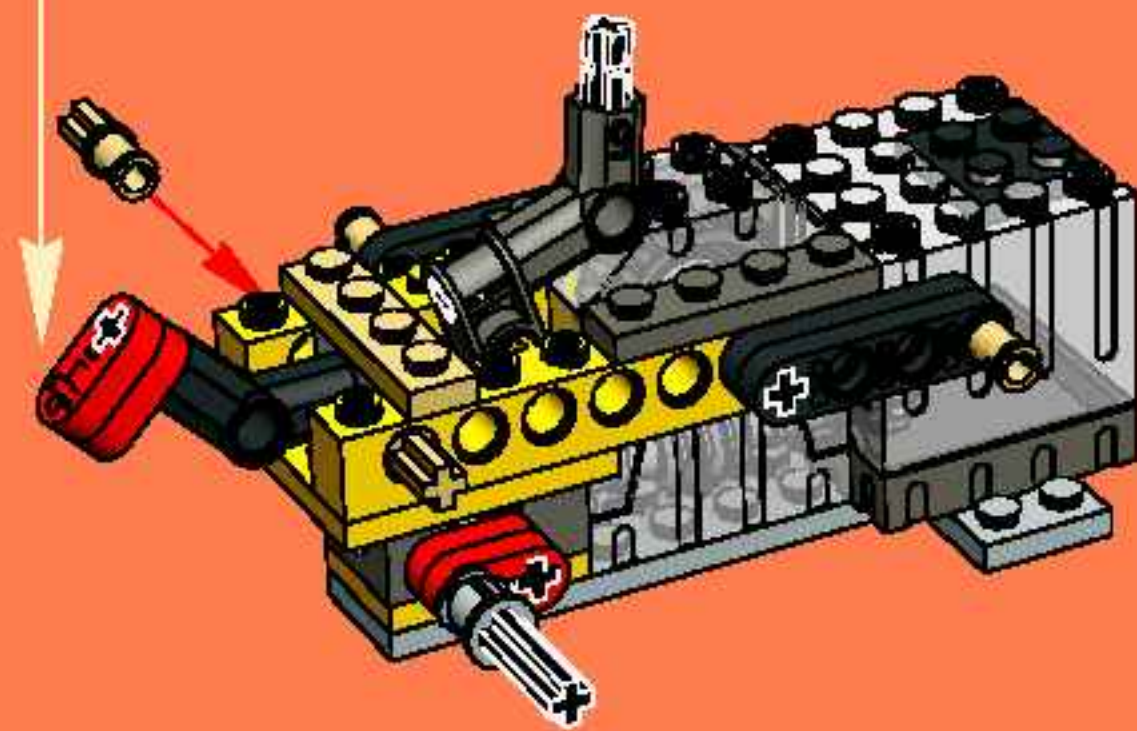
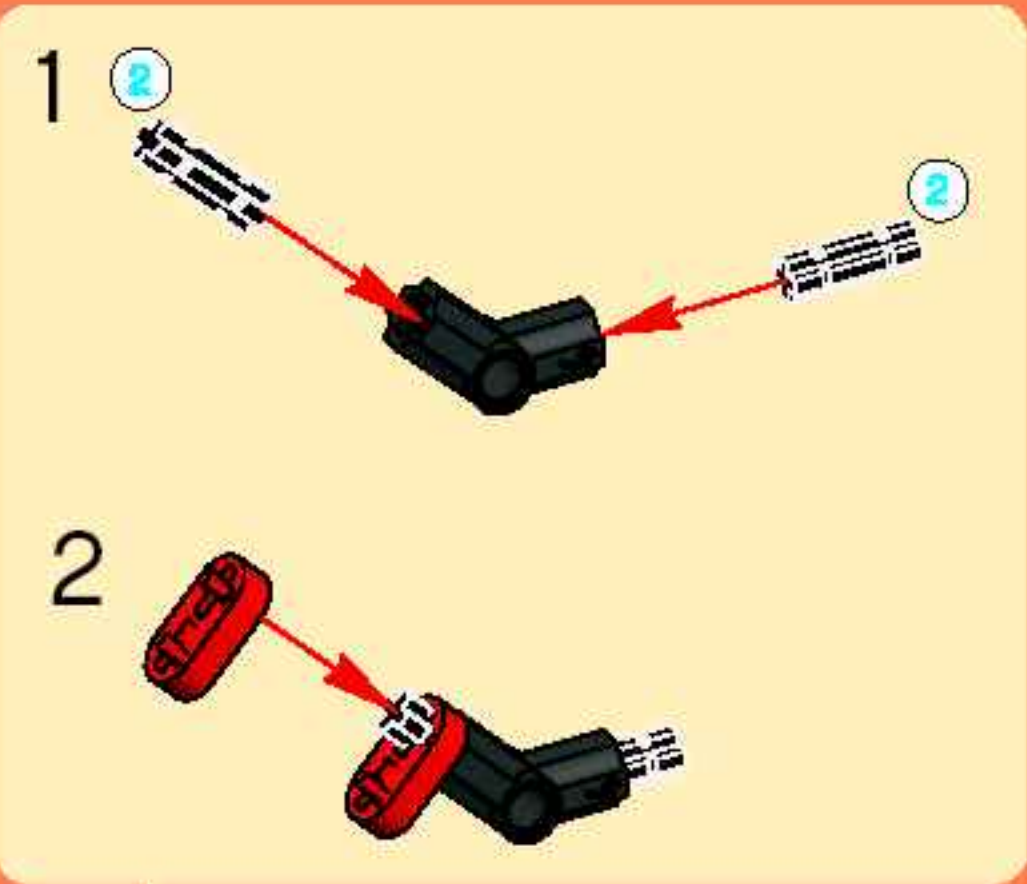



12

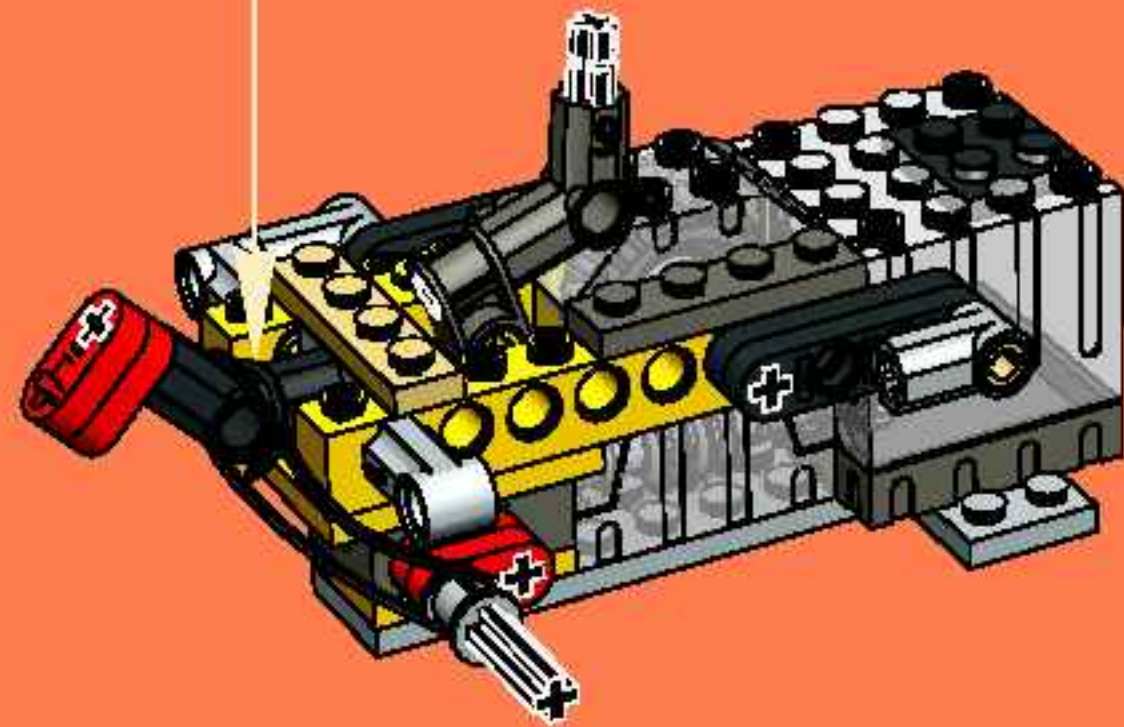
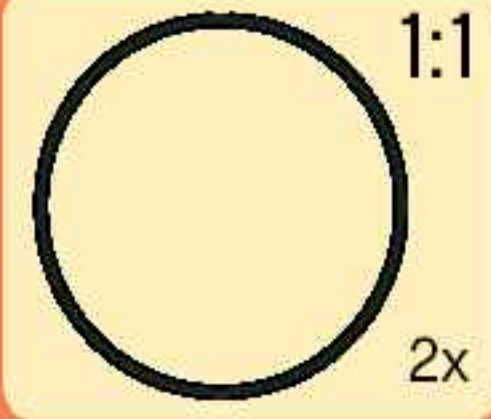

13

1

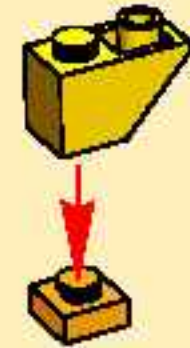

2



1

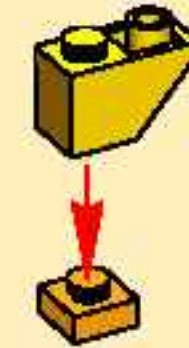

2

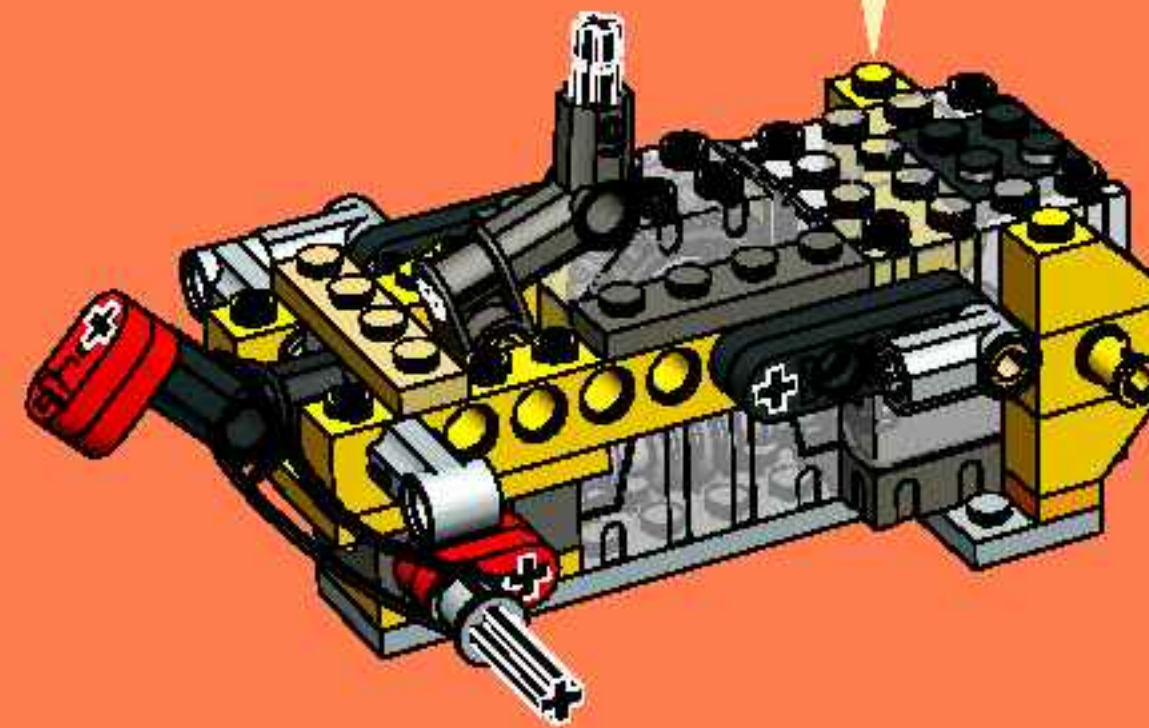

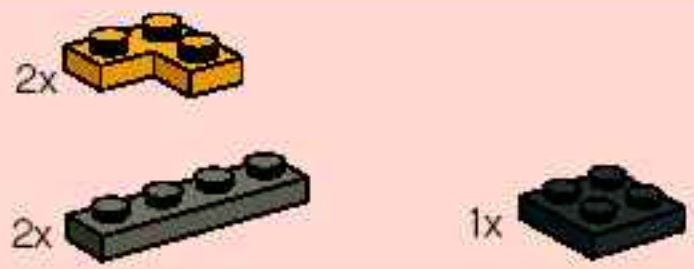

14

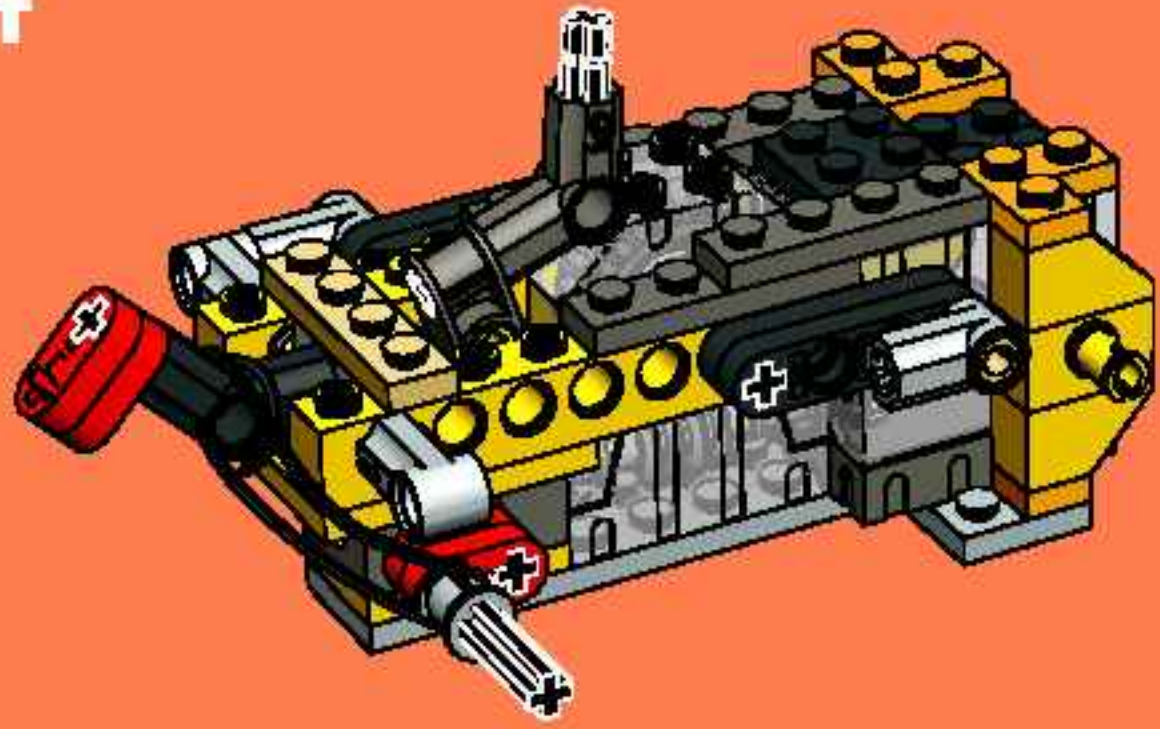

15

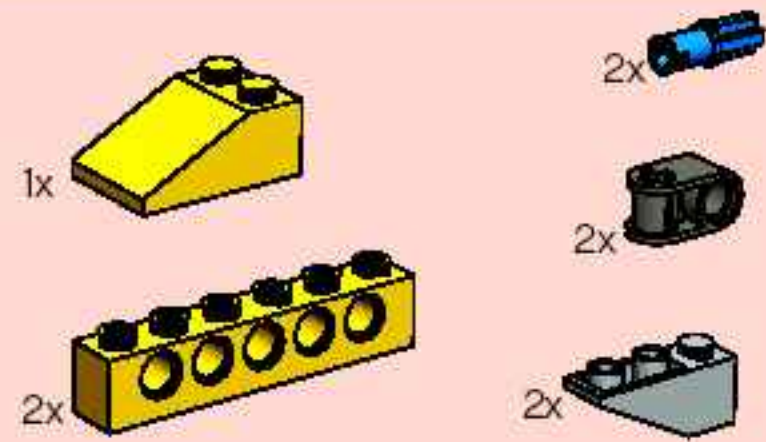
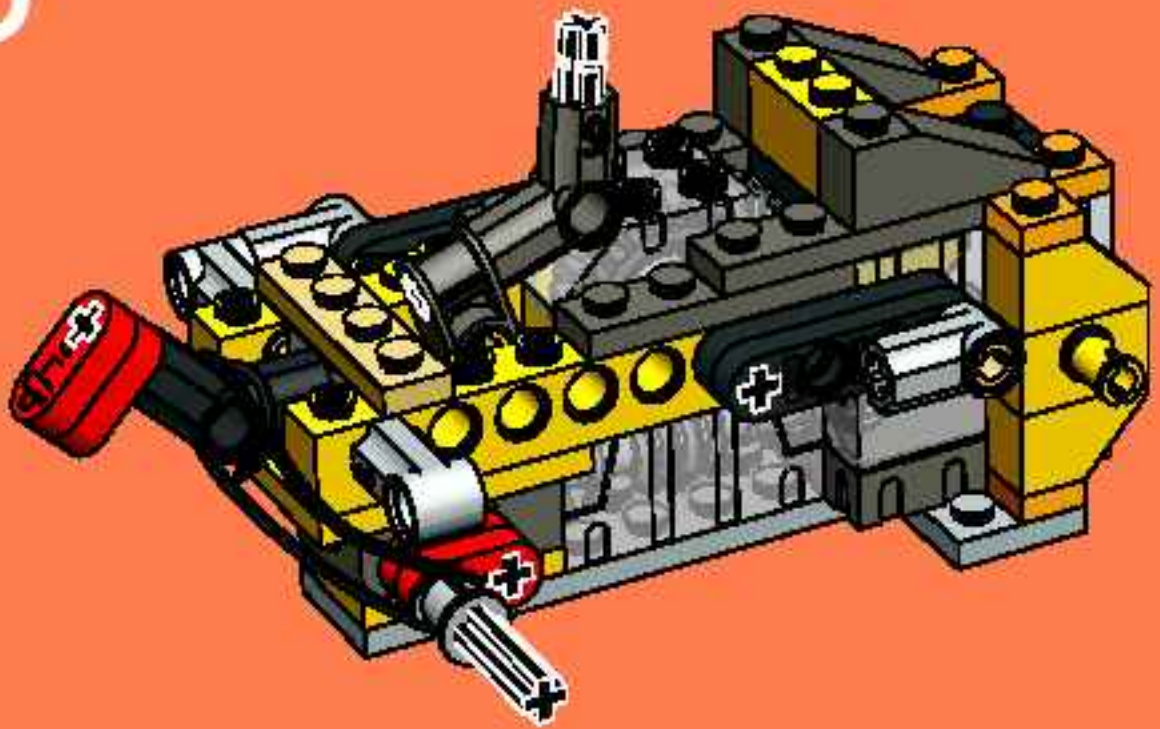

16

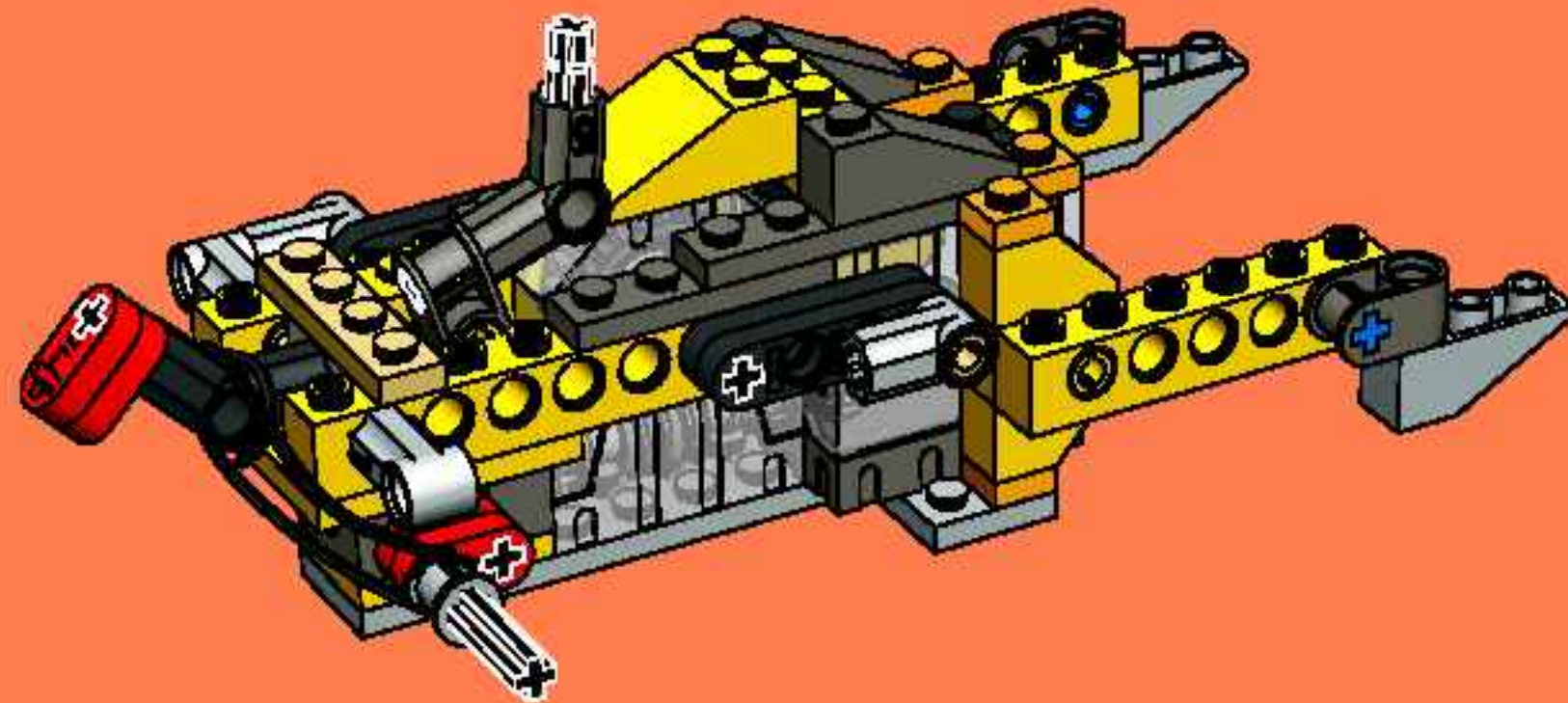
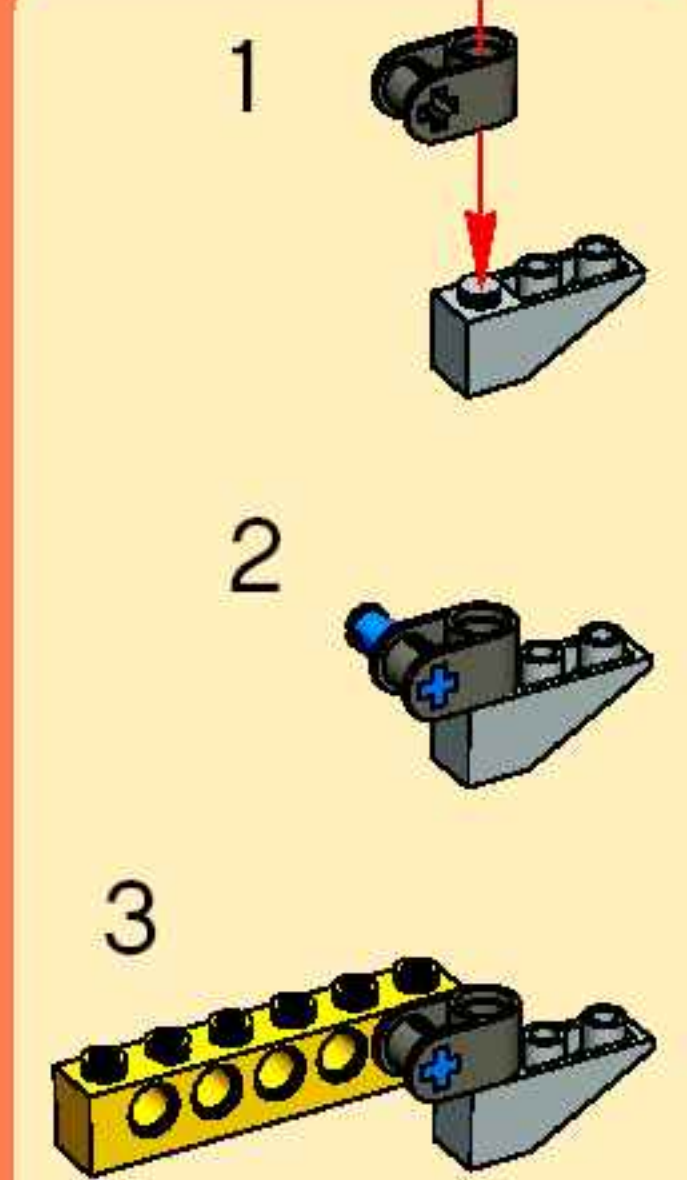
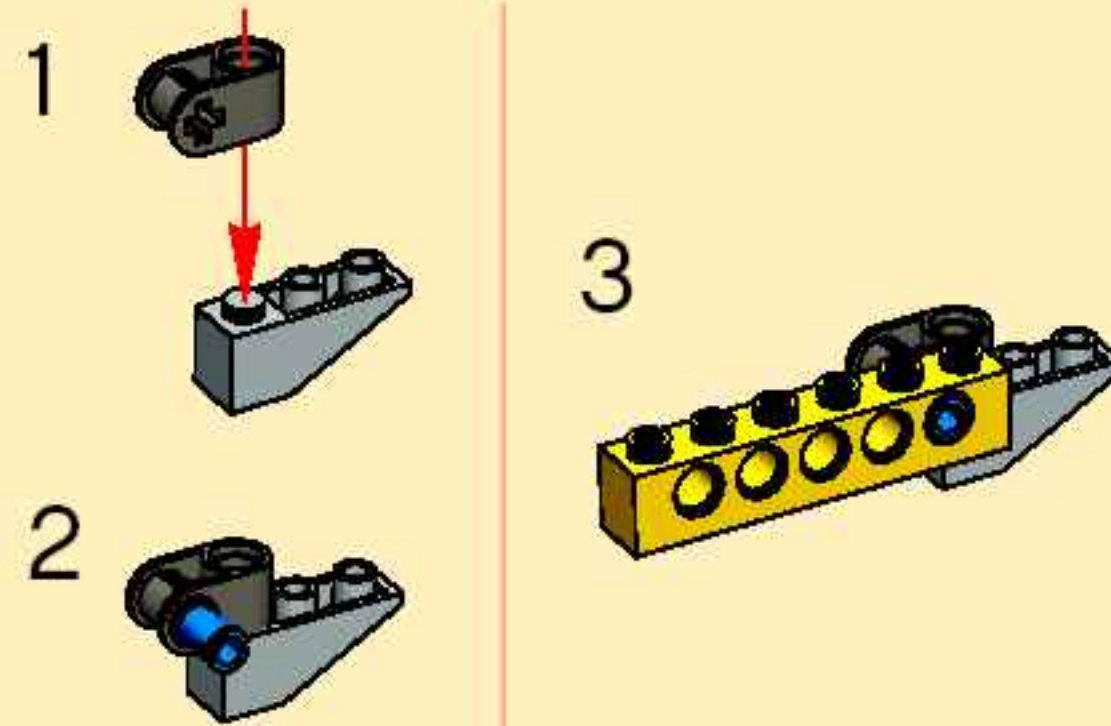

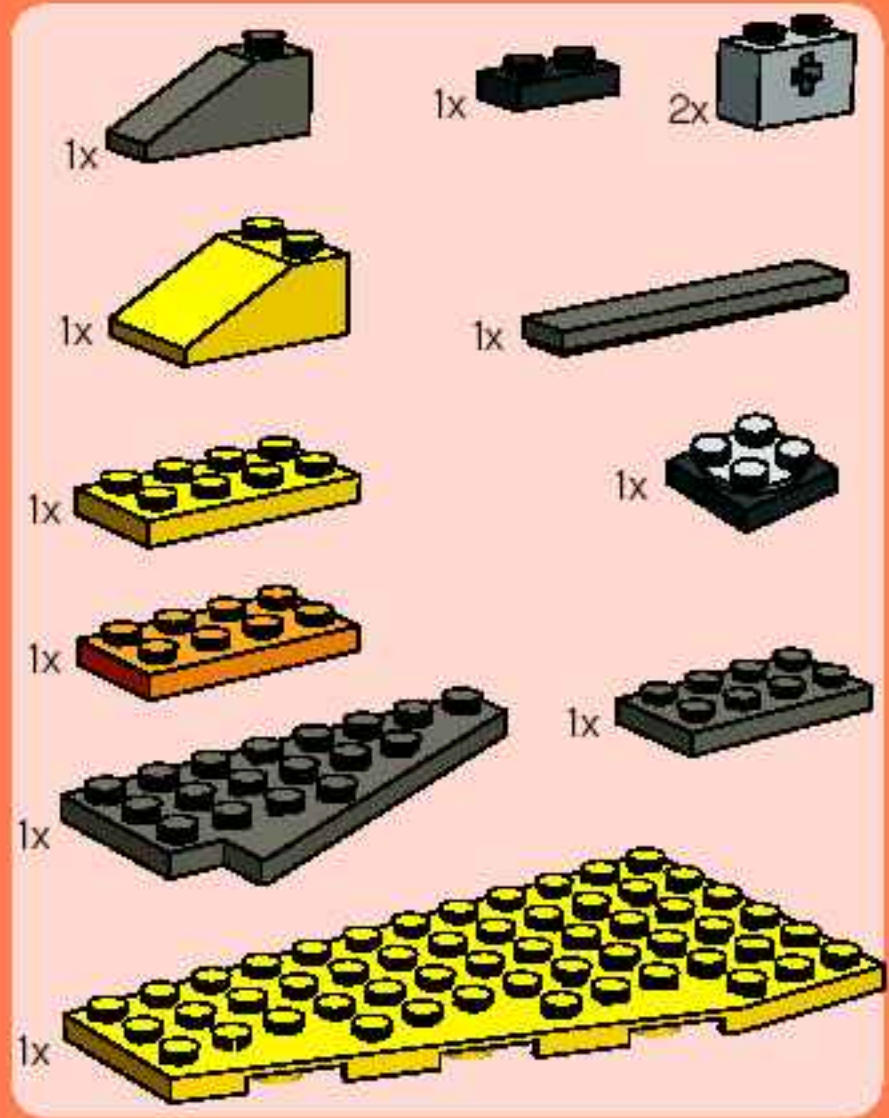

17

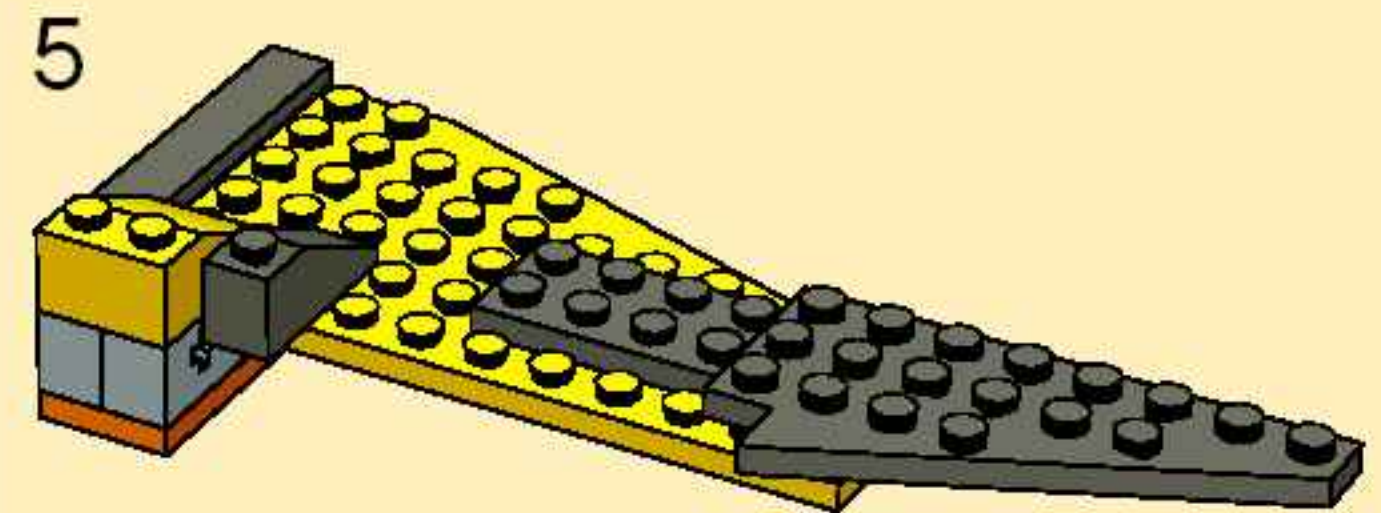
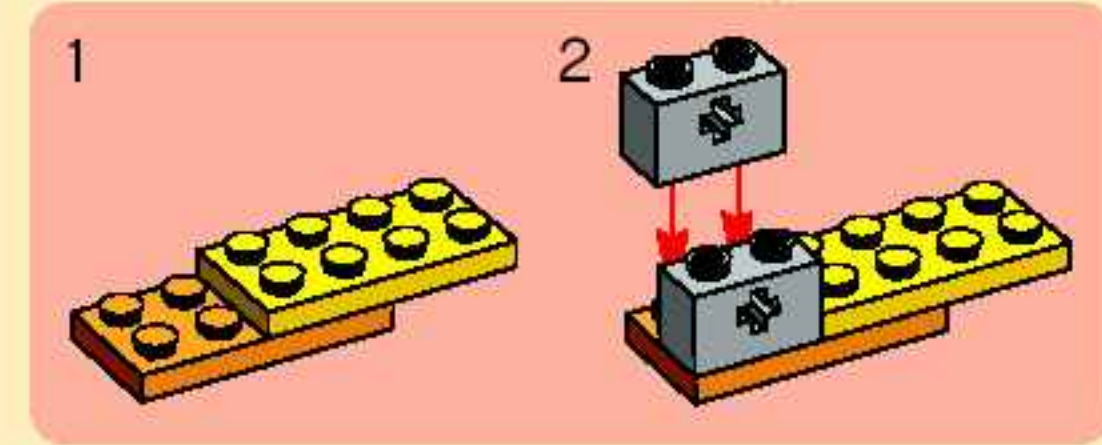
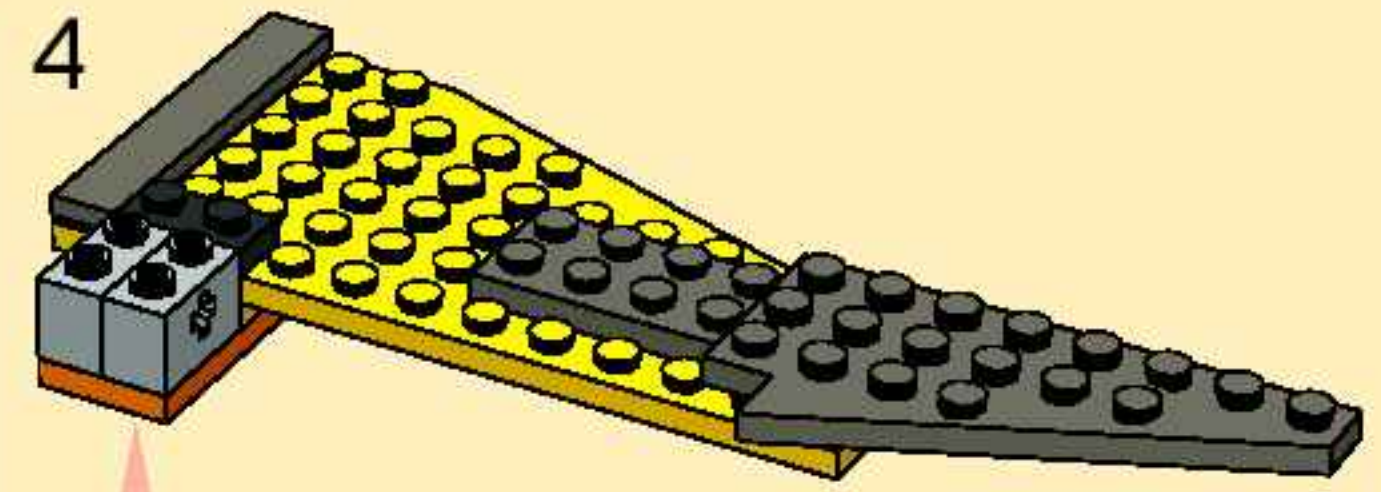
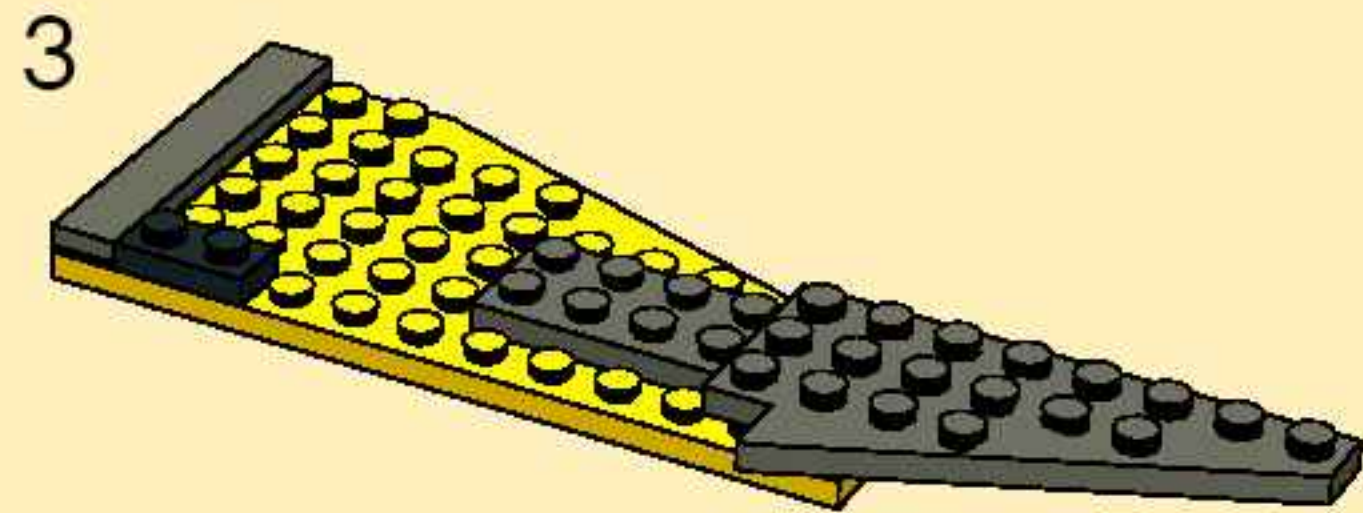
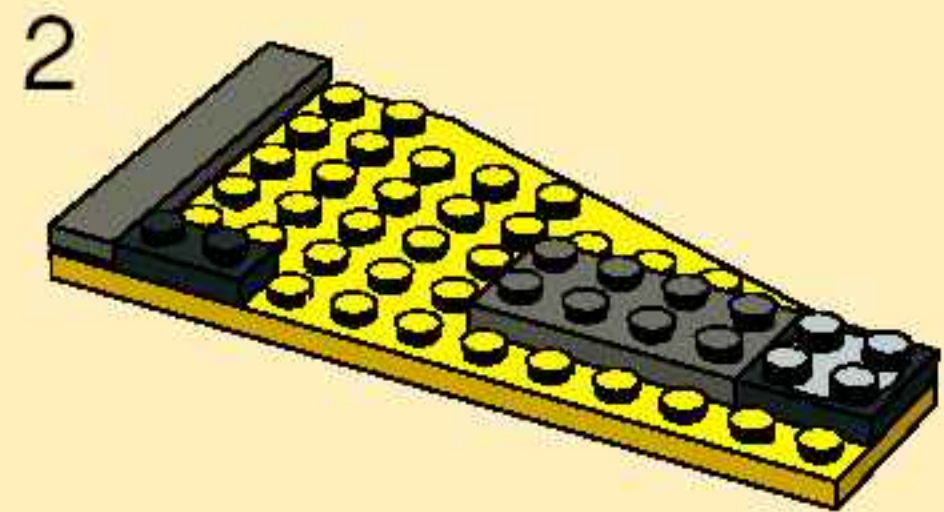
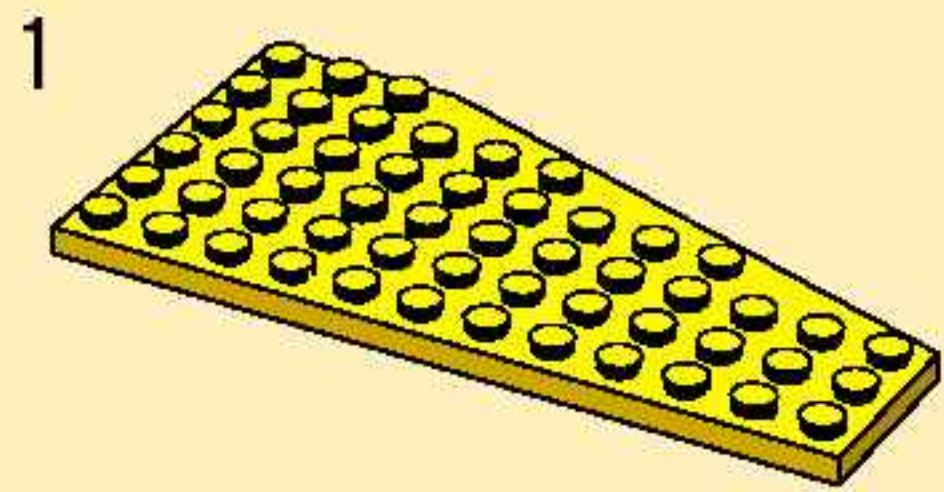



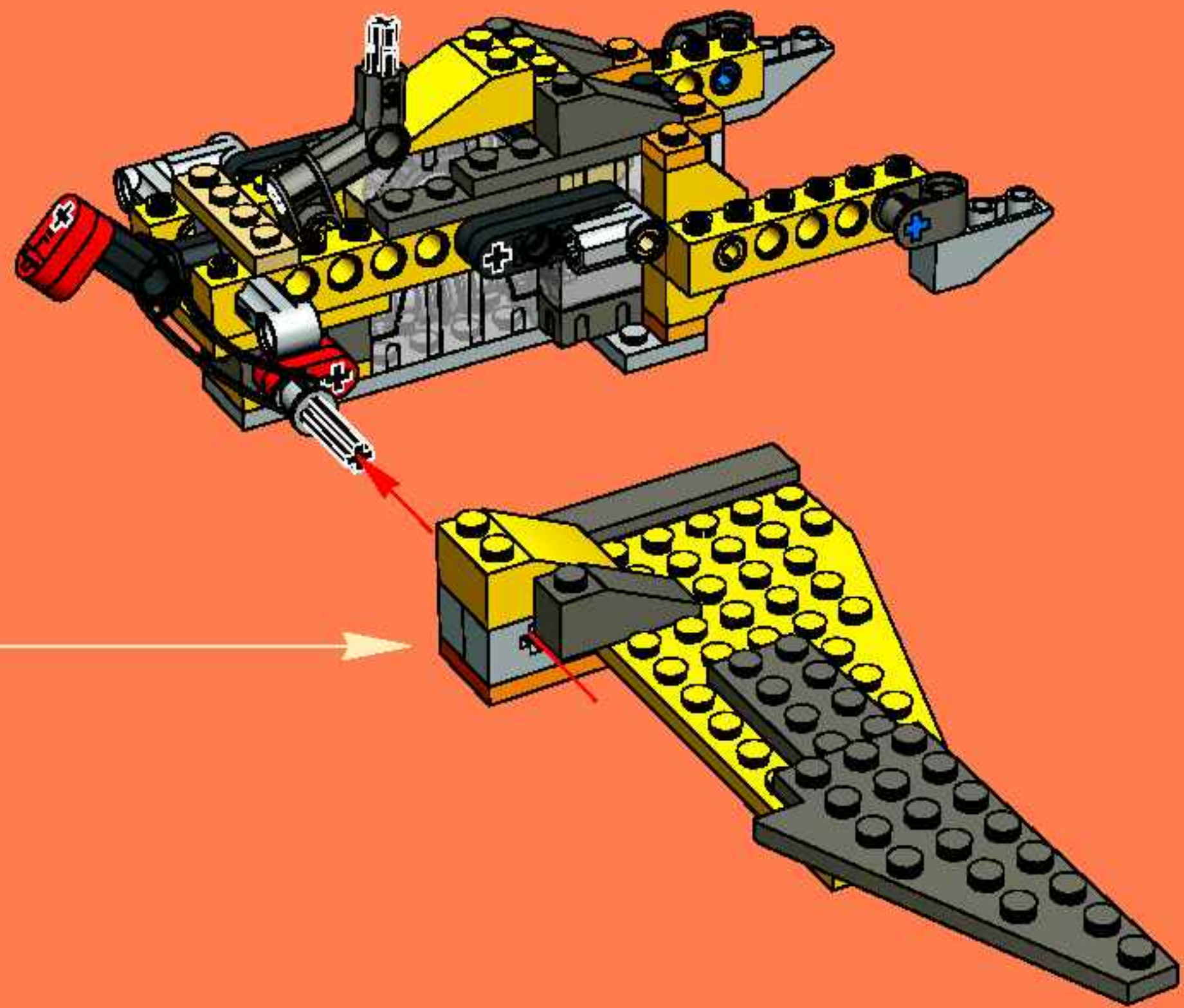

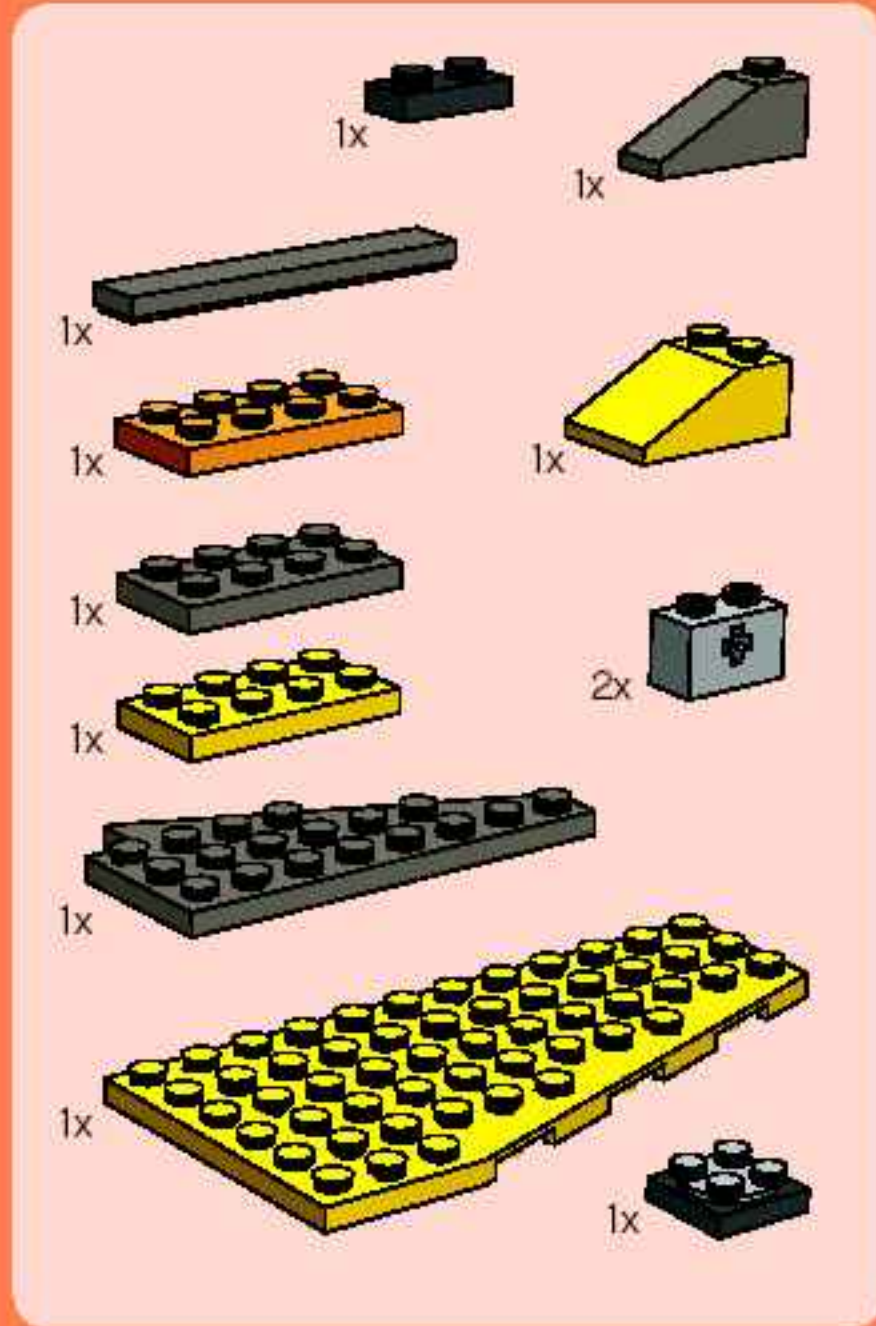

18

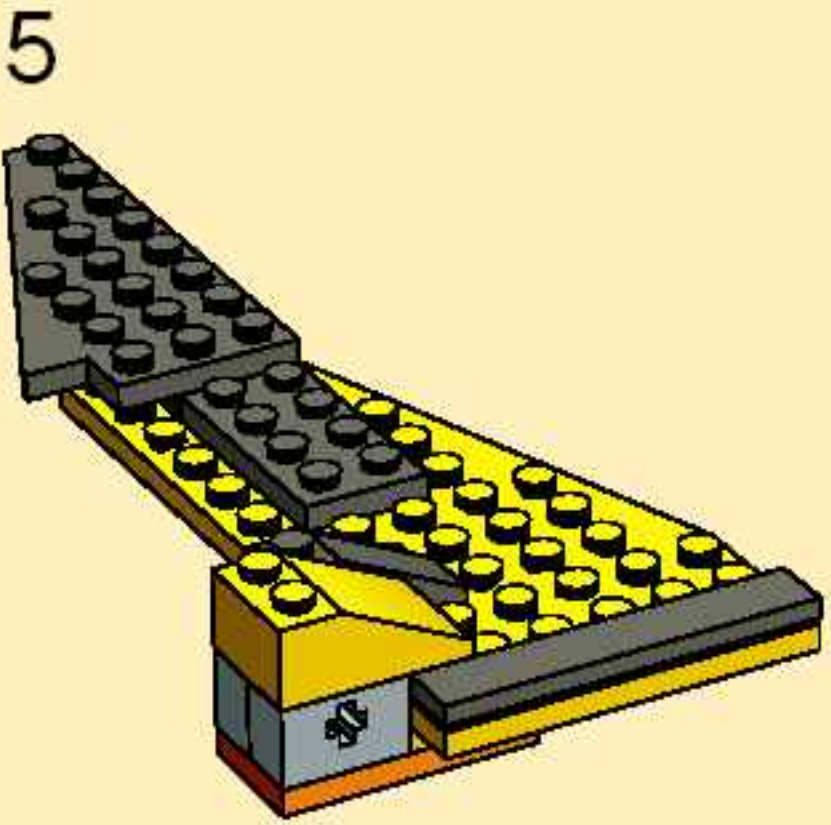
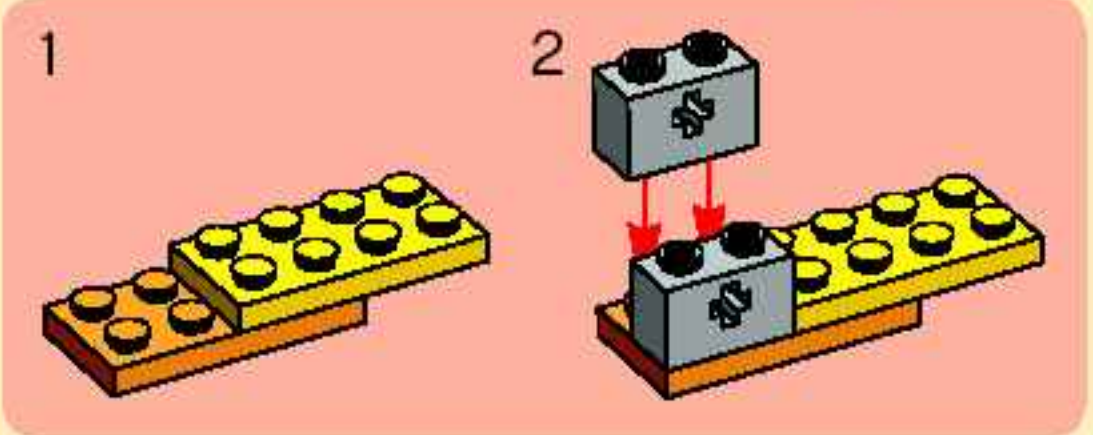
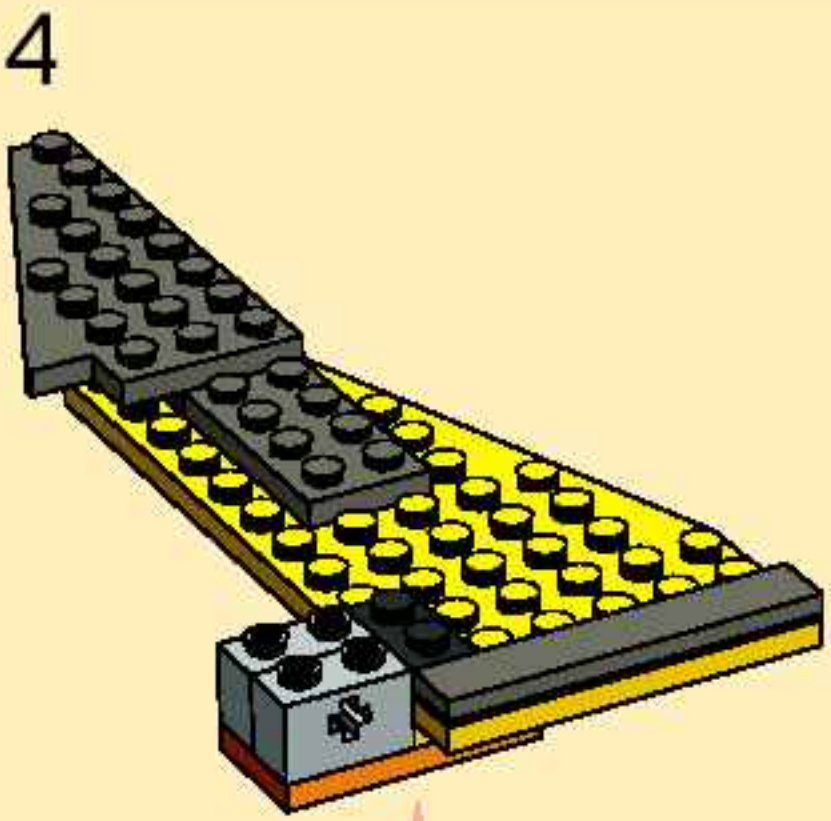
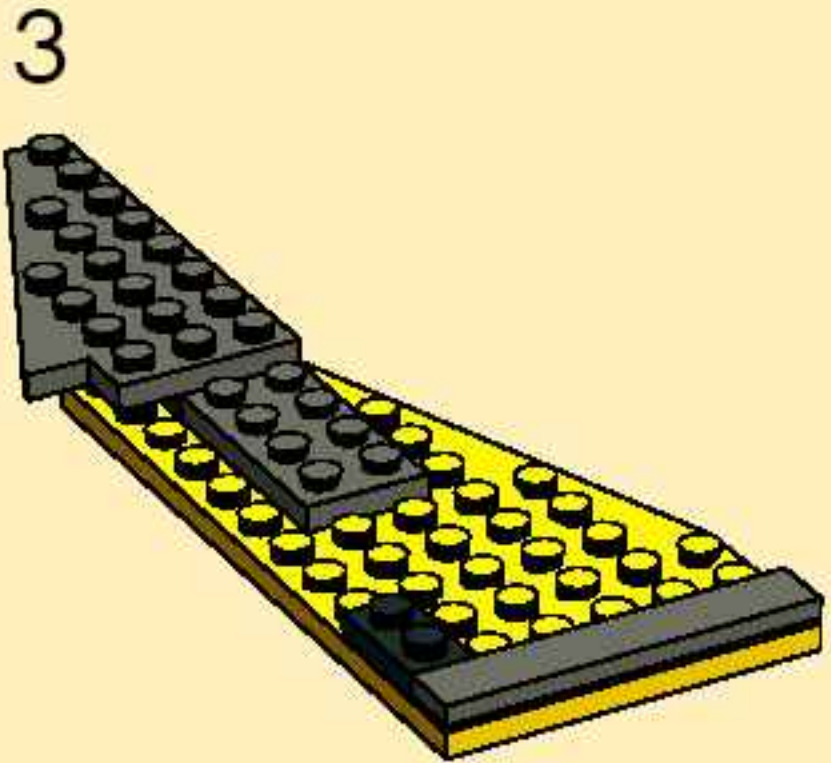
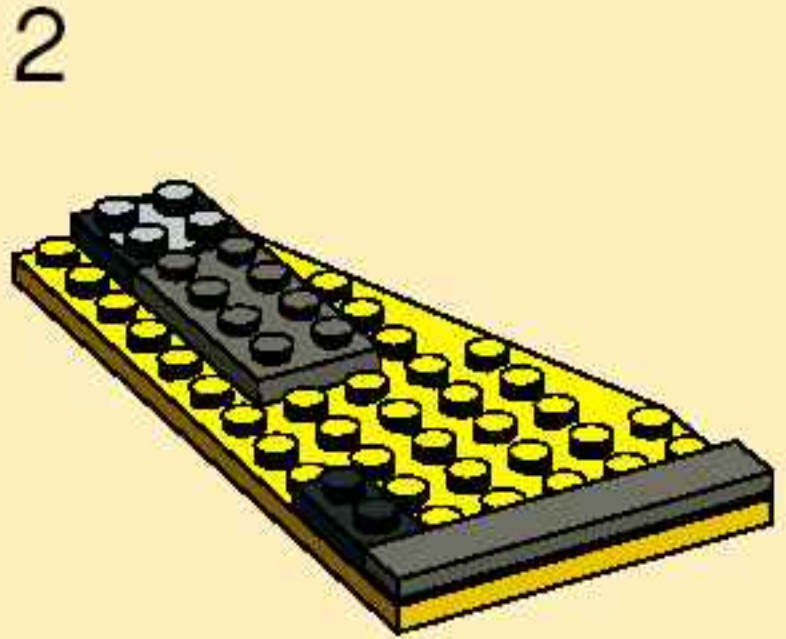
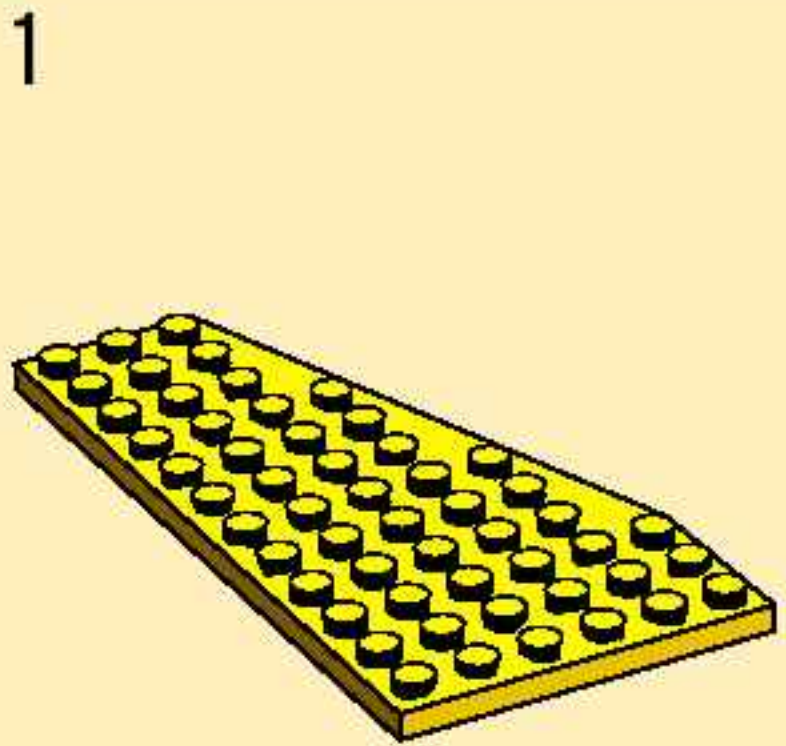

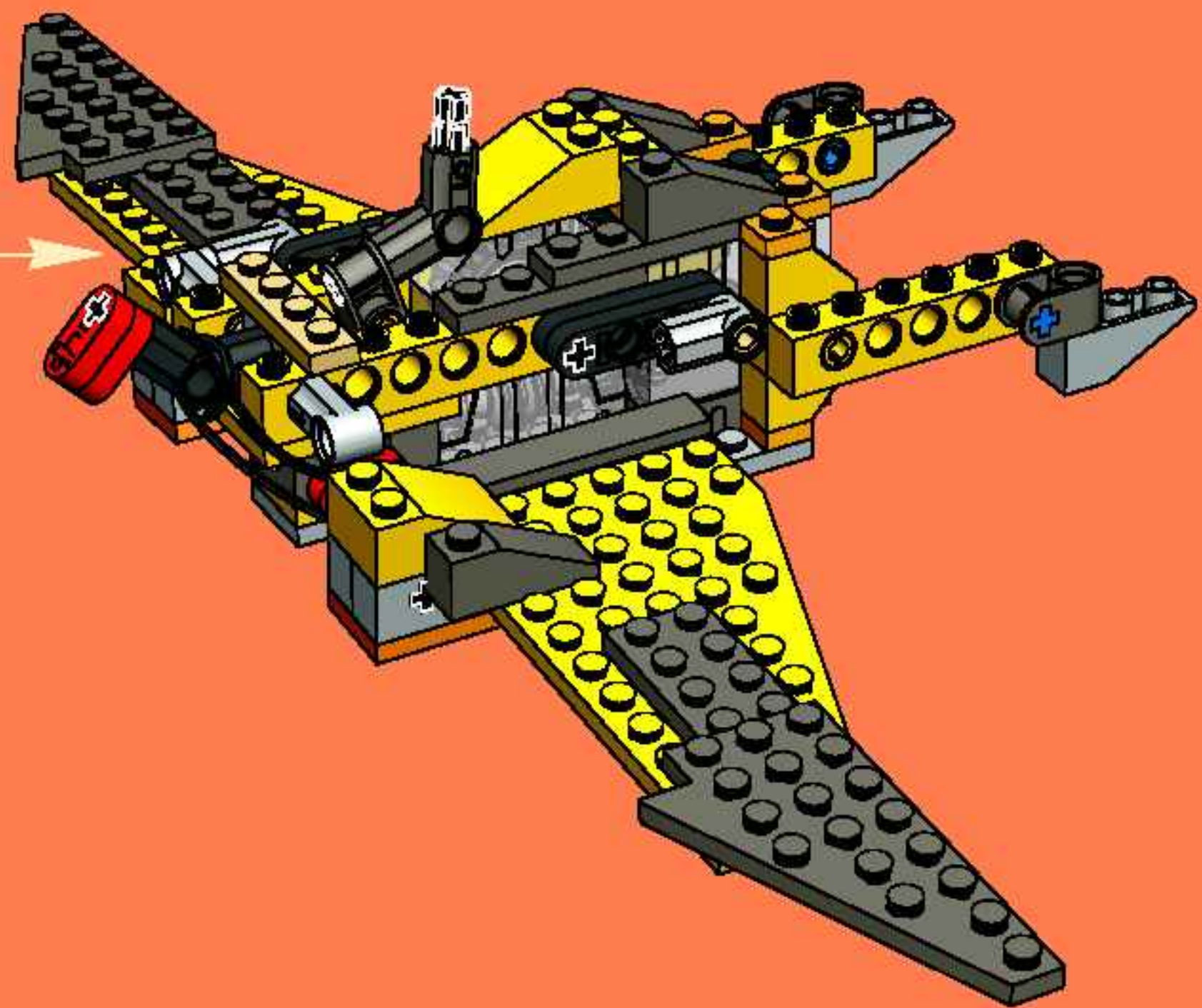







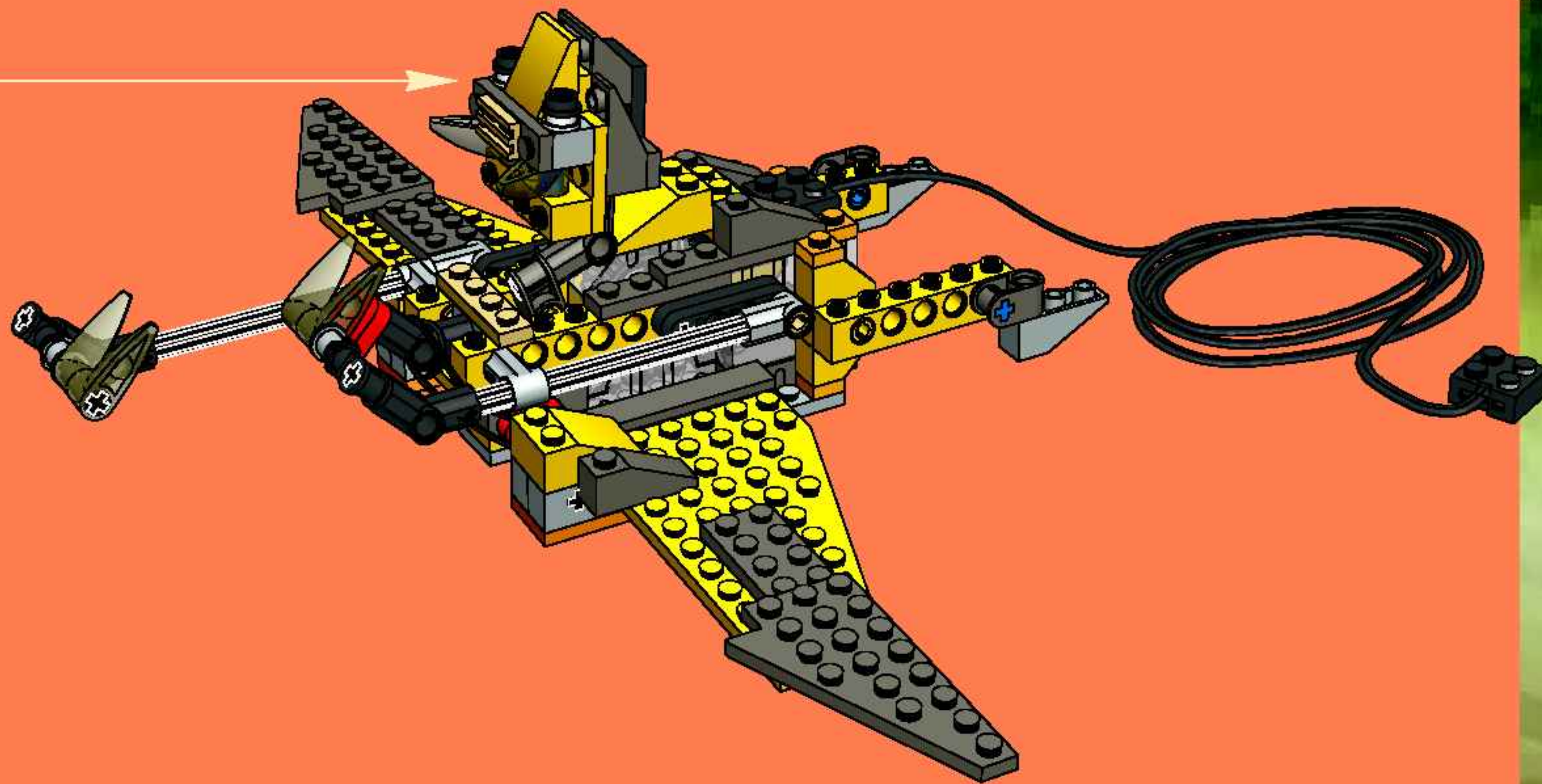

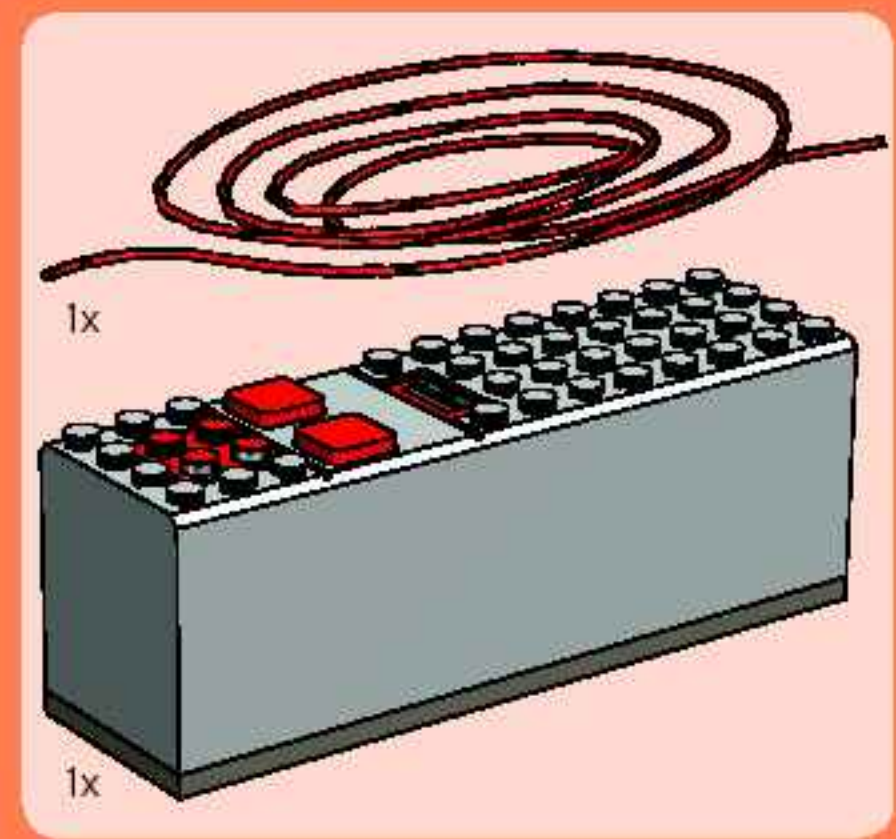

22

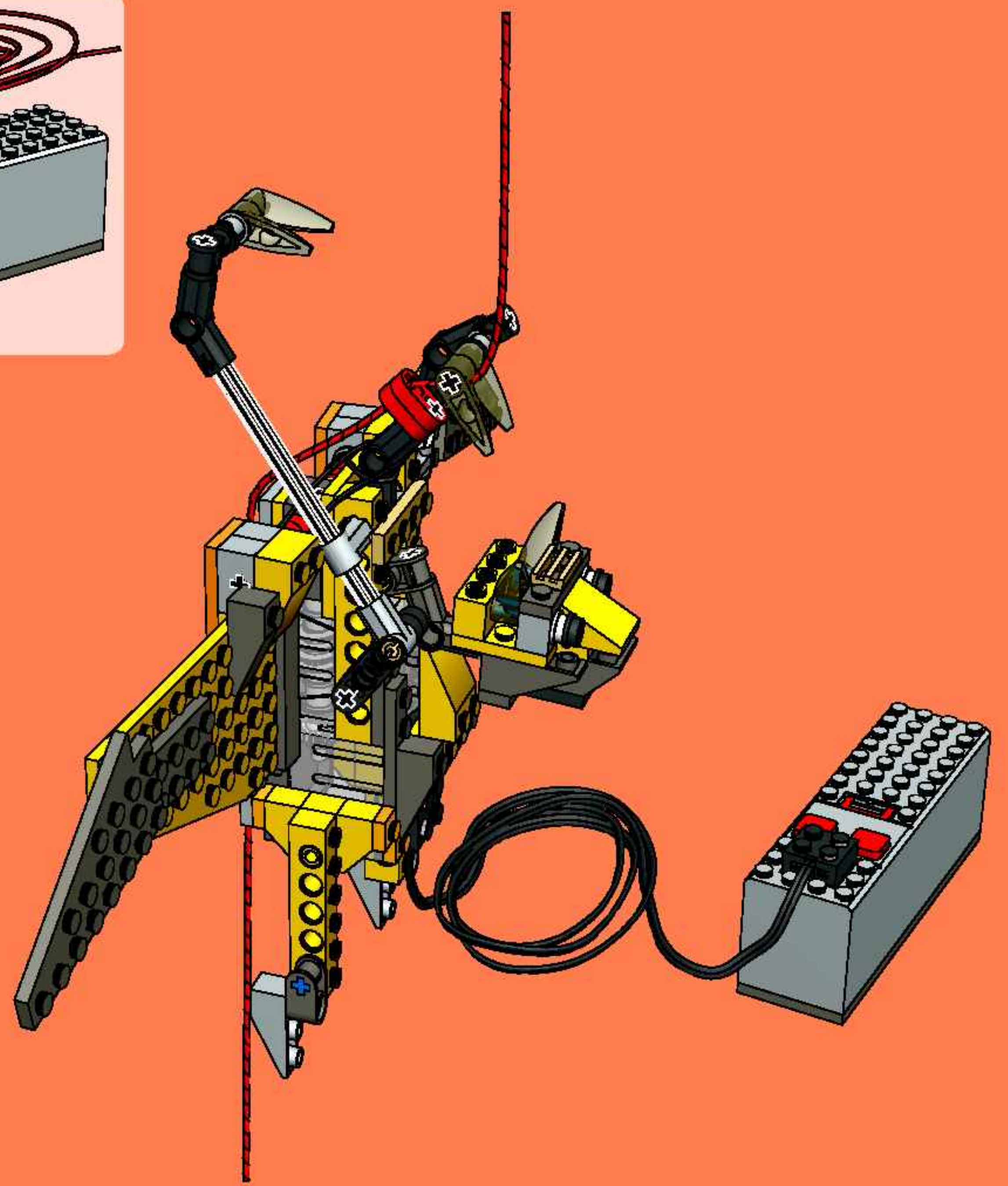







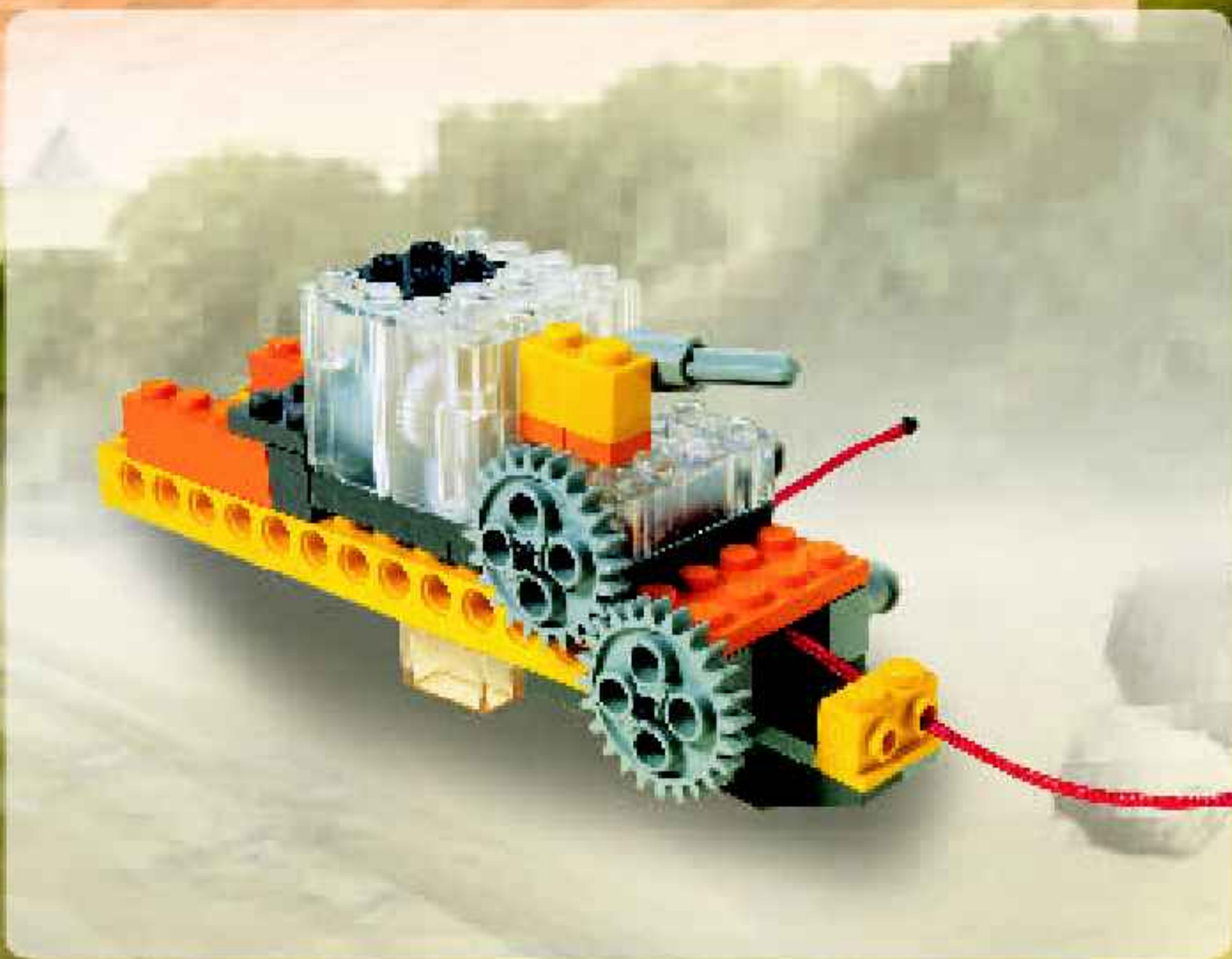







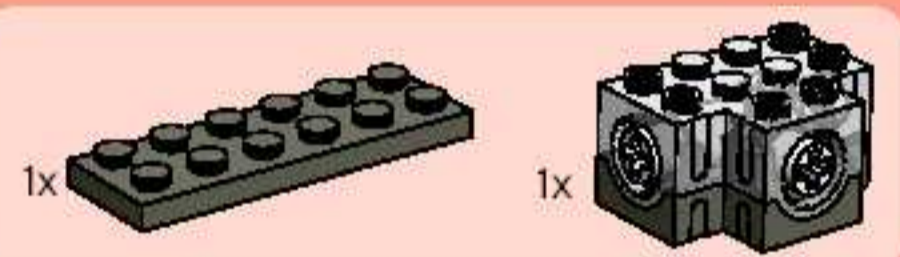
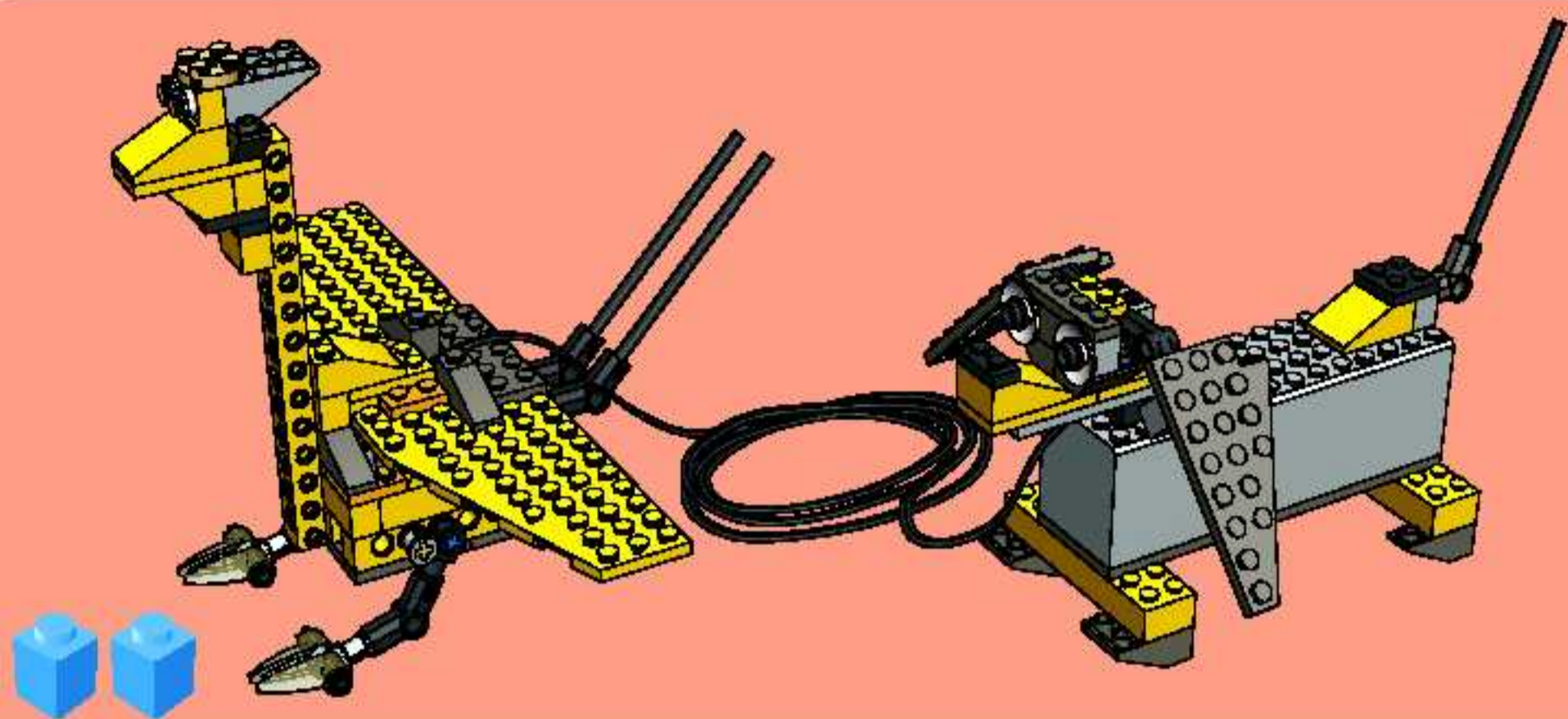

1

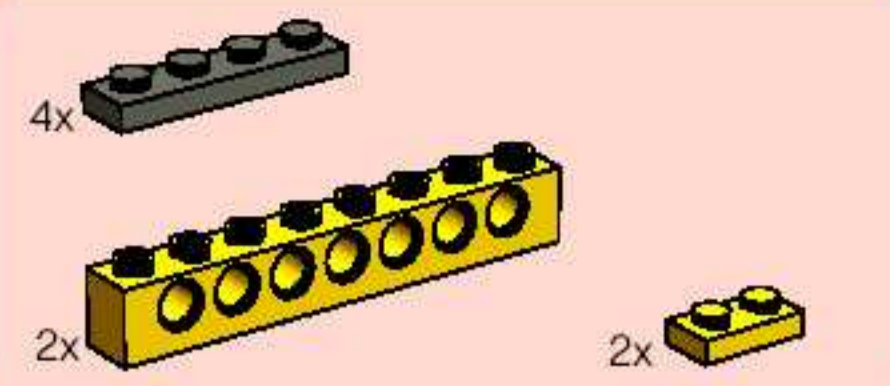
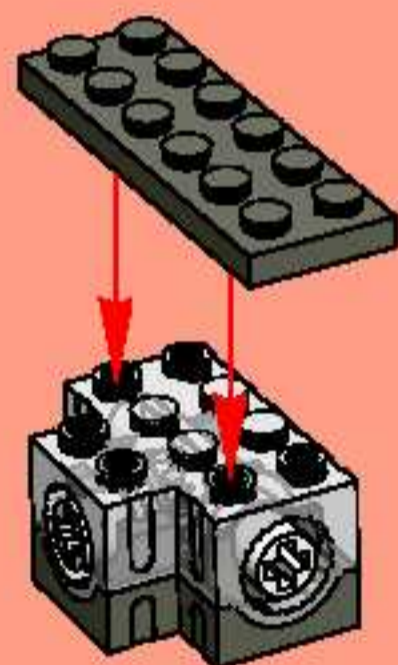

2

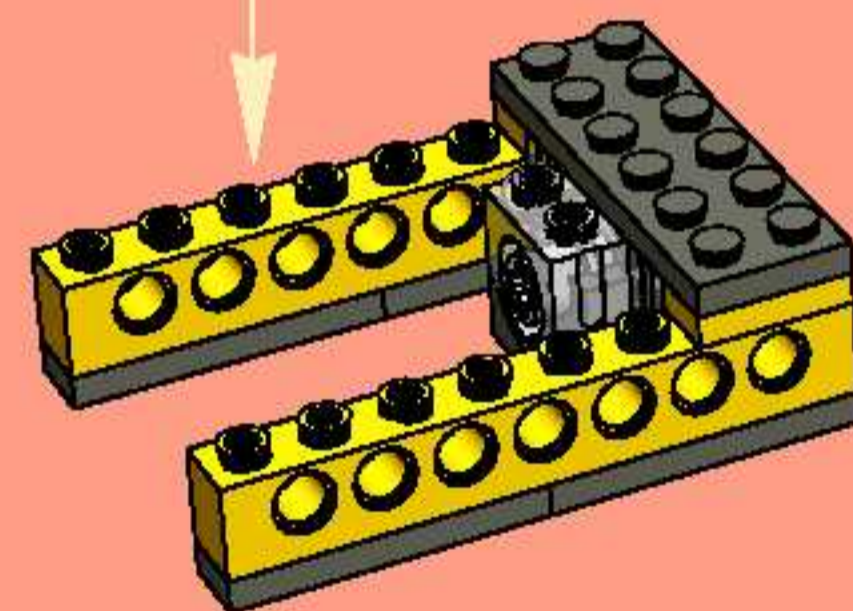
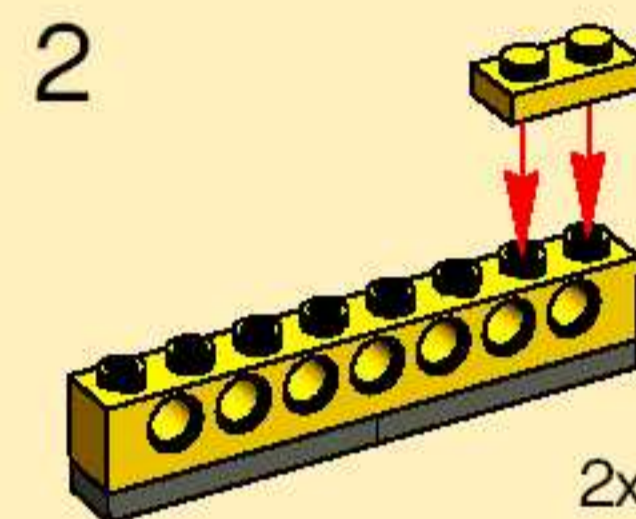
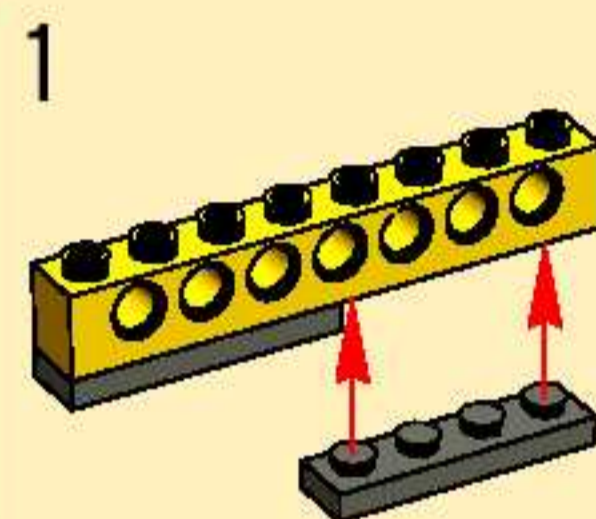



3

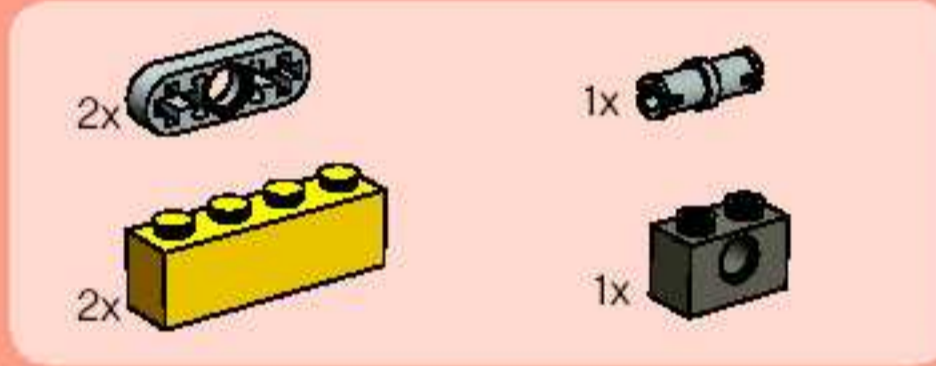
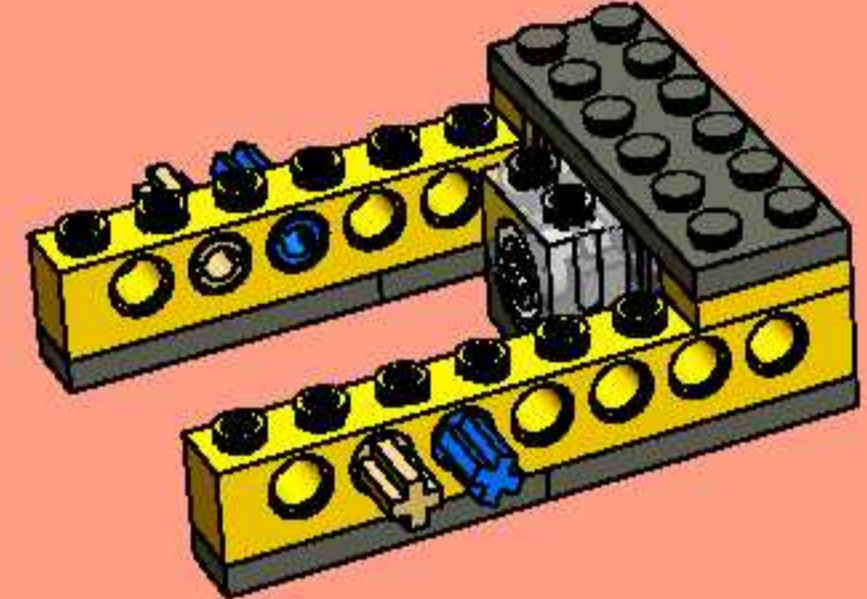

4

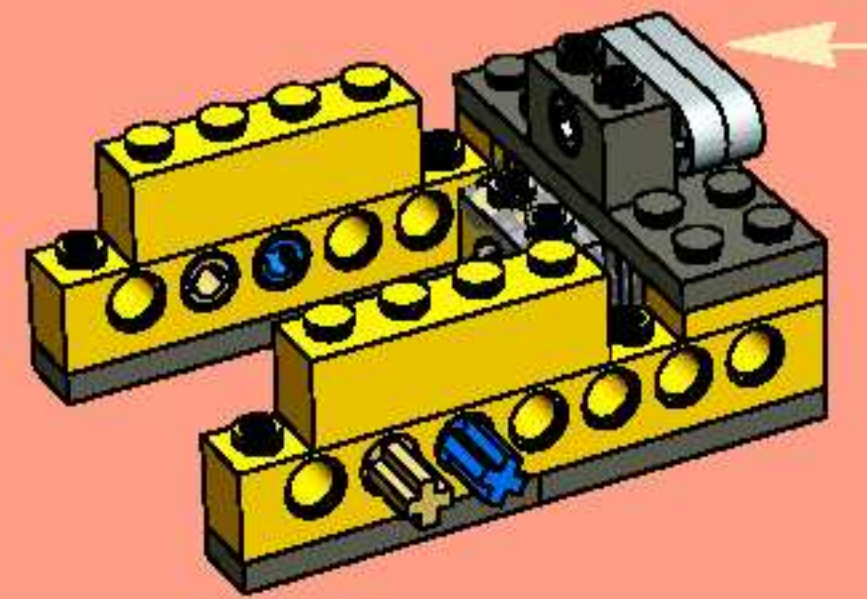

5

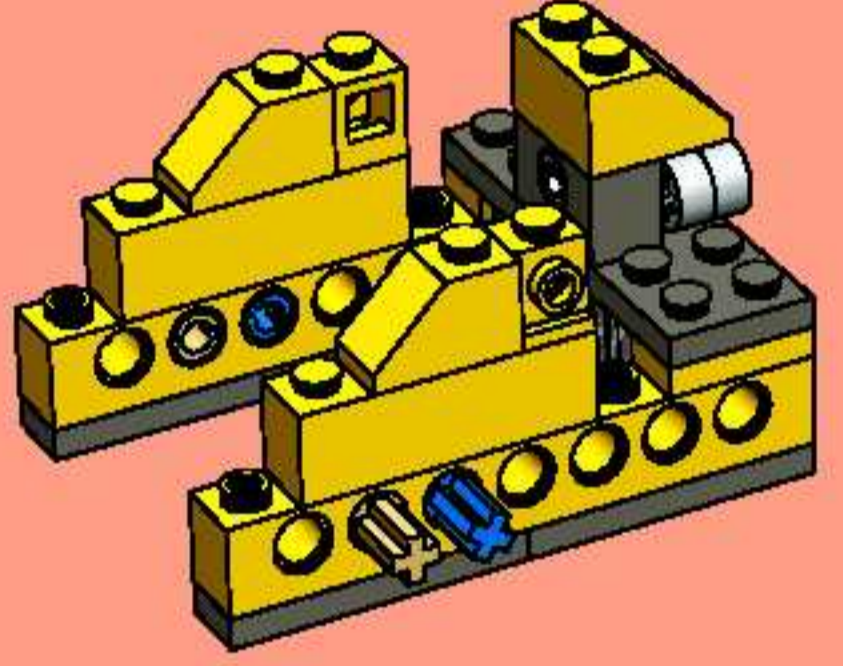



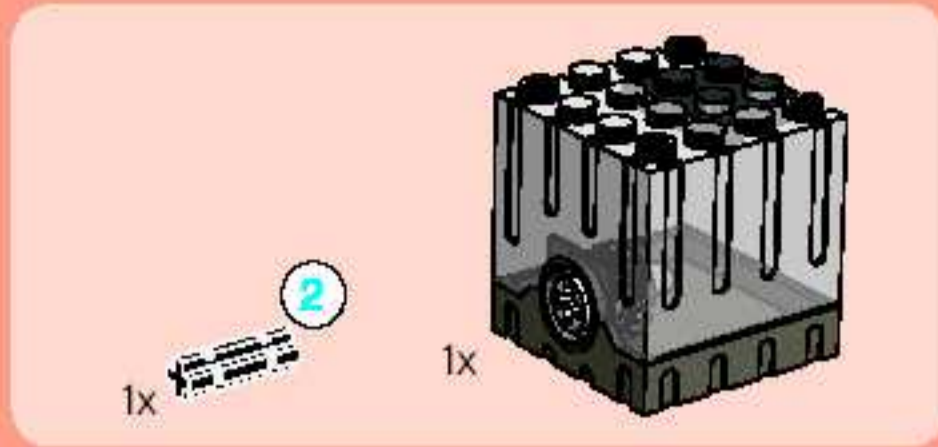

6

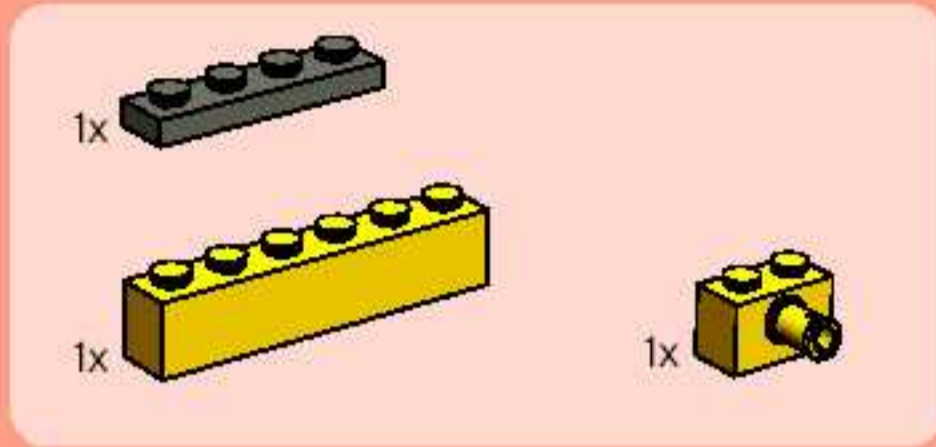
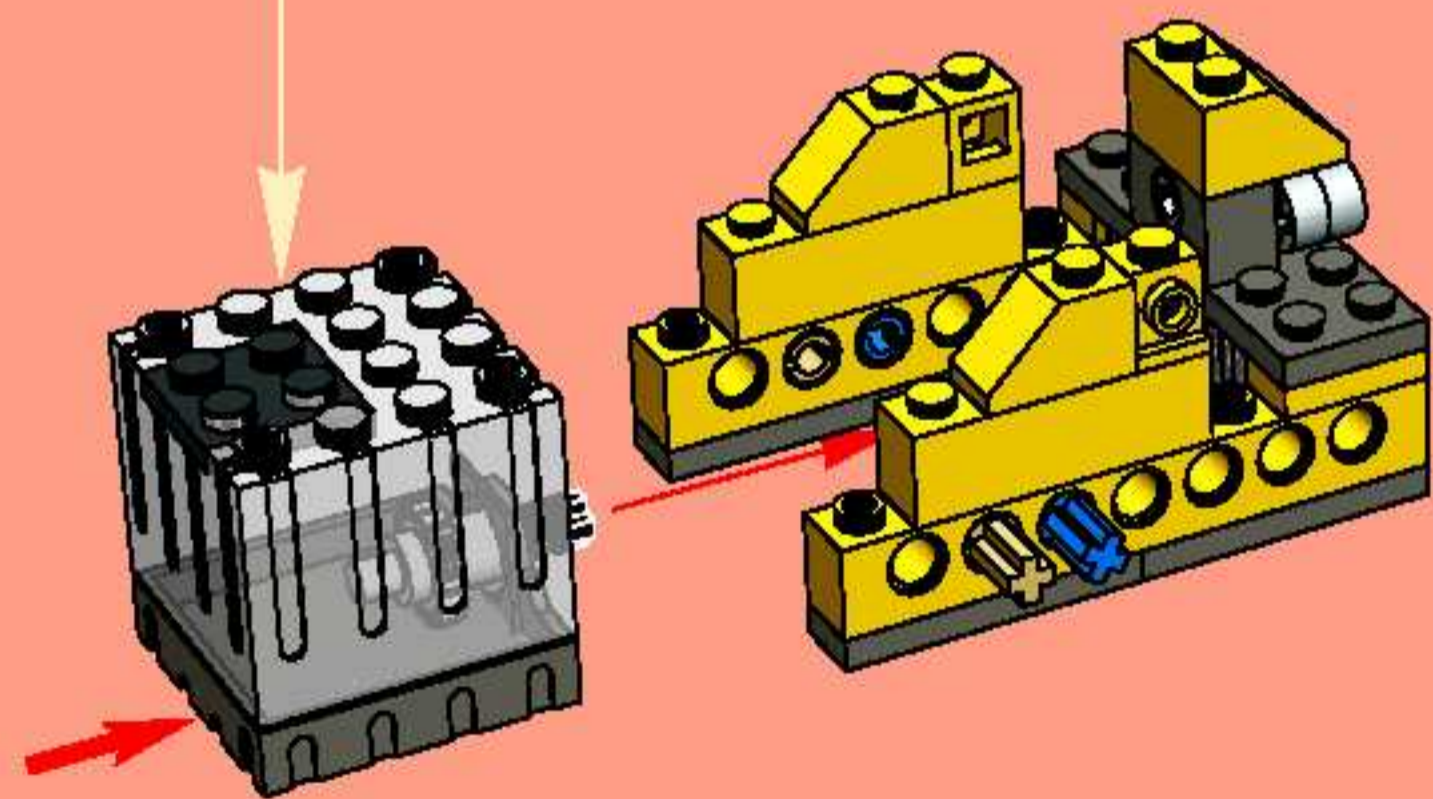
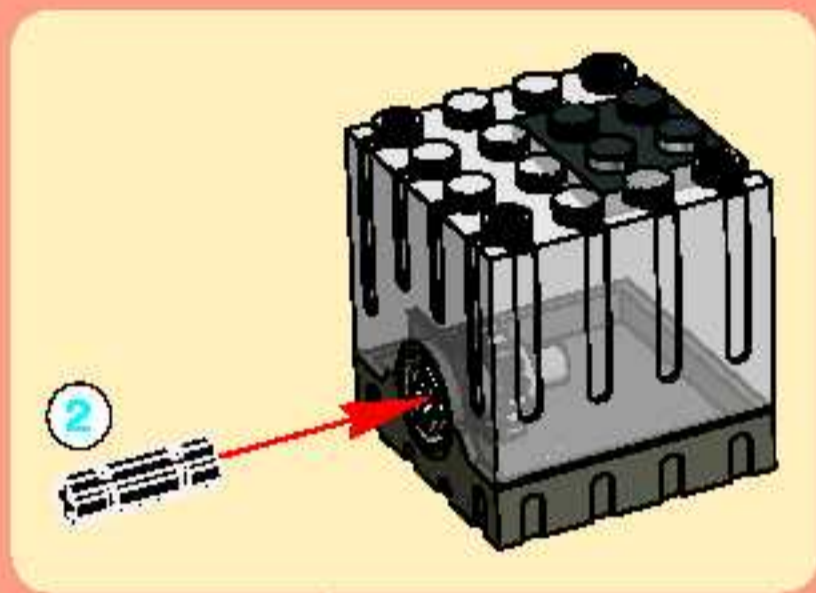

7

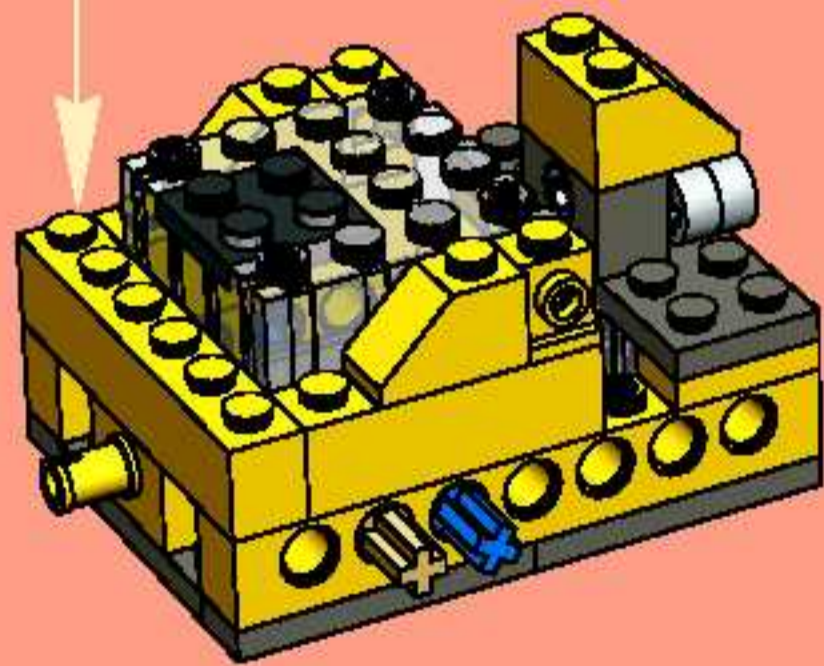
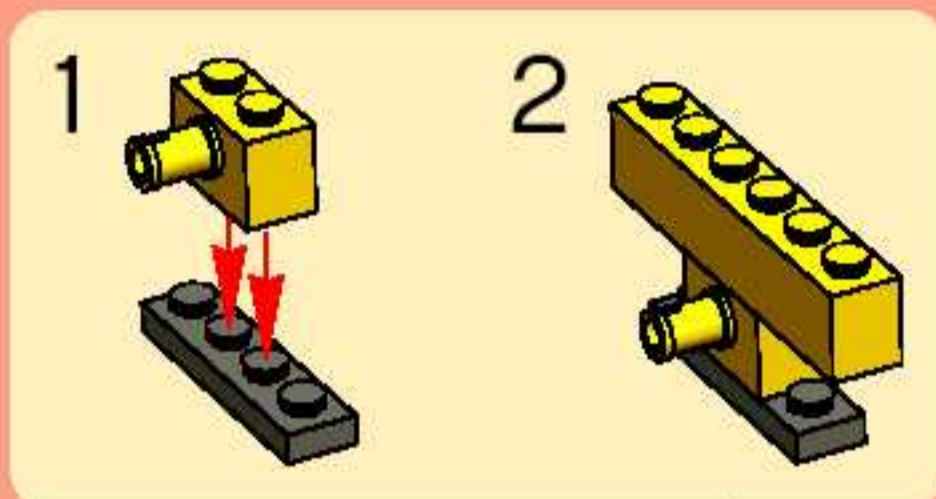

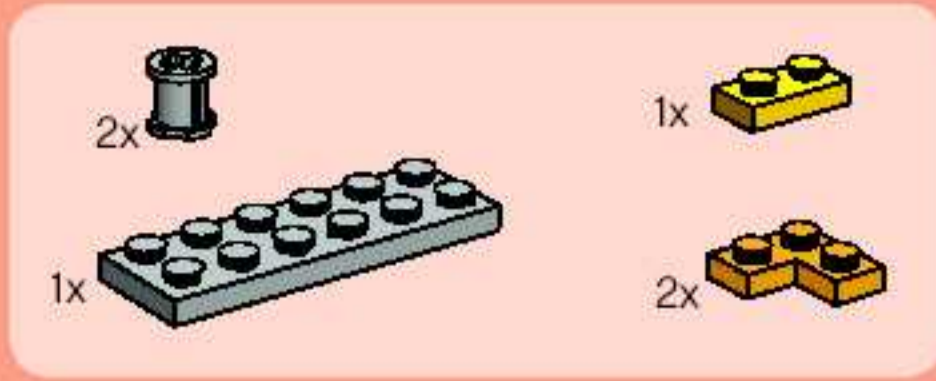
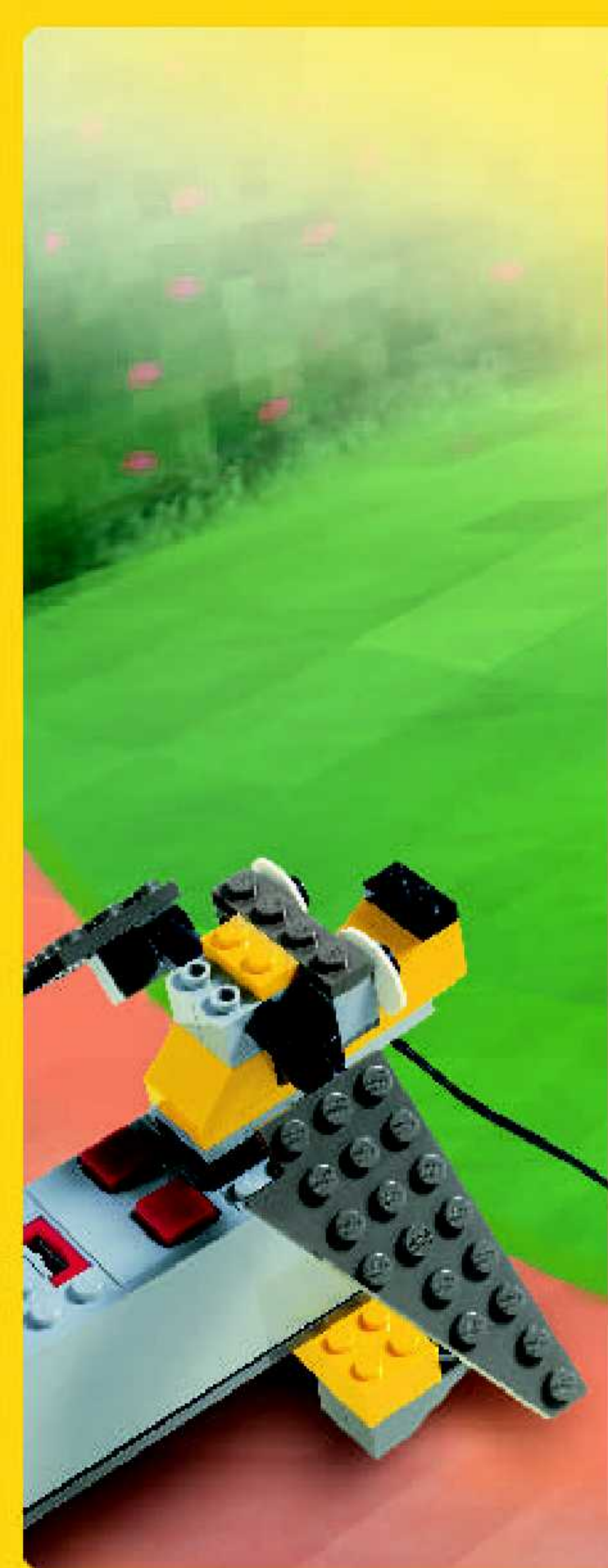

8

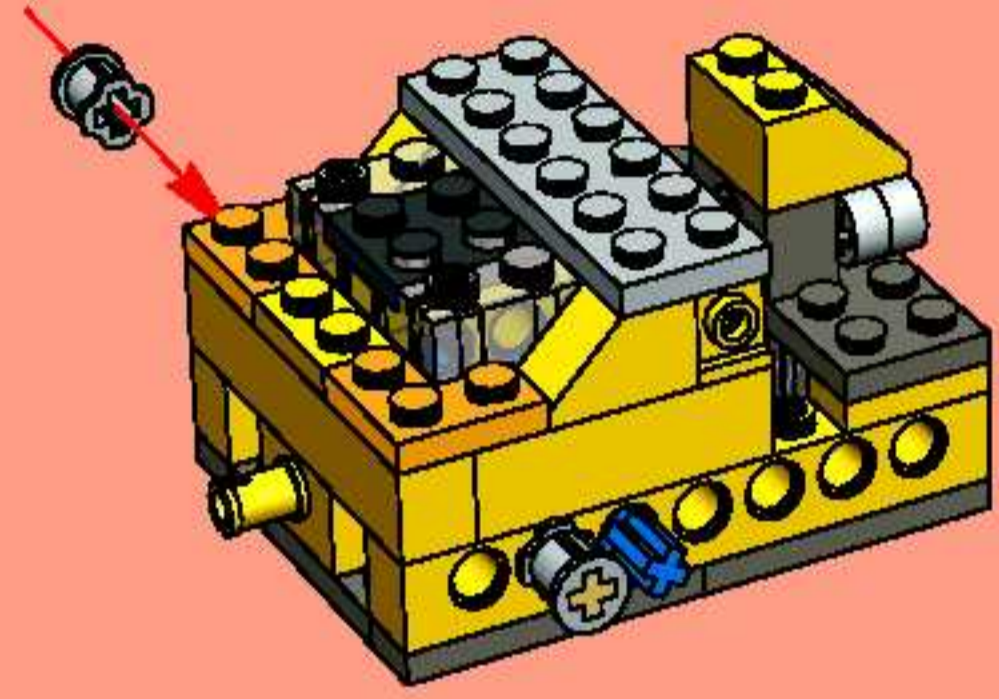

9

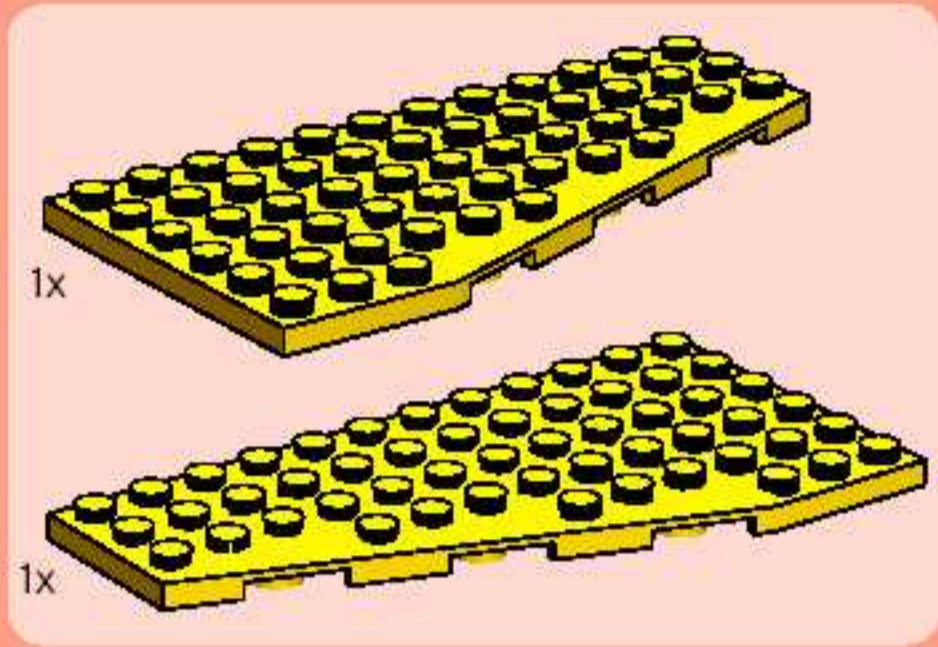
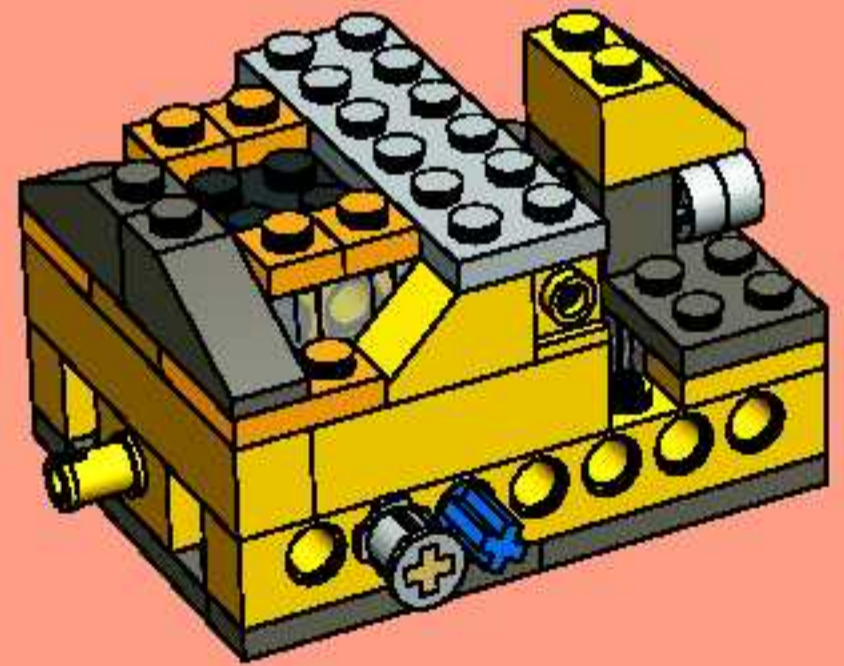

10

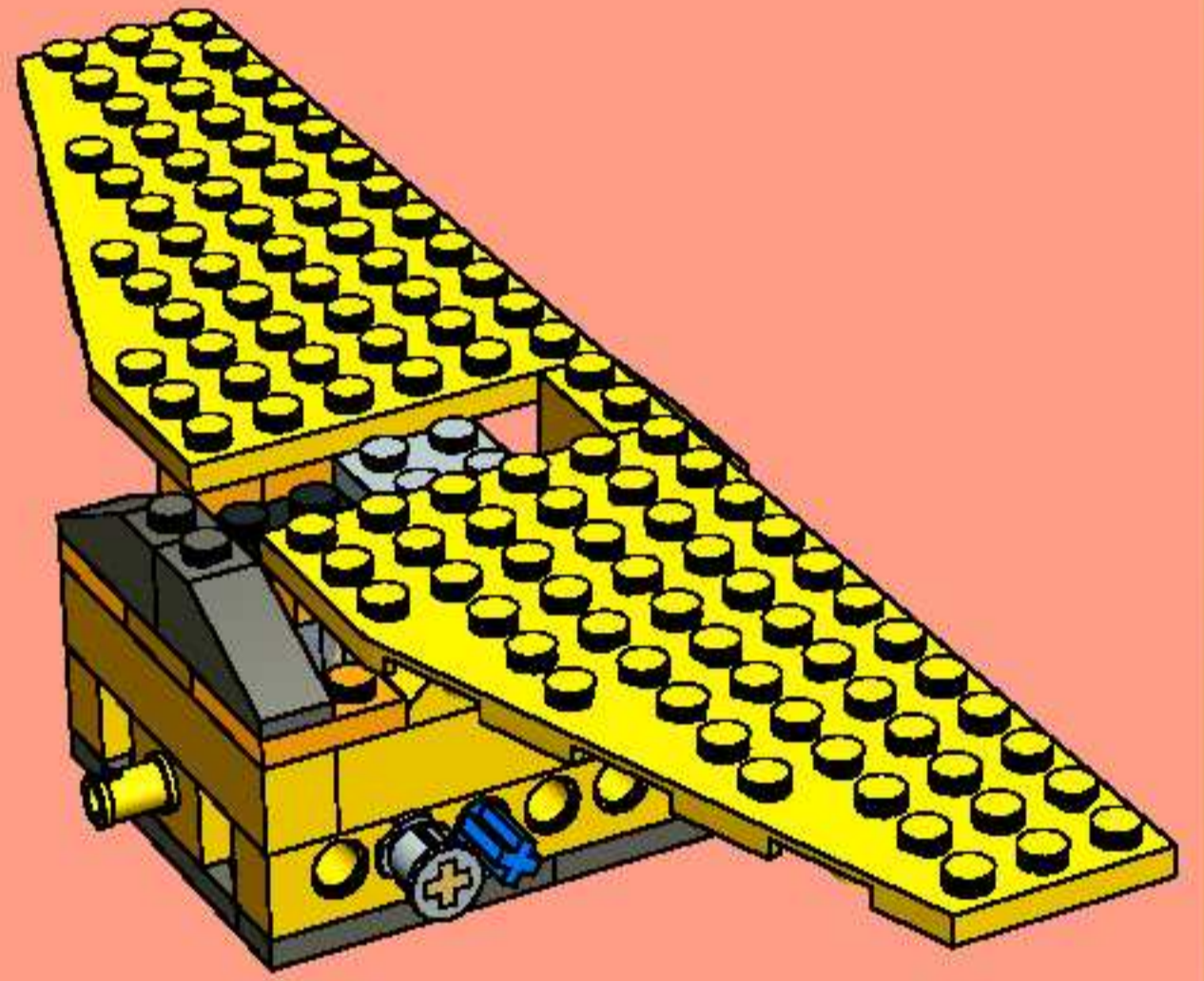

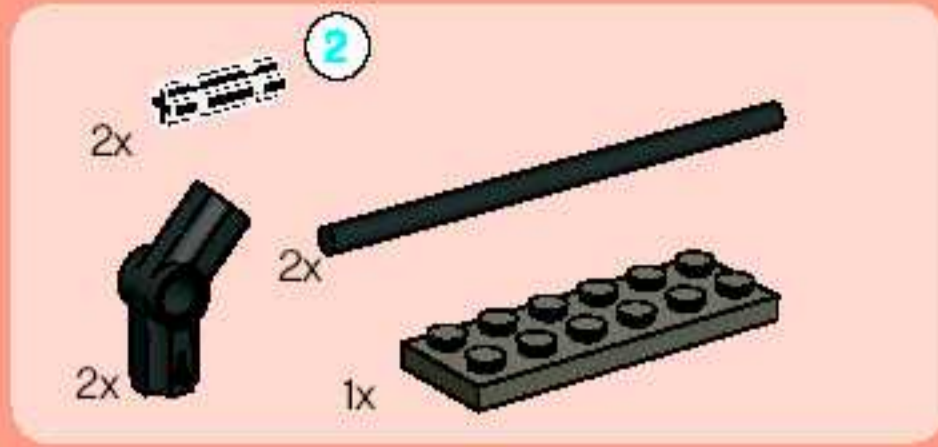

11

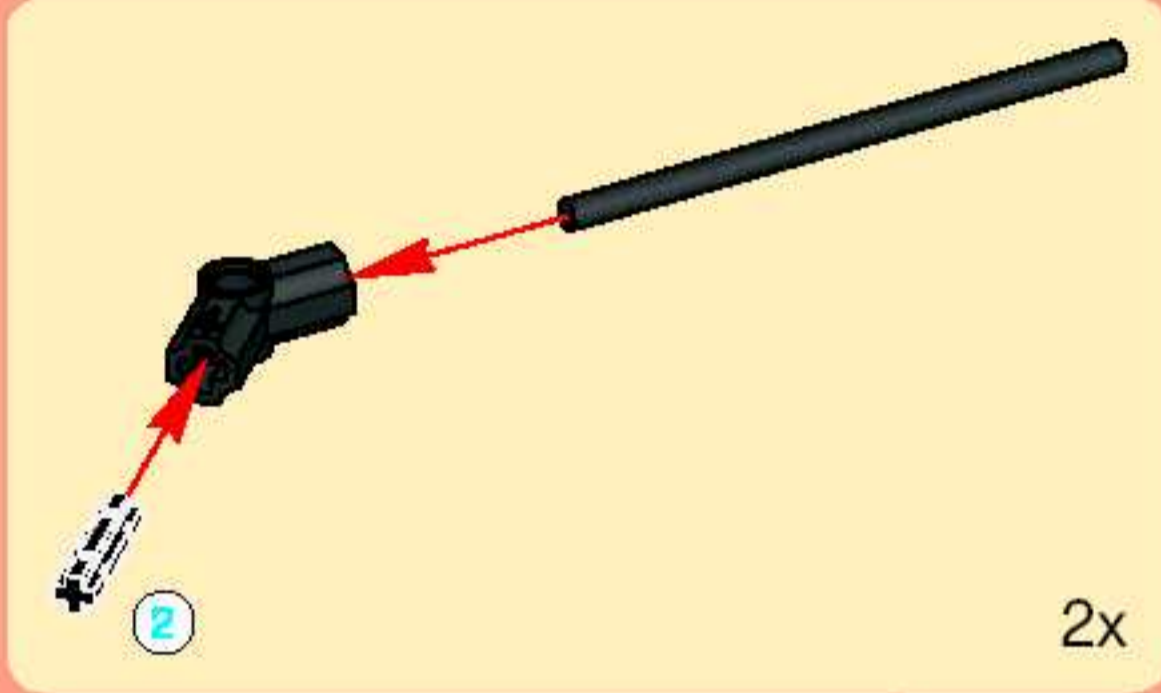

2x

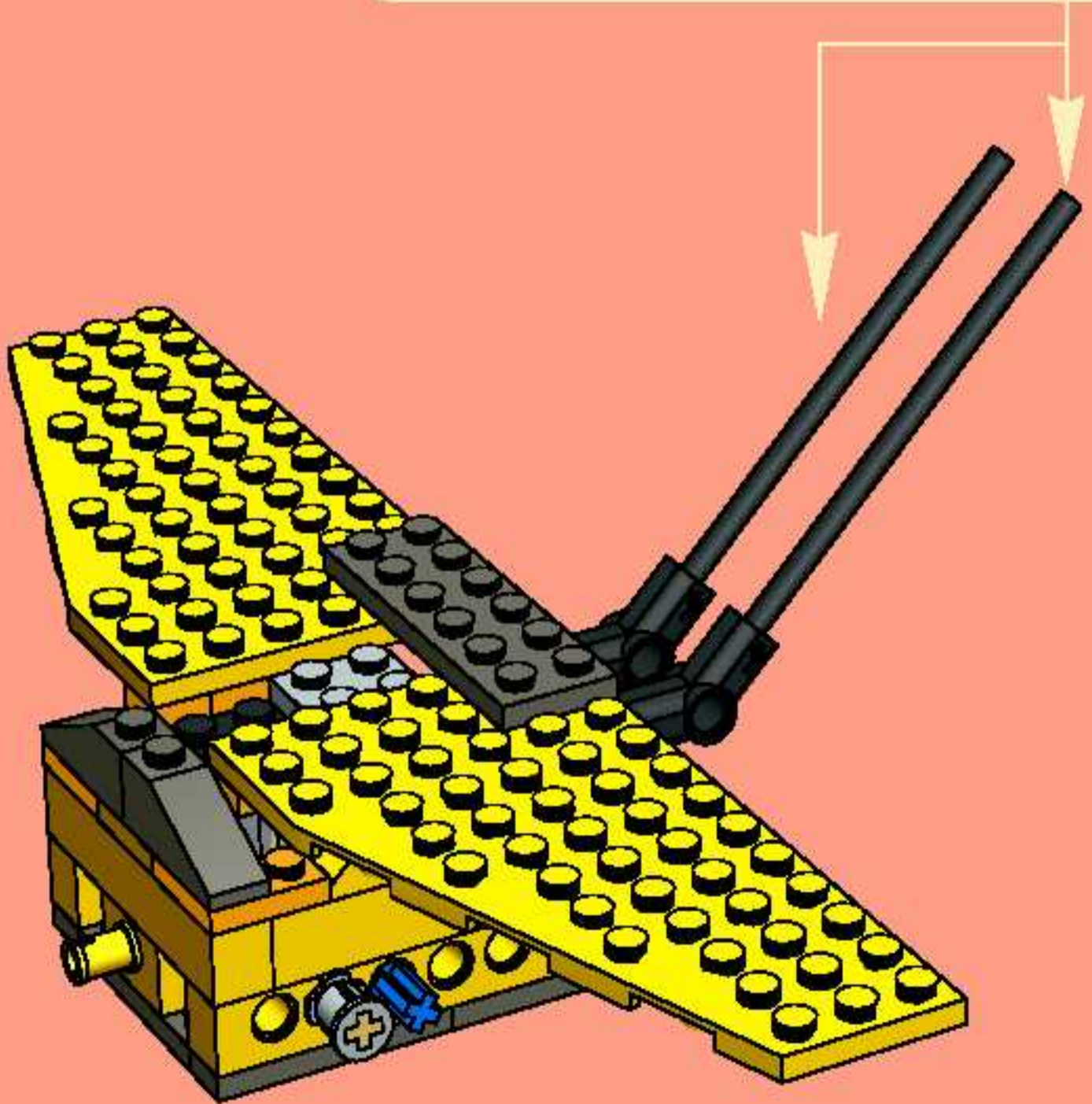



12

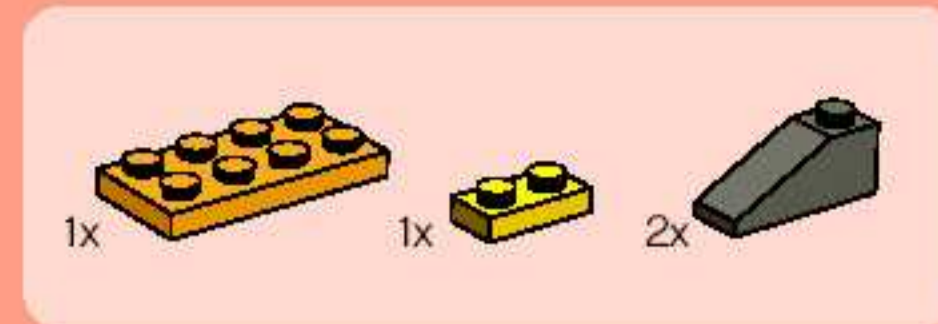
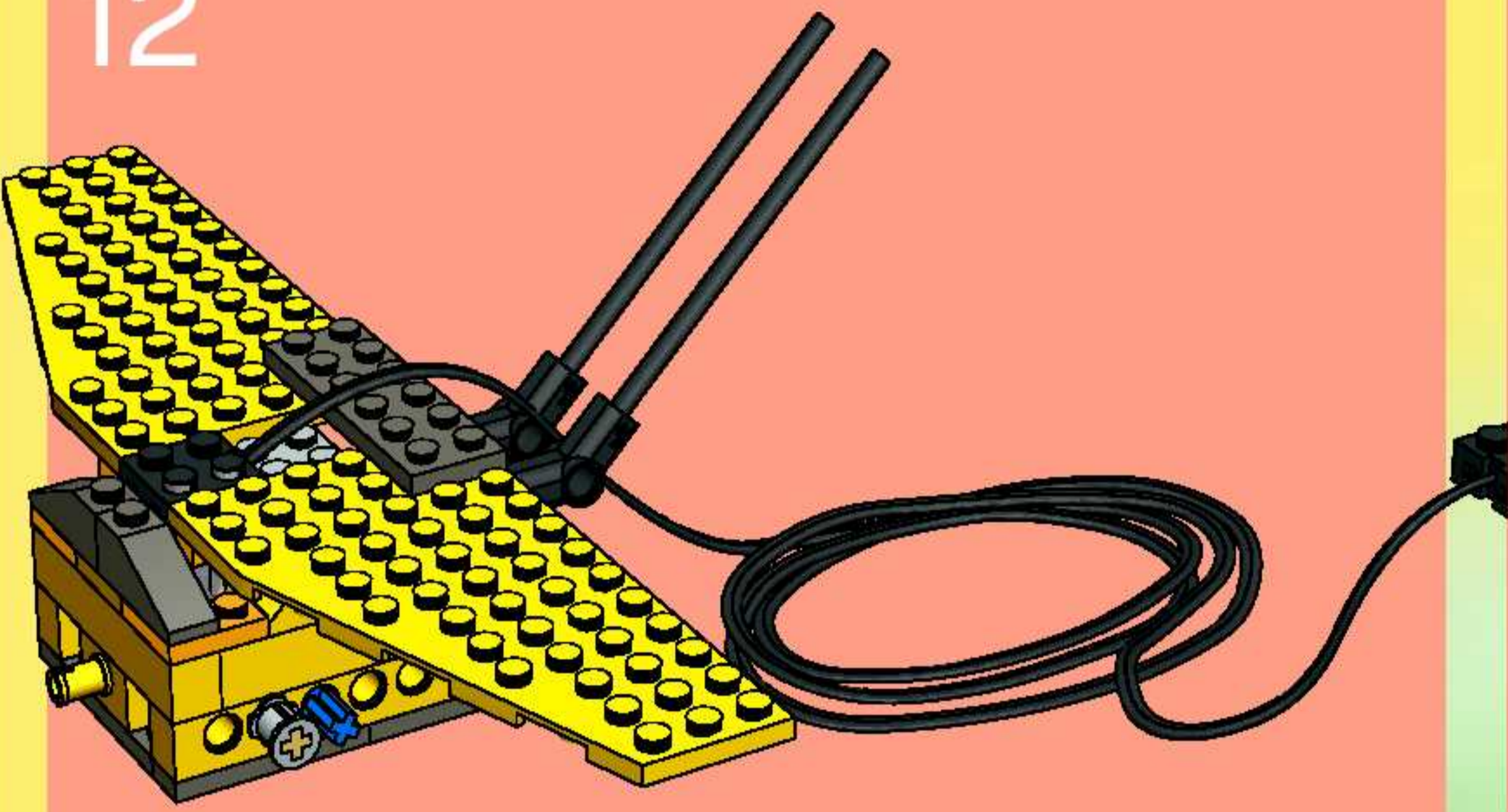

13

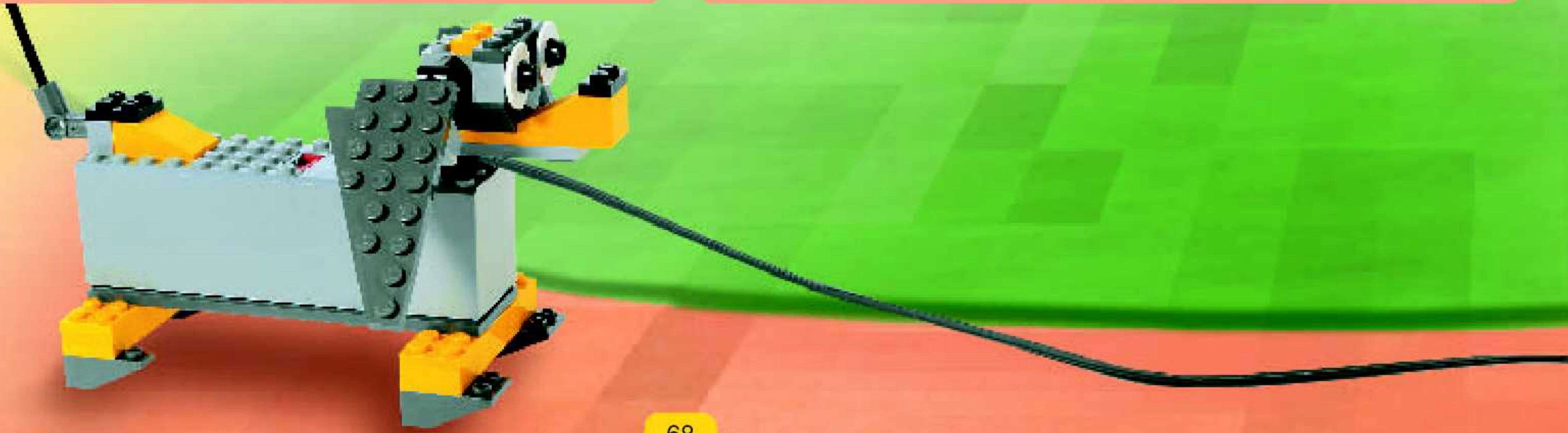
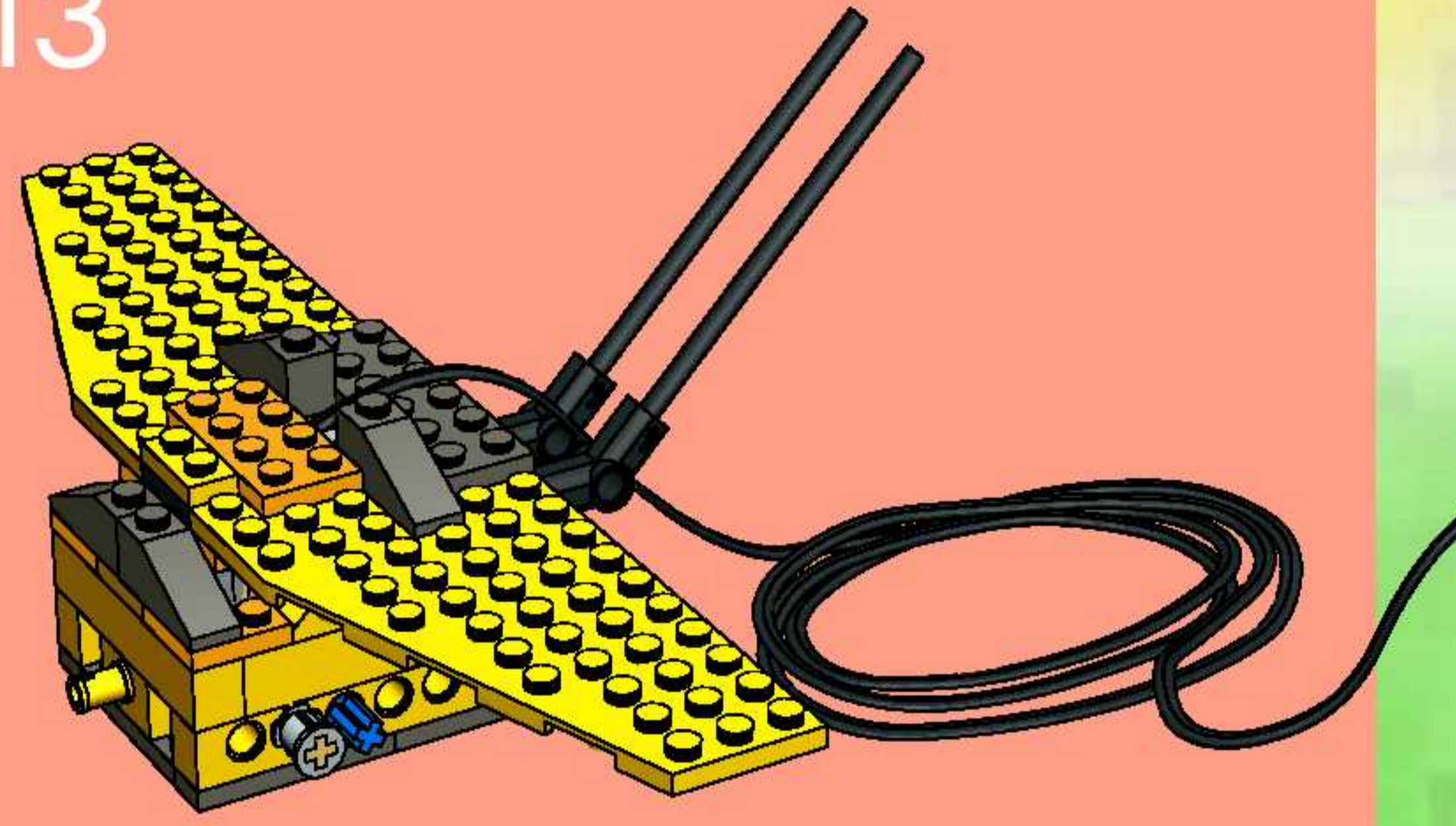



1x



1x

14



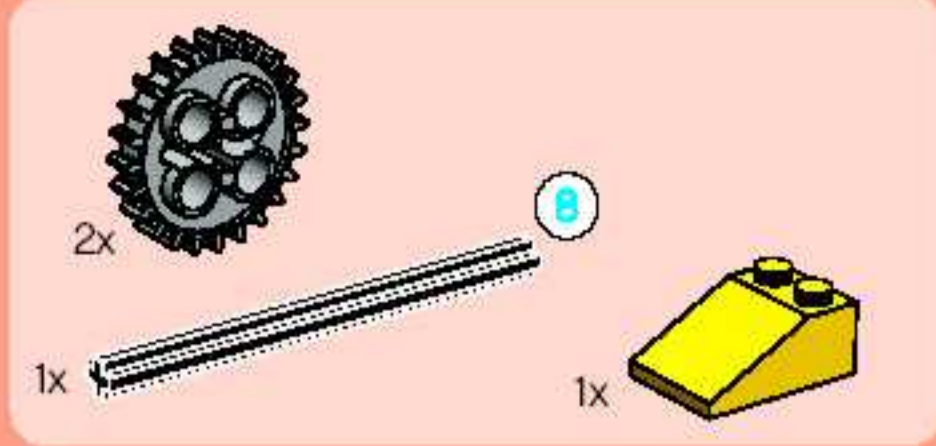

15

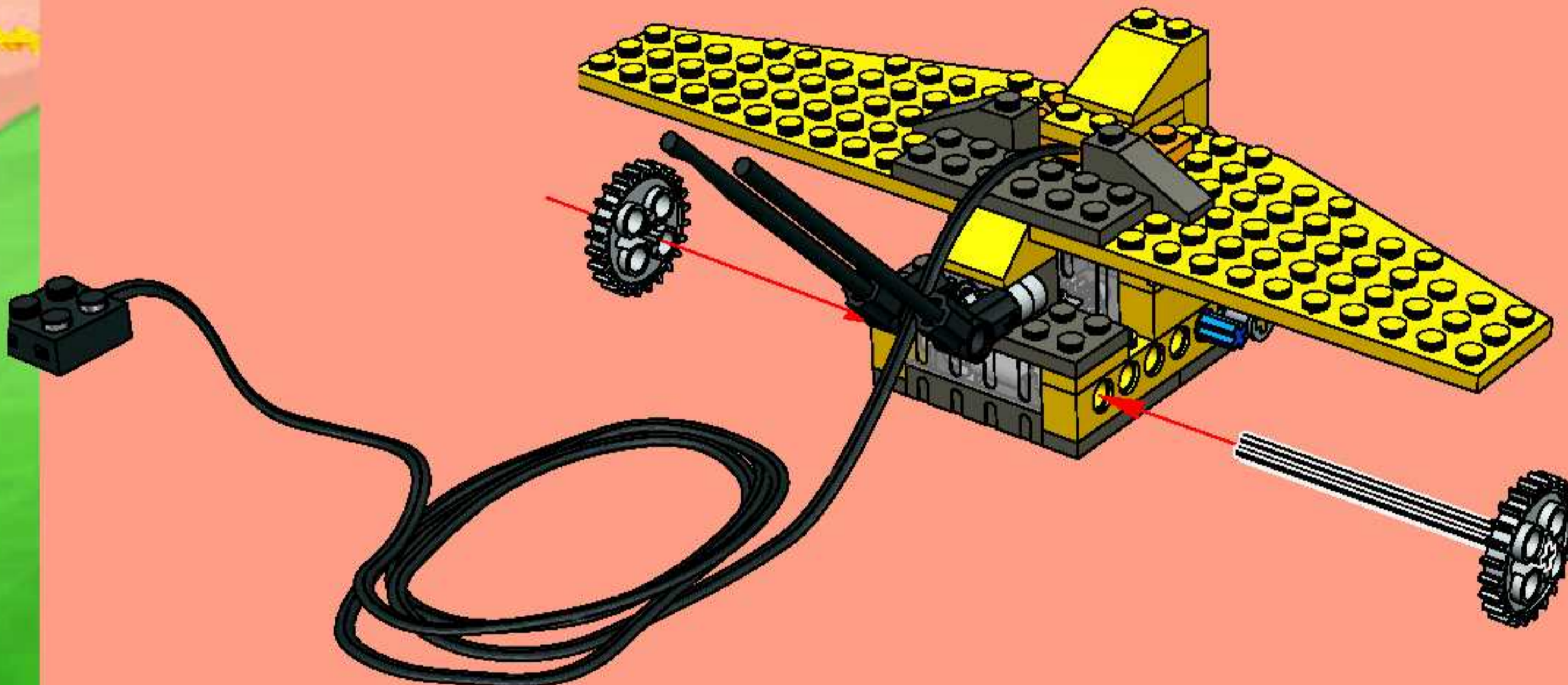
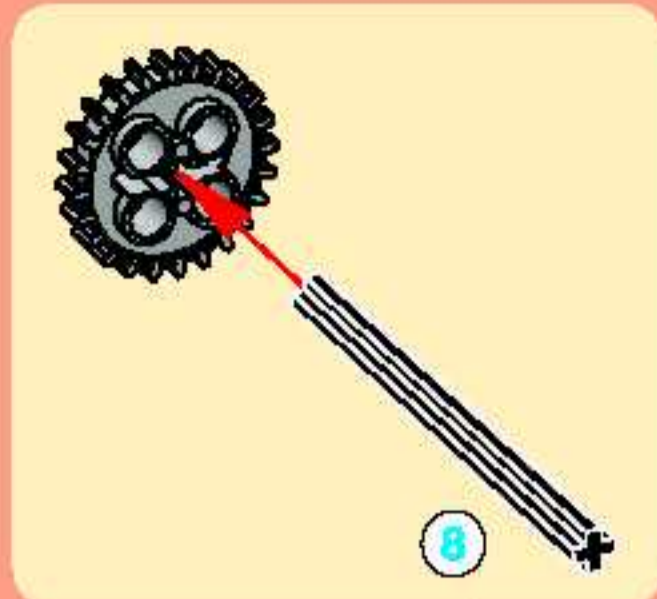

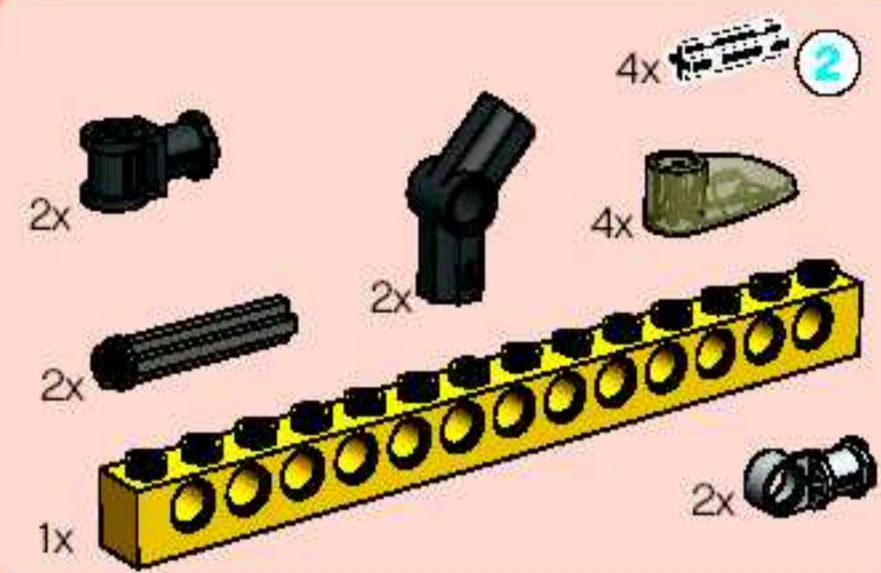

16

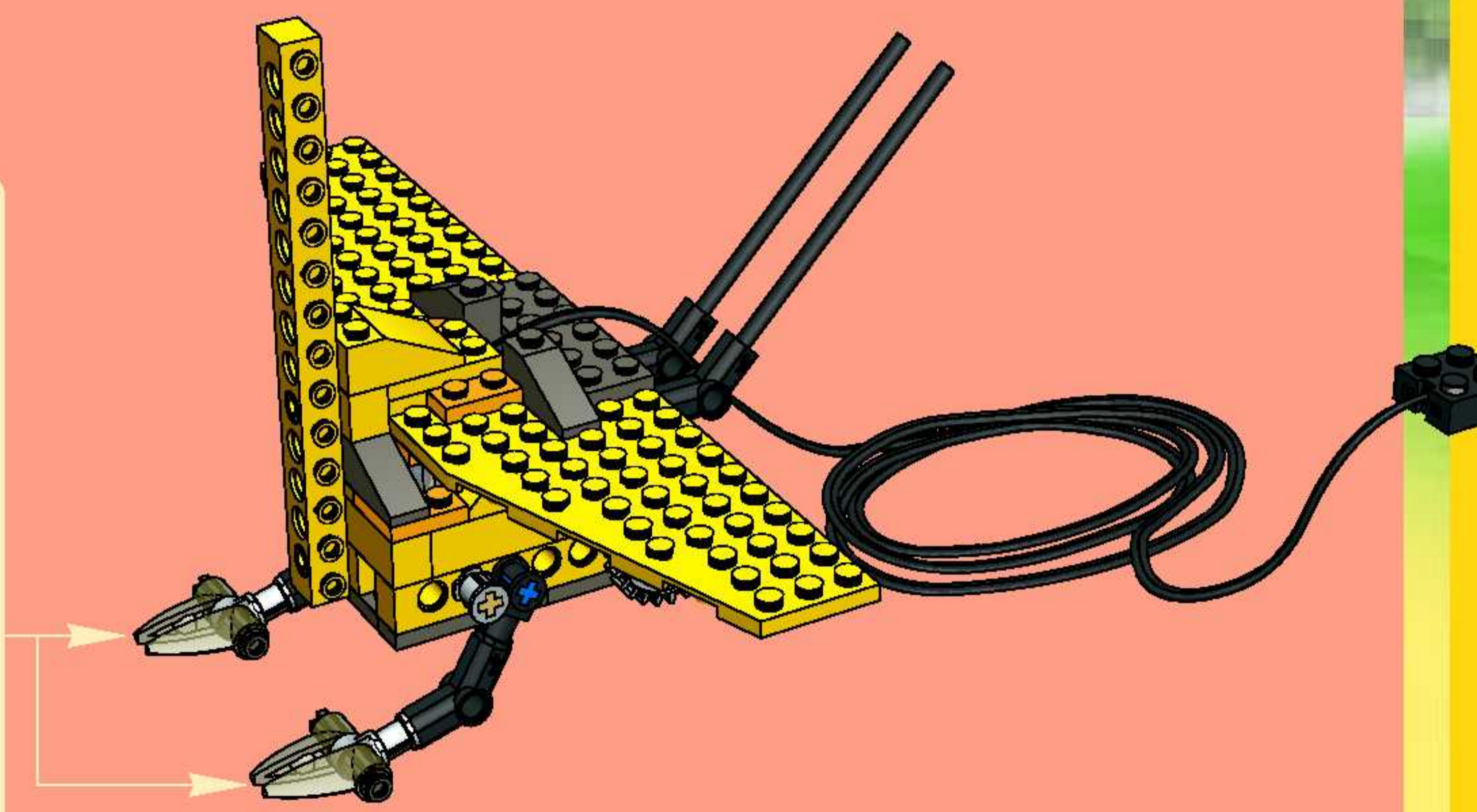
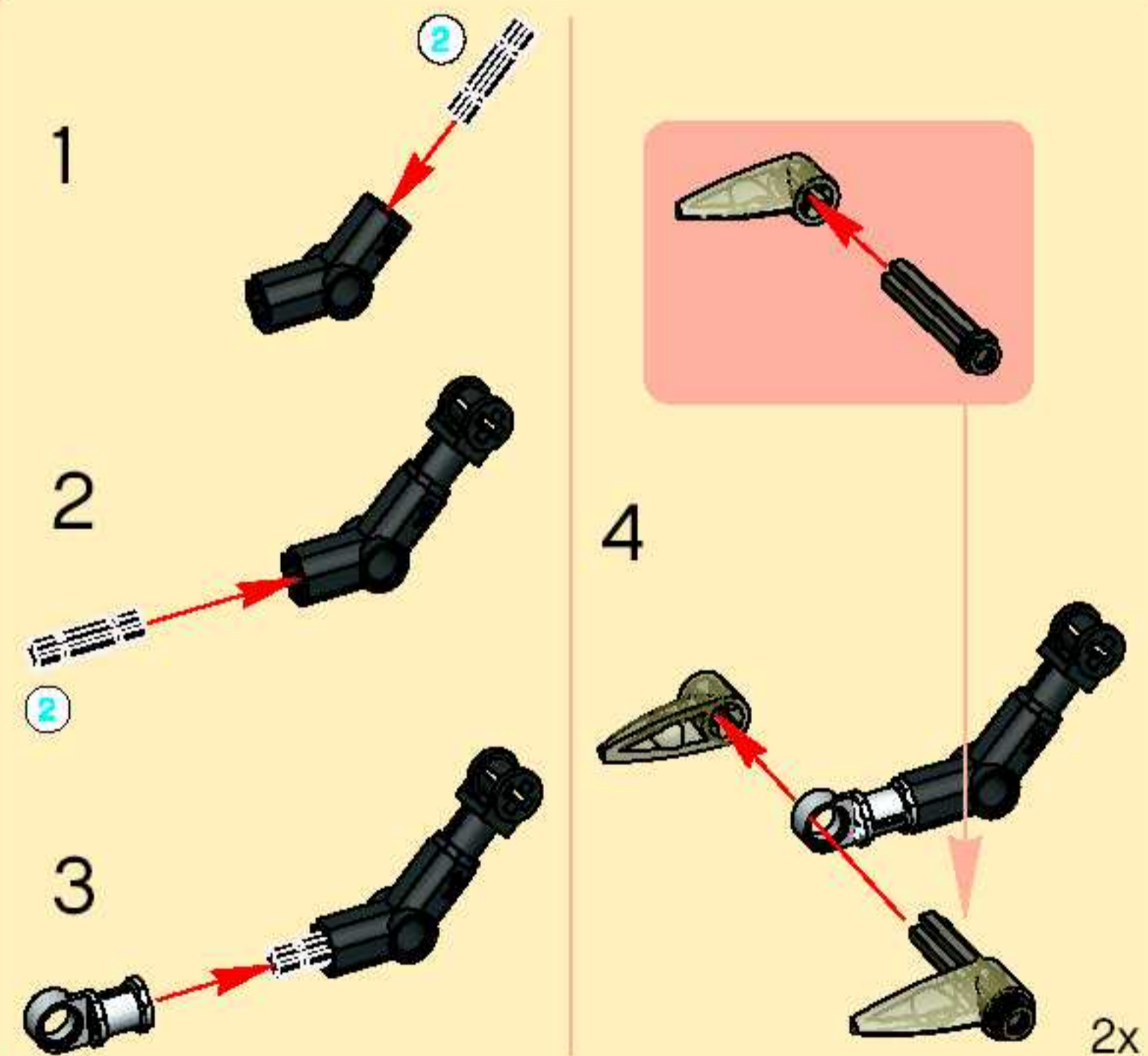



- 1x black 1x4 Technic brick
- 2x yellow 1x4 Technic brick with 4 holes
- 2x black 1x2 Technic brick
- 1x black 1x2 Technic brick
- 2x yellow 1x2 Technic brick with 2 holes
- 2x grey 1x2 Technic brick with 2 holes
- 1x yellow 1x6 Technic brick with 6 holes
- 2x grey 1x2 Technic axle pin
- 1x yellow 1x2 Technic wedge

# 17

<b>1</b> 	<b>4</b> 	<b>7</b> 
<b>2</b> 	<b>5</b> 	<b>8</b> 
<b>3</b> 	<b>6</b> 	



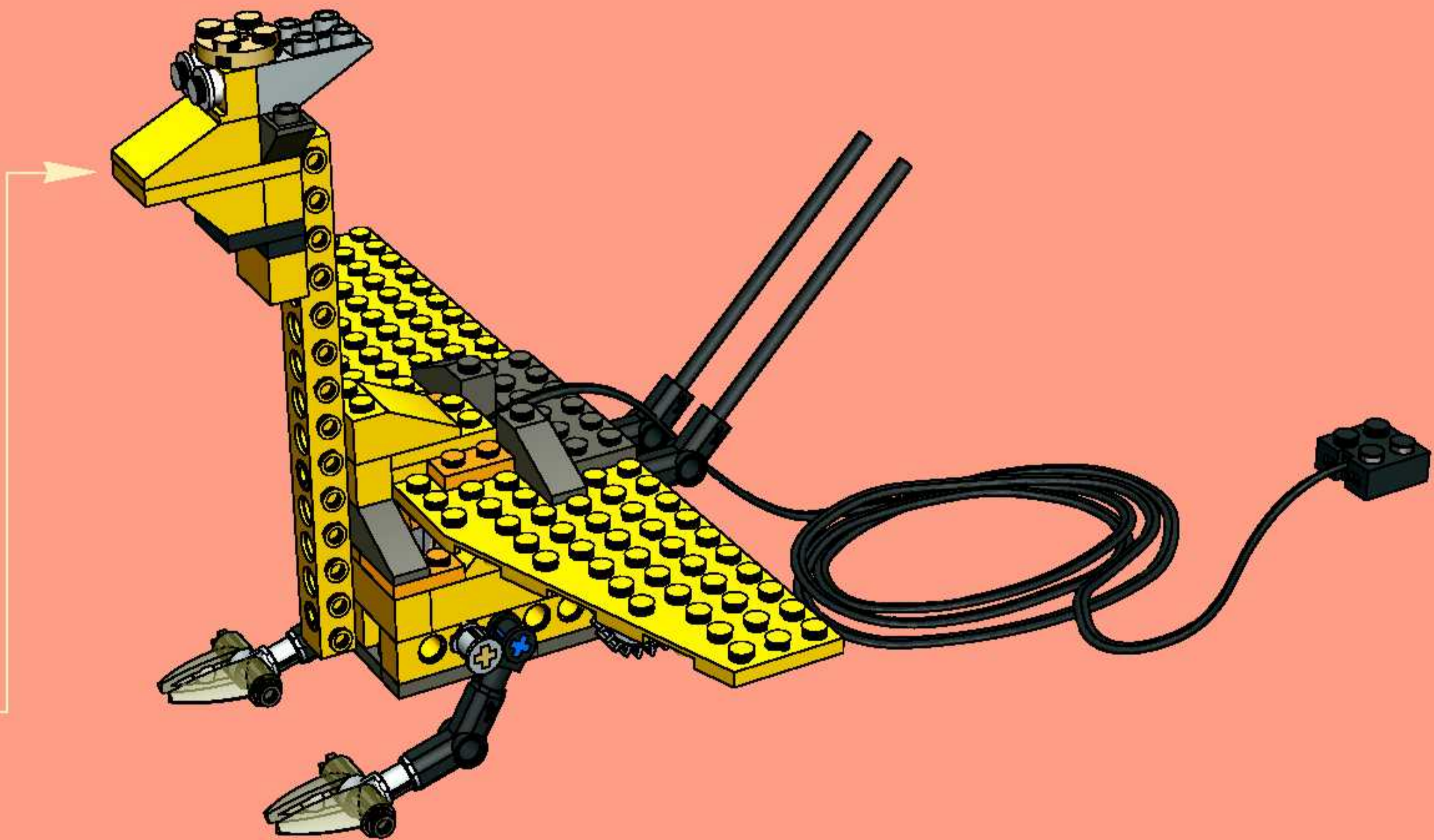

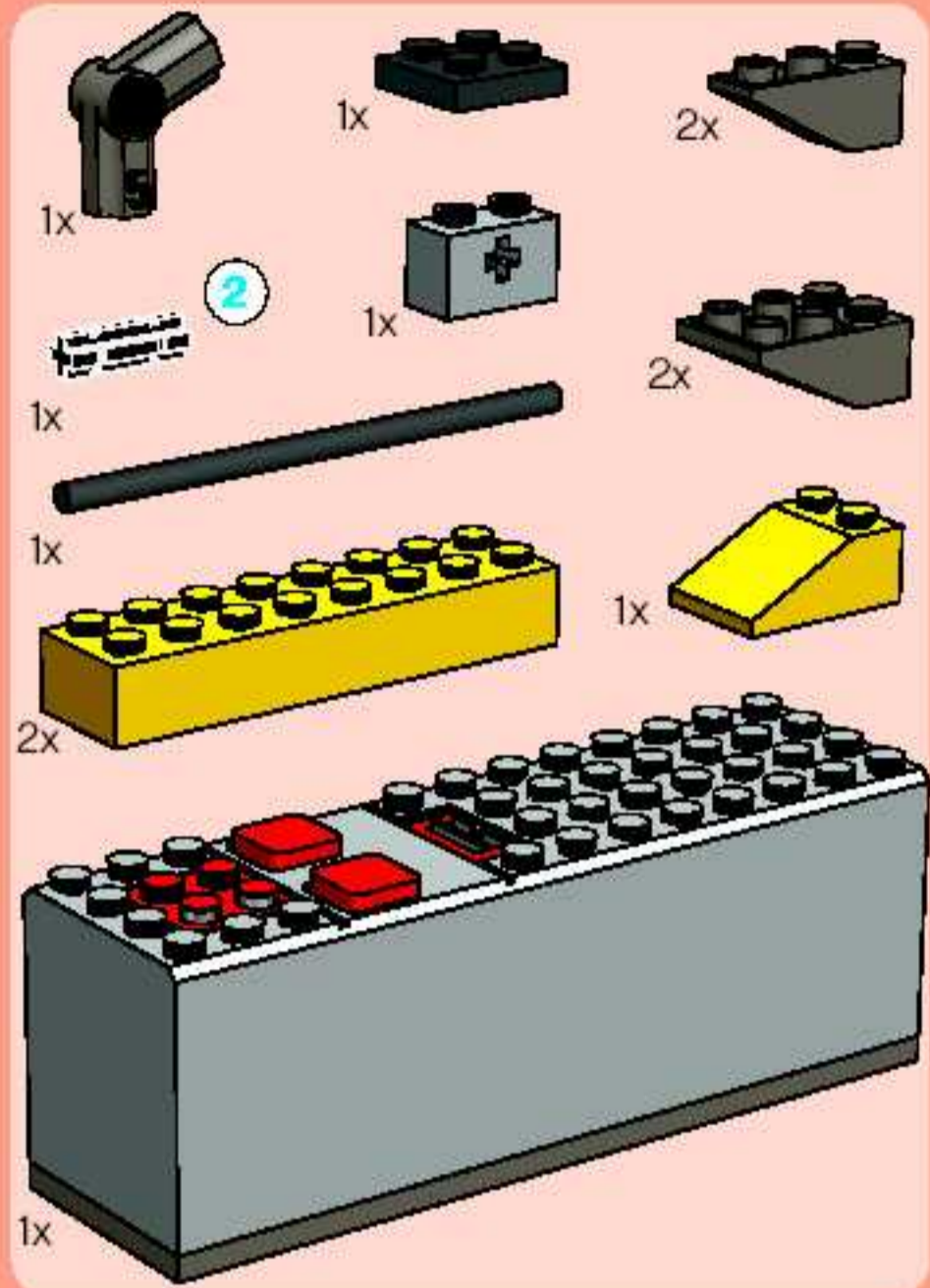

18

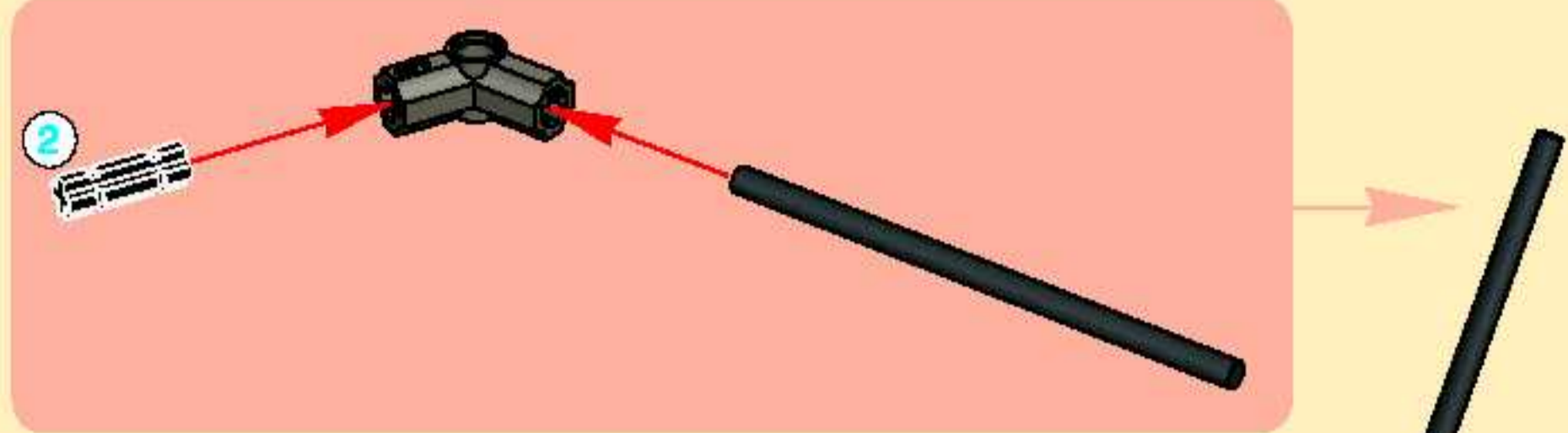
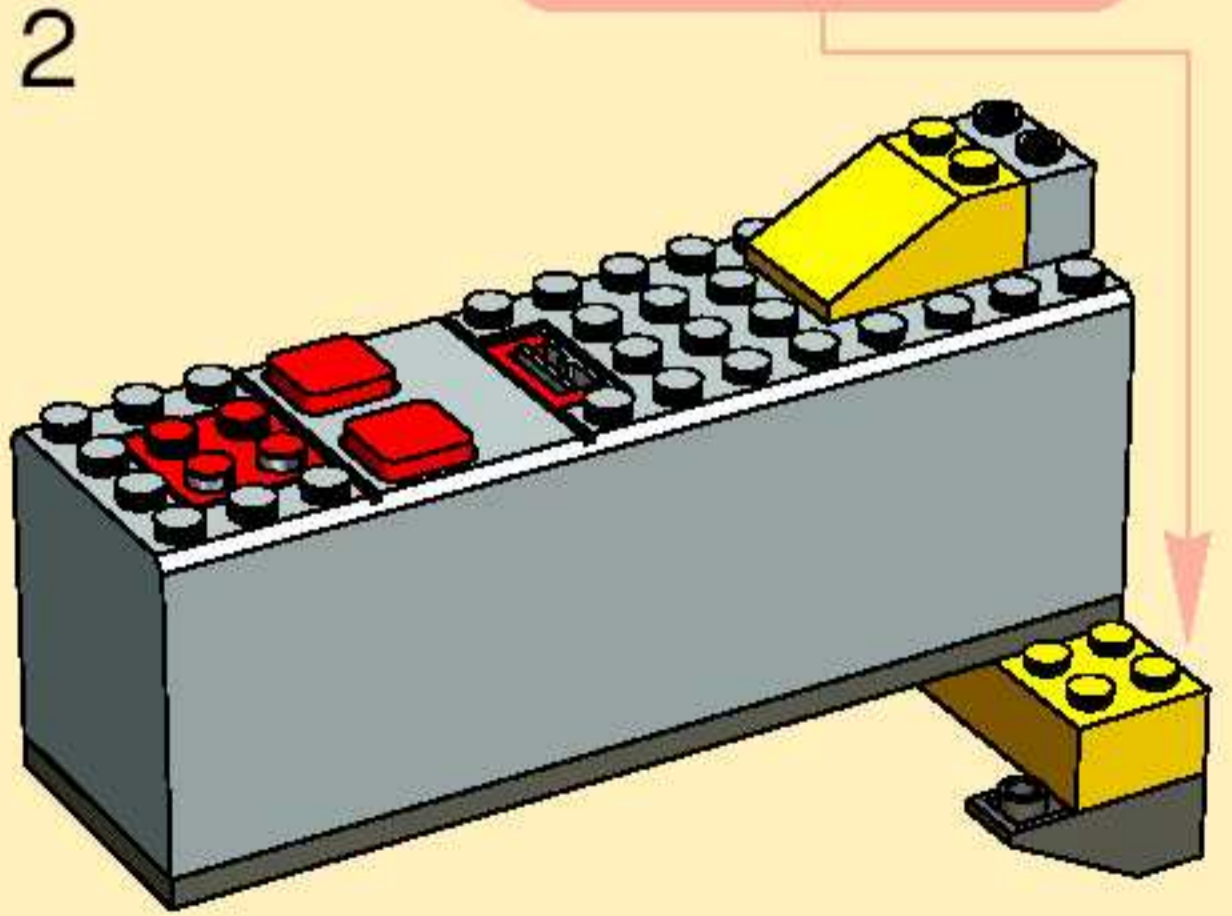
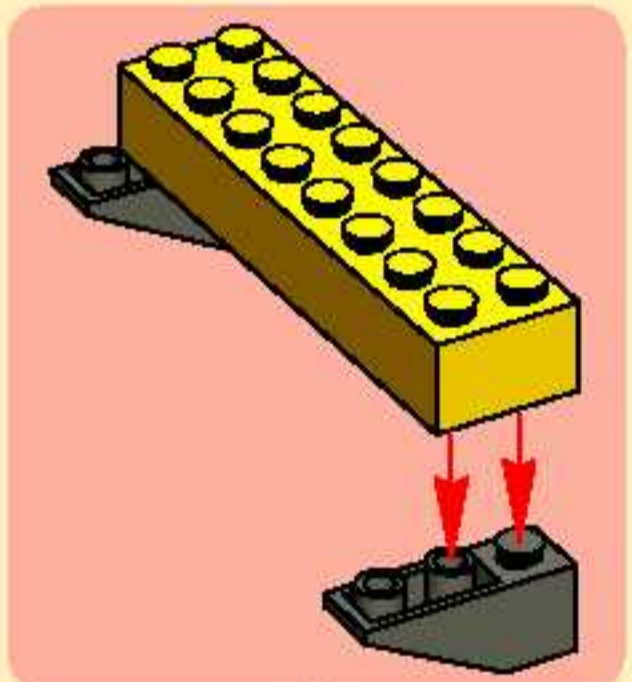
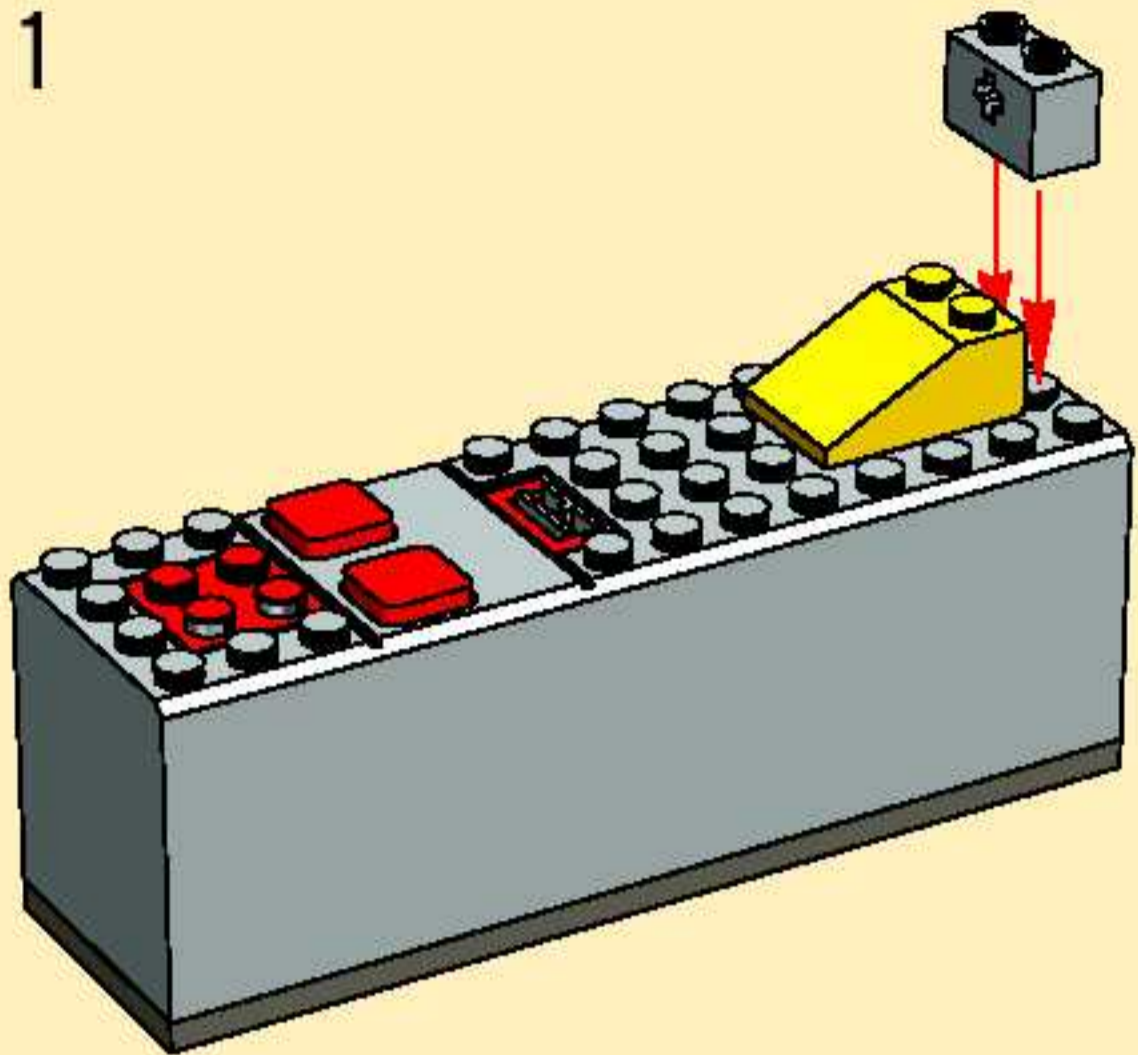
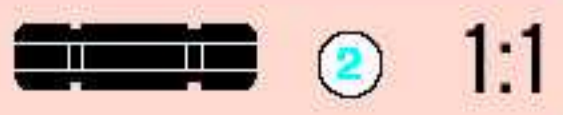

3

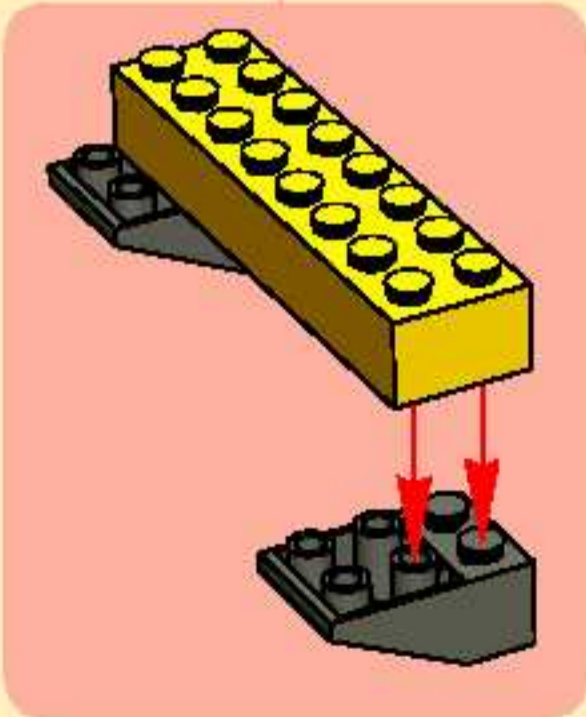
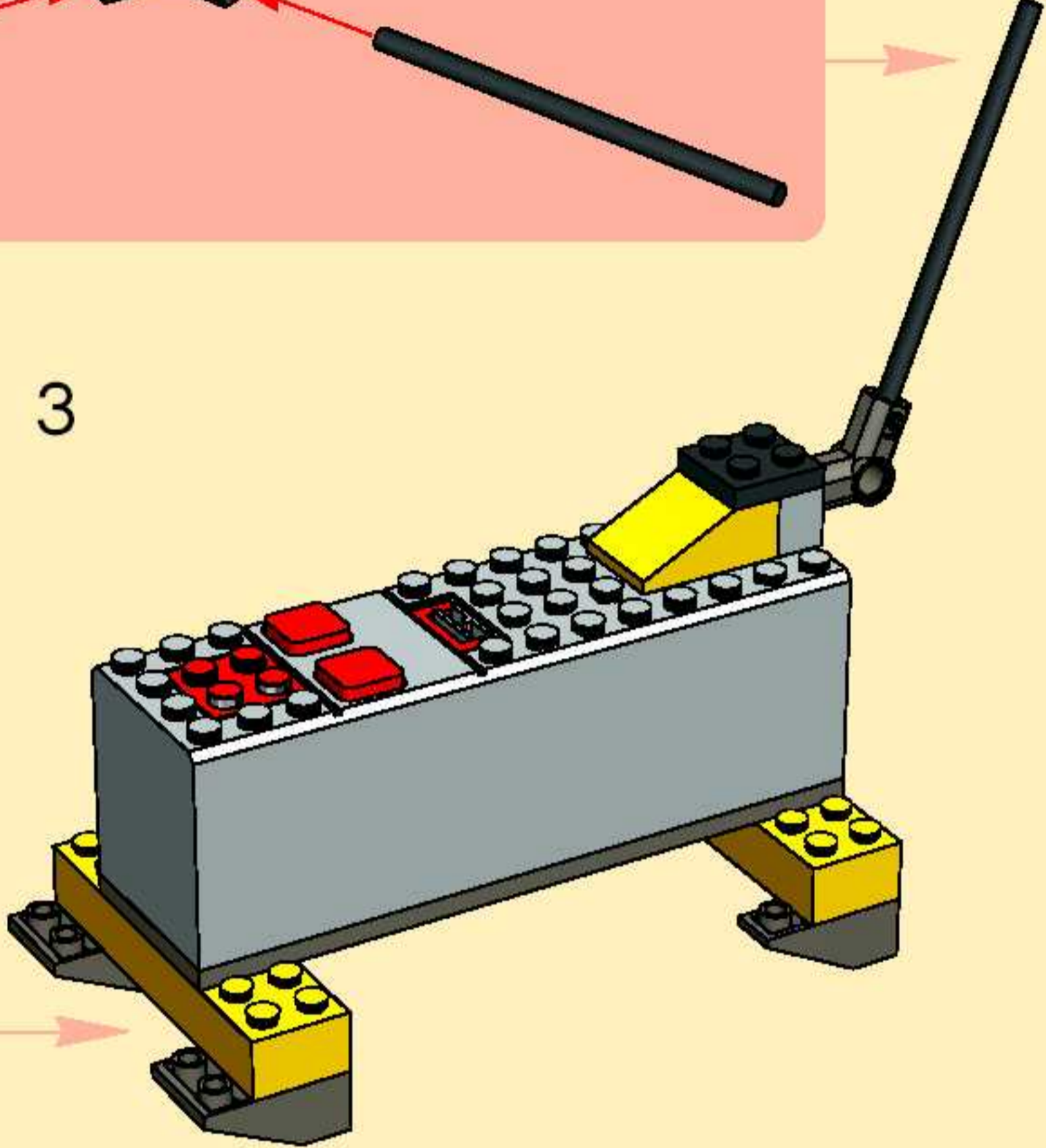

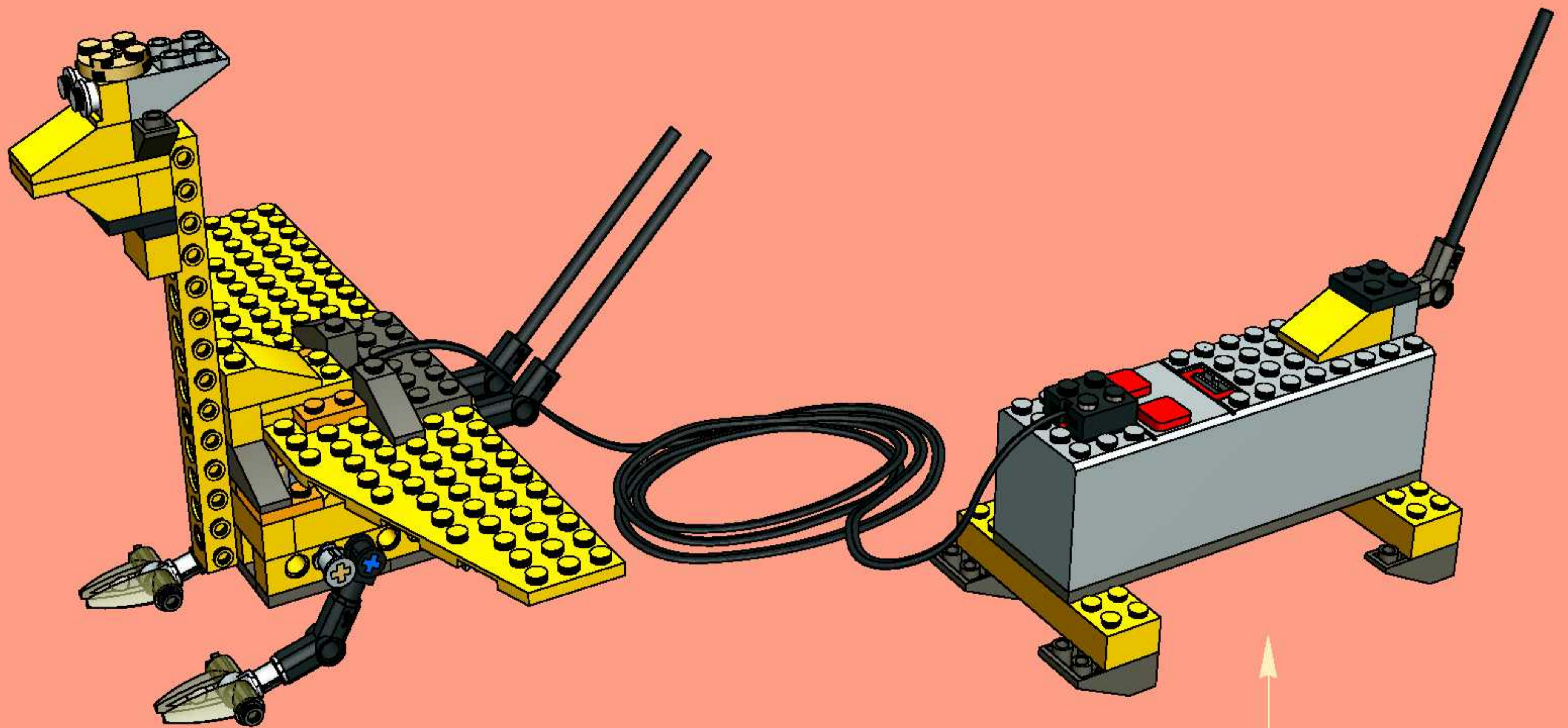



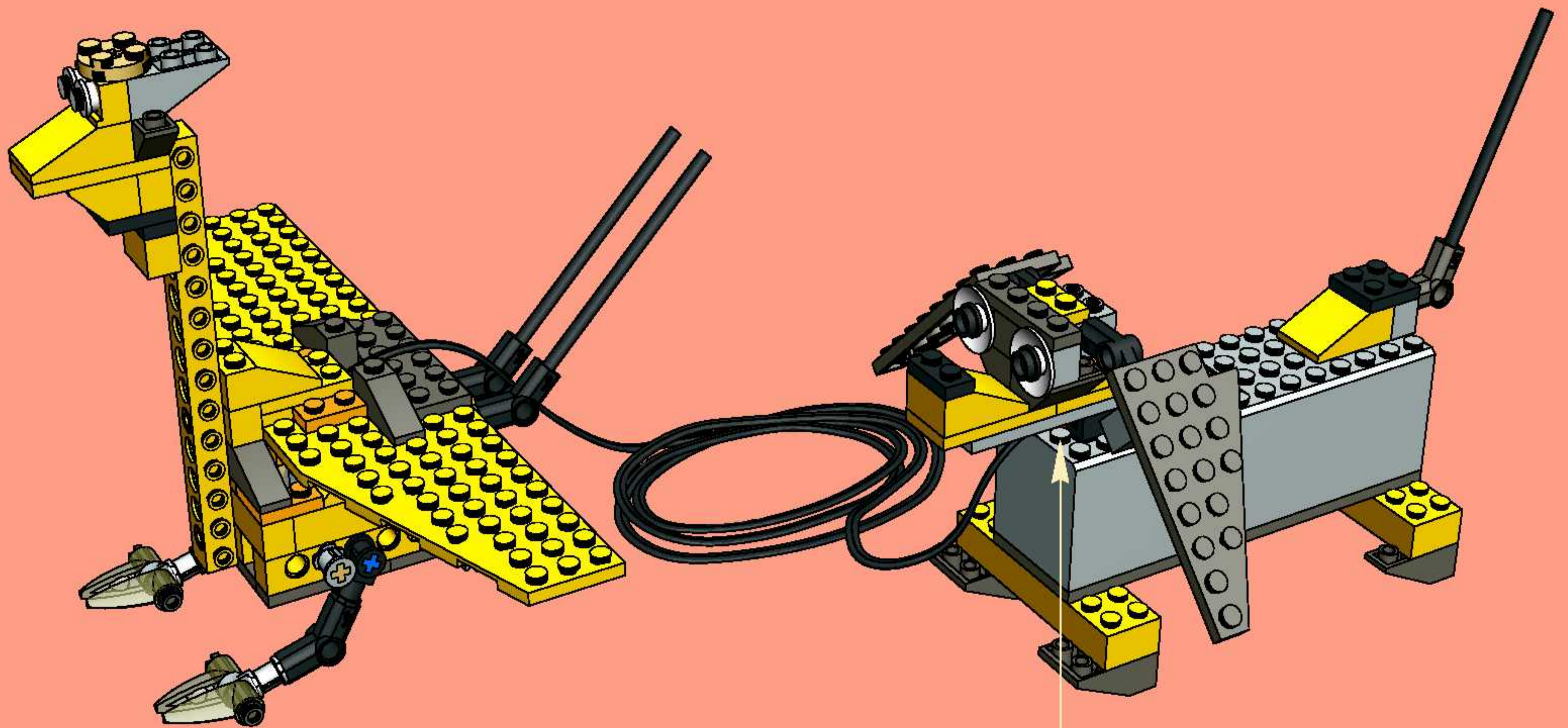

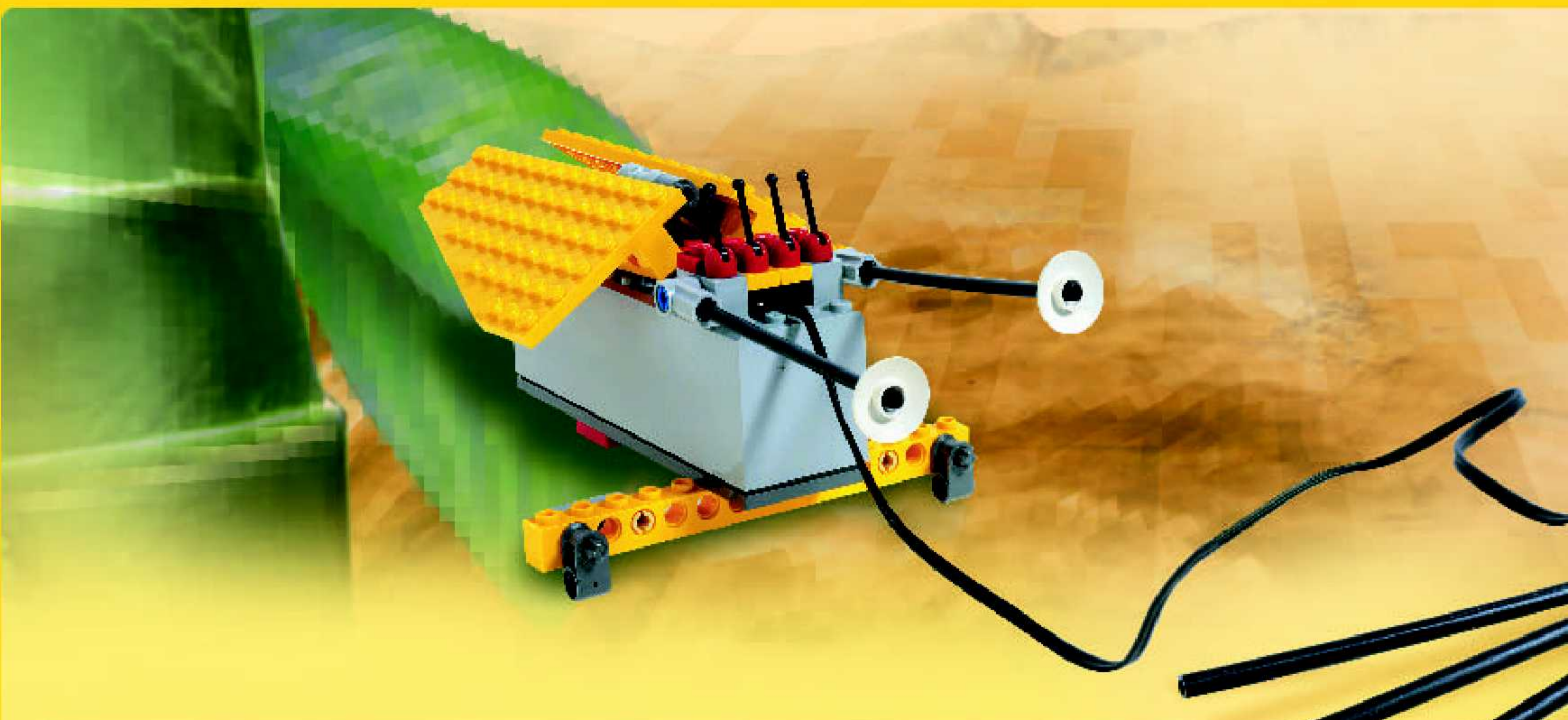



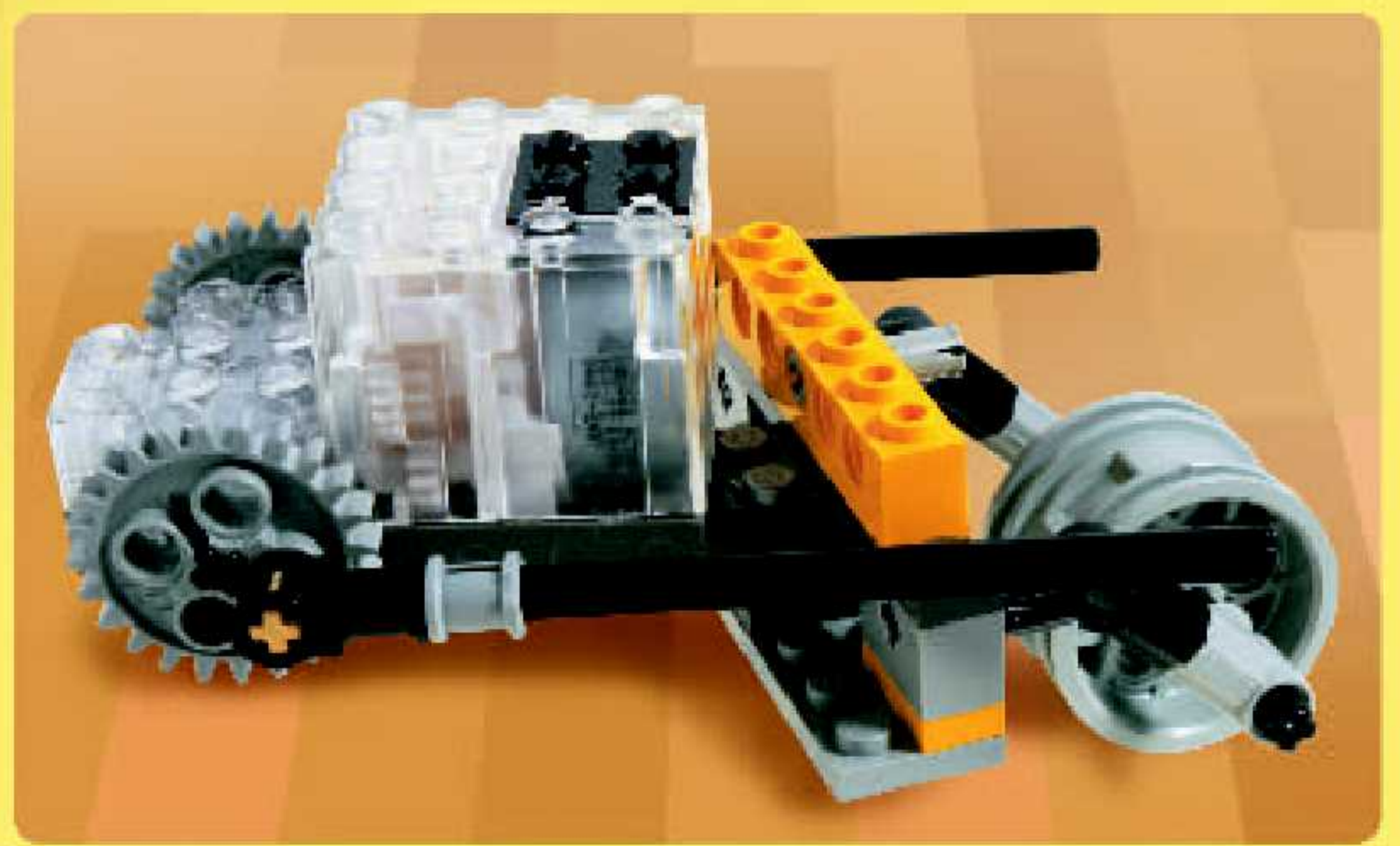



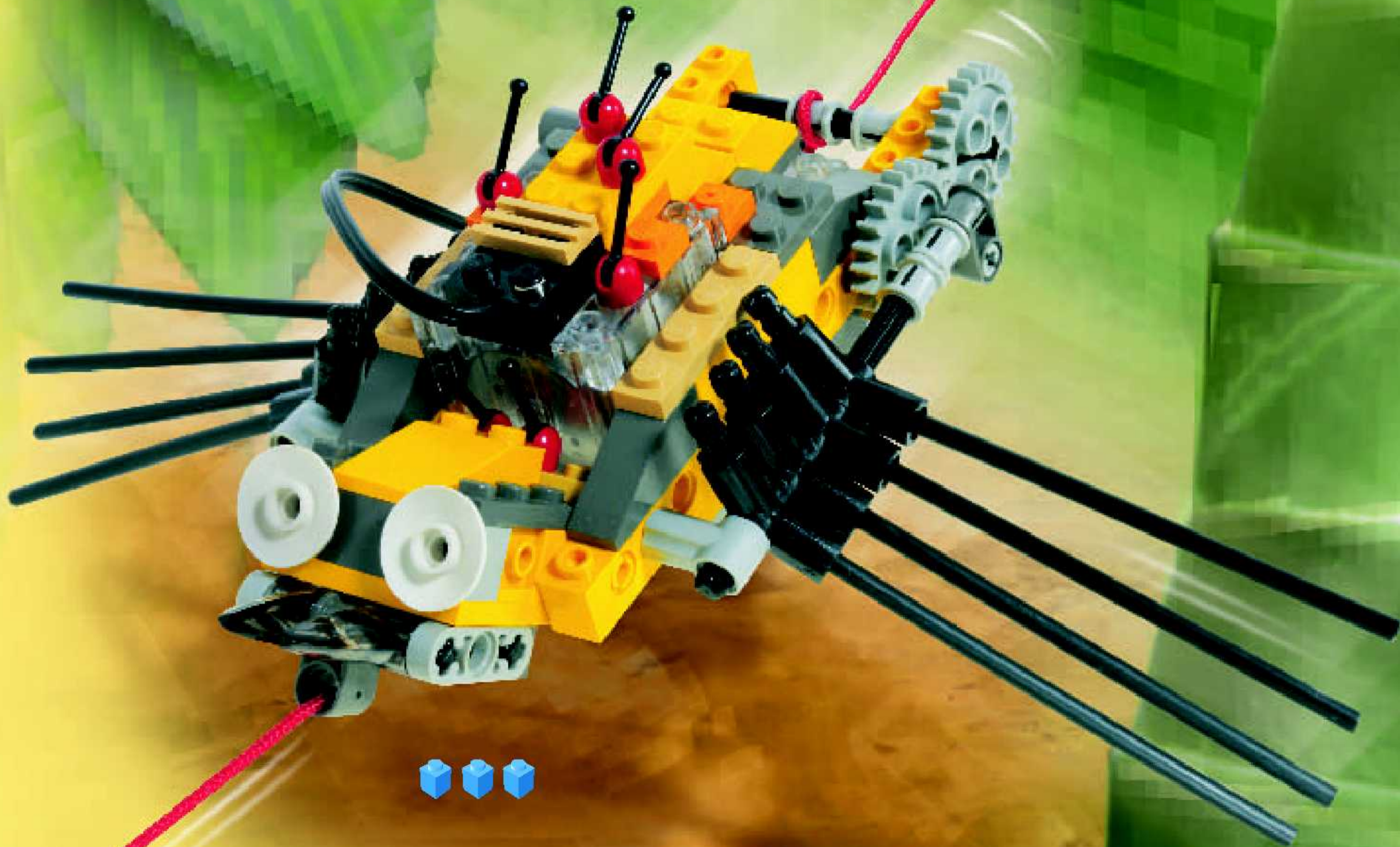

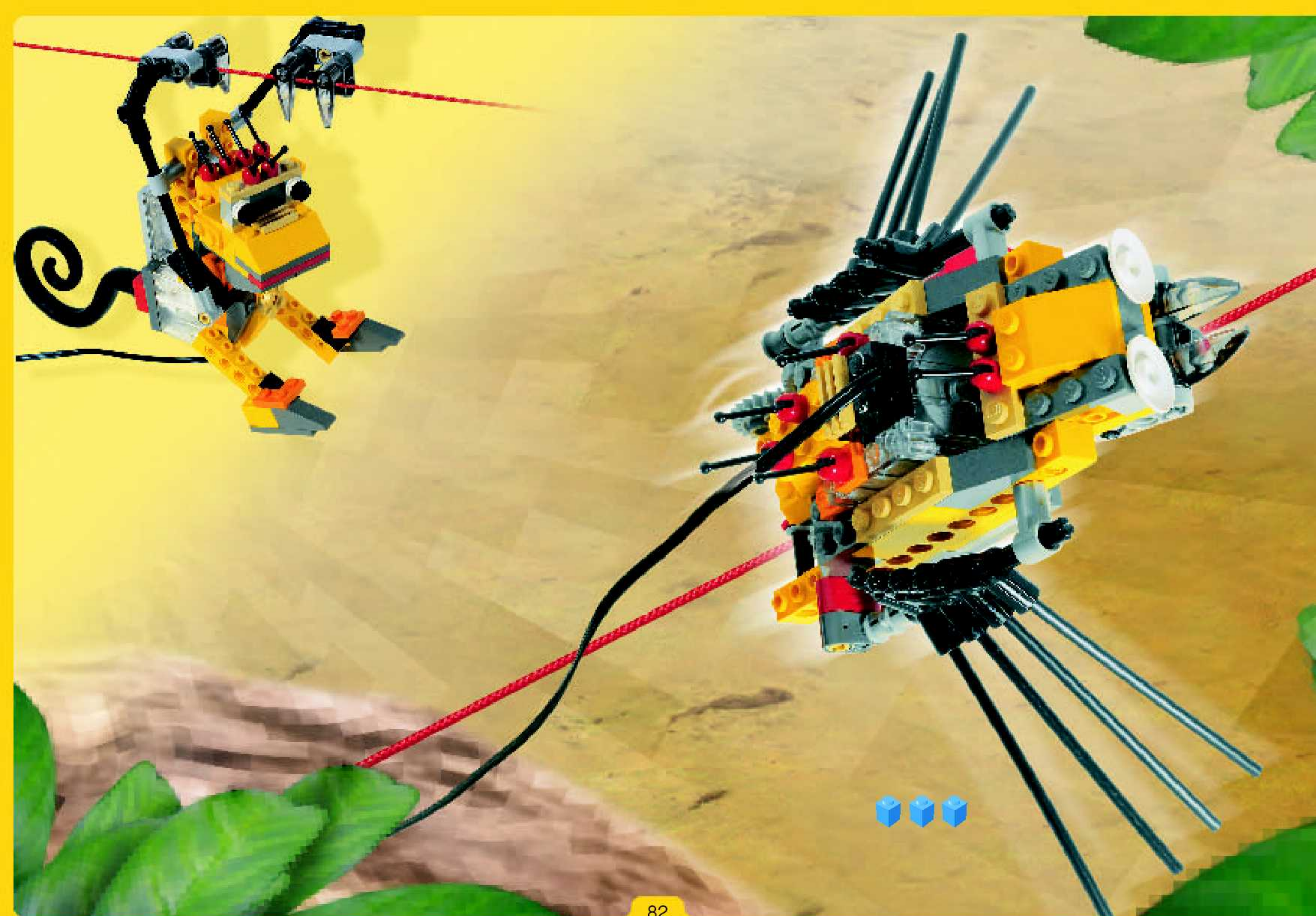

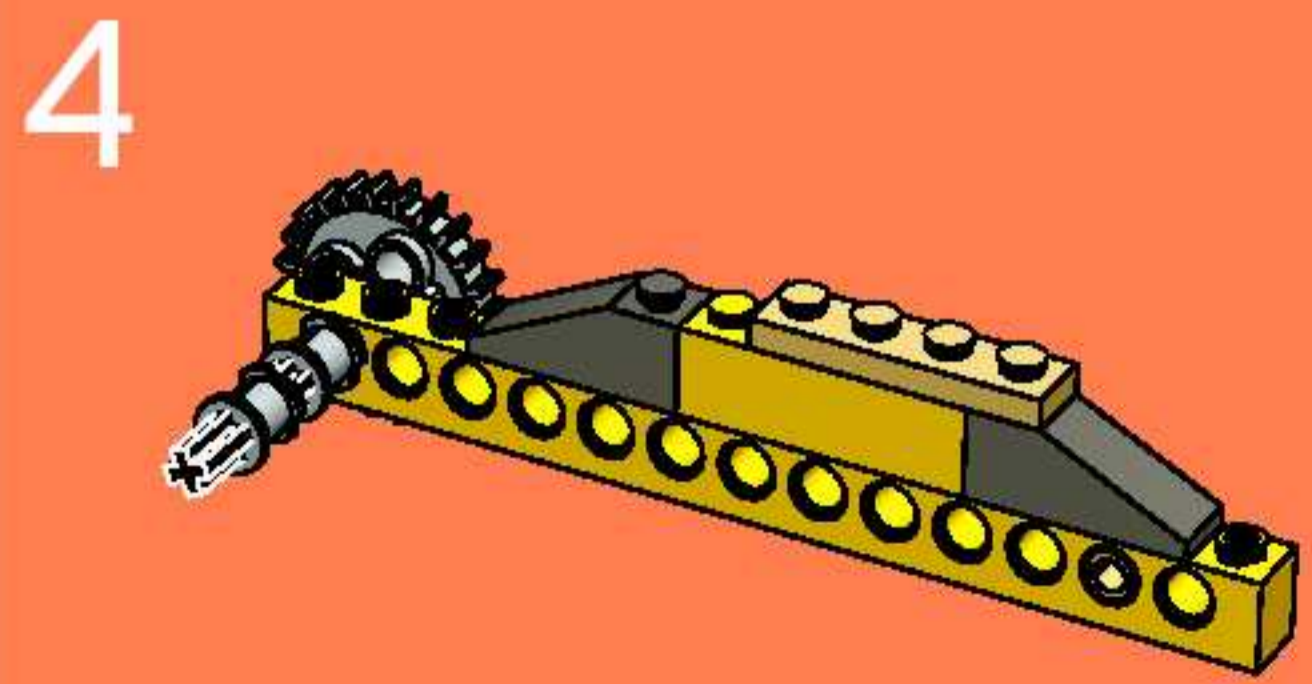
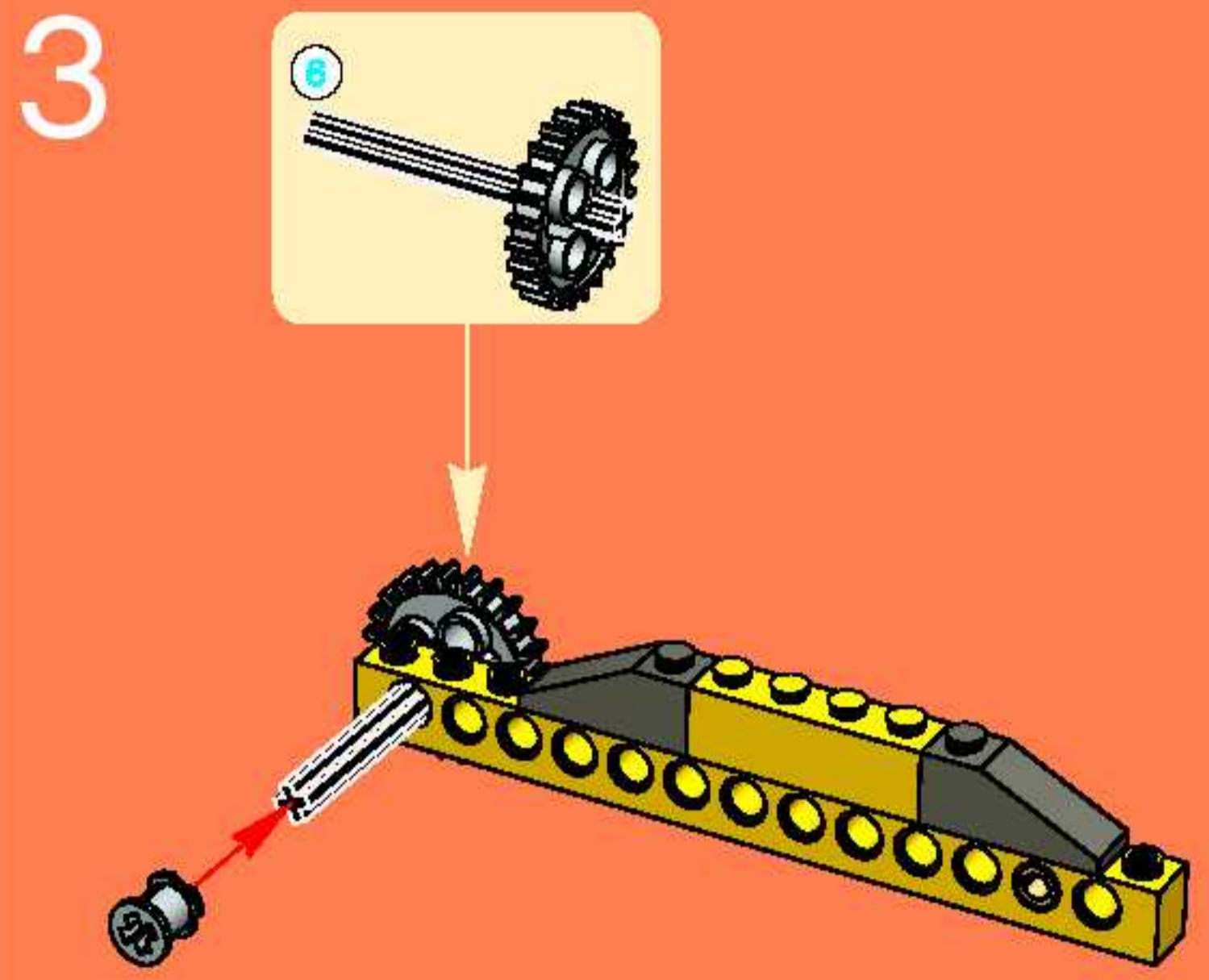
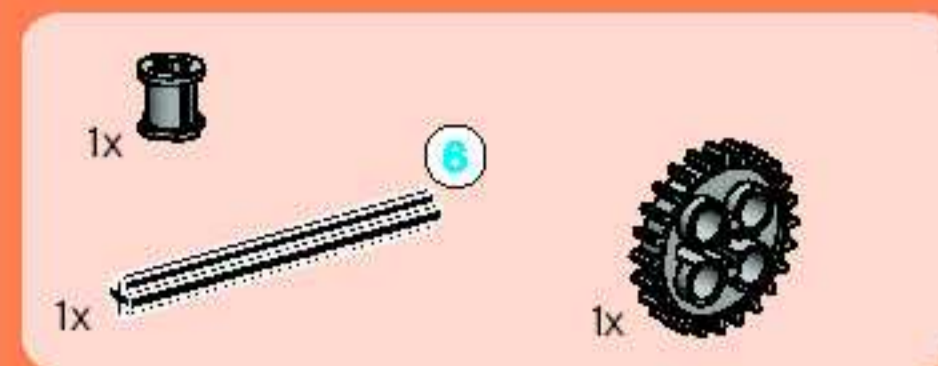
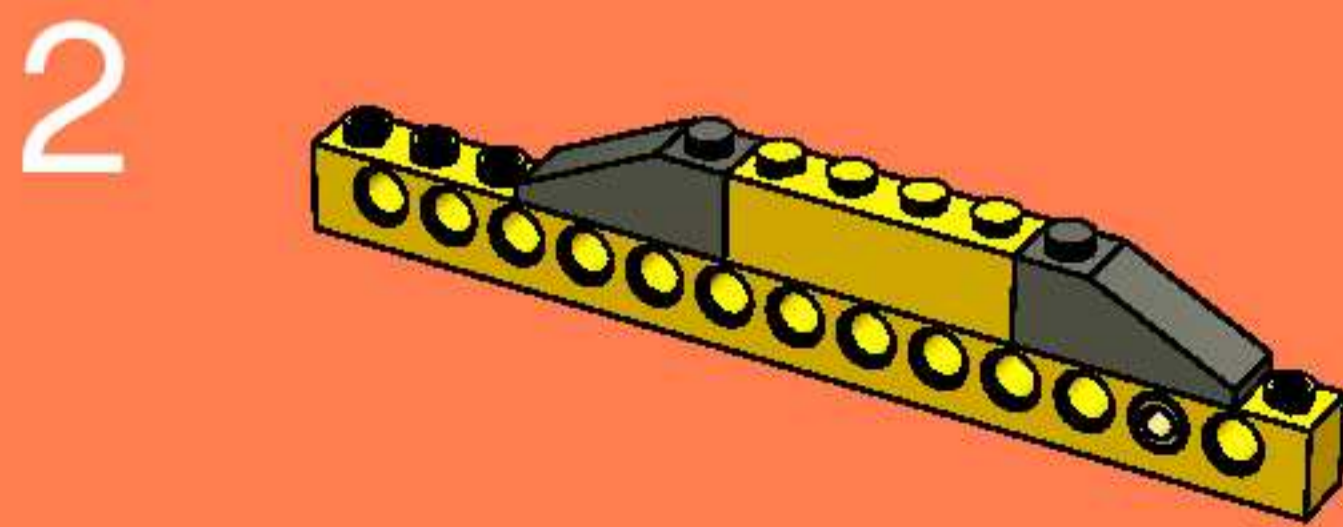
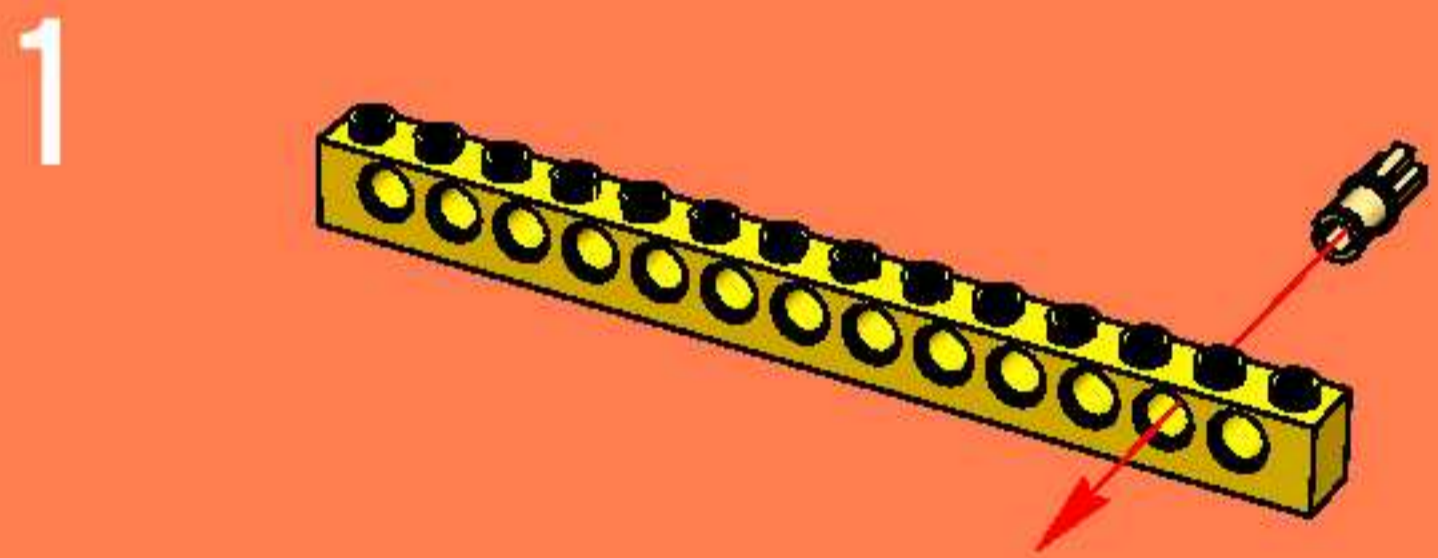
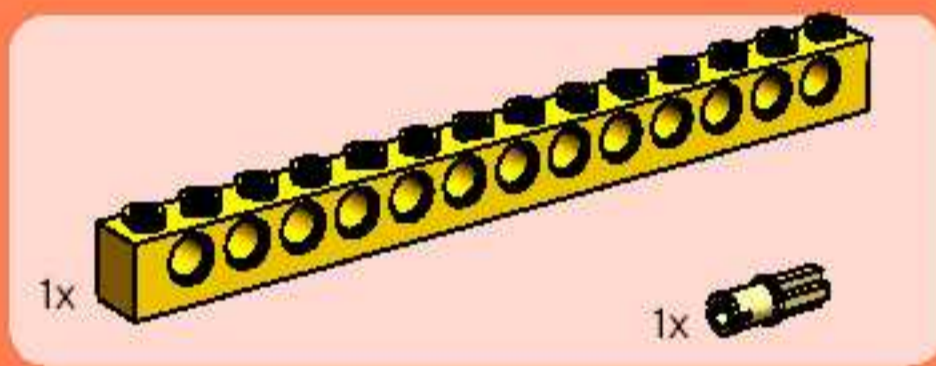
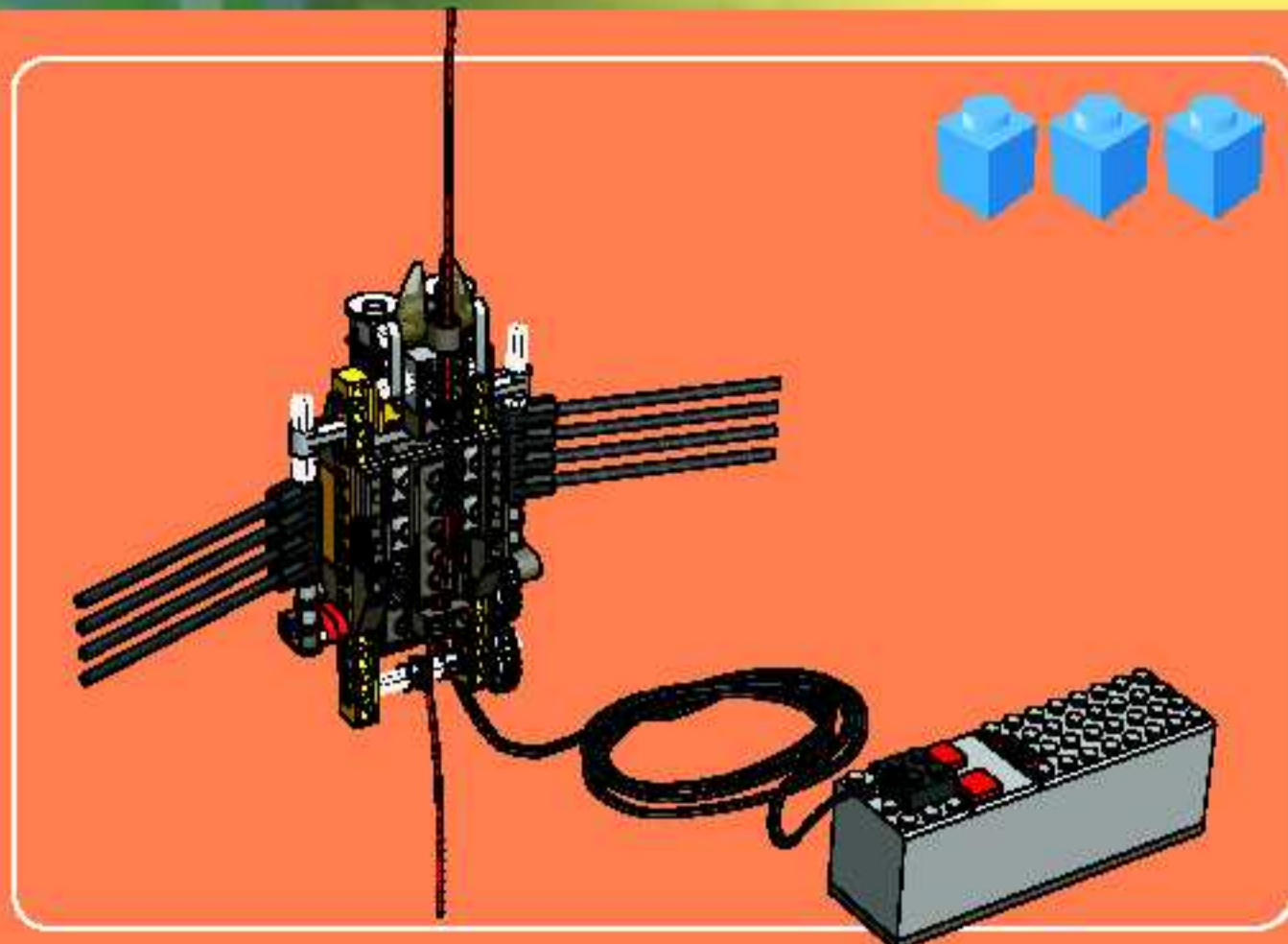



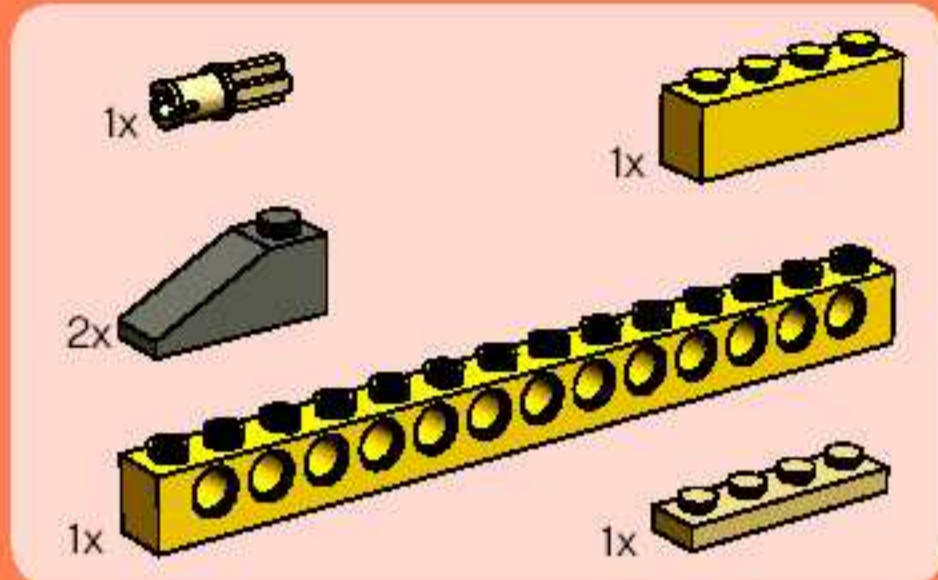

6

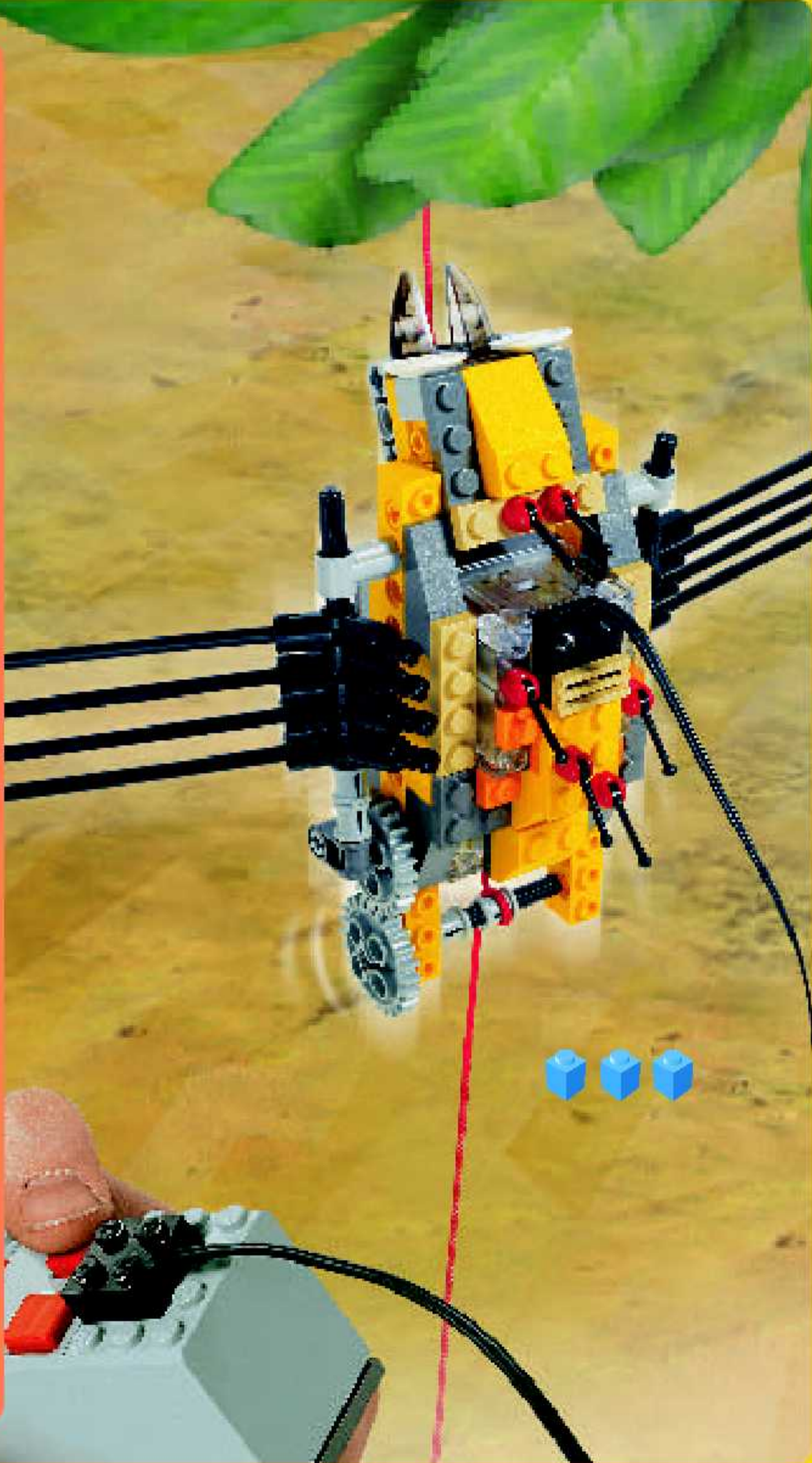
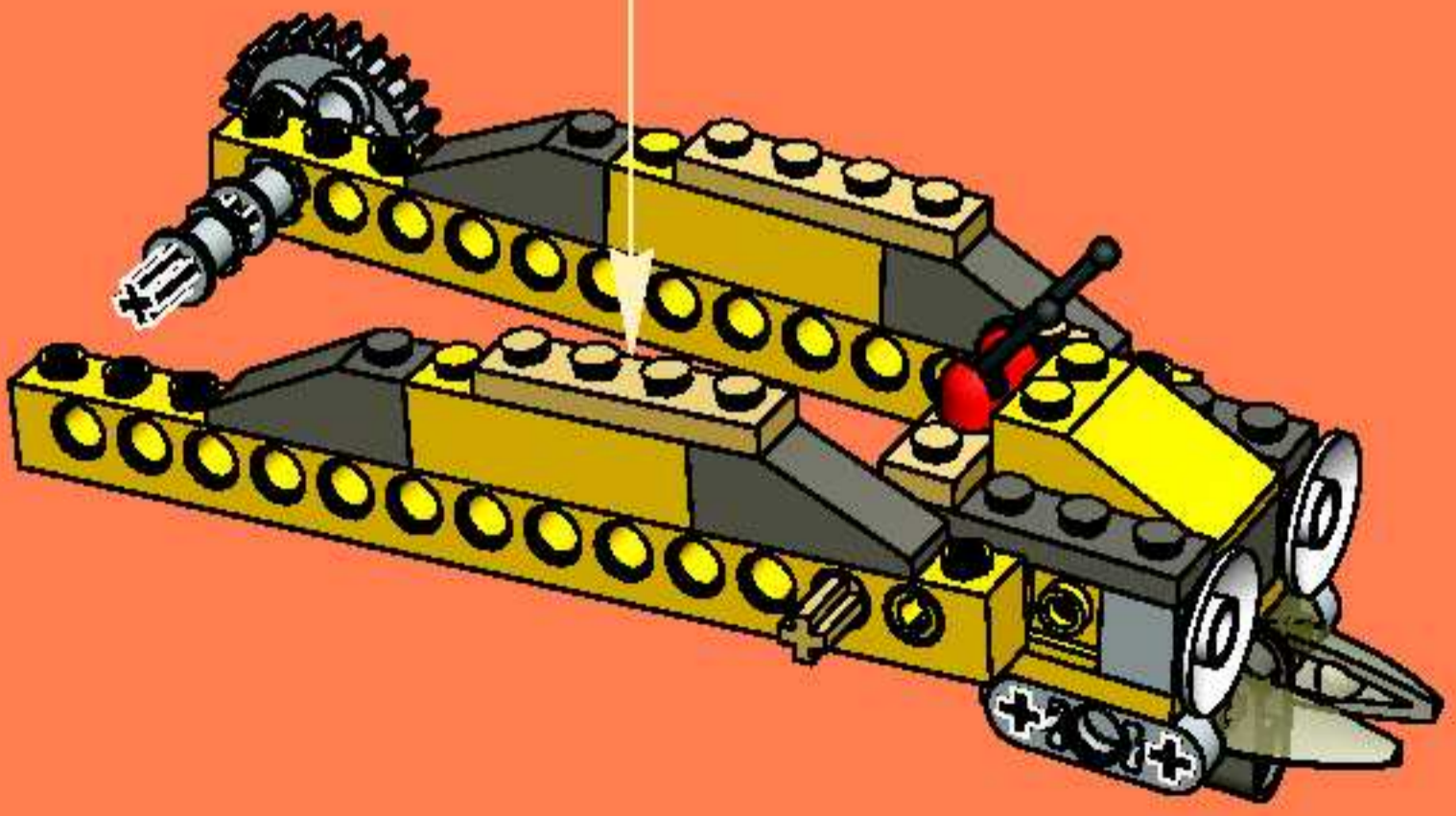
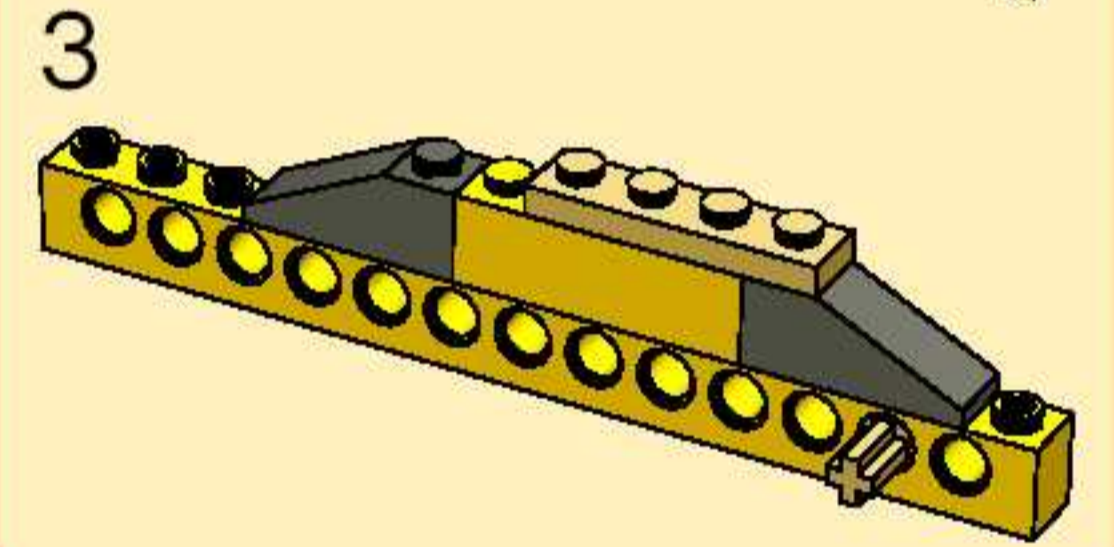
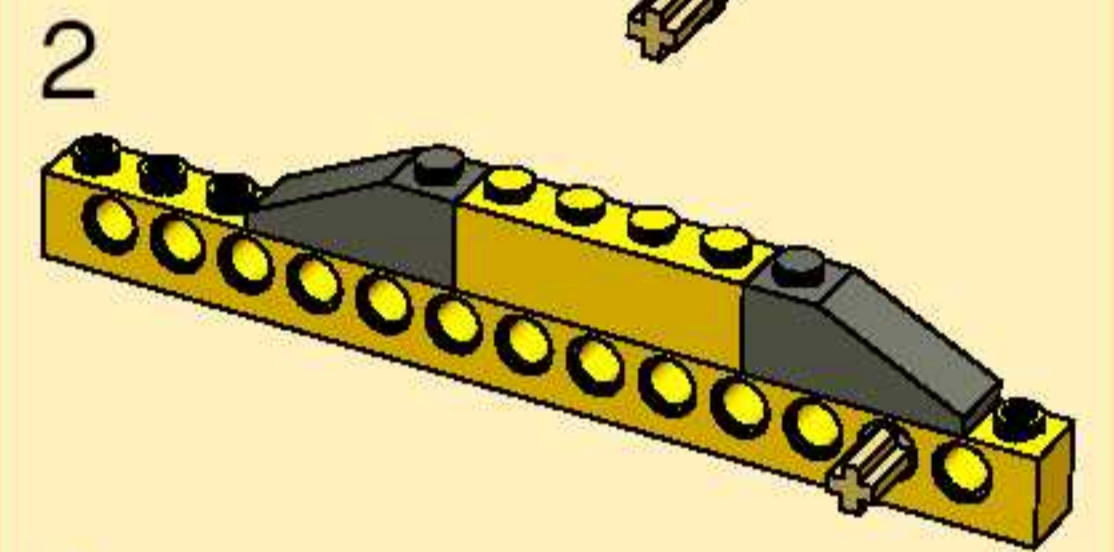
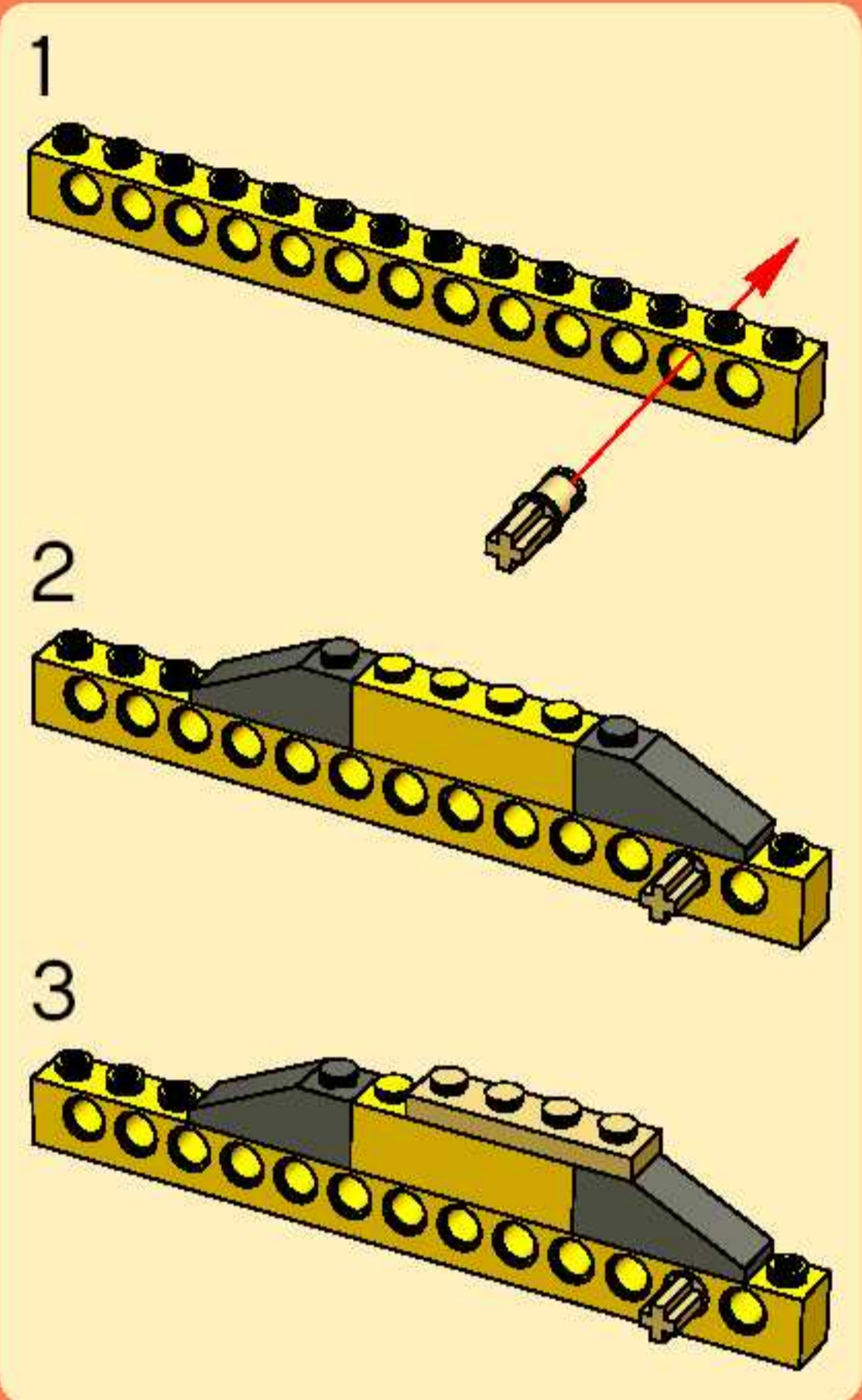

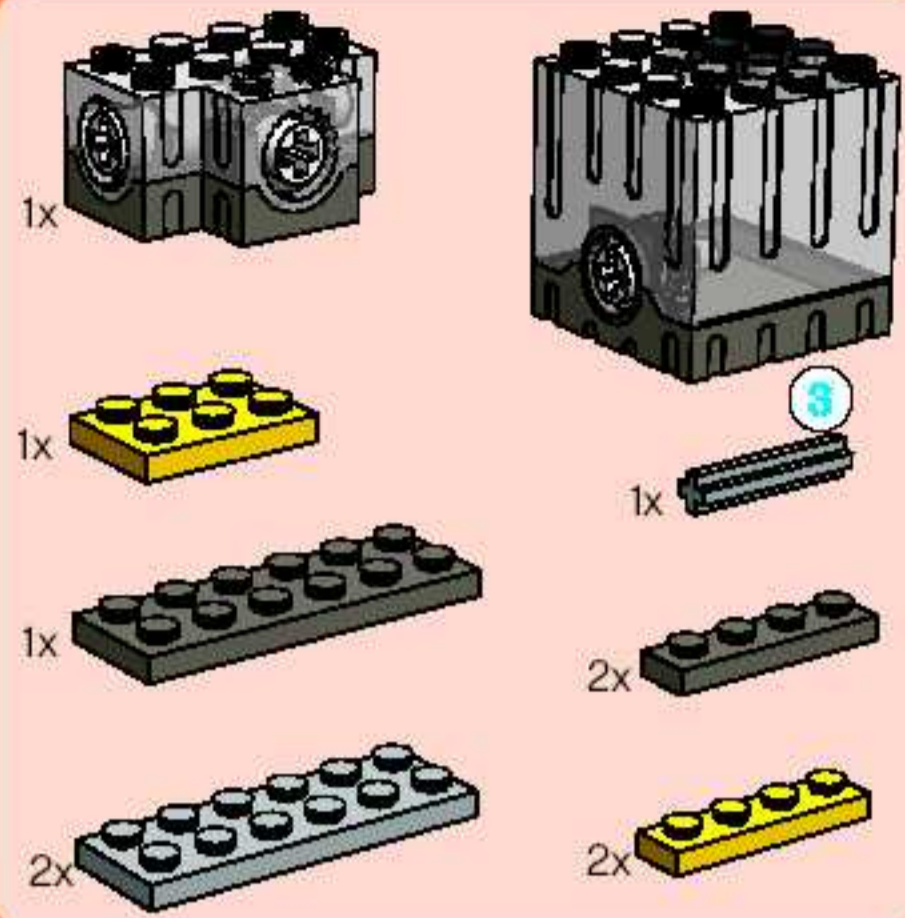

7

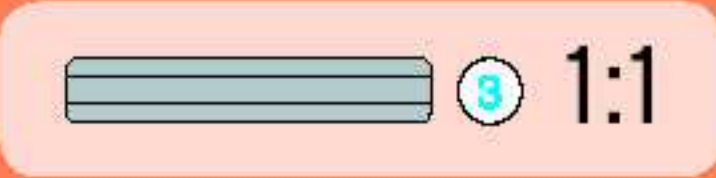
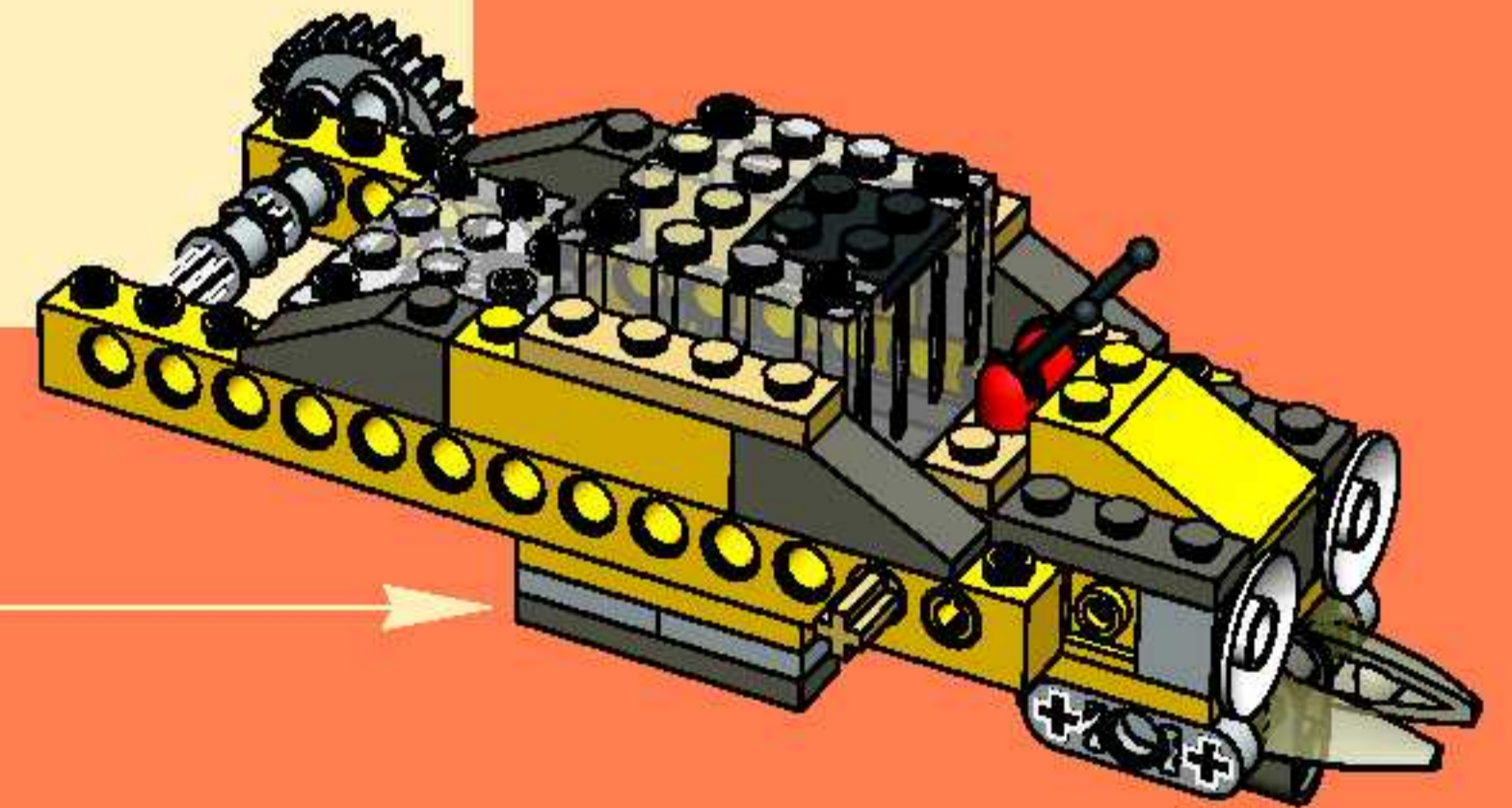
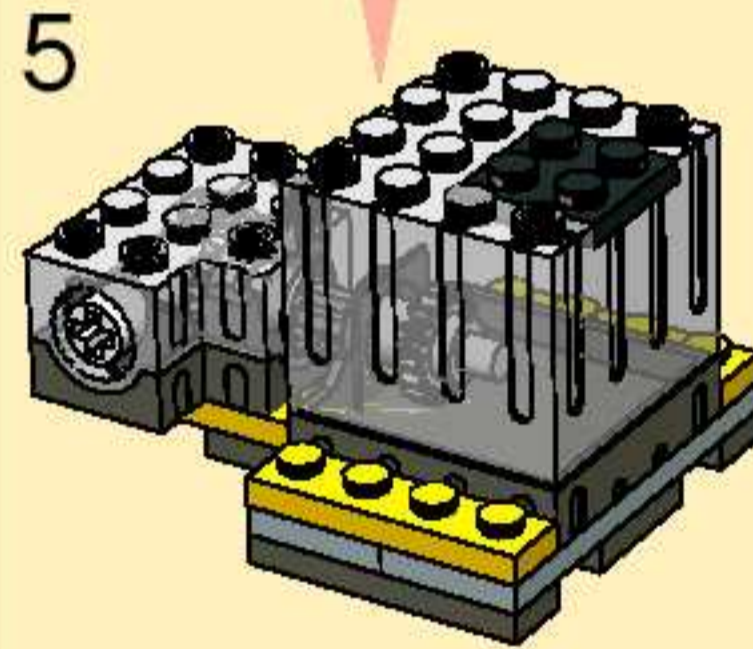
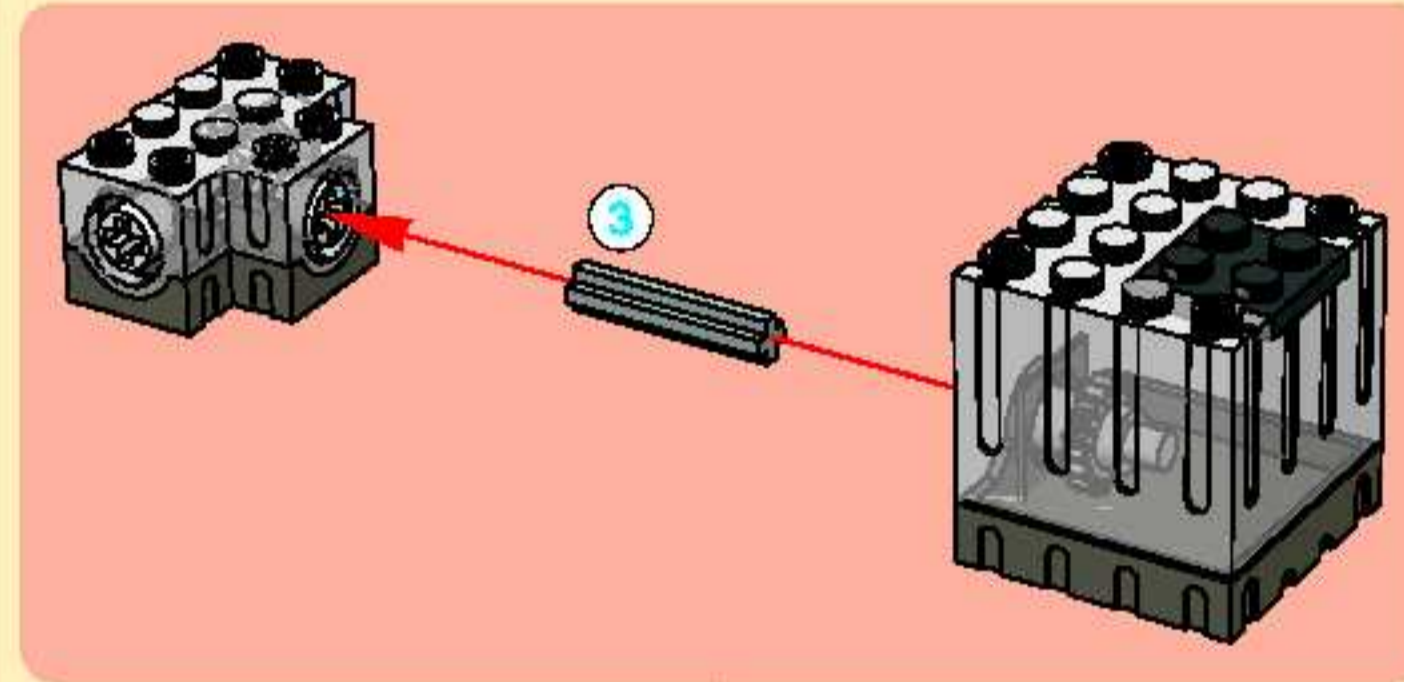
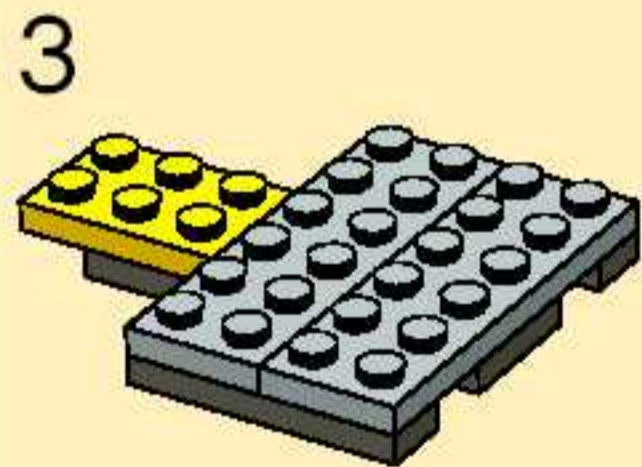
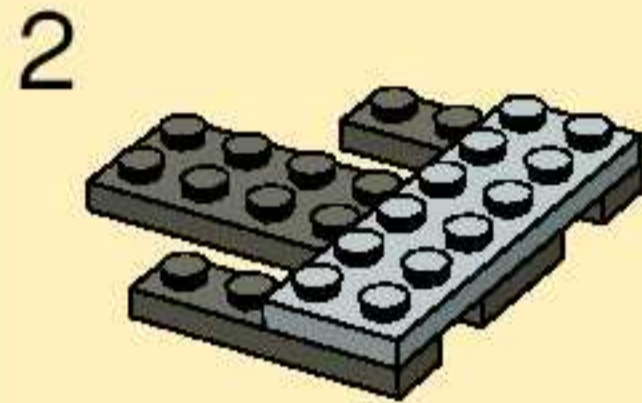
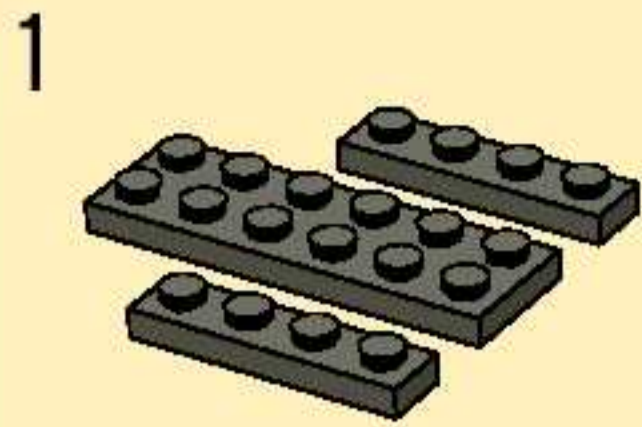

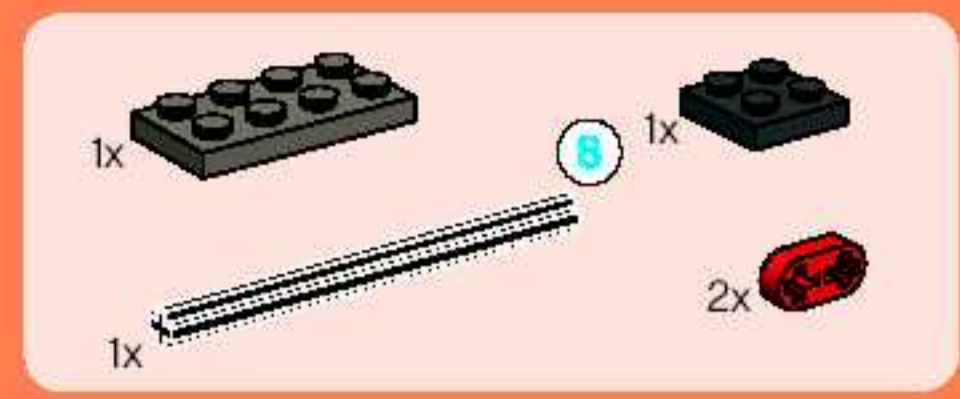
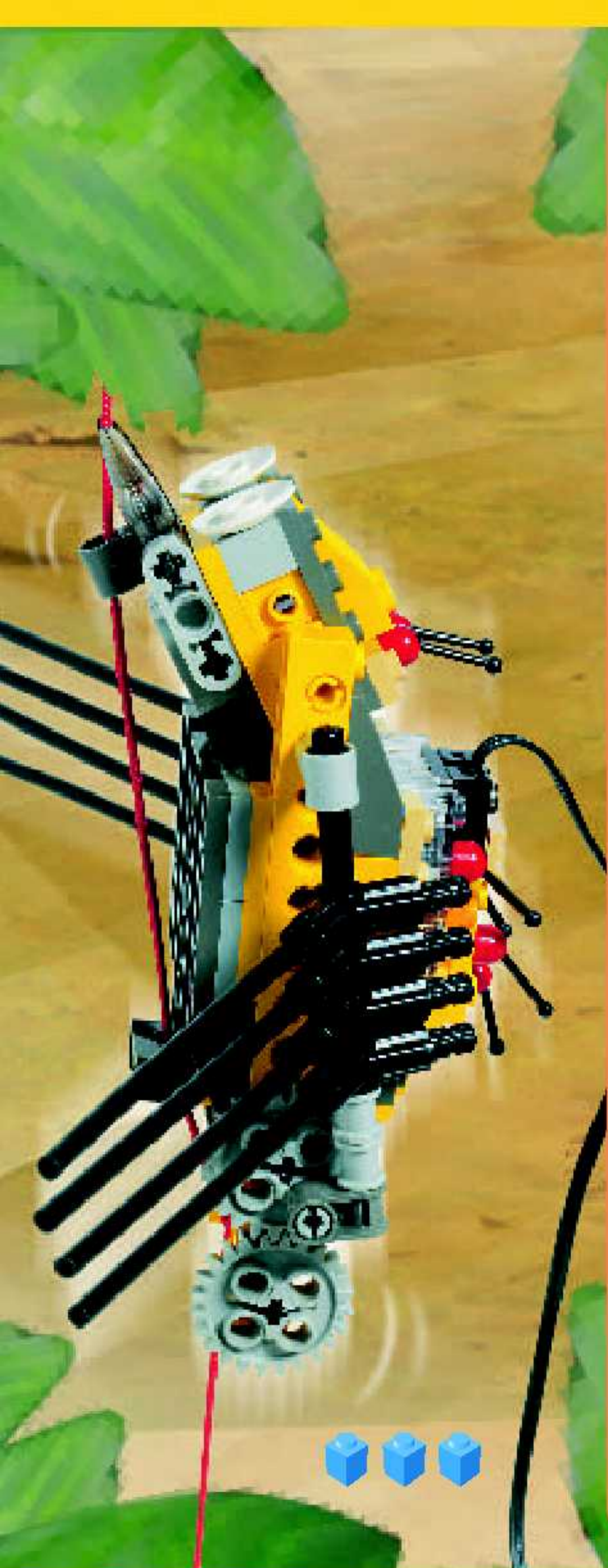

8

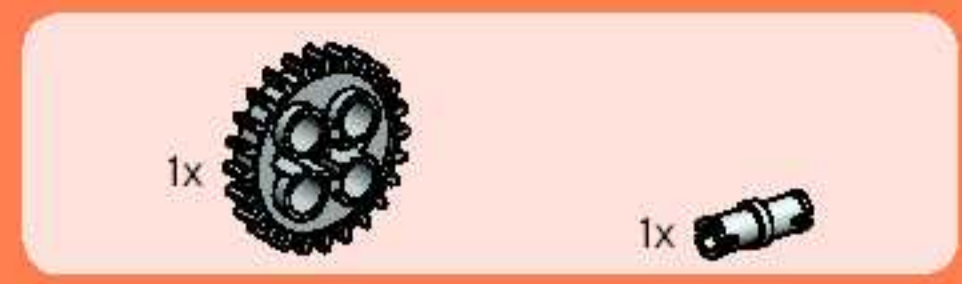
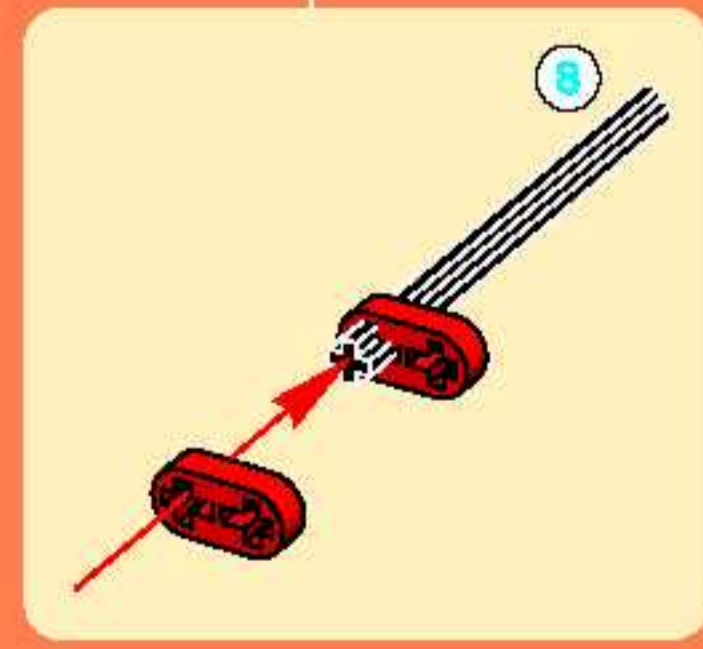
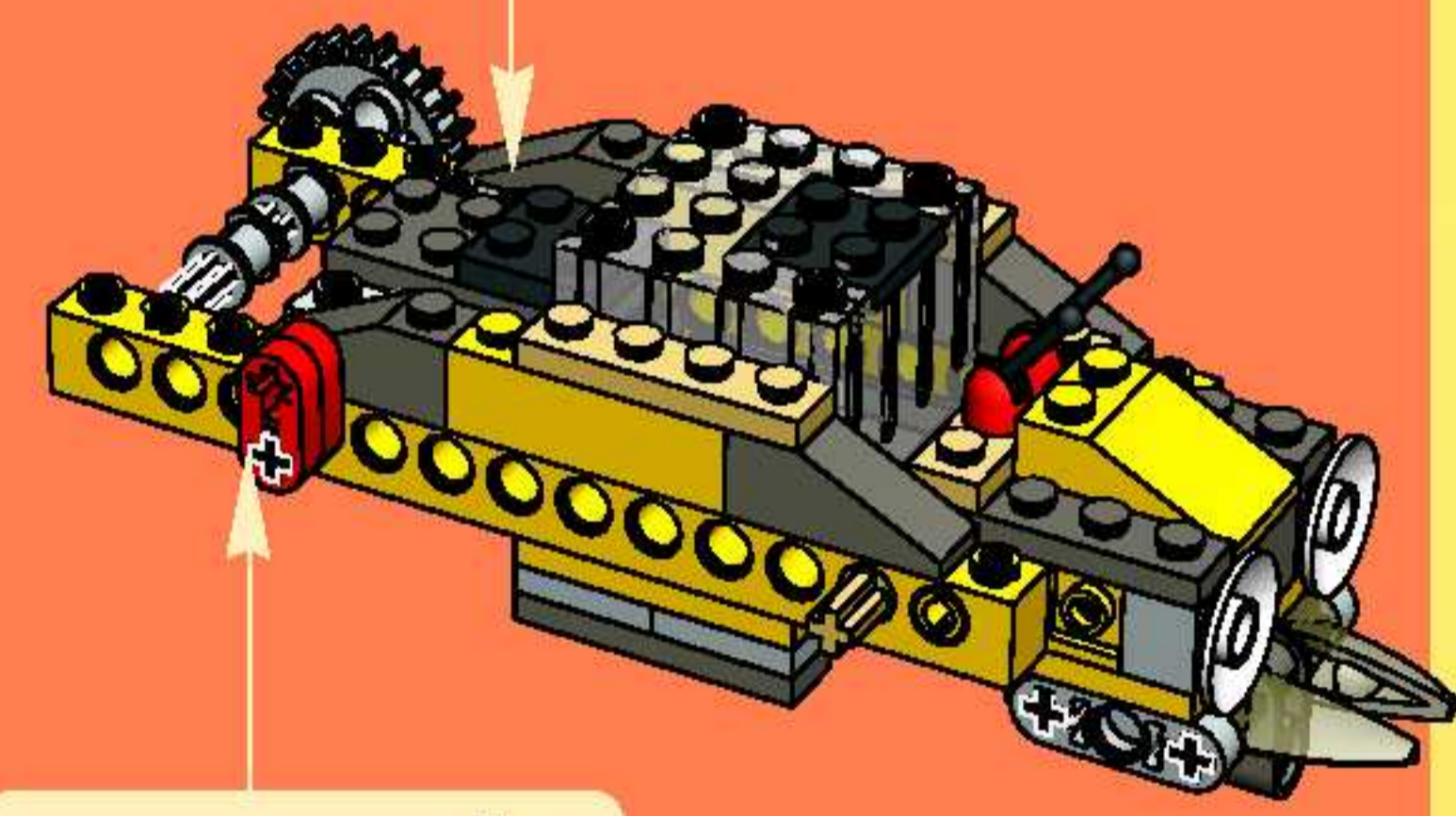
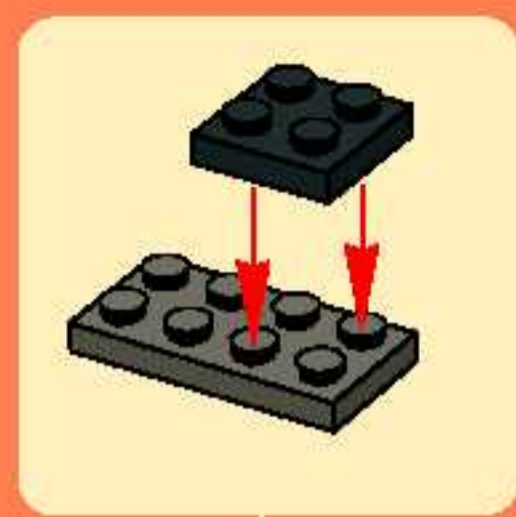

9

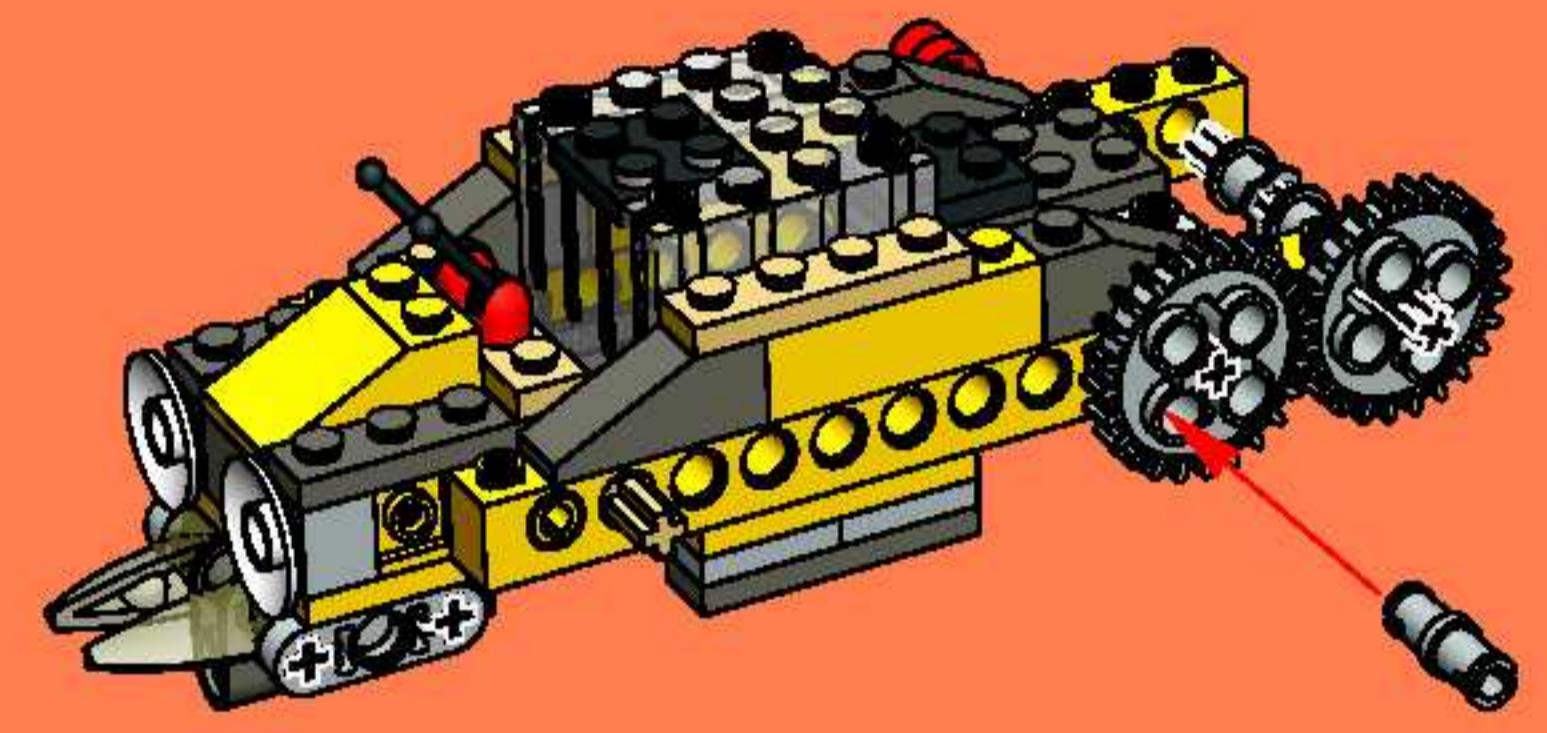

10

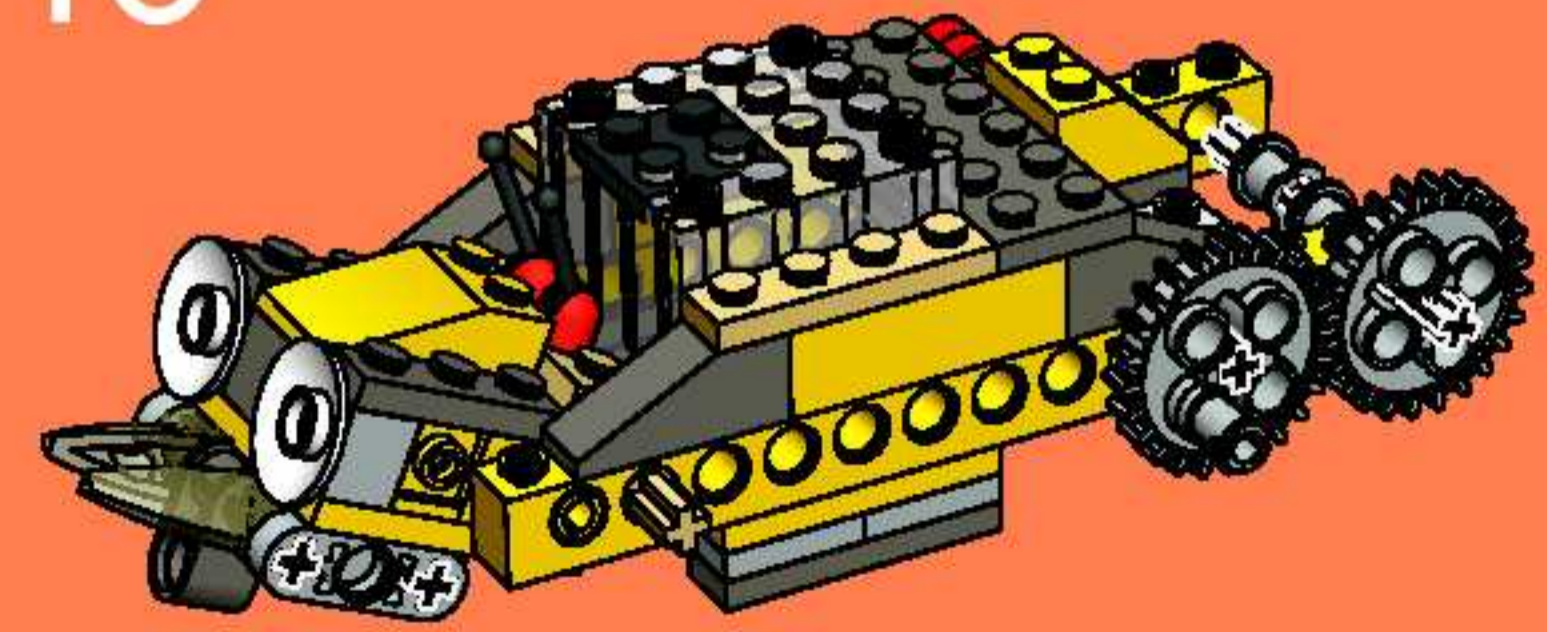



11

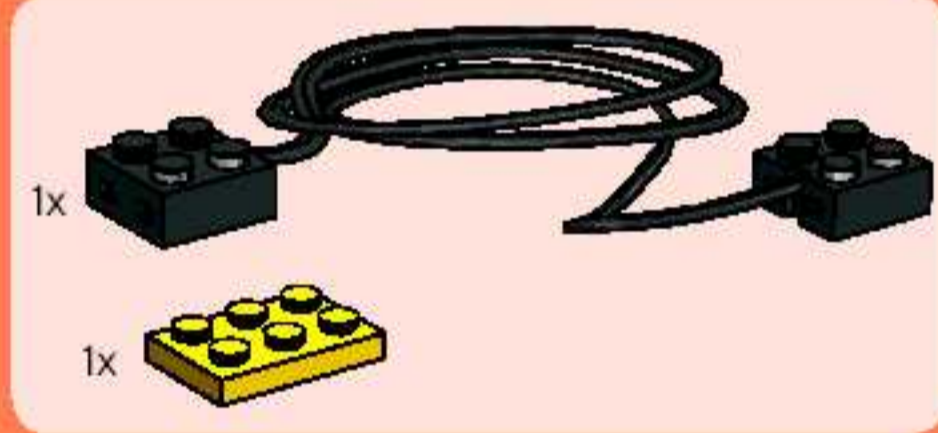
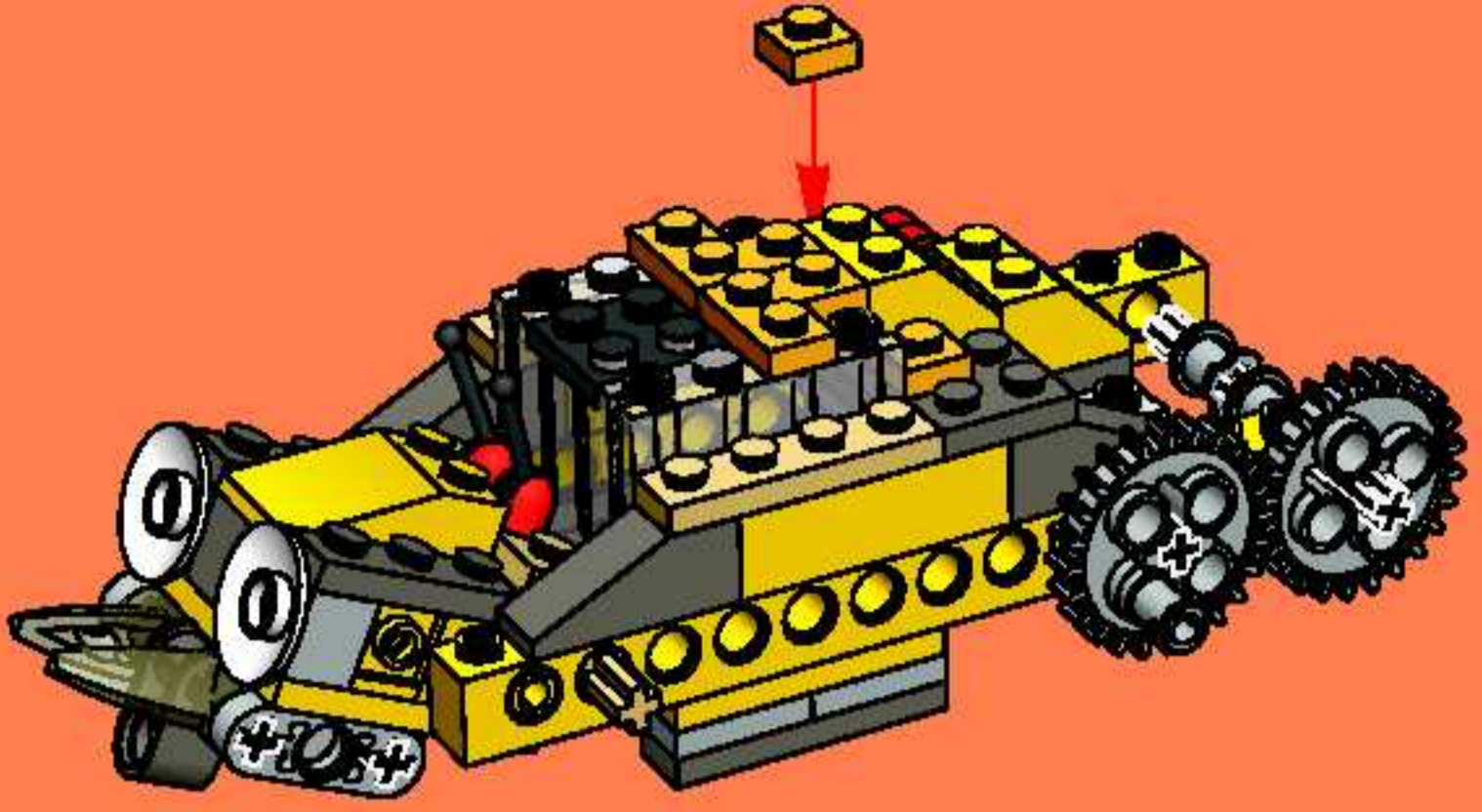

12

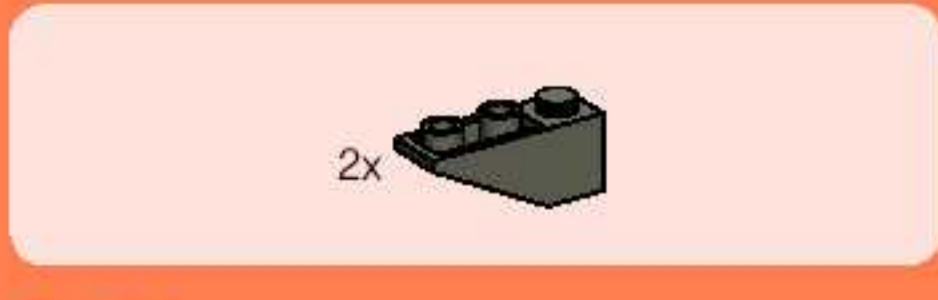
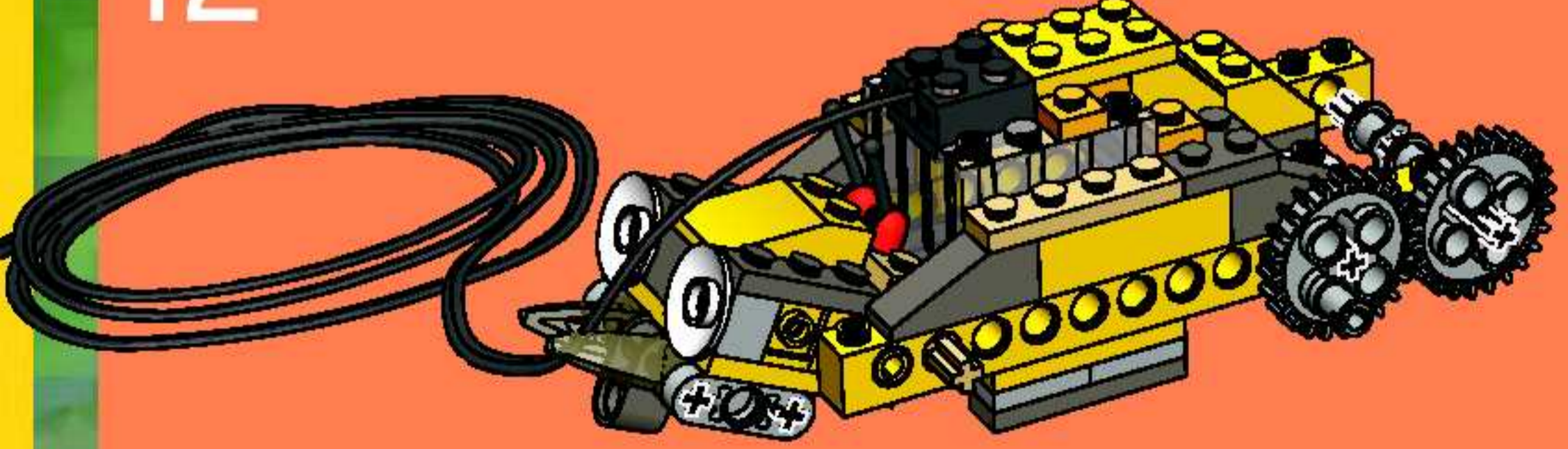

13

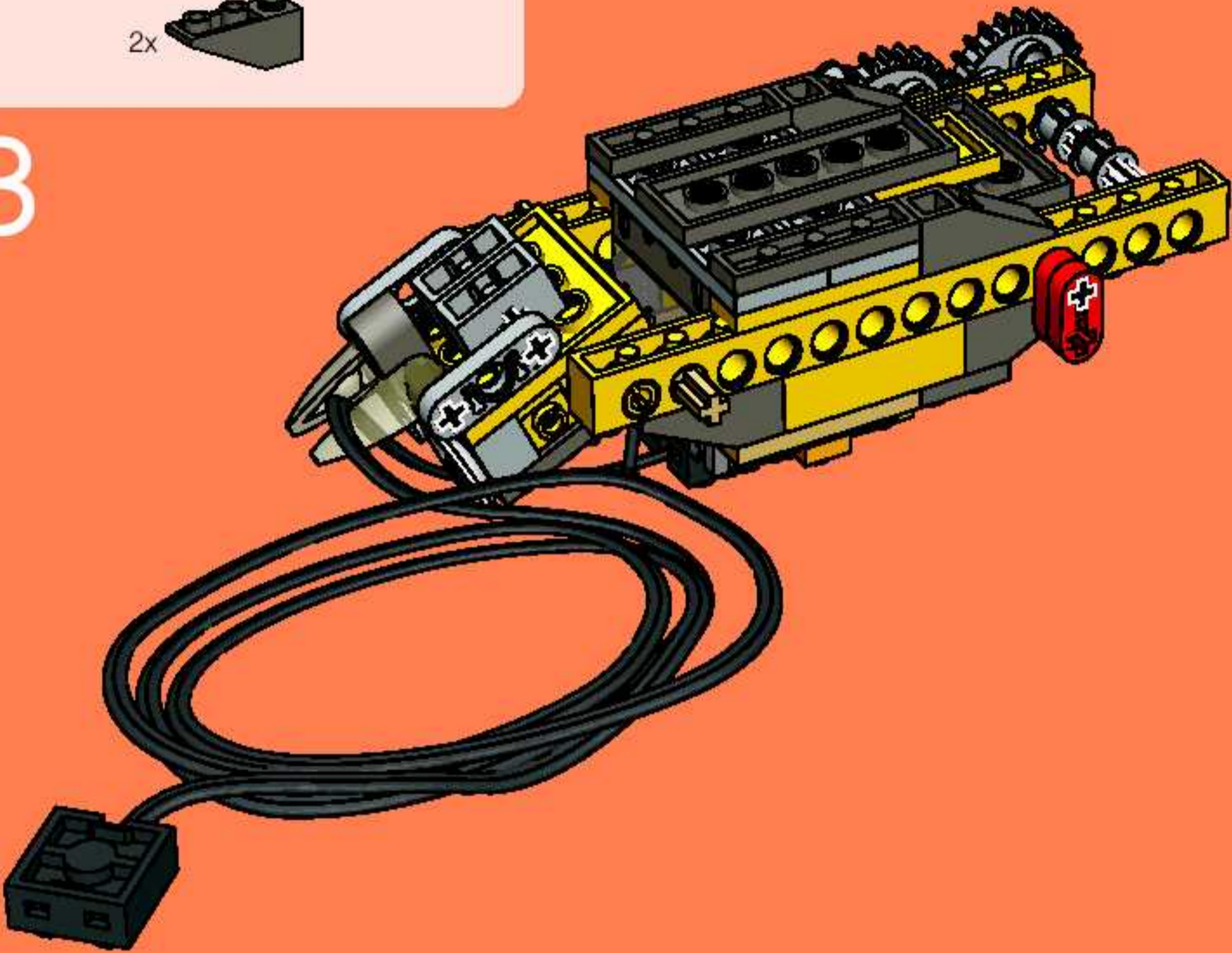

14

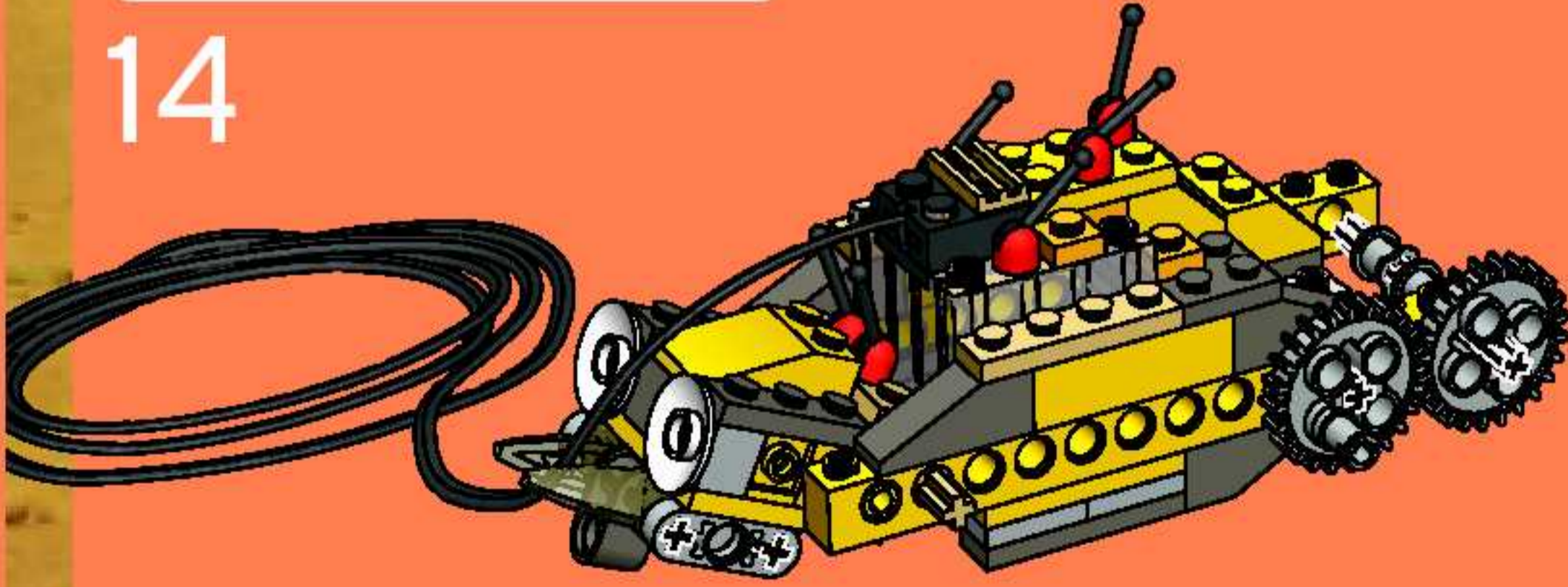



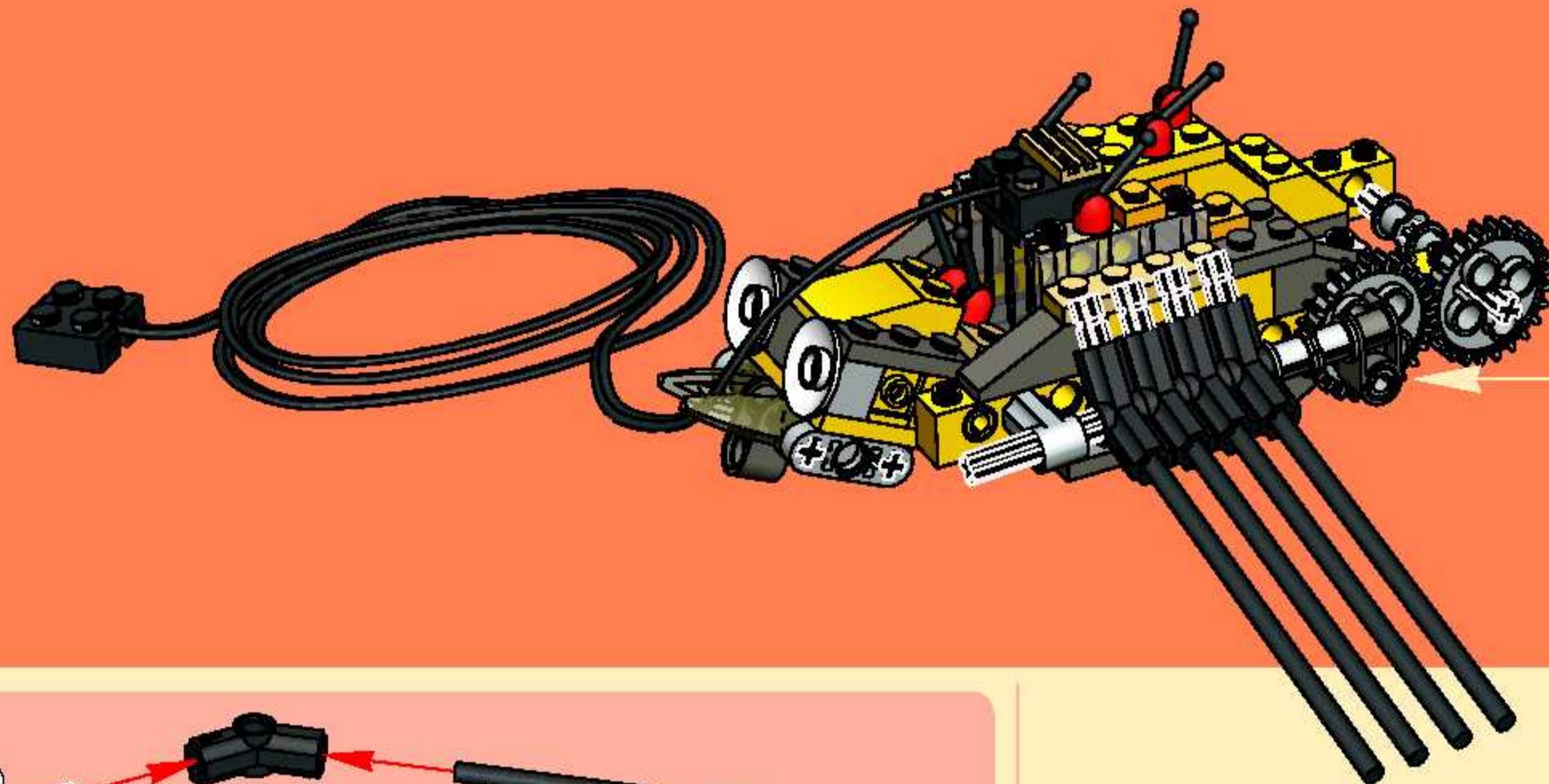

15

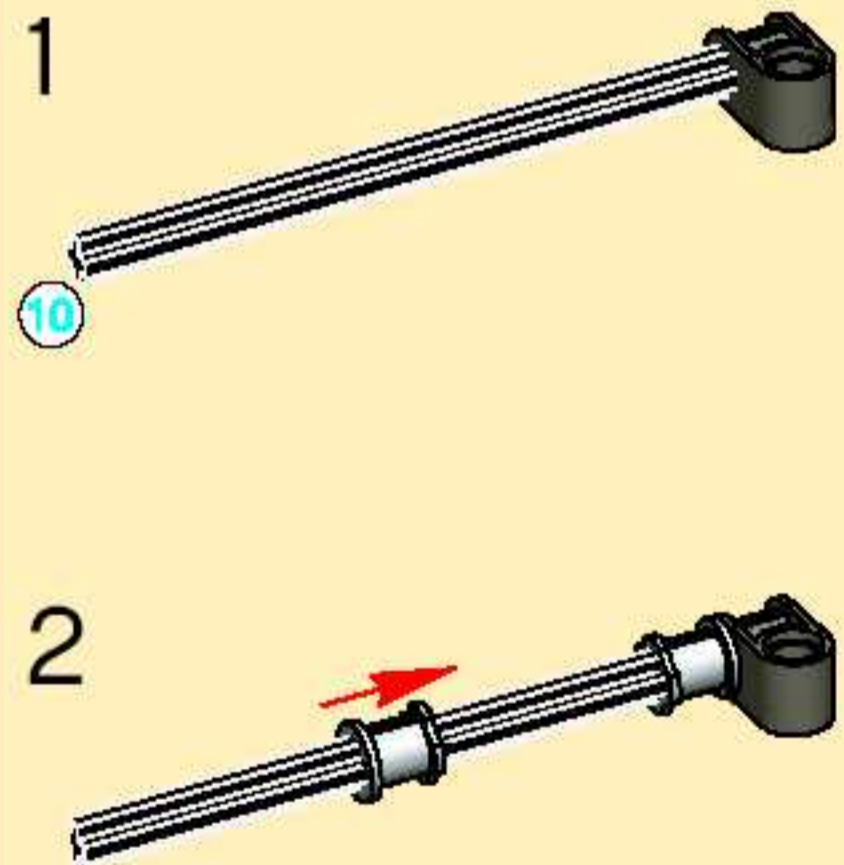



16

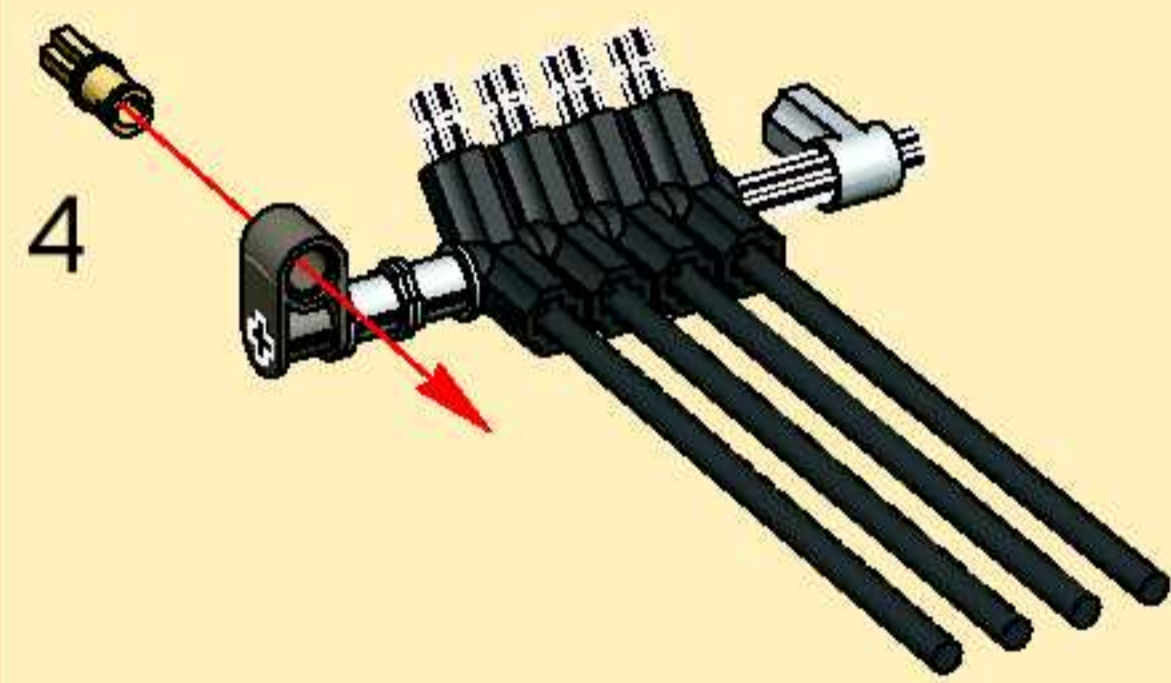
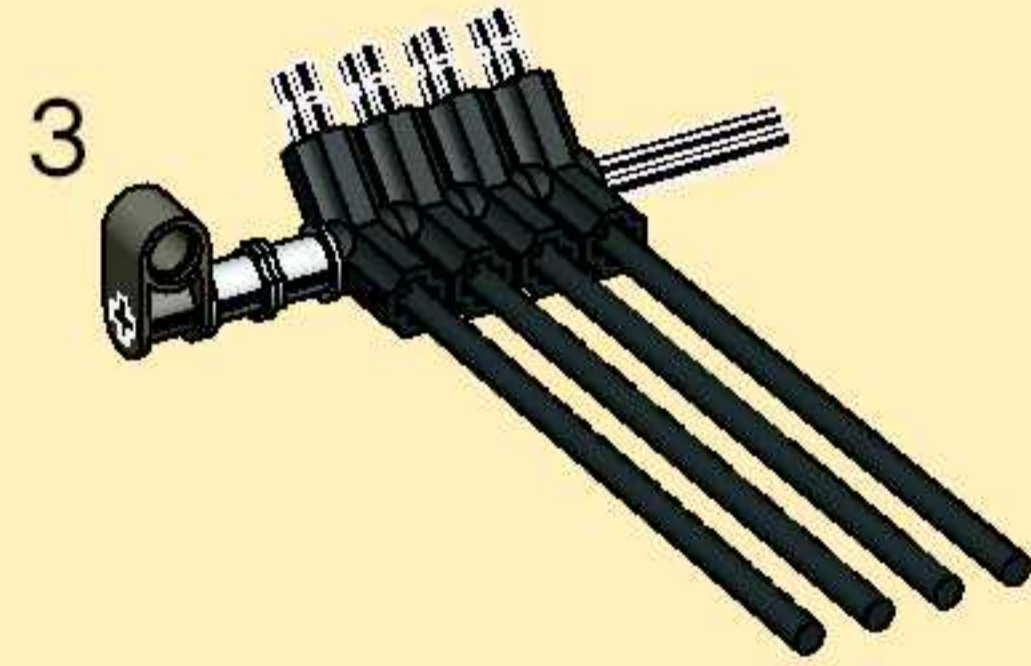
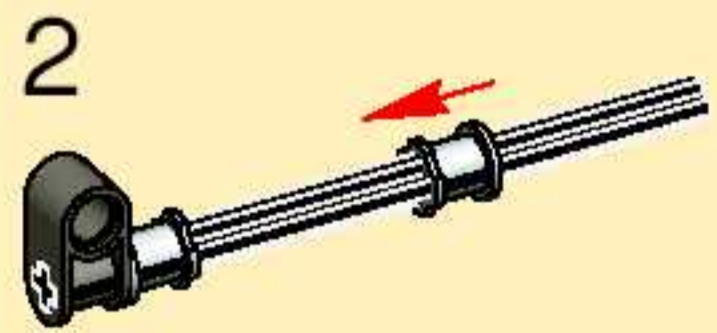
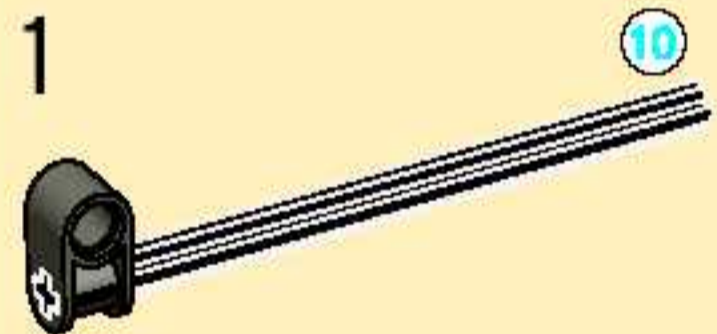

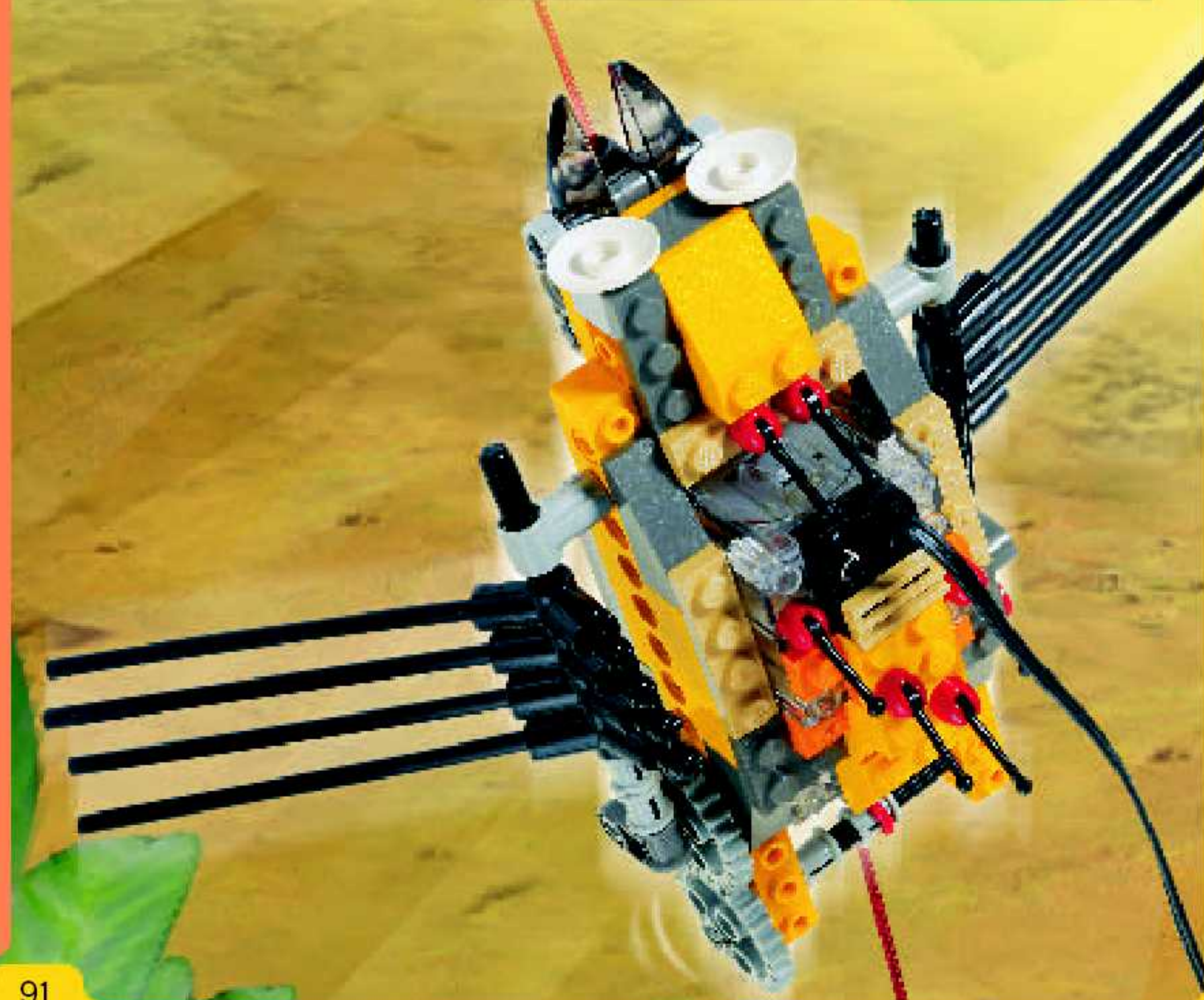
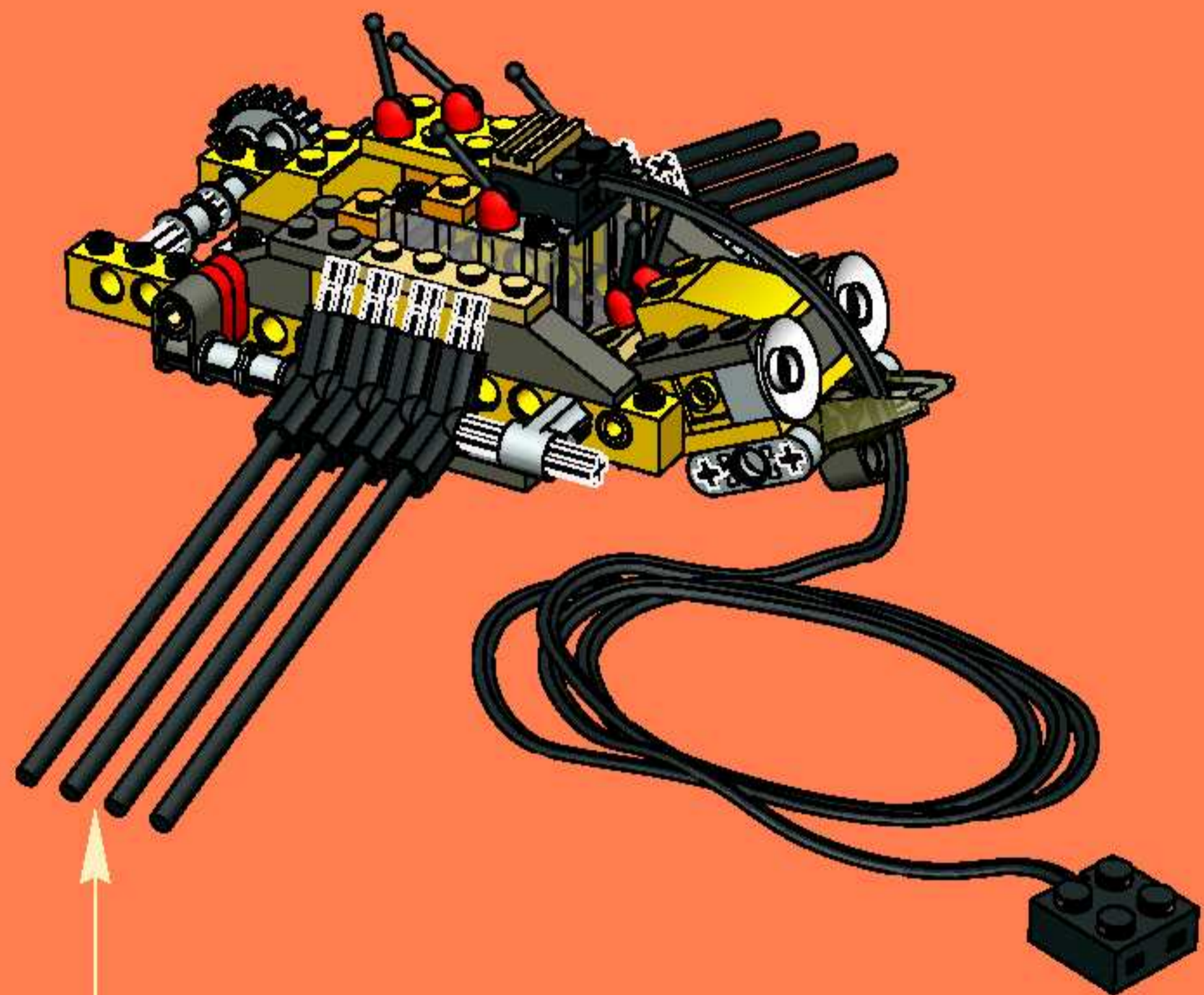



1x



1x

17

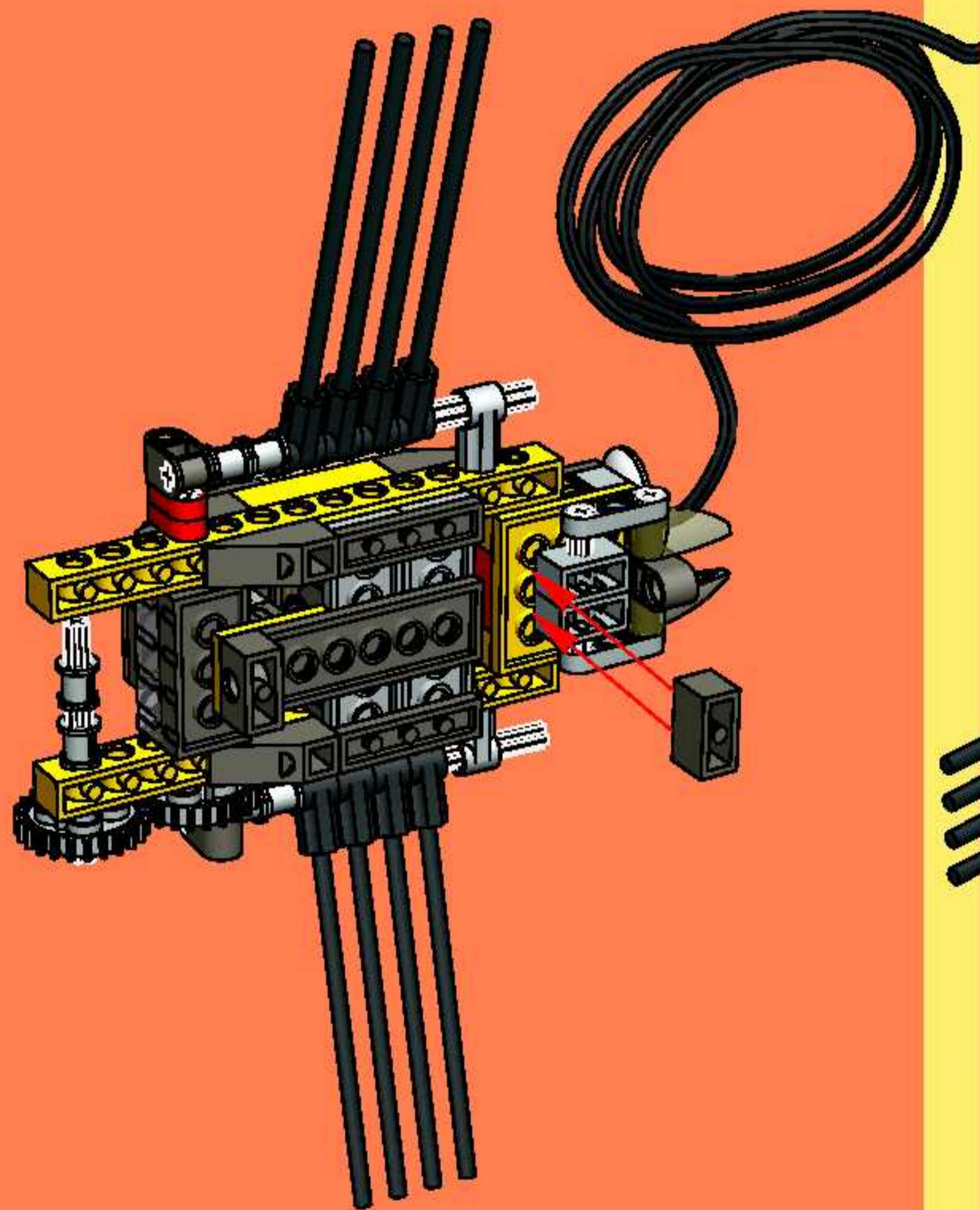

1x

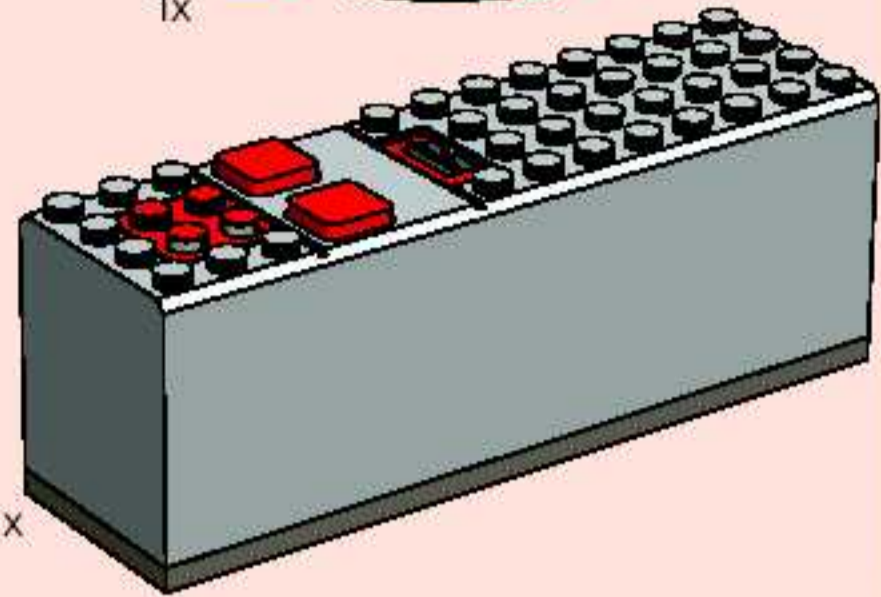

18

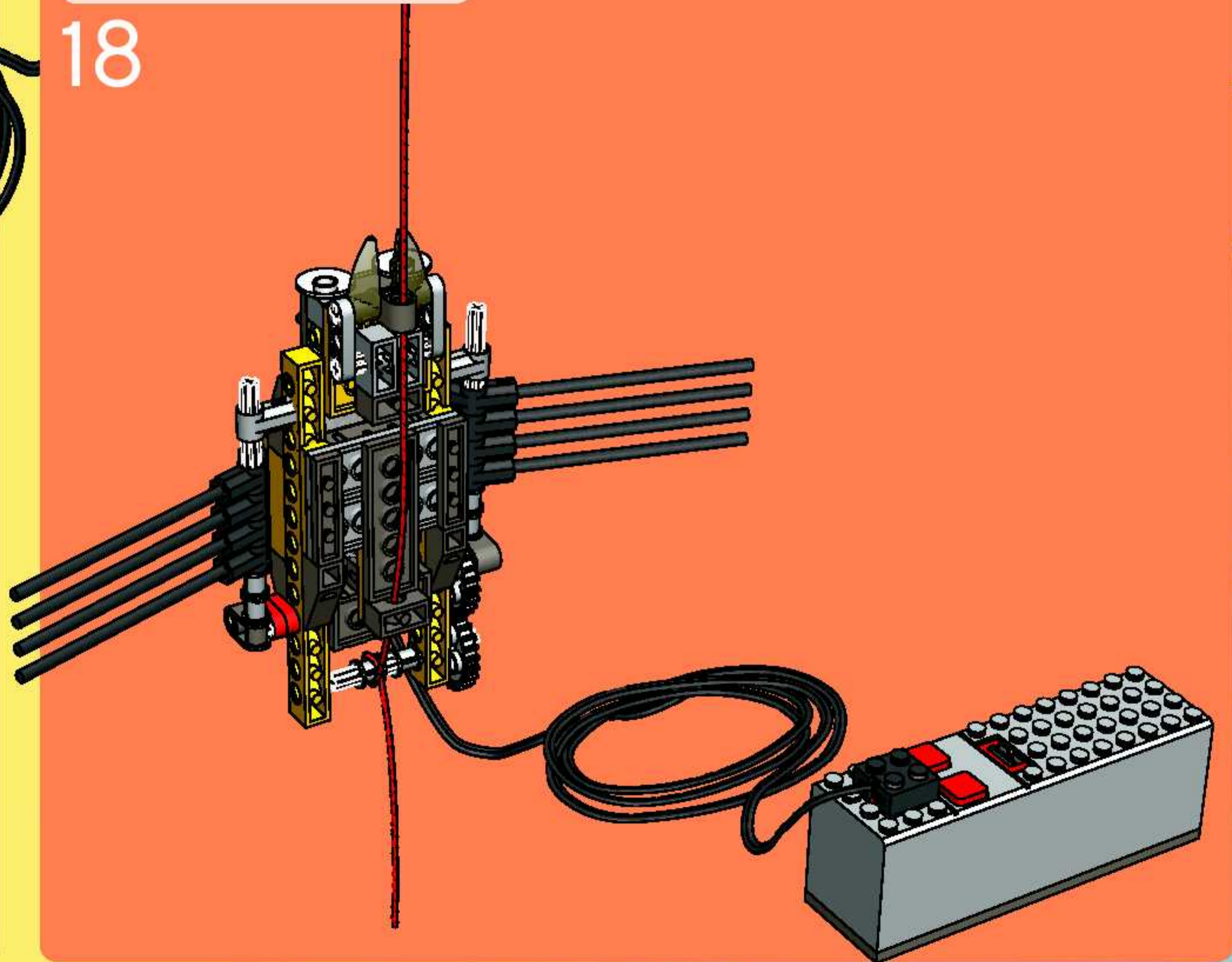



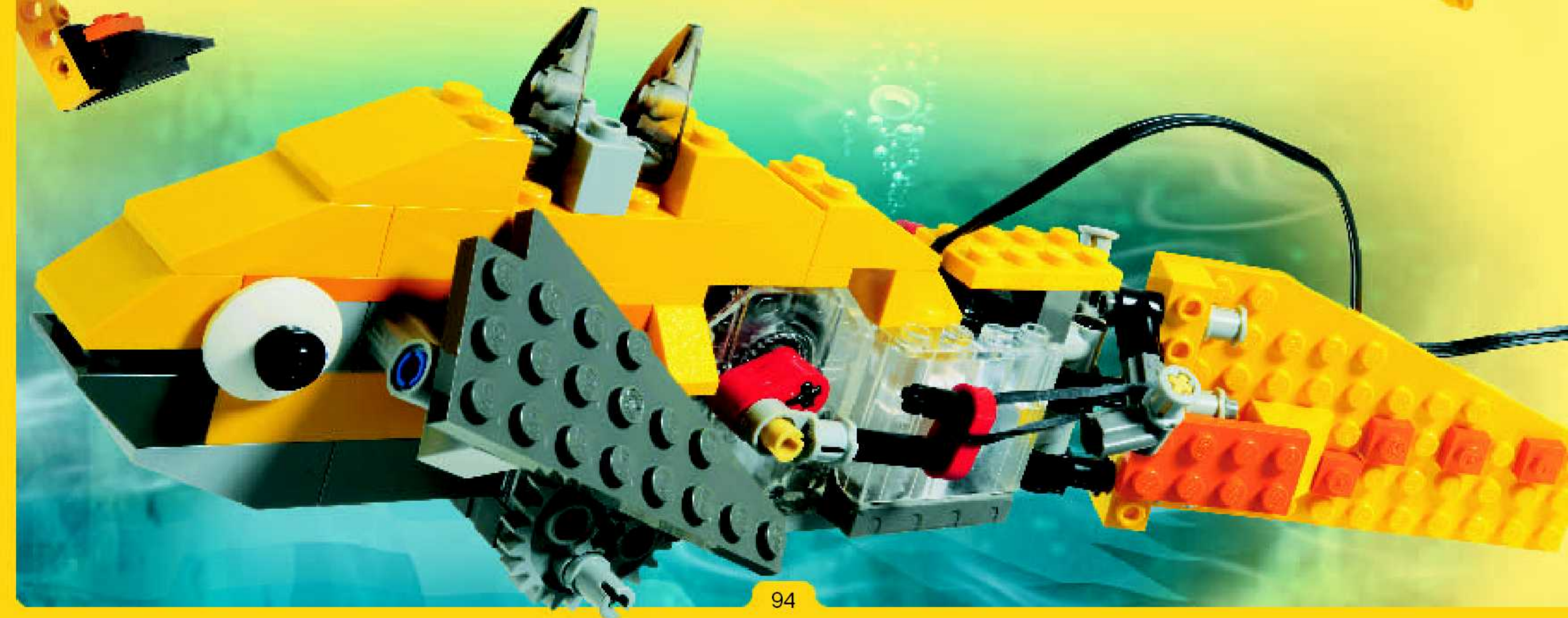
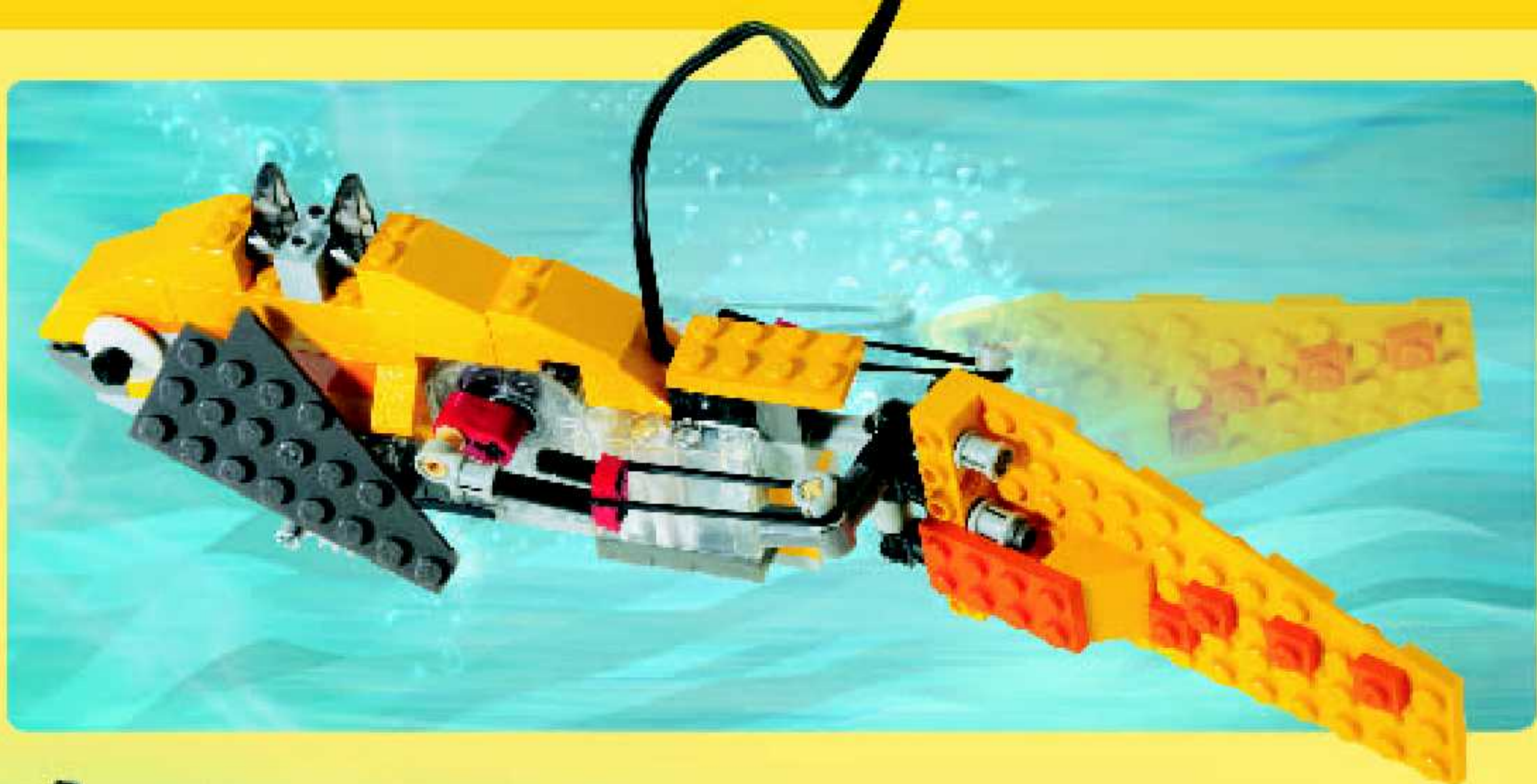

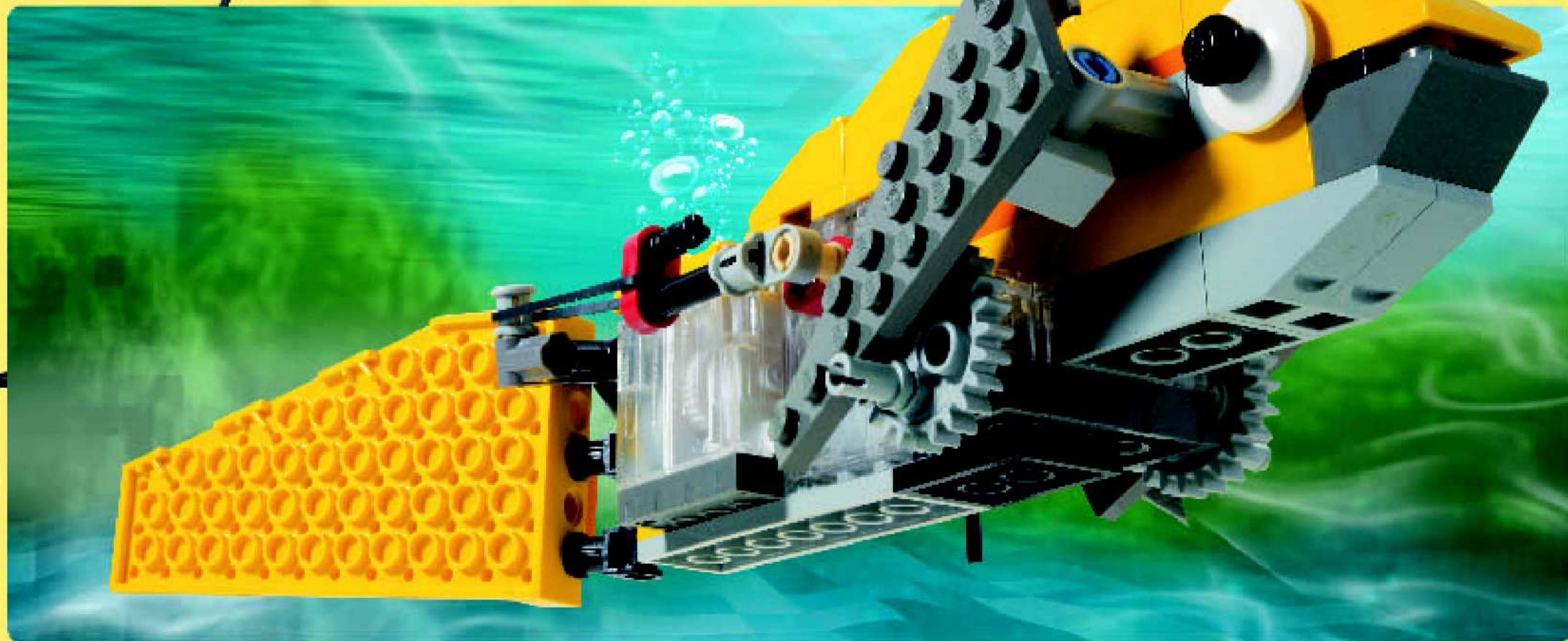

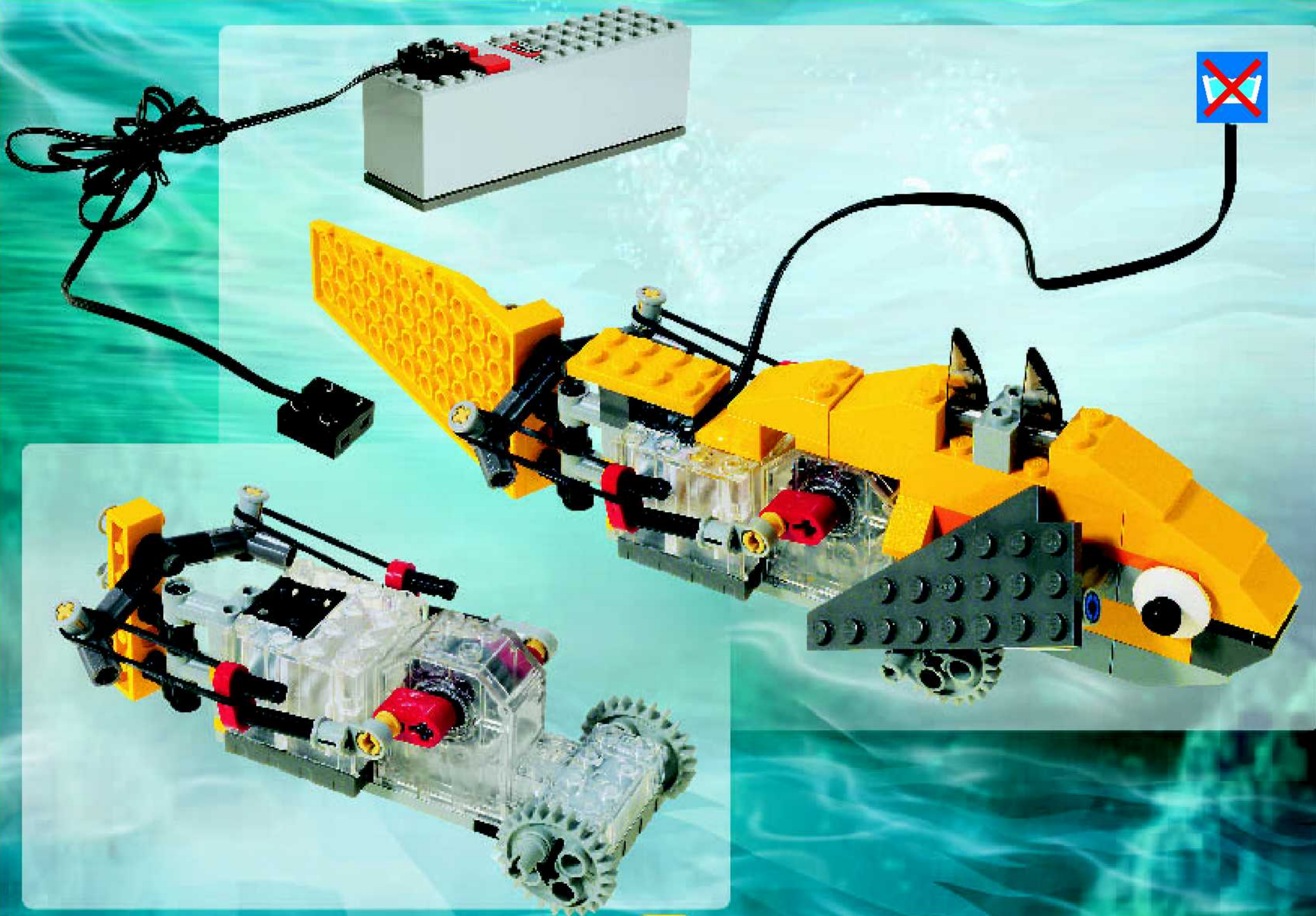









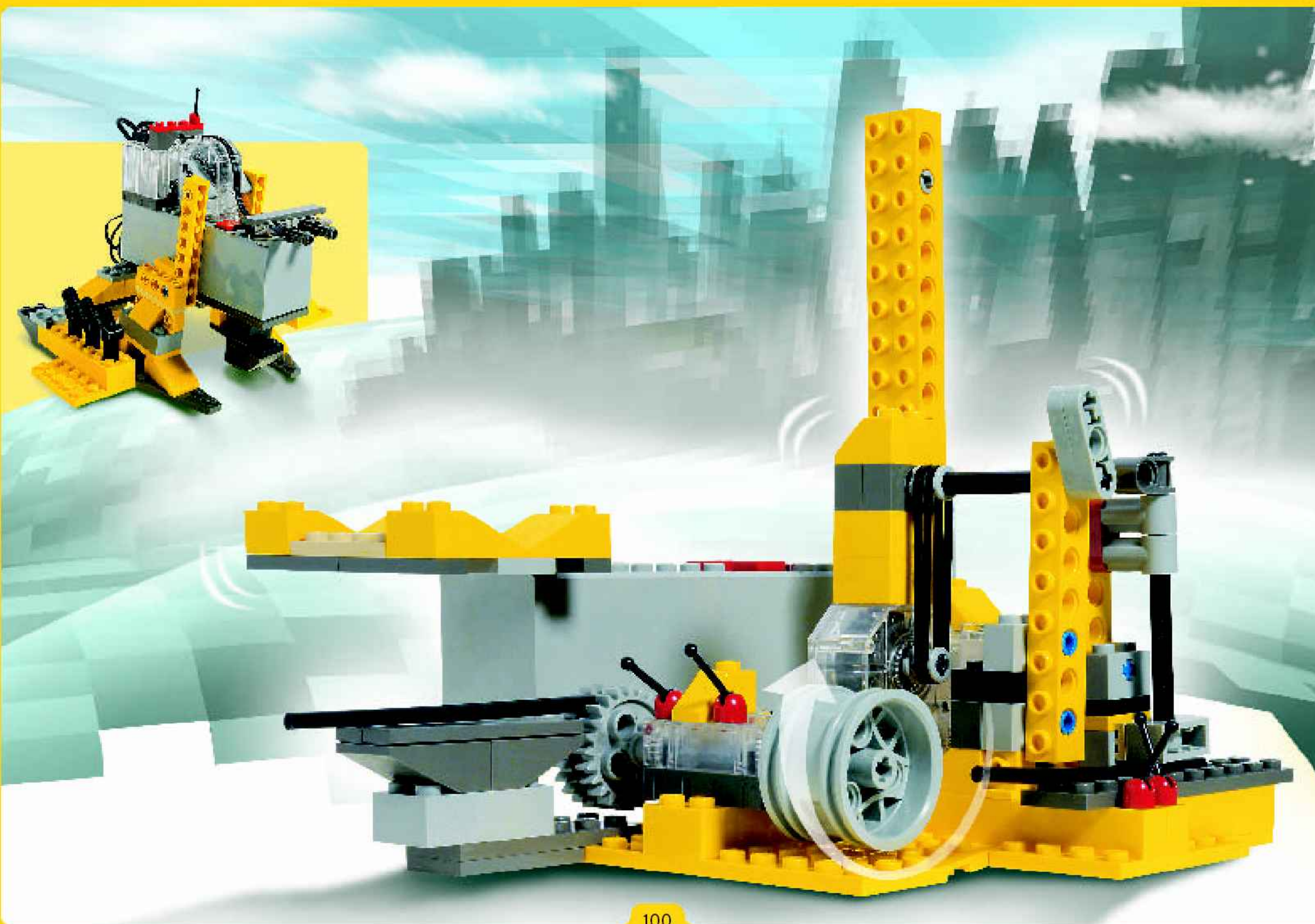

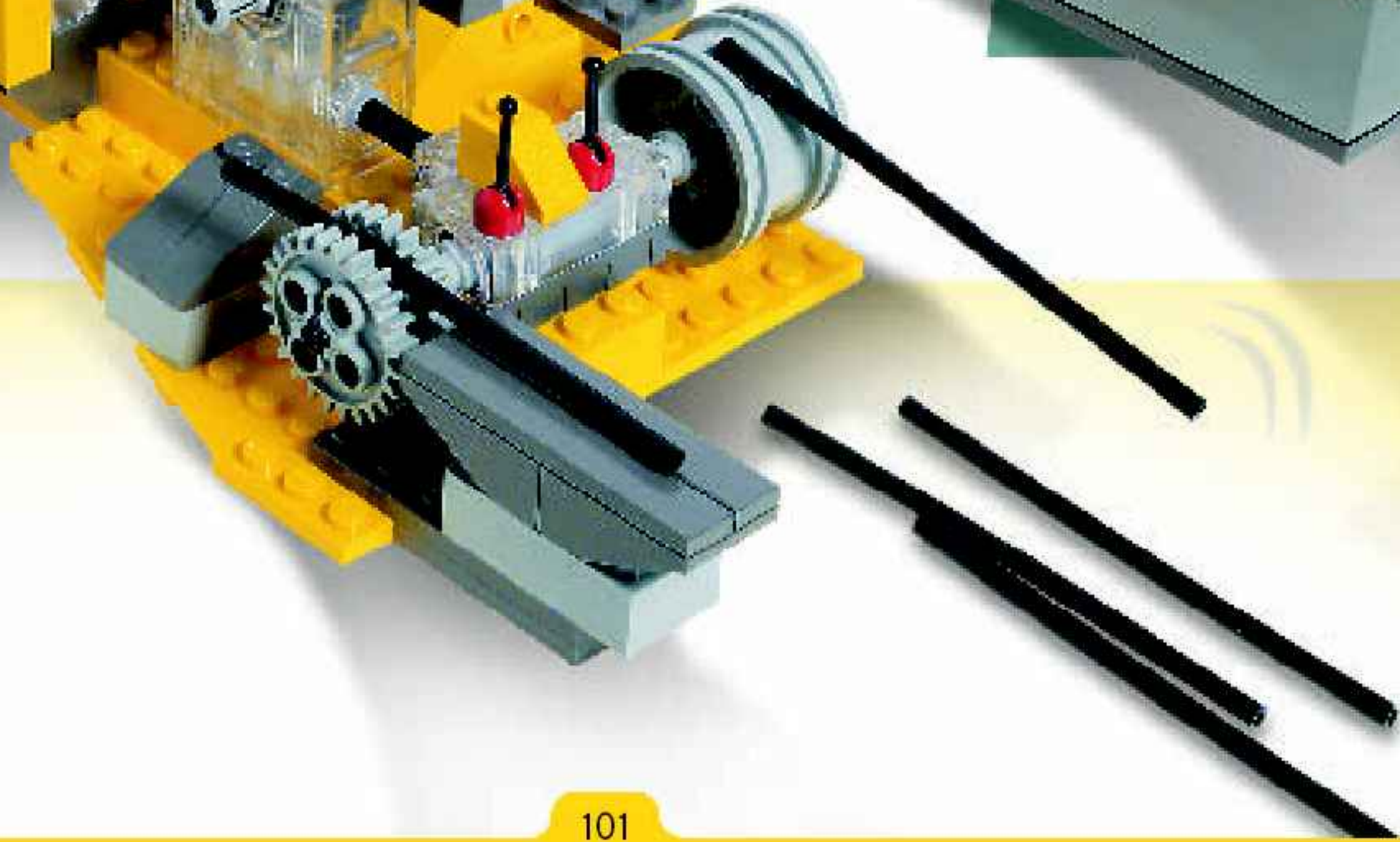
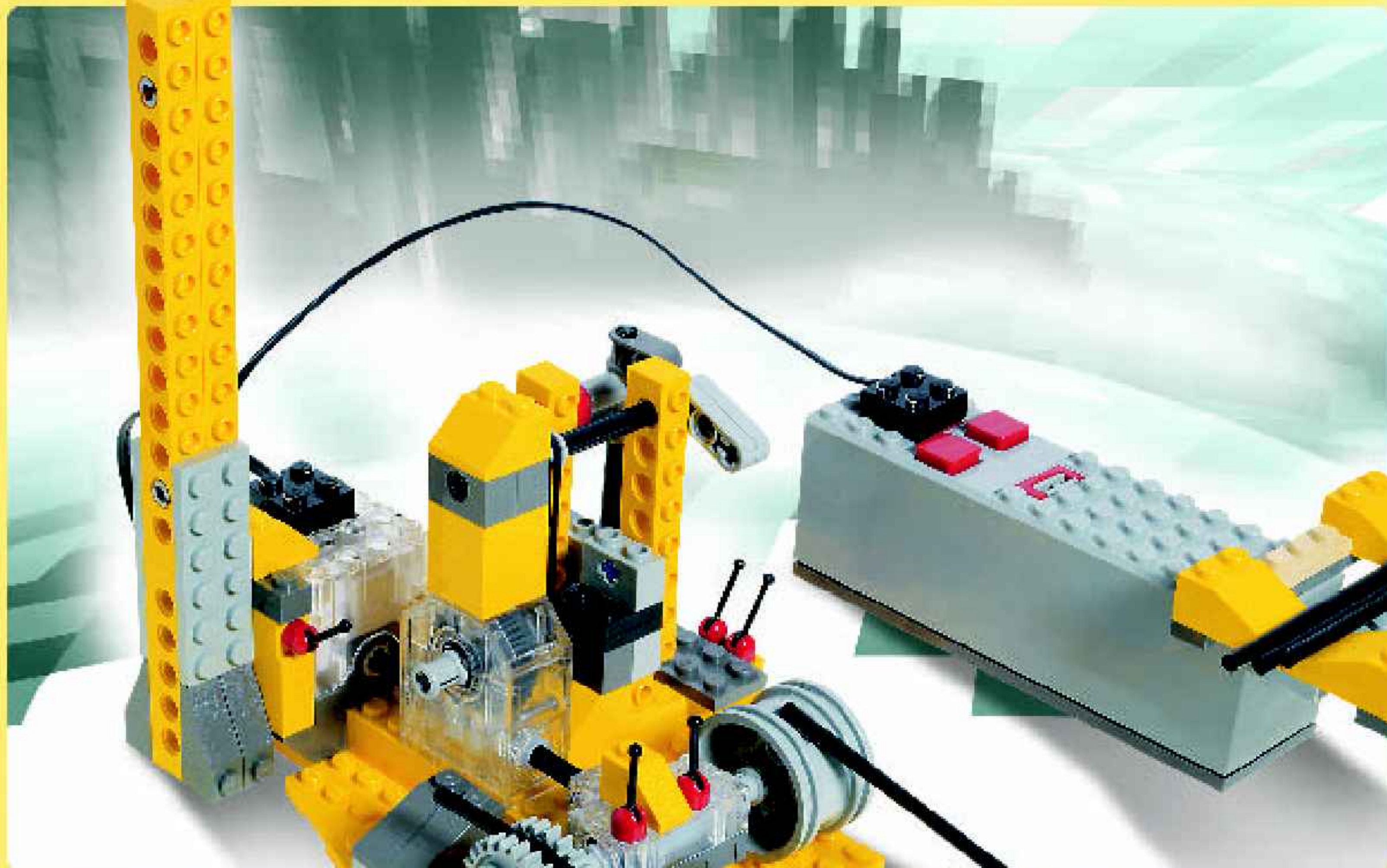



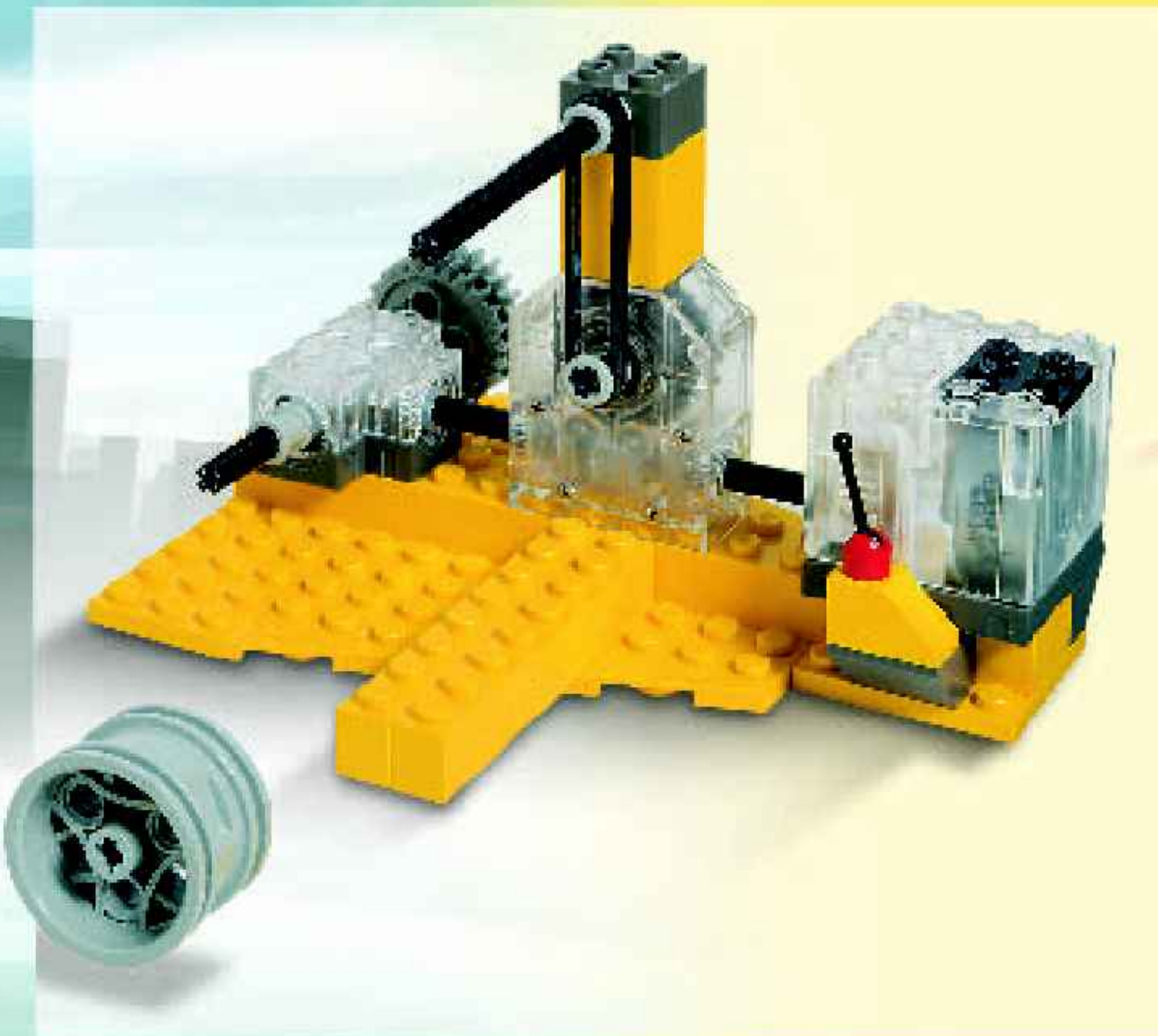









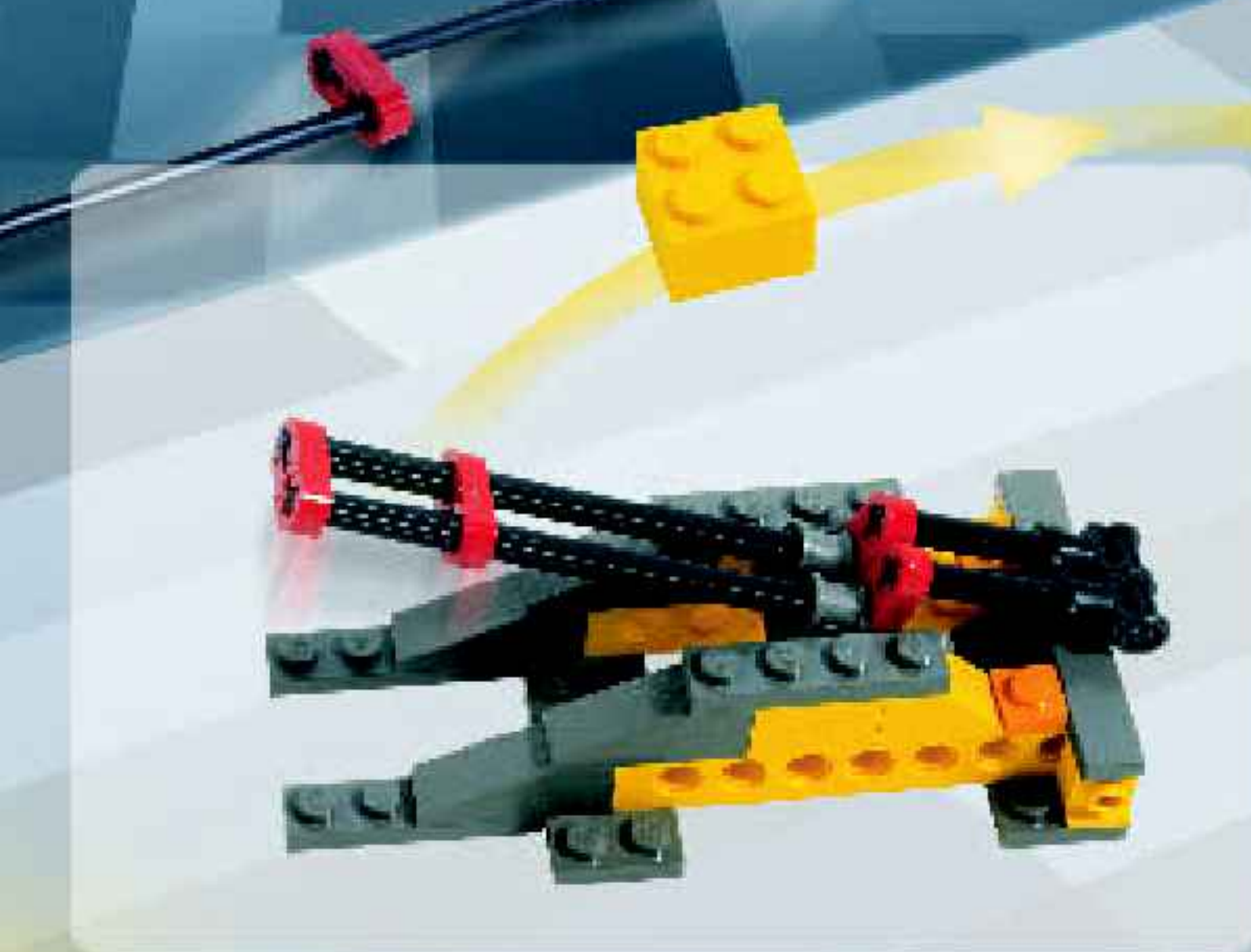

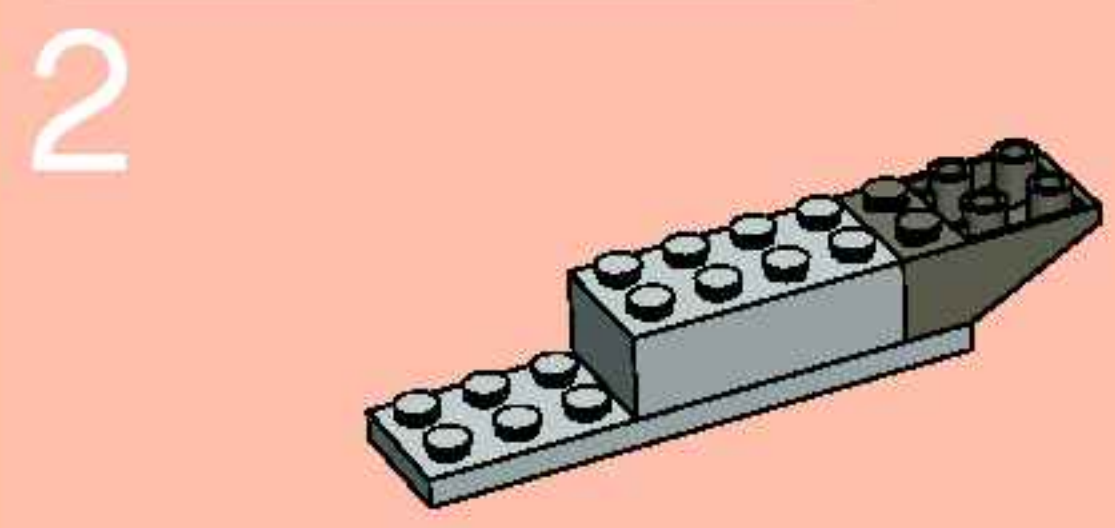
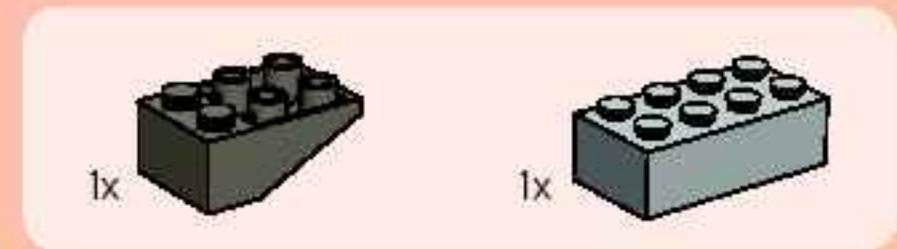
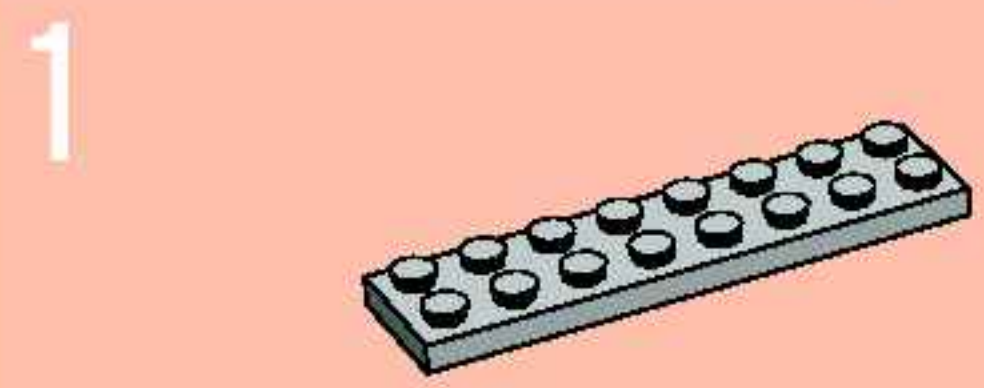
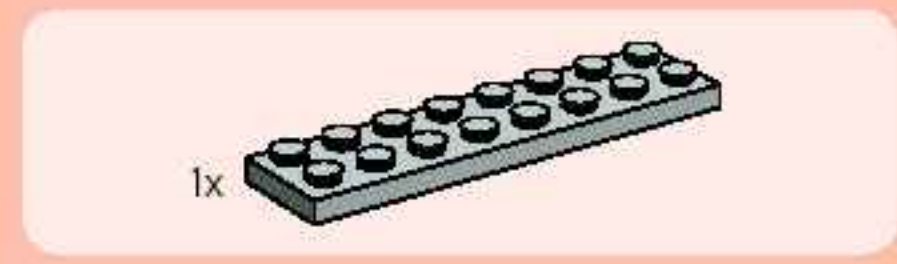
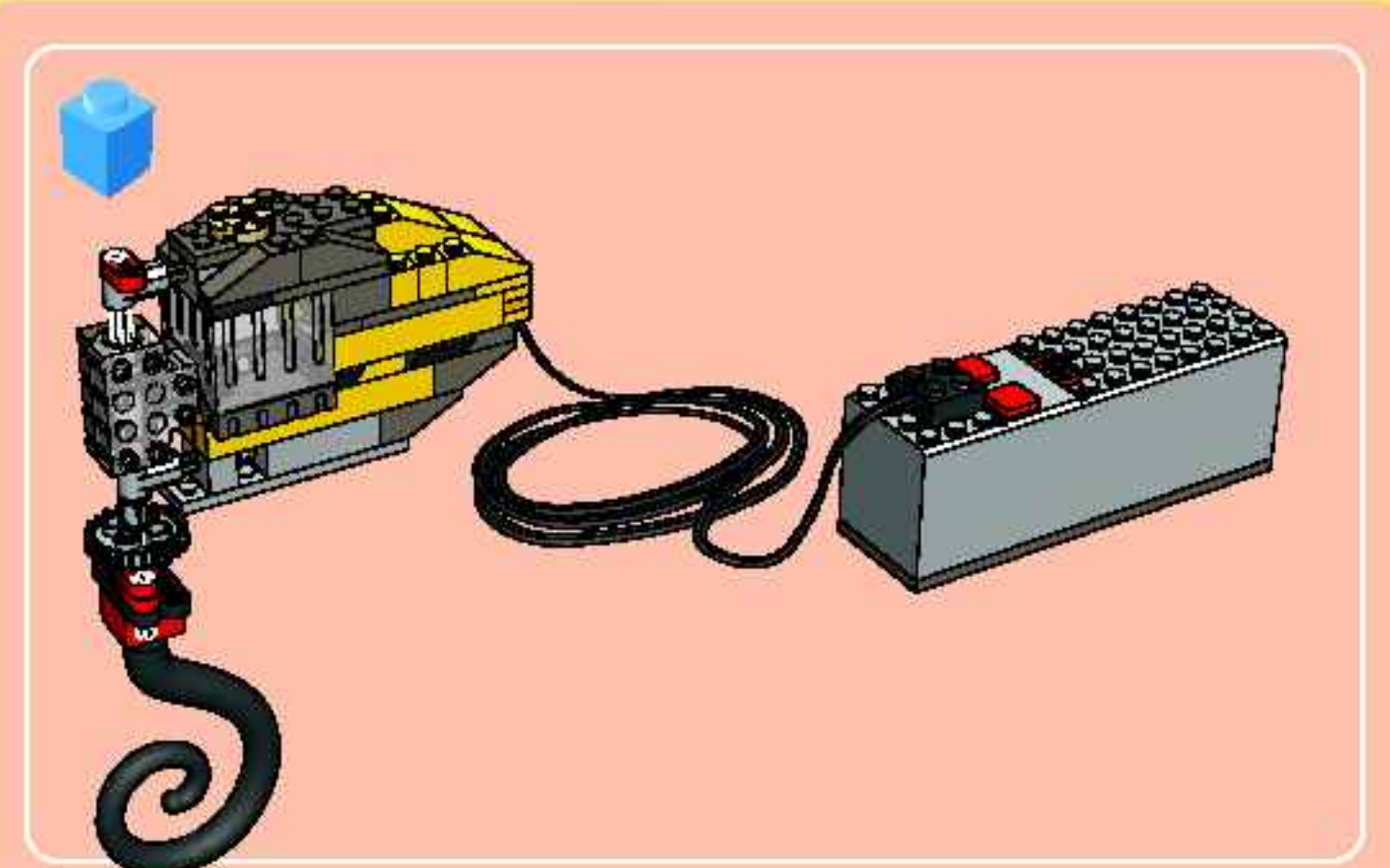
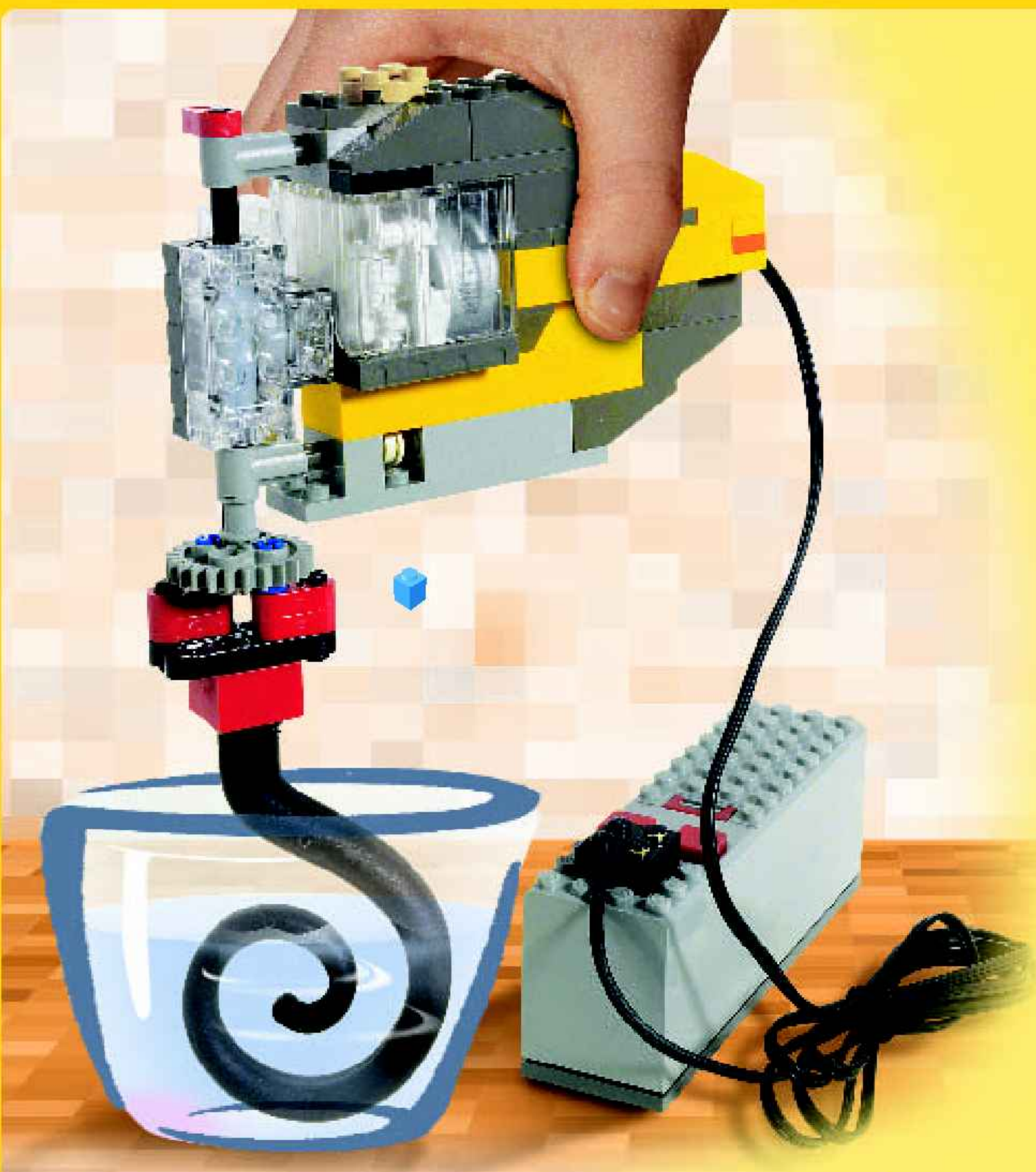

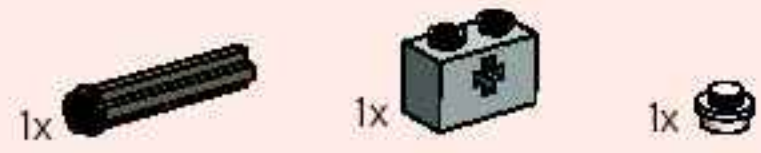

3

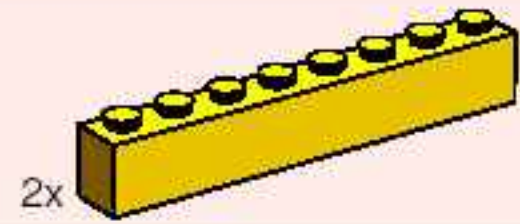
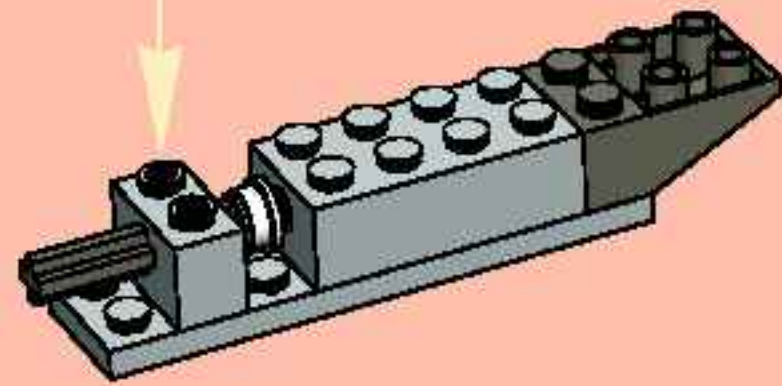

4

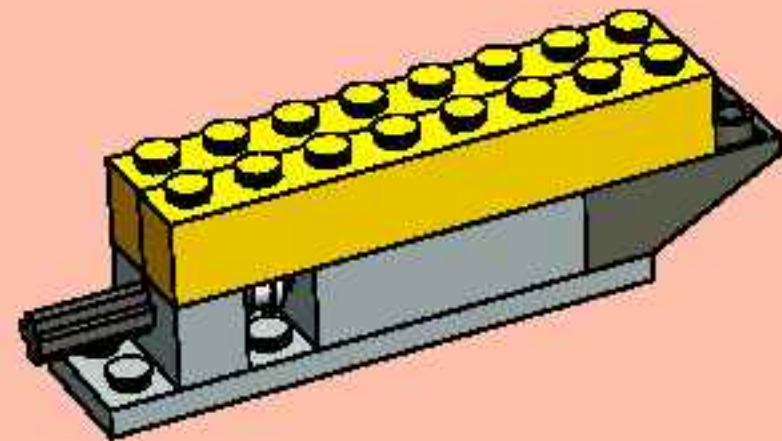

5

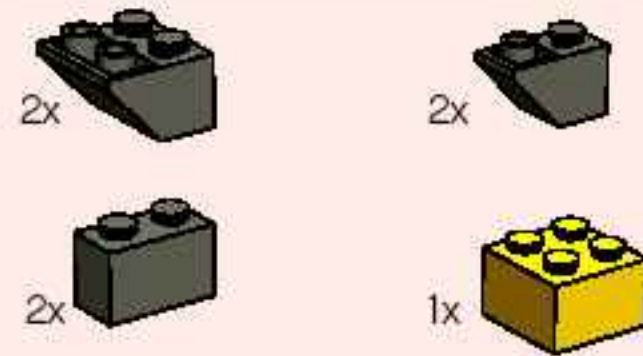
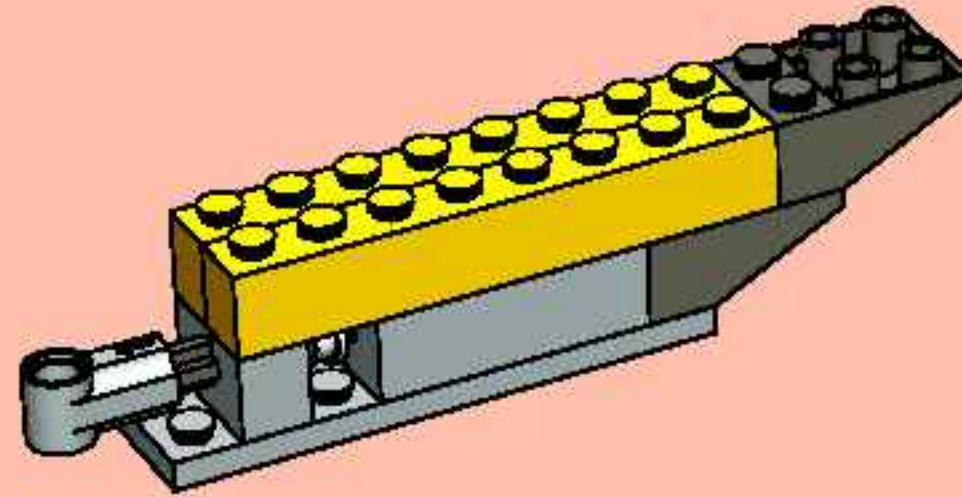

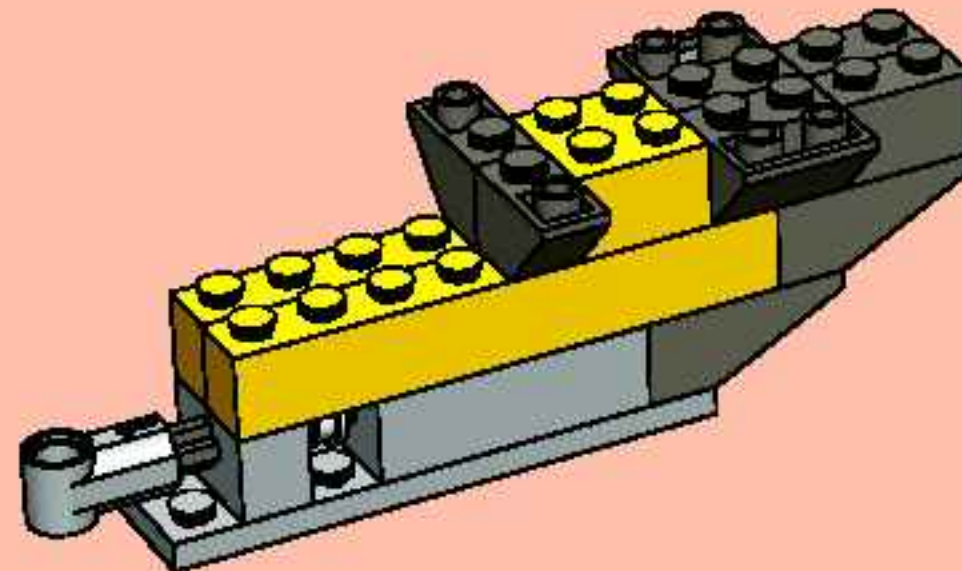

6





7

1x  1x  2x 

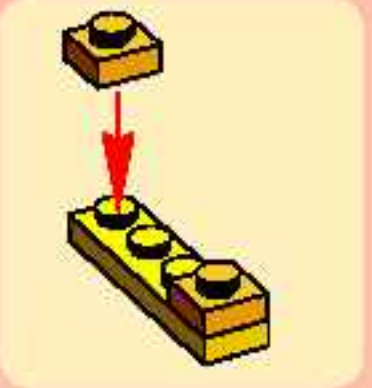

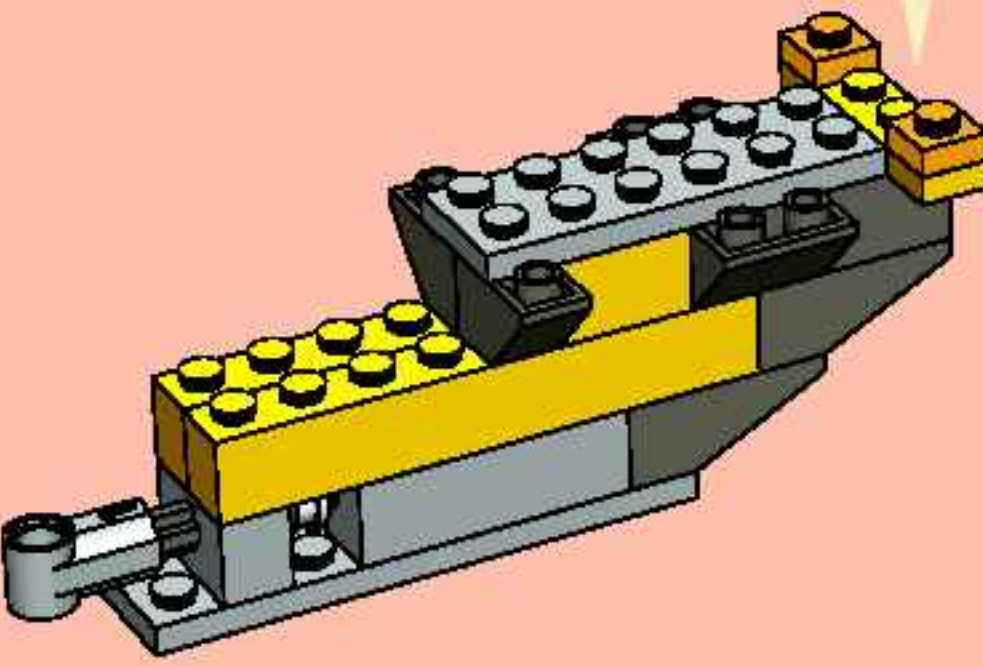

8

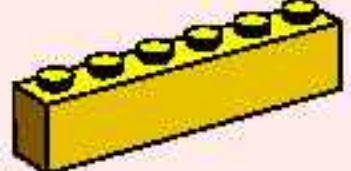
2x 

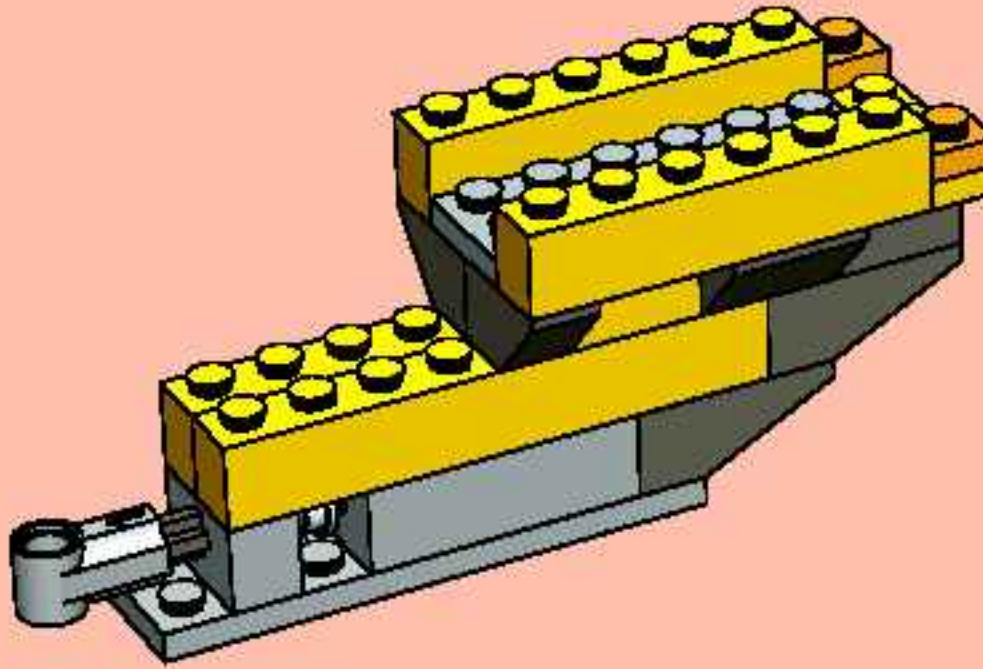

9

3x 

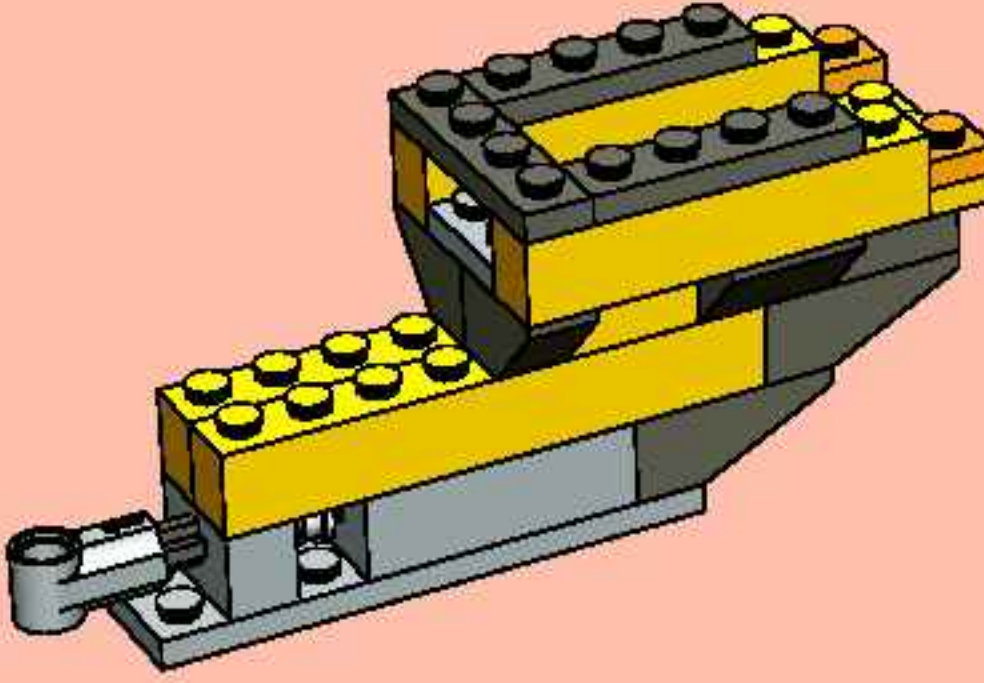

10

1x 

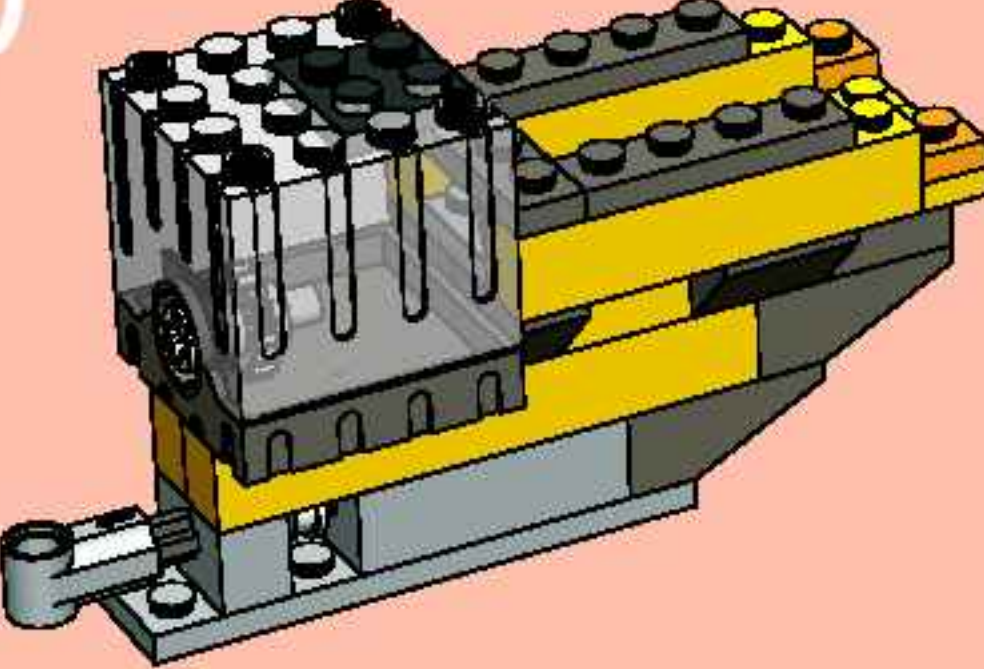



11

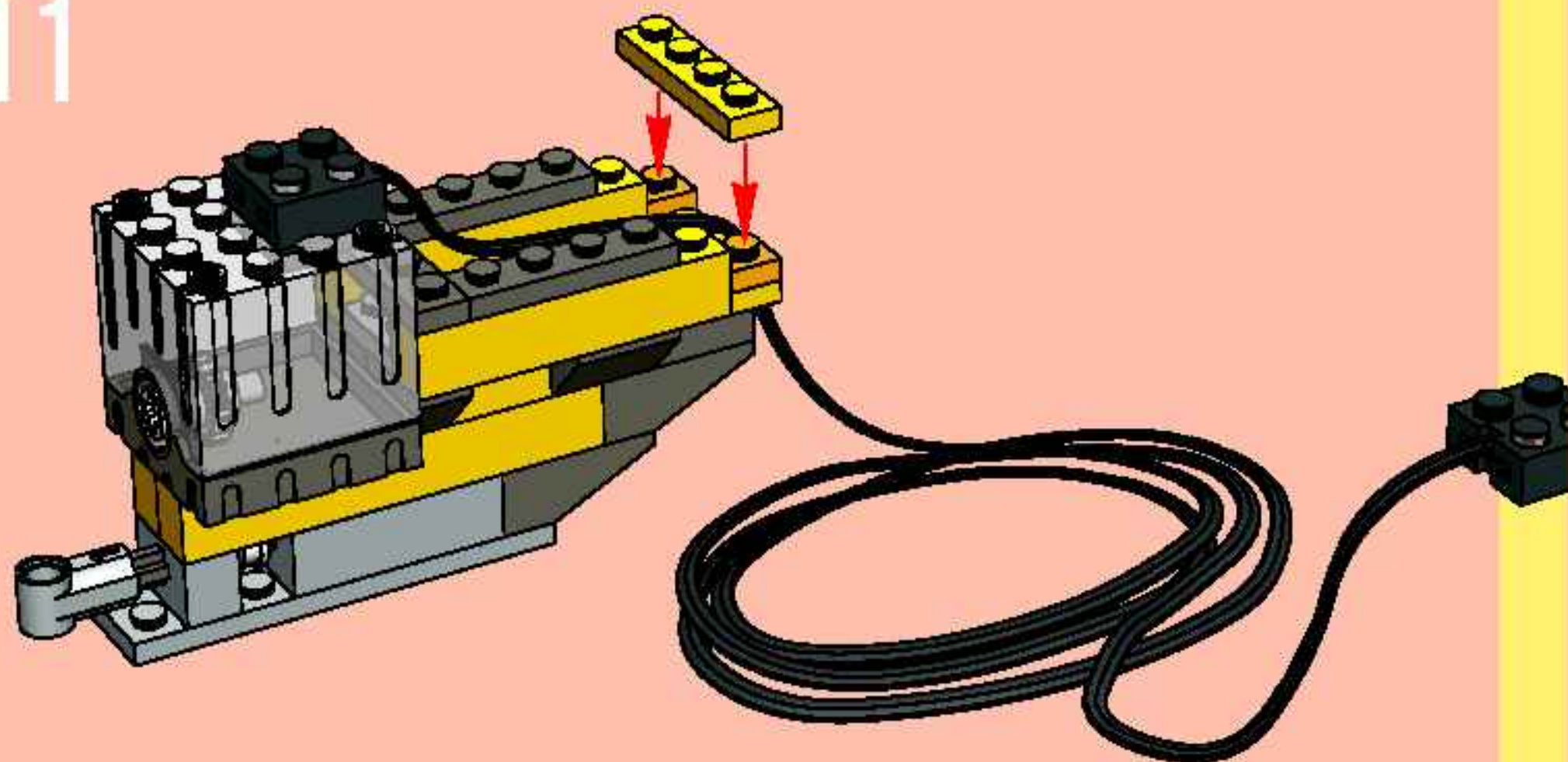

12

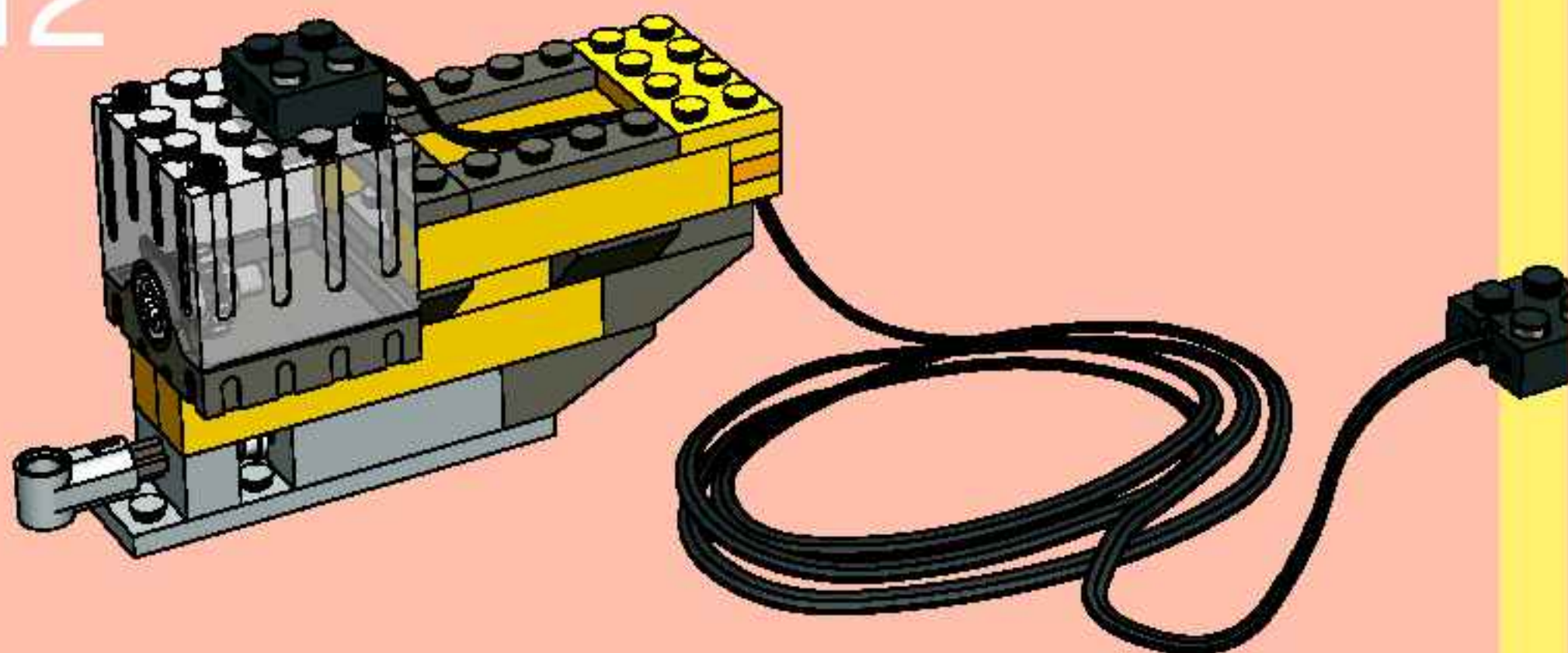

13

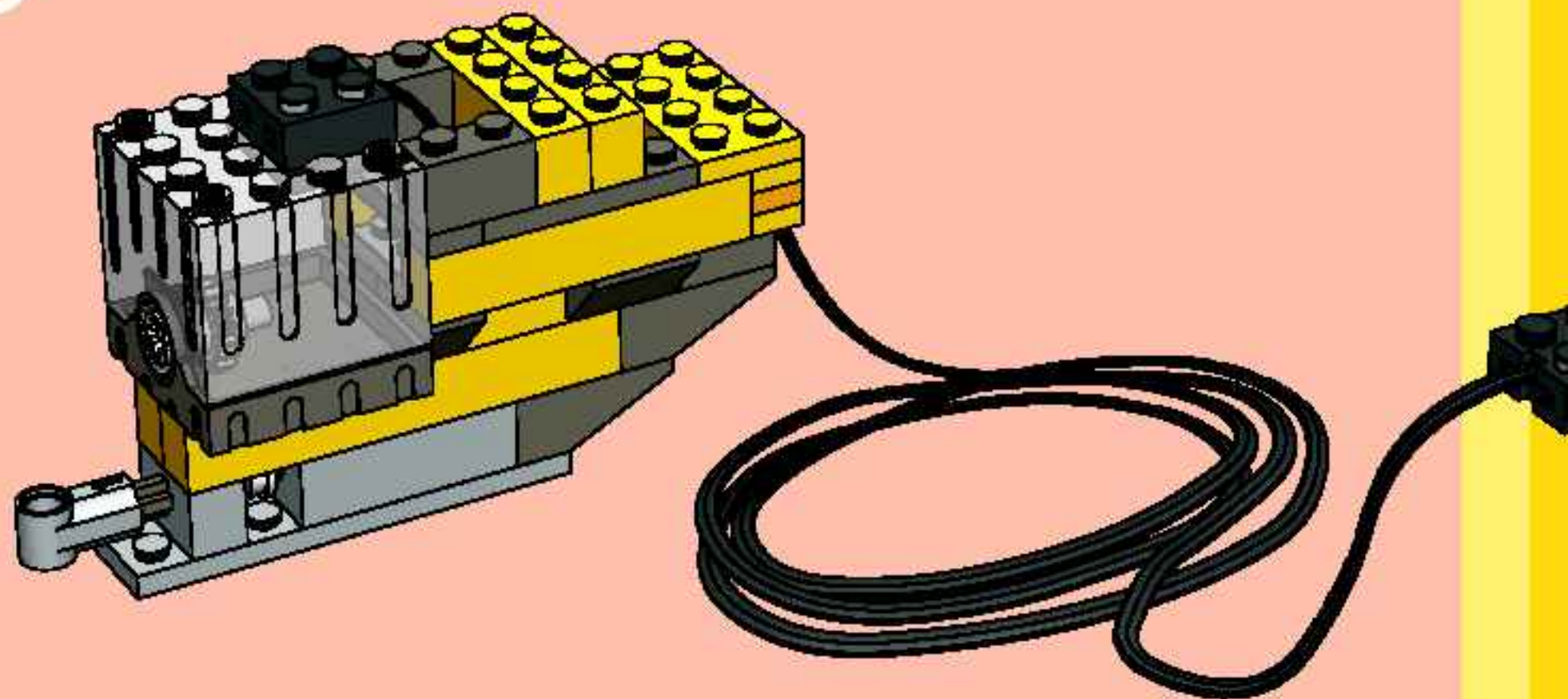

14

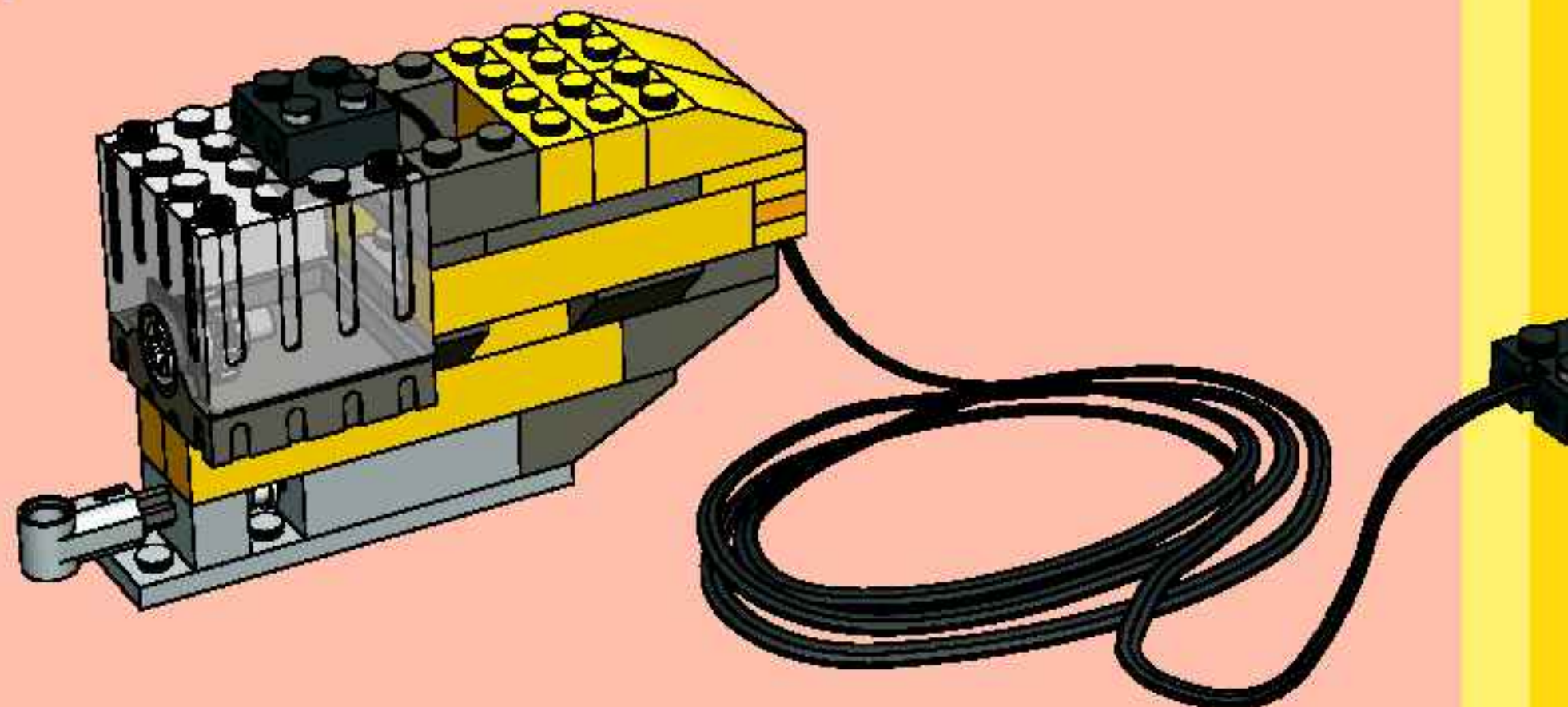

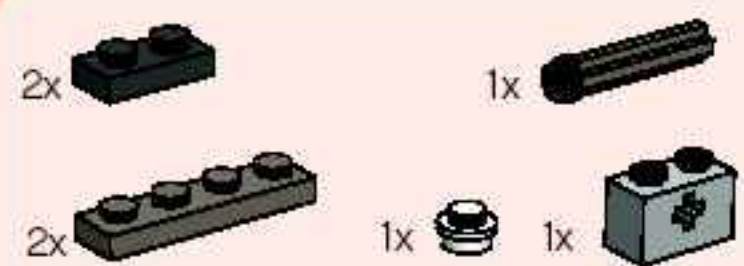

15

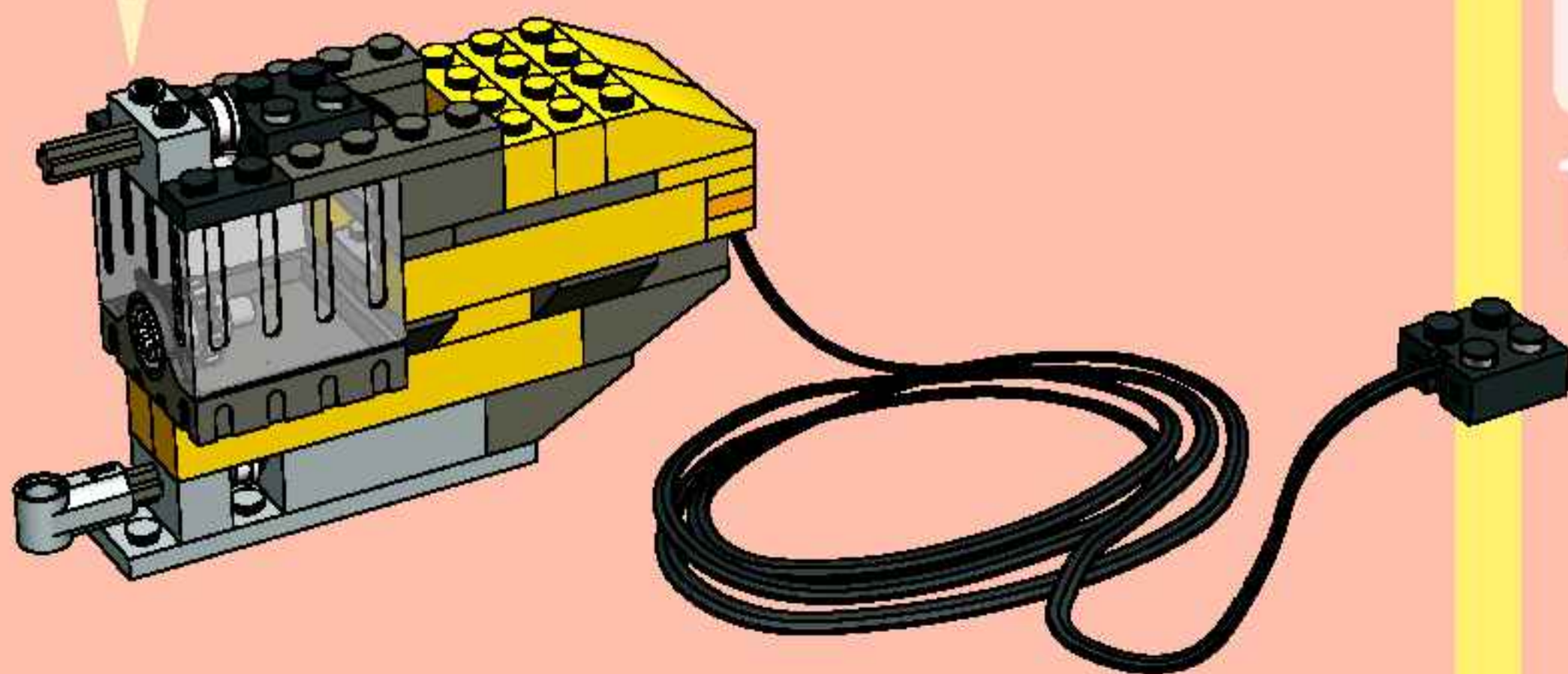
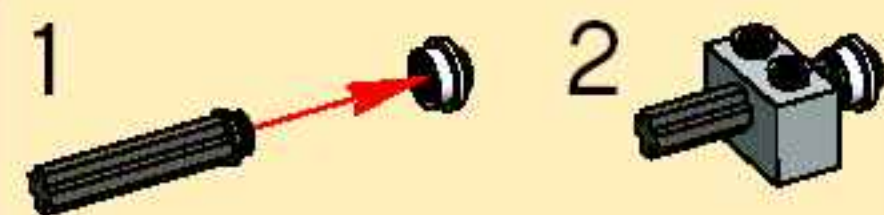

16

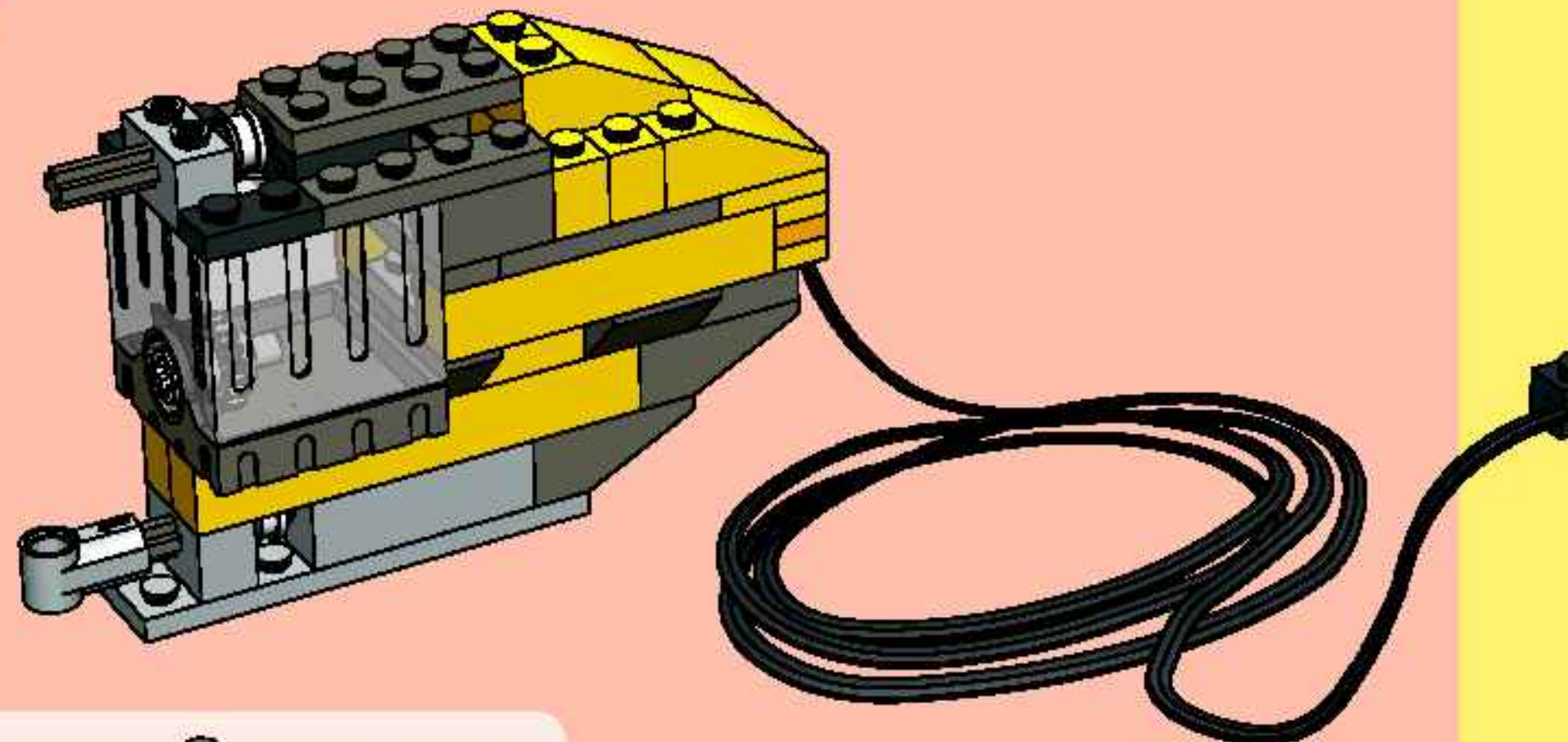

17

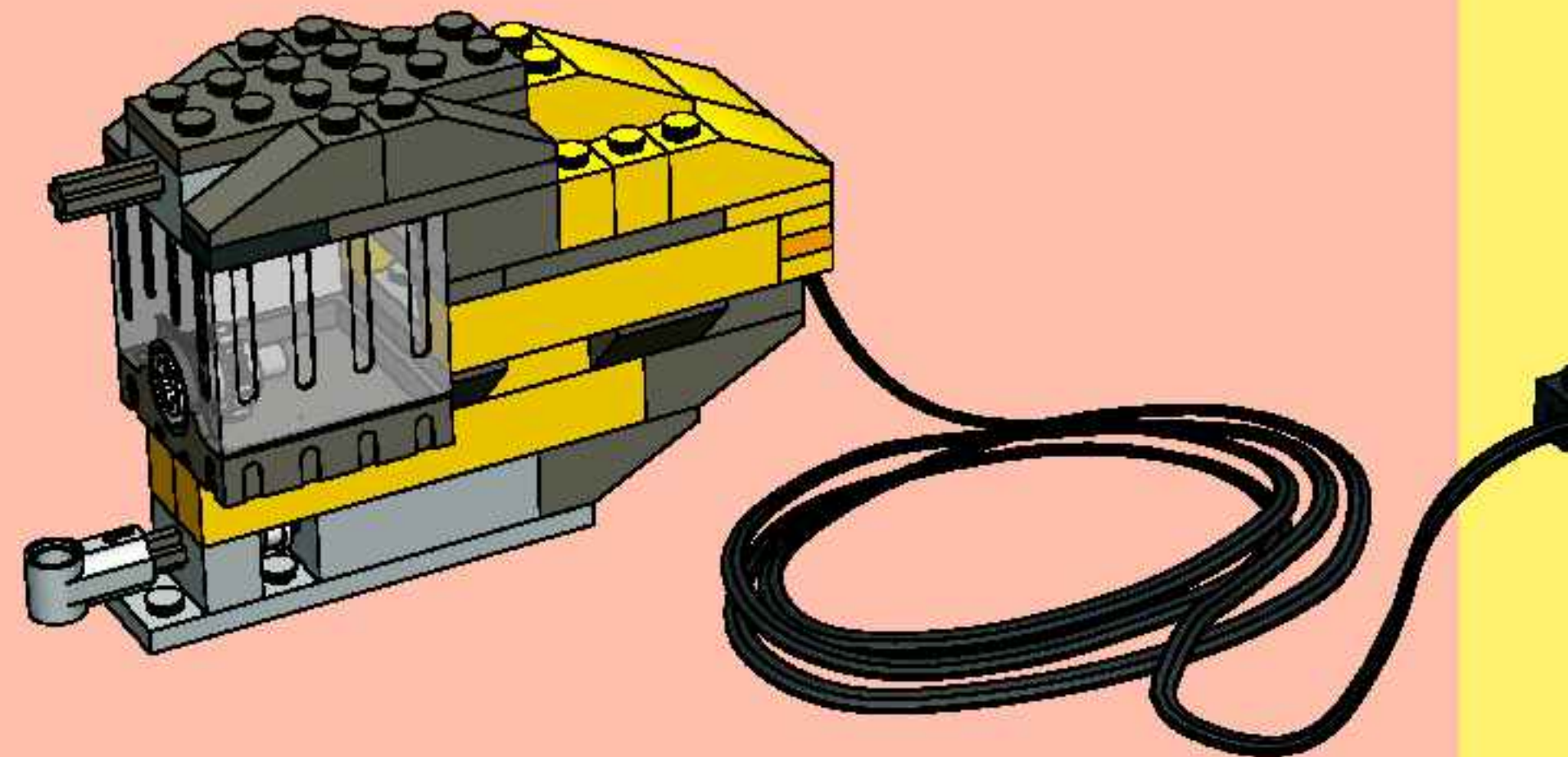



- 1x
- 1x

18

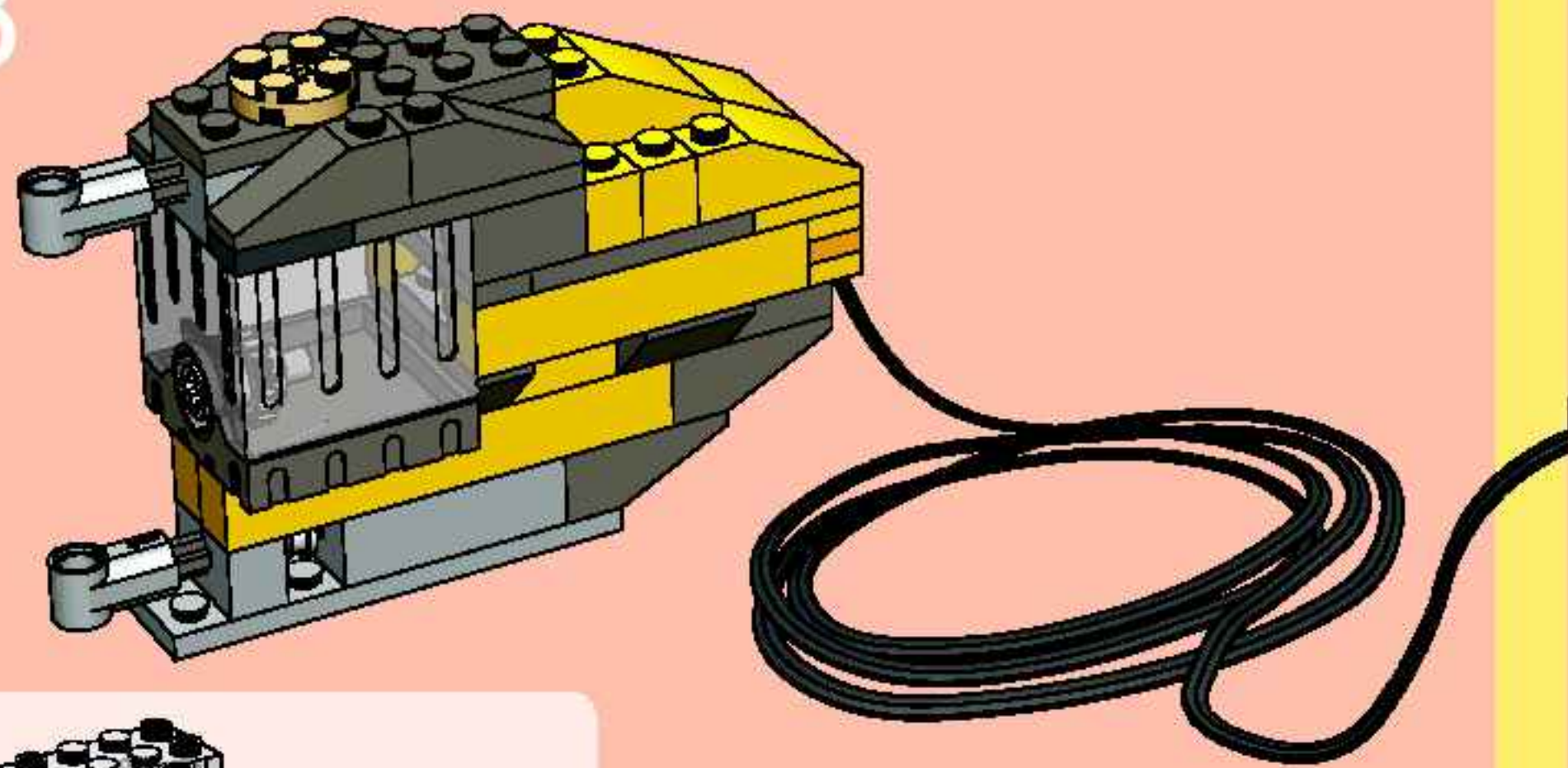

- 1x
- 1x

19

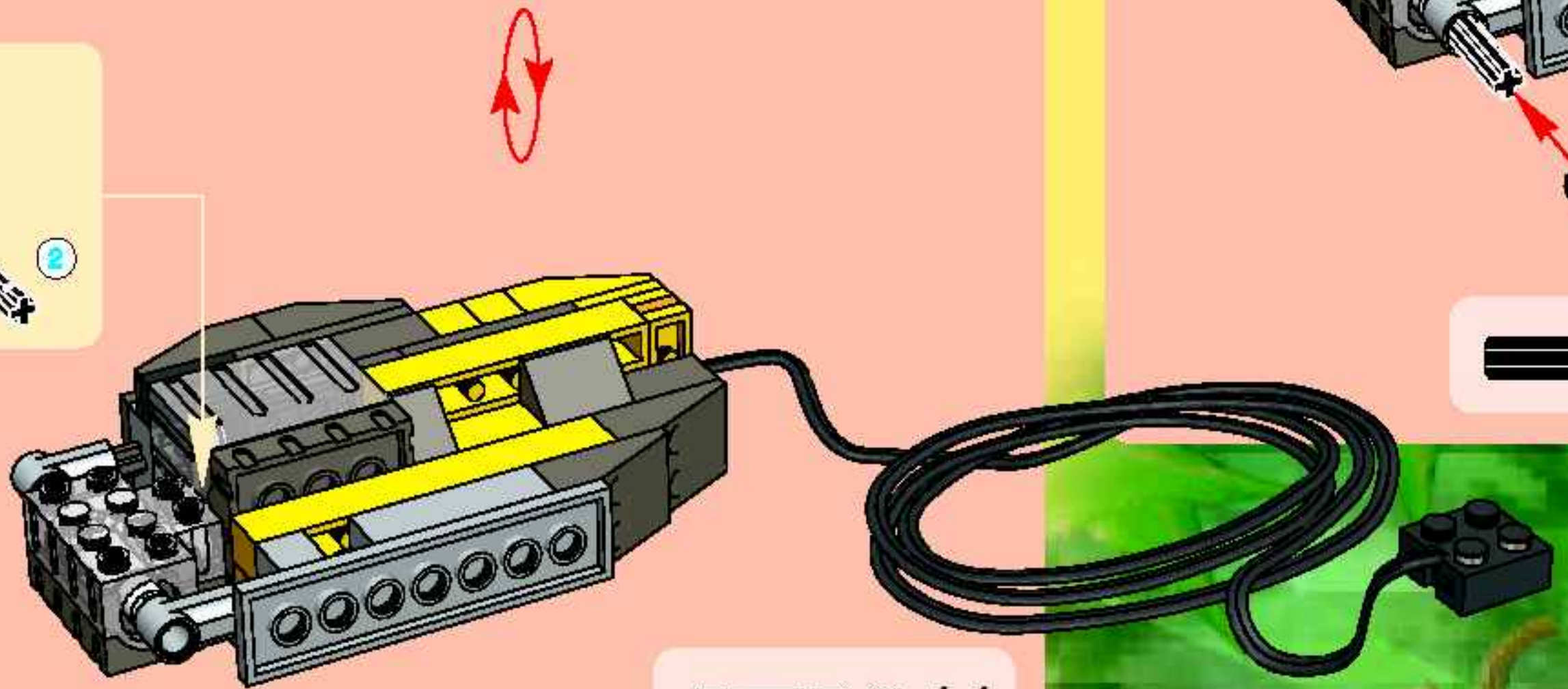
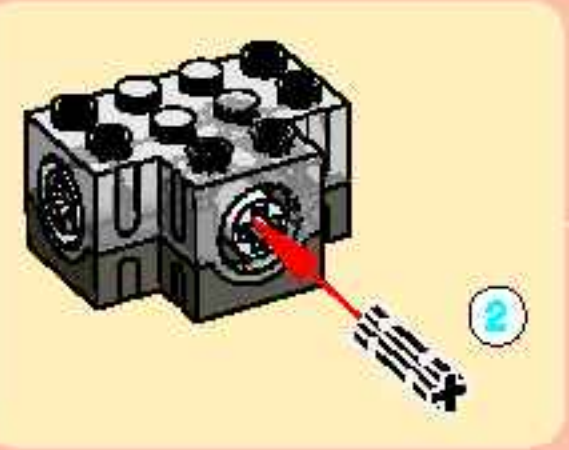

- 1:1

- 1x
- 1x
- 1x

20

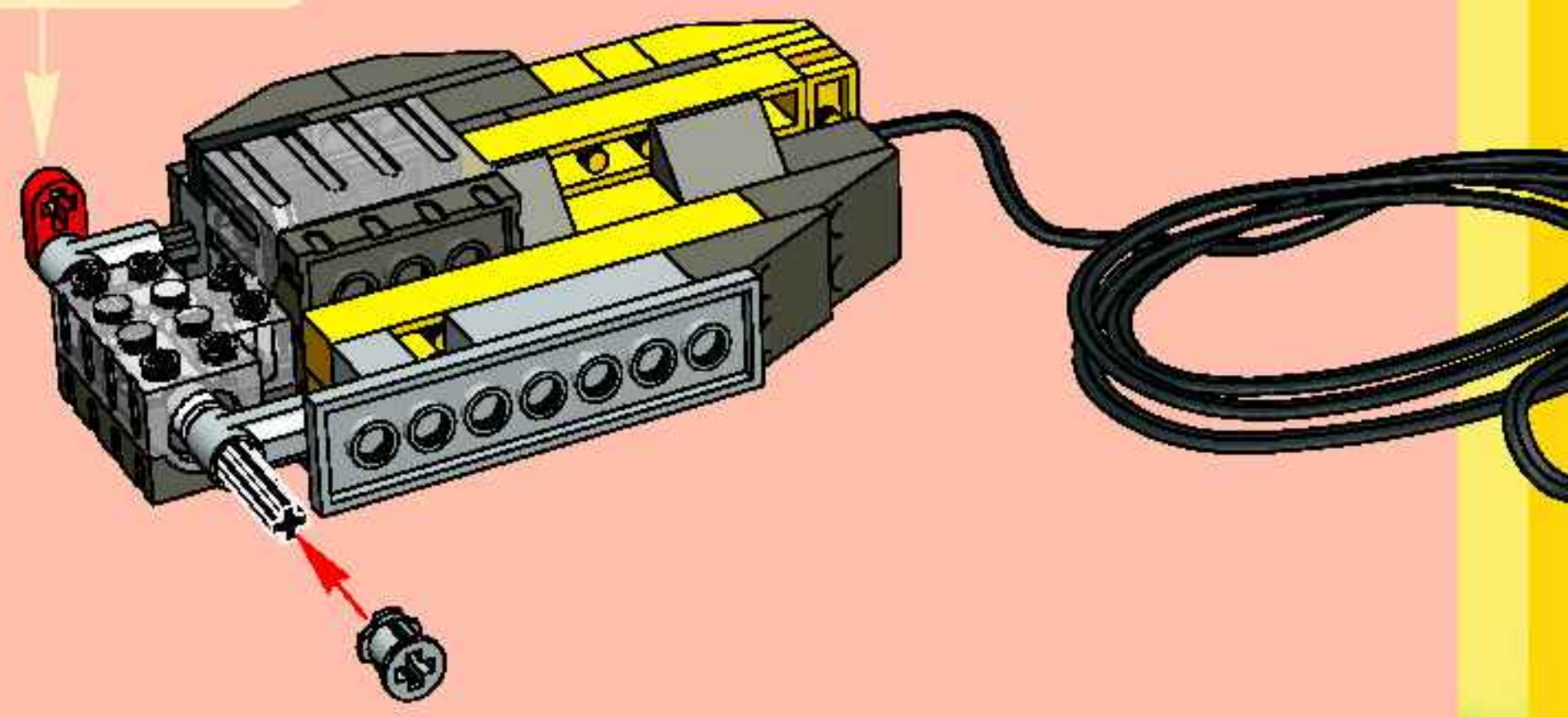
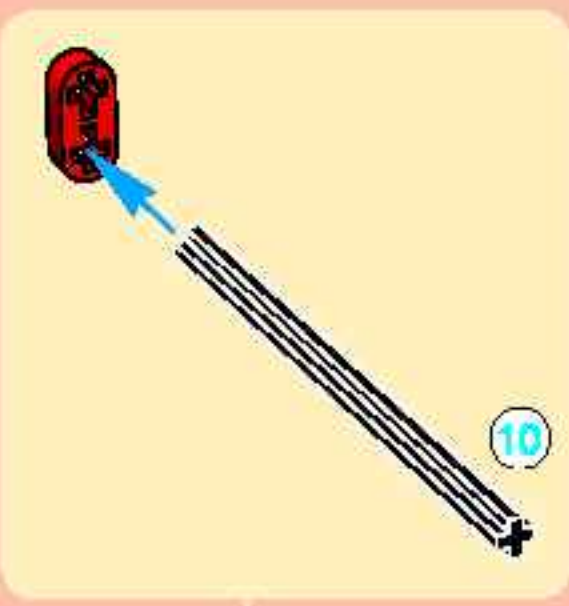

- 1:1





21

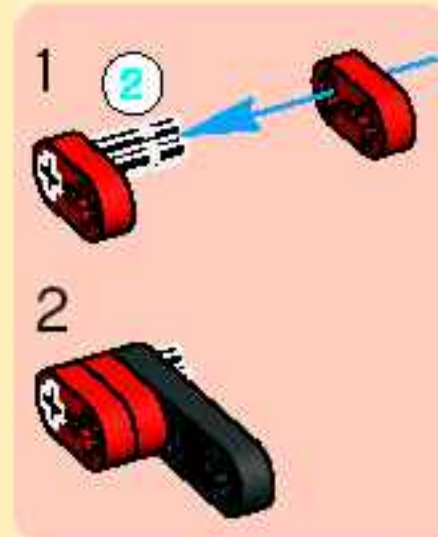
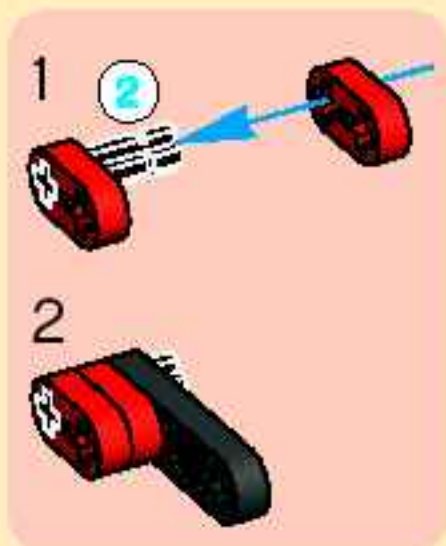

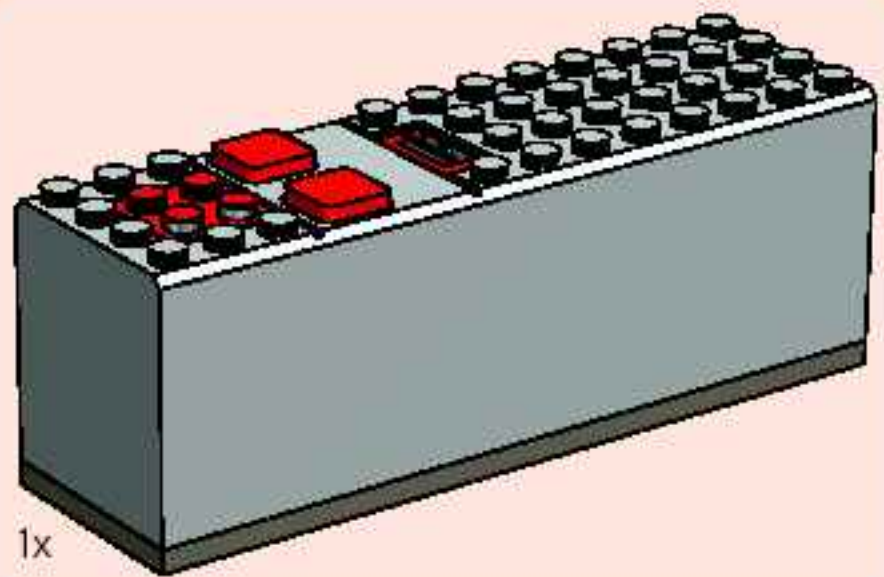

1x

22

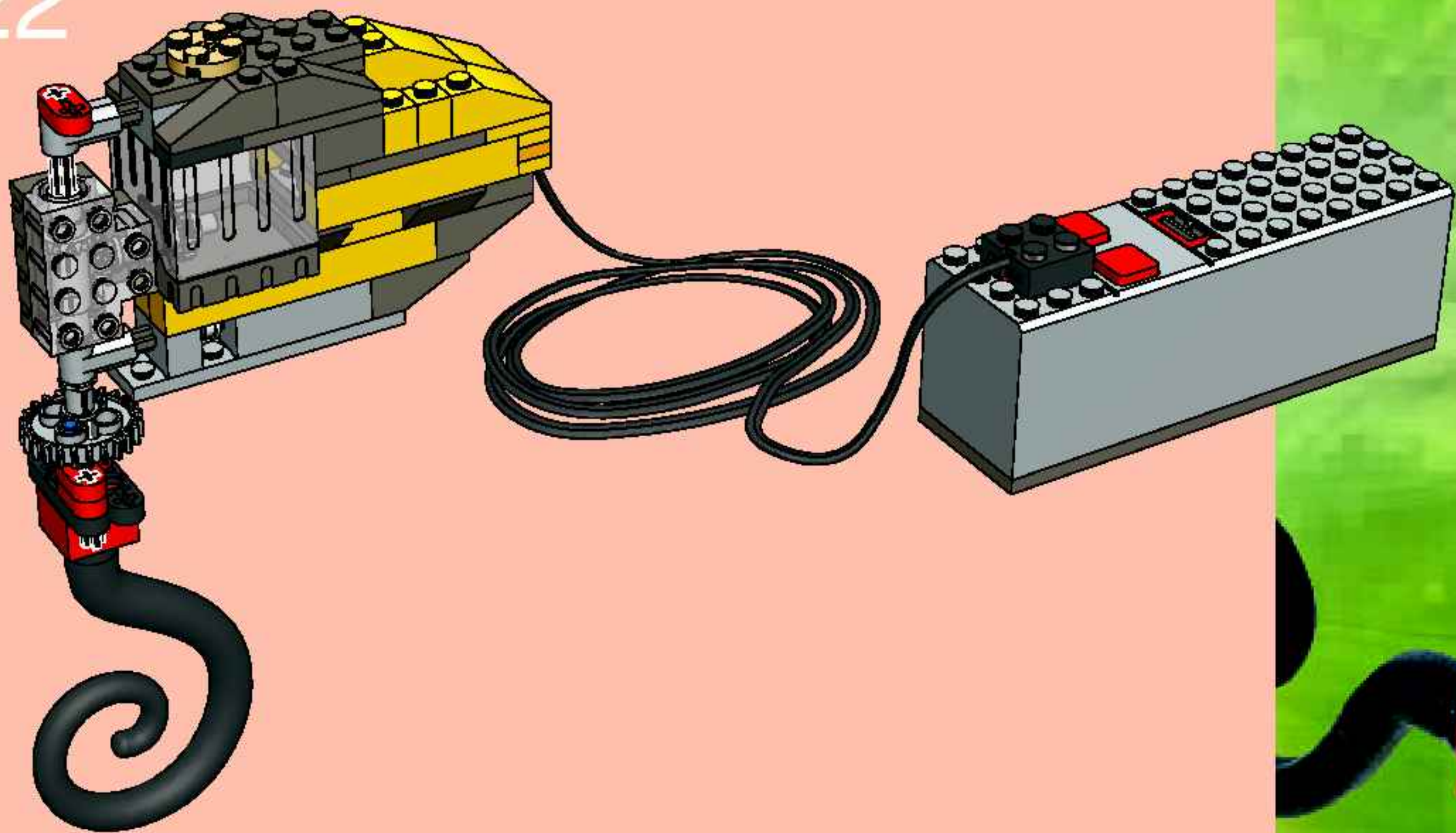



# Inventor



4093



4090

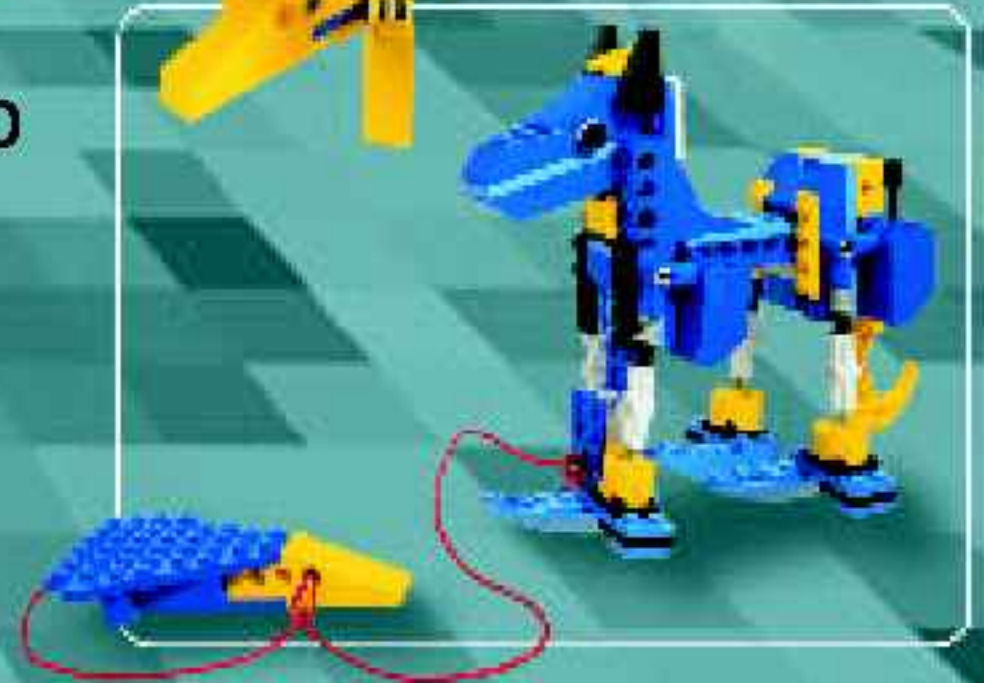

4095



4/2003

©2003 LEGO Group.

