

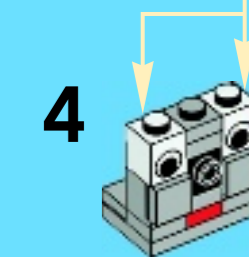

40053

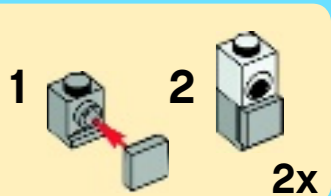

6028393

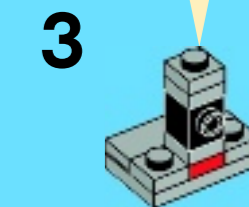
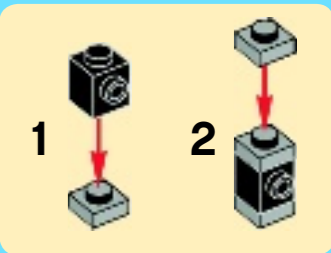
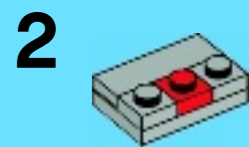
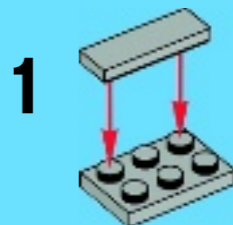
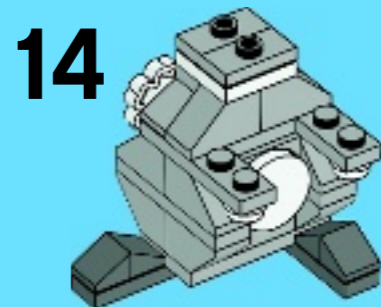
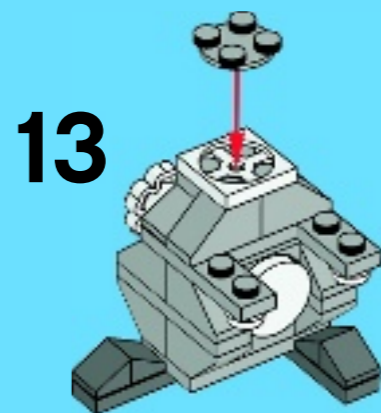
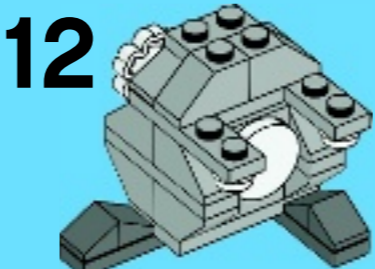
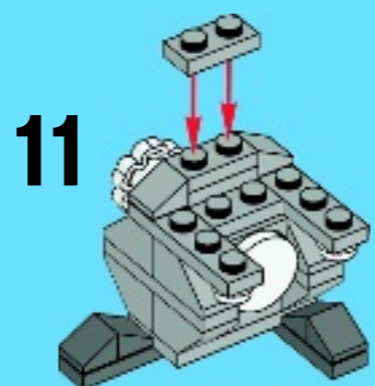
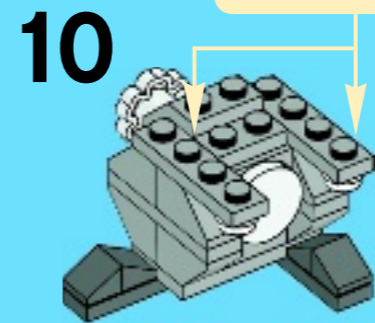
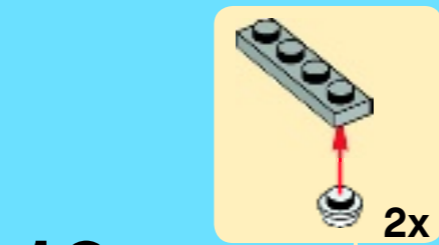
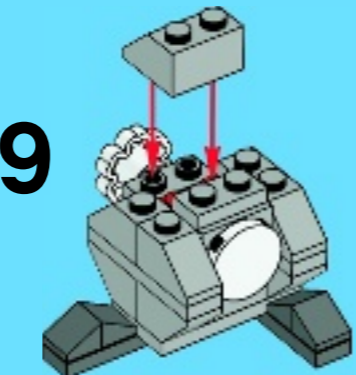
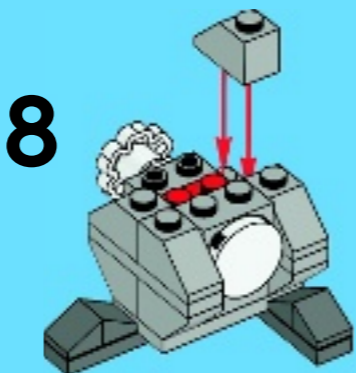
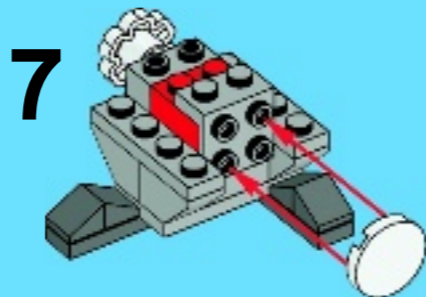
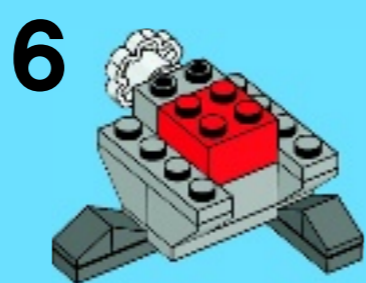
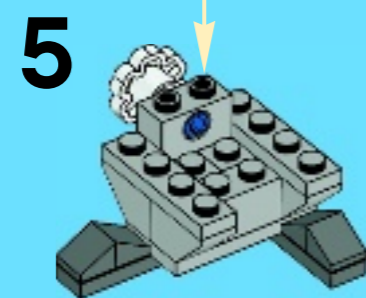
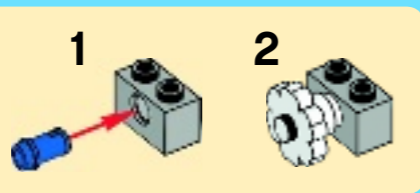
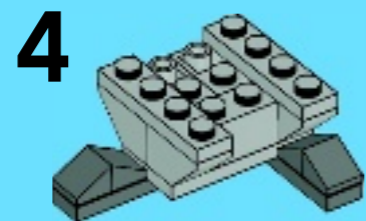
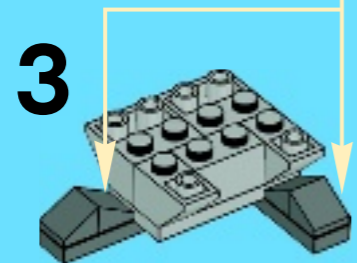
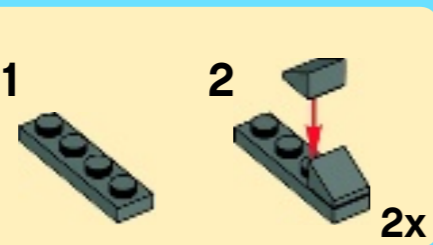
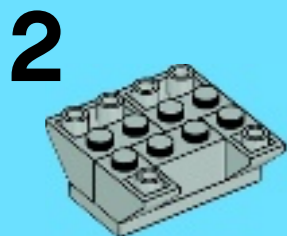
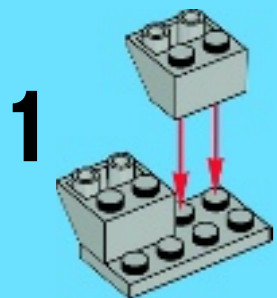

5

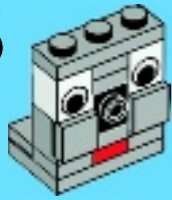

1

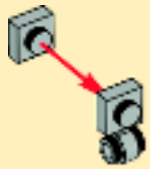

2

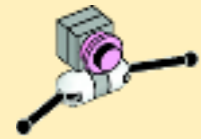

6

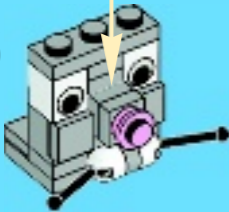

1

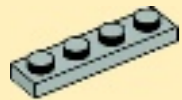

2

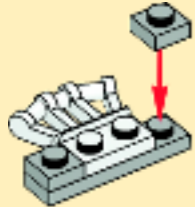

3

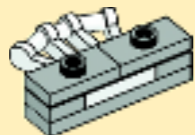

7

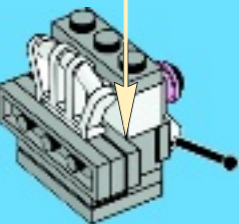

15

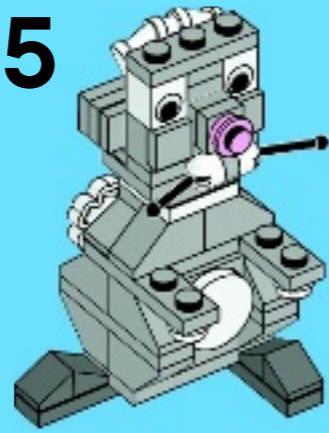

1

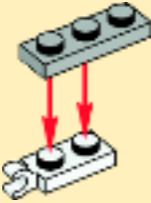

2

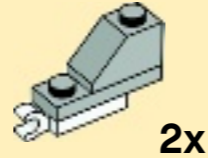

2x

16

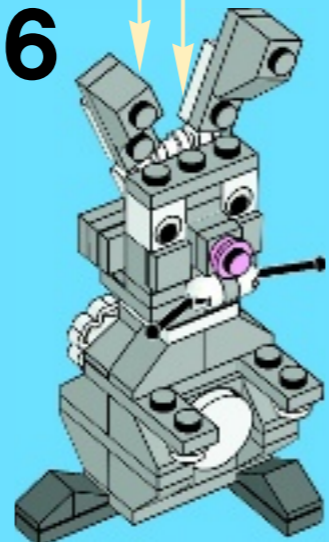

1

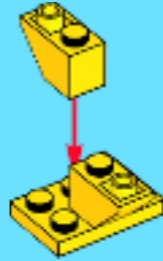

2



3



4

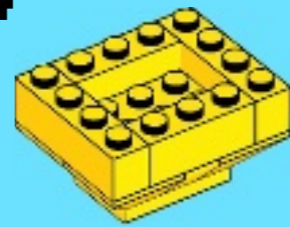

5

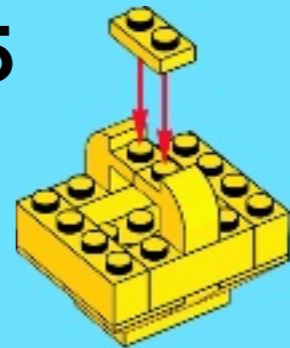

6

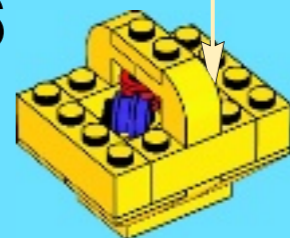

- 2x 4569080
- 1x 415001
- 2x 4535737
- 1x 4622937
- 2x 614101
- 1x 6000019
- 2x 73737
- 1x 368001
- 1x 300321
- 1x 302421
- 2x 614121
- 1x 4143005
- 2x 362224
- 2x 301024
- 2x 366524
- 4x 4264338
- 2x 4188357
- 3x 4211398
- 4x 4211451
- 3x 4211429
- 1x 302324
- 2x 302124
- 1x 4558954
- 2x 4157103
- 2x 4183133
- 1x 4211388
- 2x 4211476
- 1x 4211440
- 2x 4521921
- 2x 4211437
- 8x 4211614
- 1x 4211410
- 2x 4211436
- 8x 4211399
- 1x 4211396
- 5x 4211445
- 1x 4211395
- 2x 4211415
- 1x 4632575
- 1x 6009014
- 1x 4558169
- 1x 4540203
- 4x 4504378
- 2x 4211001
- 1x 4517996
- 2x 4566522