

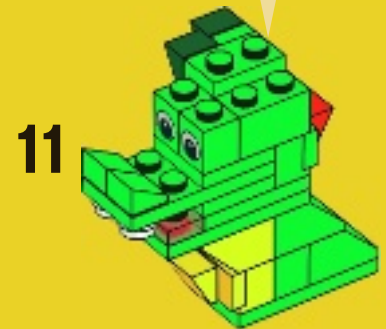

40019

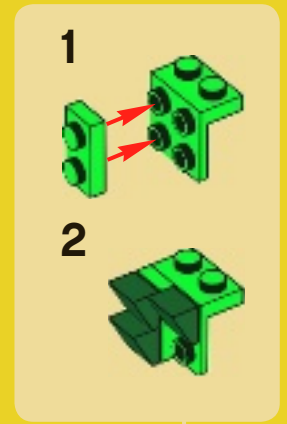

4625265

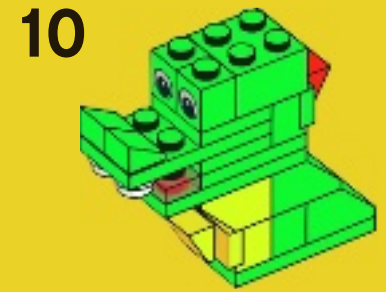
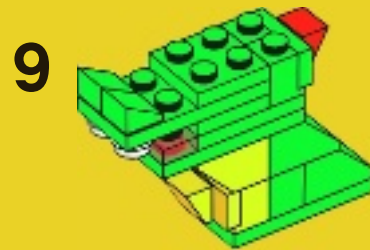
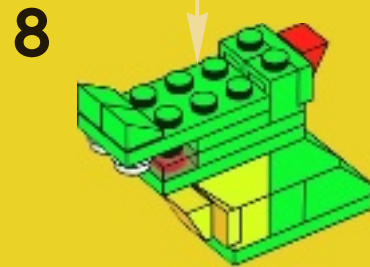
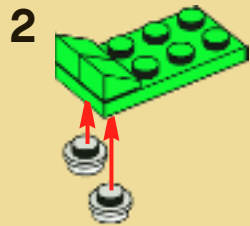
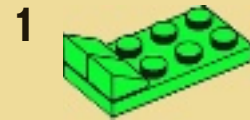
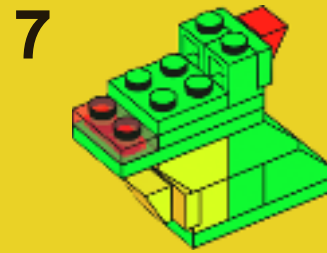
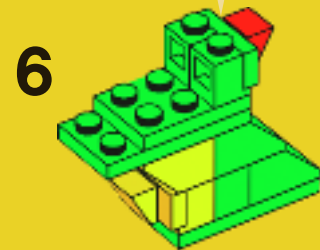
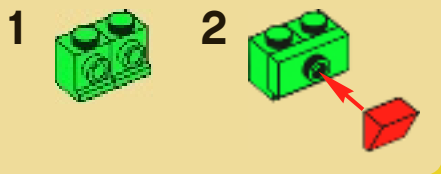
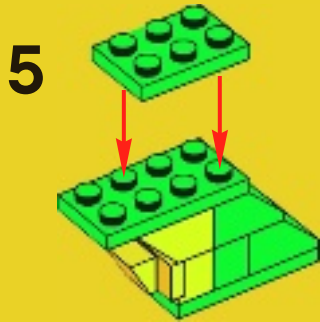
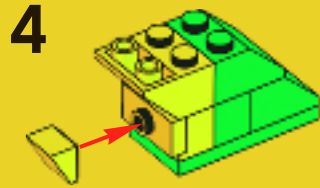
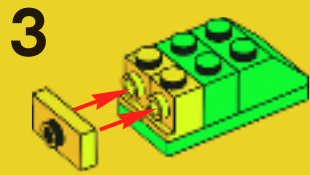
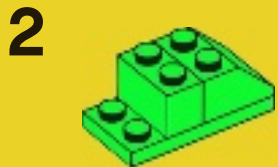

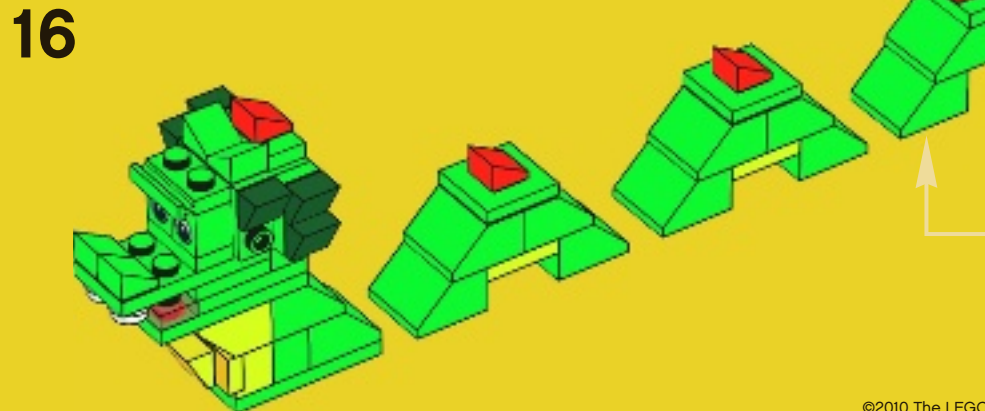
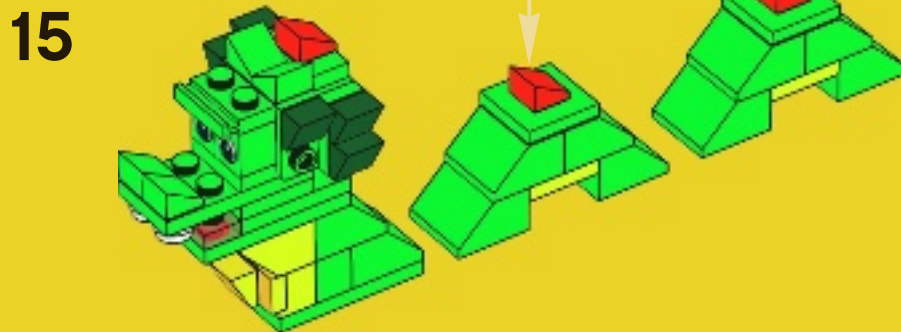
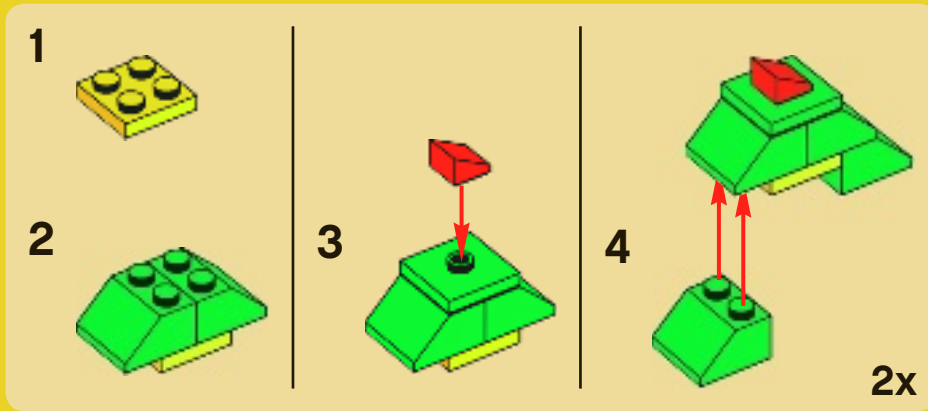
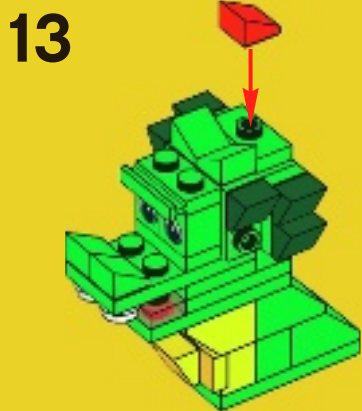
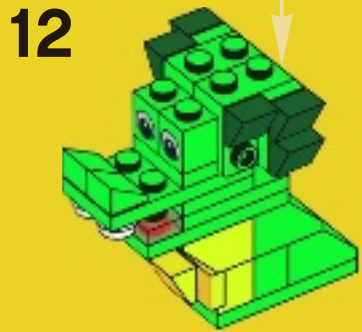
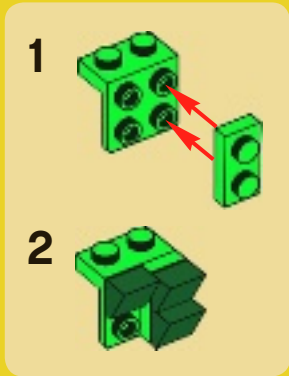

- | | | |
|---------------|---------------|---------------|
| 1x
4107736 | 2x
614101 | 3x
379428 |
| 1x
300328 | 5x
4504379 | 2x
4212471 |
| 2x
4187334 | 2x
407024 | 1x
4272665 |
| 4x
4546705 | 1x
4504381 | 2x
4565321 |
| 12x
303928 | 1x
366024 | 1x
4201019 |
| 2x
302328 | 2x
302224 | 6x
4504375 |
| 2x
302228 | 1x
379424 | |
| 1x
302128 | 2x
4569081 | |
| 3x
302028 | | |

