



nickelodeon

SpongeBob
SQUAREPANTS

3817



1

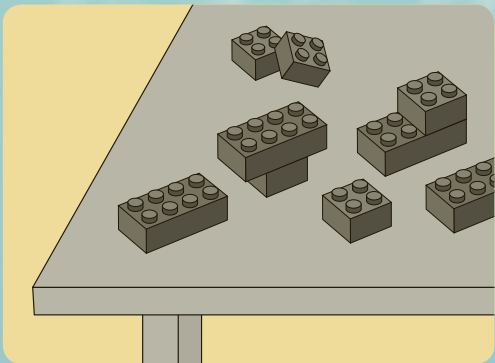
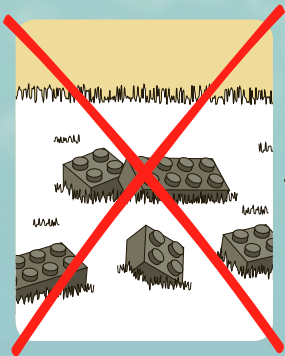

2

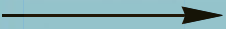

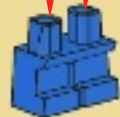
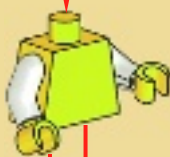



1

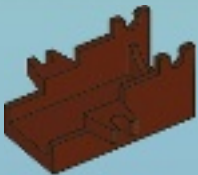

2



3

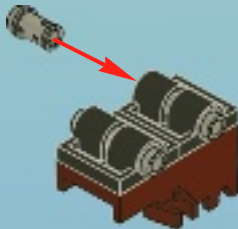

4



5

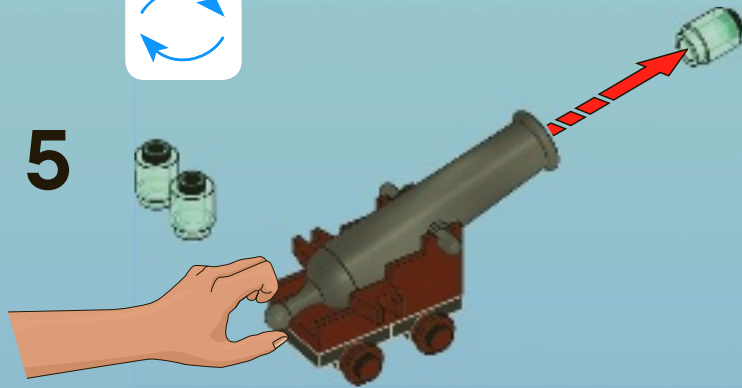



1

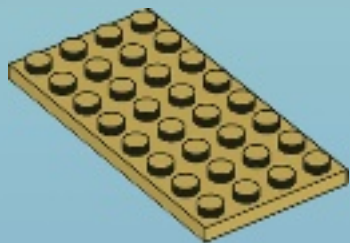

6

2



3

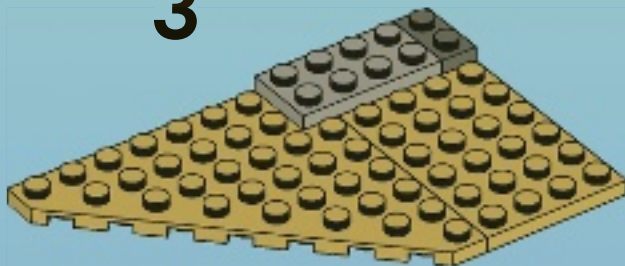

4

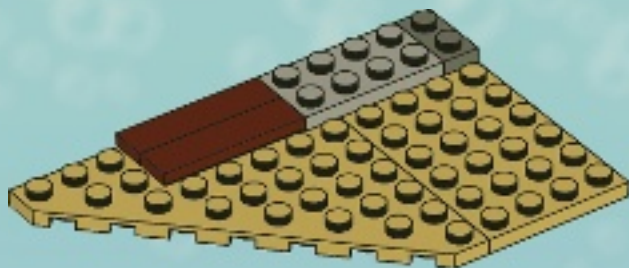

5

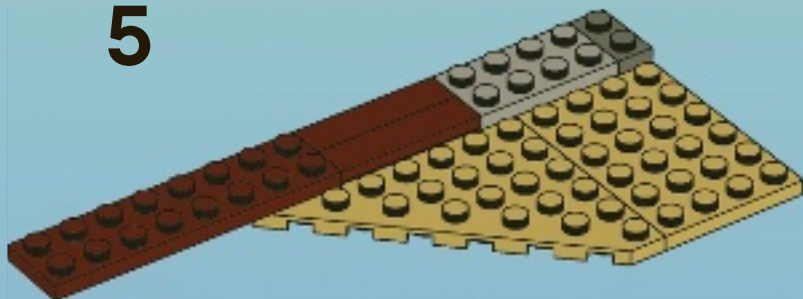



6

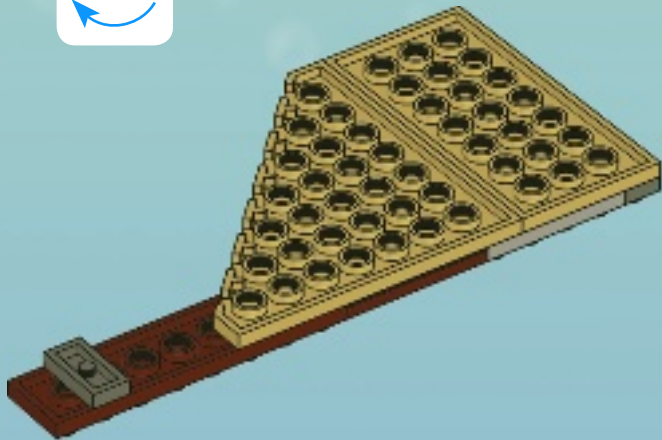

7

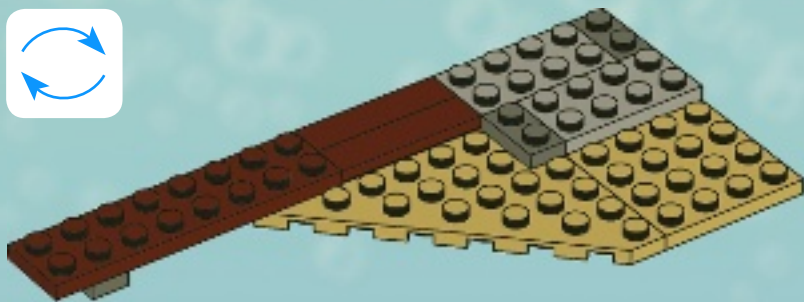

8

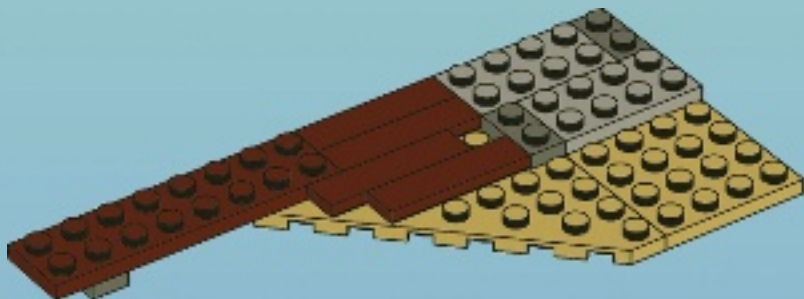

9

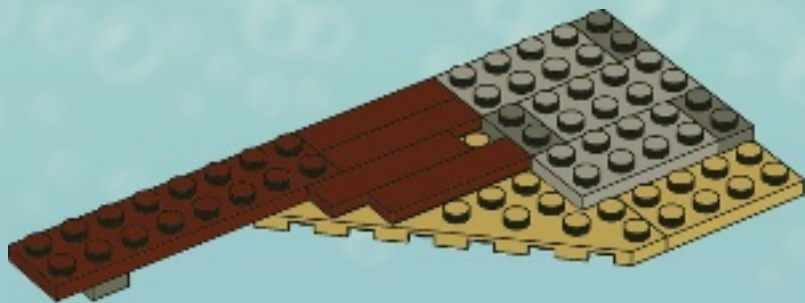

10

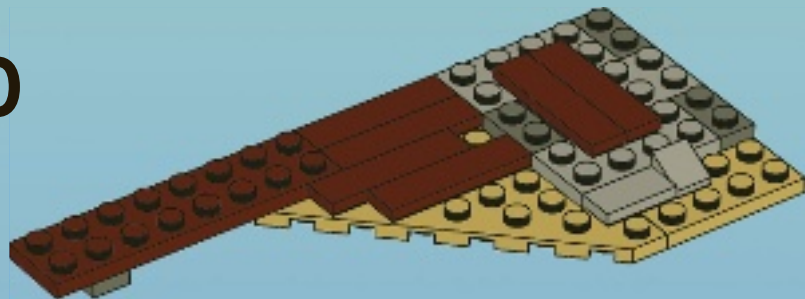

11

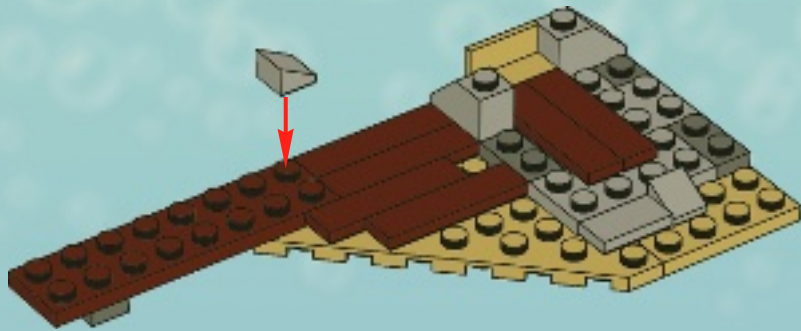

12

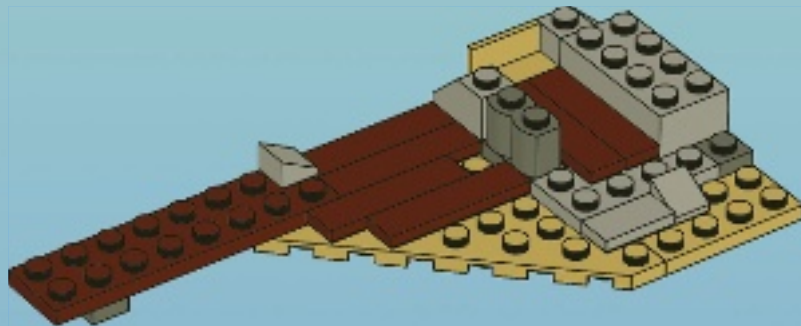

13

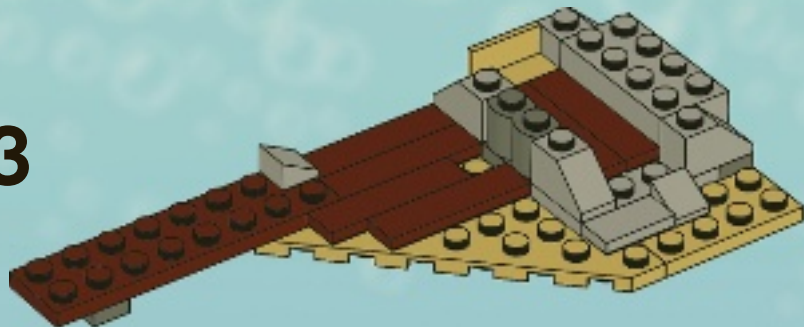

14

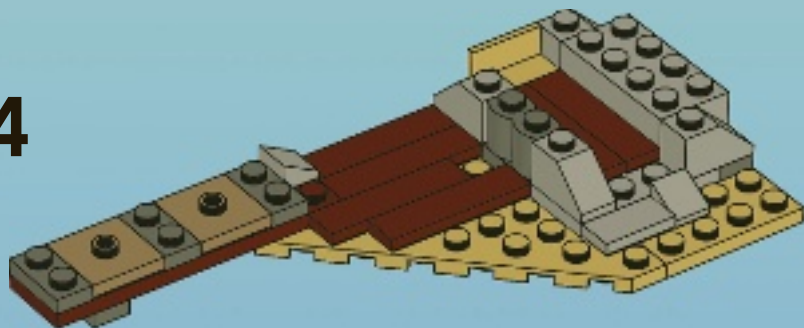

1



2



15

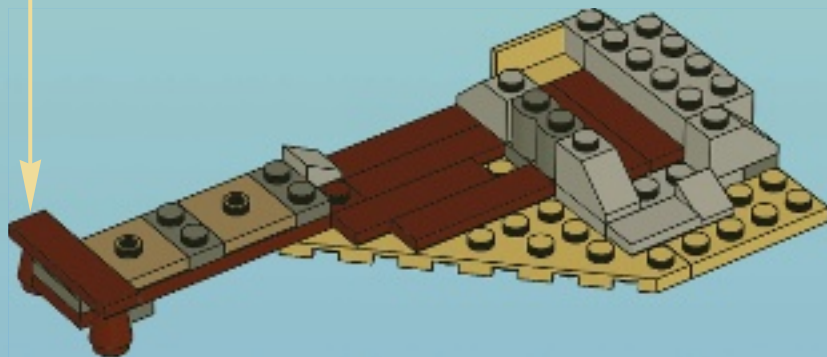

16

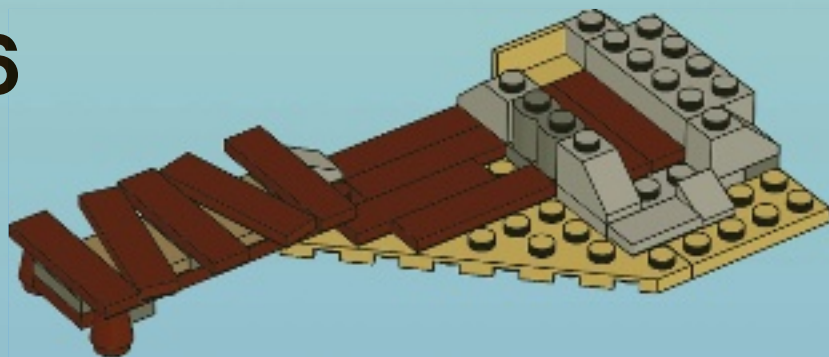

17

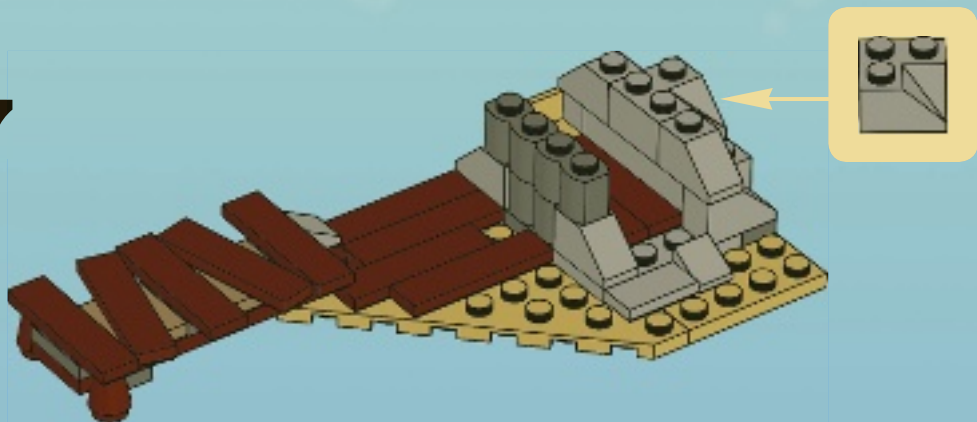

18

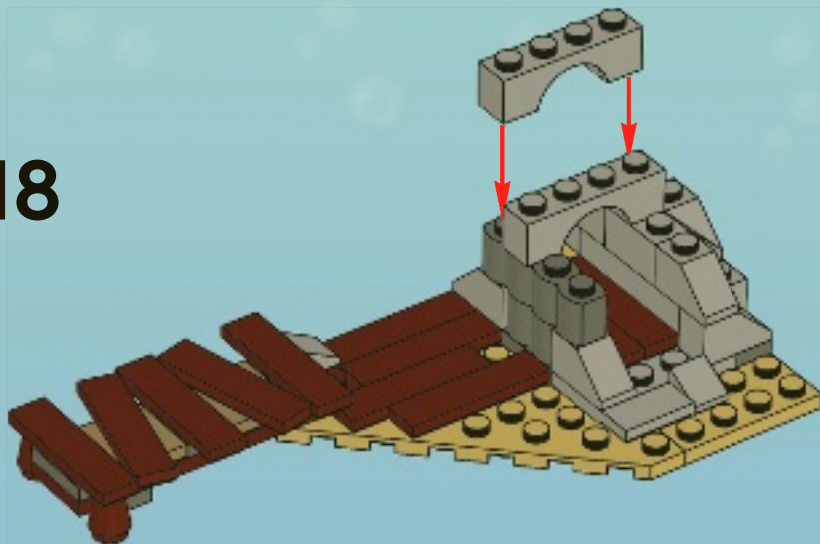

19

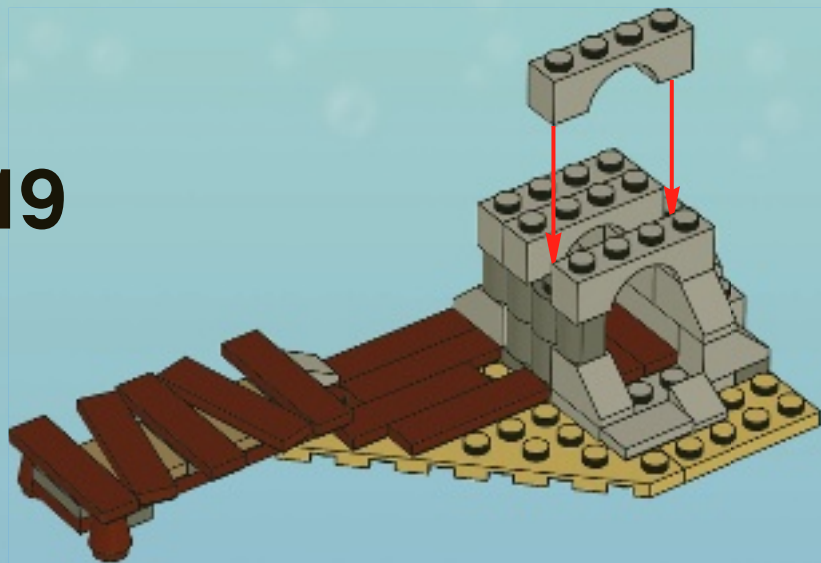

20

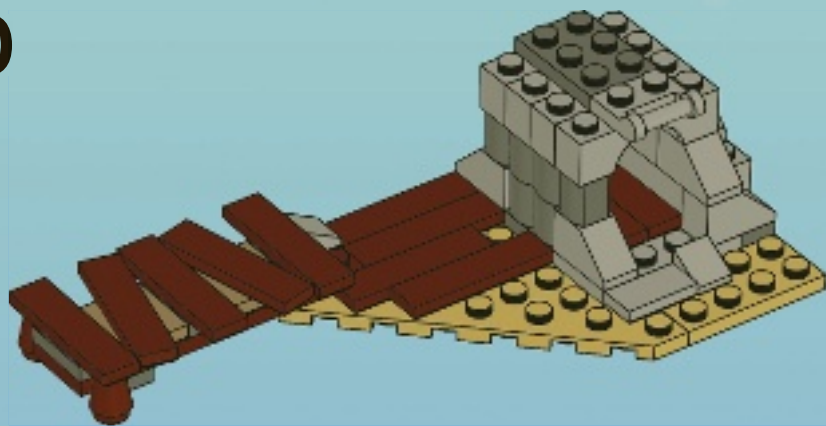

21

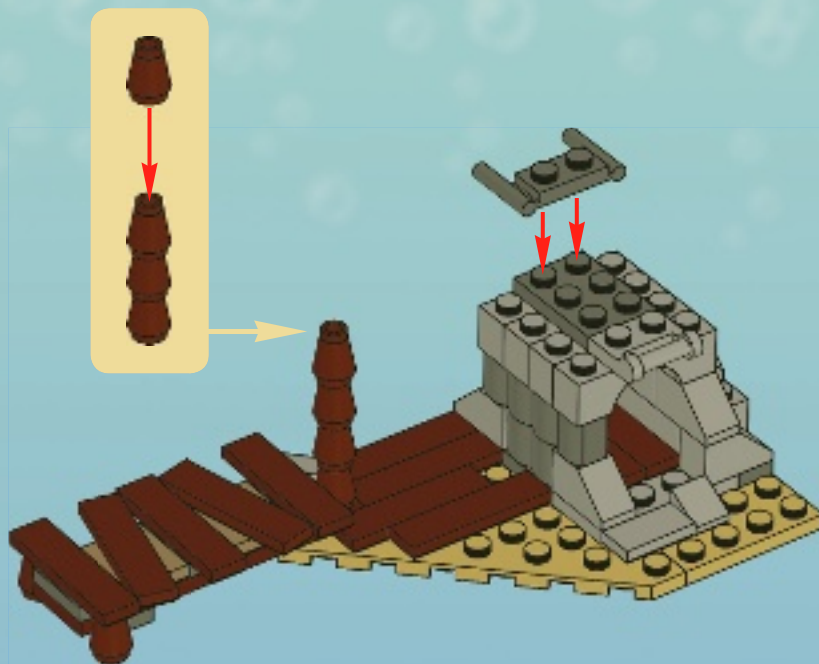

22

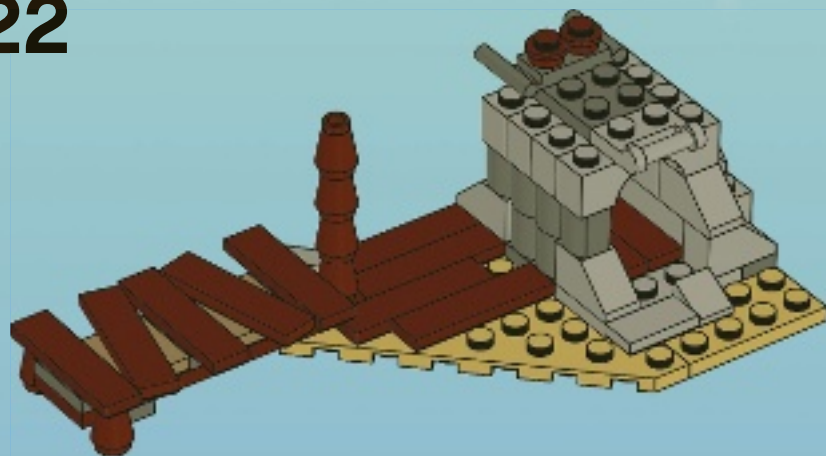

23

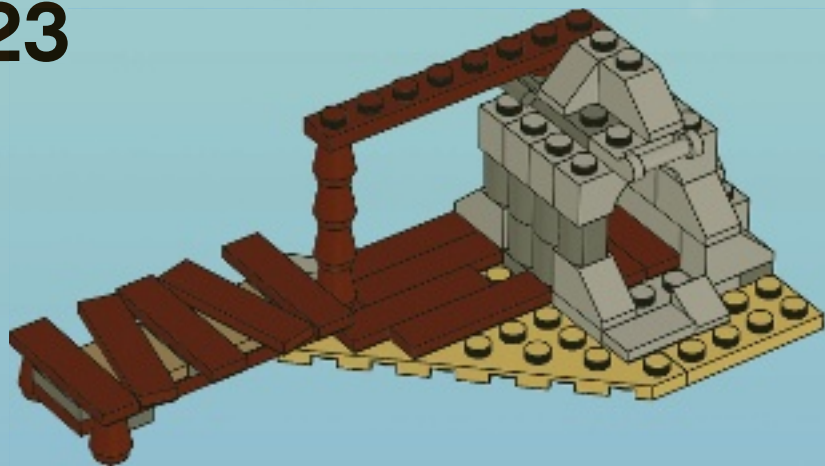

24

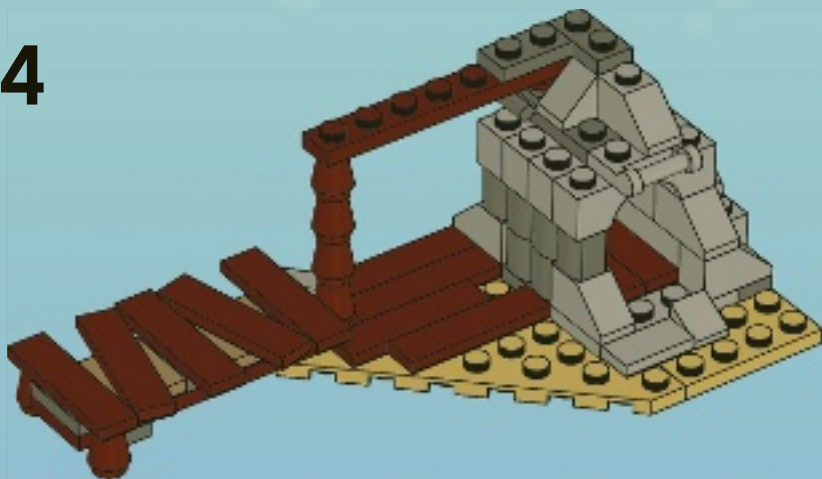



25

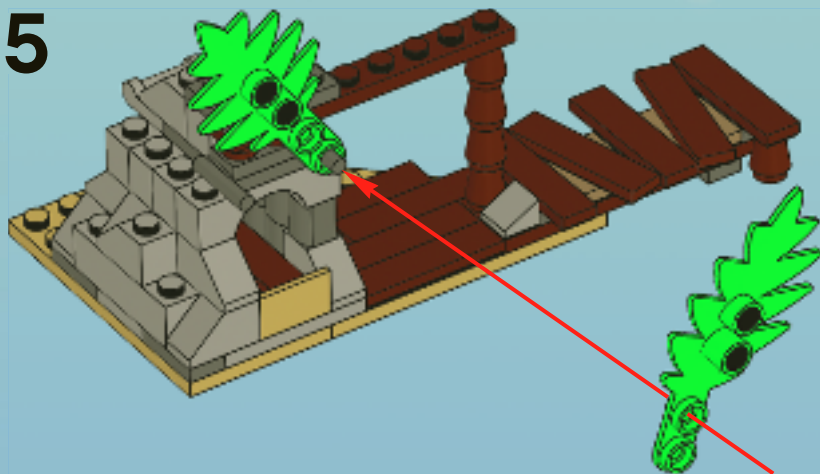



26



28





1

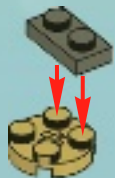

2



3



4



29

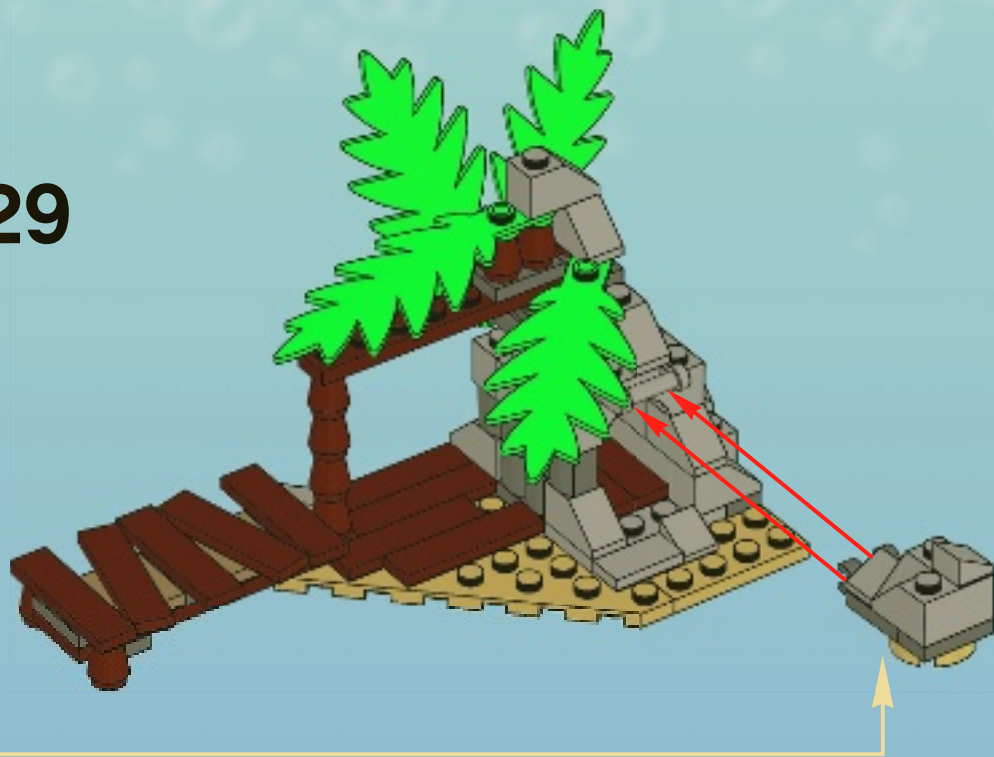

30

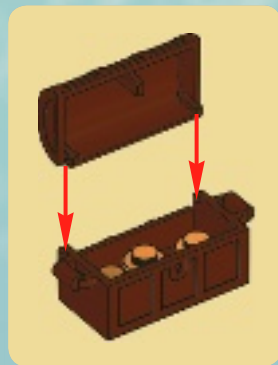

31





1



2



3

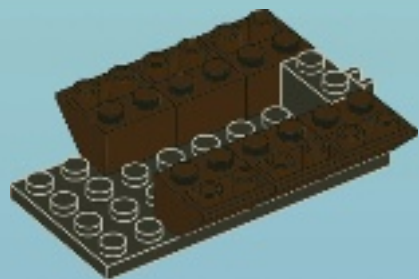

4

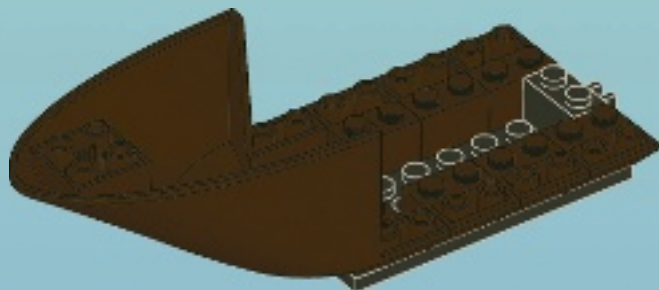

5

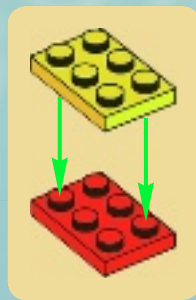
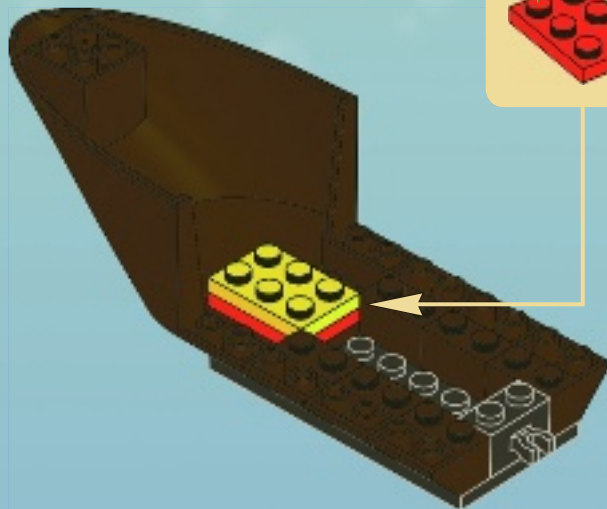

6

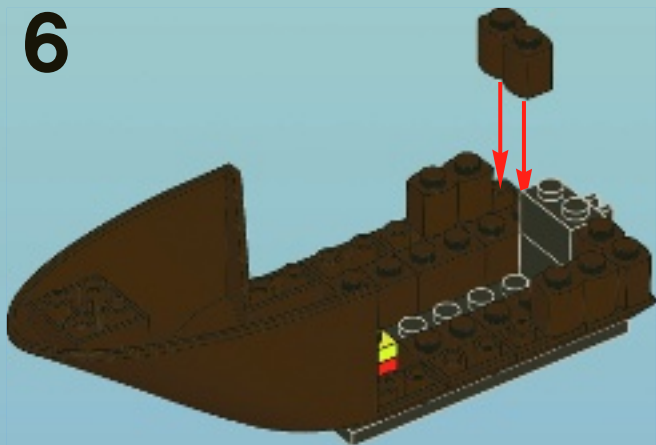

7

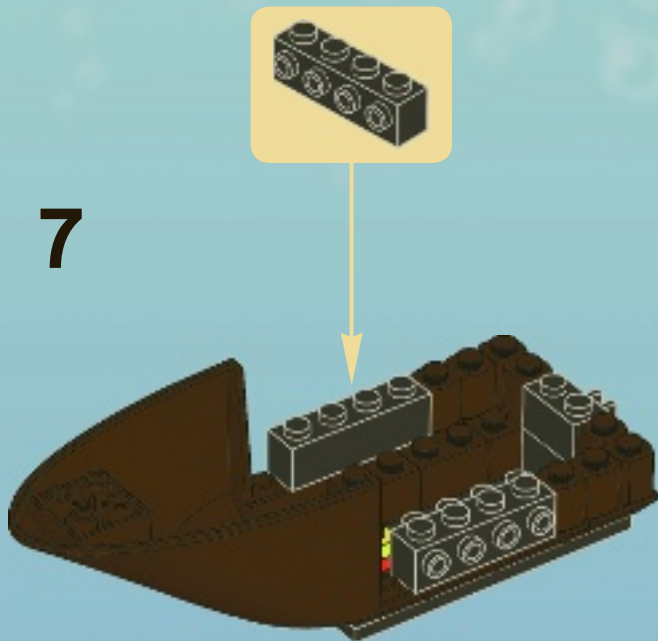

8

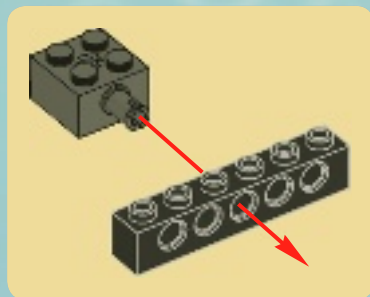
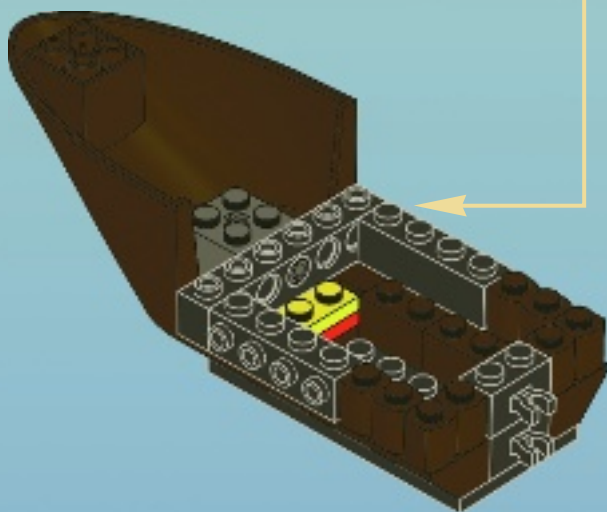

9



10

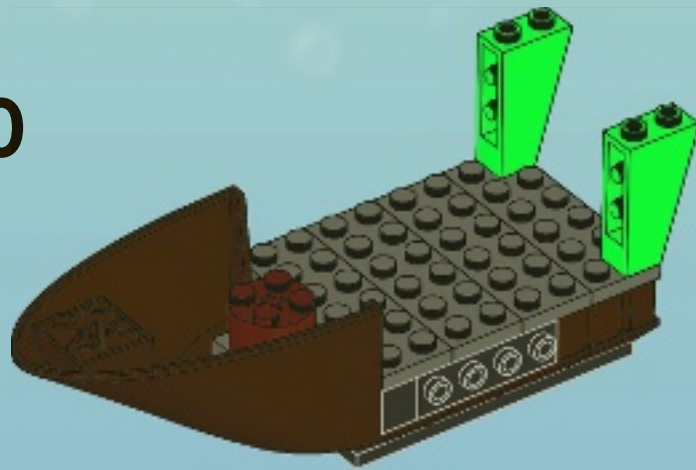

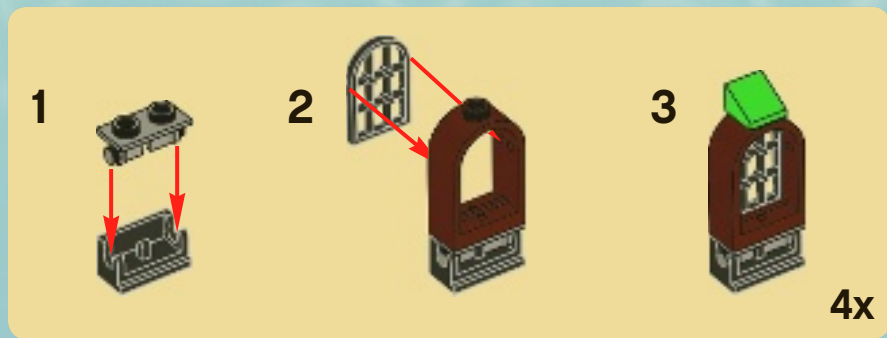

11

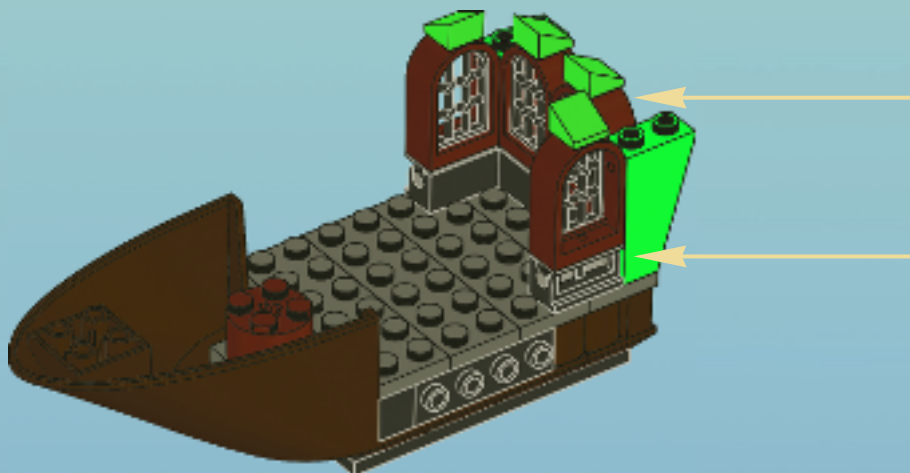

12

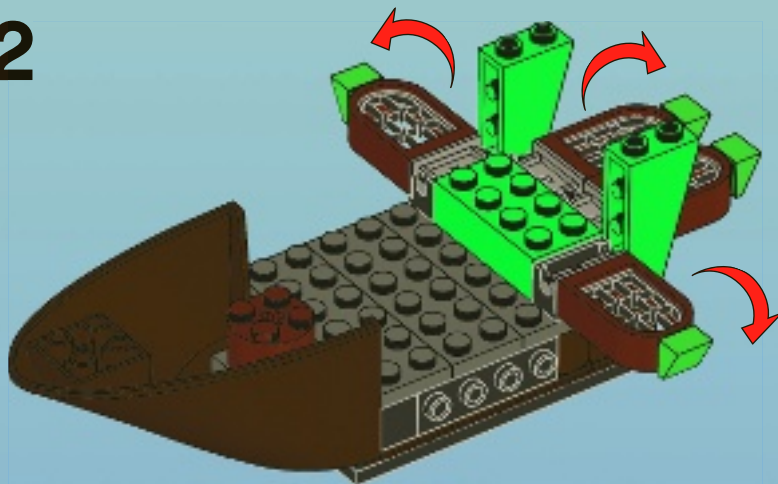

13

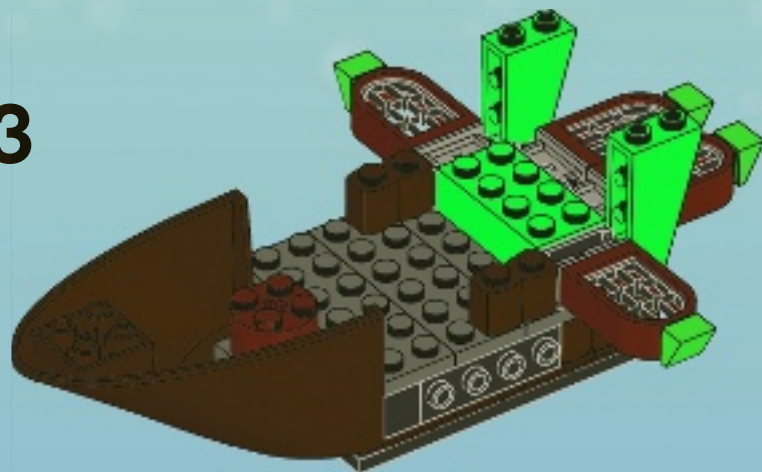

14

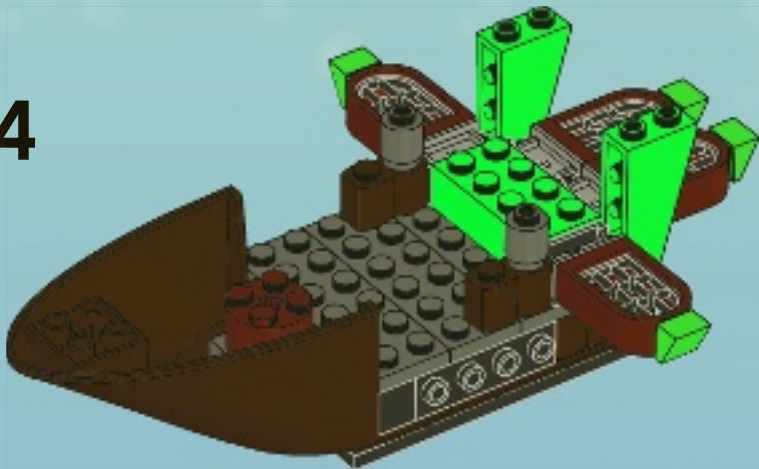

15

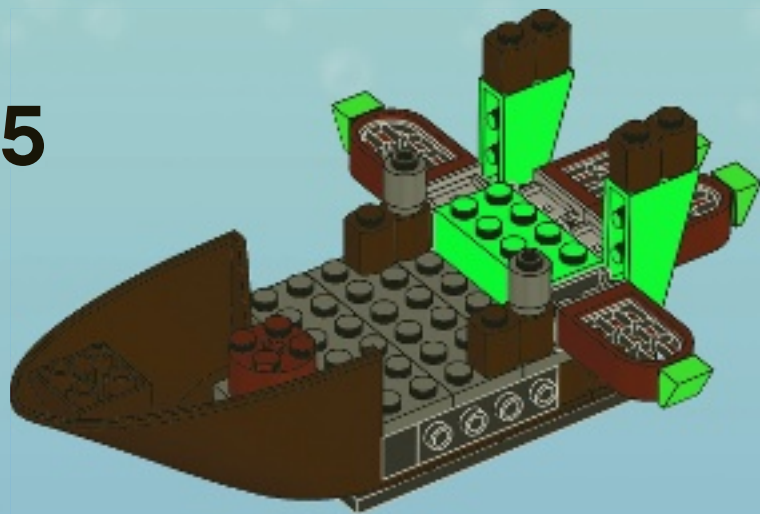

16

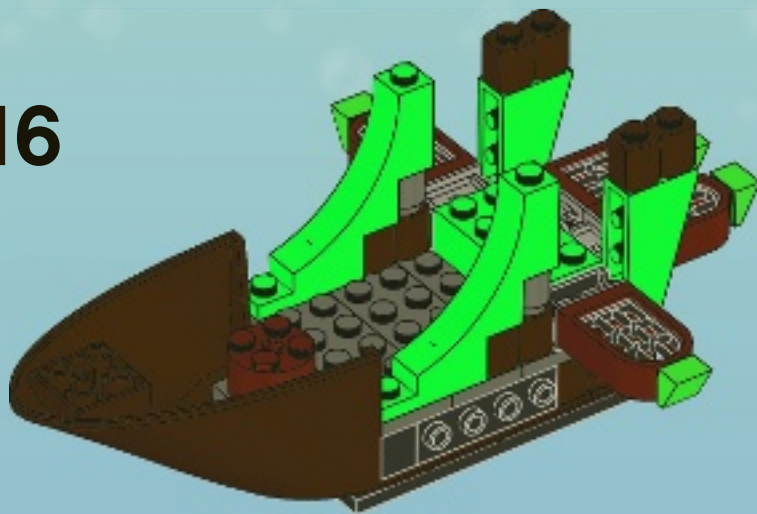

17

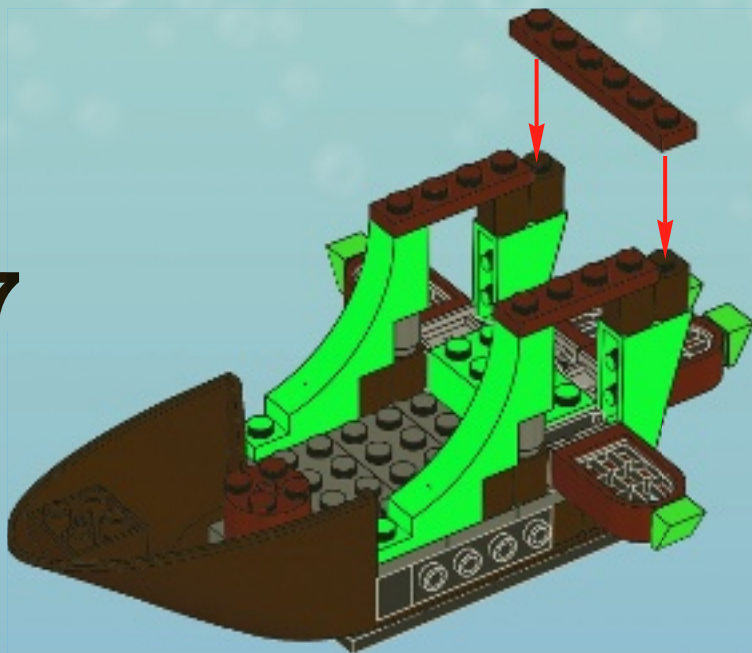

18

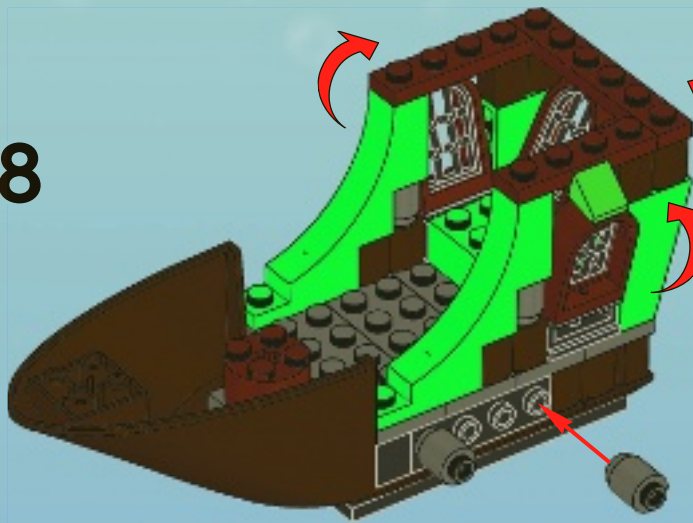

19

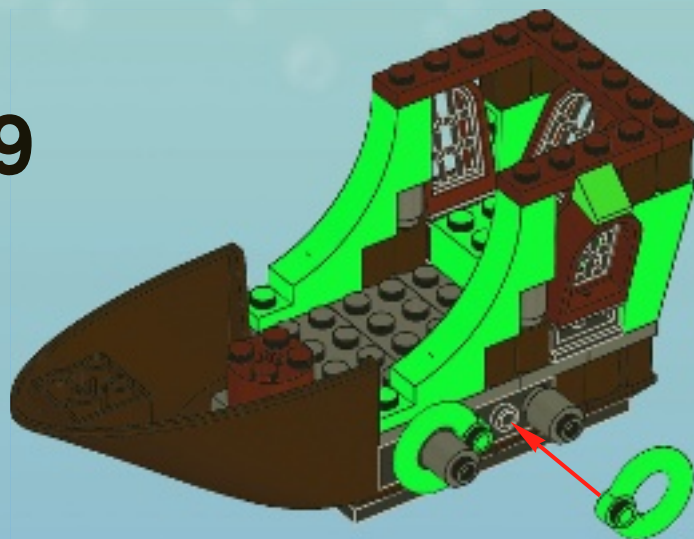



20

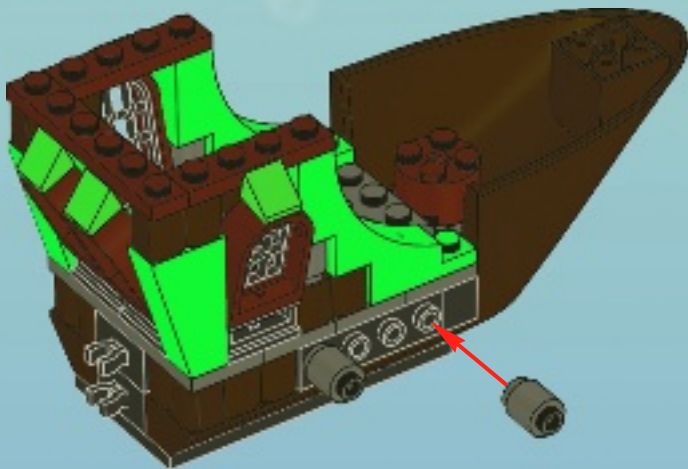

21

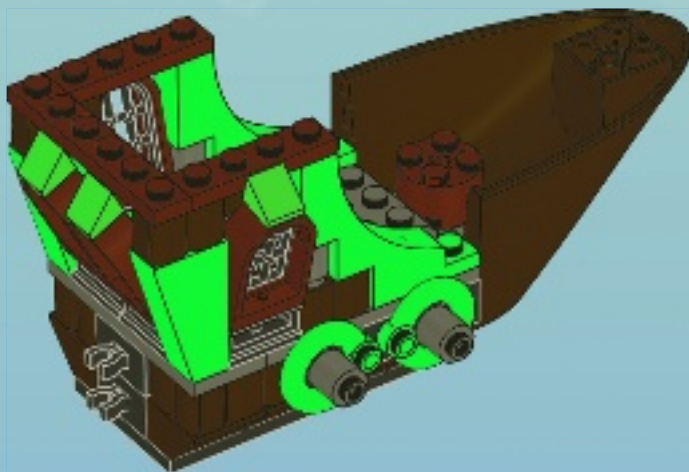



22

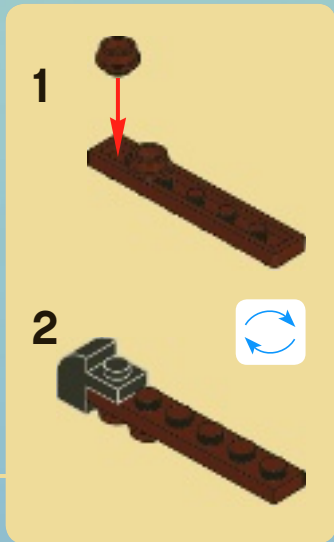
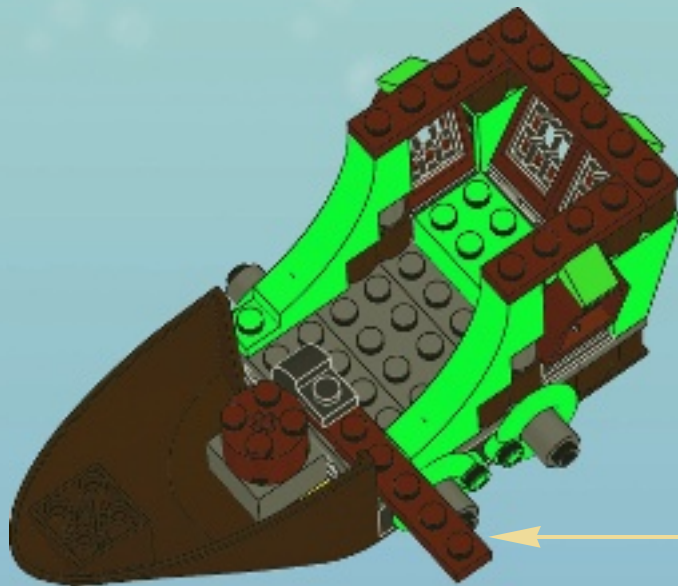

23

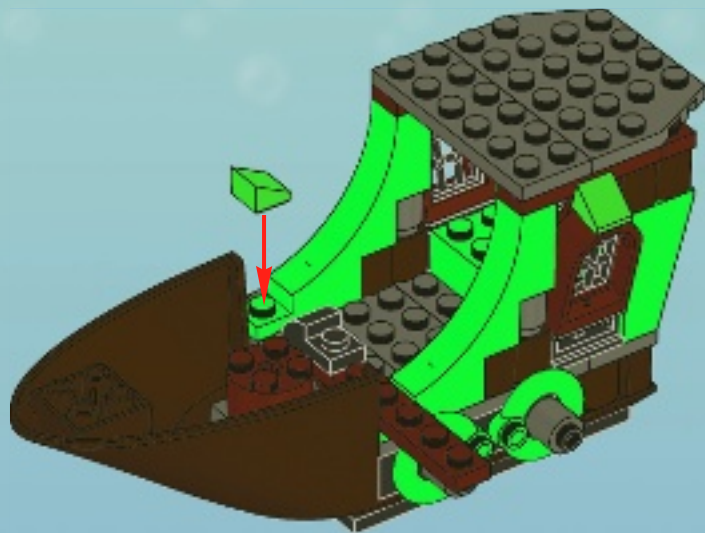



24

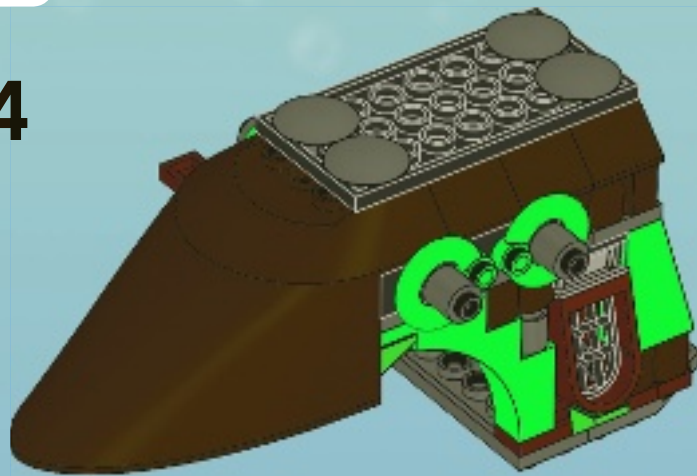



25

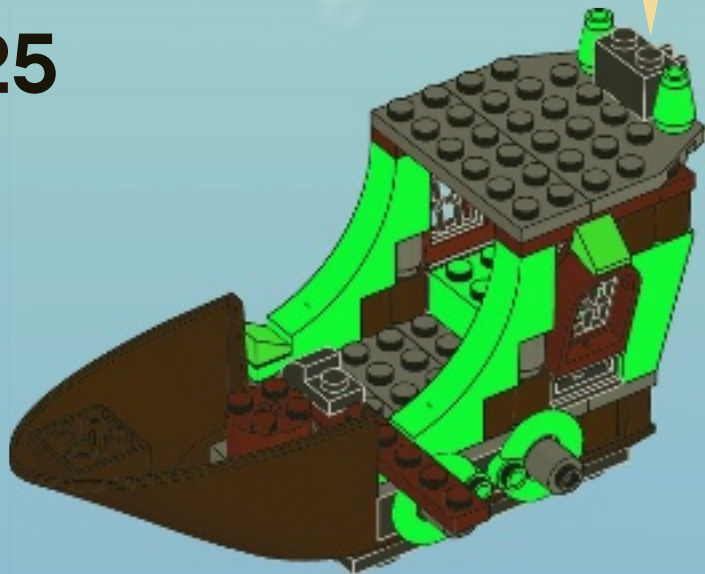

26

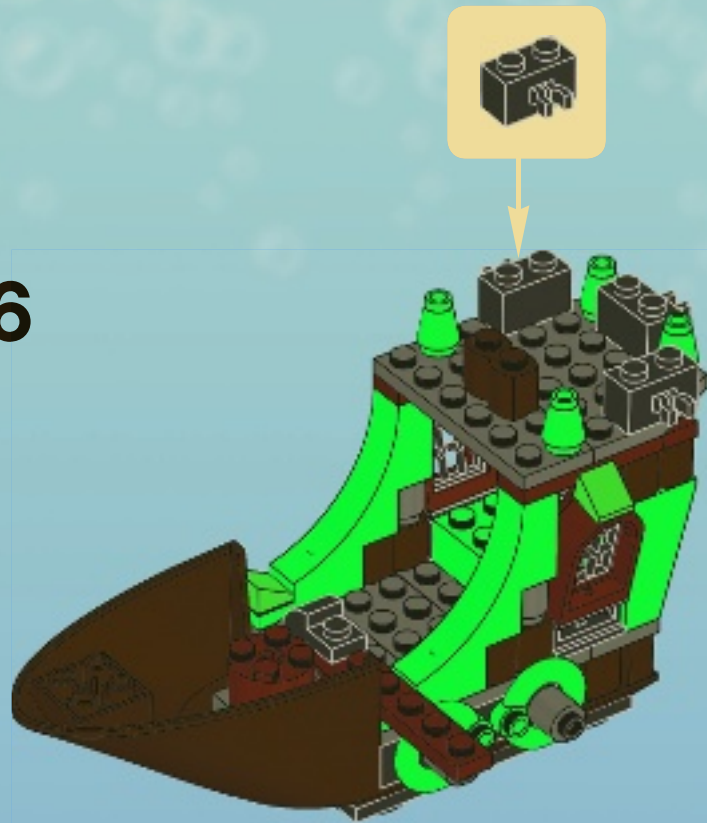

27

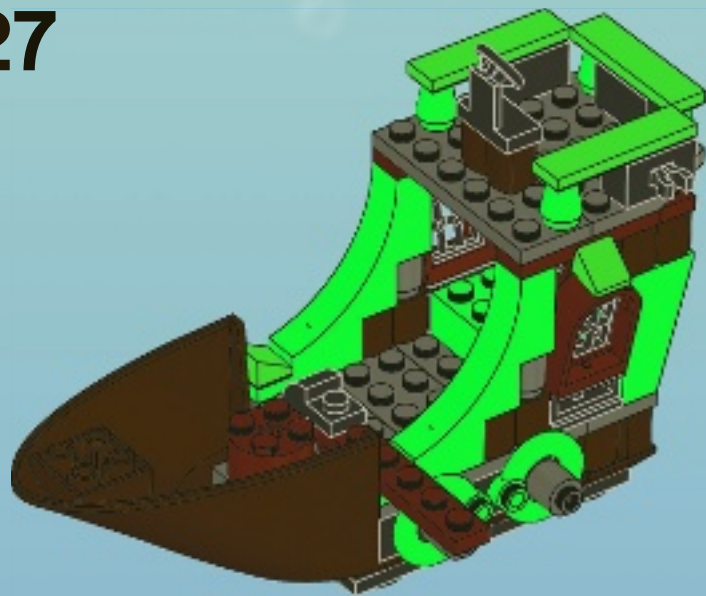

28

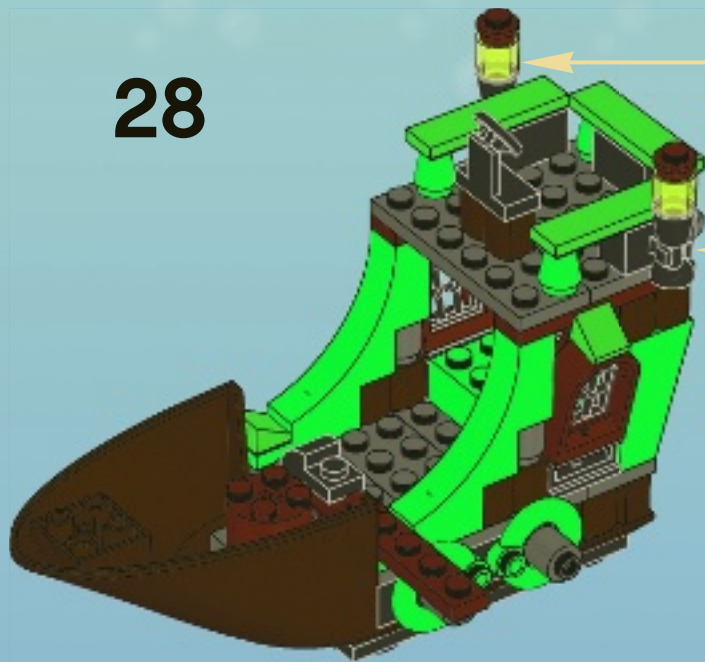

1



2



2x

1



2



3



29

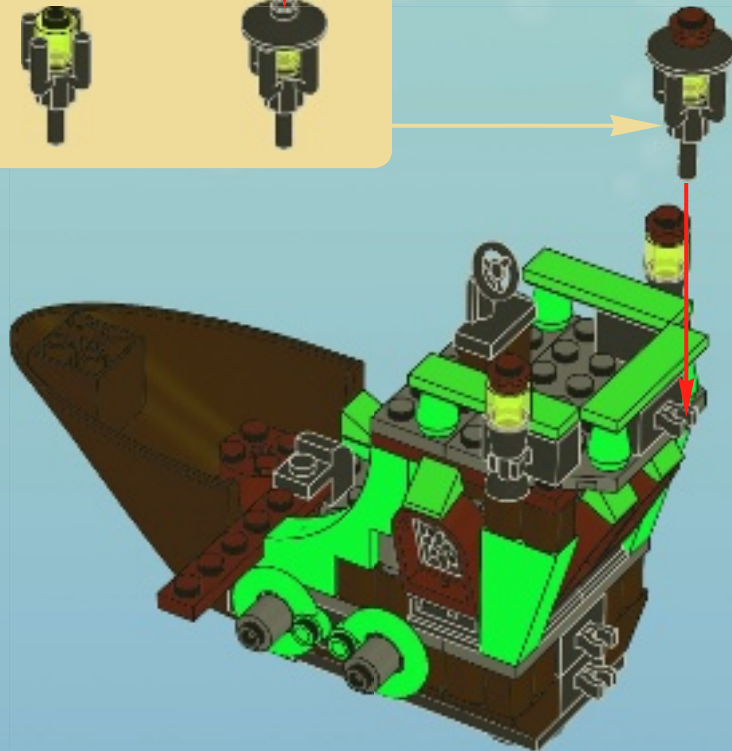

30

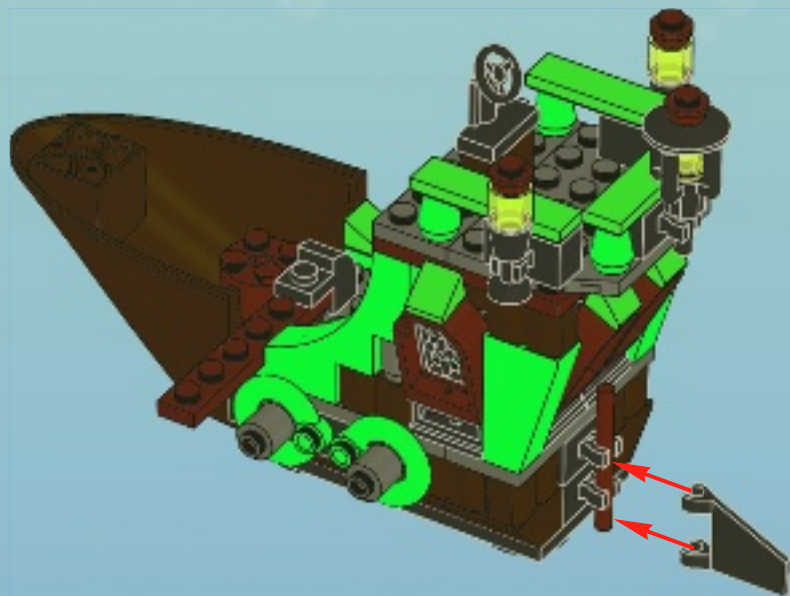



1



2



3

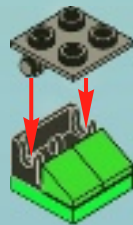

4



5



6

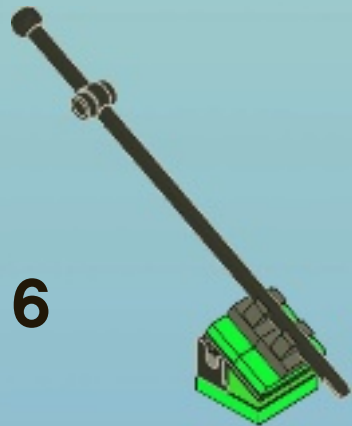

31

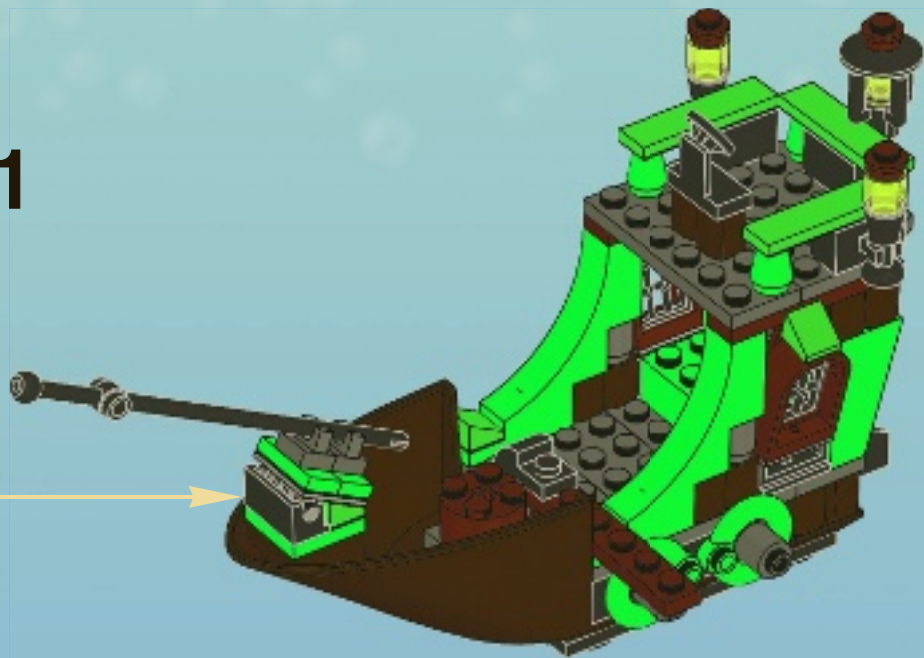



1



2



3



4



5



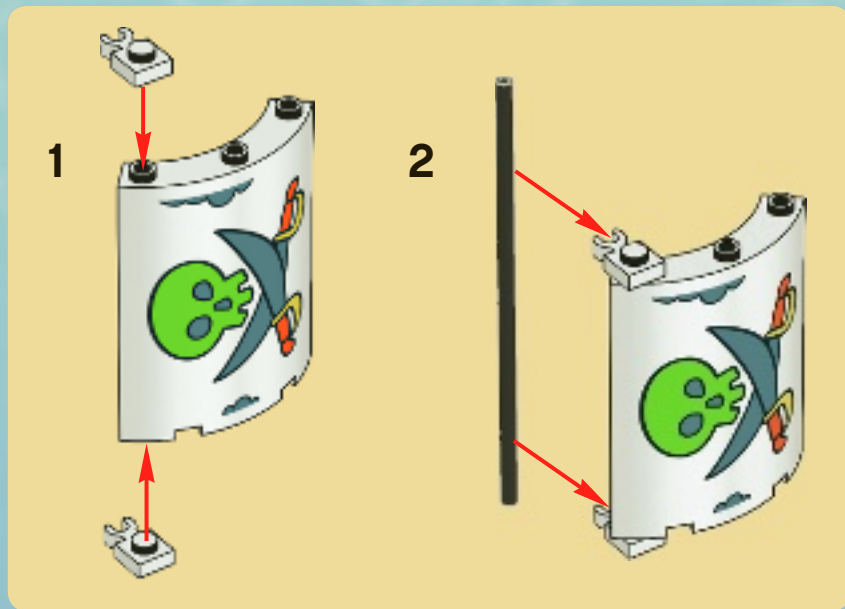

6

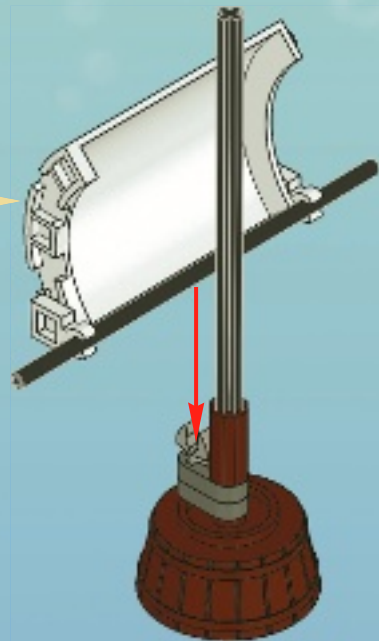

32

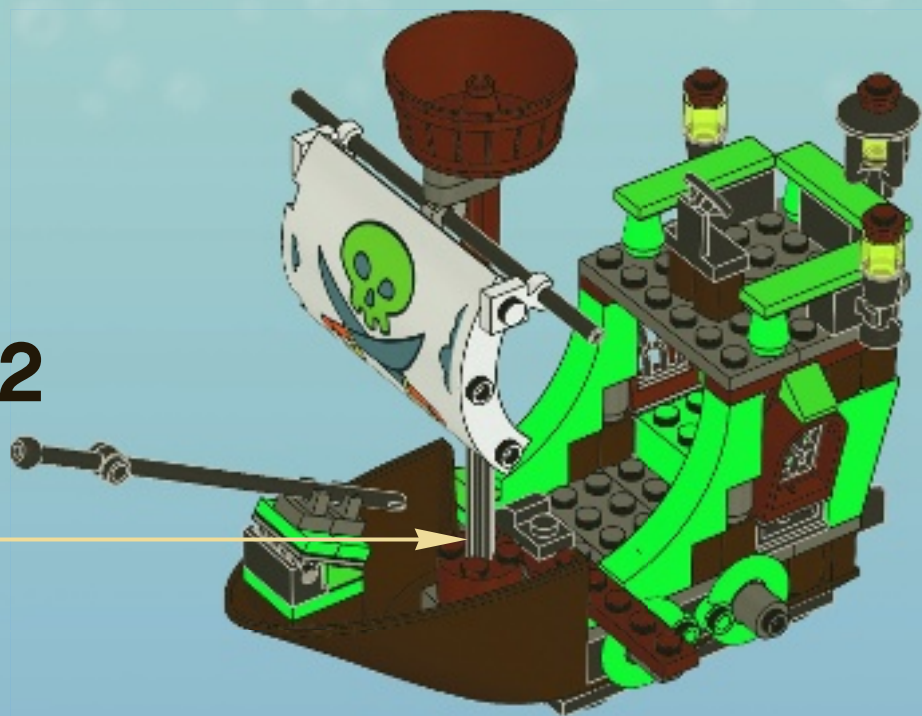

33

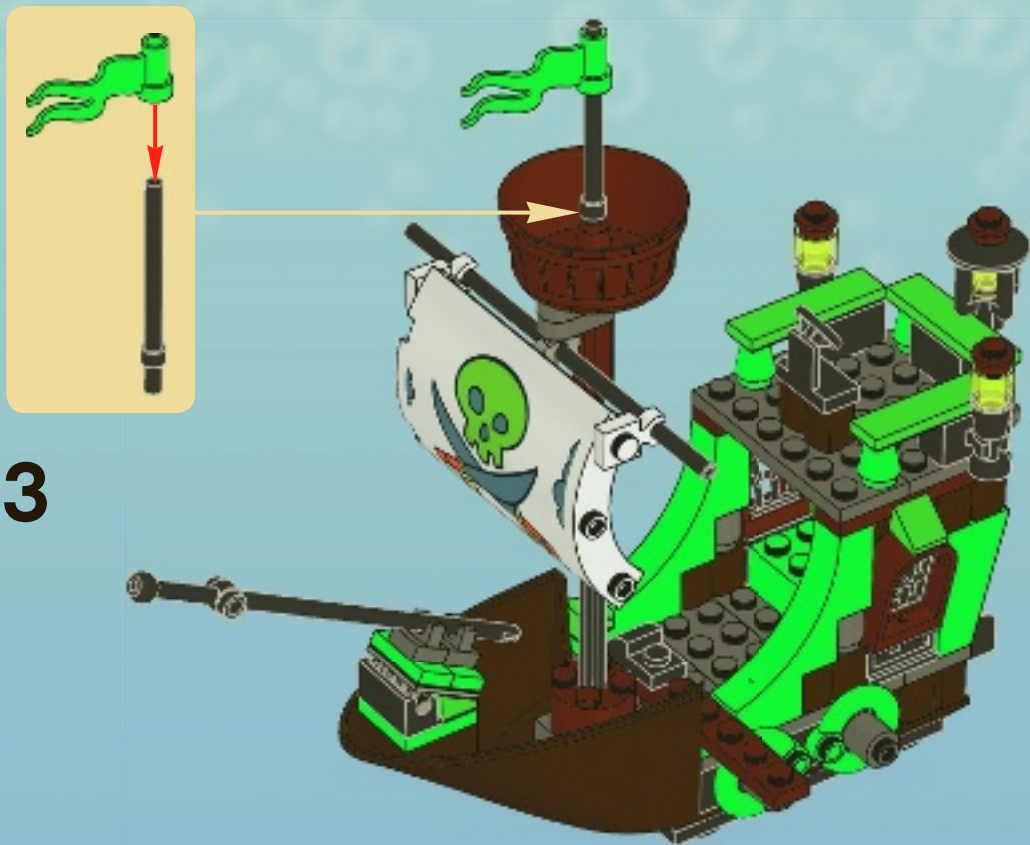

34





nickelodeon

SpongeBob SQUAREPANTS™





1x
4585203



1x
4140562



1x
4124460



1x
4509897



1x
4626948



1x
302121



1x
4543857



1x
302124



1x
4654968



1x
4653143



2x
4613256

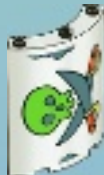

1x
4655043



3x
4523159



2x
4223189



1x
4658972



1x
609126



1x
4538722



1x
370826



1x
4296268

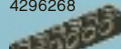

1x
389426



1x
303526



2x
281726



1x
474026



1x
4189009



1x
73081



1x
4648298



1x
4532220



5x
393726



5x
4118624



2x
4162443



11x
4211194



2x
4211190



2x
4221590



1x
4216945



1x
4211211



1x
4538718



4x
4542131



1x
4541875



1x
4211163



1x
4533101



13x
4216581



9x
4529242



1x
4211166



1x
4262974



1x
4531751



5x
4521921



10x
4211614



1x
4542590



1x
4211414



1x
4244627



4x
4211470



1x
4211385



3x
4211095



2x
4210789



9x
4519970



1x
4106356



4x
4655148



2x
379428



3x
4183544



2x
4211846



1x
4211046



2x
4210980



6x
4648296



2x
4629678



3x
4647548



7x
4647546



3x
4107106



4x
4211435



6x
4211090



1x
4211043



1x
4648300



1x
302228



1x
4654997



1x
4655012



2x
4578032



3x
4211395



10x
4211063



5x
4211002



1x
4638950



2x
4653205



1x
4651926



1x
4653155



1x
4653199



1x
4211881



1x
4263176

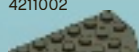

1x
4521572



1x
4638950



2x
4653205



4x
4258459



1x
4653155



1x
4653199



4x
4211483



4x
4278274



1x
4653124



4x
4105221



1x
449528

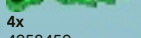

4x
4258459



1x
4653155



1x
4653199



1x
4211815



2x
4211069



1x
4654993



1x
4184617



4x
4529239



Customer Service

Kundenservice

Service Consommateurs

Servicio Al Consumidor

www.lego.com/service or dial



: 00800 5346 5555

: 1-800-422-5346



nickelodeon

SpongeBob SQUAREPANTS



3818



LEGO.com/spongebob



3816



3815





WIN!

Go to www.LEGOsurvey.com/product to fill out a survey for a chance to win a cool LEGO® Product.

No purchase necessary.

Open to all residents where not prohibited.



www.LEGOsurvey.com/product

GEWINNE!

Nimm an der Umfrage auf www.LEGOsurvey.com/product teil und hab die Chance ein cooles LEGO® Produkt zu gewinnen! Die Teilnahme am Gewinnspiel führt zu keinerlei Kaufverpflichtungen. Teilnahme in allen nicht ausgeschlossenen Ländern möglich.

WIN!

Ga naar www.LEGOsurvey.com/product, vul een enquêteformulier in en maak kans op een cool LEGO® product. Geen aankoopverplichting. Iedereen mag deelnemen, uitgezonderd ingezetenden van landen waar een enquêteverbod geldt.

GAGNE!

Visite www.LEGOsurvey.com/product pour répondre à un questionnaire et avoir une chance de gagner un produit LEGO® très cool! Aucune obligation d'achat. Ouvert à tous les résidents des pays autorisés.

当てよう!

www.LEGOsurvey.com/product にアクセスして、アンケートにご記入ください。当選者にはレゴ製品を差し上げます。お買い上げの必要はありません。禁止されていない限り、すべての皆様にご利用いただけます。



www.LEGO.com

6003838

LEGO and the LEGO logo are trademarks of the LEGO Group. ©2012 The LEGO Group. © 2012 Viacom International Inc. All Rights Reserved. Nickelodeon, SpongeBob SquarePants and all related titles, logos and characters are trademarks of Viacom International Inc. SpongeBob SquarePants created by Stephen Hillenburg. www.nick.com www.nickelodeon.tv