



nickelodeon

SpongeBob SQUAREPANTS

3815



WARNING: CHOKING HAZARD.
Toy contains small parts and a small ball.
Not for children under 3 years.

1

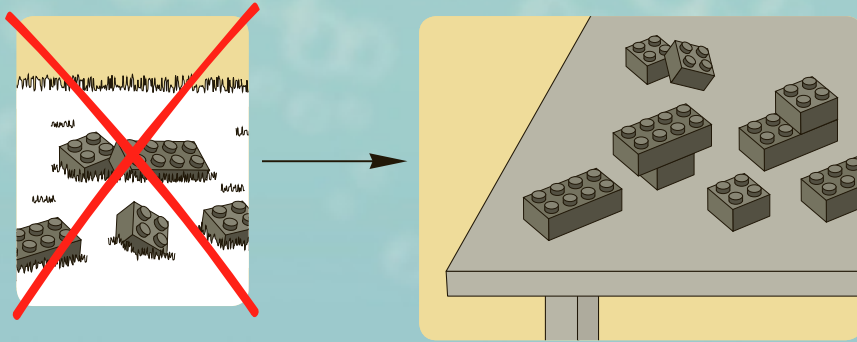

2

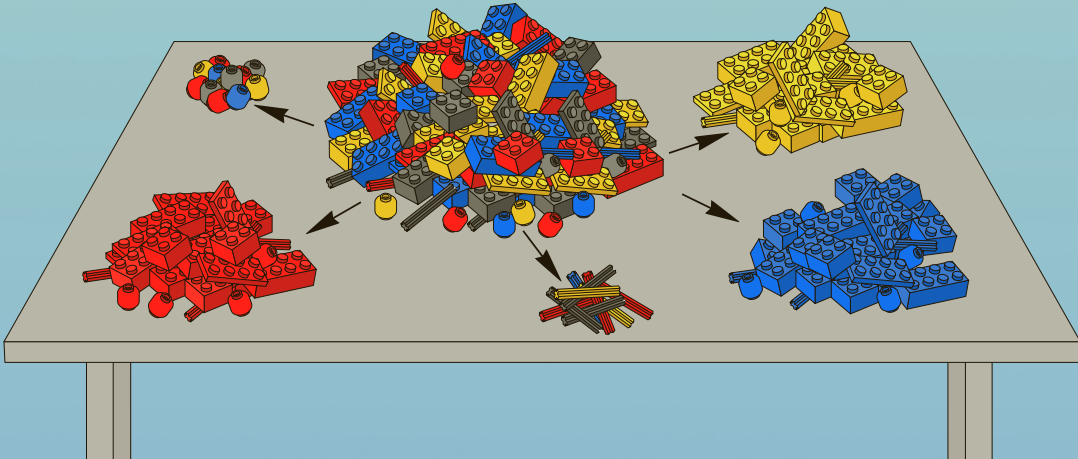

2

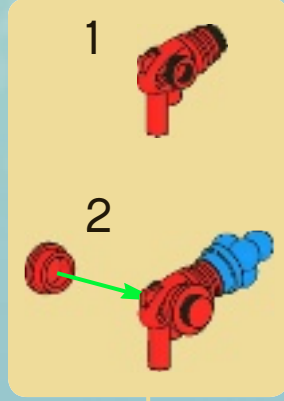
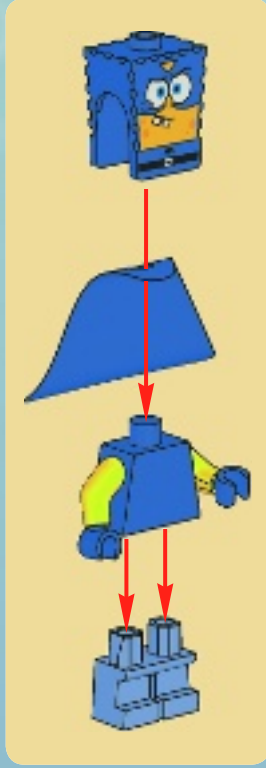

AVERTISSEMENT : RISQUE D'ÉTOUFFEMENT.
Le jouet contient des petites pièces ainsi qu'une petite boule.
Il ne convient pas aux enfants de moins de 3 ans.



ADVERTENCIA: PELIGRO DE ASFIXIA.
Juguete que contiene partes pequeñas y una pelota pequeña.
No recomendado para niños menores de 3 años.

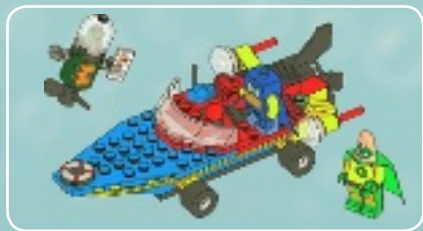

1



2



3



4



5



6

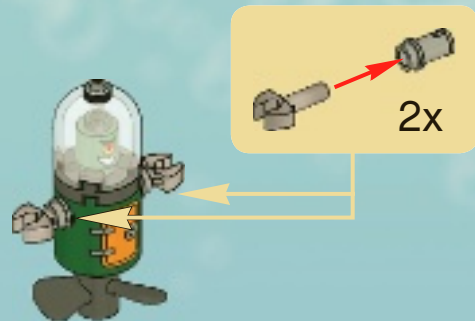

7



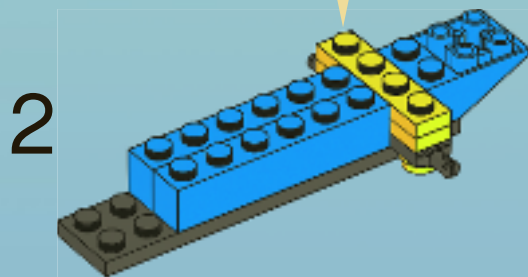
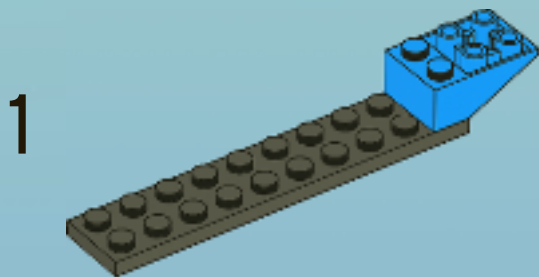
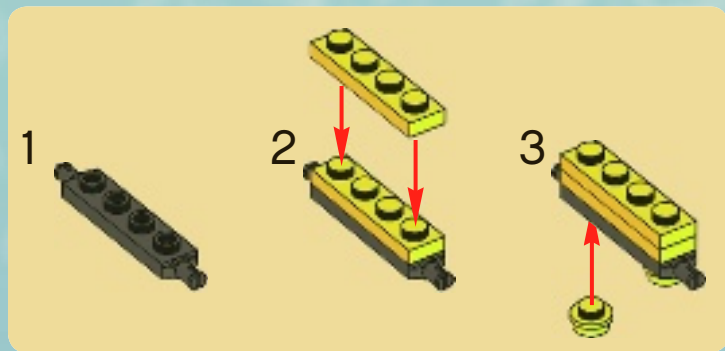
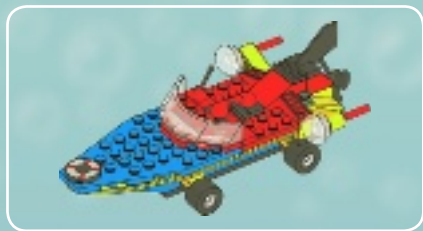

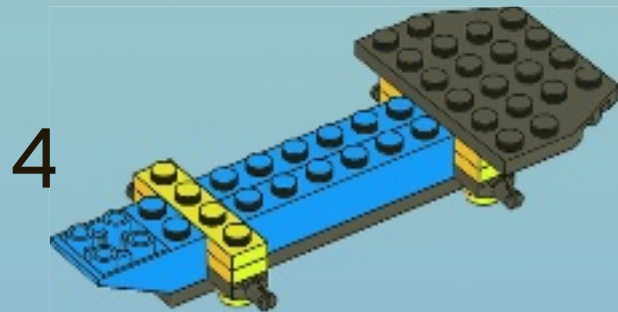
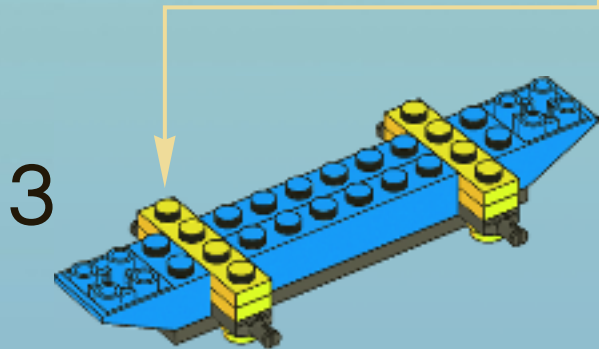
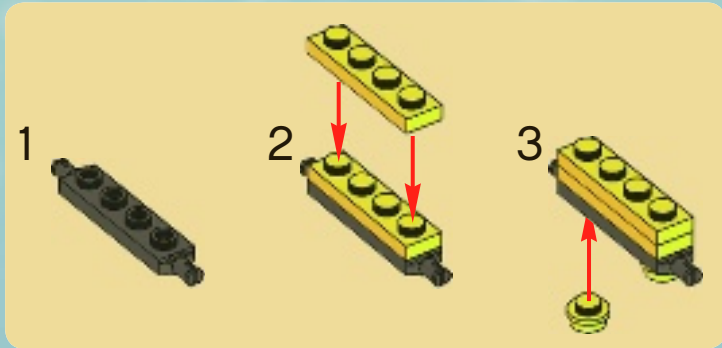

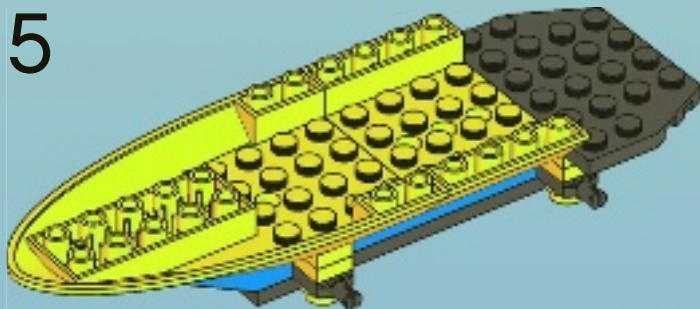

6

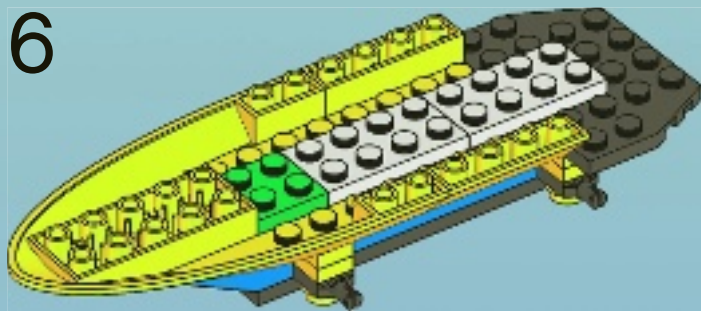

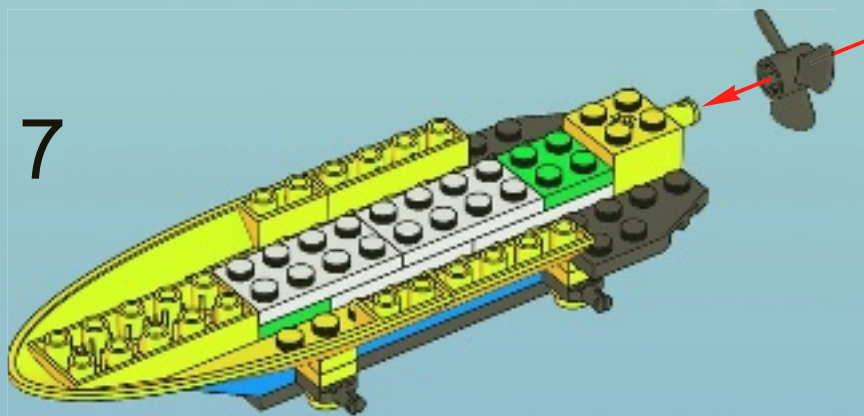

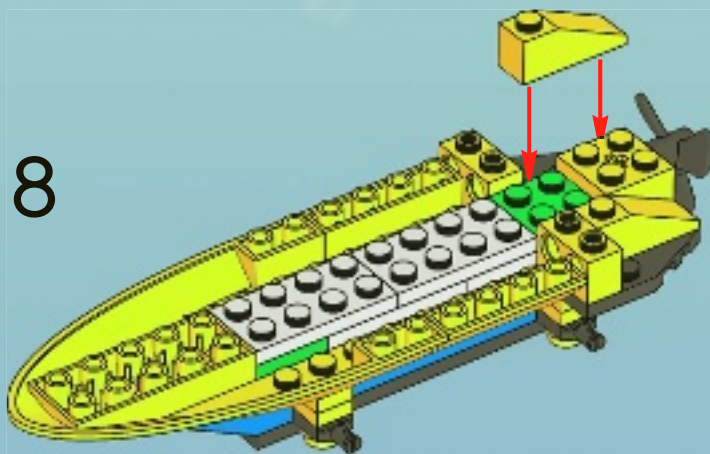

9

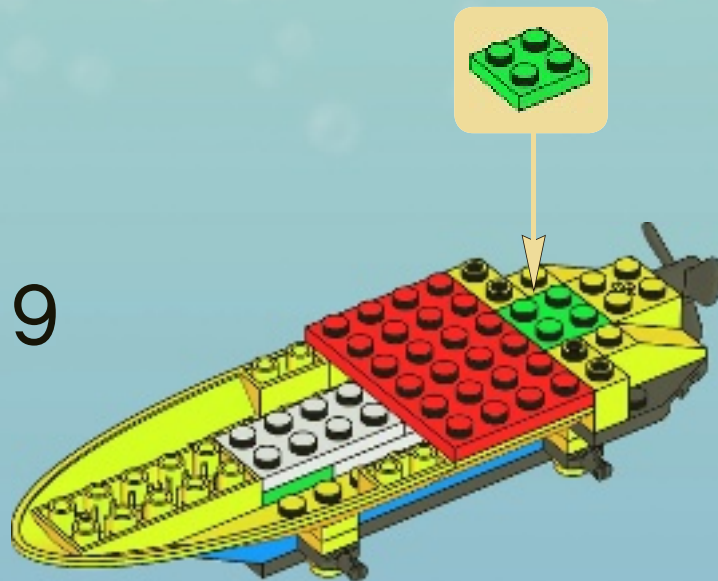

10

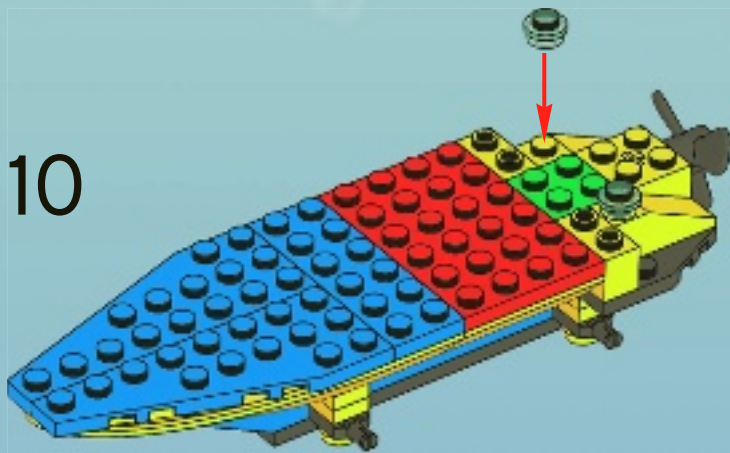

11

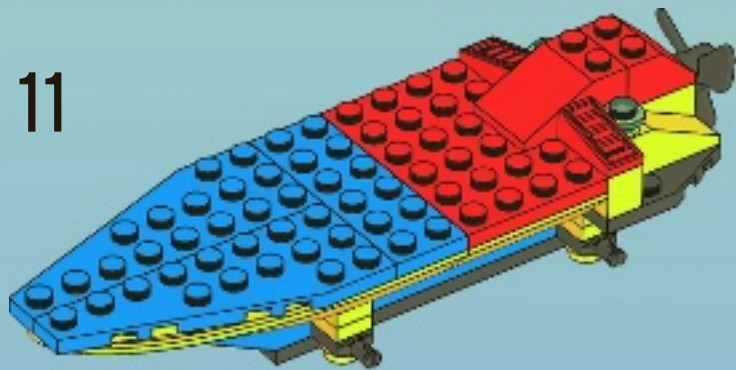

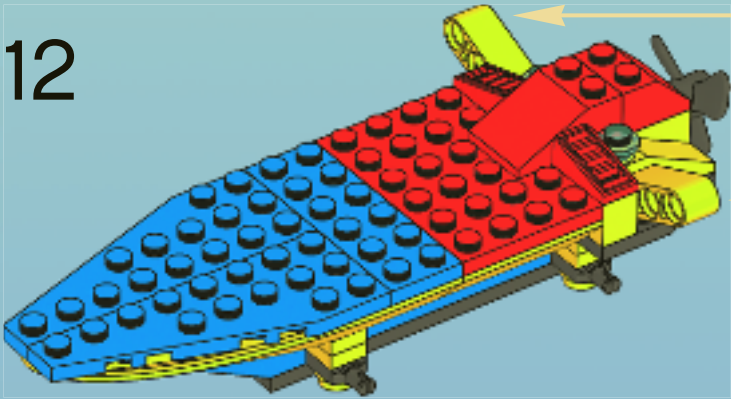
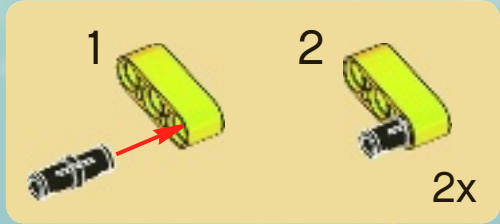

13

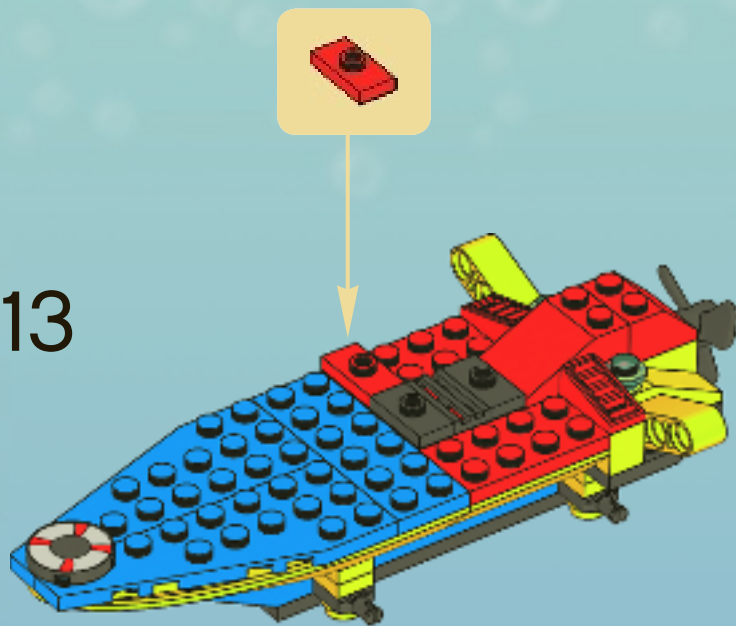

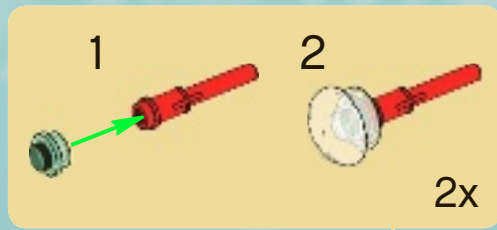

14

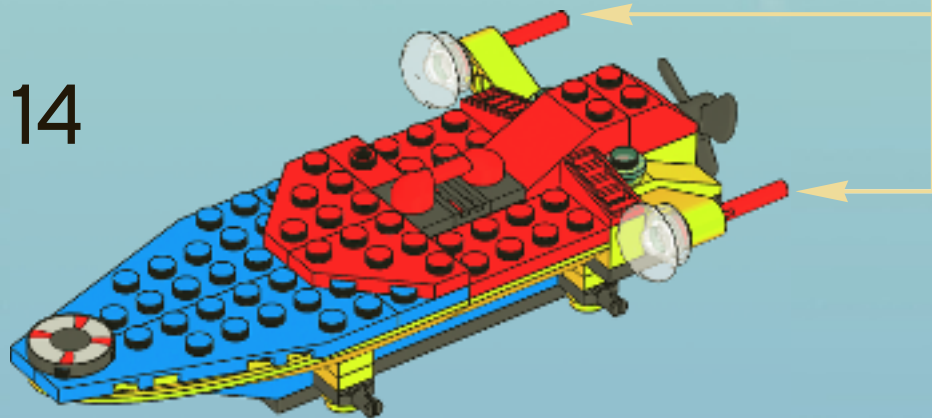

15

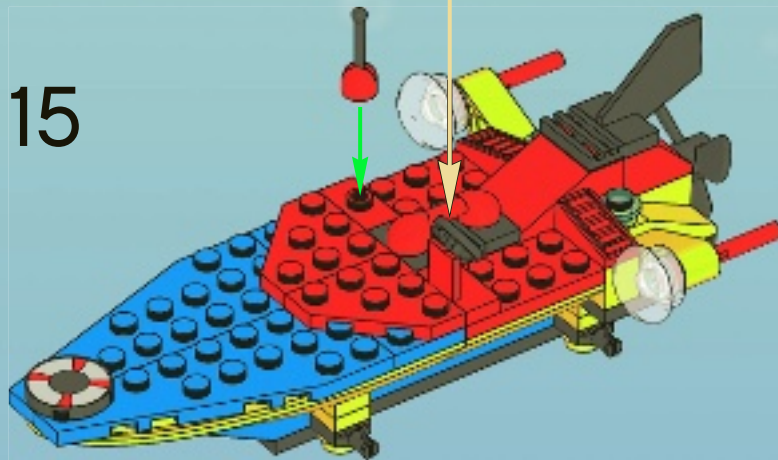

16

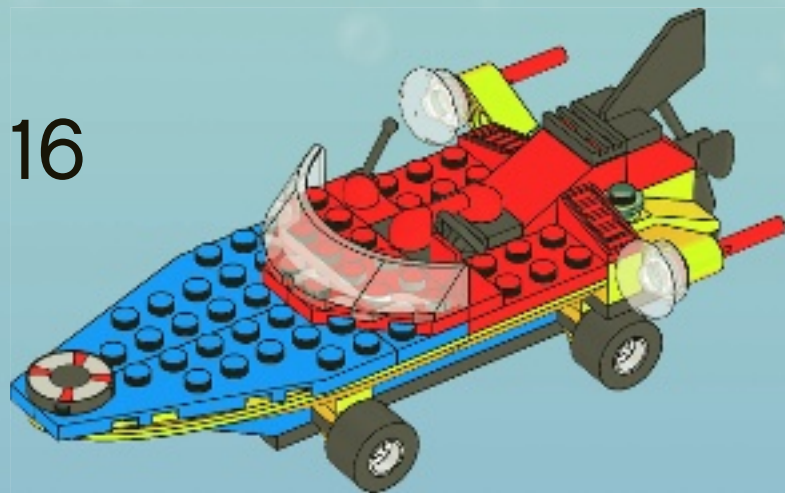

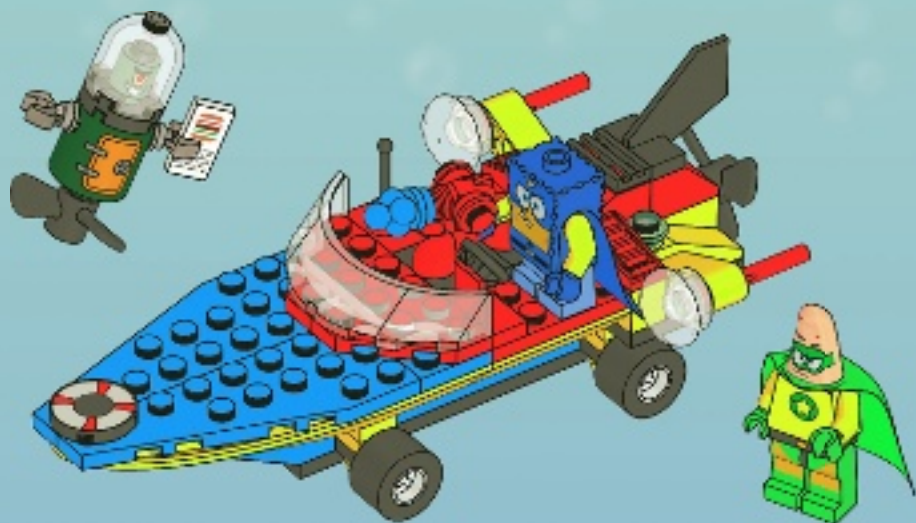

1x
4638336



4x
302001



4x
4170500



1x
4186017



2x
4540382



1x
303921



1x
329821



2x
245021



1x
303221



1x
379421



2x
614121



2x
4526119



1x
74335



1x
4558598



1x
4640906



1x
9552



4x
614124



2x
4153707



4x
371024



1x
4642460



1x
4638258



1x
4636663



1x
4636675



1x
623224



2x
4201615



2x
428624



1x
4638251



1x
4549996

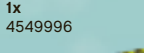

1x
4638784



1x
383226



1x
4129572



2x
292626



2x
379426



2x
241226



1x
403226



1x
4293532



4x
4508215



2x
604126



1x
4529173



2x
4121715



1x
4638367



1x
4636677



1x
4113949



2x
4640921



1x
4523573



4x
4163917



1x
4638334



1x
4636909



3x
302228



1x
4640889

1x
4640866



2x
4547937



2x
4211483



1x
4636566



1x
4640886



2x
4640884



2x
4641356



1x
4640891



Customer Service

Kundenservice

Service Consommateurs

Servicio Al Consumidor

www.lego.com/service or dial



: 00800 5346 5555

: 1-800-422-5346



nickelodeon.

SpongeBob
SQUAREPANTS

lego.com/spongebob



3816

3833





www.LEGOclub.com



LEGO® Club Email



LEGO® Club Magazine

LEGO club™

FREE! GRATIS! GRATUIT!

SIGN UP ONLINE!

www.LEGOclub.com



00800 5346 5555*



1-866-534-6258 • 1-877-518-5346

US & Canada only

One-time enrollment

- * Freephone. Mobile charges may apply.
- * Numéro sans frais. Des frais peuvent s'appliquer avec les téléphones cellulaires.
- * Gebührenfrei. Kosten für Anrufe aus Mobilfunknetzen können abweichen.
- * Gratis telefoonnummer vanaf vaste lijn.
- * Det er et gratis nummer, når du ringer fra fasttelefon.
- * Det är gratis, när du ringer från en fast telefon.
- * Numéro sans frais. Des frais peuvent s'appliquer avec les téléphones portables.



WIN!

Go to www.LEGOsurvey.com/product to fill out a survey for a chance to win a cool LEGO® Product.
No purchase necessary. Open to all residents where not prohibited.



www.LEGO.com



www.LEGOsurvey.com/product

GEWINNE!

Nimm an der Umfrage auf www.LEGOsurvey.com/product teil und hab die Chance ein cooles LEGO® Produkt zu gewinnen!

Die Teilnahme am Gewinnspiel führt zu keinerlei Kaufverpflichtungen. Teilnahme in allen nicht ausgeschlossenen Ländern möglich.

WIN!

Ga naar www.LEGOsurvey.com/product, vul een enquêteformulier in en maak kans op een cool LEGO® product.

Geen aankoopverplichting. Iedereen mag deelnemen, uitgezonderd ingezetenden van landen waar een enquêteverbod geldt.

GAGNE!

Visite www.LEGOsurvey.com/product pour répondre à un questionnaire et avoir une chance de gagner un produit LEGO® très cool!

Aucune obligation d'achat. Ouvert à tous les résidents des pays autorisés.

当てよう!

www.LEGOsurvey.com/product にアクセスして、アンケートにご記入ください。当選者にはレゴ®製品を差し上げます。

お買い上げの必要はありません。禁止されていない限り、すべての皆様にご利用いただけます。

LEGO and the LEGO logo are trademarks of the/son des marques de commerce de/son marcas registradas de LEGO Group. © 2011 The LEGO Group.

© 2011 Viacom International Inc. All Rights Reserved. Nickelodeon, SpongeBob SquarePants and all related titles, logos and characters are trademarks of Viacom International Inc. SpongeBob SquarePants created by Stephen Hillenburg. © 2011 Viacom International Inc. Toute reproduction interdite. Nickelodeon, Bob l'éponge ainsi que les logos, les personnages et les autres titres qui s'y rapportent sont des marques de commerce de Viacom International Inc. Bob l'éponge créé par Stephen Hillenburg.

© 2011 Viacom International Inc. Todos los derechos reservados. Nickelodeon, Bob Esponja y todos los títulos, logotipos y personajes del mismo género son marcas de Viacom International Inc. Bob Esponja creado por Stephen Hillenburg.