

1

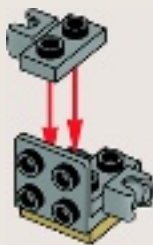

2



3

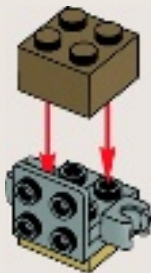

4

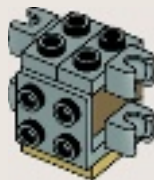

5

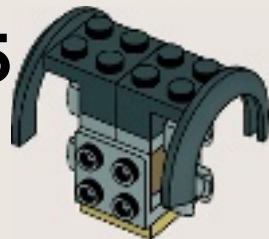

6

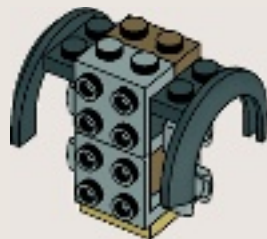

7

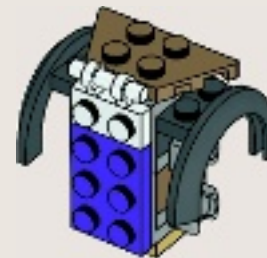

8

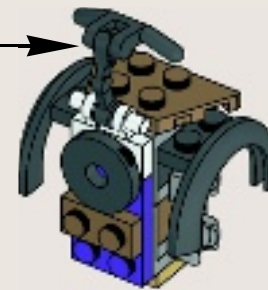
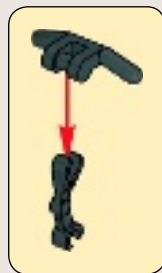

9

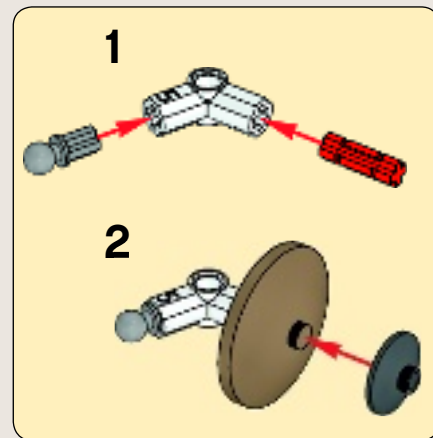
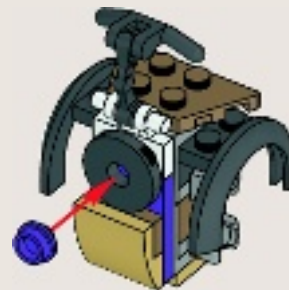

10

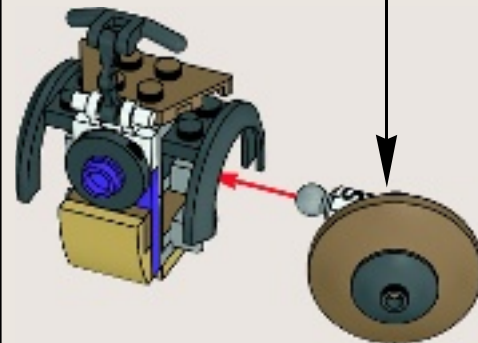

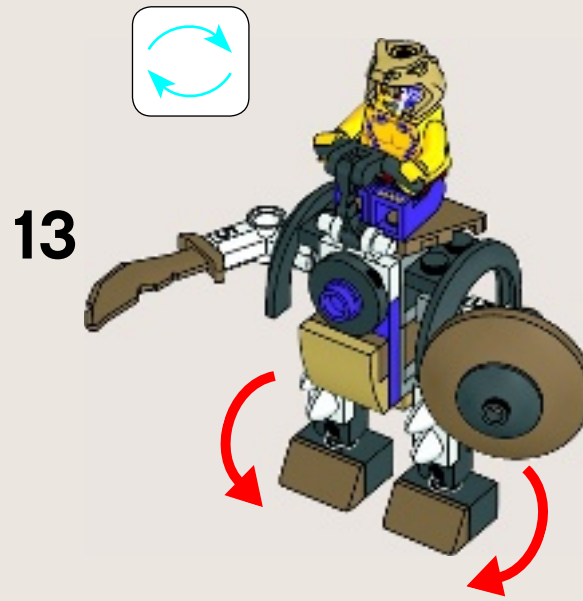
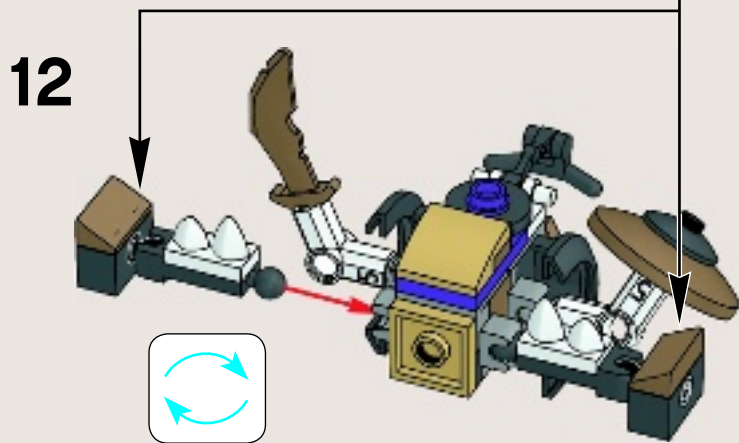
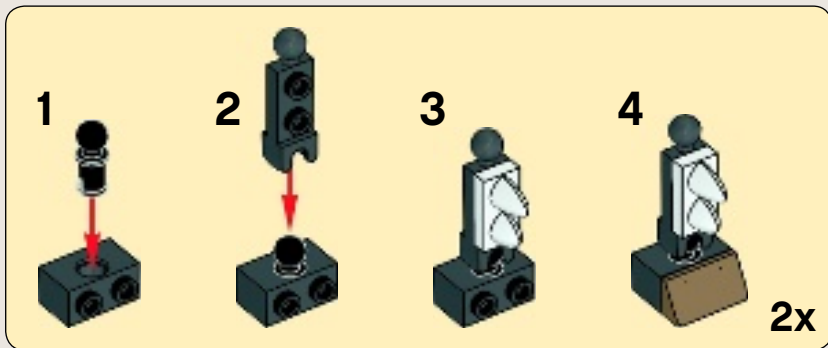
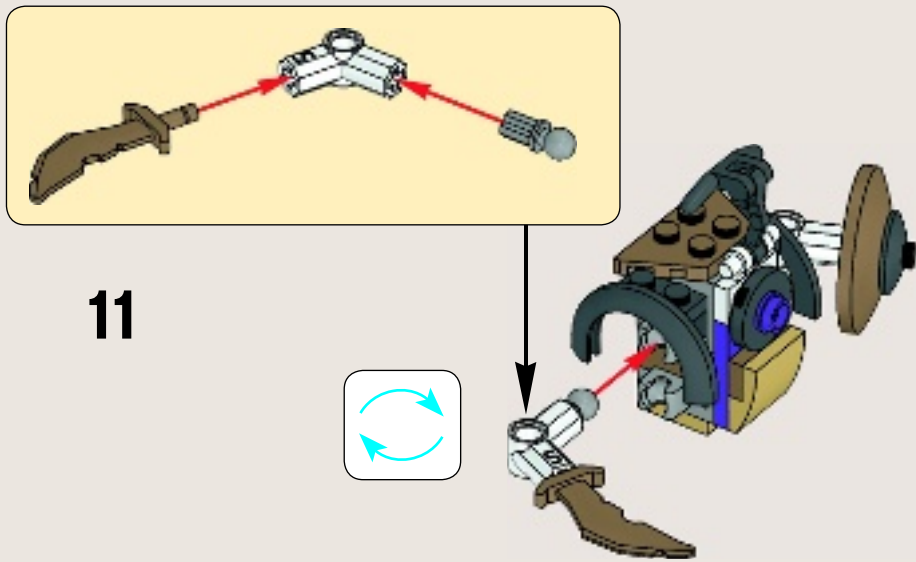

LEGO.com/service  LEGO.com/ninjago

LEGO and the LEGO logo are trademarks of the LEGO Group. ©2015 The LEGO Group. 6114481

