

**LEGO**

**Ferrari**  
OFFICIAL LICENSED PRODUCT

30196

6022729 / 6042511

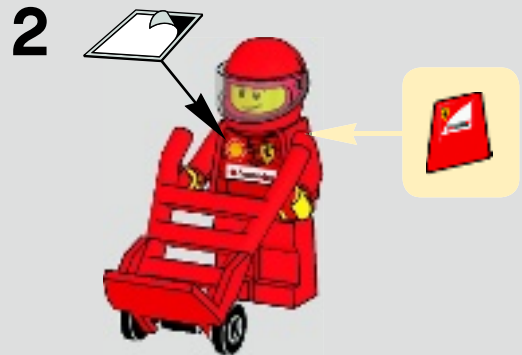
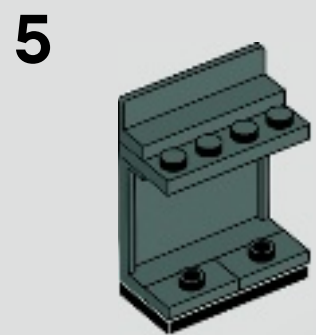
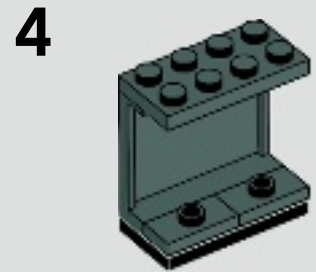
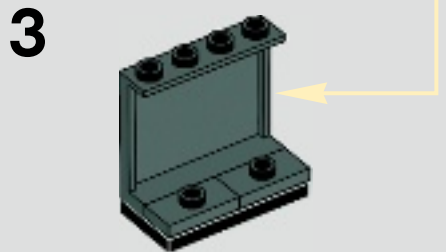
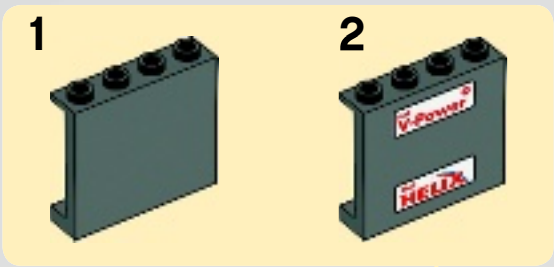

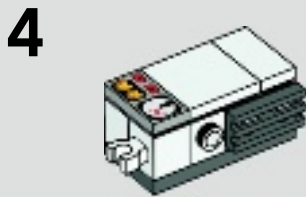
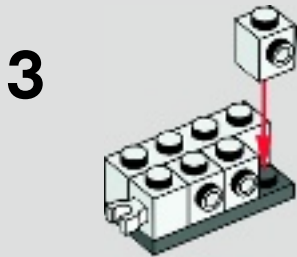
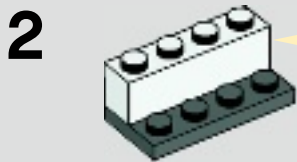
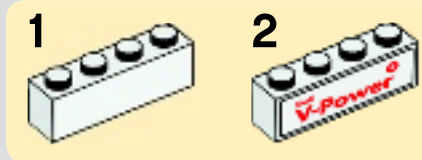

5



6



7

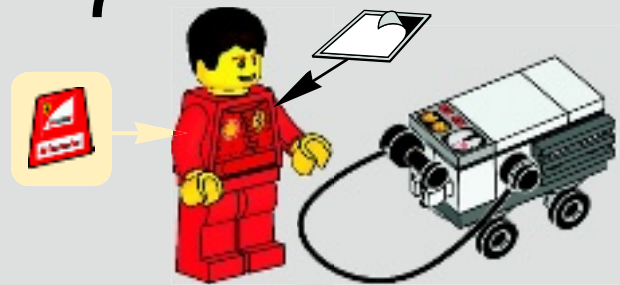

www.LEGO.com/Service

LEGO and the LEGO logo are trademarks of the LEGO Group. ©2012 The LEGO Group.

Produced under license of Ferrari Spa. FERRARI, the PRANCING HORSE device, all associated logos and distinctive designs are property of Ferrari Spa. The body designs of the Ferrari cars are protected as Ferrari property under design, trademark and trade dress regulations.



6022729 / 6042511



30190  
Ferrari 150°  
Italia



30191  
Scuderia  
Ferrari Truck



30192  
F40



30193  
250 GT  
Berlinetta



30194  
458 Italia



30195  
FXX

www.shell.com/LEGO