

LEGO

Ferrari
Official Licensed Product

30196

6022729 / 6042511

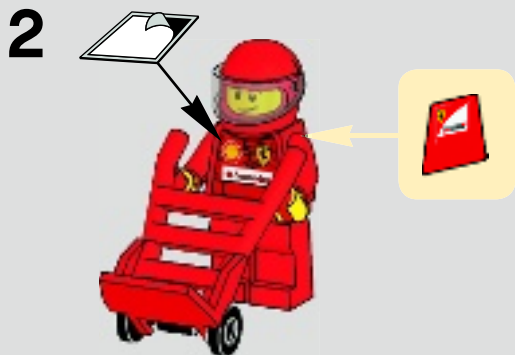
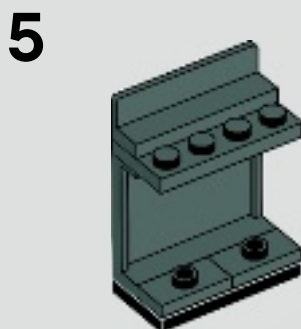
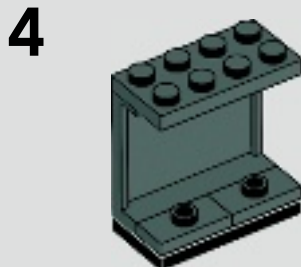
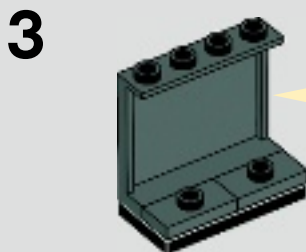
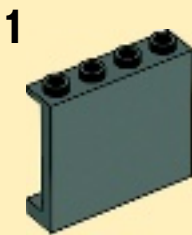

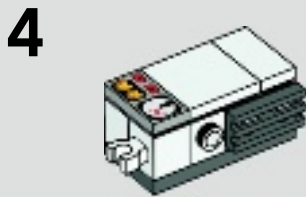
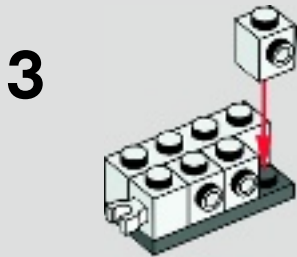
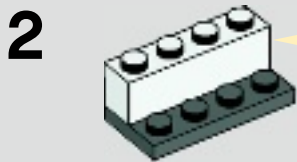
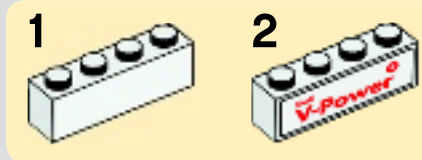

5



6



7

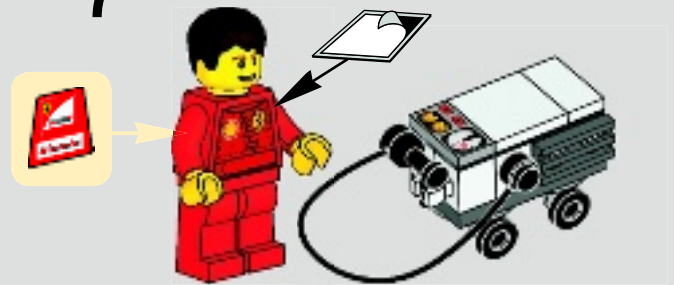

www.LEGO.com/Service

LEGO and the LEGO logo are trademarks of the LEGO Group. ©2012 The LEGO Group.

Produced under license of Ferrari Spa. FERRARI, the PRANCING HORSE device, all associated logos and distinctive designs are property of Ferrari Spa. The body designs of the Ferrari cars are protected as Ferrari property under design, trademark and trade dress regulations.



6022729 / 6042511



30190
Ferrari 150°
Italia



30191
Scuderia
Ferrari Truck



30192
F40



30193
250 GT
Berlinetta



30194
458 Italia



30195
FXX

www.shell.com/LEGO