

The LEGO logo is positioned in the top left corner, featuring the word "LEGO" in white on a red square background.

# HEROFACTORY

**WARNING: CHOKING HAZARD.**  
Toy contains small parts and a small ball.  
Not for children under 3 years.



# NITROBLAST

# 2194

HeroFactory.LEGO.com/Nitroblast

A LEGO Technic robot, model 2142, is shown in a dynamic pose. The robot is primarily green and black, with red accents on its chest and head. It has a complex mechanical structure with various gears, levers, and a large red ball in its right hand. The background is a hazy, industrial setting with a tall tower emitting a flame and a red ball in the sky. The number 2142 is displayed in white text above the robot.

2142



**AVERTISSEMENT : RISQUE D'ÉTOUFFEMENT.**

Le jouet contient des petites pièces ainsi qu'une petite boule. Il ne convient pas aux enfants de moins de 3 ans.



**ADVERTENCIA: PELIGRO DE ASFIXIA.**

Juguete que contiene partes pequeñas y una pelota pequeña. No recomendado para niños menores de 3 años.





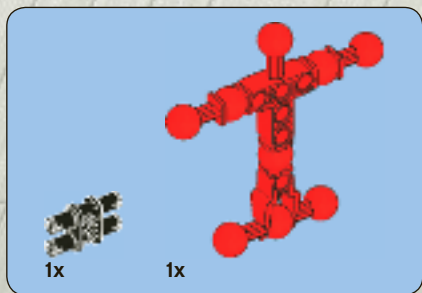

1

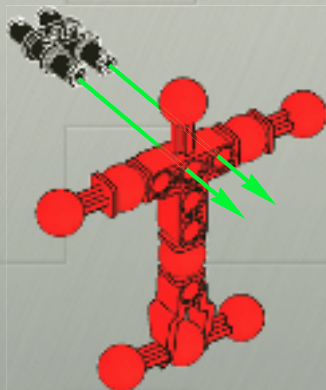



1

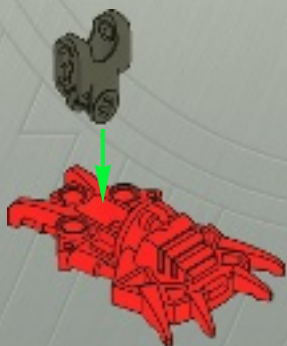

2



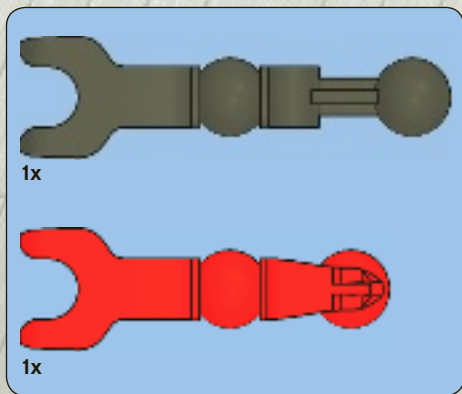

**3**

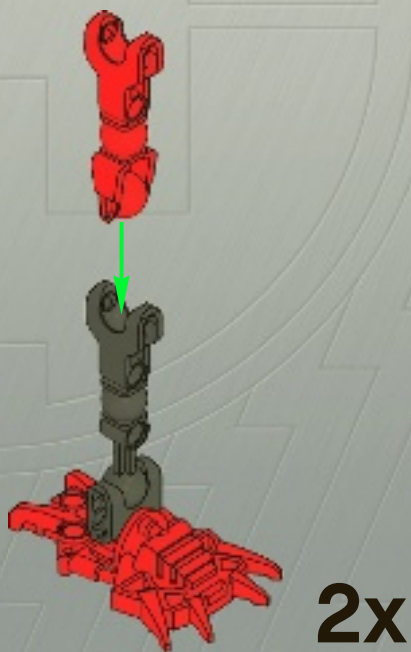



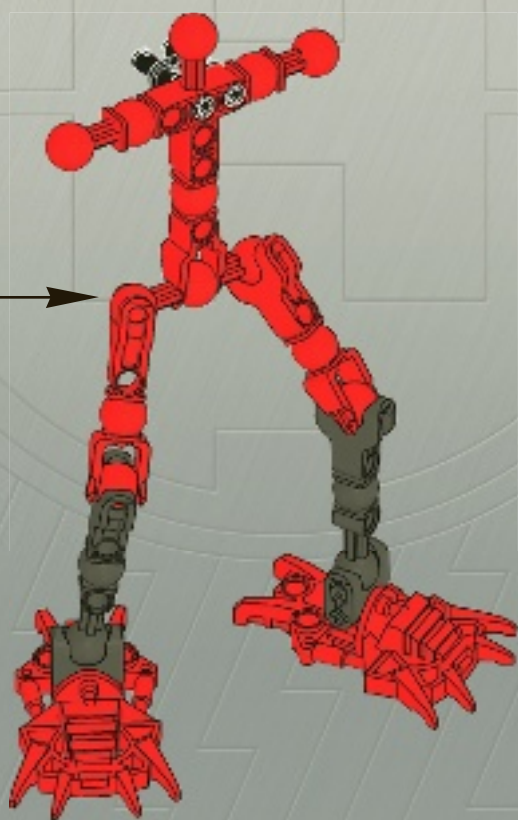



2x

2

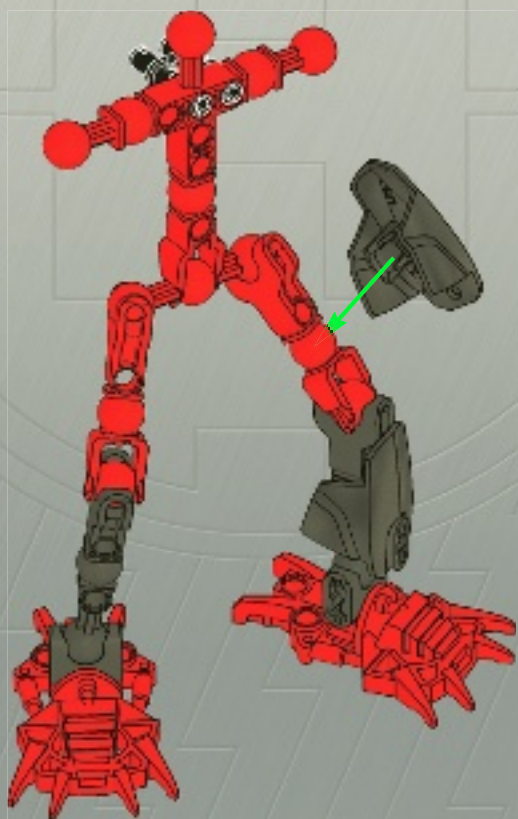





3

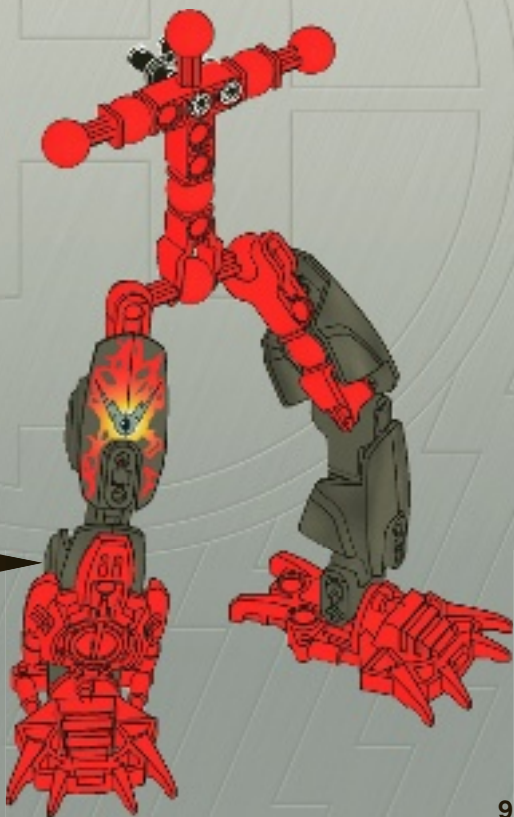
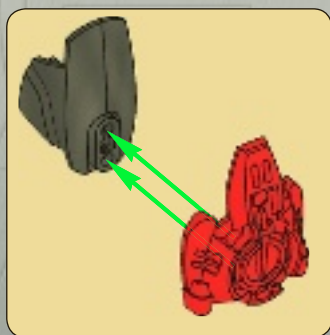



6x

4

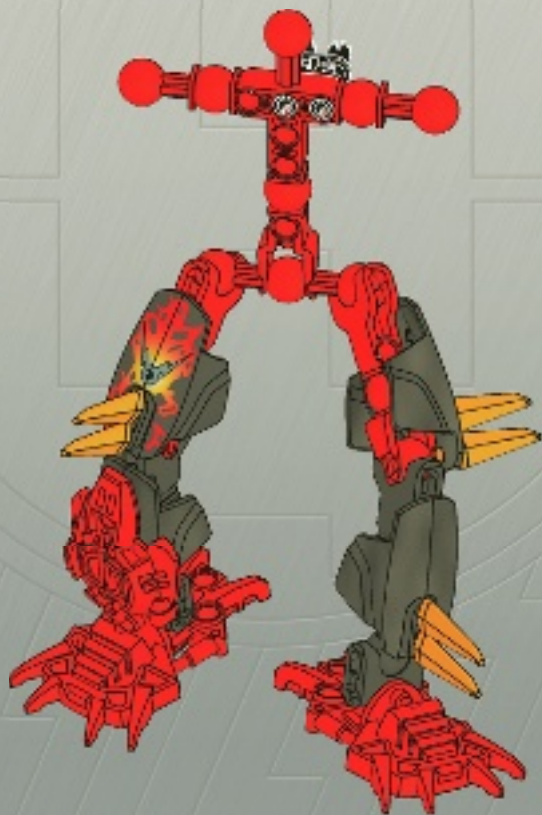

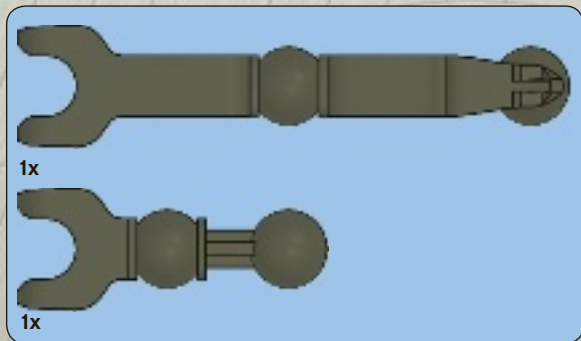
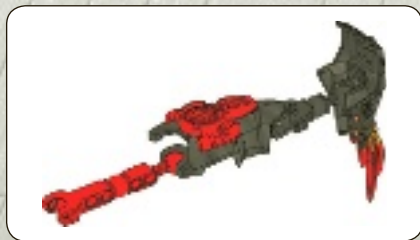

**1**

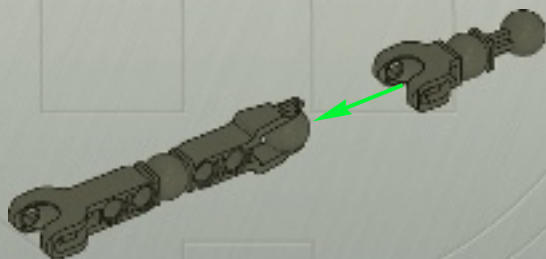

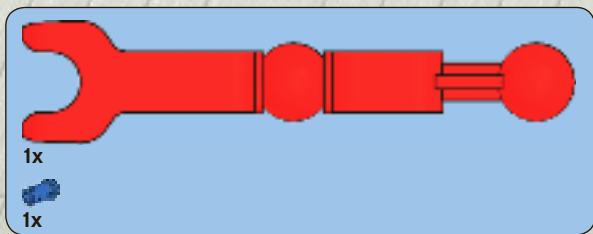

2

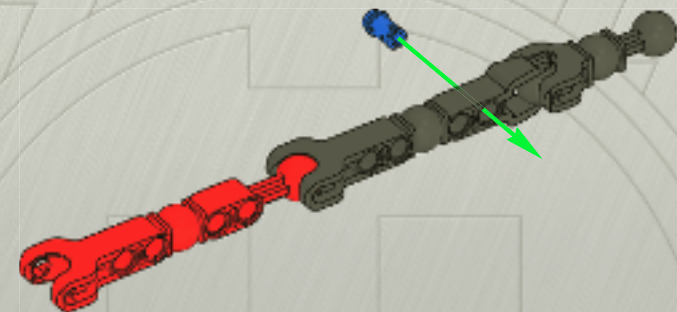

3

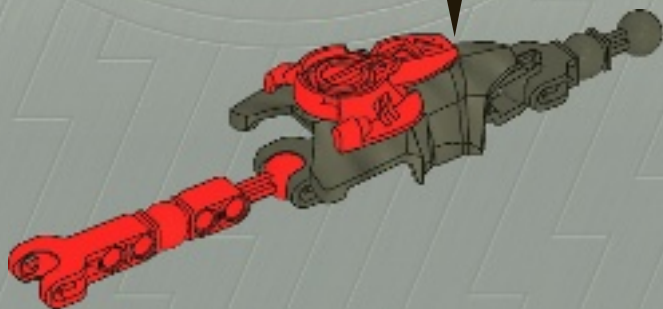
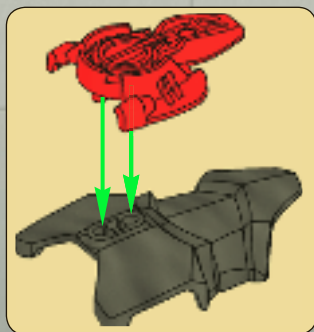



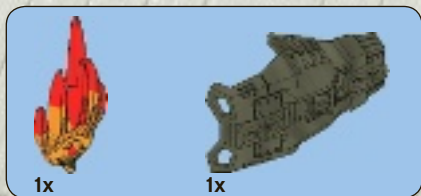

4

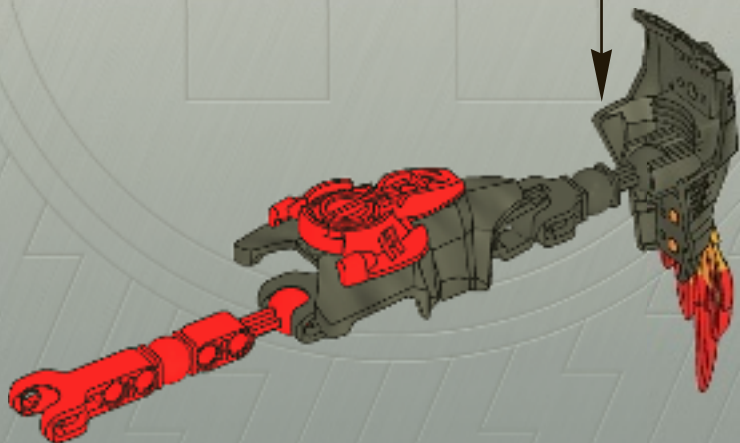
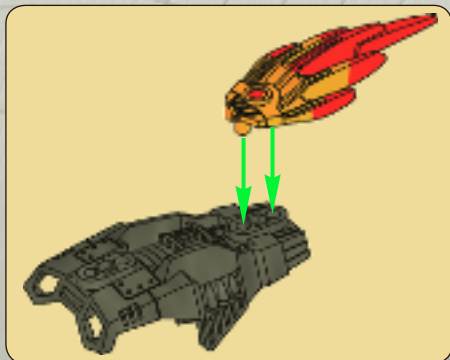

5



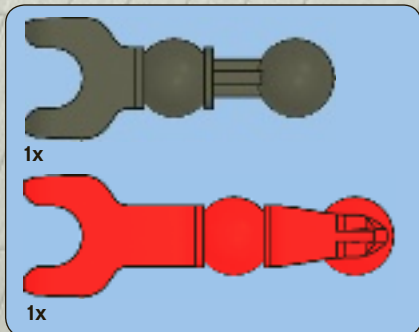

1

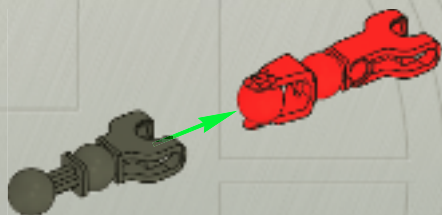

2

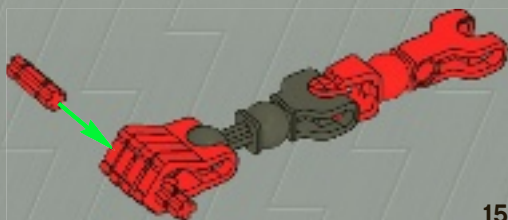

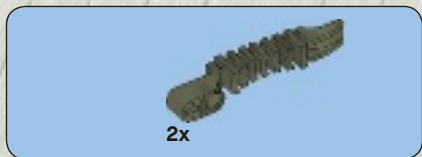

3

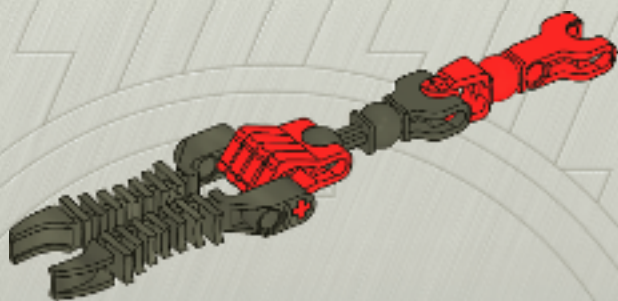

6

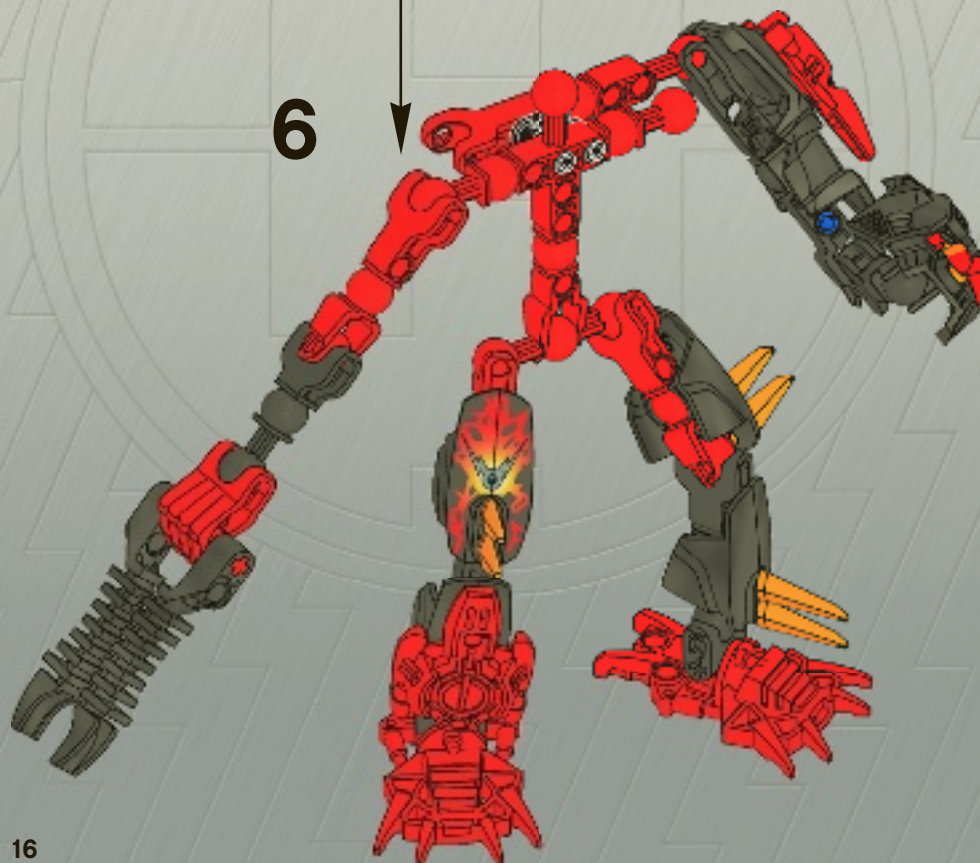





7

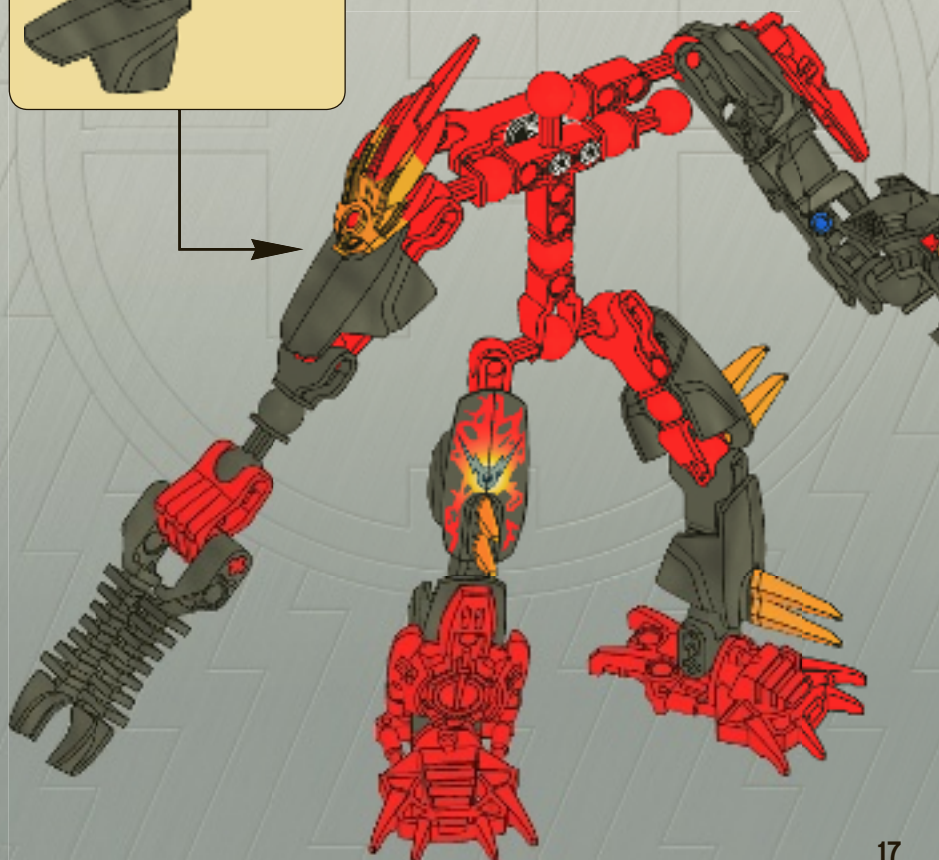
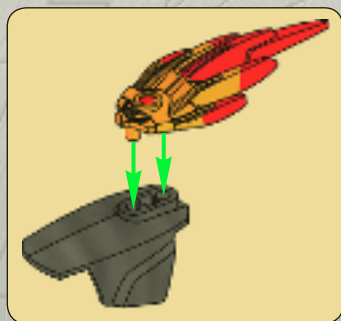



8

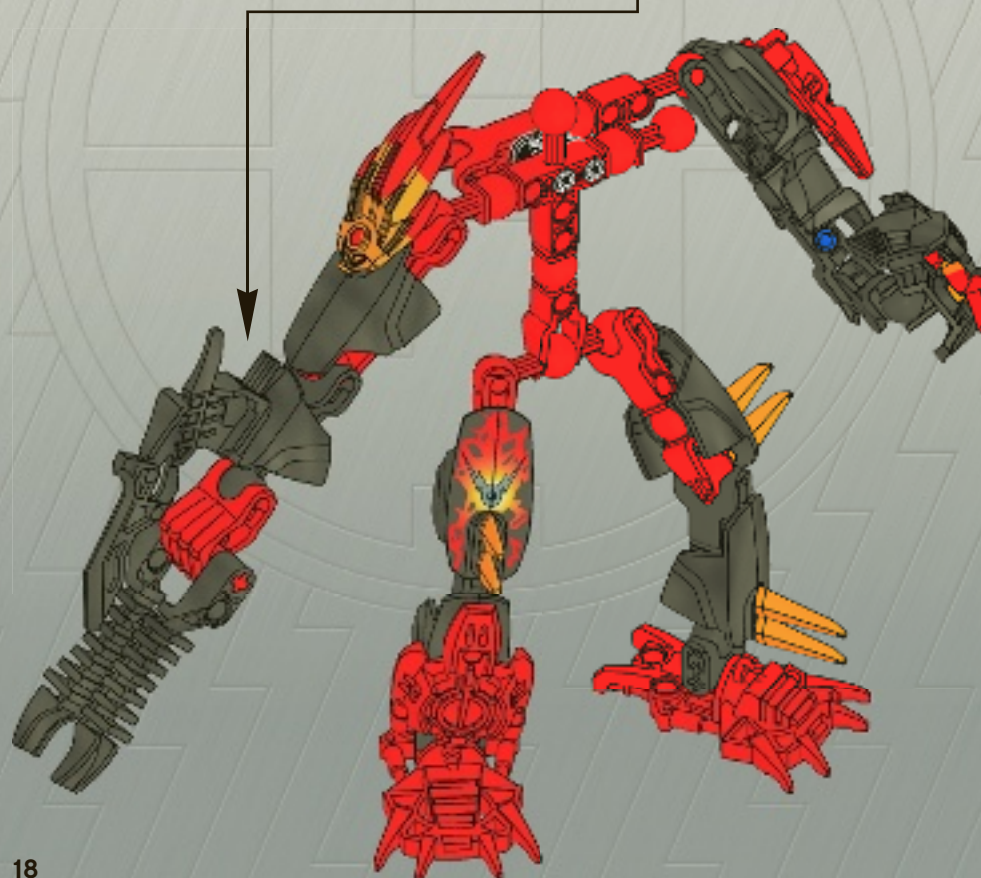
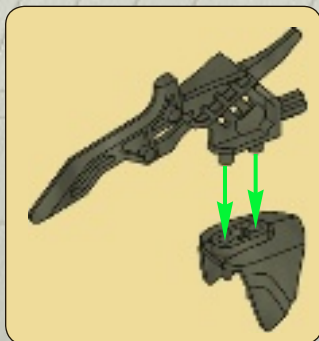

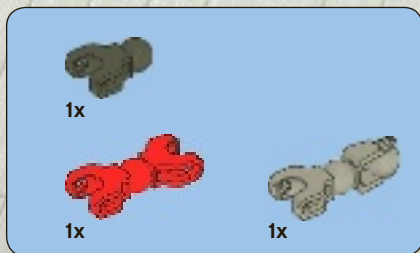

9

1



2

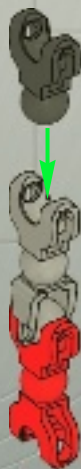

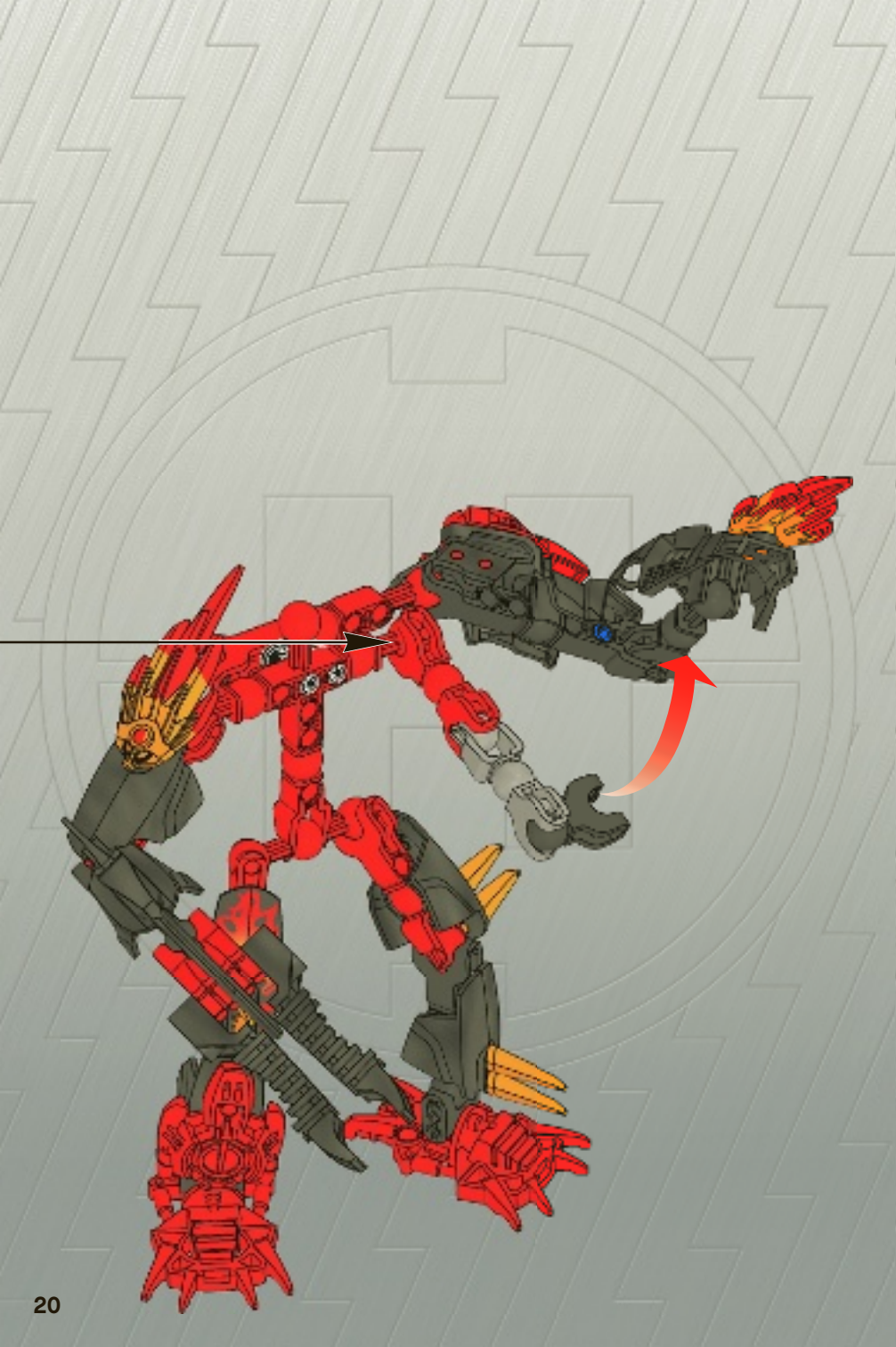



10

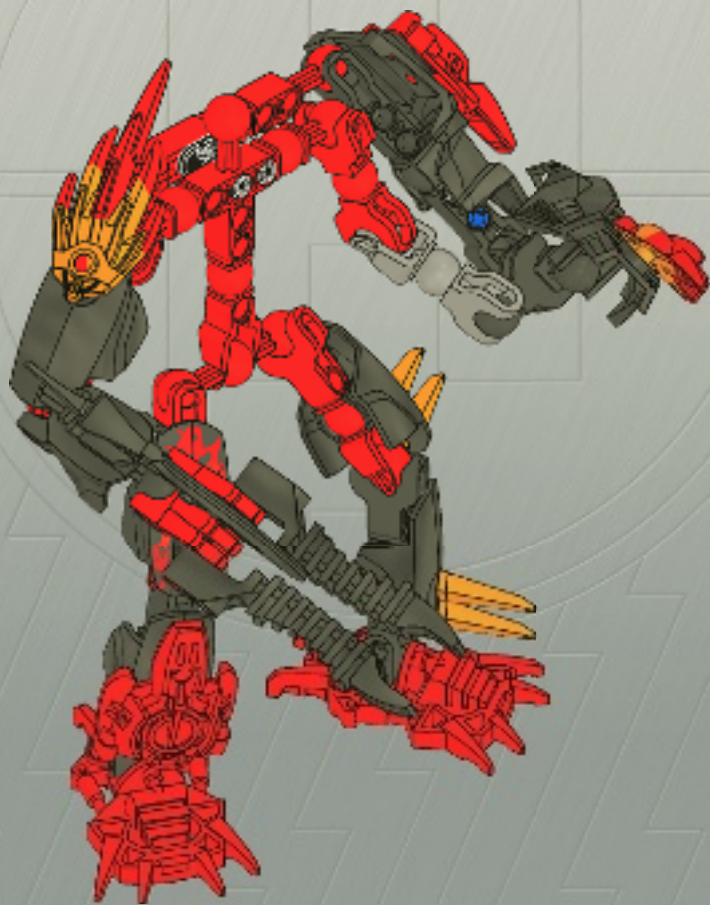



11

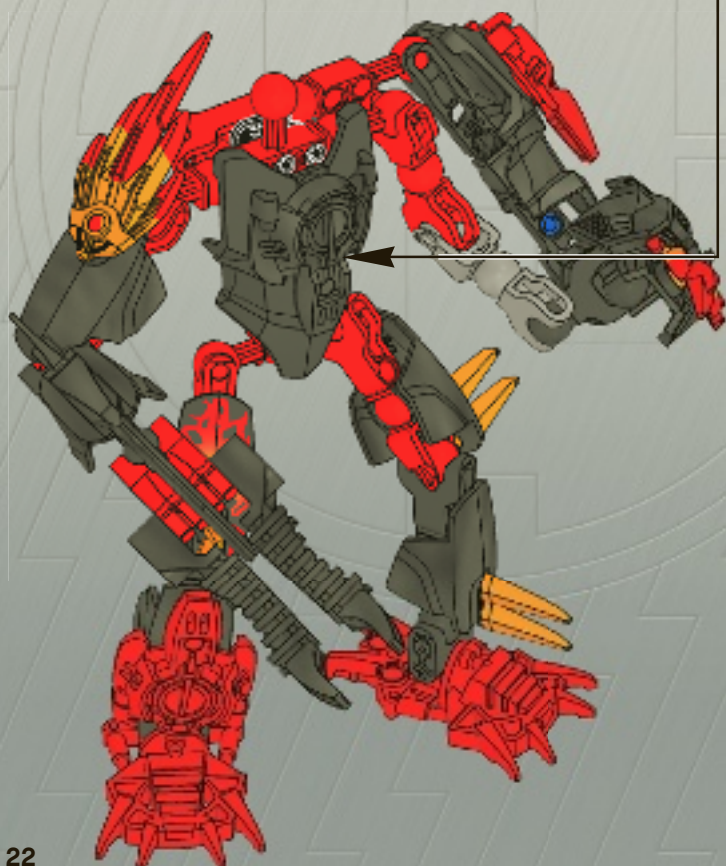
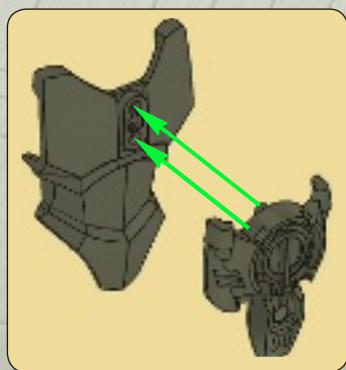



1x

# 12

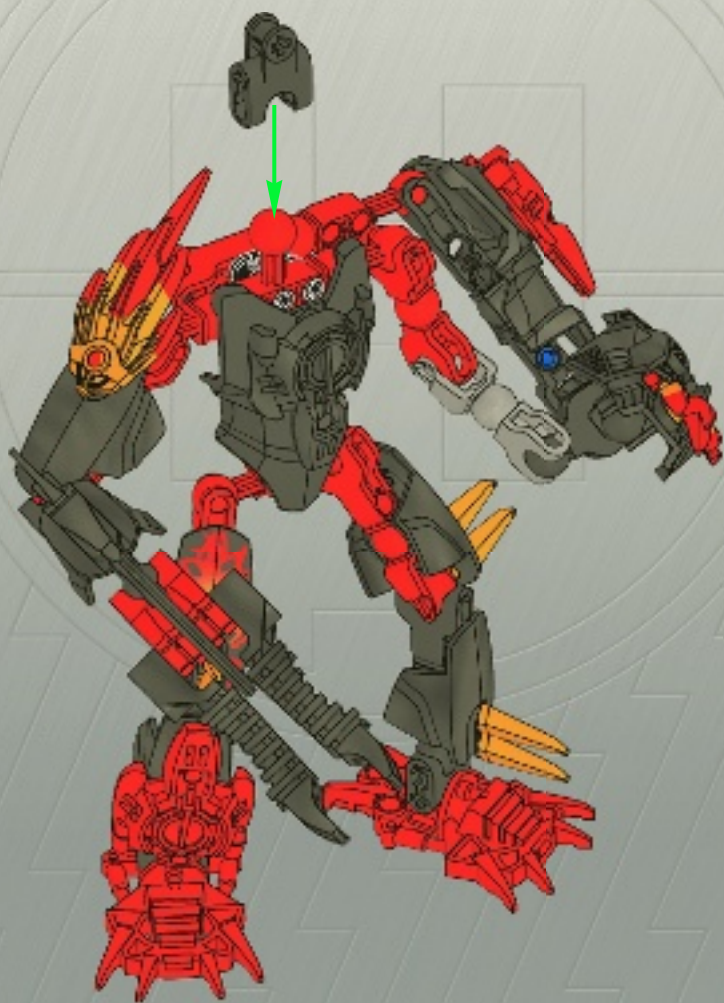



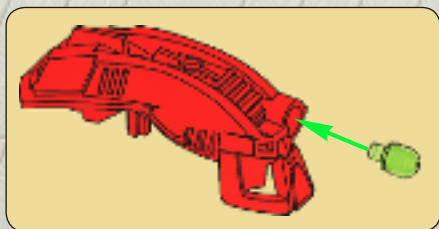

13





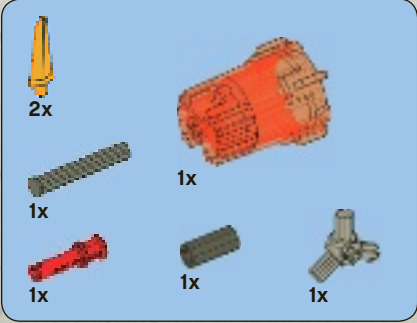

# 14

1



2



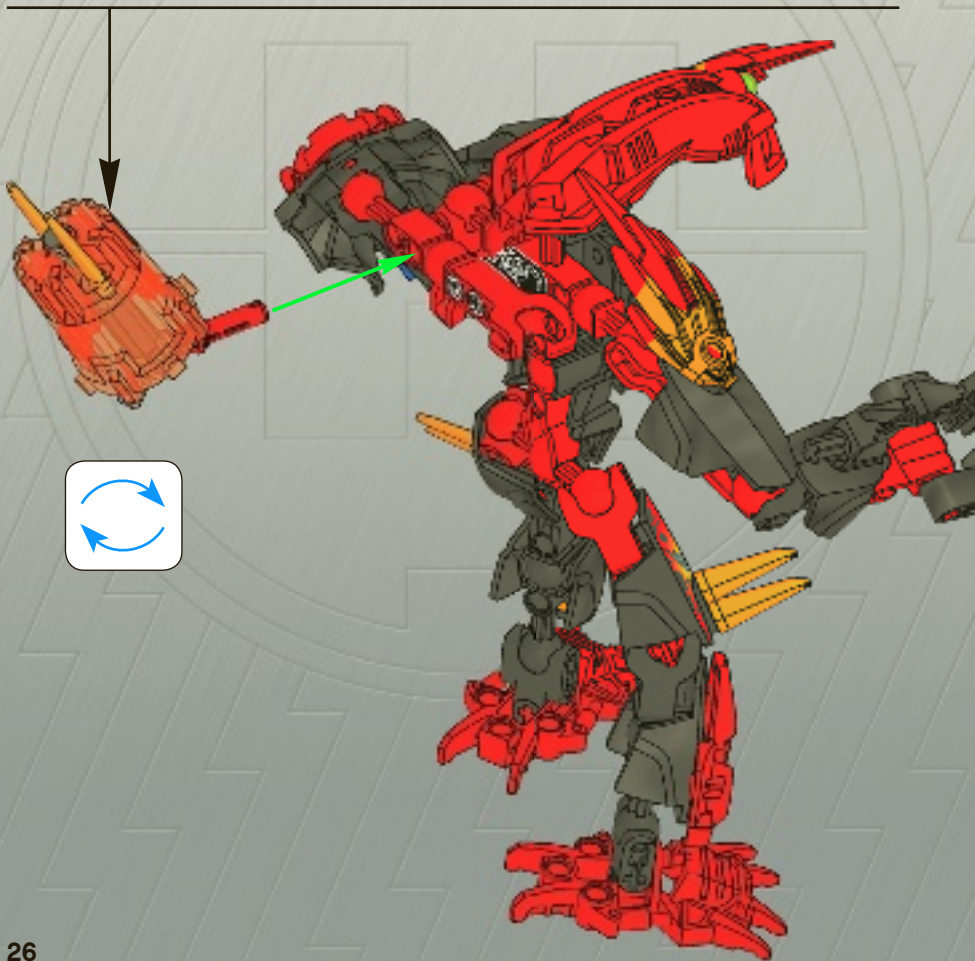
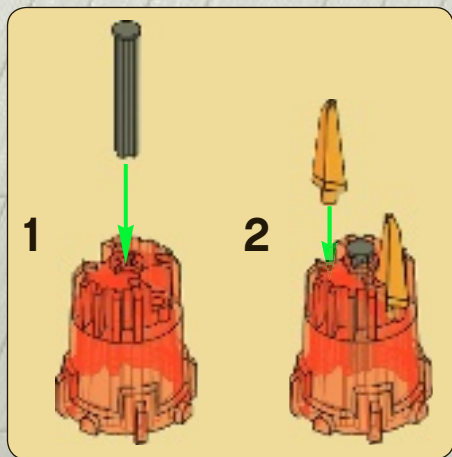

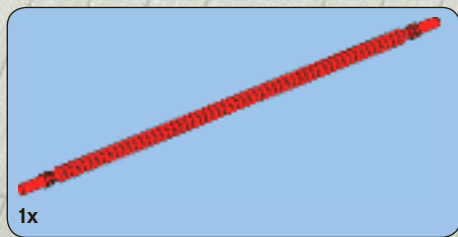

15





1x

16

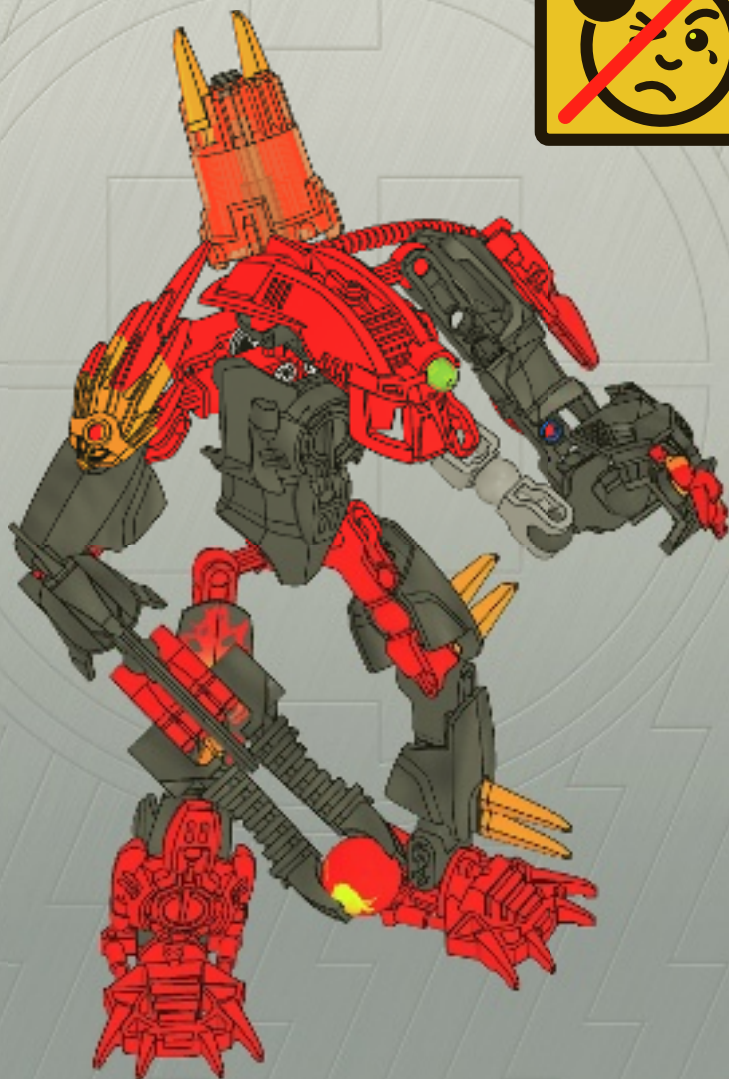
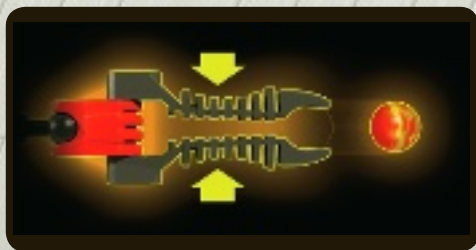





1x  
4610915



1x  
4614227



3x  
4614228



1x  
4614230



1x  
4591538



1x  
4609762



2x  
4292594



2x  
4591614



2x  
4142865



1x  
4140806



1x  
4609780



3x  
4610948



1x  
4593557



2x  
4593555



2x  
4593553



1x  
4593558



1x  
4632652



1x  
4632595



1x  
4512363



1x  
4622390



2x  
4591604



1x  
4119589



1x  
4612491



8x  
4616841



1x  
4616176



1x  
4502595



1x  
4560177



1x  
4570481



1x  
4143005



4x  
4632641



1x  
4632593



1x  
4612489



1x  
4609763



2x  
4609686



1x  
4609731



1x  
4632613



Customer Service

Kundenservice

Service Consommateurs

Servicio Al Consumidor

[www.lego.com/service](http://www.lego.com/service) or dial

 : 00800 5346 5555

 : 1-800-422-5346

 : 1-800-422-5346

# HeroFactory.LEGO.com





www.LEGOclub.com

**LEGO club**™

**FREE! GRATIS! GRATUIT!**



**LEGO® Club Magazine**



**LEGO® Club Email**

**SIGN UP ONLINE!**  
**www.LEGOclub.com**

VISIT THE WORLD'S  
BIGGEST LEGO® SHOP!  
**www.LEGOshop.com**

00800 5346 5555

 1-866-534-6258 • 1-877-518-5346

USA & Canada only

EUROPE



\* Freephone. Mobile charges may apply. \* Numéro sans frais. Des frais peuvent s'appliquer avec les téléphones cellulaires. \* Gebührenfrei, Kosten für Anrufe aus Mobilfunknetzen können abweichen. \* Gratis telefoonnummer vanaf vaste lijn. \* Det er et gratis nummer, når du ringer fra fasttelefon. \* Det är gratis, när du ringer från en fast telefon. \* Numéro sans frais. Des frais peuvent s'appliquer avec les téléphones portables.

B1112





# WIN!

Go to [www.LEGOsurvey.com/product](http://www.LEGOsurvey.com/product) to fill out a survey for a chance to win a cool LEGO® Product.

No purchase necessary.

Open to all residents where not prohibited.



[www.LEGO.com](http://www.LEGO.com)



## [www.LEGOsurvey.com/product](http://www.LEGOsurvey.com/product)

### GEWINNE!

Nimm an der Umfrage auf [www.LEGOsurvey.com/product](http://www.LEGOsurvey.com/product) teil und hab die Chance ein cooles LEGO® Produkt zu gewinnen!

Die Teilnahme am Gewinnspiel führt zu keinerlei Kaufverpflichtungen. Teilnahme in allen nicht ausgeschlossenen Ländern möglich.

4620956

### WIN!

Ga naar [www.LEGOsurvey.com/product](http://www.LEGOsurvey.com/product), vul een enquêteformulier in en maak kans op een cool LEGO® product.

Geen aankoopverplichting. Iedereen mag deelnemen, uitgezonderd ingezetenden van landen waar een enquêteverbod geldt.

### GAGNE!

Visite [www.LEGOsurvey.com/product](http://www.LEGOsurvey.com/product) pour répondre à un questionnaire et avoir une chance de gagner un produit LEGO® très cool!

Aucune obligation d'achat. Ouvert à tous les résidents des pays autorisés.

### 当てよう!

[www.LEGOsurvey.com/product](http://www.LEGOsurvey.com/product) にアクセスして、アンケートにご記入ください。当選者にはレゴ®製品を差し上げます。

お買い上げの必要はありません。禁止されていない限り、すべての皆様にご利用いただけます。