



IDEAS

21320



TRICERATOPS HORRIDUS

Booklet available in English on
Heft in deutscher Sprache erhältlich auf
Livret disponible en français sur
Libretto disponibile in italiano su
Folleto disponible en español en
Folheto disponível em português em
A füzet magyarul ezen a honlapon olvasható:
Buklets latviešu valodā pieejams vietnē
如需中文版手册, 请访问 LEGO.com/ideas

What is it about dinosaur fossils that is so mind-blowingly cool?

Is it the fact that they are millions of years old?

Or is it the sheer scale of the bones?

It probably has something to do with the fact that they are real physical evidence that incredible creatures roamed the earth long before we did; something that in many ways defies belief. Fossils tell stories of their time; stories of evolutionary successes and dead-ends, of turbulent lives and complicated ecosystems, and help us piece together the steps that evolution took during these mysterious epochs in life on Earth.

This LEGO® Ideas set, co-created by some very passionate designers, miniaturizes these three awesome fossils on 1:32 scale, and includes a minifigure paleontologist and human skeleton. Now you can build and display some dinosaurs wherever you like...without taking up as much room as the real thing! Enjoy!

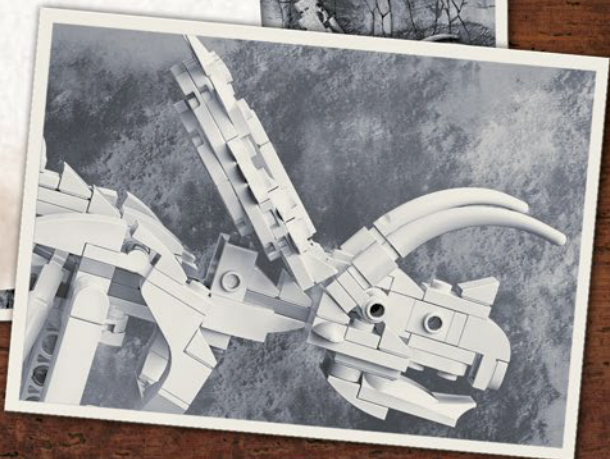
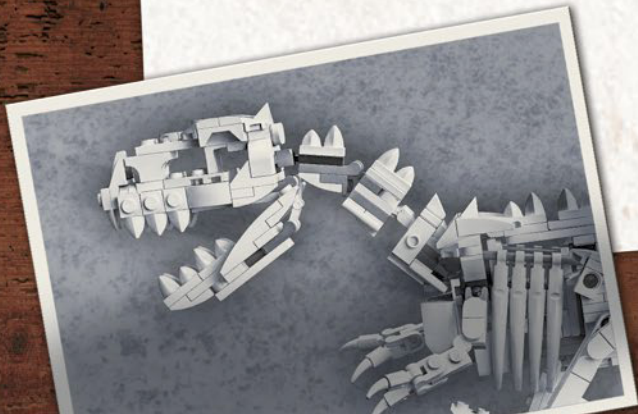
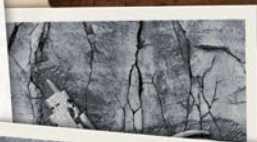

LEGO® Designer: Niels Milan Pedersen

YES! OF COURSE!!!!!!!!!!

That was my reaction when I was asked to work on this project!

I have loved and sculpted dinosaurs for more than 50 years. In fact, I have made more than 60 different skulls and skeletons of prehistoric animals of all kinds and sizes, so I had the blueprints for these three well-known beasts in my head already!

But I hadn't done any building since 2008; my current job involves hand sculpting prototypes of figures and accessories, so it was a matter of getting my hands back into building with bricks.

To get a LEGO® model ready for the market, it has to go through a lot of processes and tests to ensure that it can be built as easily as possible and stay stable. My role was to redesign the already awesome-looking fan designer models to make them follow LEGO standards.

I really liked the overall look of the original builds, but there were just too many special elements. So, I had to redesign it in a rather different way, which also meant changing the colors. I'm very happy with the free-standing poses, and the head of the T-Rex.

So, thank you to Jonathan, the fan designer; without his success on LEGO Ideas, I might not have had the opportunity to work on one of my great passions!

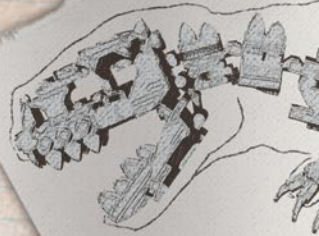



Meet the Fan Designer: Jonathan Brunn



Jonathan is a graphic and web designer, working in a creative agency in Perpignan, France. He is also a massive science and dinosaur geek, into space, searching for fossils and everything related to dinosaurs... and of course, he's a big LEGO® fan.

I inherited my older brother's LEGO collection when I was very young, and since then, I haven't stopped buying and building LEGO sets. I'm really into space and would like to own every single NASA-related set, so my favorite sets would either be the 10231 Shuttle Expedition or the 21309 NASA Apollo Saturn V. I own both of these sets and they are displayed on my desk at work. My clients are always amazed by them when they come to the office.

When I was little, my passion for dinosaurs was almost obsessional.

Dinosaurs were the most incredible thing ever for me, so I made this project to please my inner child! I would have loved it as a kid, and I think every kid who loves dinosaurs and science would agree with me.

It took me 2 years to be pretty happy with the result. I kept improving the models in the updates. Everything was computer-made, which made these models difficult to imagine in real life.



The biggest challenge was to recreate the "animal architecture." Dinosaurs were living animals with real body parts. I needed to use a lot of documentation and pictures as references. The trick then was to keep some consistency in the build, using the same LEGO® parts to keep the same "design line." That was really challenging because a Triceratops body is not the same as a Stegosaurus.

I didn't sleep all night when I heard that the LEGO Ideas team wanted to talk to me on Skype! When they told me that my project had qualified for production, my joy turned into euphoria. From the moment I posted the project on the LEGO Ideas platform to the 10000-vote milestone, I didn't imagine that my dinosaurs would be accepted, and that the LEGO Ideas team would be so excited to work on it! It was an unforgettable moment; few people have the chance to see a childhood dream come true.

What I love about LEGO Ideas is that everyone, young or old, can submit an idea. This is really a beautiful platform where people are kind and encourage you. The criticism is constructive, and the team is awesome.

My advice for other fan designers is never stop believing in it! If you really think your idea is worth it, keep showing it to others! Don't hesitate to contact people who can make some publicity (for example, I wrote to all the biggest natural history museums in the world). Use social media, communicate the potential of your idea, and people will come naturally. Also, the pictures of your project need to be attractive and aesthetic, to gain attention.



THE DINOSAURS

Tyrannosaurus rex King Tyrant Lizard

The T-Rex was a large, bipedal, carnivorous theropod dinosaur with a massive skull, long tail and relatively short forearms, roaming what is now the USA and Canada during the upper Cretaceous Period, 68-66 million years ago. The first partial skeleton of this ferociously large beast was found in the USA in 1900, by Barnum Brown.

The theropod was a subspecies of dinosaur characterized by hollow bones and three-toed limbs. Growing up to 13m long and 7m tall, other theropods may have rivaled its size, but the T-Rex is one of the best-known and most iconic dinosaurs and is thought to have been the one with the most forceful bite! With about 50 banana-sized teeth, it is thought that the T-Rex could tear almost 220 lbs. (100kg) of flesh off their victims in a bite.

There is some debate in paleontology as to whether the T-Rex was mainly a hunter- or scavenger-type of land predator. There is a growing consensus that it was both. A smart move for a smart dinosaur with a brain twice as big as other giant carnivores. The T-Rex could also move fast, at speeds up to 12 mph (20kmh) ... enough to catch a human, had we co-existed with these truly awesome creatures.

Triceratops Three-Horned Face

This herbivorous dinosaur roamed what is now North America about 68 million years ago and is among the last known non-avian dinosaurs. When first discovered, the triceratops was first thought to be a bison-like mammal: the American paleontologist Othniel Charles Marsh only believing it to be a dinosaur after seeing a third, more detailed skull.



In paleontology terms, it has been discovered and documented in many stages and ages, the fossilized bones showing its large bony frill and three horns, reminiscent of a modern rhinoceros. Whether the frills and horns were for protection against predators, or courtship and dominance rituals is debatable, but it is known that the Triceratops was likely preyed on by its neighbor in this LEGO® set, the Tyrannosaurus rex.

The Triceratops was comparable with a modern elephant, weighing in at approximately 5-8 tons and had a bird-like beak that they used for clipping off tough vegetation to eat.

Pteranodon Wing Without Tooth

These flying reptiles are actually not dinosaurs, but by definition, "pterosaurs." However, they are contemporaries of and frequently featured alongside dinosaurs in literature and media and have a special place next to the T-Rex and Triceratops in this LEGO homage to fossil collecting.

The Pteranodon species are well-represented in the fossil record, providing enough information to enable detailed descriptions of their anatomy and life history. The largest adult male could have wingspans up to 18.3 ft. (5.6m) wide and their fossils show their distinctive cranial crests, projecting upwards and backwards from the skull. These crests were thought to be display structures but may have had other functions, too. The Pteranodon was a toothless carnivore, existing off fish by using its pointed beak to scoop them up.

Studies suggest that the Pteranodon flew mainly by soaring, like long-winged seabirds or albatrosses, but they probably also required active bursts of flapping to sustain flight.



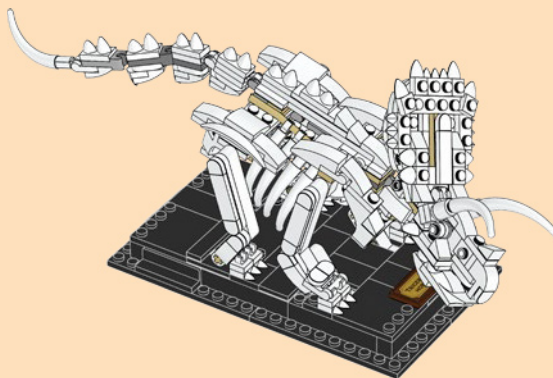
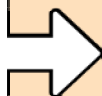
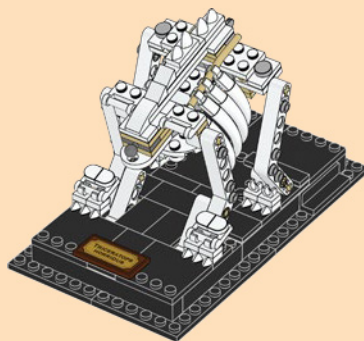
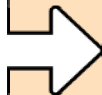

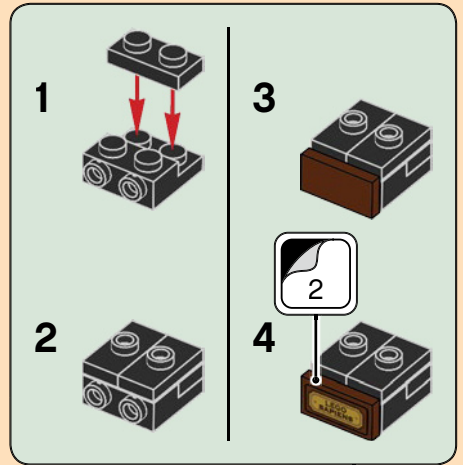
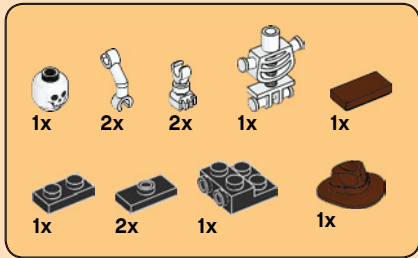
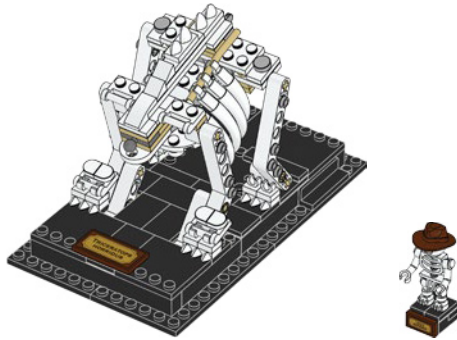

1

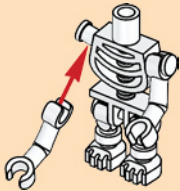

2

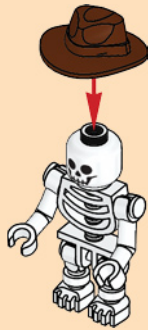

3



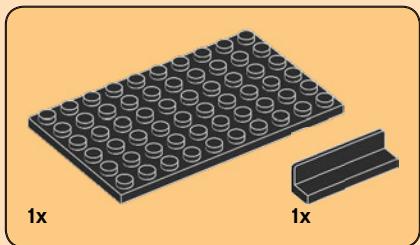
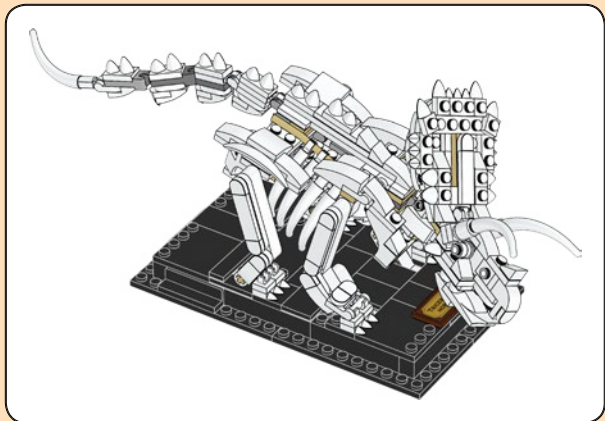

1

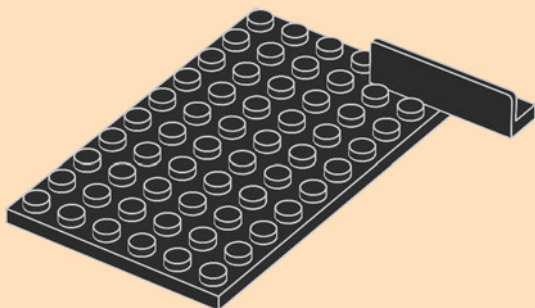

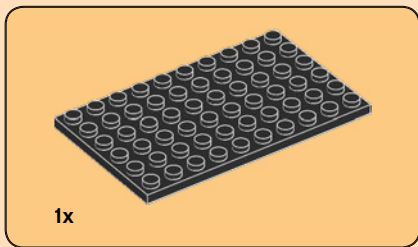

2

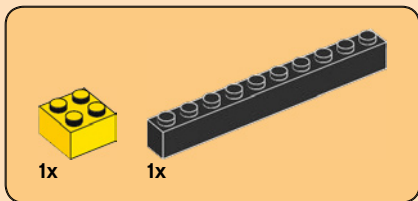
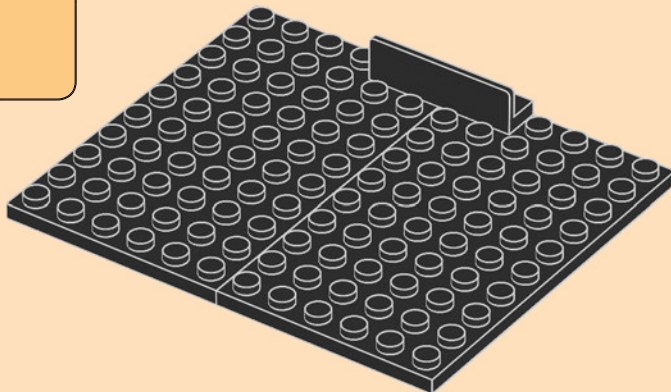

3

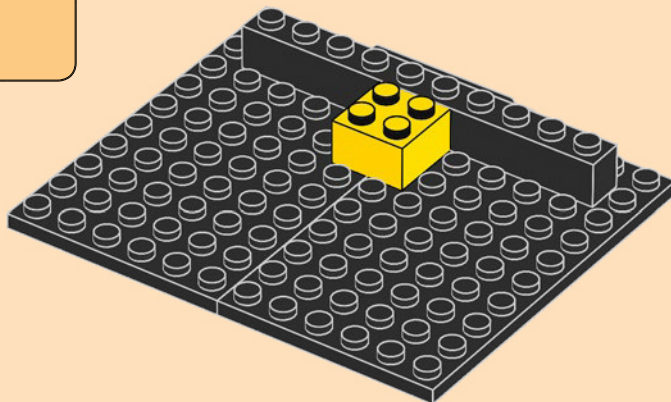

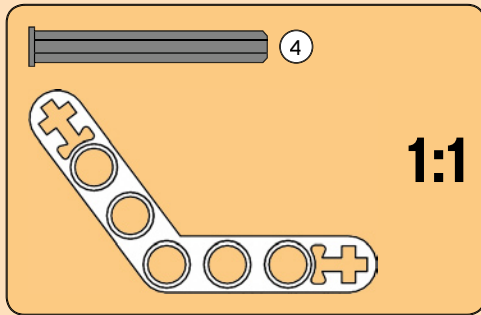
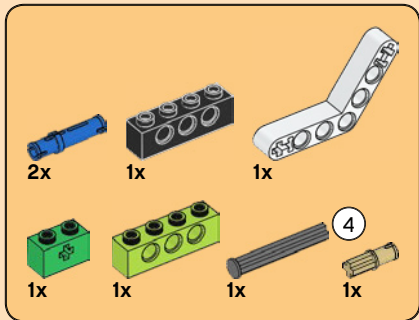

4

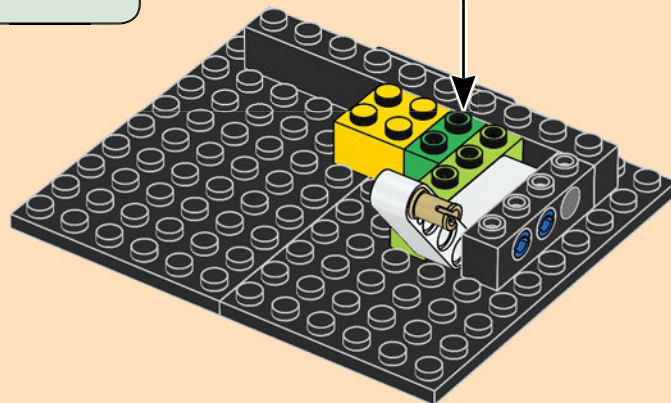
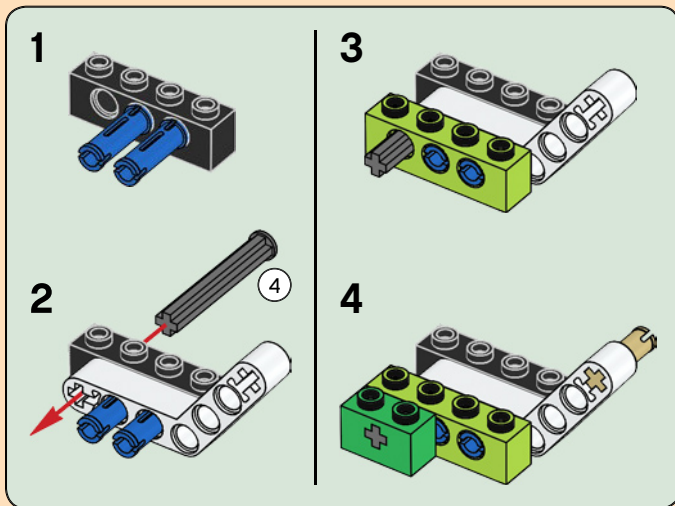

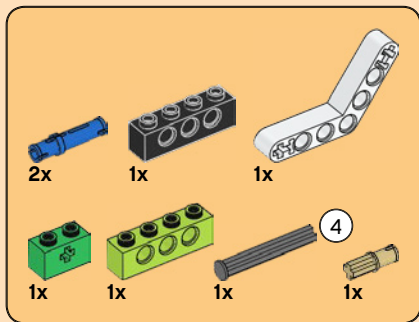

5

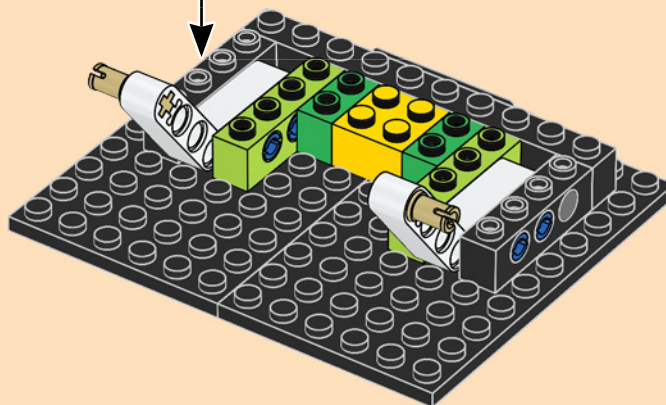
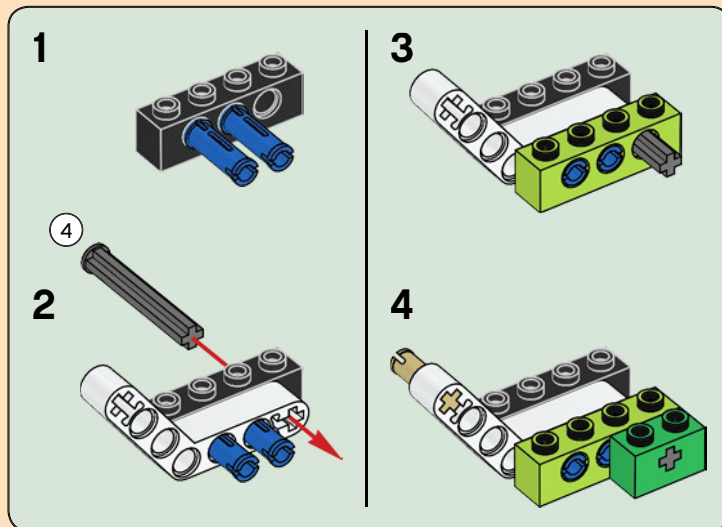

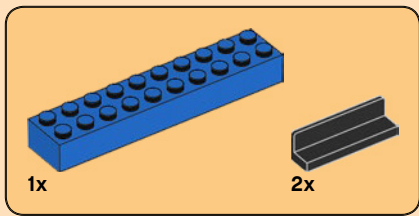

6

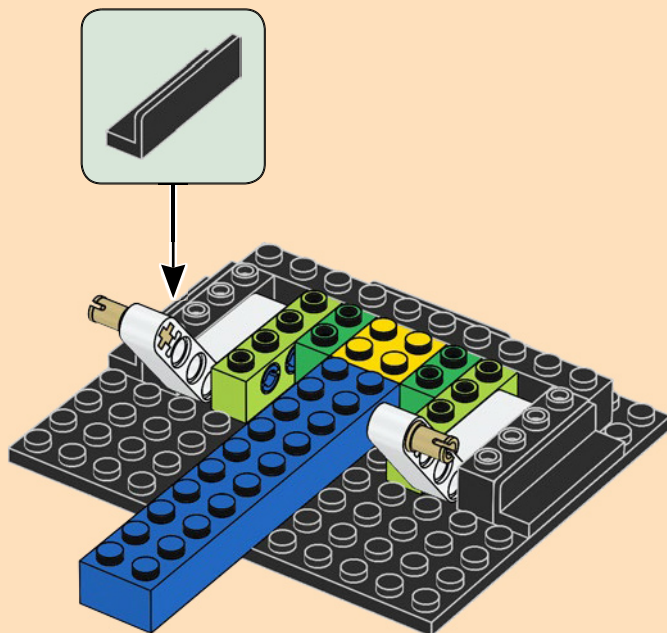

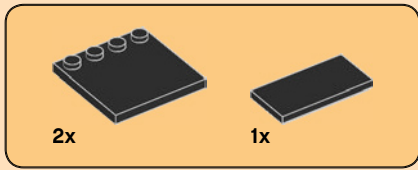

7

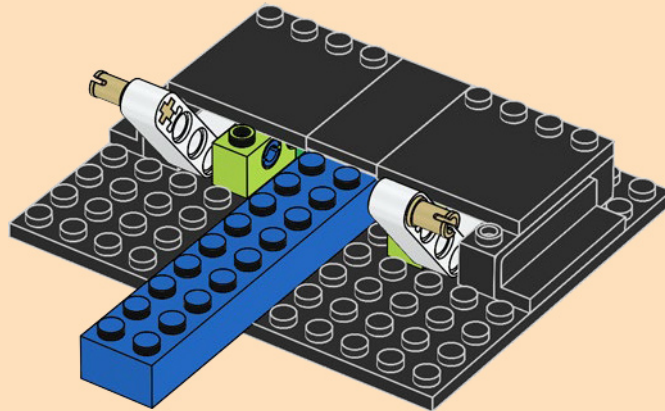

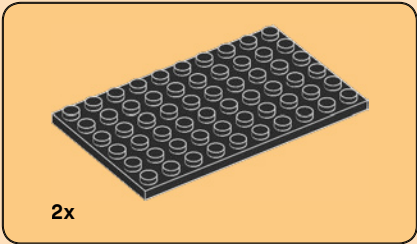

8

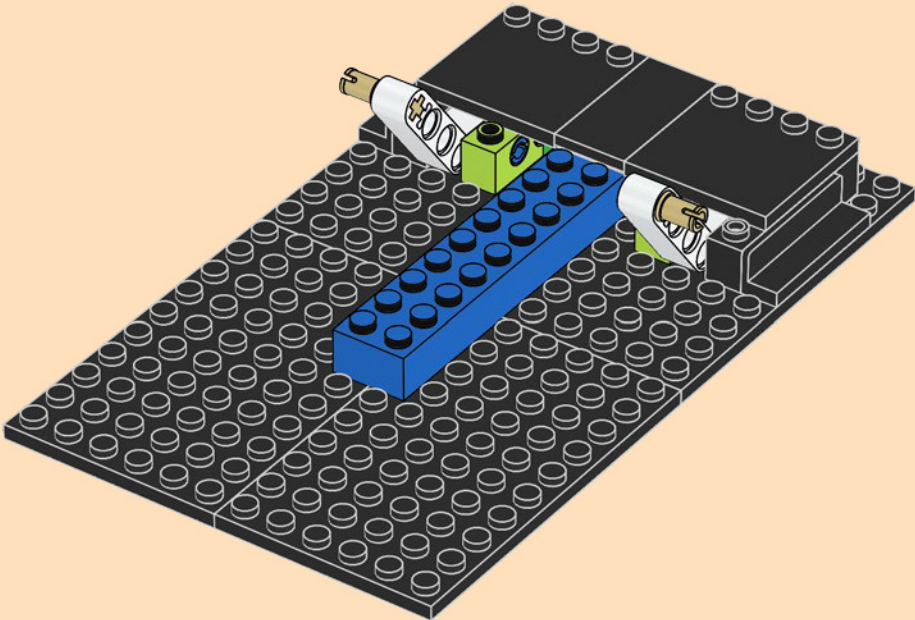

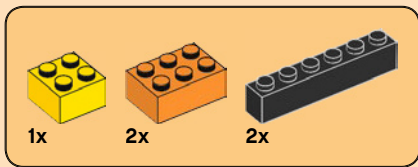

9

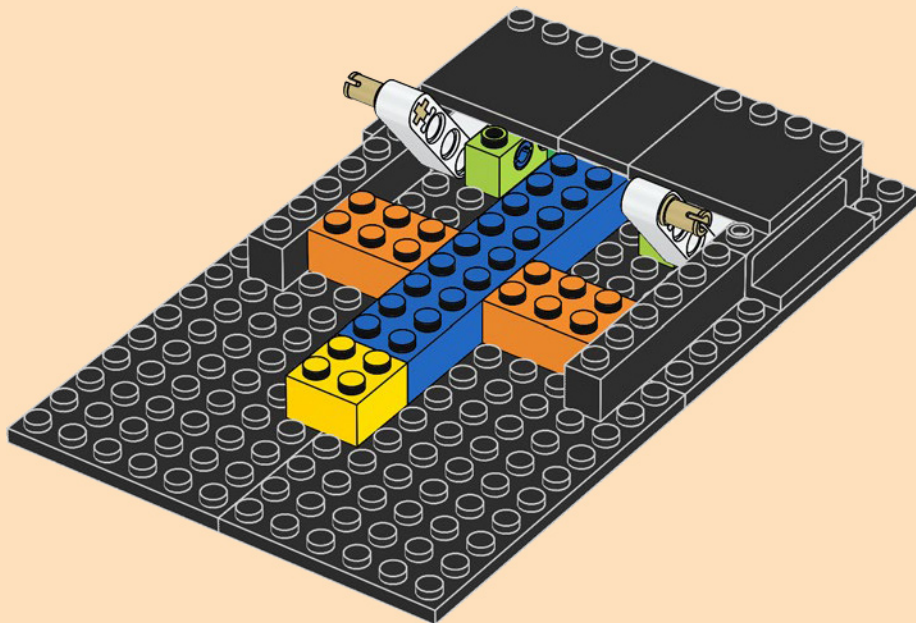

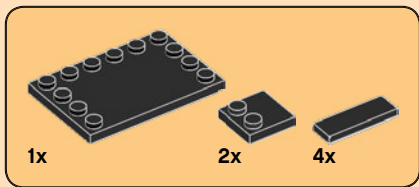

10

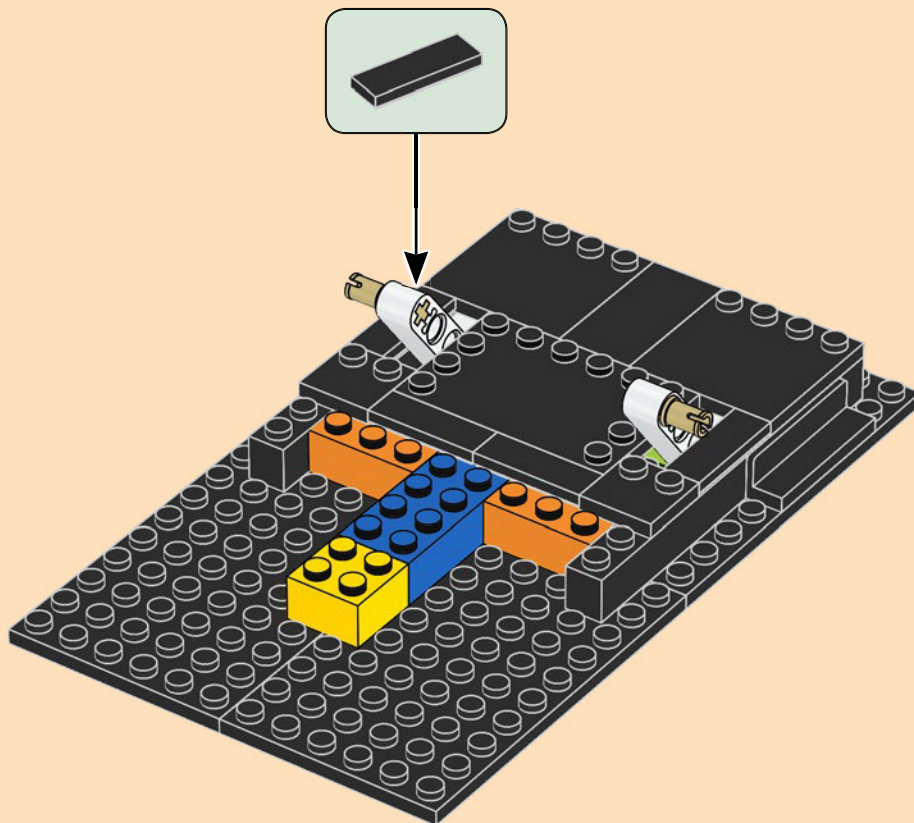

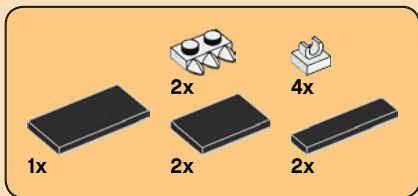

11

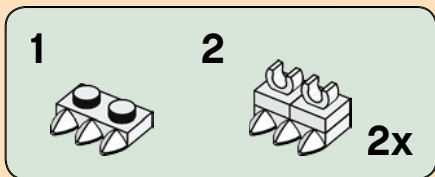
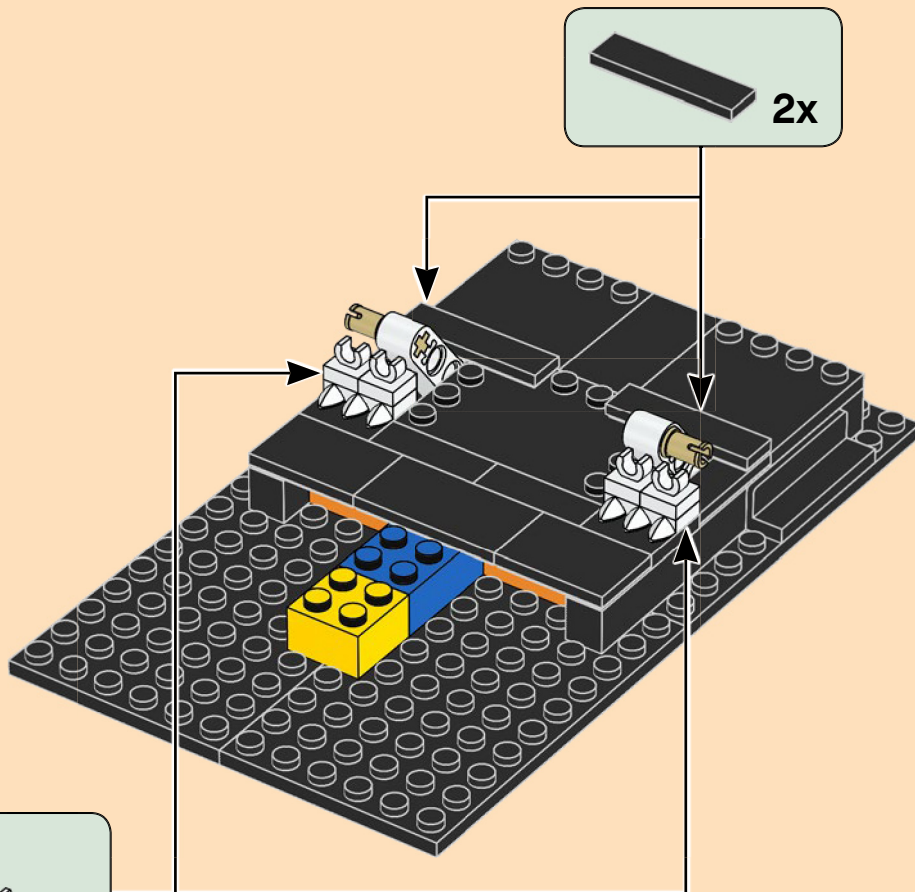

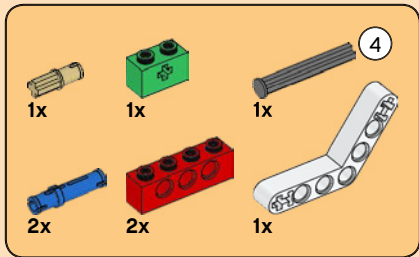

12

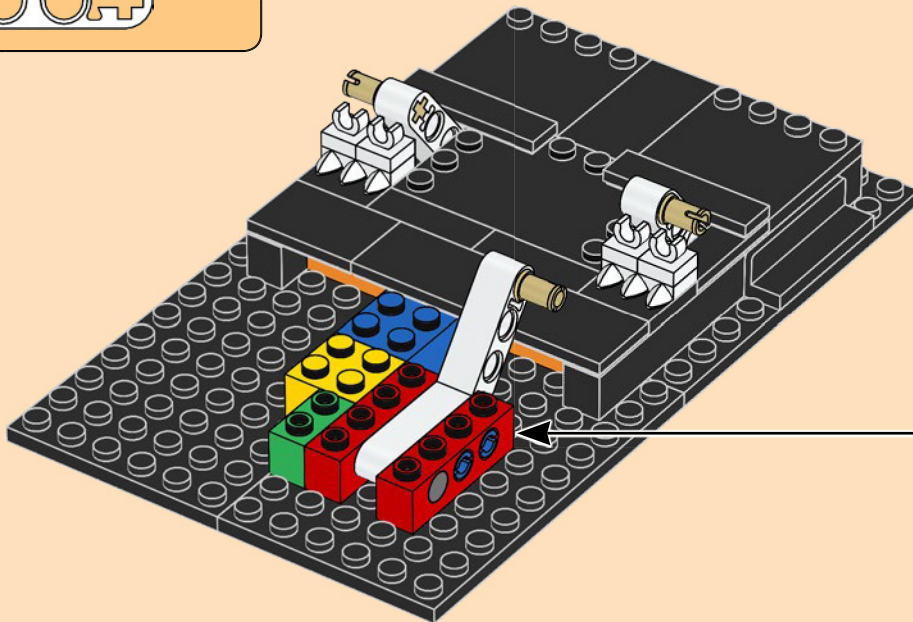
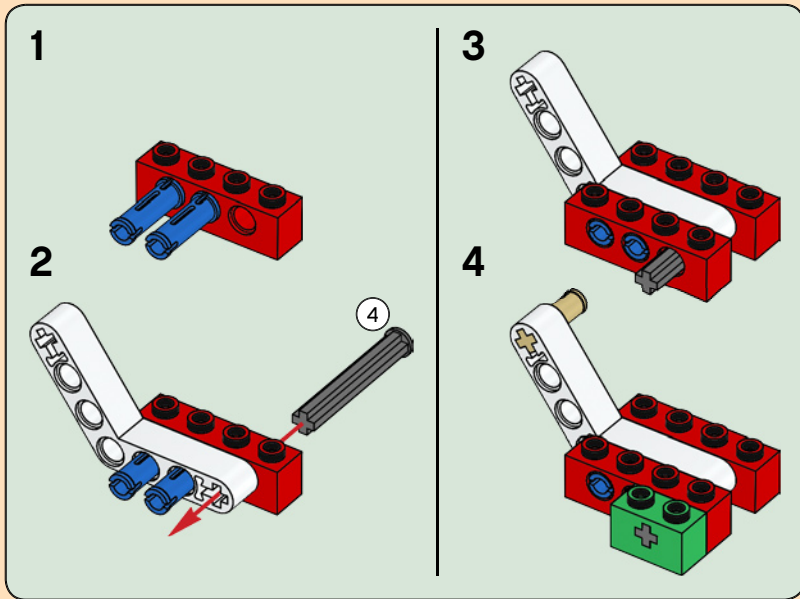
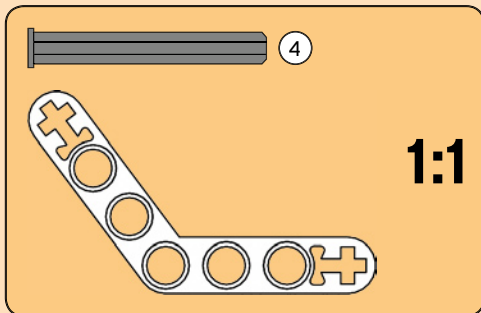

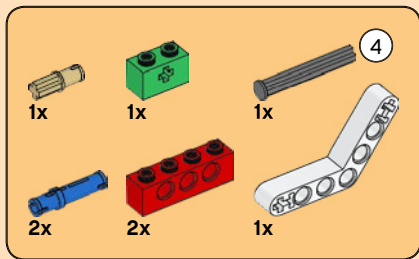

13

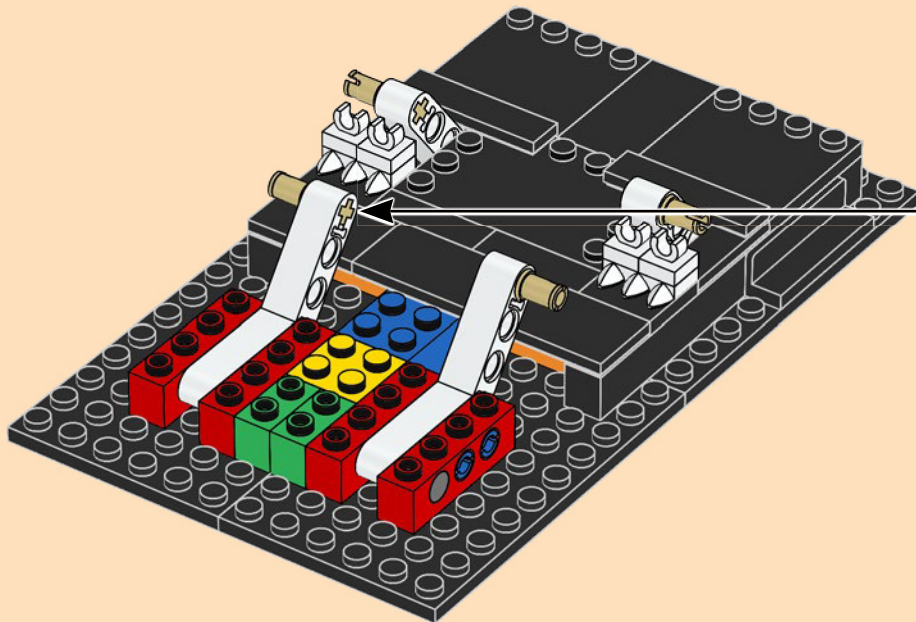
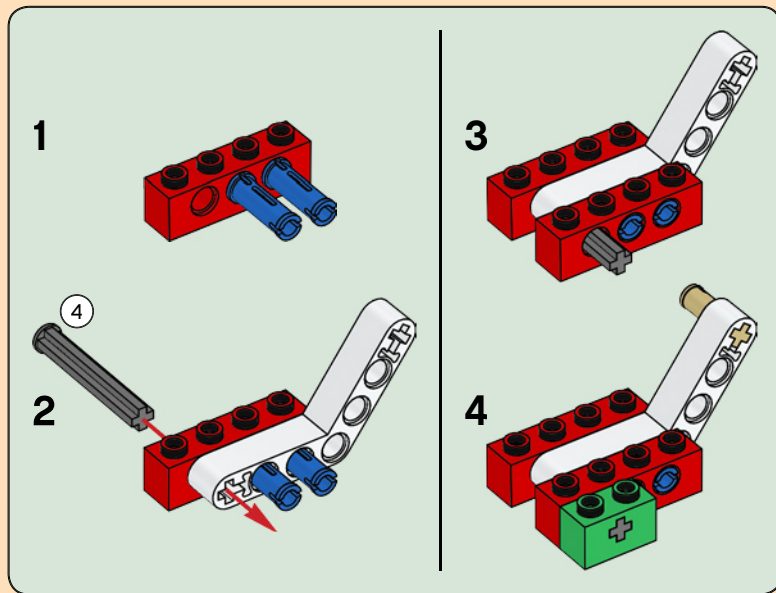

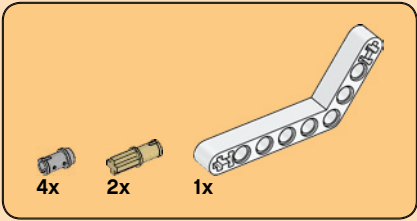

14

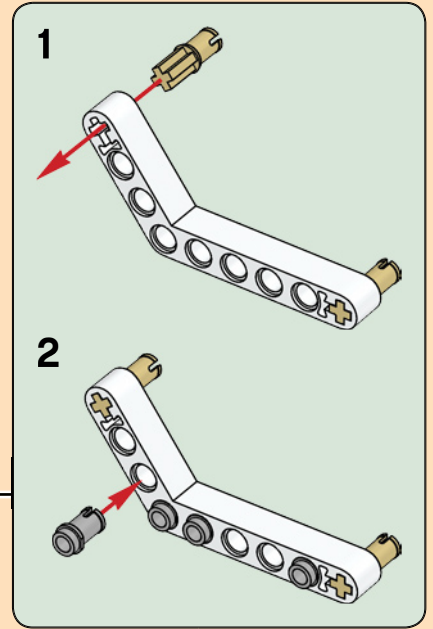
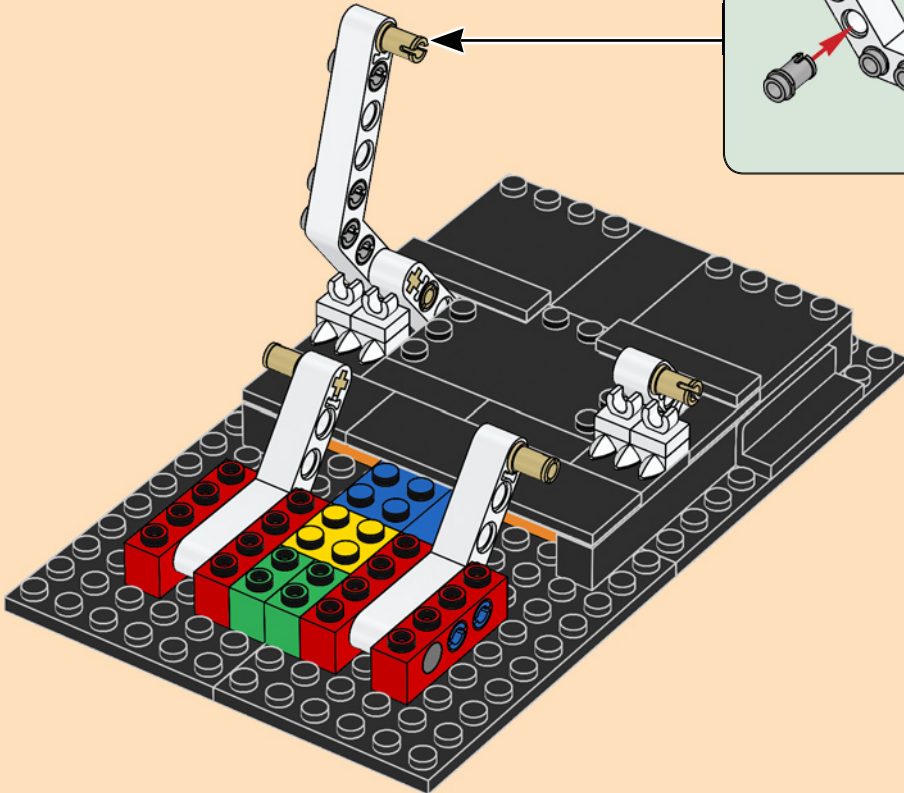

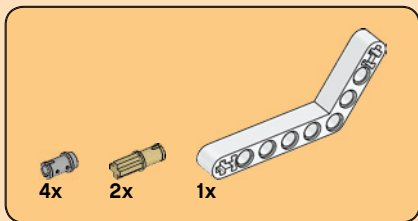

15

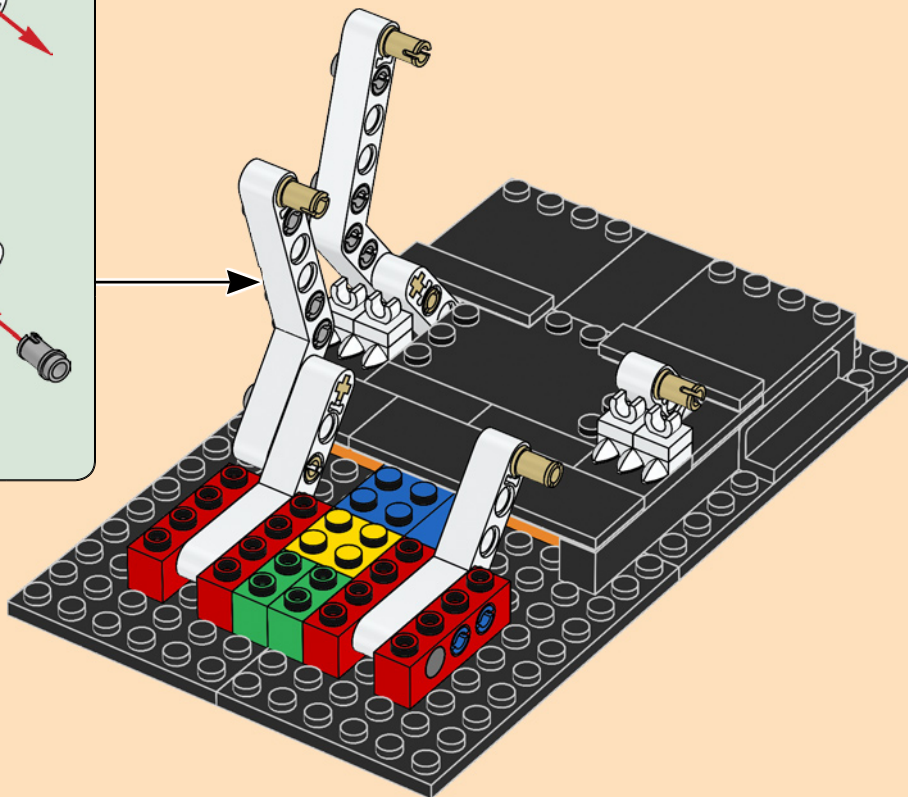
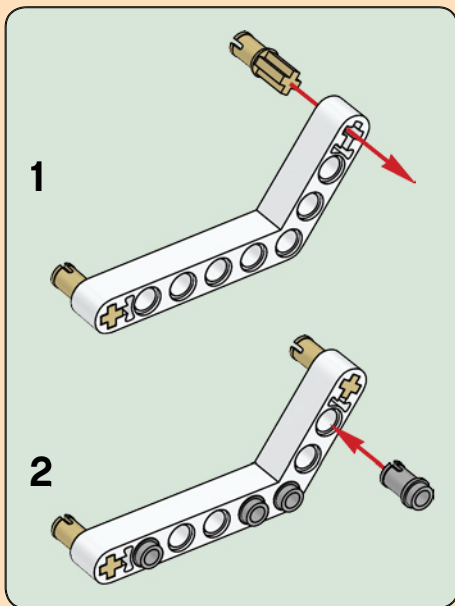

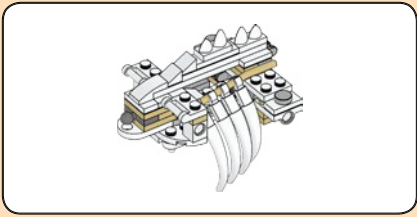

16

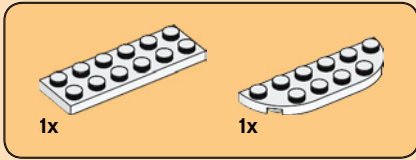

17

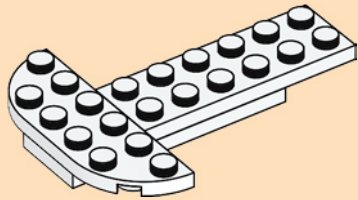

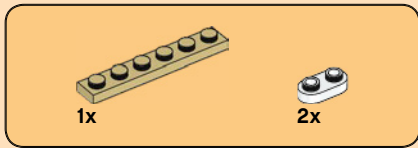

18

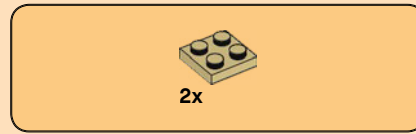
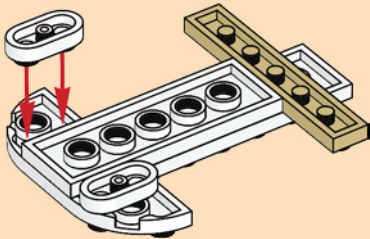

19

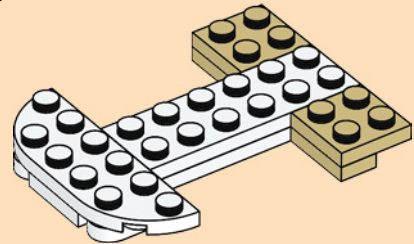
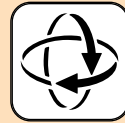

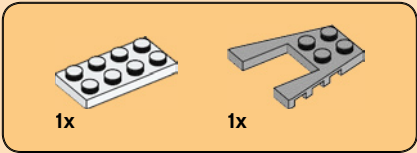

20

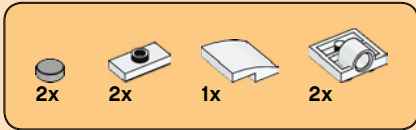
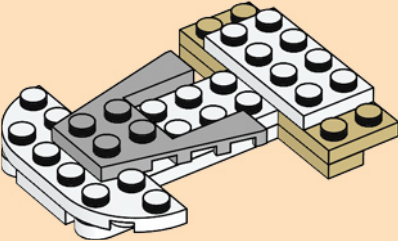

21

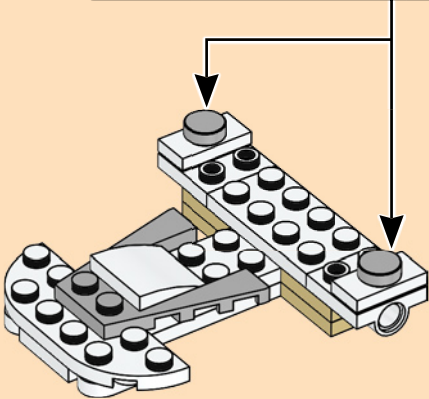
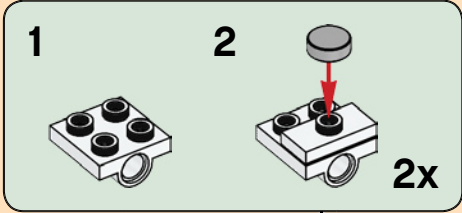

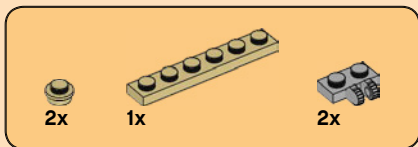

22

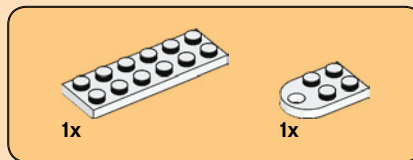
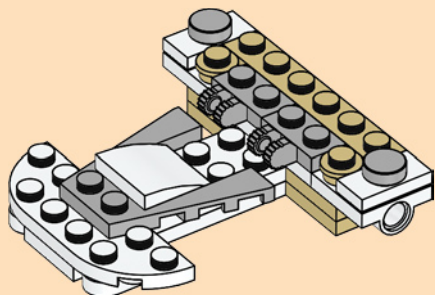

23

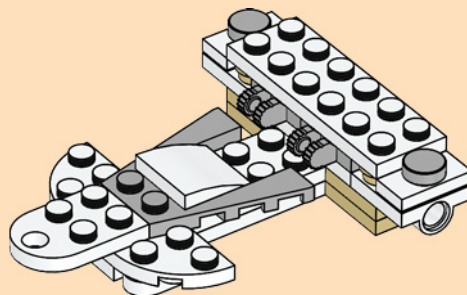



24

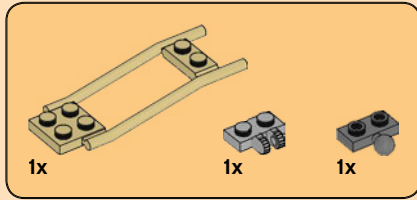
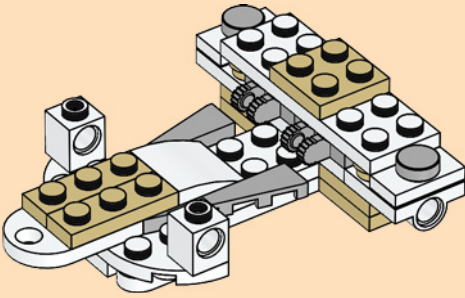

25

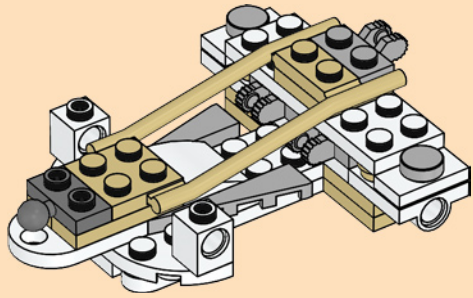

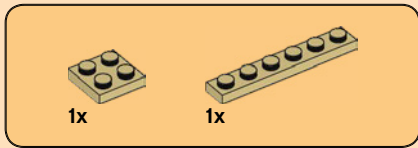

26

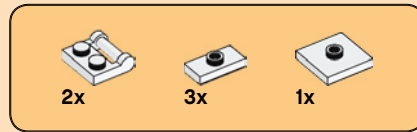
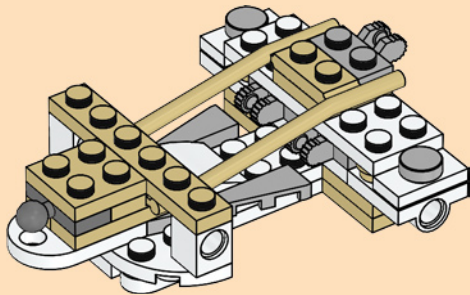

27

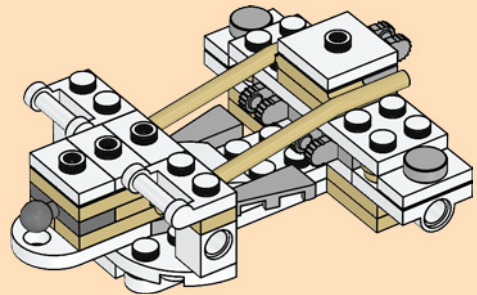

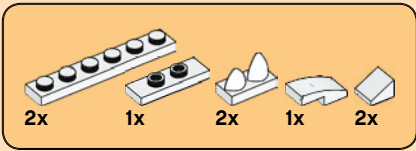

28

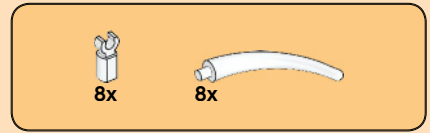
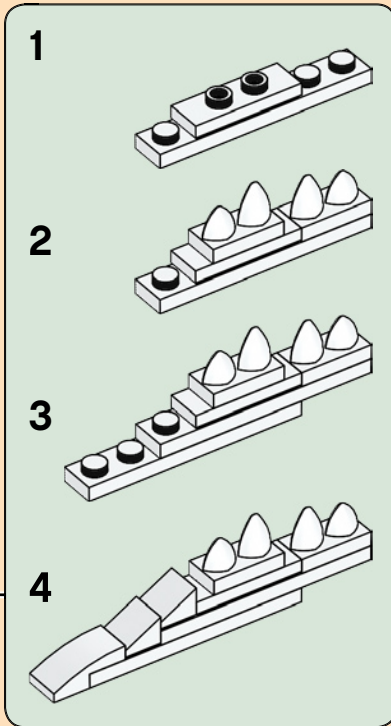
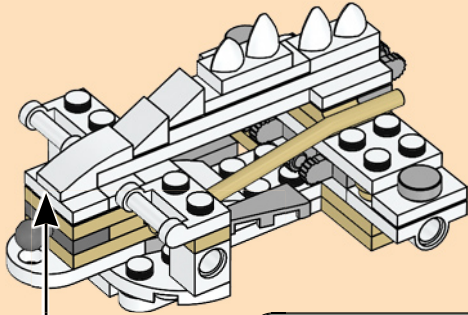

29

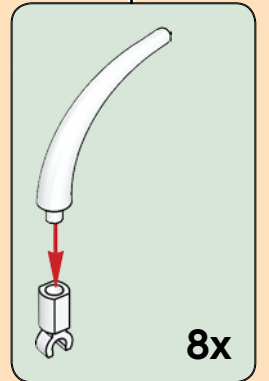
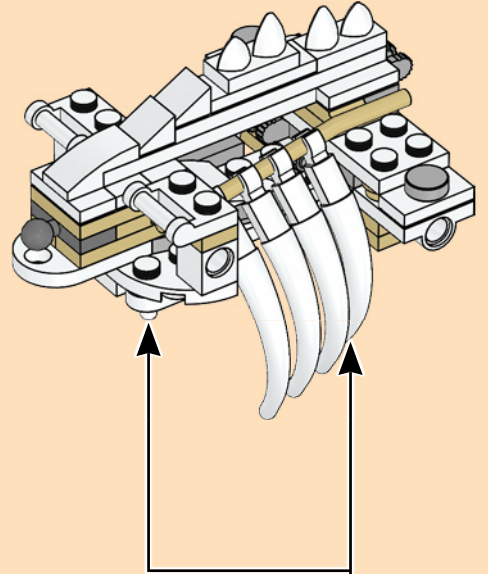

30

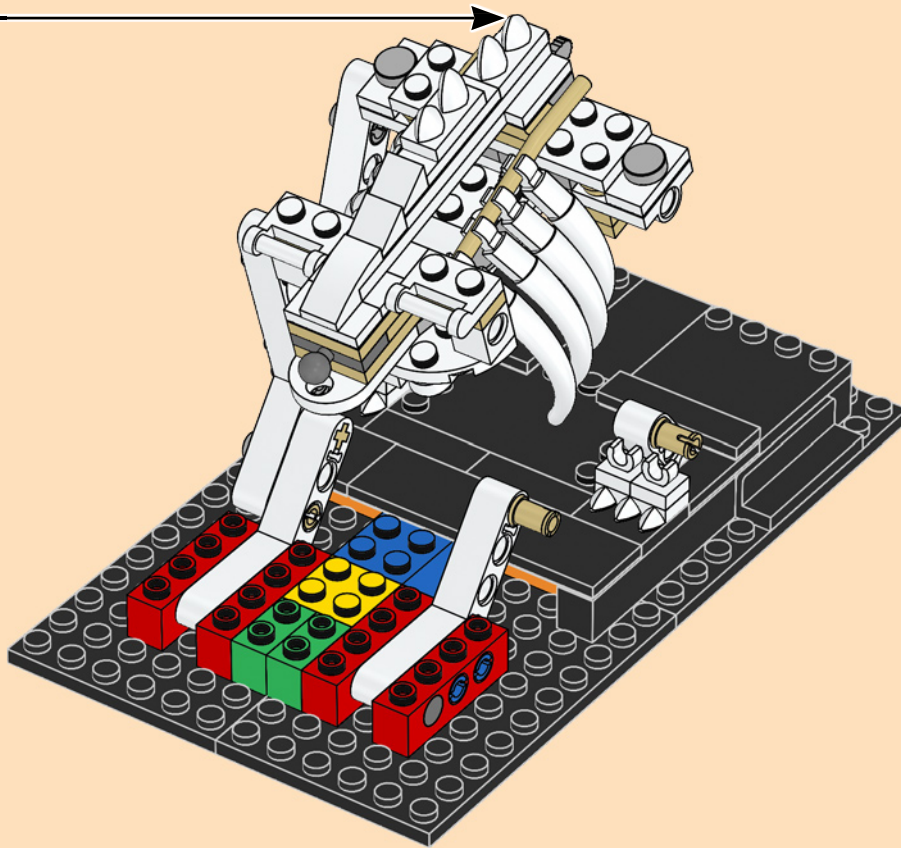

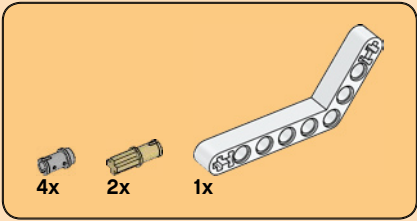

31

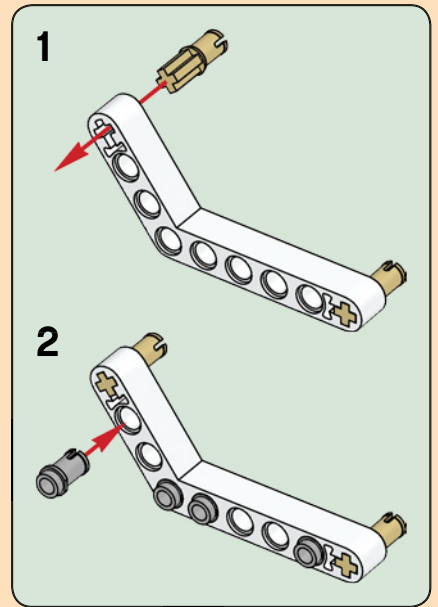
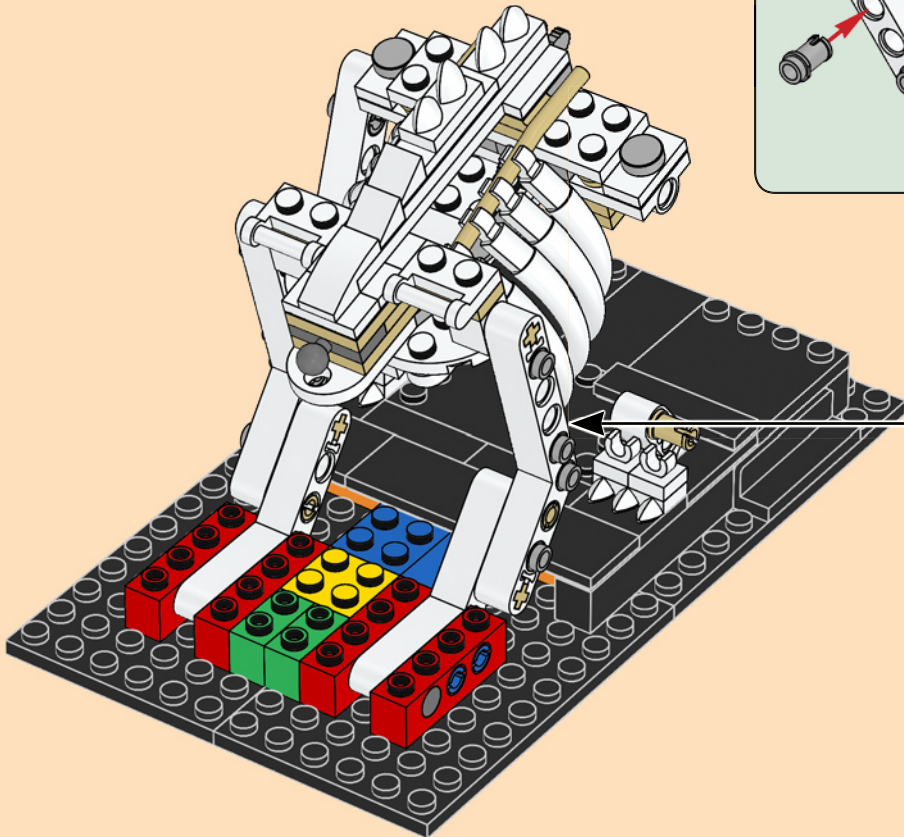

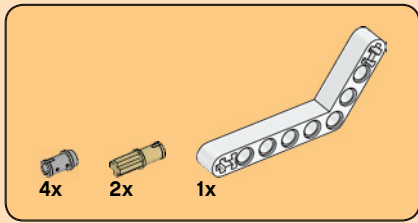

32

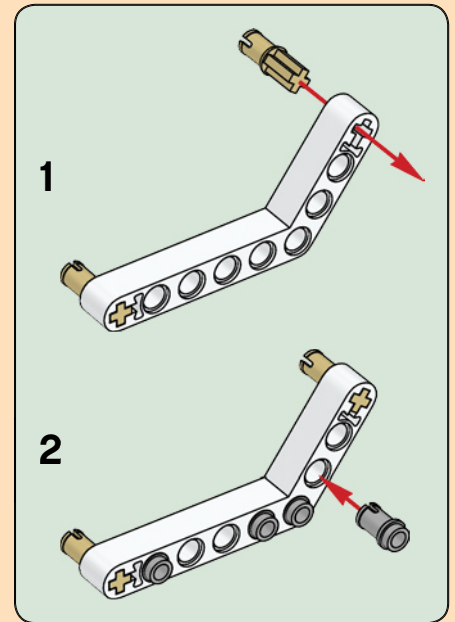
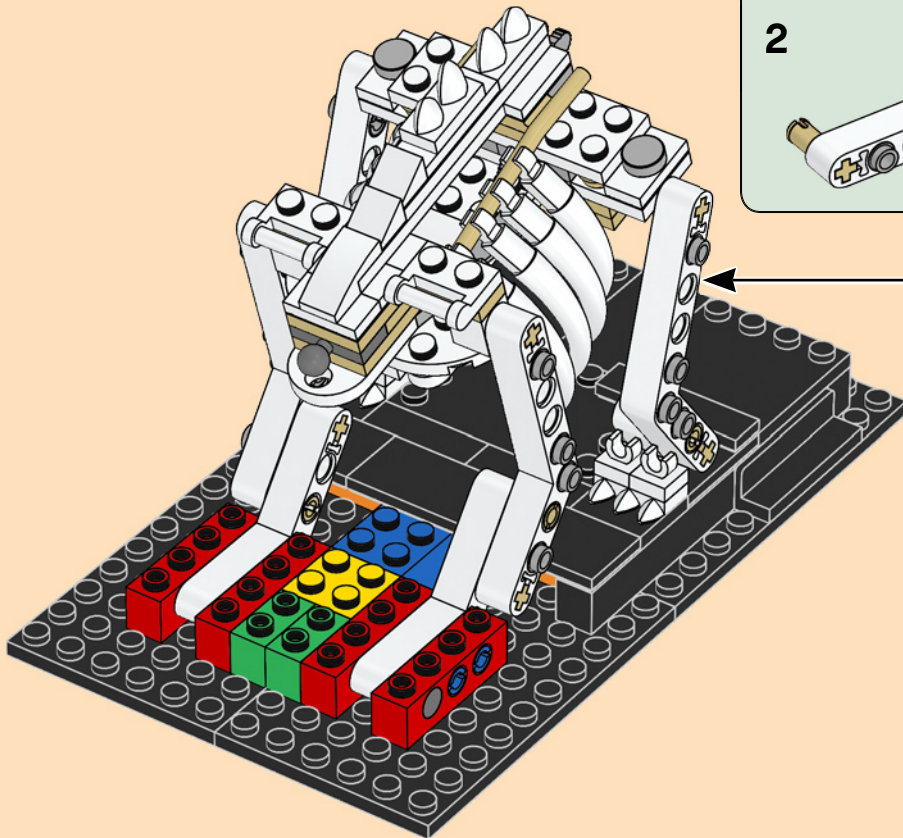

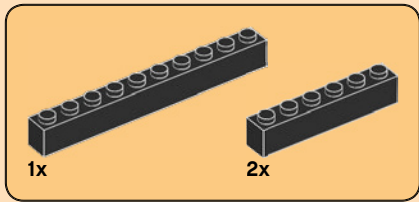

33

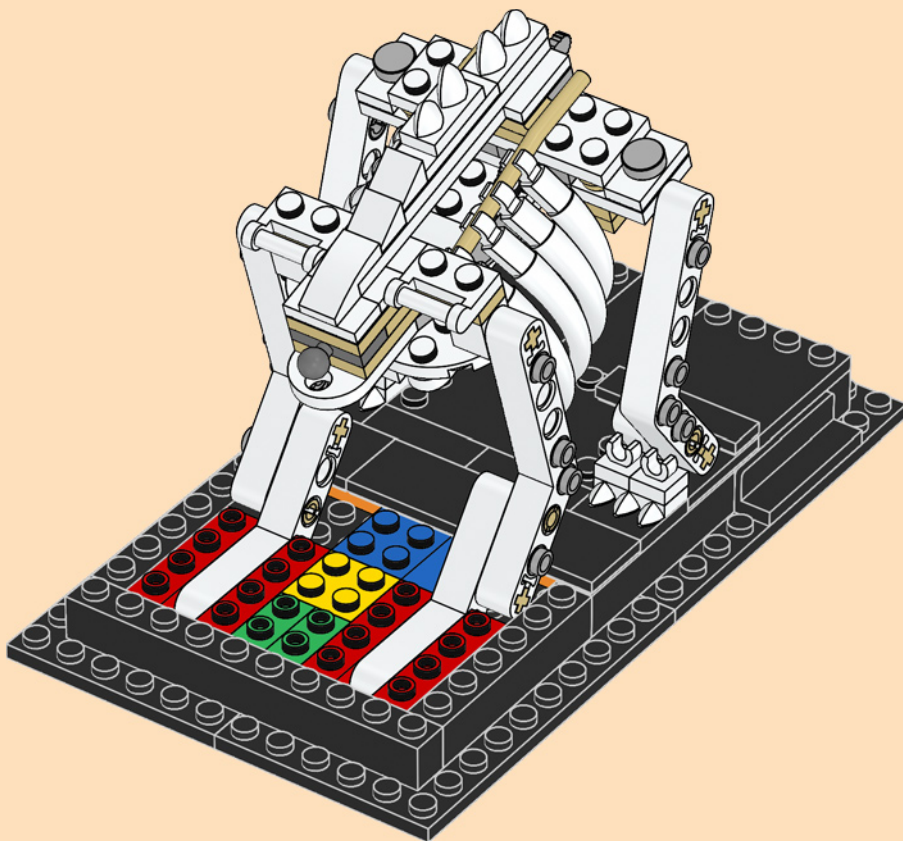

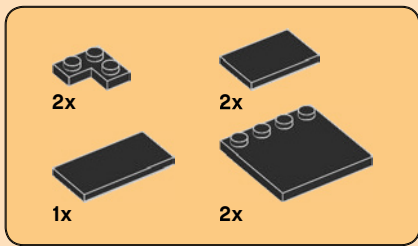

34

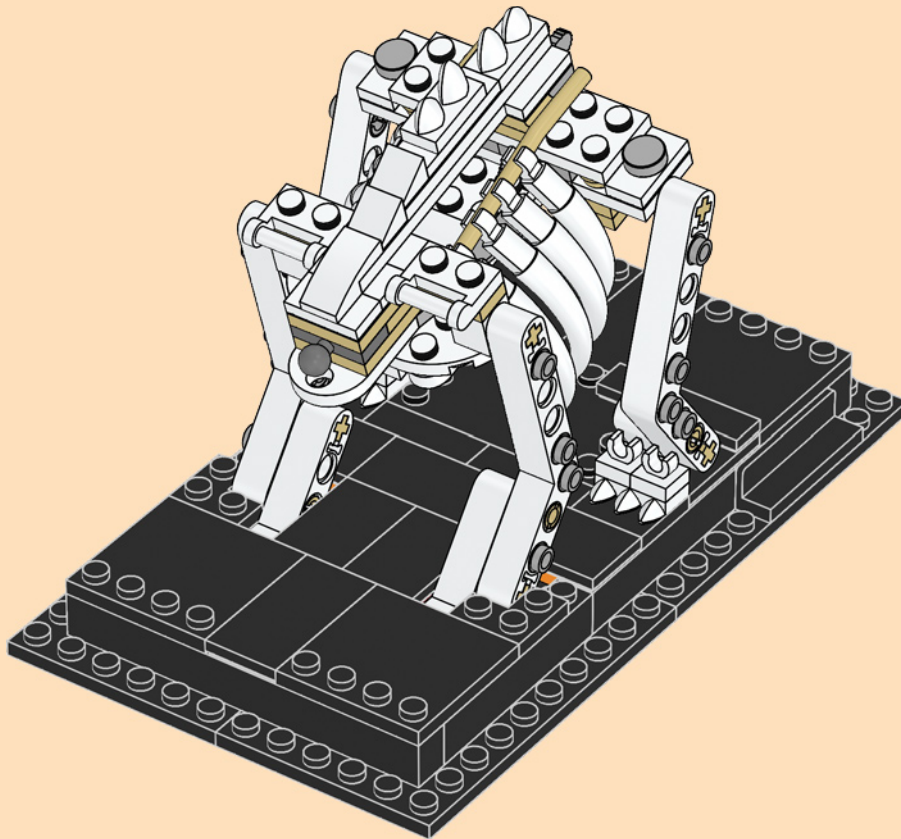

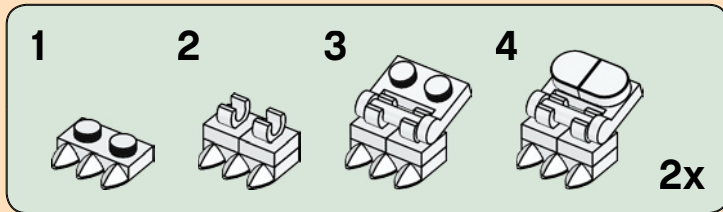

35

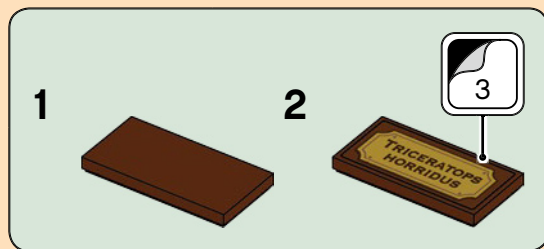
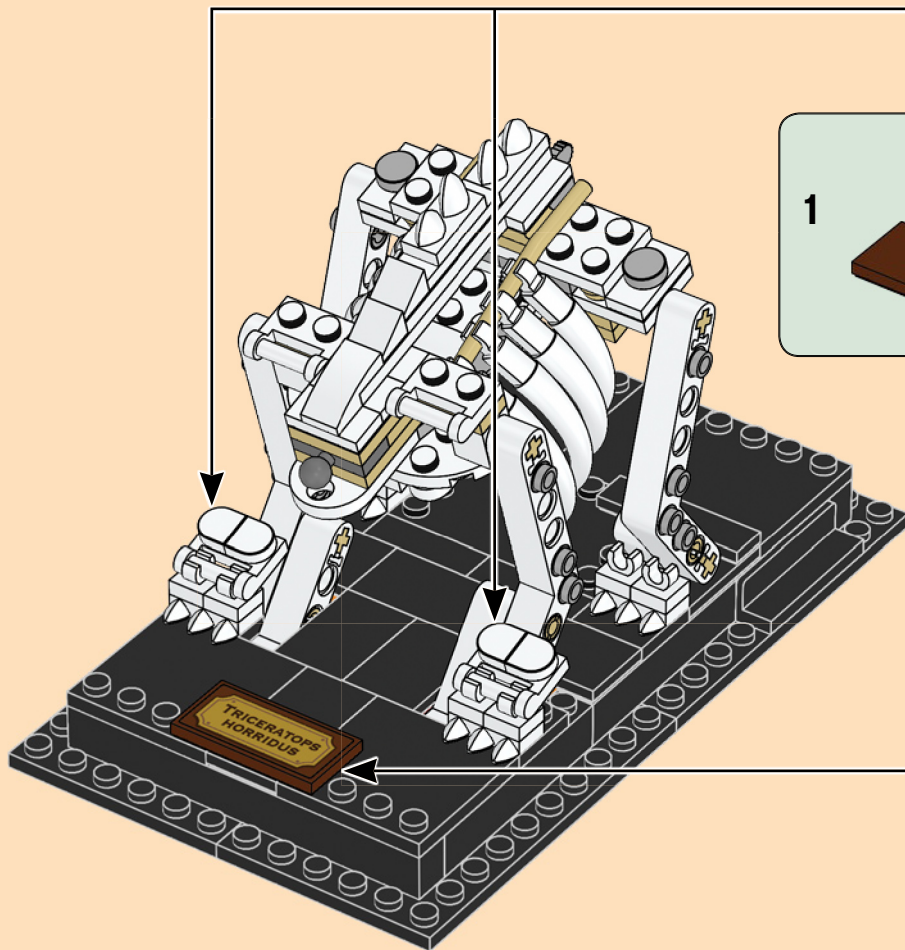

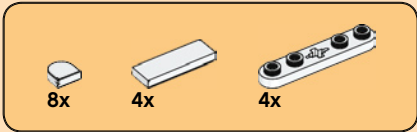
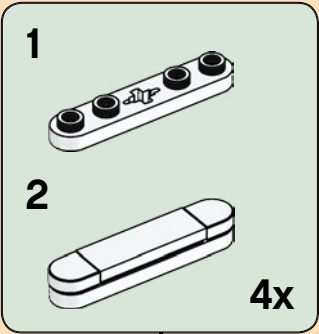
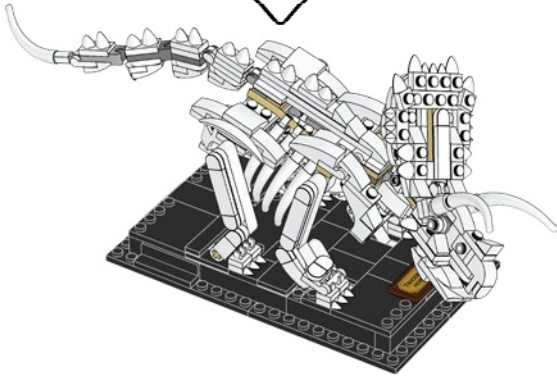
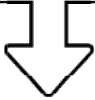

36

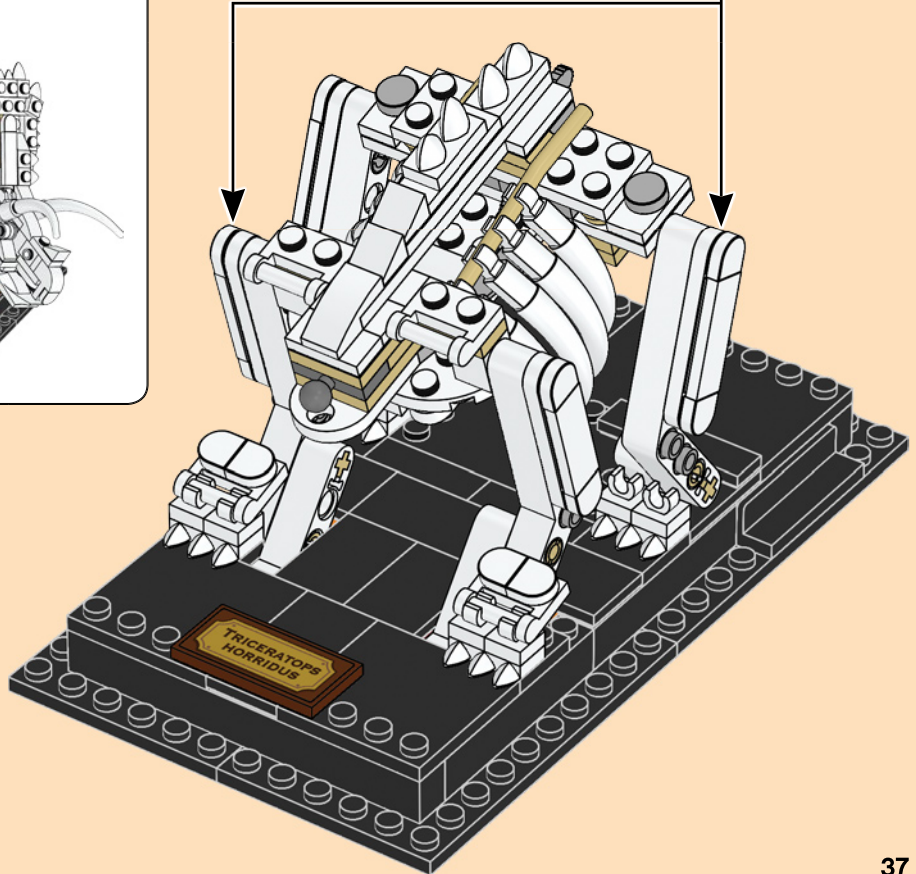



37

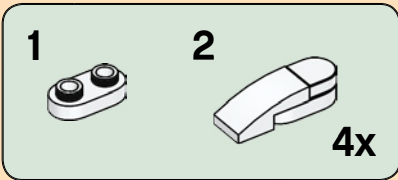
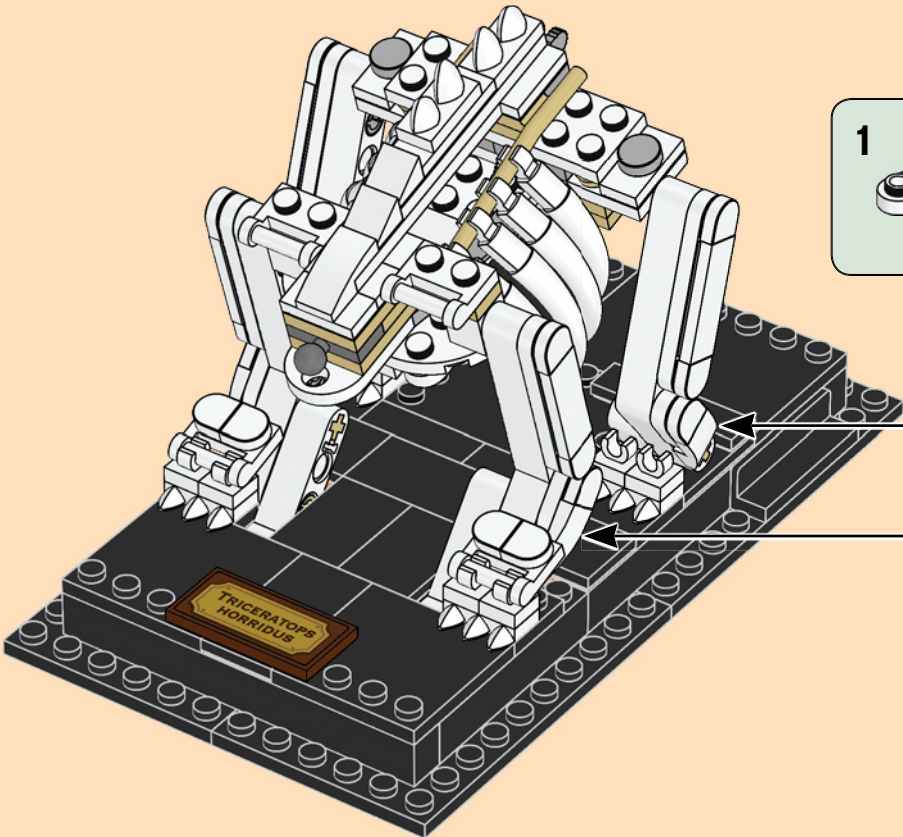

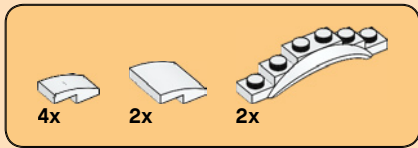

38

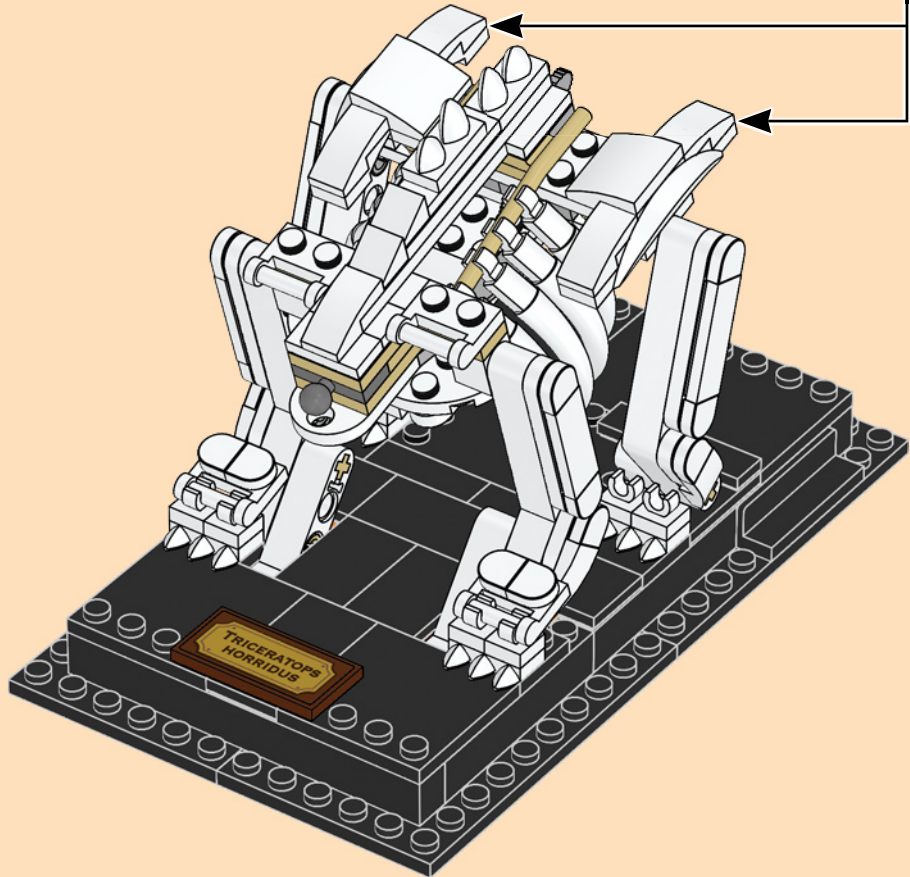
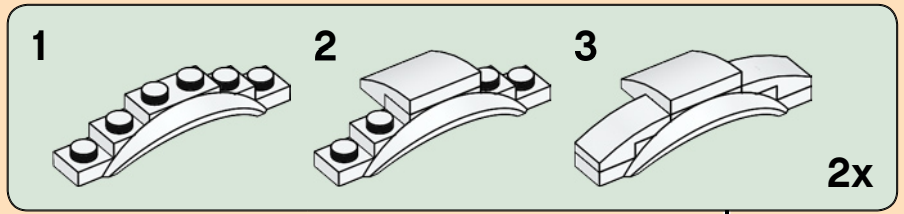

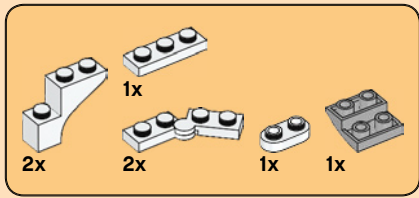

39

1

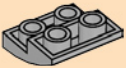

2

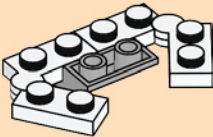

3

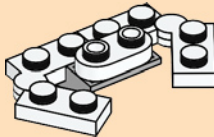

4

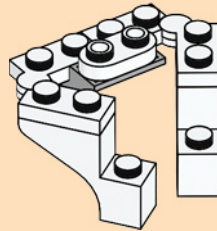

5

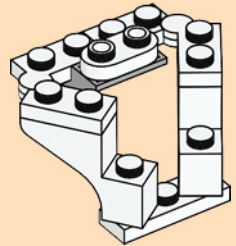

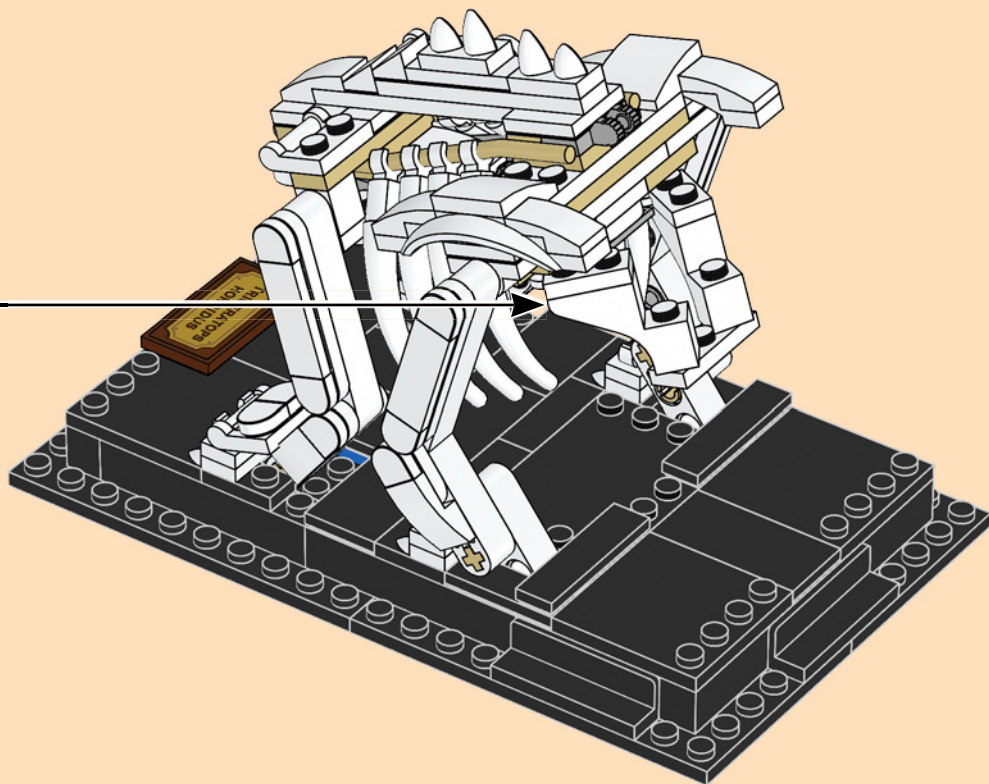



2x

40

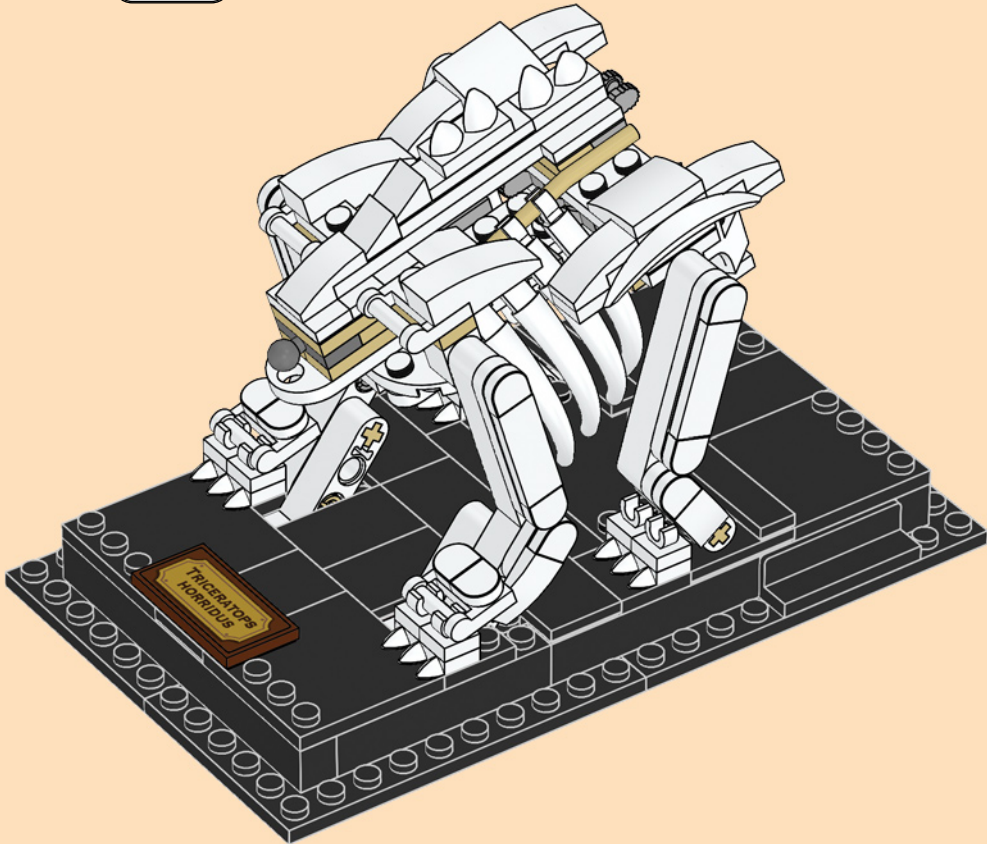

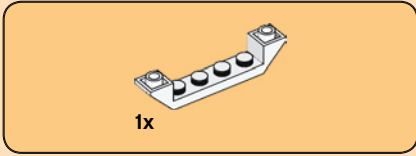
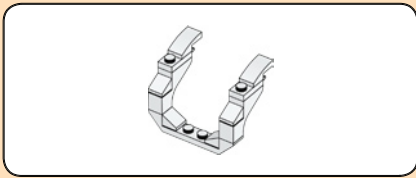

1x

41

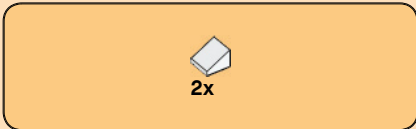
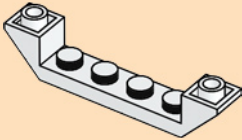

2x

42

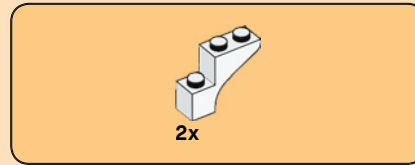
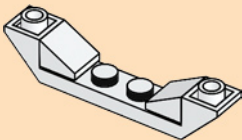

2x

43

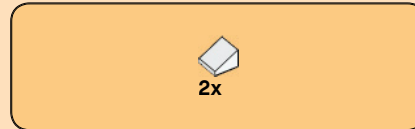
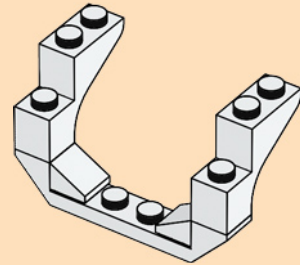

2x

44

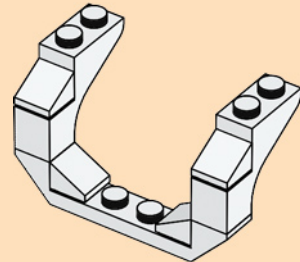



2x

45

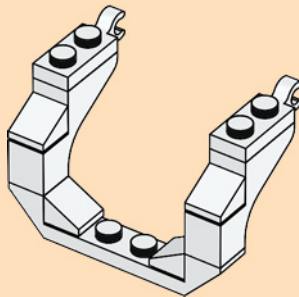
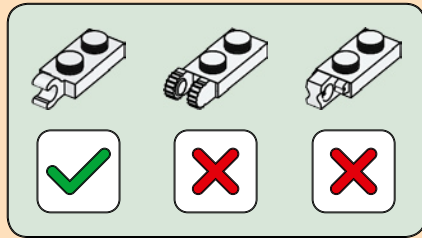

2x

46

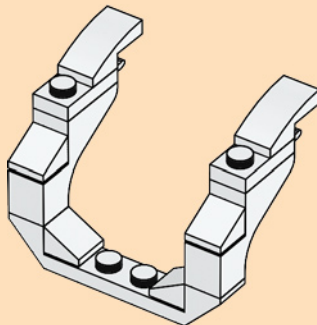

47

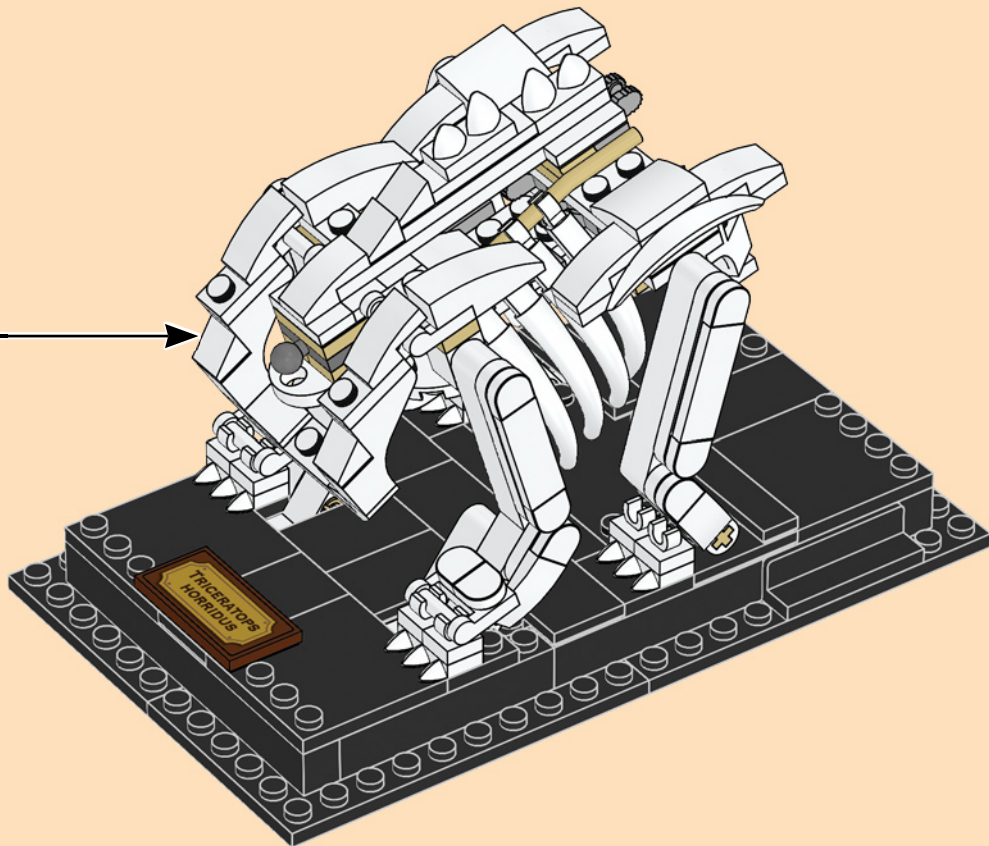

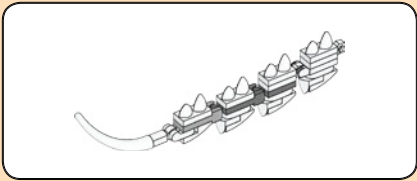

48

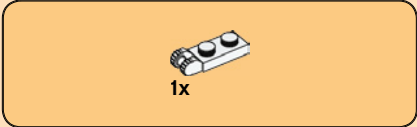

49

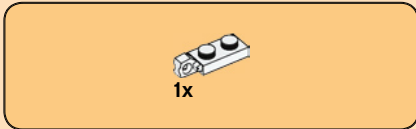
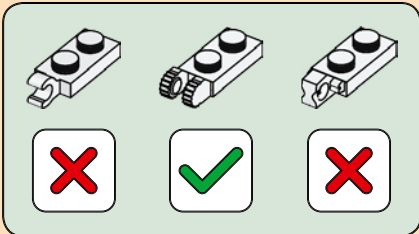

50

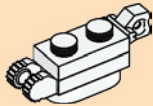
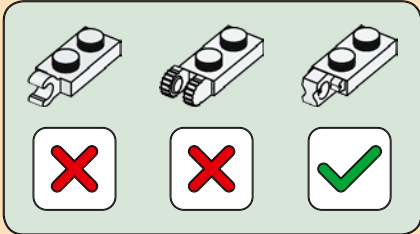

51

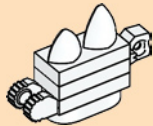

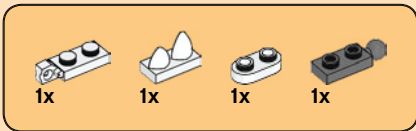

52

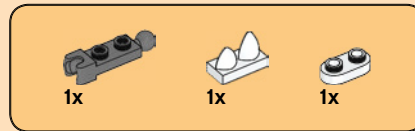
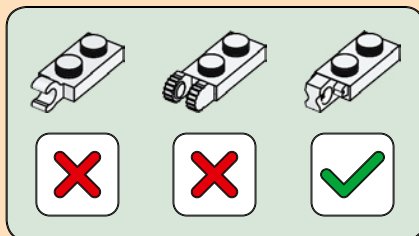
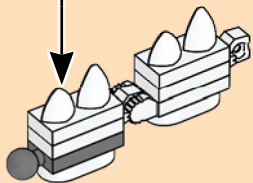
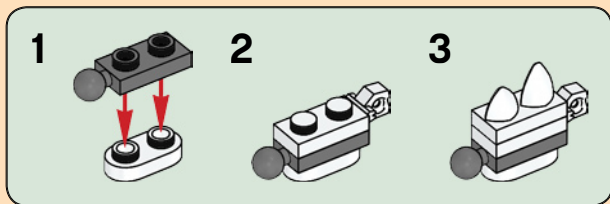

53

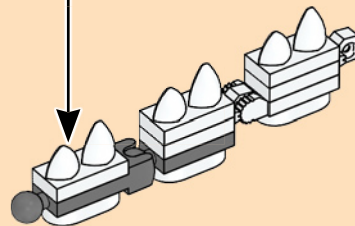
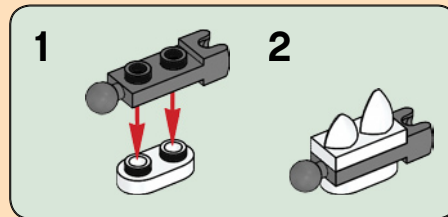

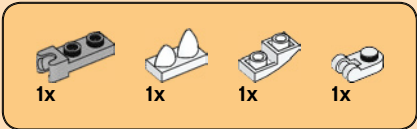

54

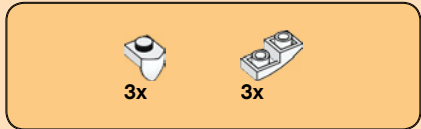
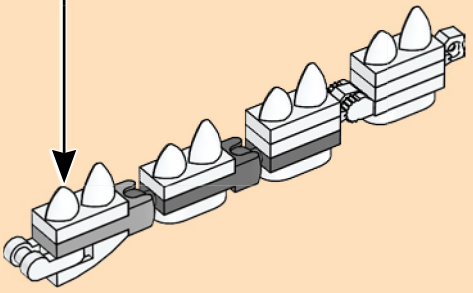
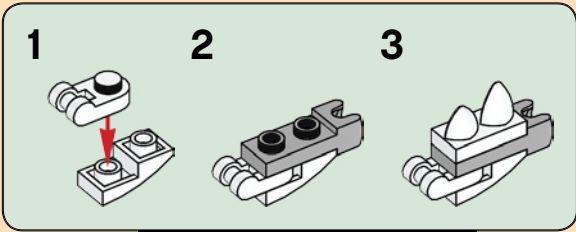

55

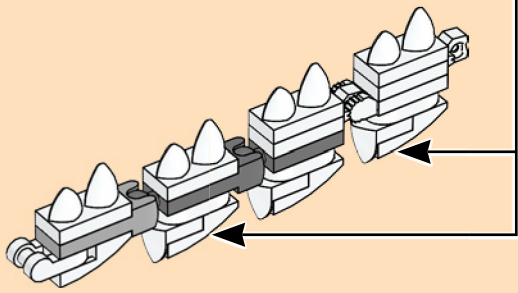
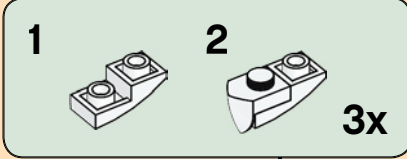



1x



1x

56

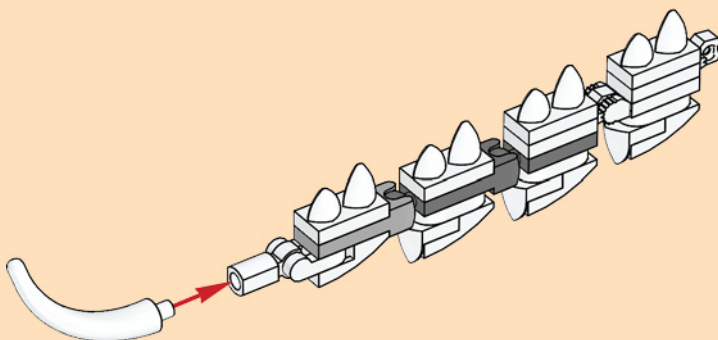

57

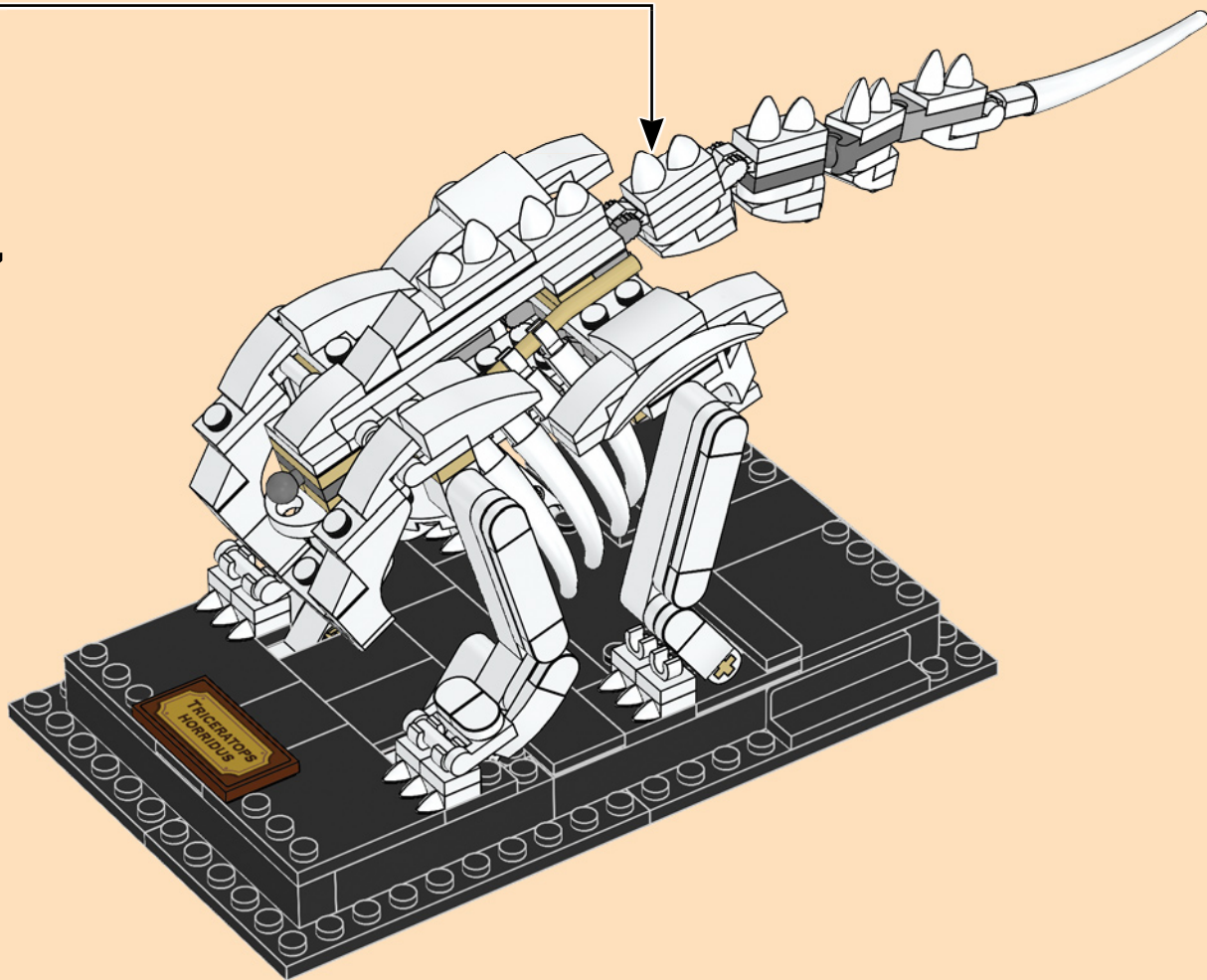

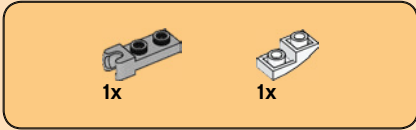
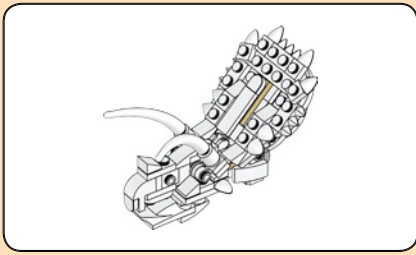

58

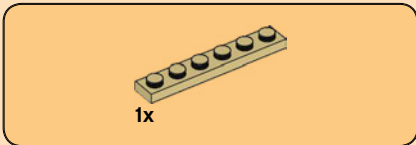
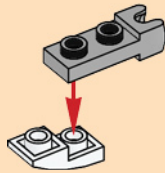

59

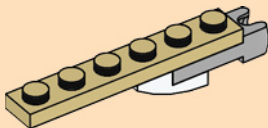

60

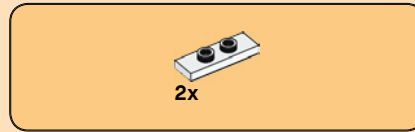
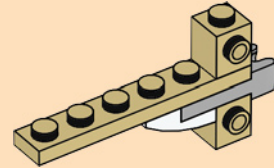

61

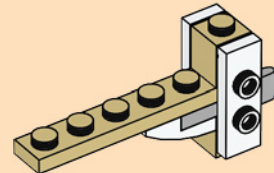



2x

62

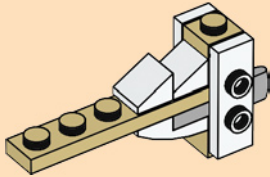

2x

63

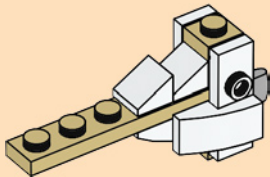

2x



2x



4x



1x

64

1



2

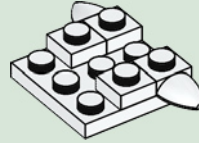

3

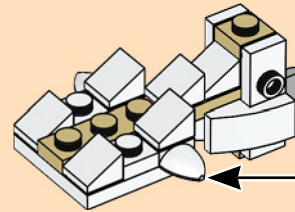
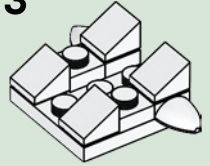



65

1

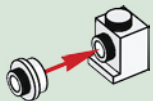

2

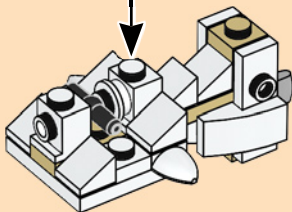

66

1



2

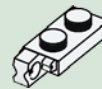
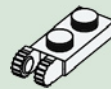
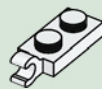
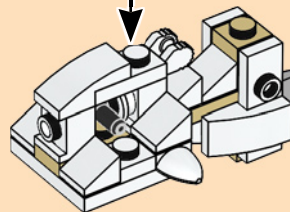
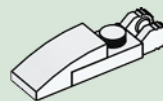

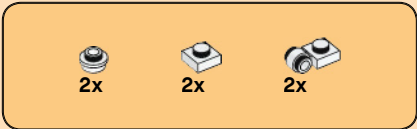

67

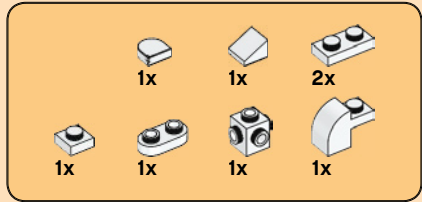
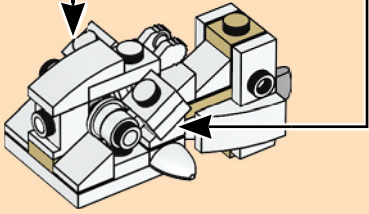
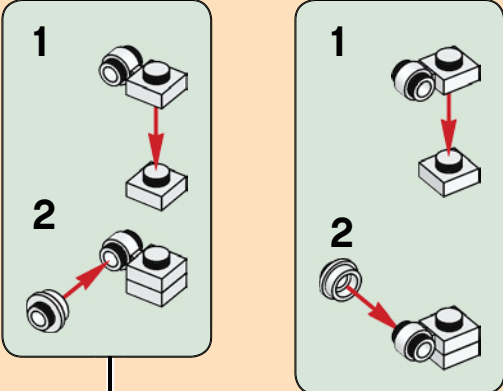

68

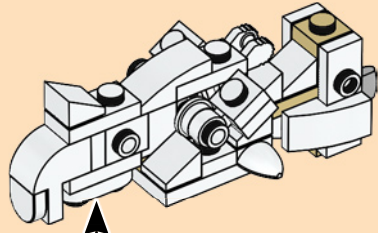
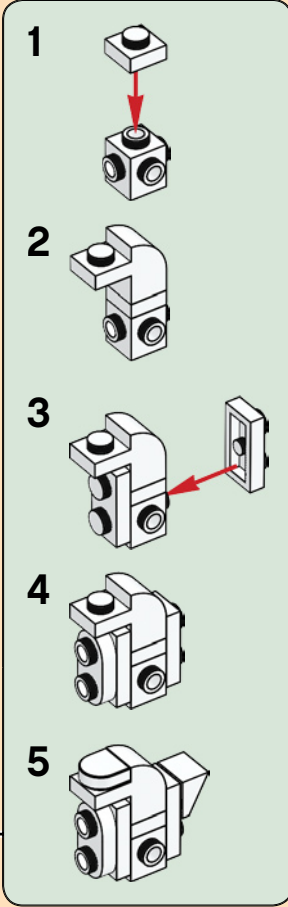

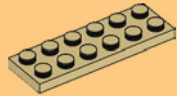

1x

69

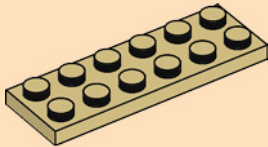

3x



1x

70

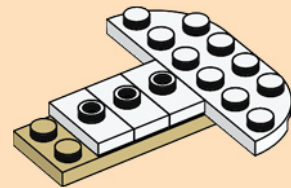



2x

71

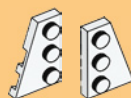
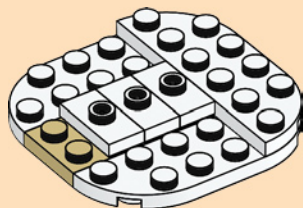

1x

1x

1x

2x

2x

72

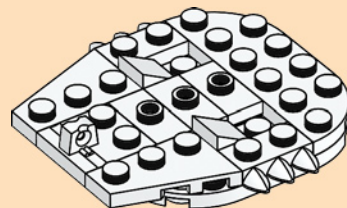

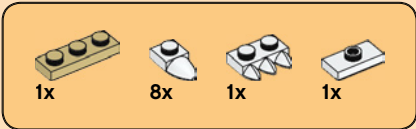

73

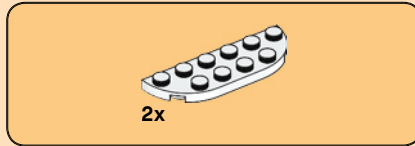
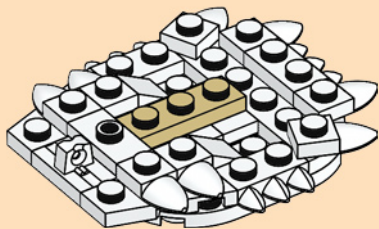

74

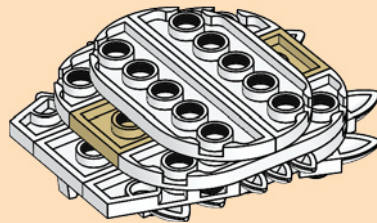
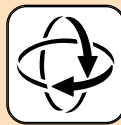

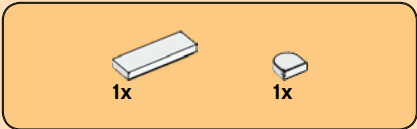

75

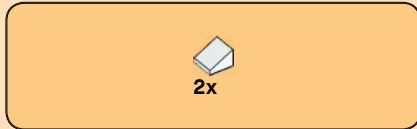
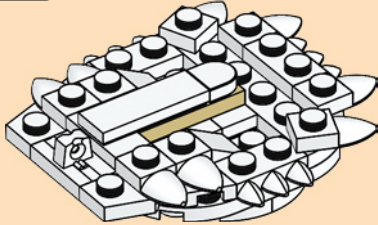

76

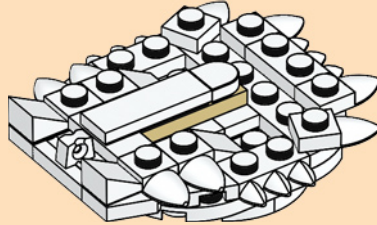

77

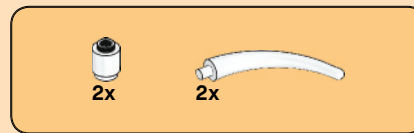
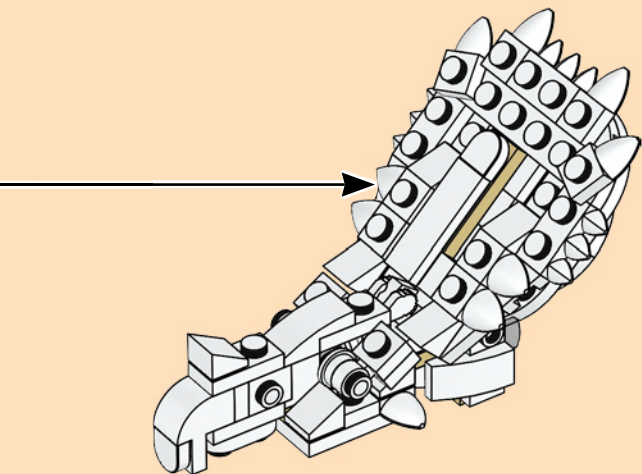

78

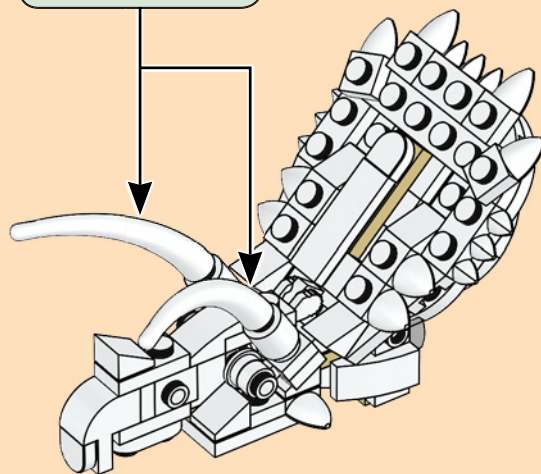
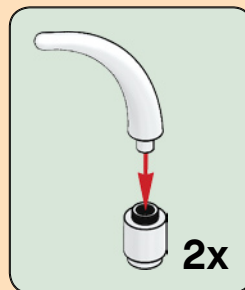

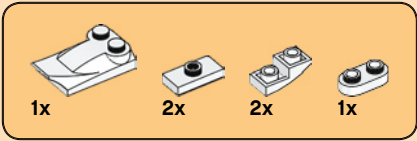

79

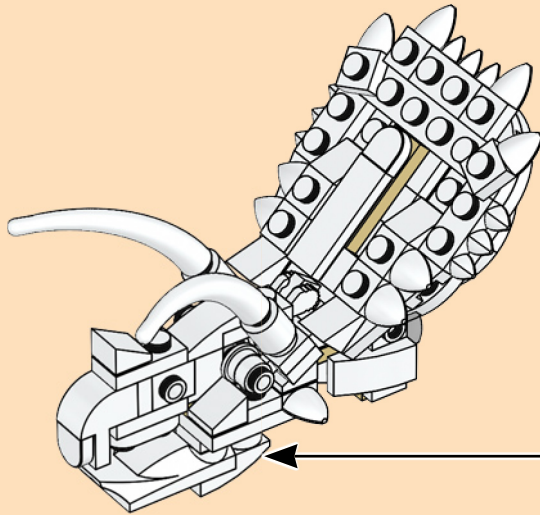
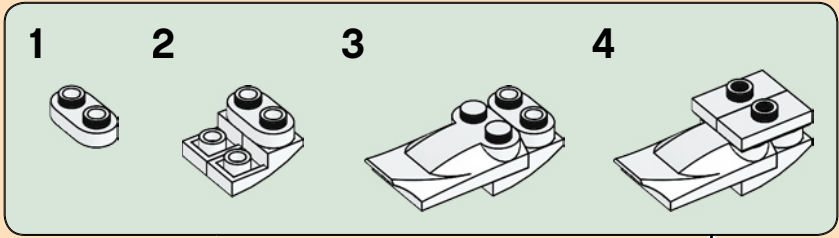

80

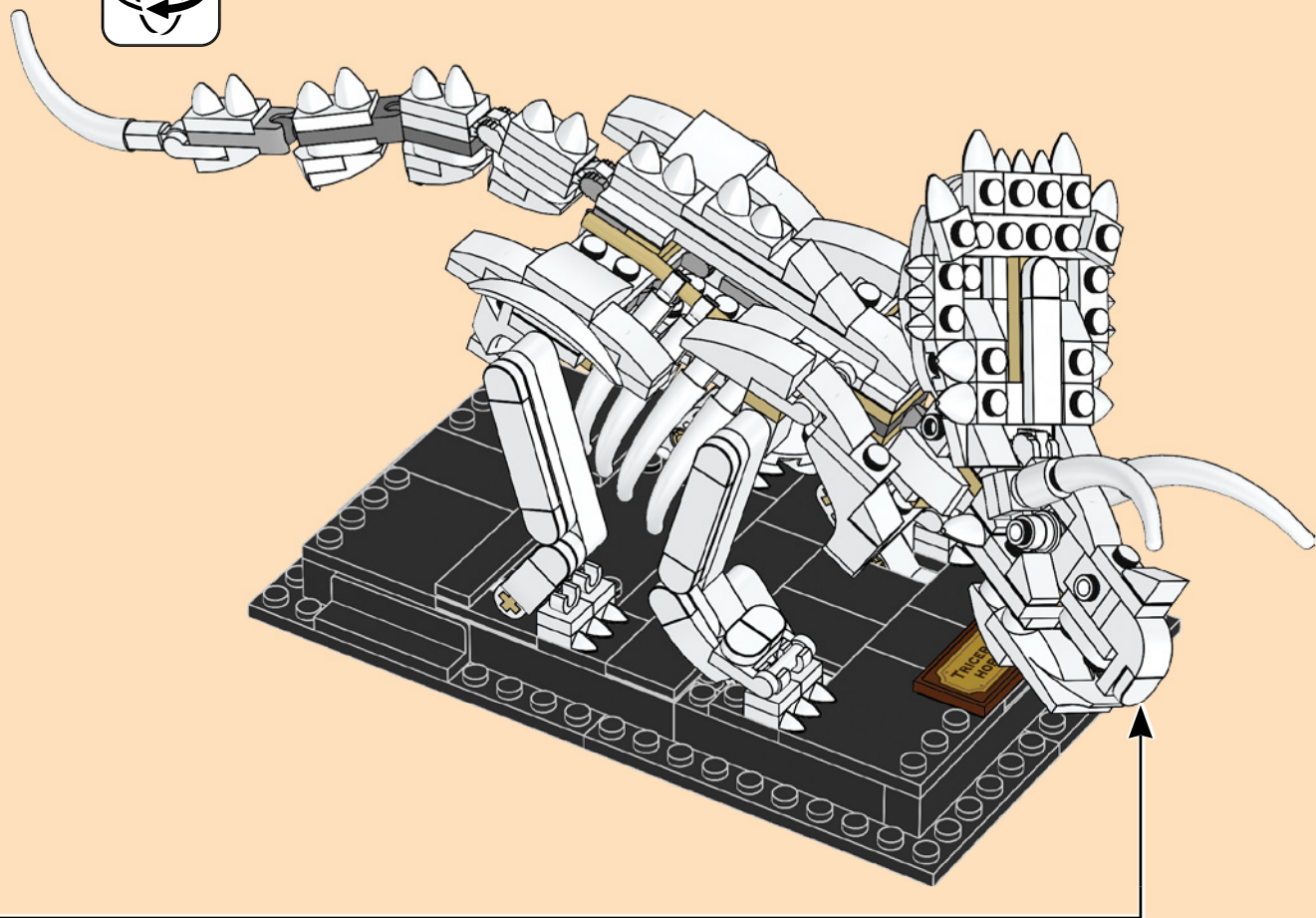



IDEAS

SHARE YOUR IDEA
TEILE DEINE IDEE
PARTAGE TON IDÉE
CONDIVIDI LA TUA IDEA
COMPARTE TU IDEA
PARTILHA A TUA IDEIA
TEDD KÖZZÉ AZ ÖTLETED
DALIES AR SAVU IDEJU
分享您的观点



GATHER SUPPORT
HOL DIR UNTERSTÜTZUNG
RASSEMBLE DES VOTES
CHIEDI DI ESSERE SUPPORTATO
GANA APOYOS
OBTÉM APOIO
SZEREZZ TÁMOGATÁST
IEGŪSTI ATBALSTU
获得更多支持

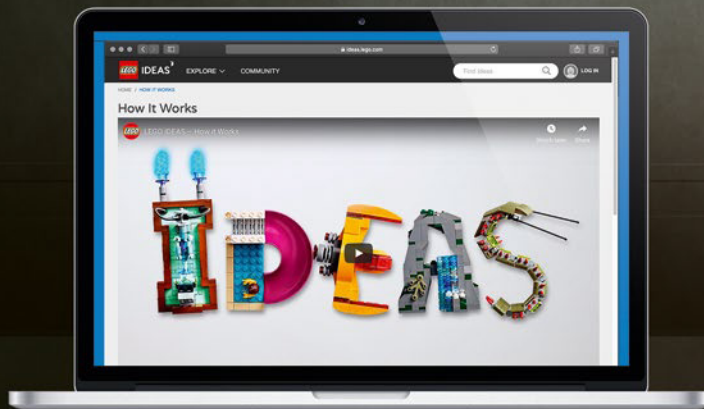

LEGO® REVIEW
LEGO® PRÜFUNG
EXAMEN PAR LEGO®
REVIEW LEGO®
REVISIÓN DE LEGO®
AVALIAÇÃO LEGO®
LEGO® VÉLEMÉNYEZÉS
LEGO® RECENZIJA
乐高®评论

NEW LEGO® PRODUCT
NEUES LEGO® PRODUKT
NOUVEAU PRODUIT LEGO®
NUOVO PRODOTTO LEGO®
NUEVO PRODUCTO LEGO®
NOVO PRODUTO LEGO®
ÚJ LEGO® TERMÉK
JAUNS LEGO® PRODUKTS
新的乐高®产品



THE FLINTSTONES and all related characters
and elements © & ™ Hanna-Barbera. (s19)
©Disney

[LEGO.com/ideas](https://www.lego.com/ideas)



IDEAS

Do you like this LEGO® Ideas set?

The LEGO Group would like your opinion on the new product you have just purchased. Your feedback will help shape the future development of this product series.

Please visit:

[LEGO.com/productfeedback](https://www.lego.com/productfeedback)

By completing our short feedback survey, you will be automatically entered into a drawing to win a LEGO® prize.

Terms & Conditions apply.

