







Architecture

Seattle Space Needle

Seattle, Washington, USA

 Building instructions are available on:  Die Bauanleitung finden Sie auf:

 Vous pourrez trouver des instructions de montage sur :  Encontrarás las instrucciones de construcción en:

 Encontrar instruções de construção em:  Az építési útmutatót a következő helyen találod meg: [Architecture.LEGO.com](https://www.lego.com/en-us/lego-architecture)



Architecture, Engineering and Construction

Viewed as the predominate symbol of Seattle's skyline, the Seattle Space Needle was originally built to be the centerpiece of the futuristic 1962 World's Fair. Originally sketched by Edward E. Carlson, the futuristic concept has given the Seattle Space Needle its sleek "frozen in time" flying saucer appearance.

The theme of the 1962 World's Fair was unmistakably about futurism and American optimism, and was appropriately named, "The Century 21 Exposition." The Needle was specifically designed to embrace the "Race into Space" or now more commonly referred to as the "Space Age." In keeping with the 21st Century theme, even the final coats of paint were dubbed Astronaut White for the supporting legs, Orbital Olive for the core, Re-entry Red for the halo and Galaxy Gold for the sunburst and pagoda roof. A separate unique elevated monorail transport was an added feature attraction to further enhance its futuristic alien spaceship counterpart, the Seattle Space Needle.

Due to the 12 month condensed construction schedule, the Seattle Space Needle's legs and observation pod were prefabricated in several sections and then quickly erected and secured in place. To offset the "top heavy" loading, the Space Needle's center of gravity was lowered all the way down to ground level by means of anchoring the three legs to an oversized solid concrete slab 30 feet thick, thus matching the entire weight of the exposed structure above.

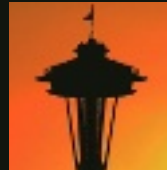

Facts at a Glance

Location: 400 Broad Street, Seattle, Washington, United States
Architect: John Graham & Associates
Classification: Observation Tower
Construction Type: Structural Steel Frame
Materials: Steel, Concrete and Glass
Year: 1961-1962
Height: 518 ft. (158 m.)
Footprint: 120 ft. x 120 ft. (36.6 m. x 36.6 m.)
Pinnacle Type: Lightning Rod 605 ft. (184 m.)
Stories: 60
Cost: \$4.5 million (1962)
Floor Area: N/A
Zoned: 60
Elevators: 3



Points of Interest

Built to withstand winds of up to 200 mph, the Seattle Space Needle clearly demonstrates the inherent strength of the unique tripod design. “SkyCity,” the rotating restaurant located 500 feet above the

ground, cleverly rotates 360 degrees every 47 minutes using only a one horsepower motor, which is accomplished thanks to skillful and precise craftsmanship.

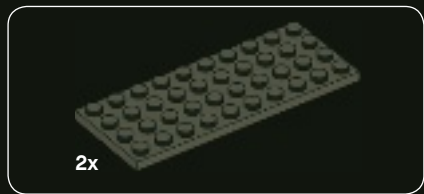

1

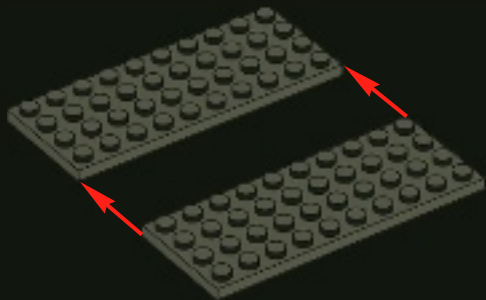

2

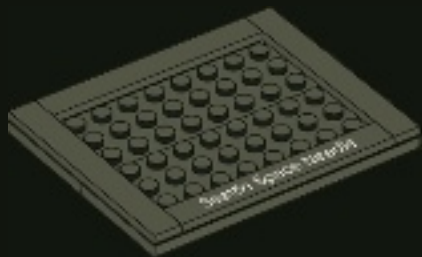



3

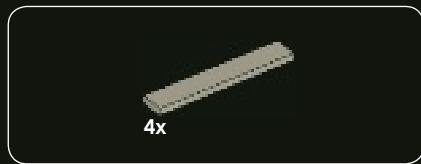

4

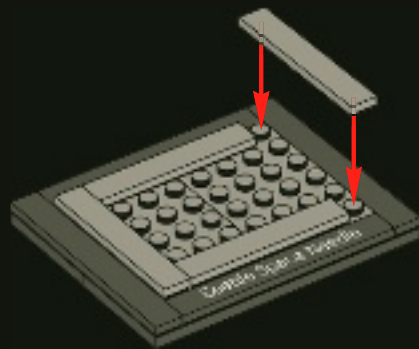



5

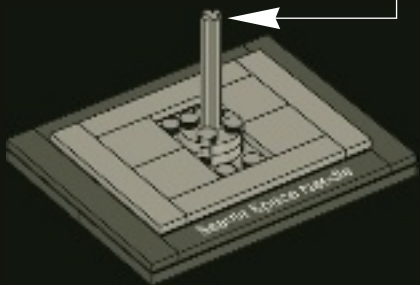

6

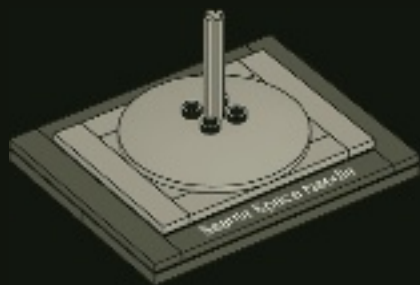



7

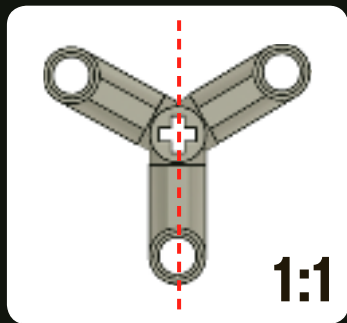
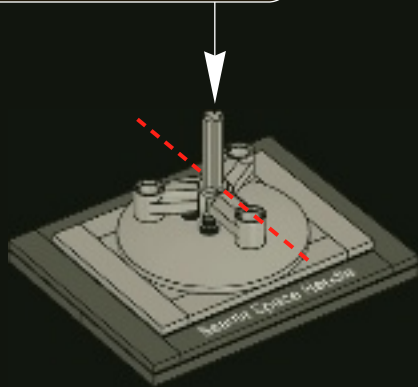
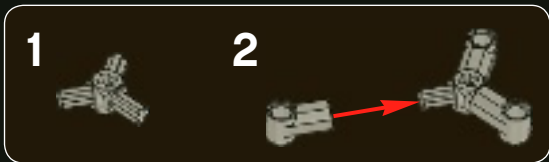

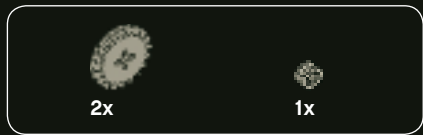

8

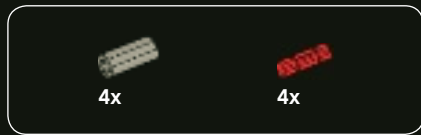
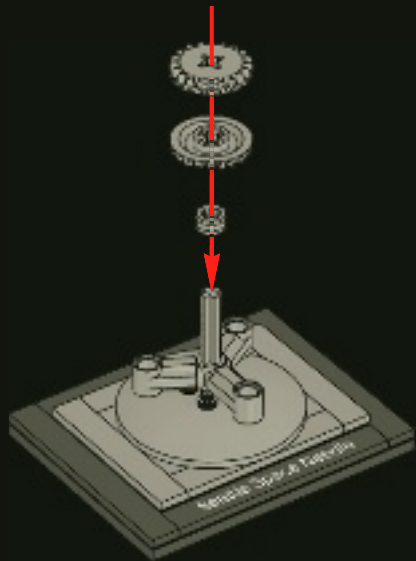

9

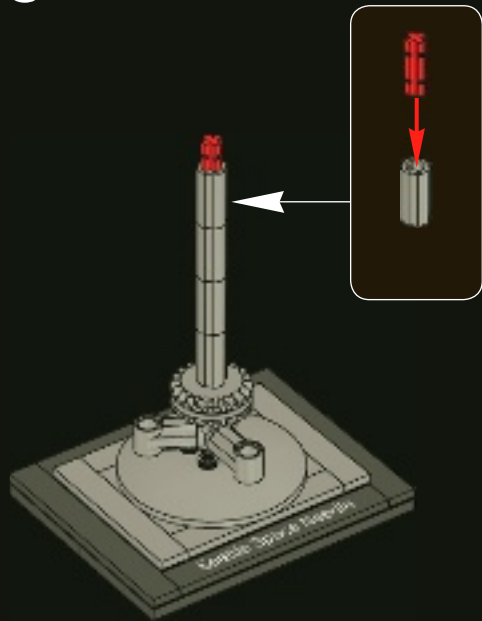

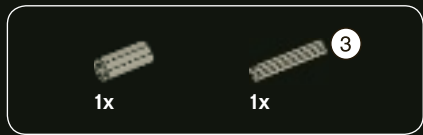

10

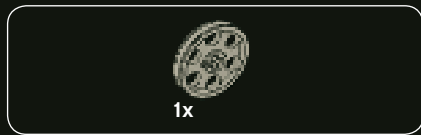
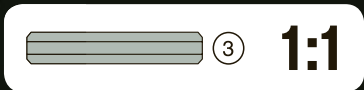
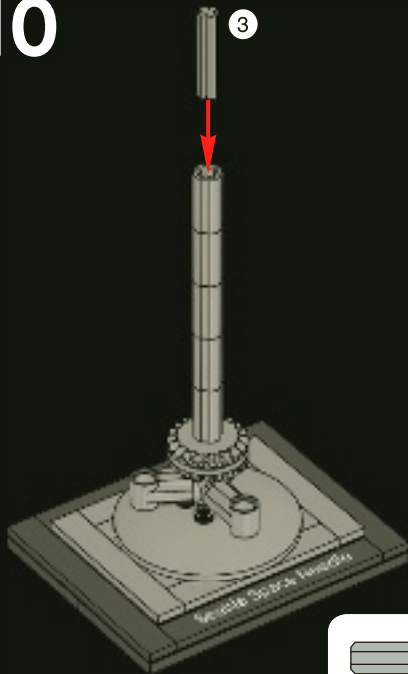

11

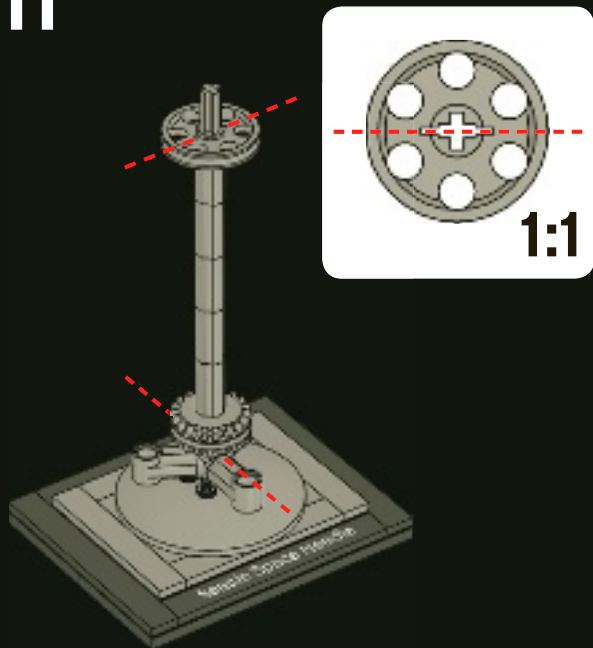

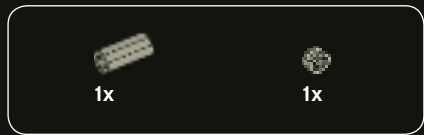

12

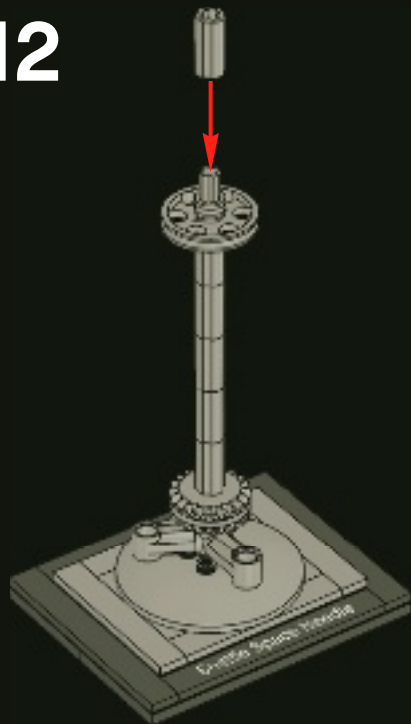

13

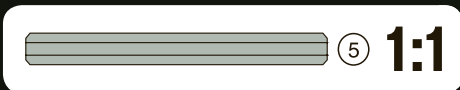
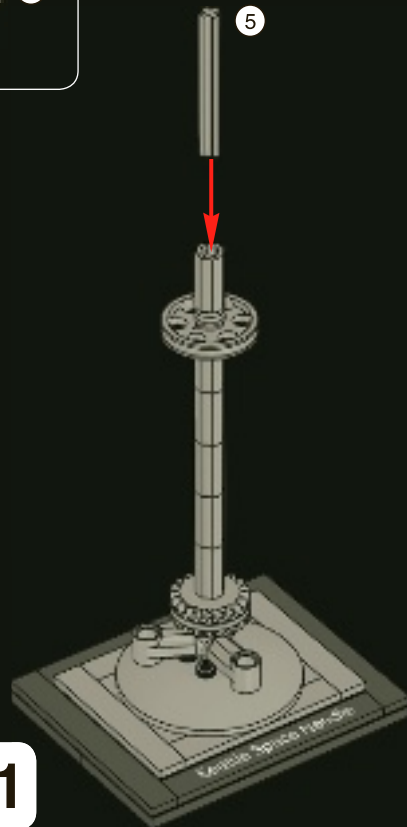



14

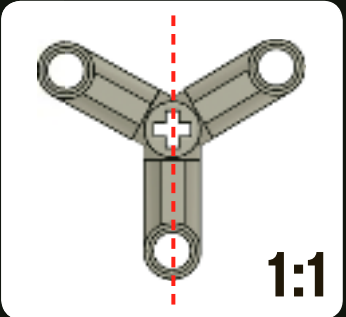
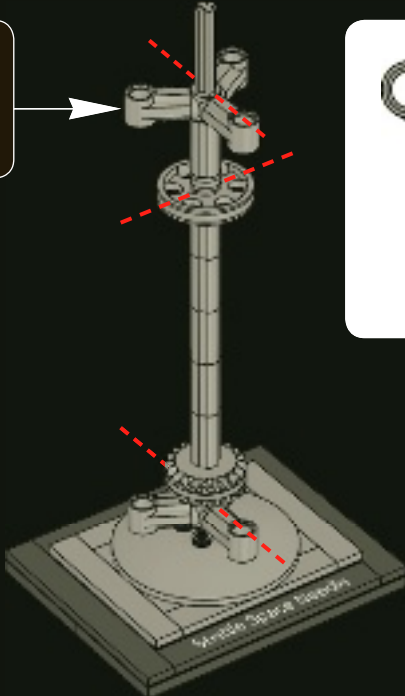

15

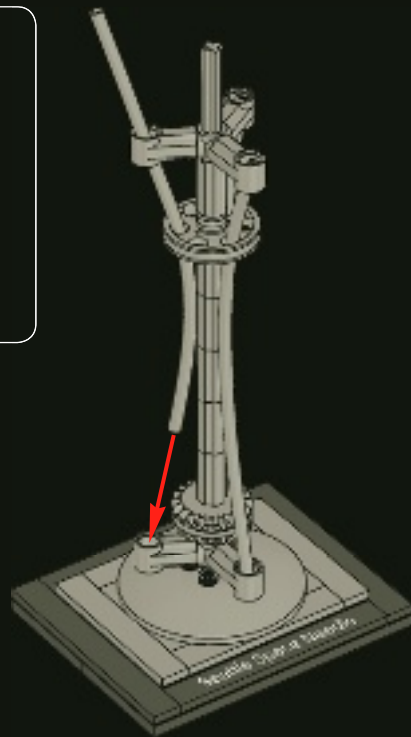

5.25 in / 133 mm

1:1

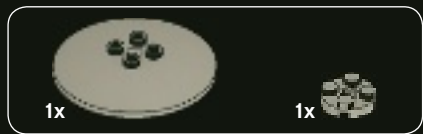

16

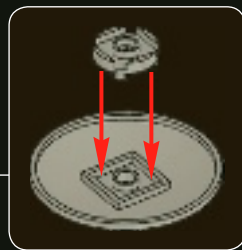
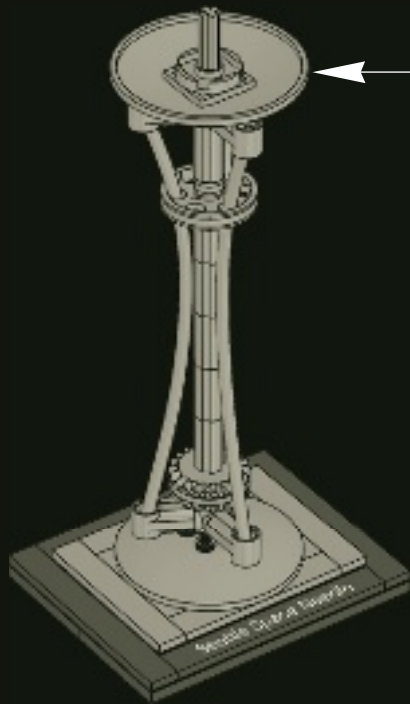

1x



17

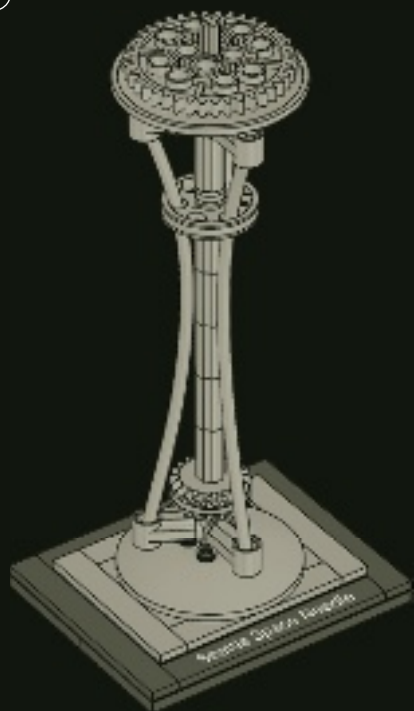

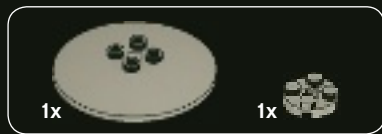

18

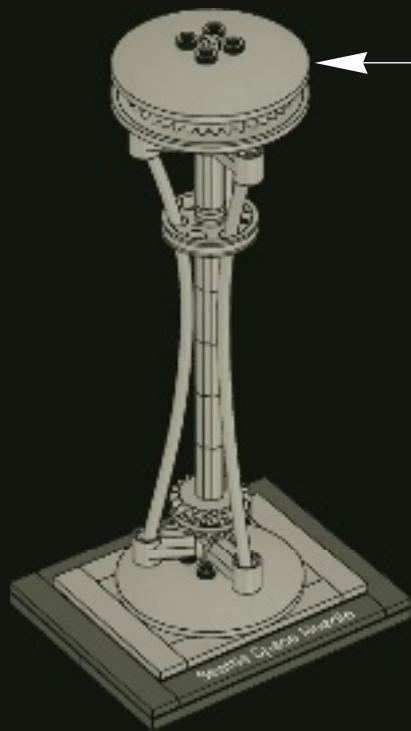

19

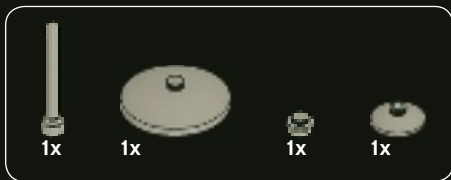



2x
4211639



6x
4512360



4x
4211549



4x
4211413



1x
4285634



3x
4211796



1x
4211512



4x
4211475



2x
4211573



2x
4502595



6x
4211550



2x
4211885



1x
4211815



1x
4494222



1x
4211664



1x
4211525



2x
4211404



1x
4211473

3x
4514198

4x
4142865



4x
416226



2x
303026

Customer Service
Kundenservice
Service Consommateurs
Servicio Al Consumidor
www.lego.com/service or dial

00800 5346 5555 : 
1-800-422-5346 : 

A Word from the Artist

As an Architectural Artist my desire is to capture the essence of a particular landmark into its pure sculptural form, especially at this small scale. I first and foremost do not view my models as literal replicas, but rather my own artistic interpretations, harnessing the essence of these landmark's through the use of LEGO® bricks as a medium. The LEGO brick is not initially thought of as a material typically used in creating art or used as an artist's medium. I quickly discovered the LEGO brick was lending itself as naturally to my applications as paint to a painter or metal to a blacksmith. As I explore how to capture these buildings with the basic shapes of the bricks, I find the possibilities and challenges they offer almost magical.



– Adam Reed Tucker



LEGO® Architecture, bringing two worlds together

The LEGO Group and Adam Reed Tucker are excited to bring you this new line of distinctive landmark building sets. Our hope is that this will inspire minds of all ages whether you're young and eager to learn or young at heart and simply intrigued by these modern day marvels. The idea behind LEGO® Architecture is to celebrate the past, present and future of architecture through the LEGO Brick. Through products and events we wish to promote an awareness of the fascinating worlds of Architecture, Engineering and Construction. Initially, we featured a pair of Chicago's most famous landmarks: The Sears Tower and The John Hancock Center. We now proudly offer you landmarks that represent both the East & West coasts, The Empire State Building and The Seattle Space Needle. Eventually, we wish to offer other famous landmarks throughout the world celebrating influential architects and movements that have shaped the environment around us. We hope to inspire future architects around the world with the brick as a medium. We hope you enjoyed this experience.

– The LEGO Group and Brickstructures, Inc.

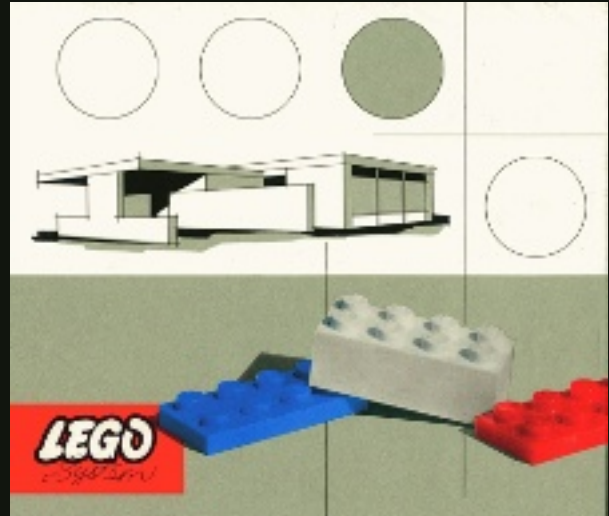

Visit www.LEGO.com/architecture or
www.Brickstructures.com for more information



Architecture

The landmark series

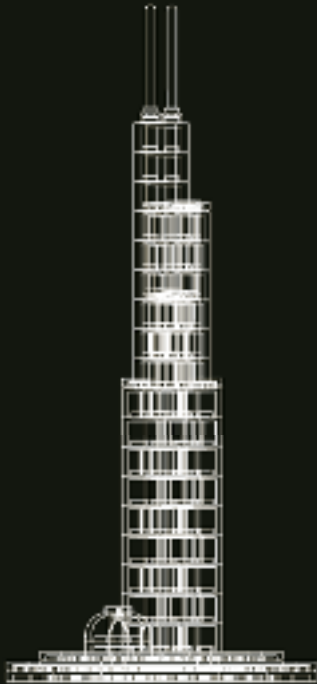

Willis Tower



Space Needle

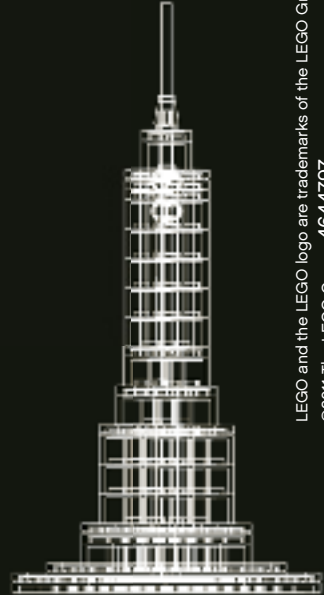

Empire State Building

LEGO and the LEGO logo are trademarks of the LEGO Group.
©2011 The LEGO Group. 4644797

