

77

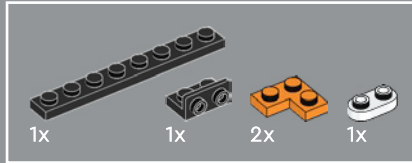

78

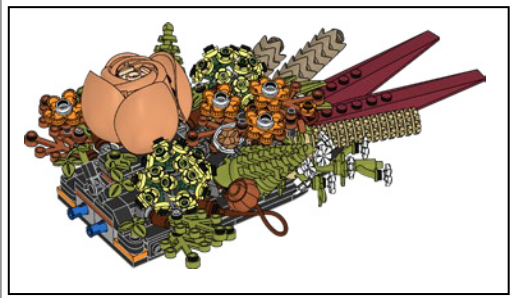

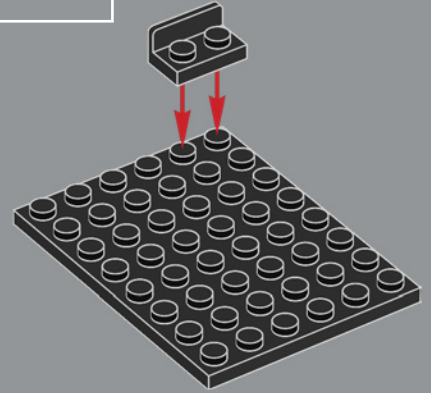
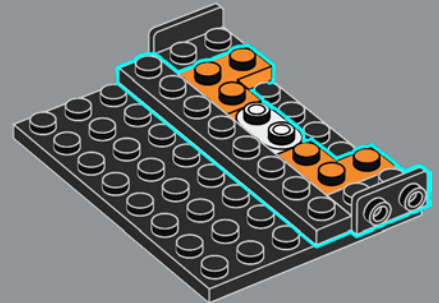
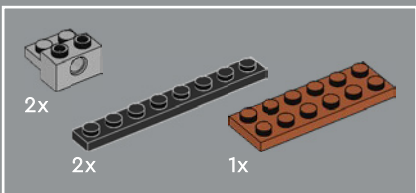

79

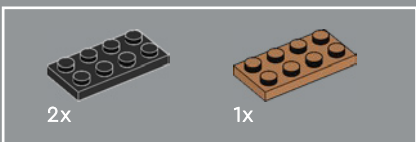
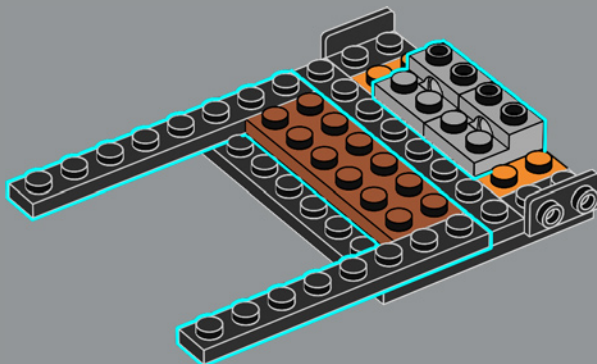

80

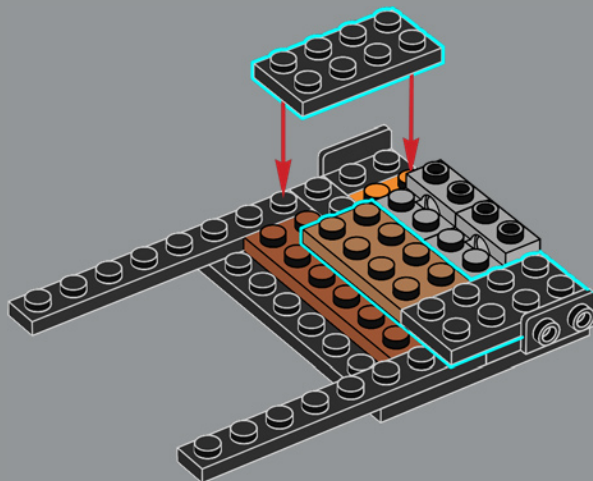

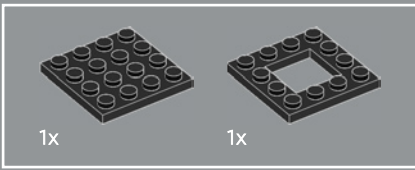

81

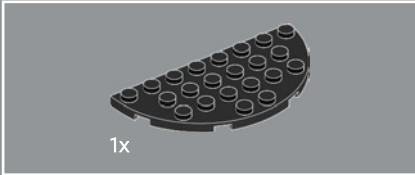
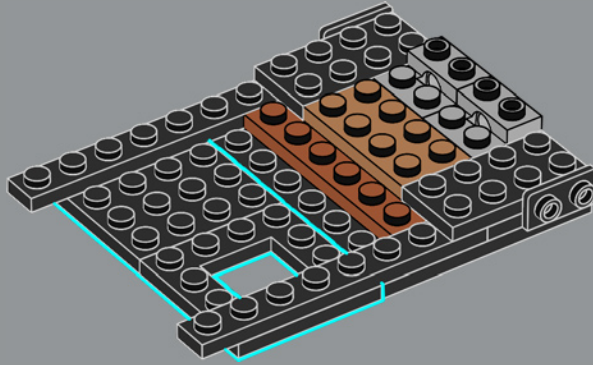

82

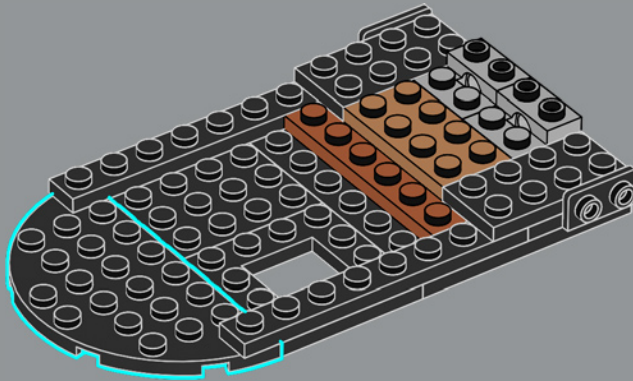

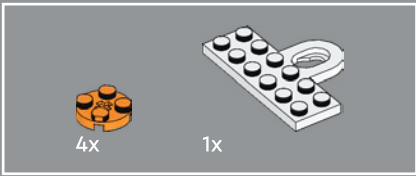

83

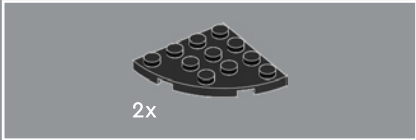
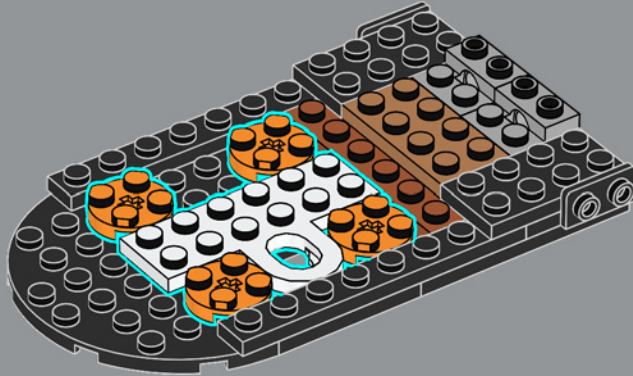

84

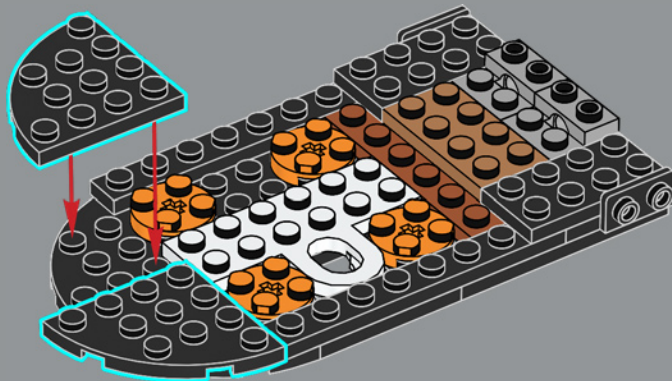

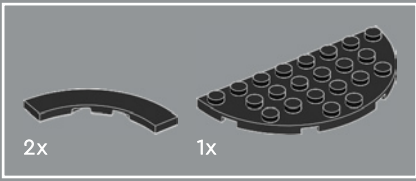

87

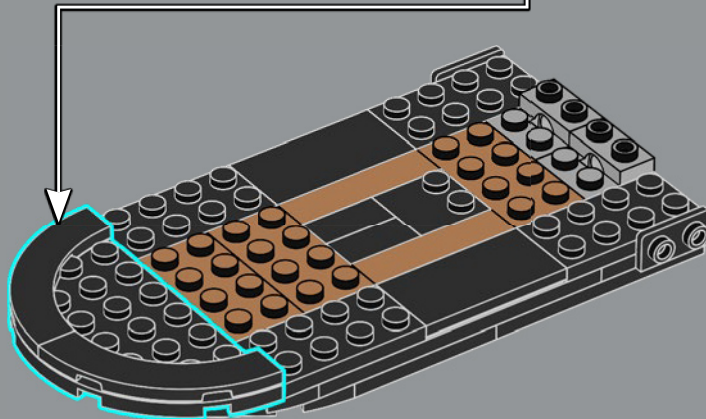
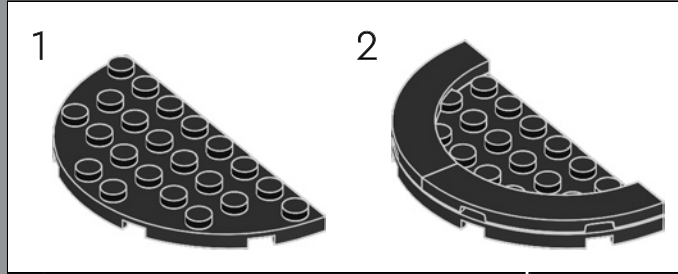

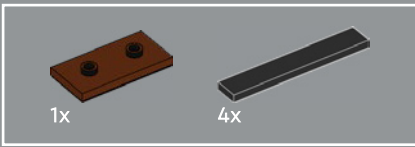

88

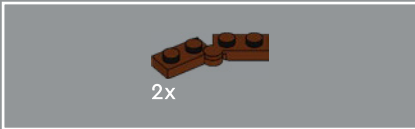
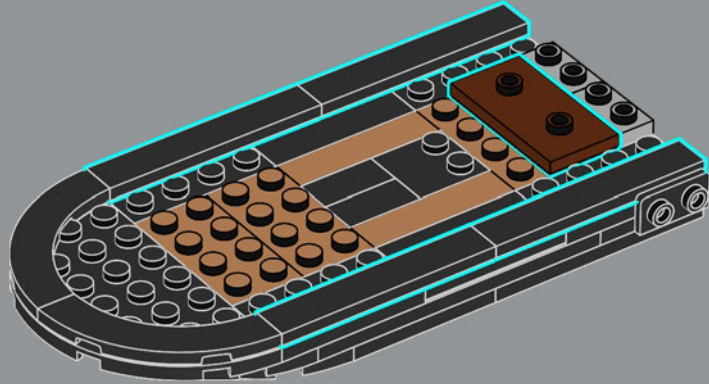

89

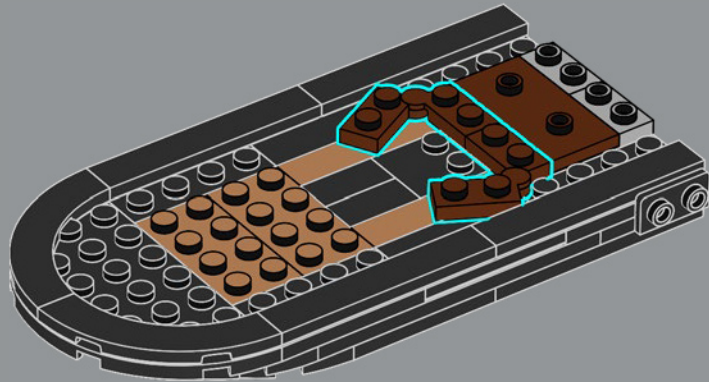

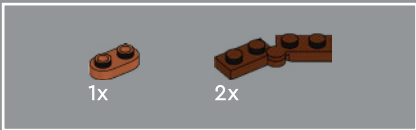

90

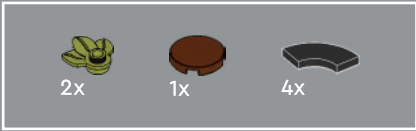
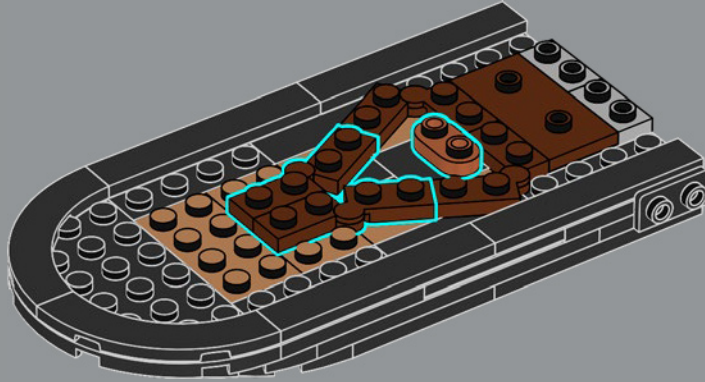

91



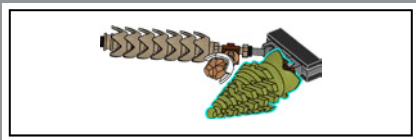

92

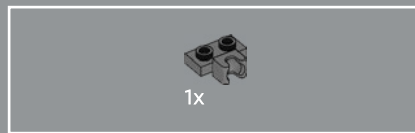
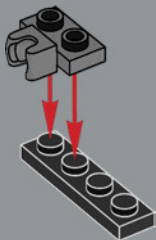

93

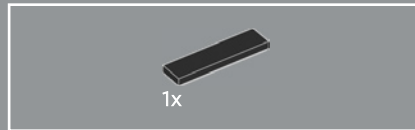
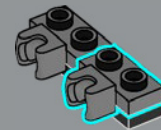

94

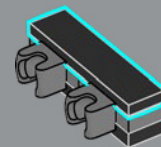



95

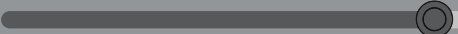
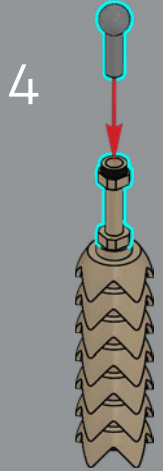
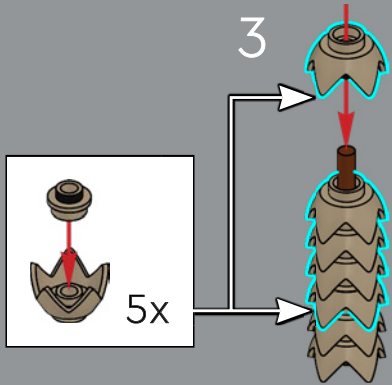
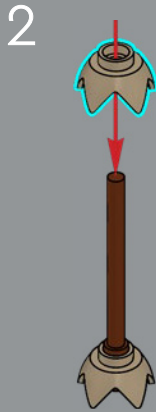
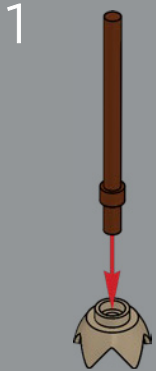



5

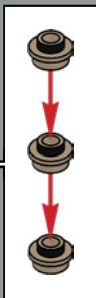

1x



1x



1x



1x

96

1



2



3

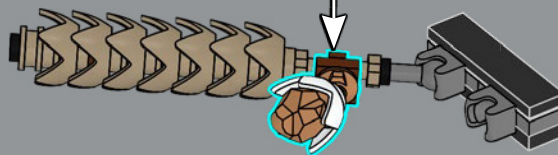

Gli steli di grano utilizzano elementi corona annidati per conferire al grano il suo aspetto ondulato.

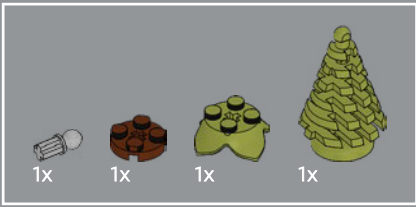

97

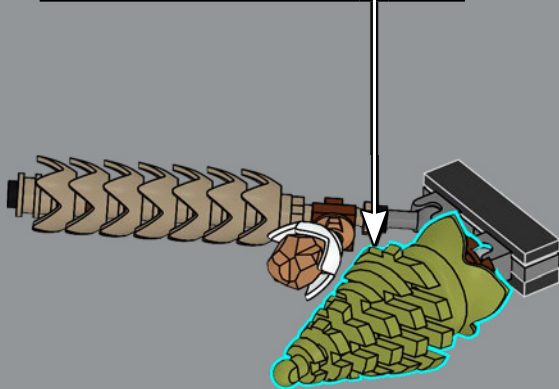
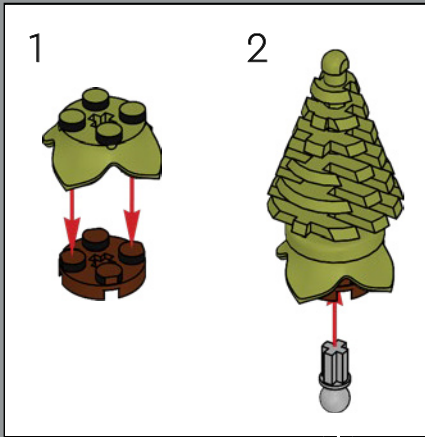

98

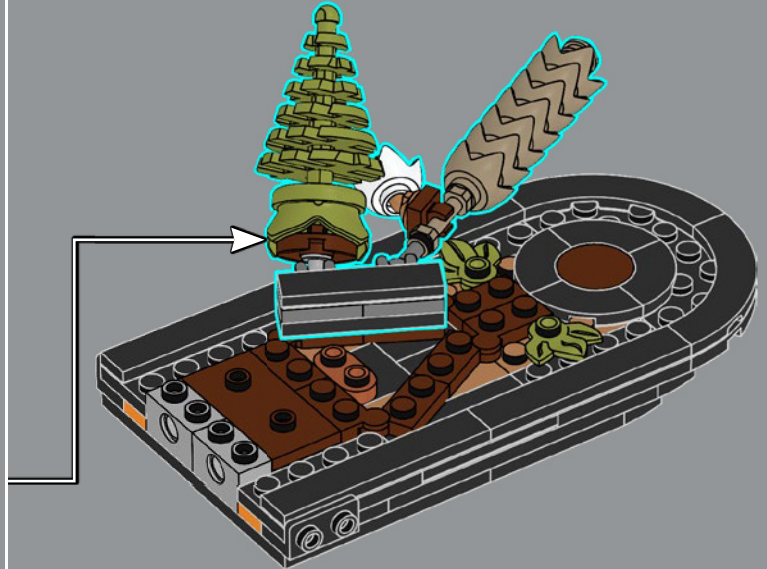

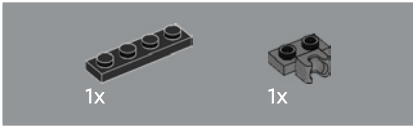
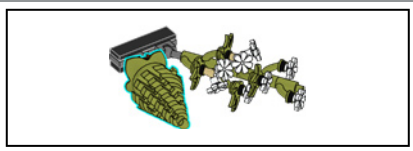

99

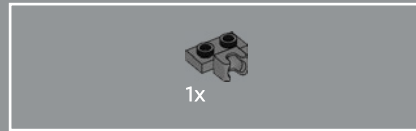
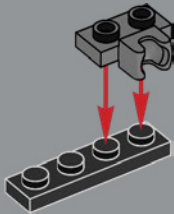

100

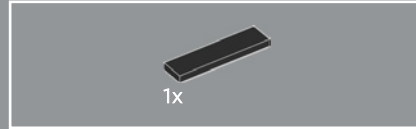
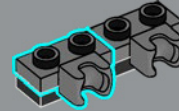

101

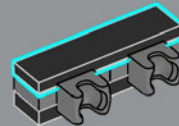

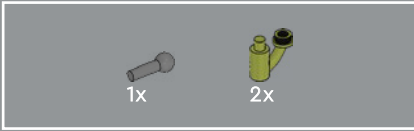
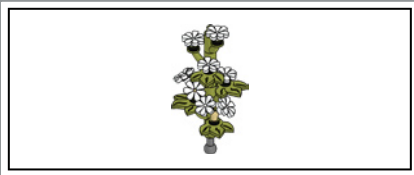

102



103

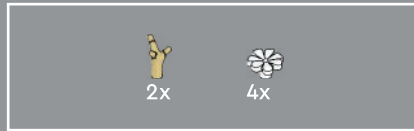
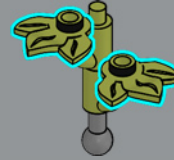

104

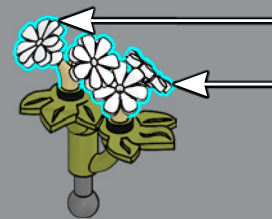
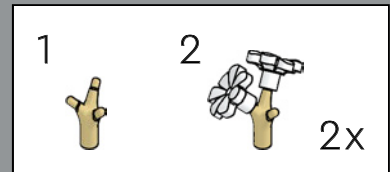



105

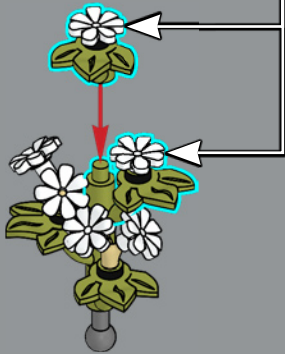
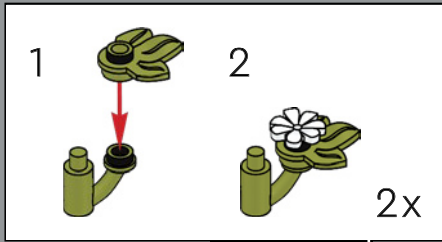

106

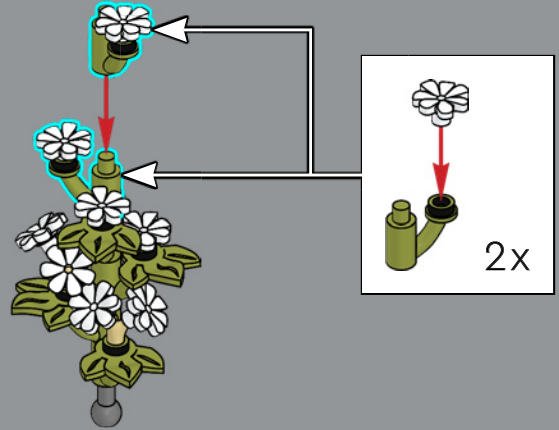

107

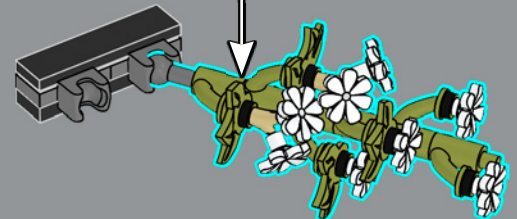

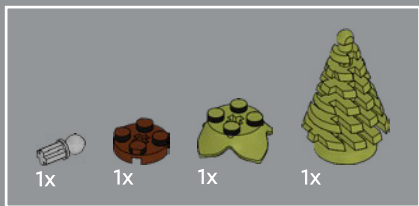

108

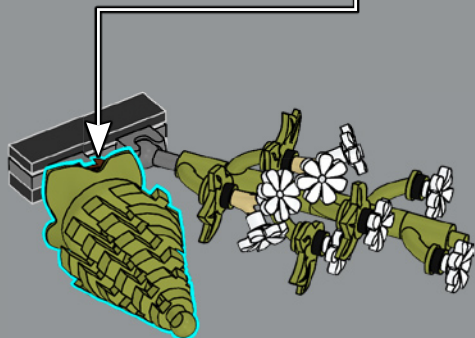
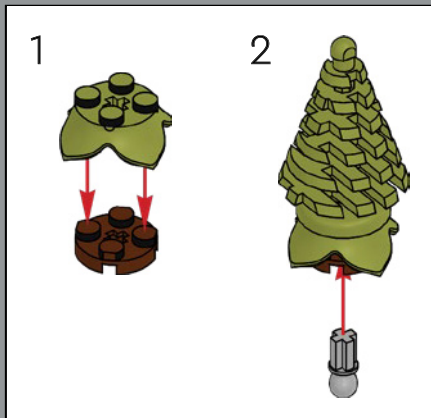

109

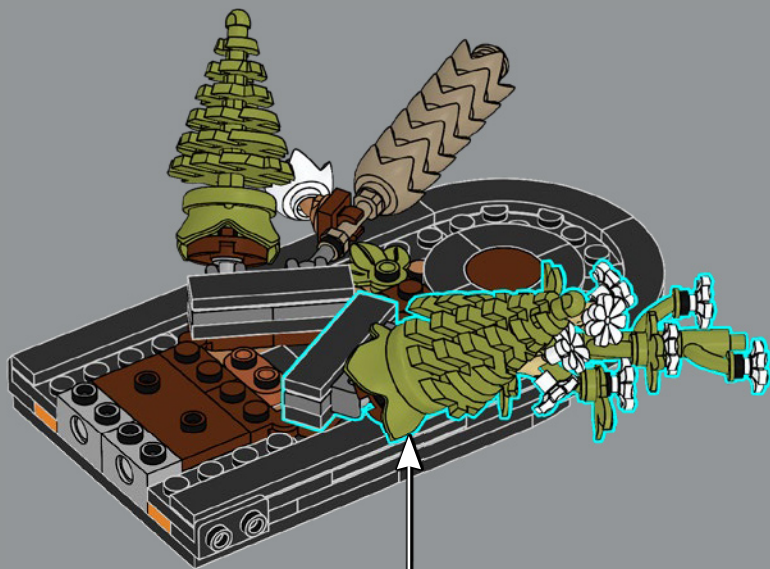

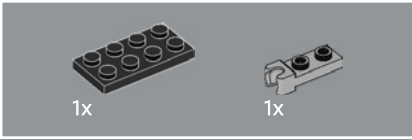
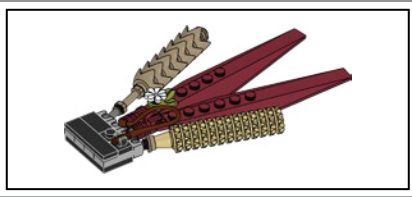

1x

1x

110

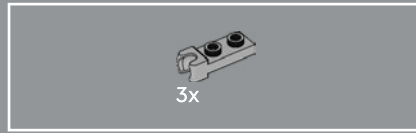

3x

111

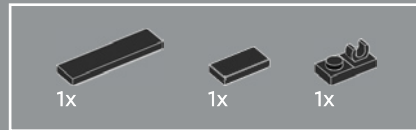
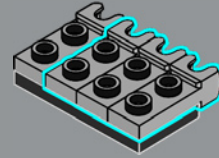

1x

1x

1x

112

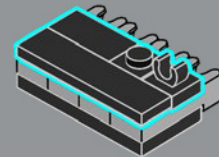

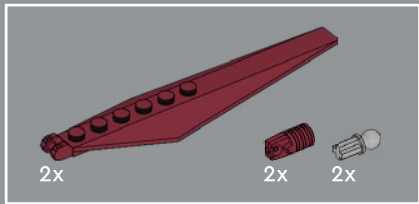

113

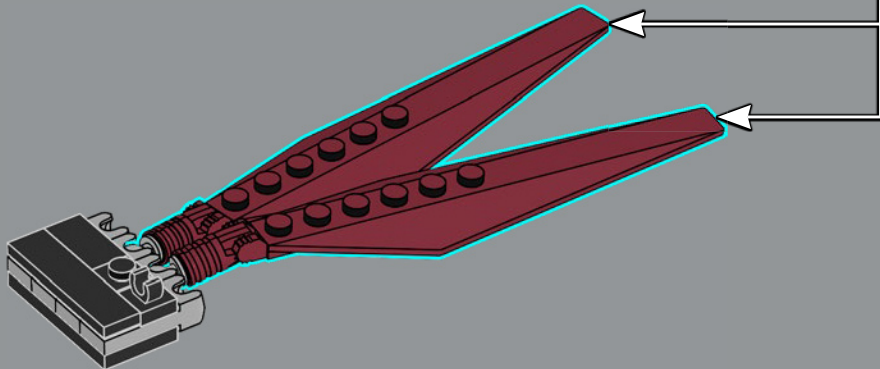
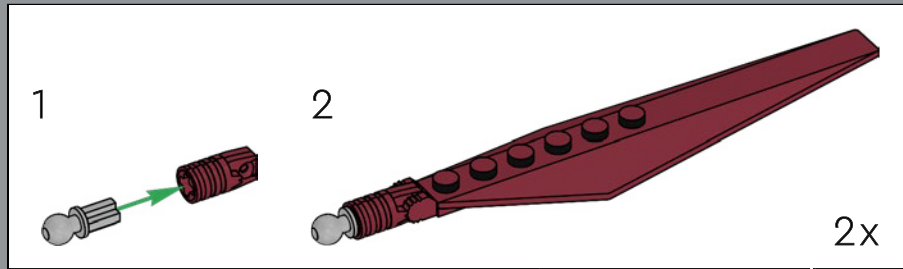

114

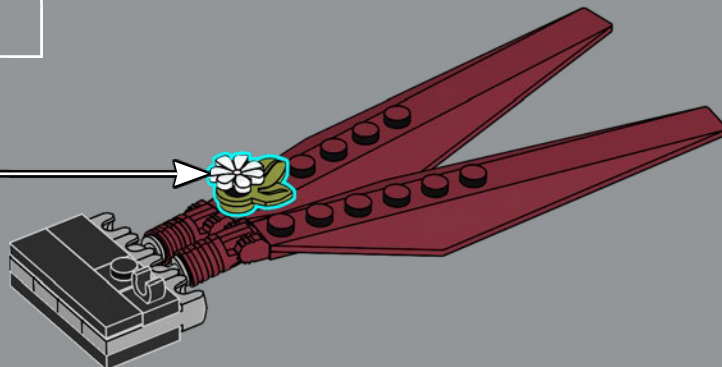
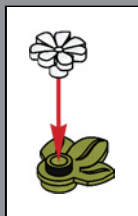



115

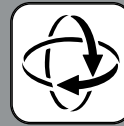
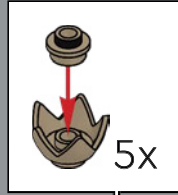
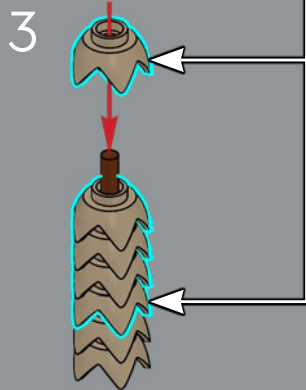
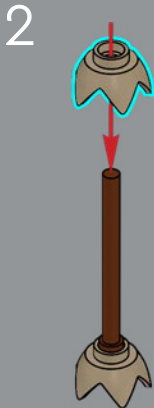
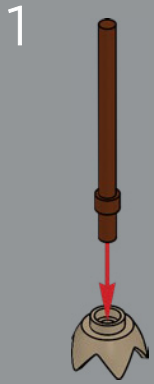

5

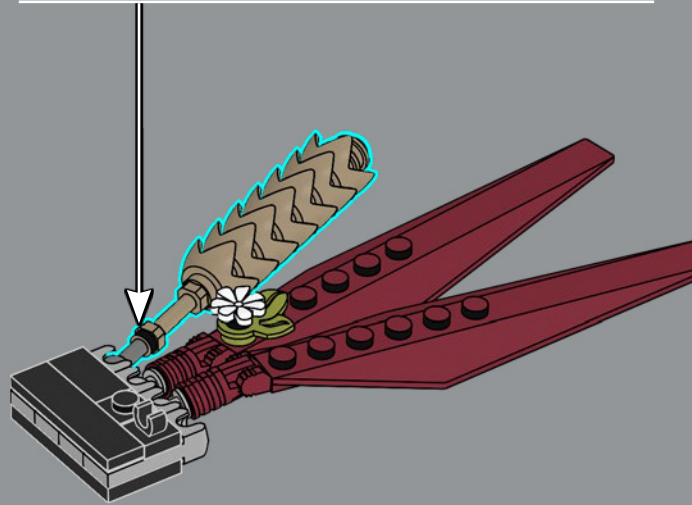
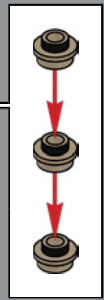

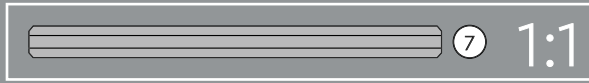
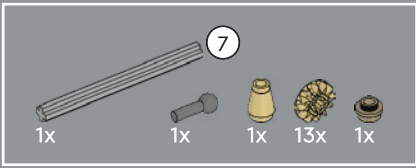

116

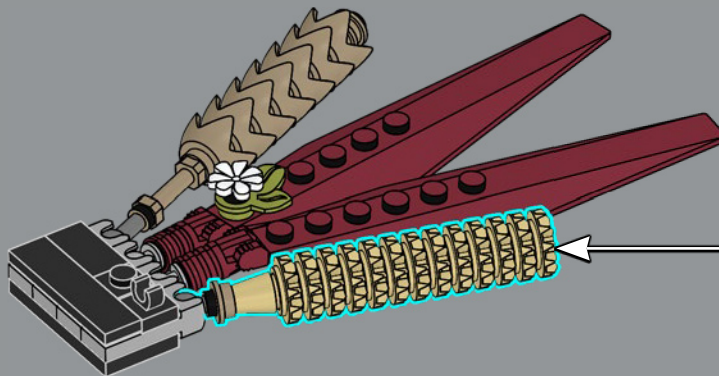
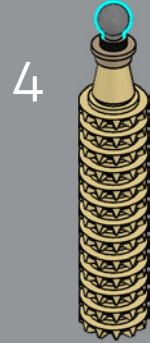
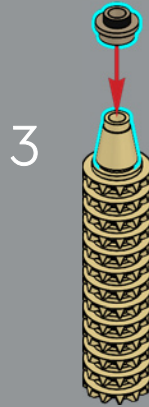
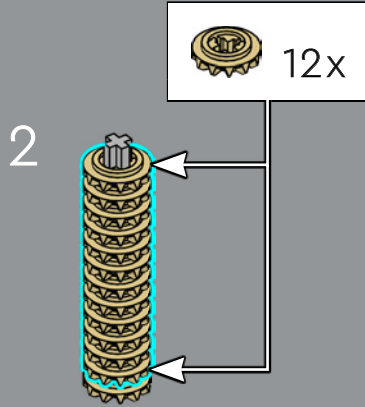
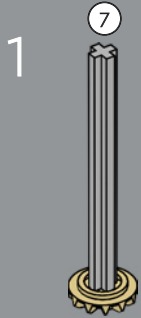



117

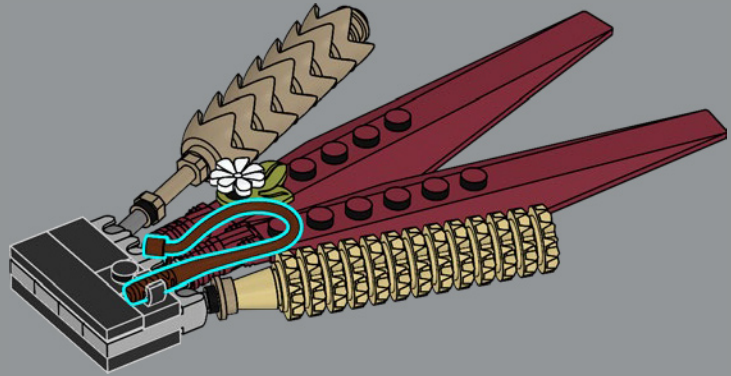

118

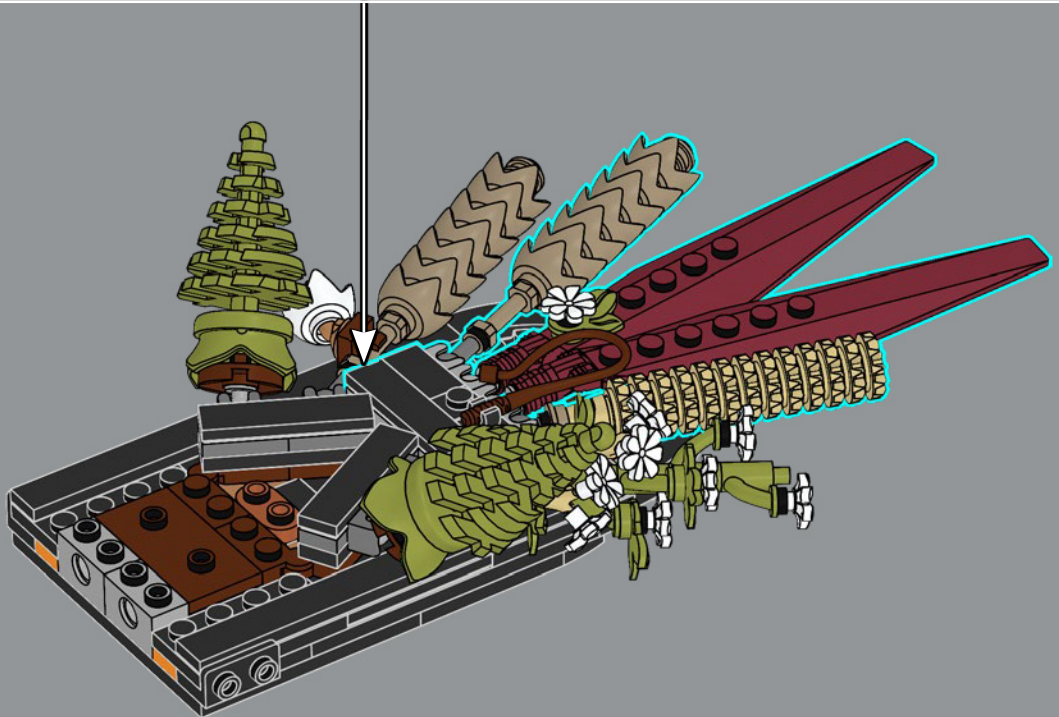

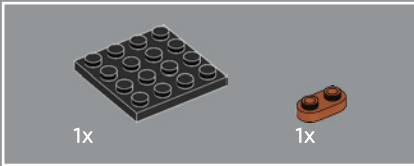
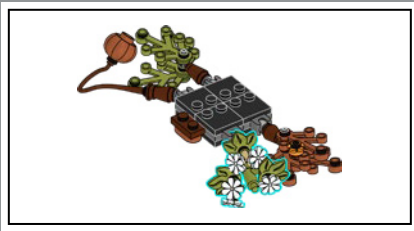

119

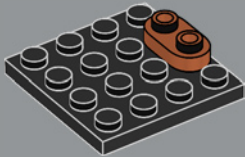

120

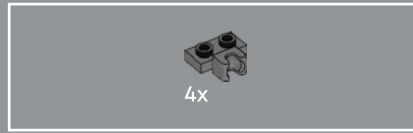
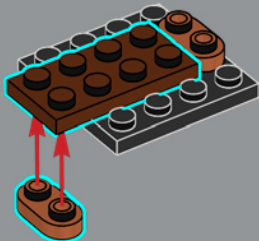

121



4x

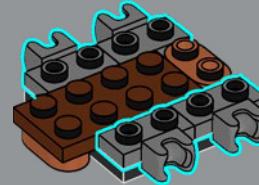

122



4x

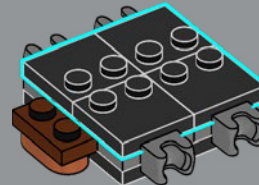

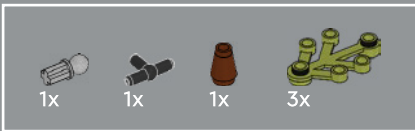

123

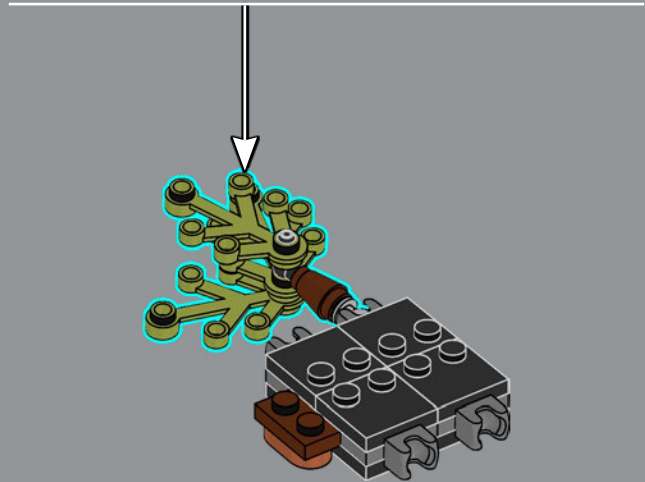
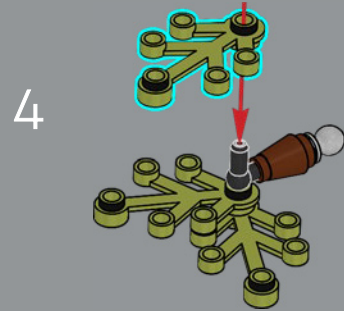
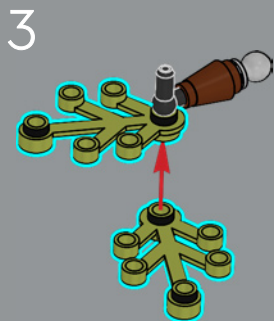
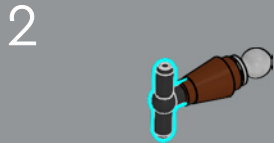
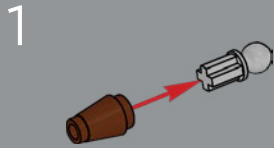



124

1

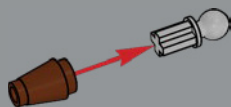

2

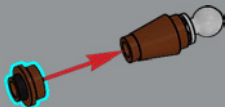

3

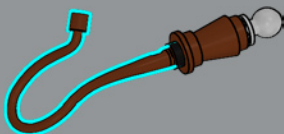

4

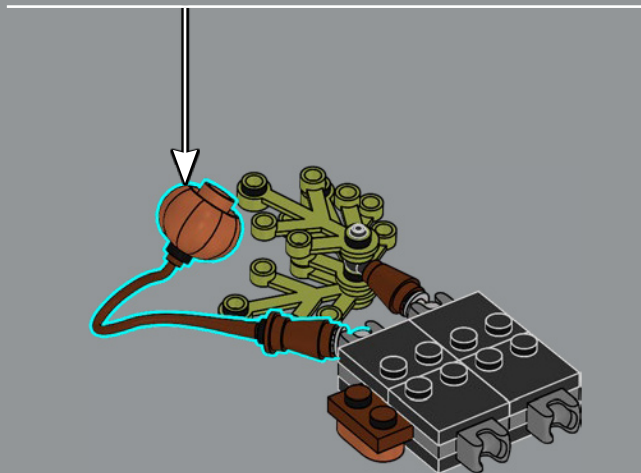
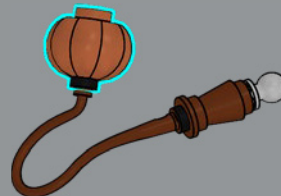

L'alchechengi – un nome sicuramente particolare – è realizzata con un elemento LEGO® che di solito viene utilizzato per le verdure (come le zucche) e un elemento frusta marrone flessibile.





125

1

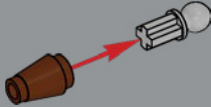

2

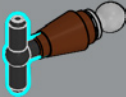

3

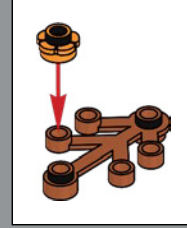
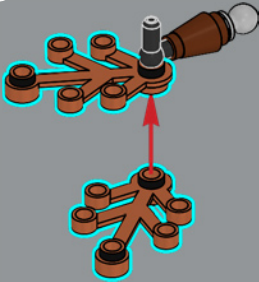

4

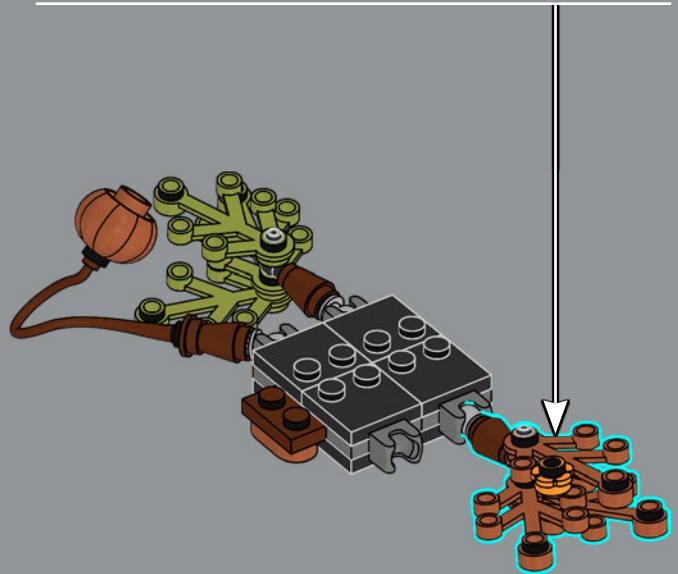
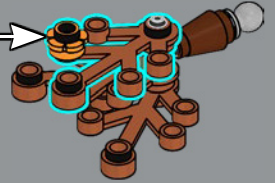

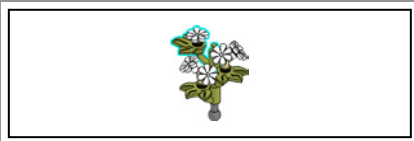

126

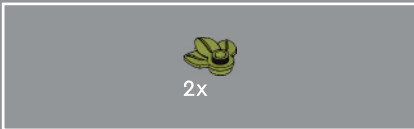

127

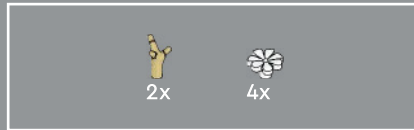
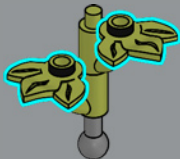

128

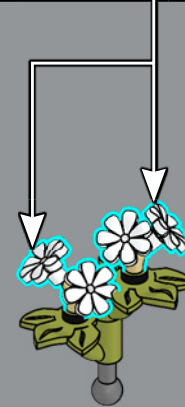
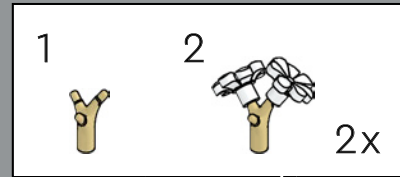

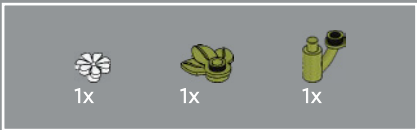

129

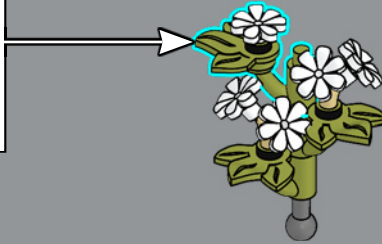
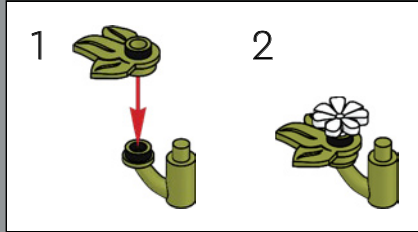

130

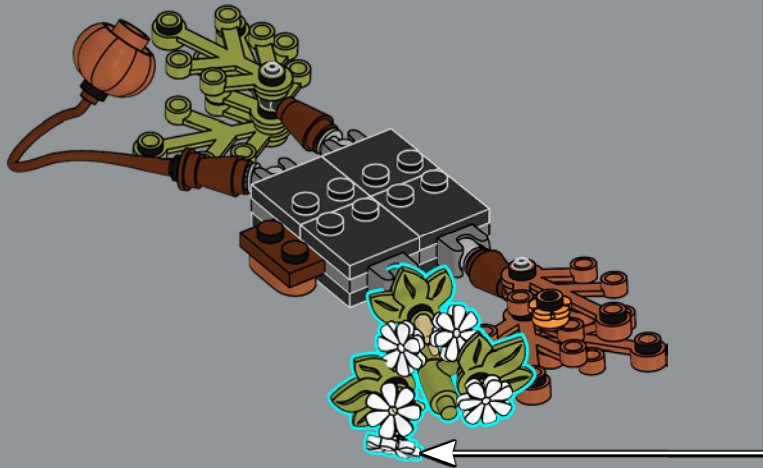

131

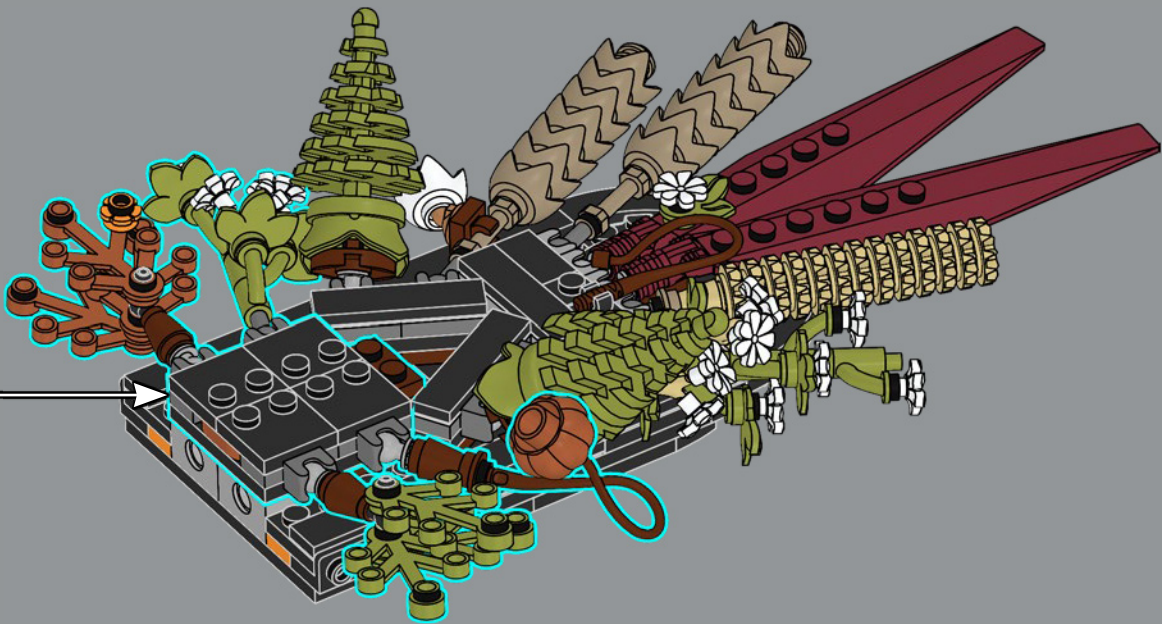

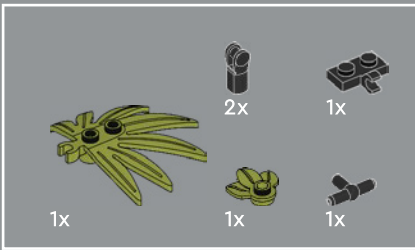

132

1

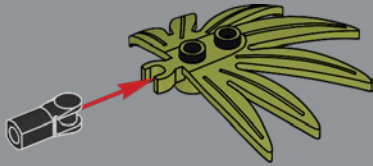

2

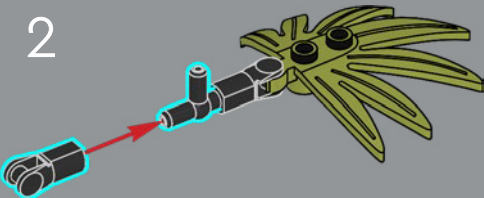

3

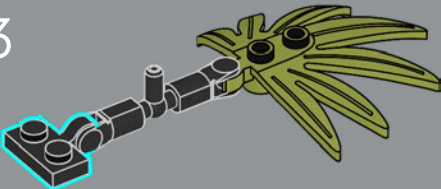

4

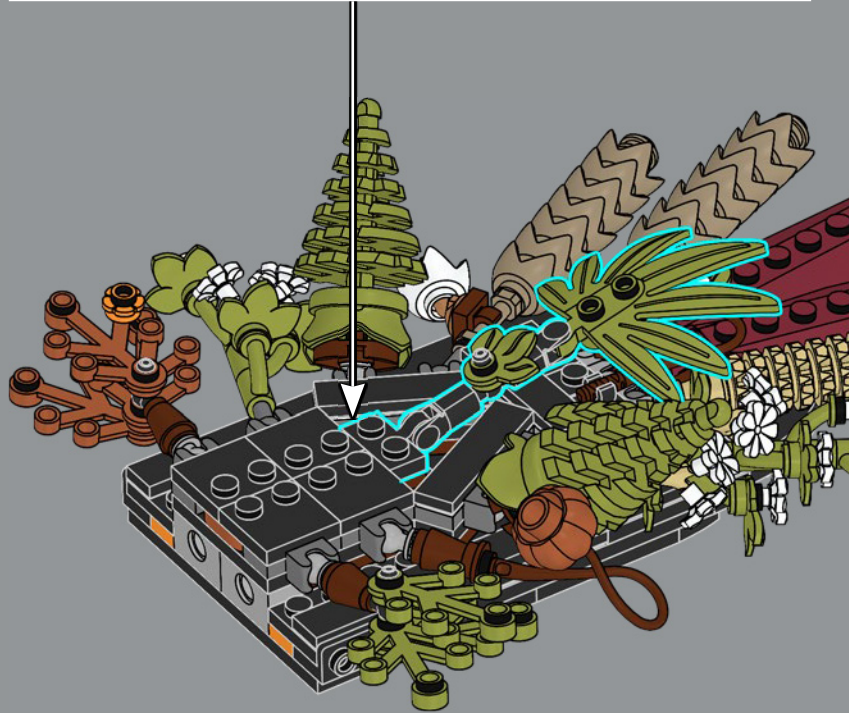
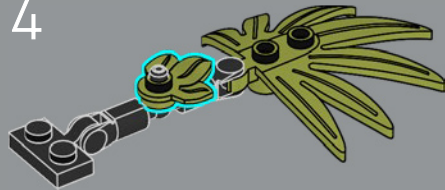

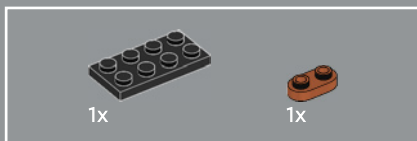
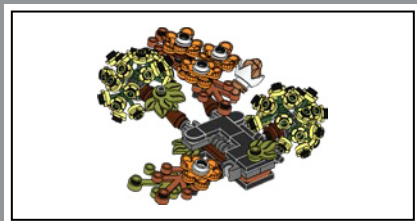

133

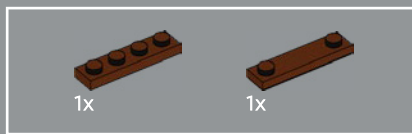
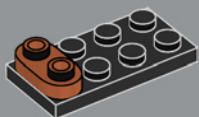

134

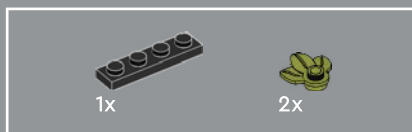
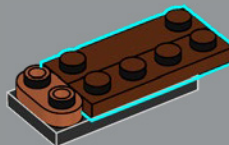

135

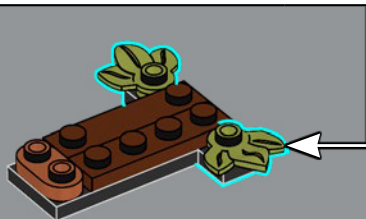
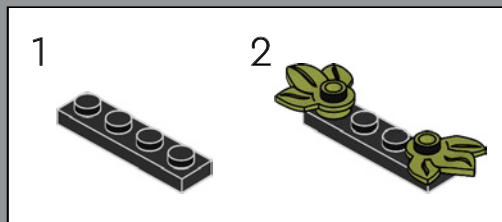

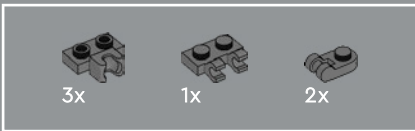

136

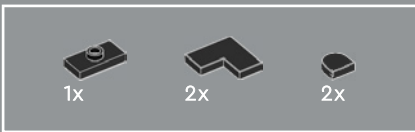
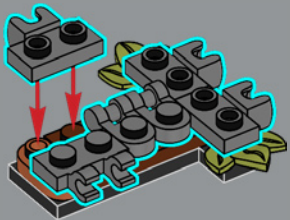

137

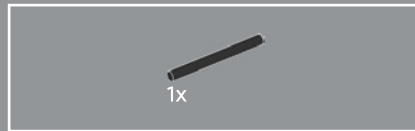
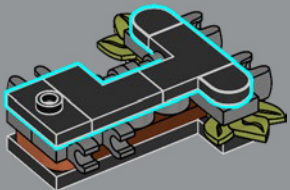

138

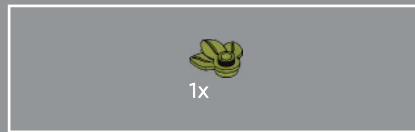
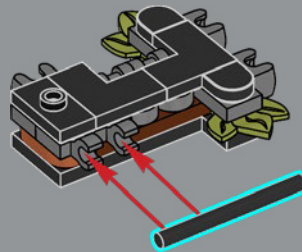

139

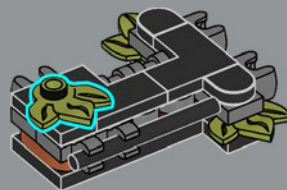

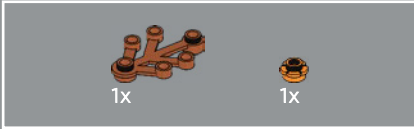
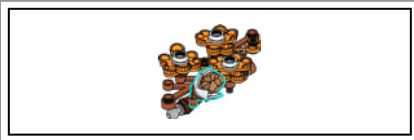

140

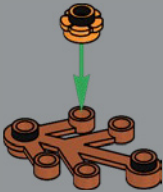

141

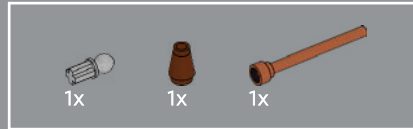
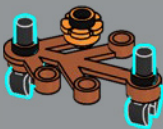

142

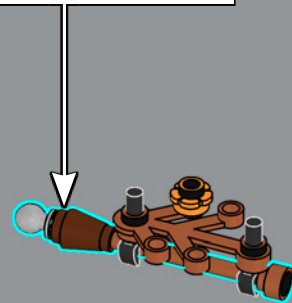
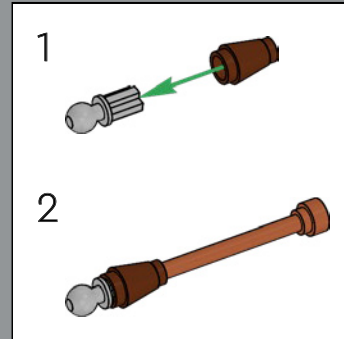

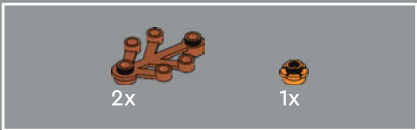

143

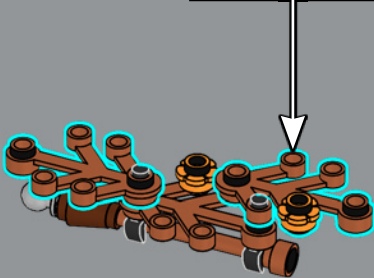
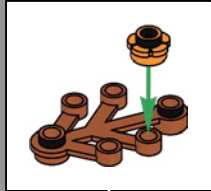

144

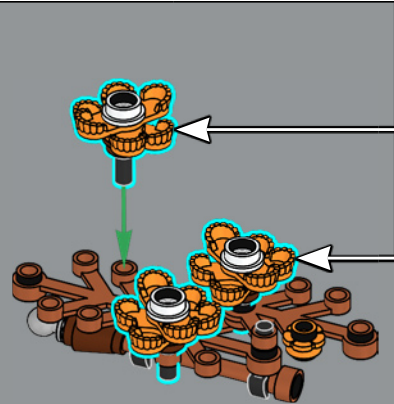
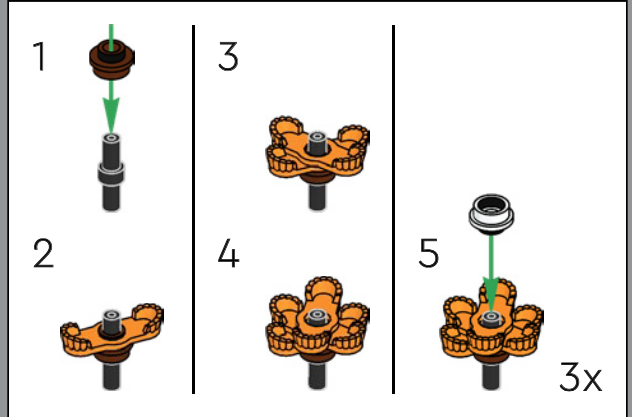



1x



1x



1x

145

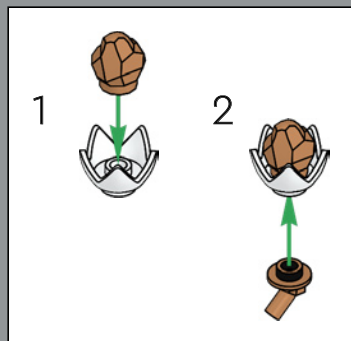

Le teste di margherite essiccate sono realizzate con un elemento corona bianco e un elemento di roccia raro, usato per la prima volta come pepita d'oro.

146

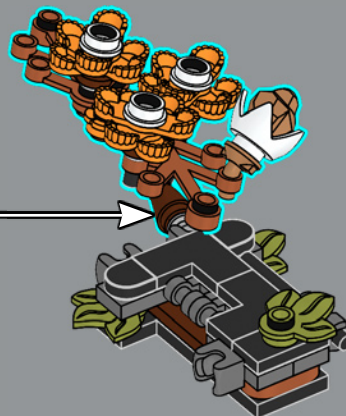

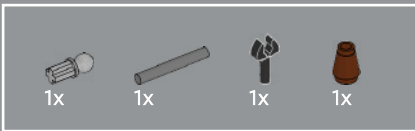

147

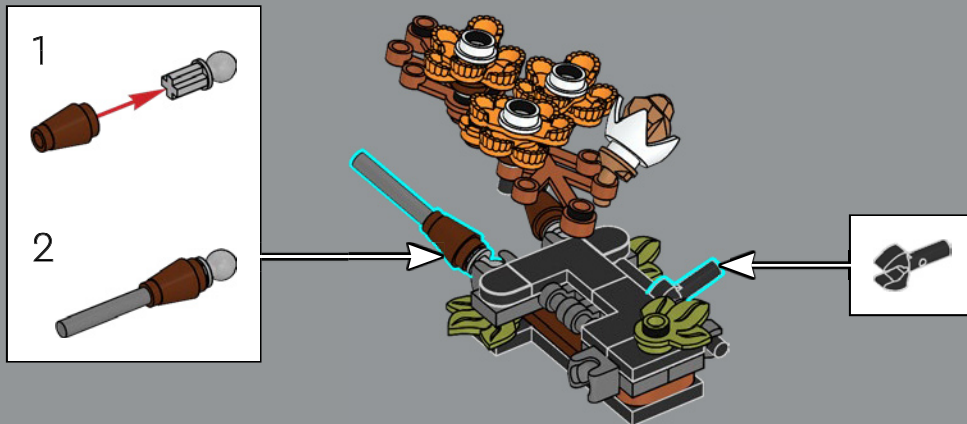



148

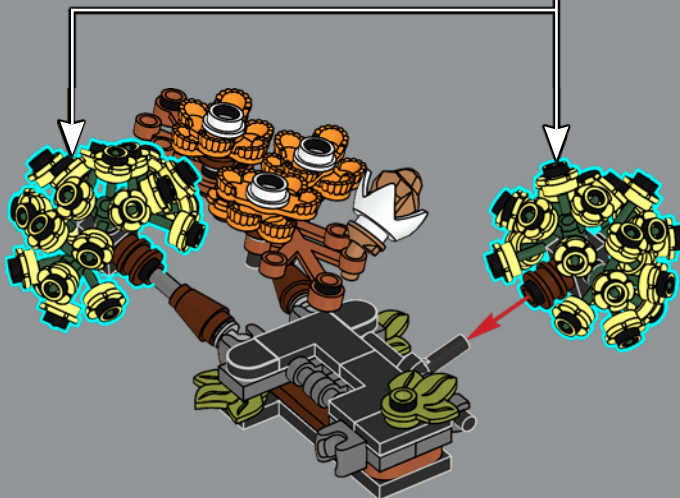
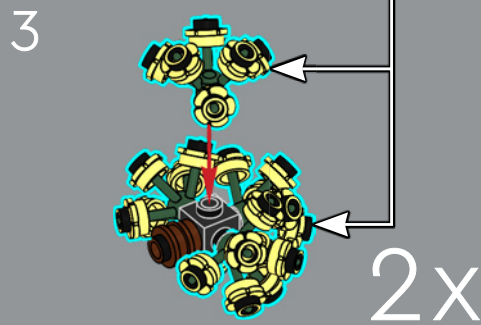
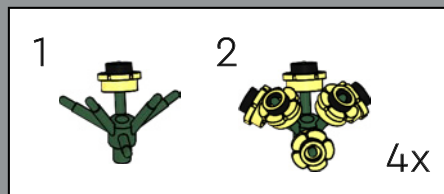
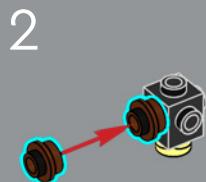
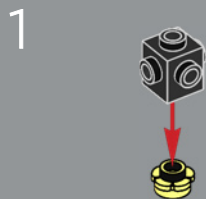



1x



2x

149

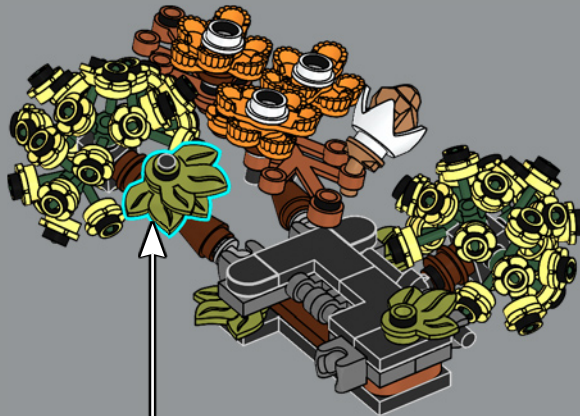

1

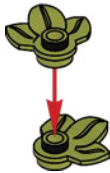

2



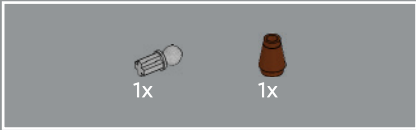

150

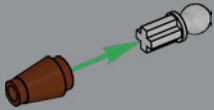

151

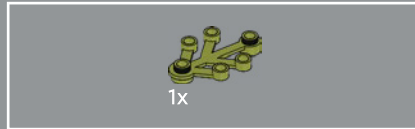
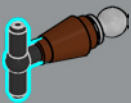

152

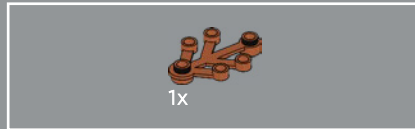
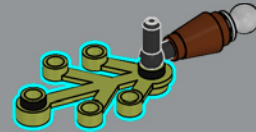

153

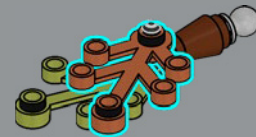

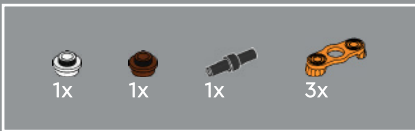

154

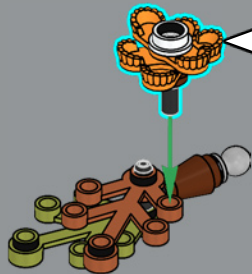
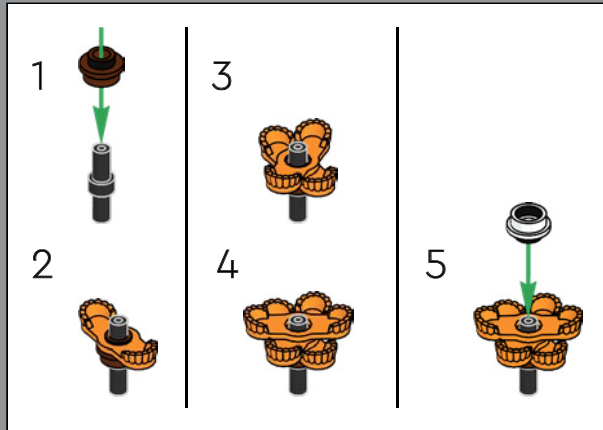

155

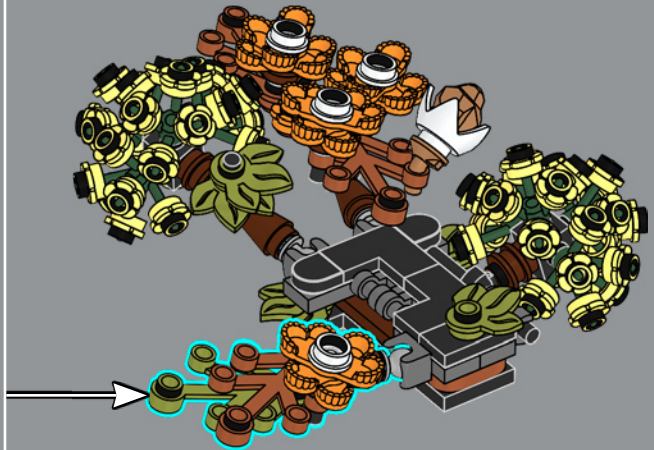

156

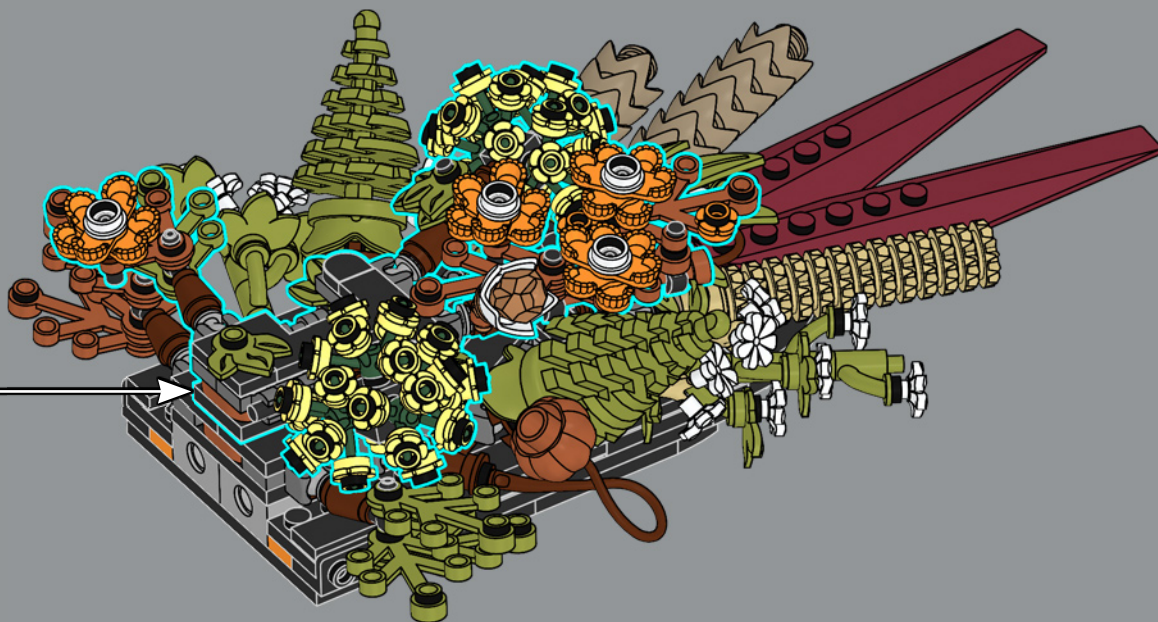

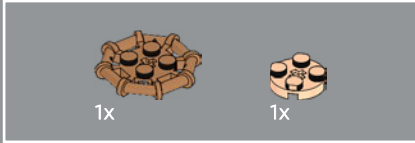
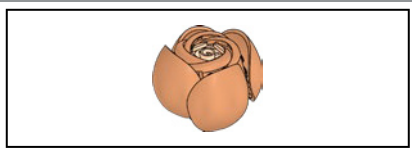

157

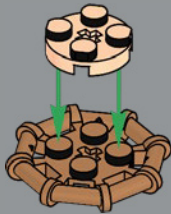

158



159

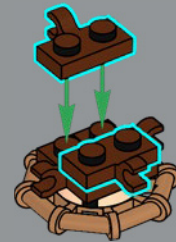

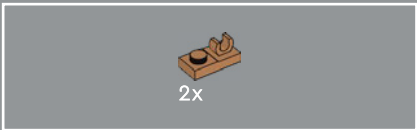

160

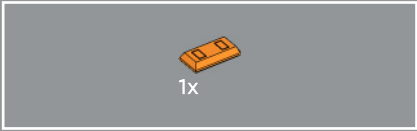
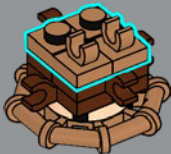

161

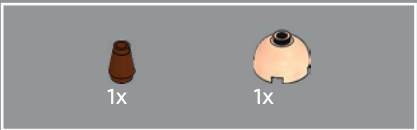

162

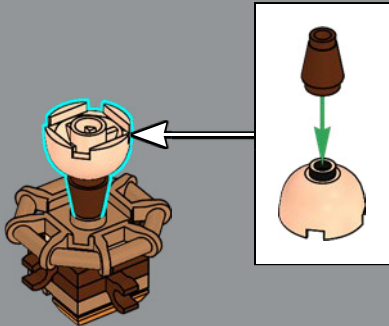

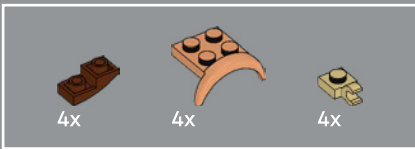

163

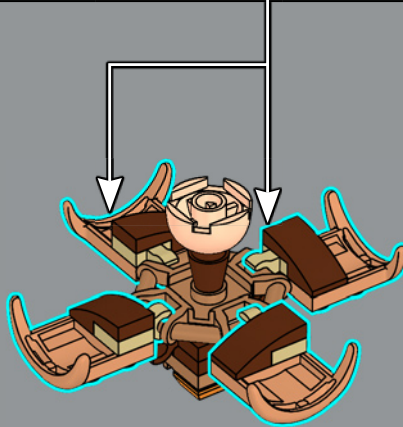
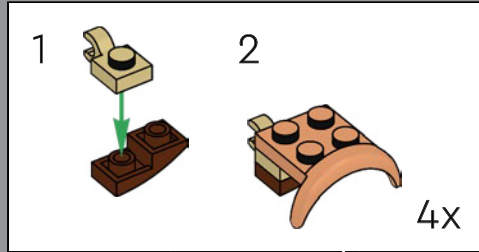

164

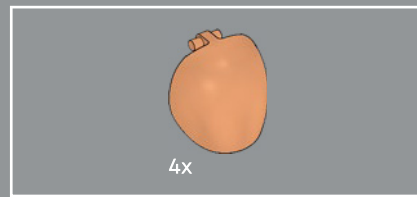
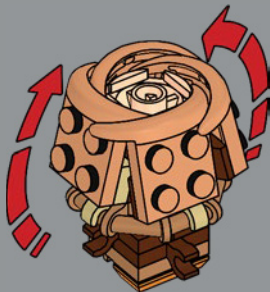

165

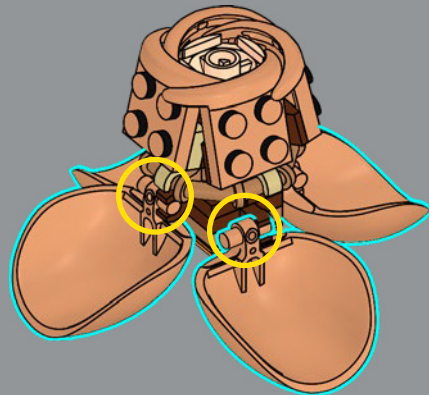

166

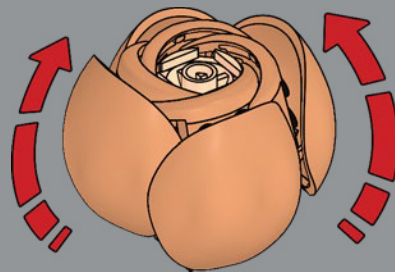



L'intricata costruzione della rosa utilizza nuovi elementi parafango per i petali interni e un nuovo elemento conchiglia per i petali esterni.

167

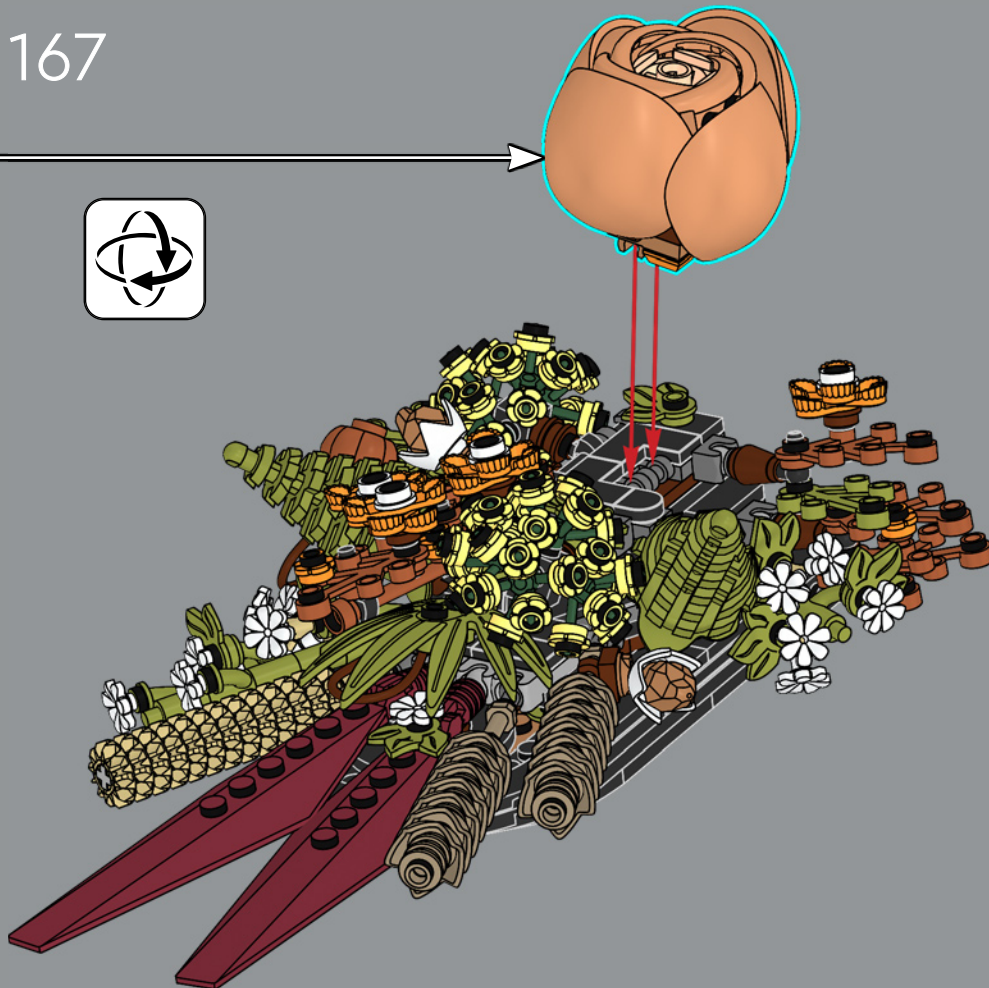



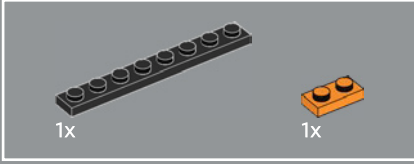

168

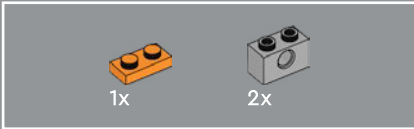
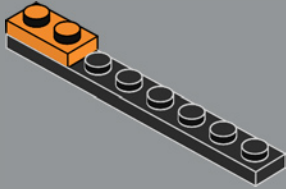

169

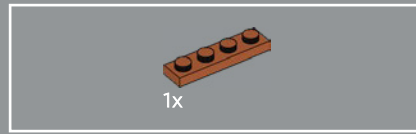
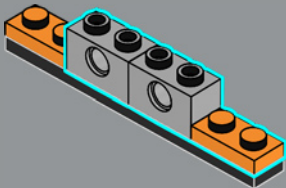

170

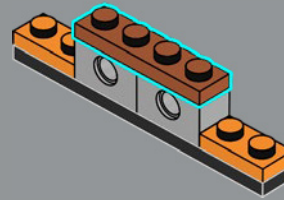

171

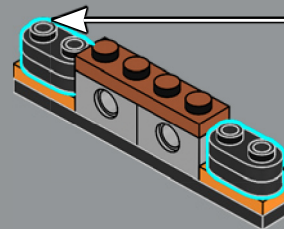
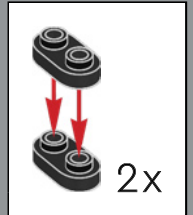



172

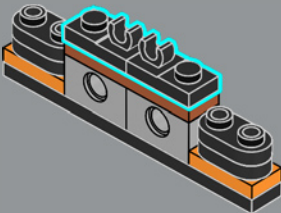

173

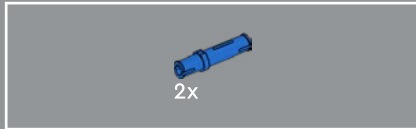
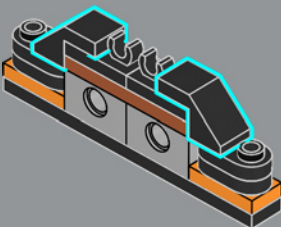

174

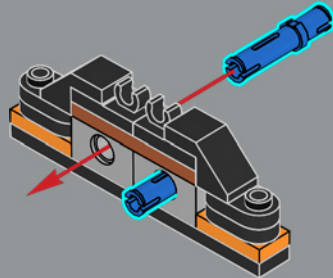



175

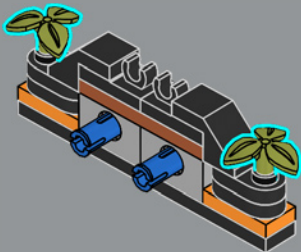

176

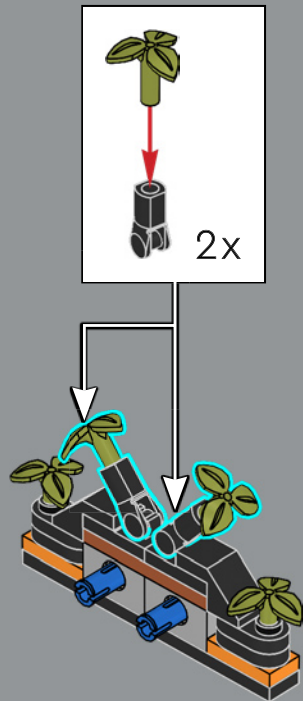

177

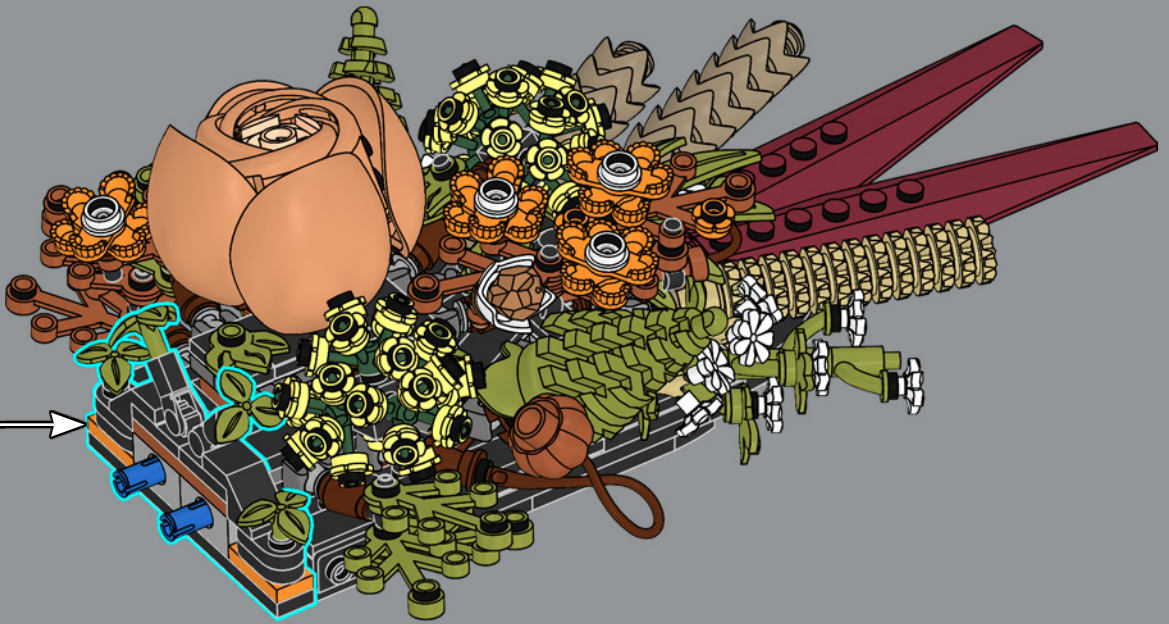



I fiori secchi vengono talvolta protetti applicando una cera sottile. Gli elementi lucidi di questo set sono stati scelti per replicare l'aspetto della cera.

178

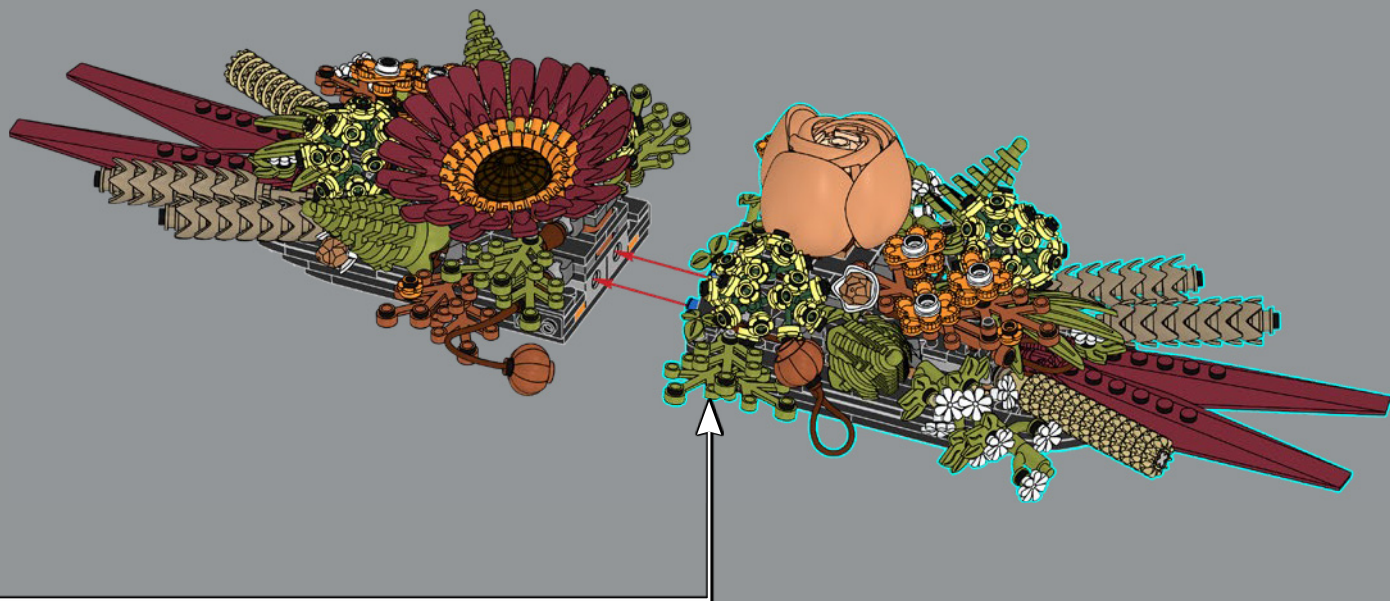

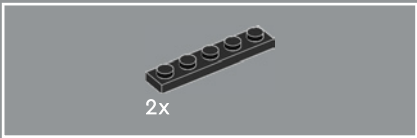

179

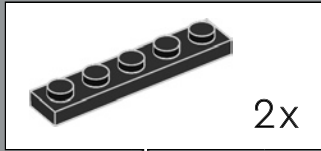

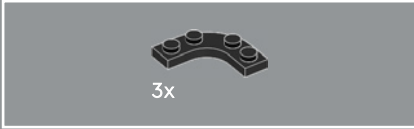
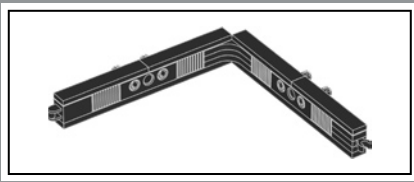

180

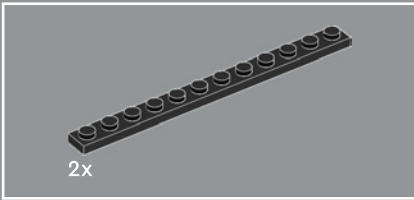
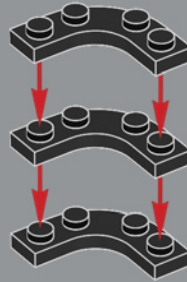

181

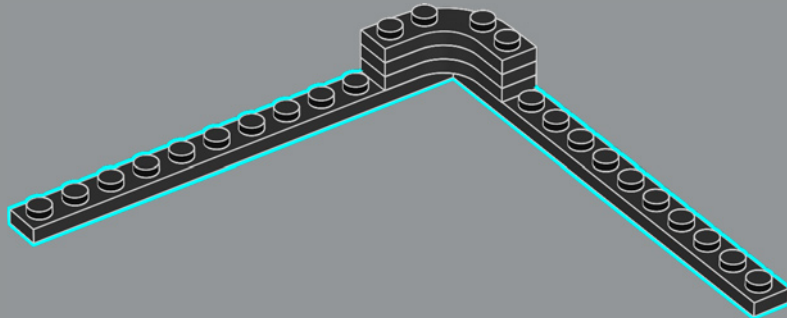

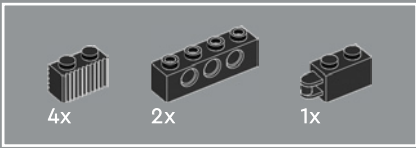

182

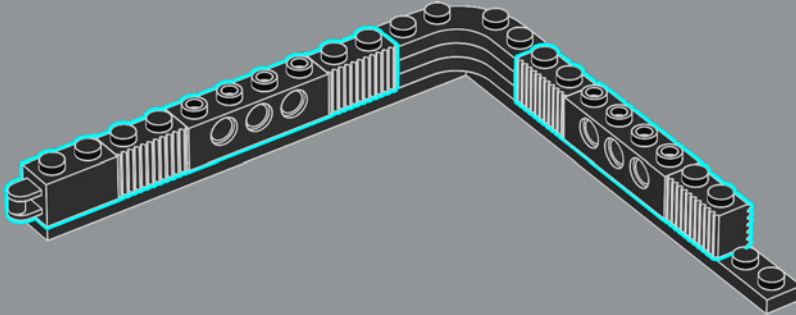

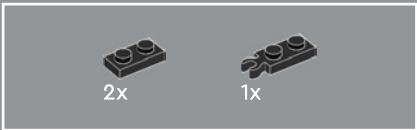

183

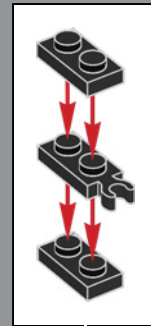
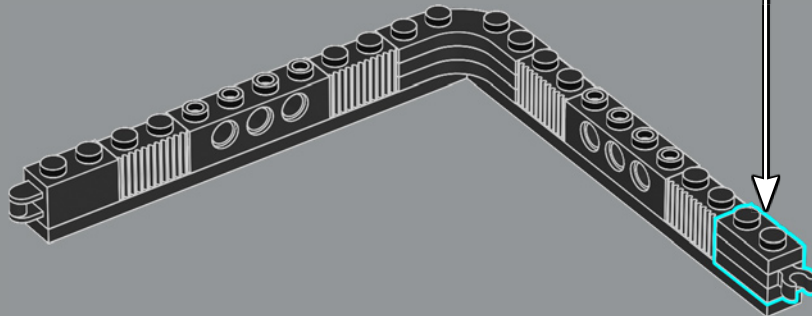

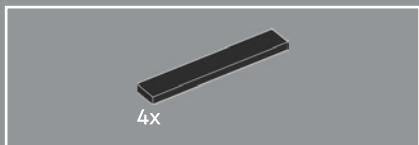

184

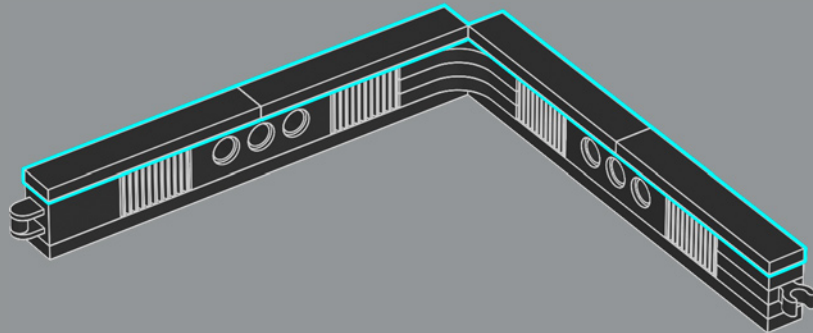

185

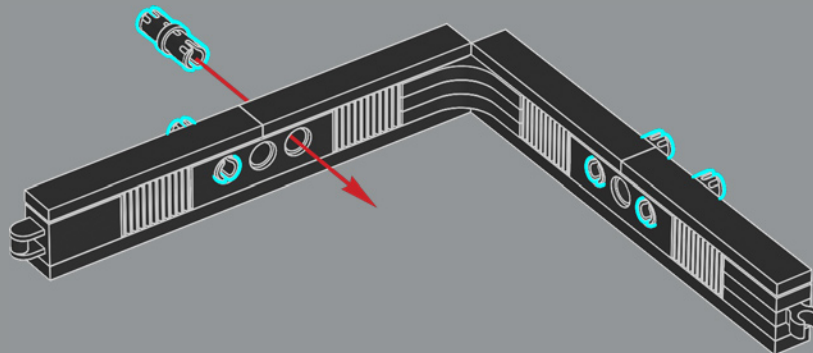

186

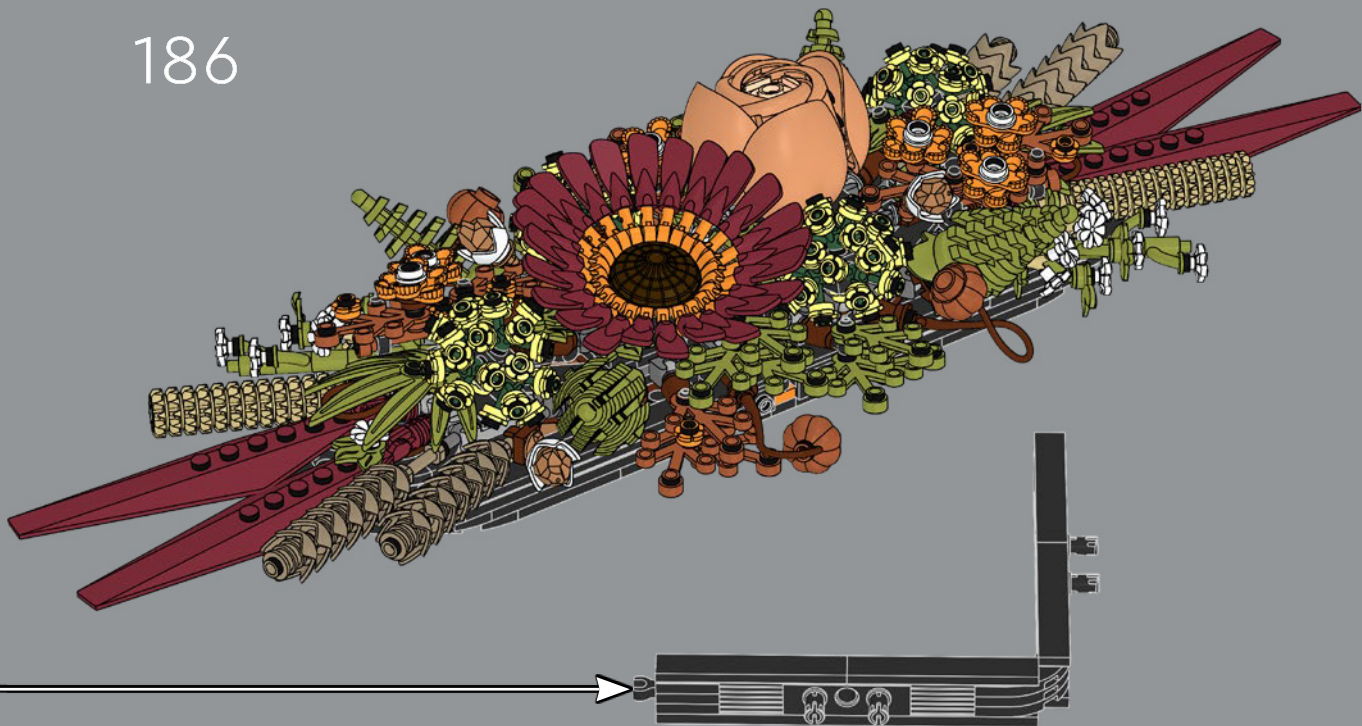

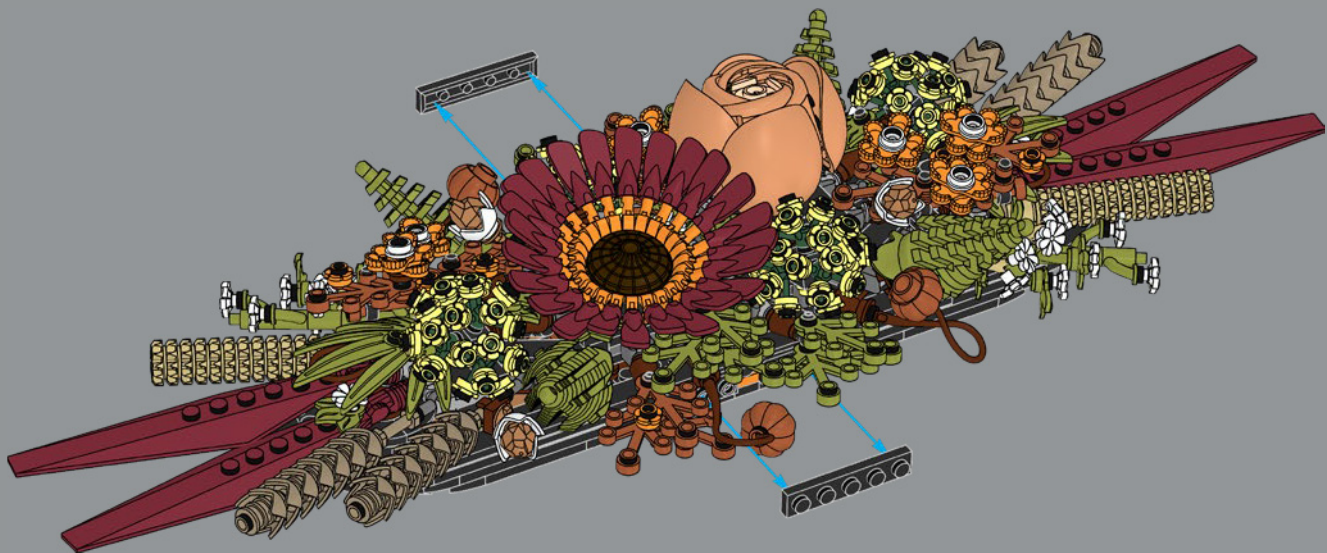

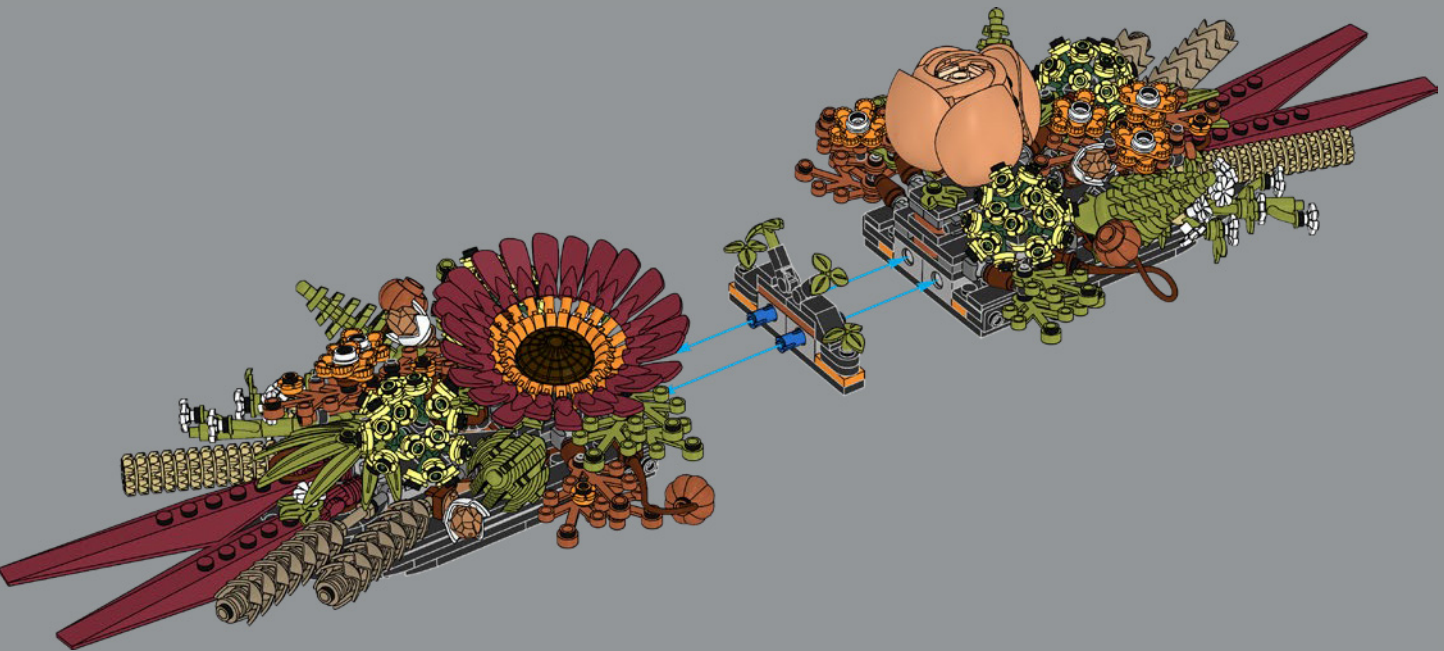

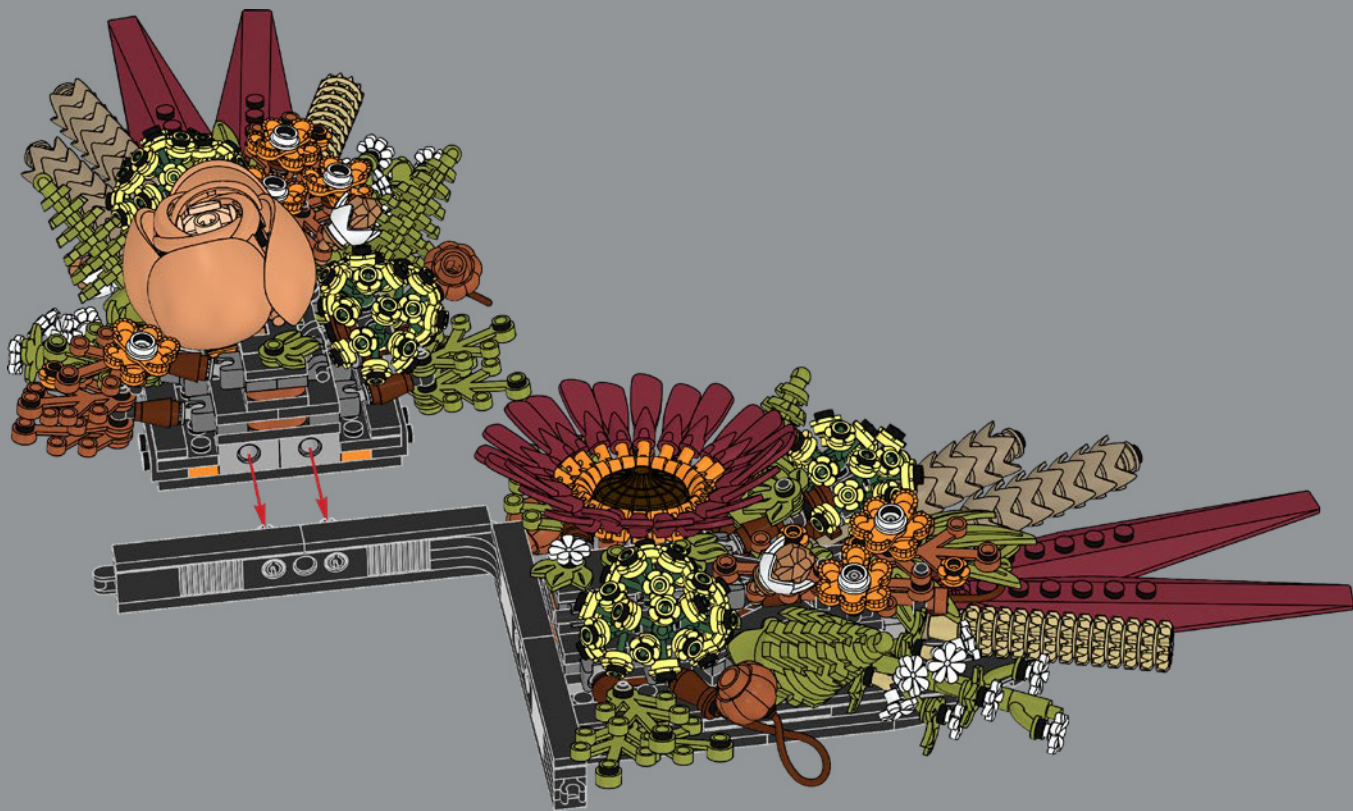



3 x 10314

