

77

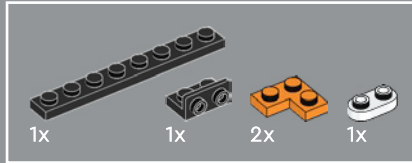

78

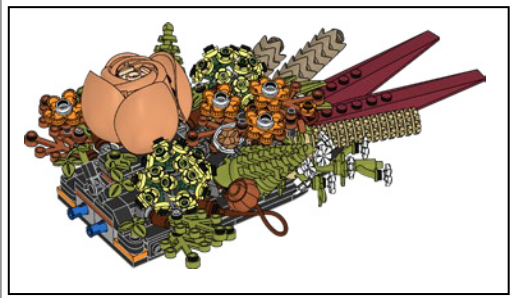

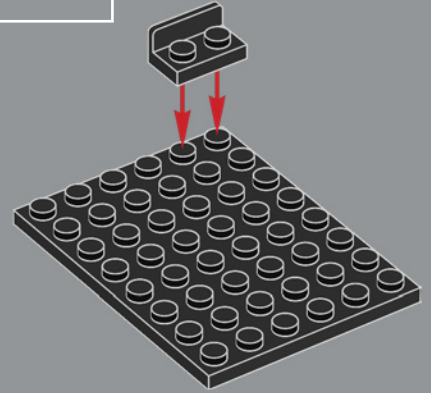
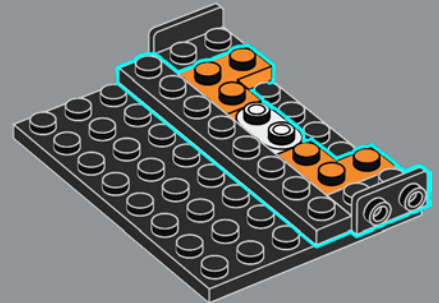
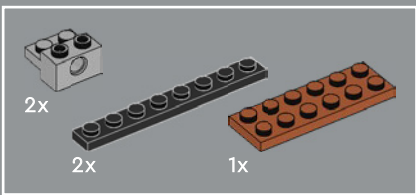

79

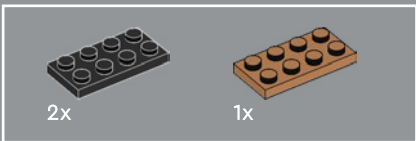
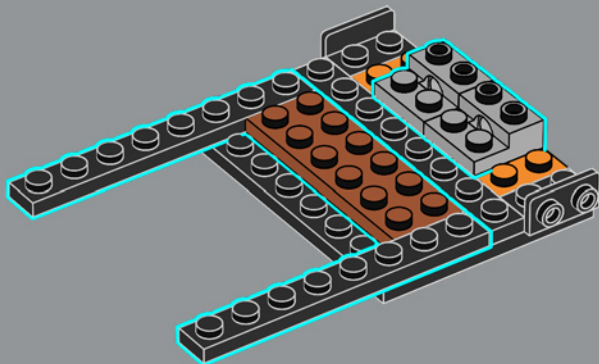

80

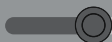
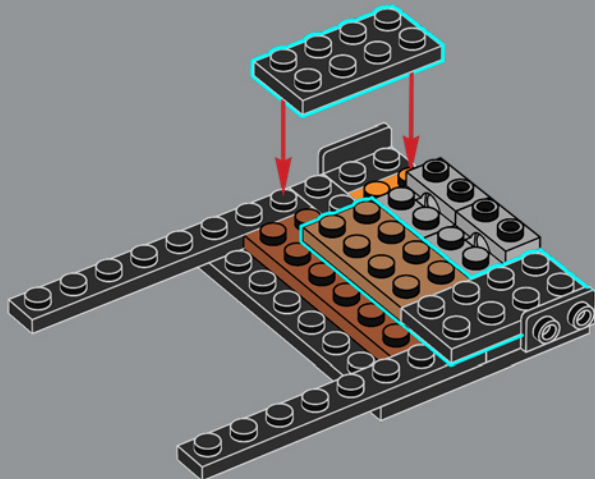

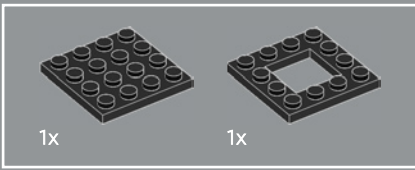

81

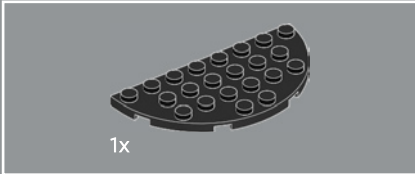
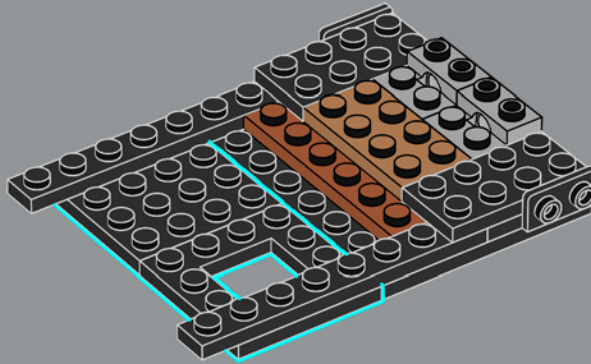

82

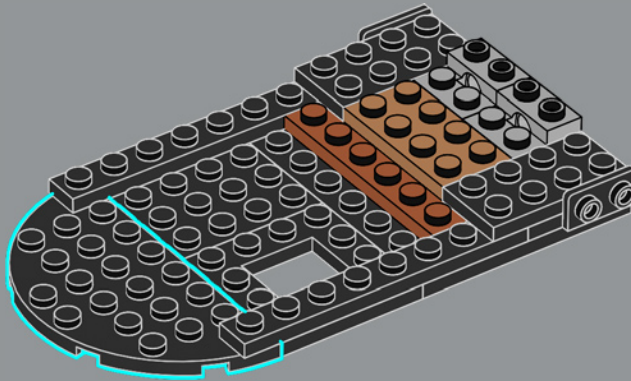

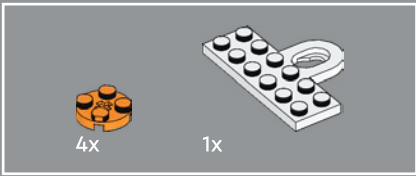

83

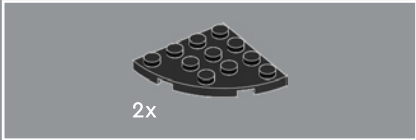
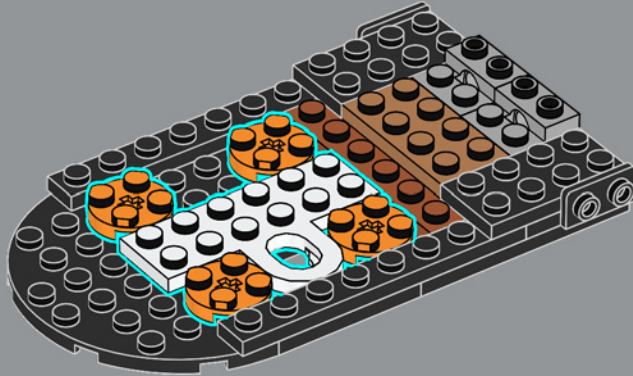

84

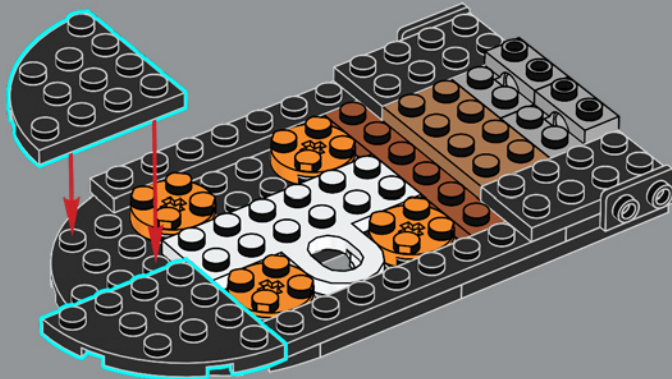

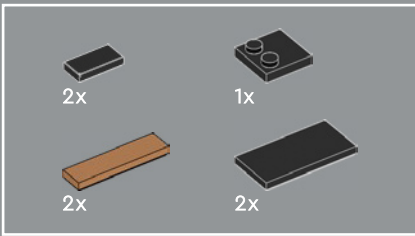

85

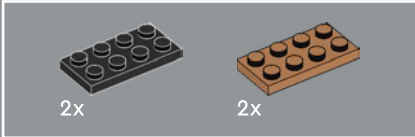
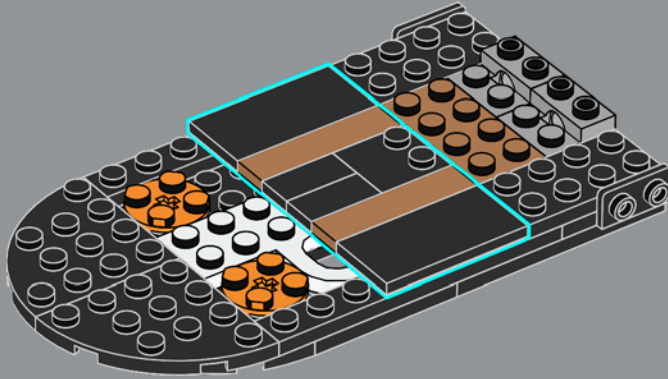

86

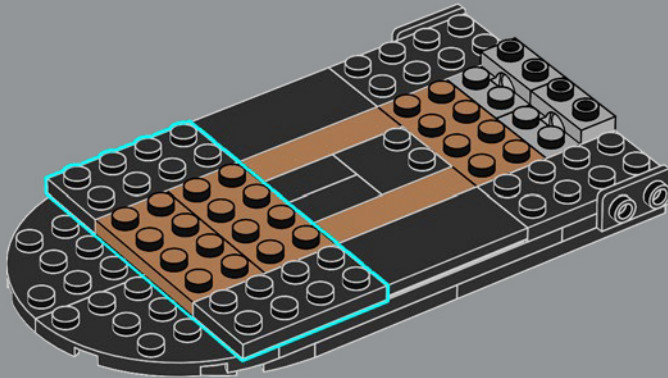

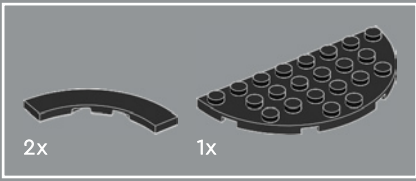

87

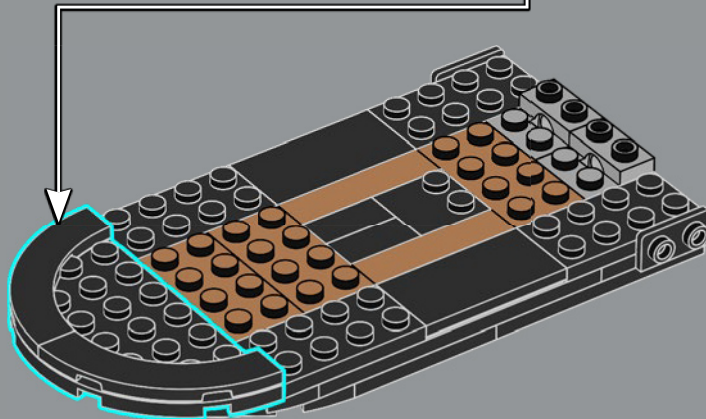
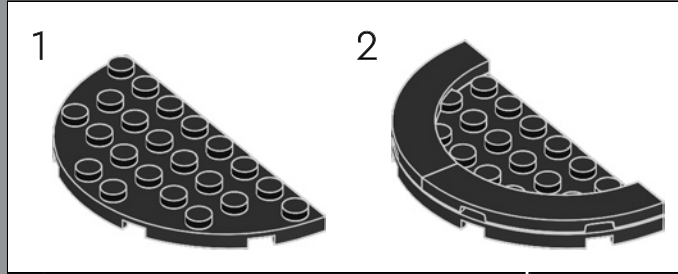

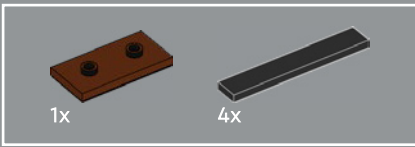

88

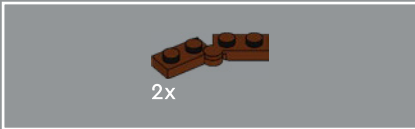
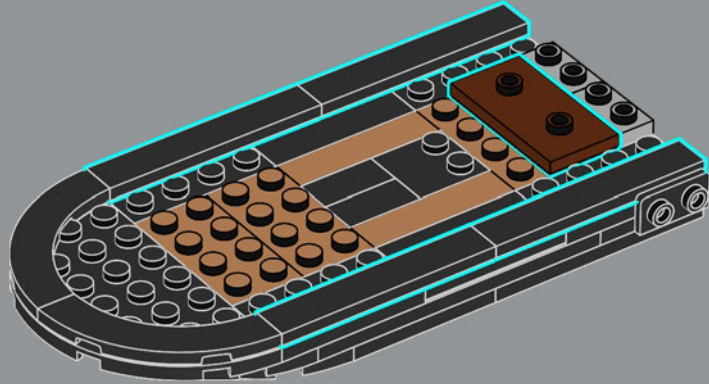

89

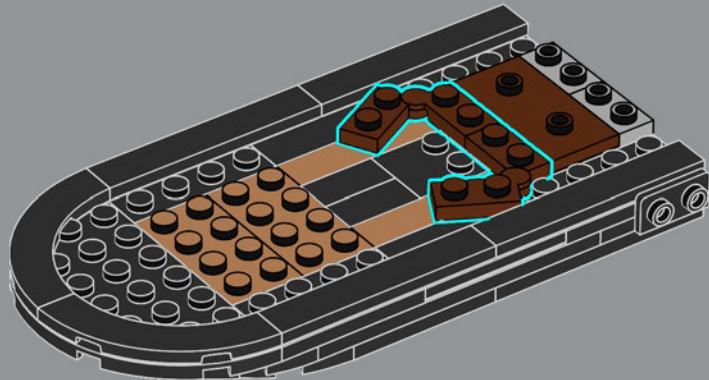

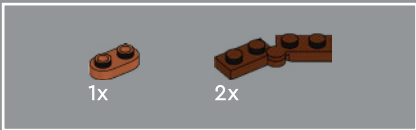

90

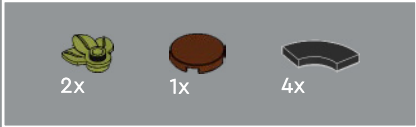
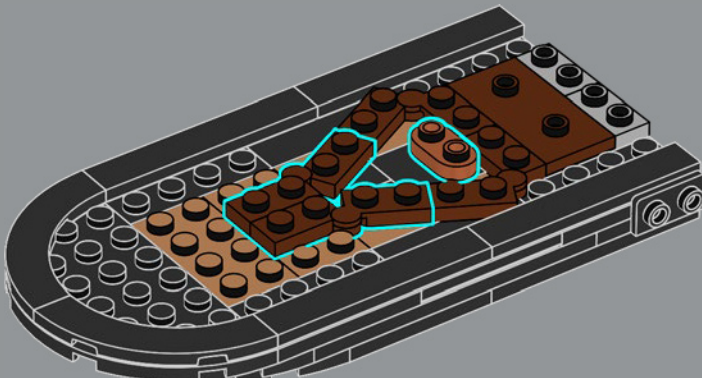

91



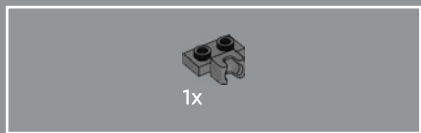

93

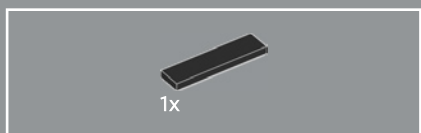
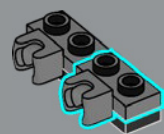

94

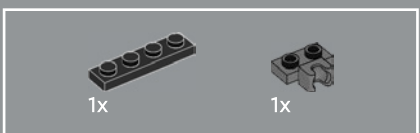
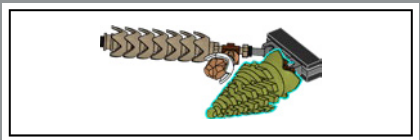
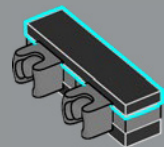

92

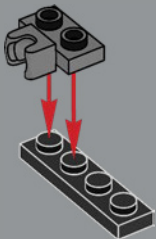



95

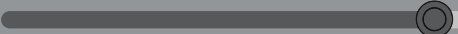
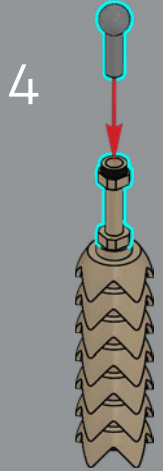
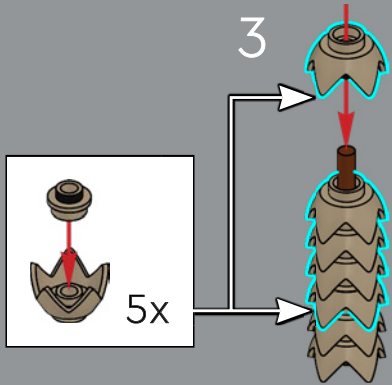
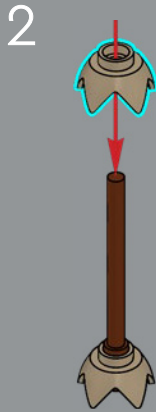
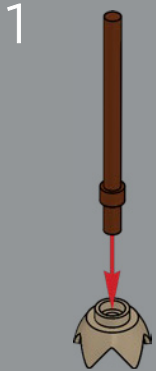



5

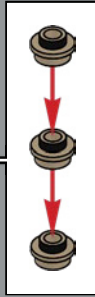

1x



1x



1x



1x

96

1



2

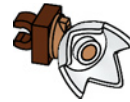

3

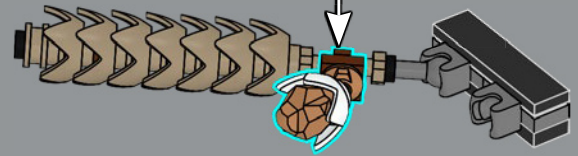

Mit geschichteten Kronen lassen sich die geriffelten Weizenähren gut nachbilden.

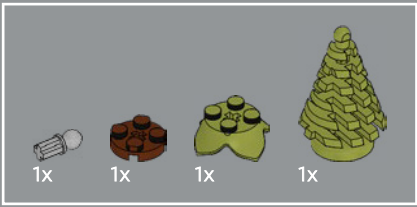

97

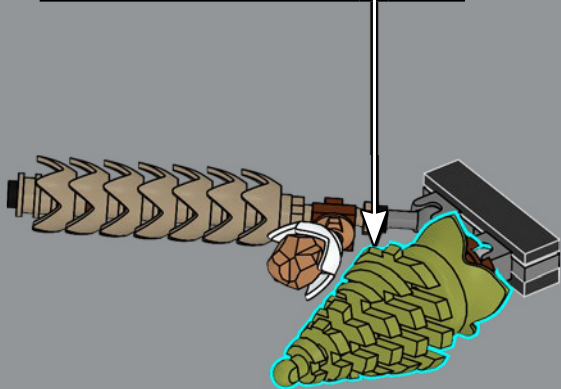
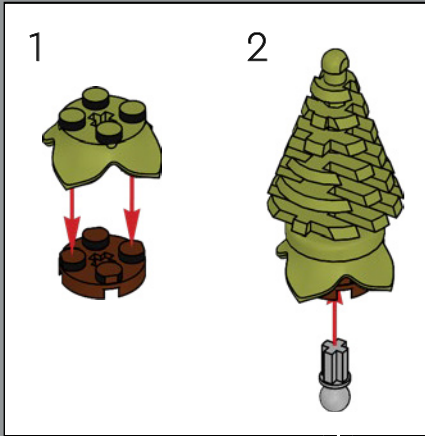

98

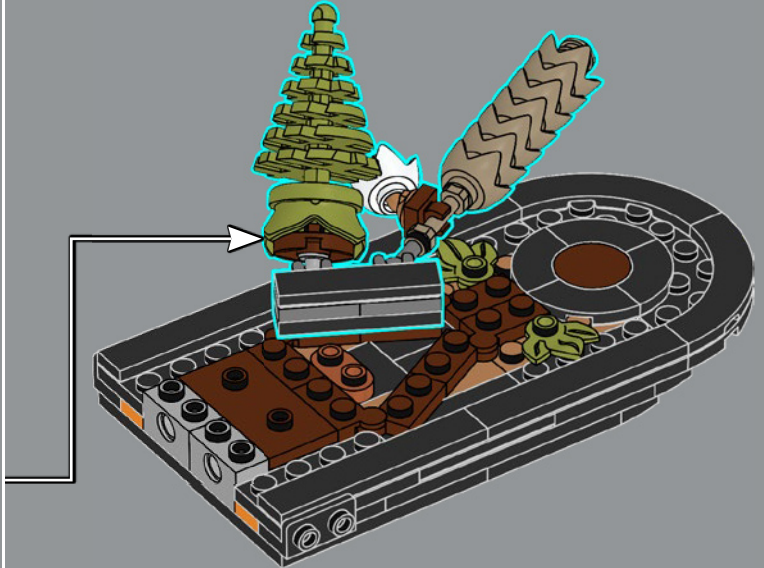

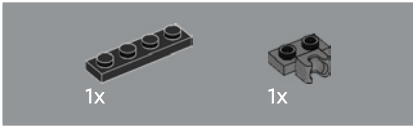
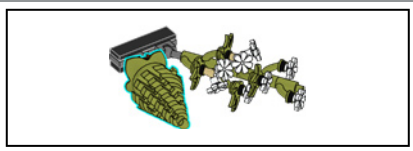

99

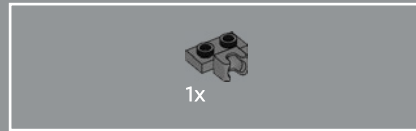
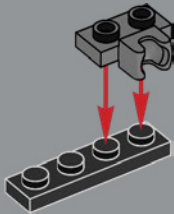

100

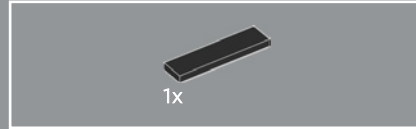
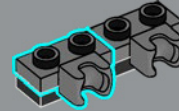

101

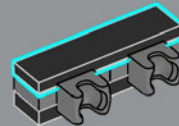

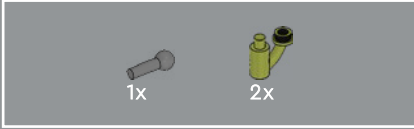
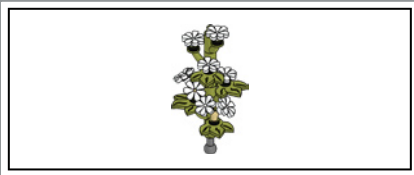

102



103

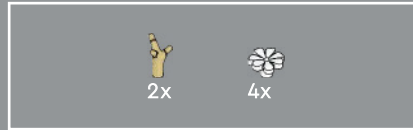
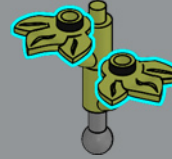

104

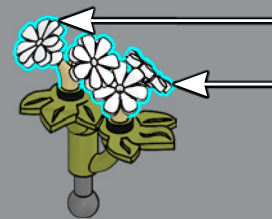
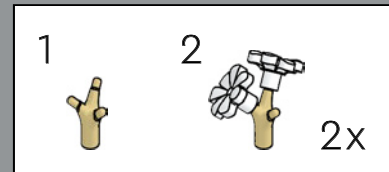



105

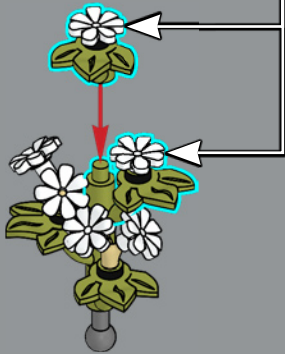
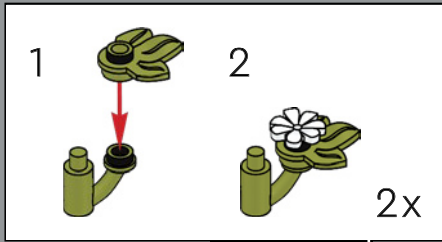

106

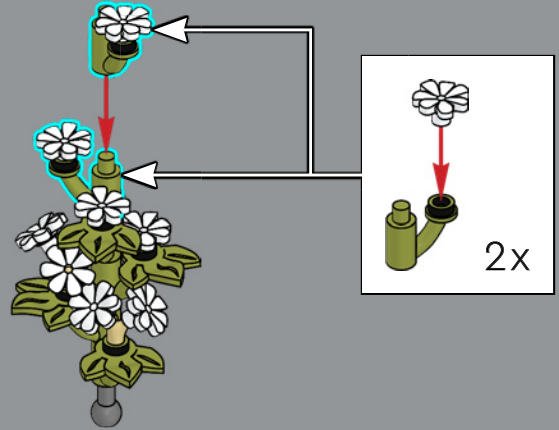

107

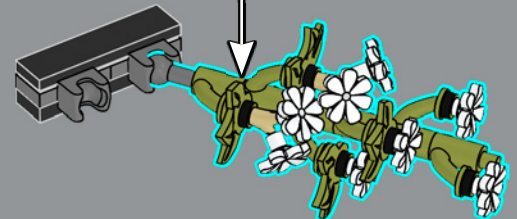

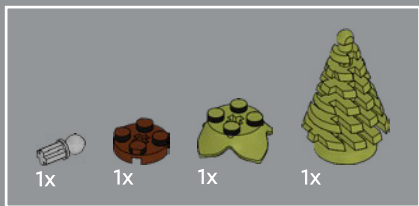

108

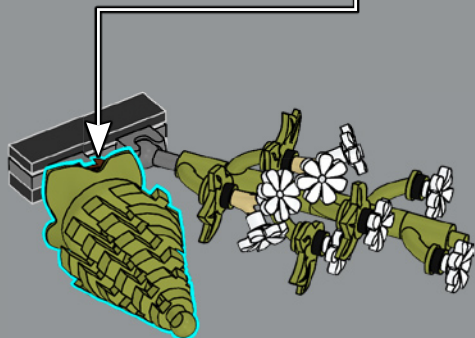
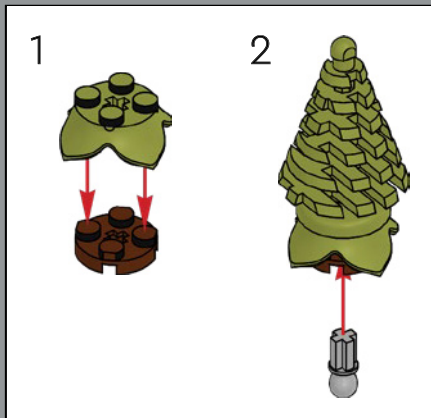

109

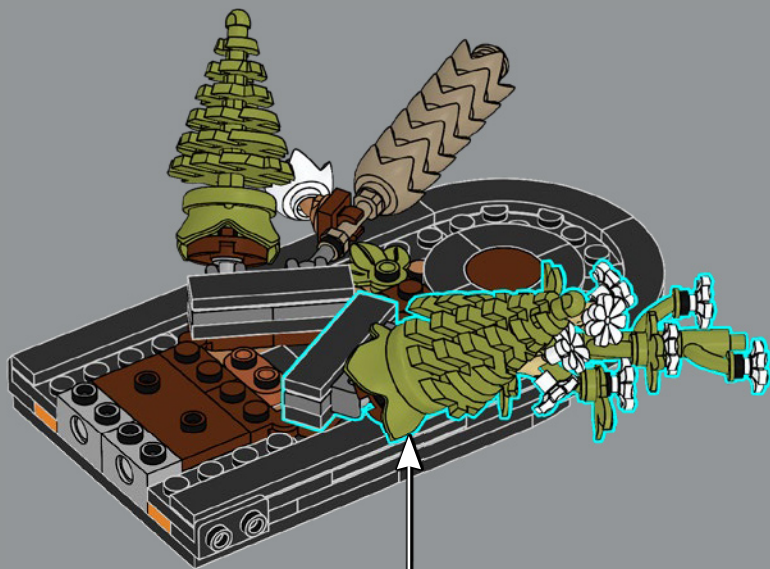

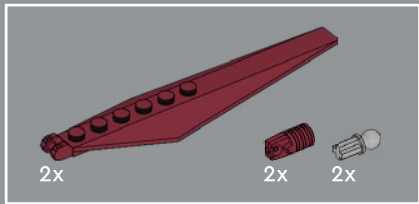

113

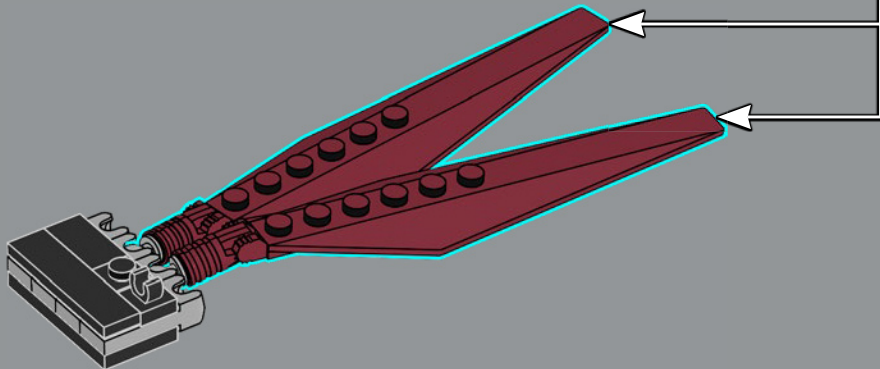
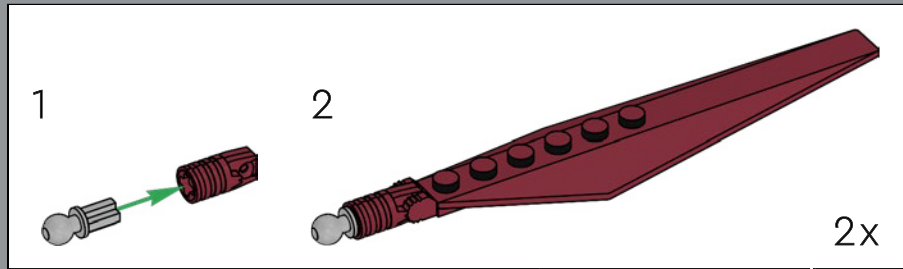

114

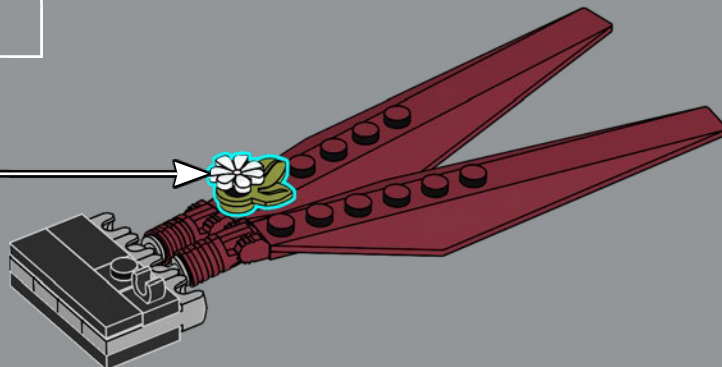
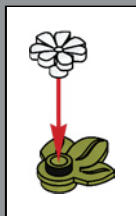



115

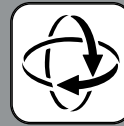
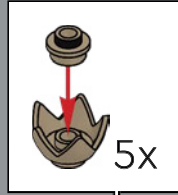
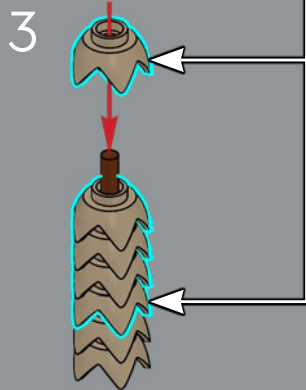
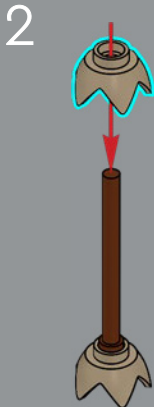
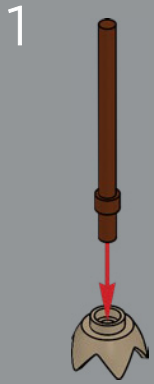

5

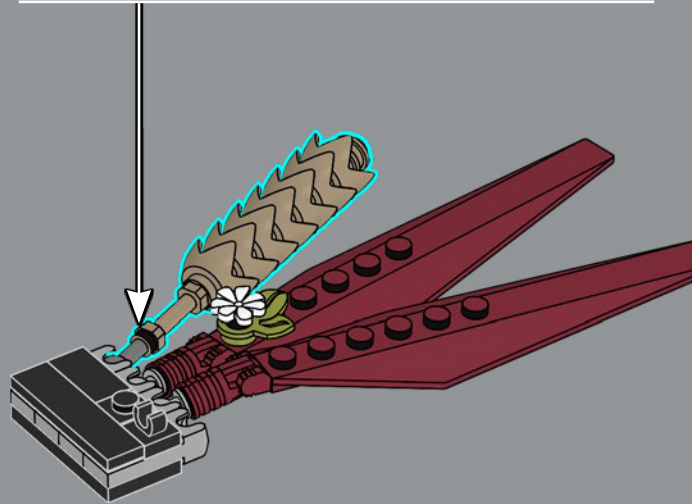
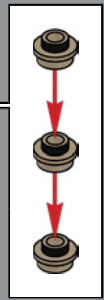

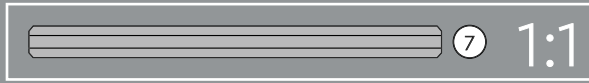
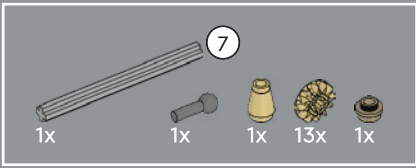

116

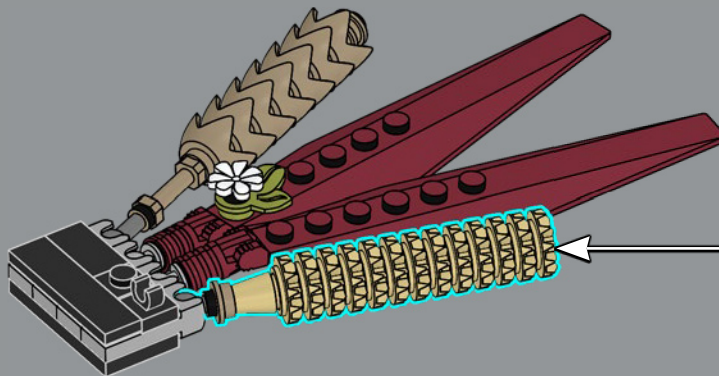
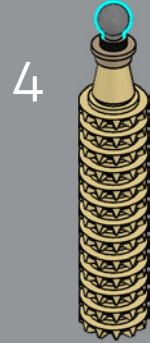
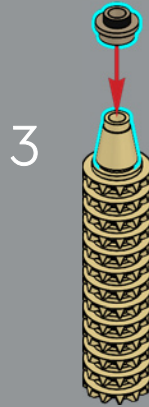
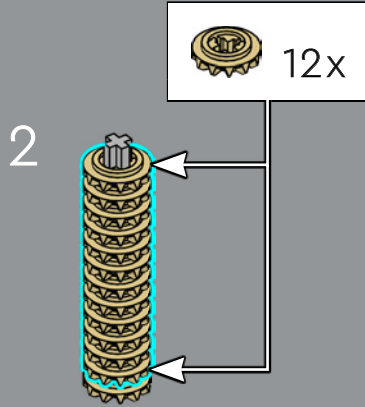



117

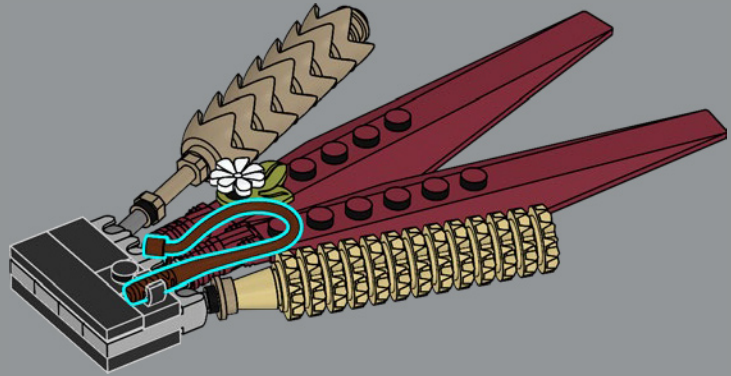

118

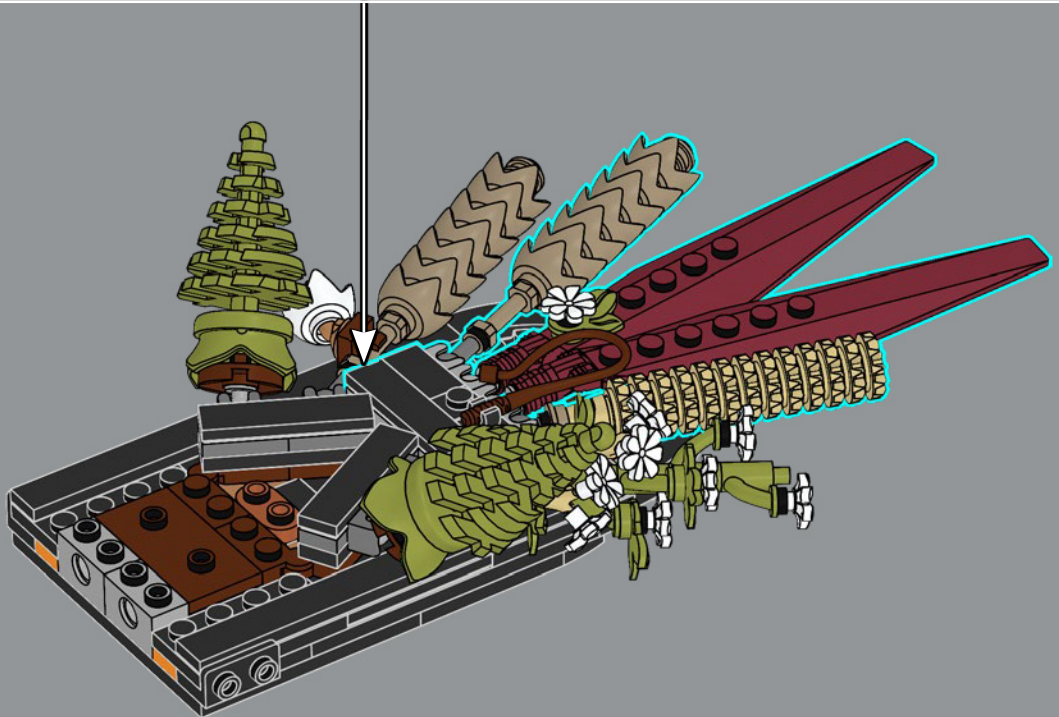

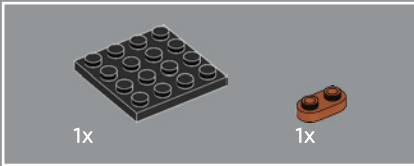
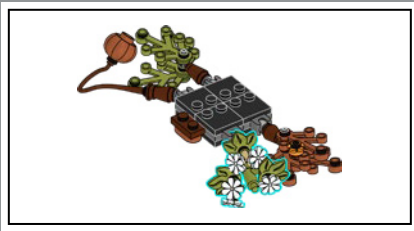

119

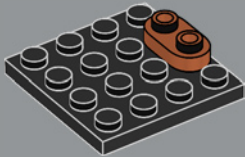

120

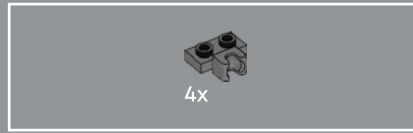
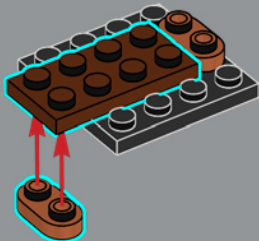

121



4x

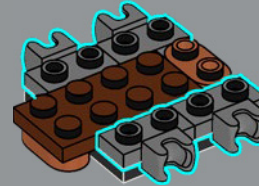

122



4x

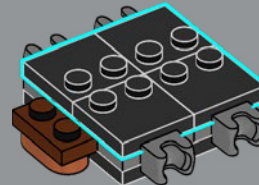

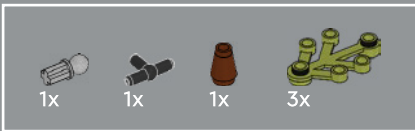

123

1

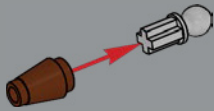

2

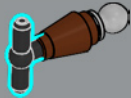

3

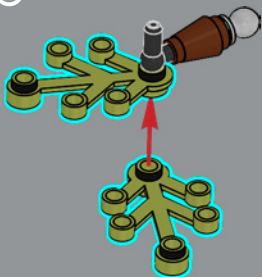

4

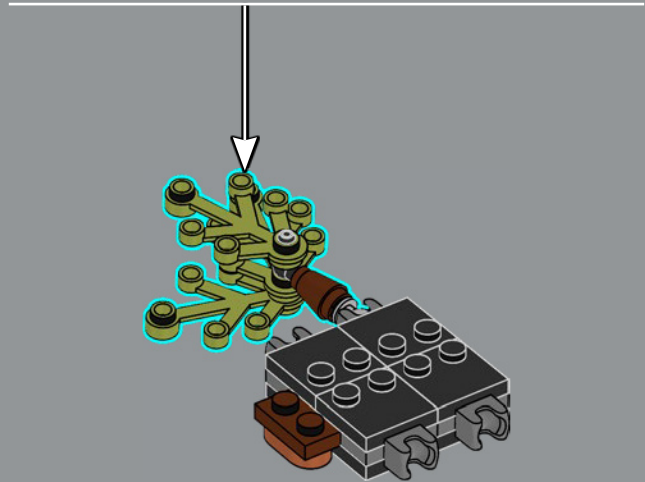
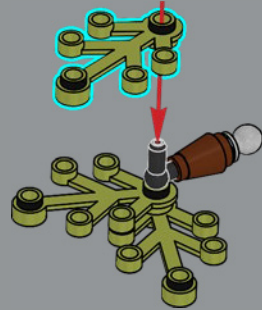



124

1

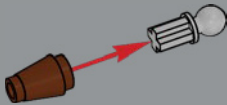

2

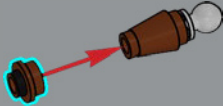

3

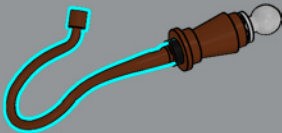

4

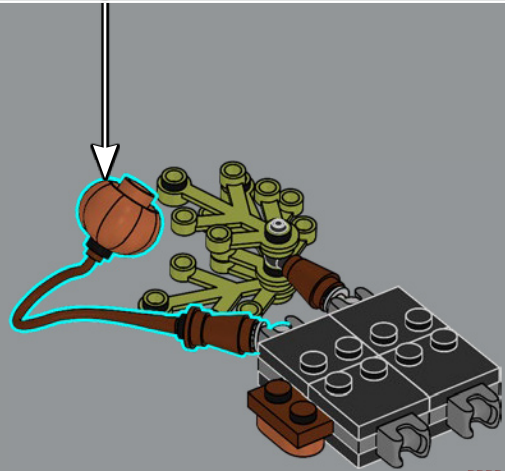
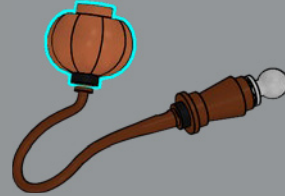

Die Lampionblume wird aus einer biegsamen braunen Peitsche sowie aus einem LEGO® Element gebaut, das sonst Kürbisse oder Laternen darstellt.





125

1

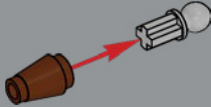

2

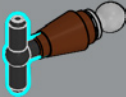

3

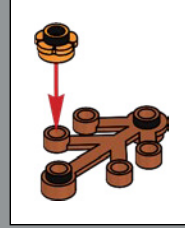
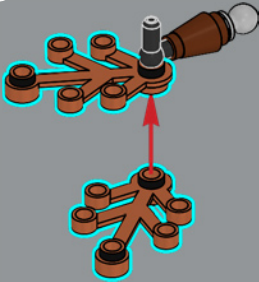

4

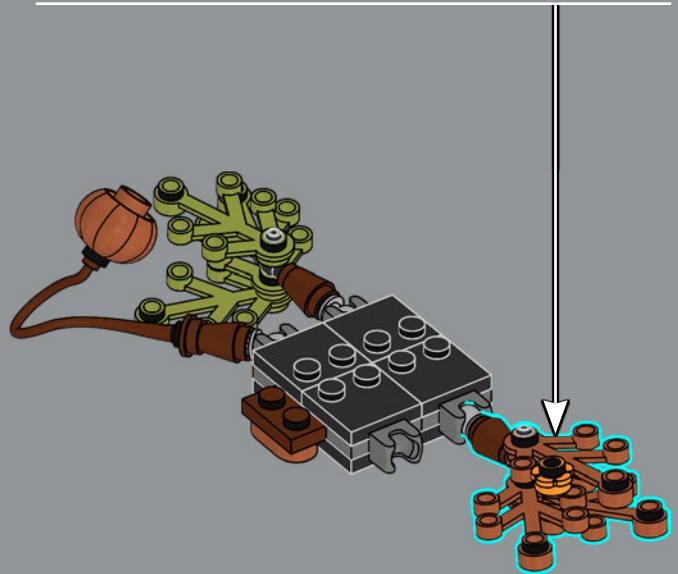
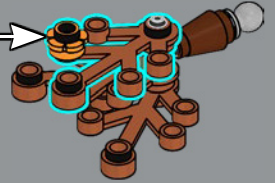

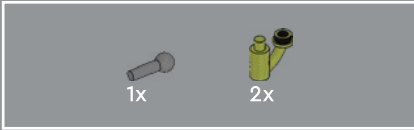
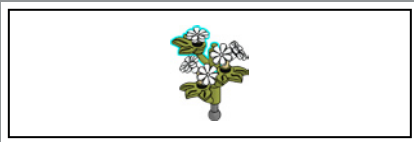

126



127

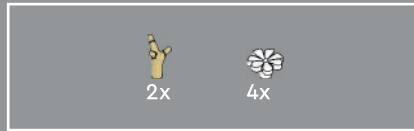
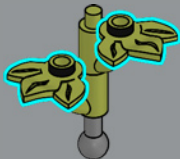

128

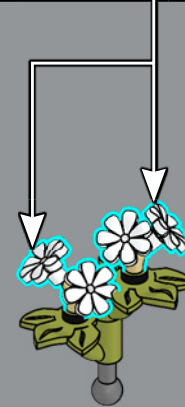
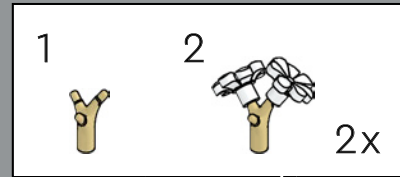

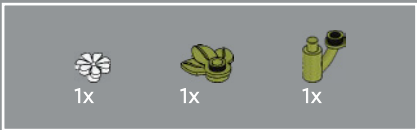

129

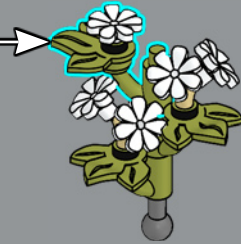
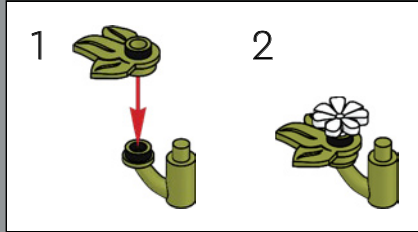

130

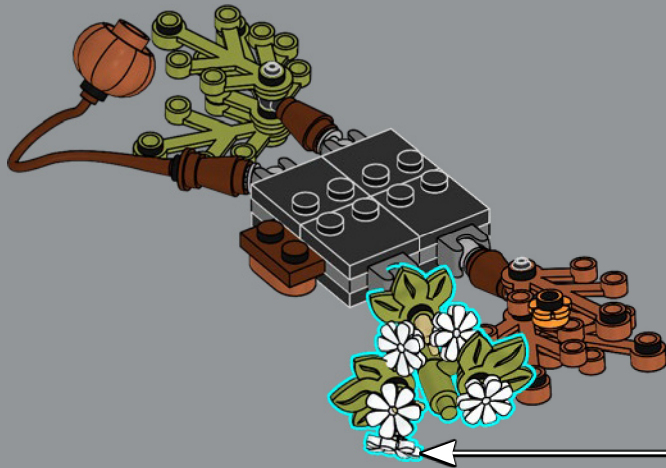

131

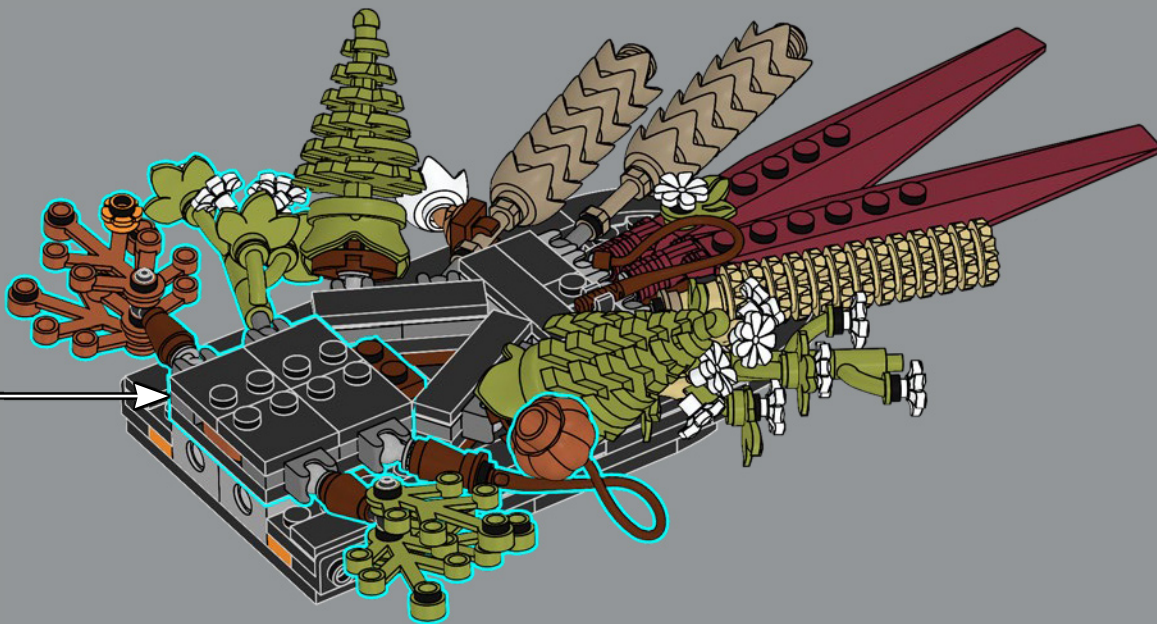

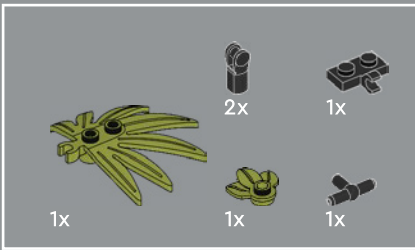

132

1

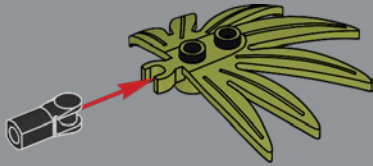

2

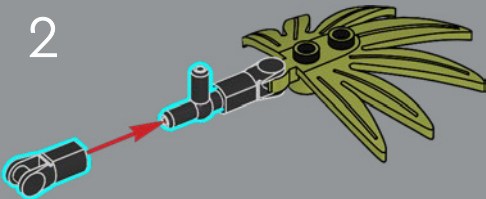

3

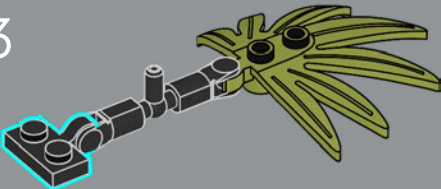

4

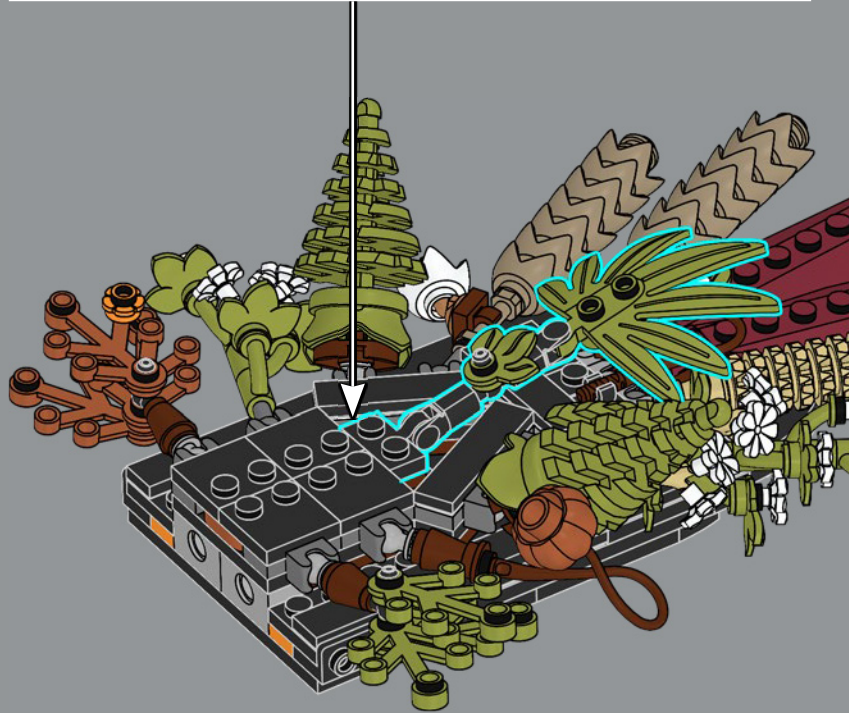
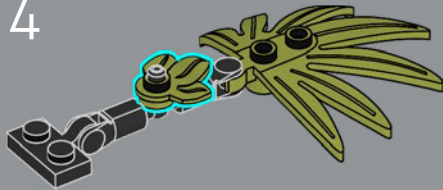

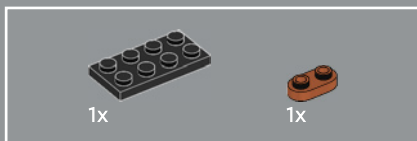
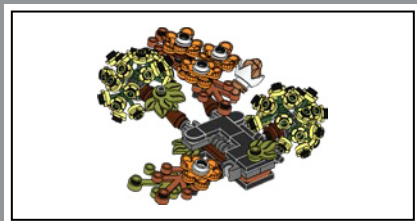

133

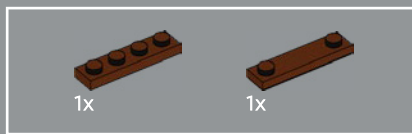
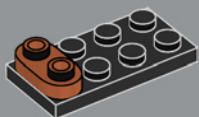

134

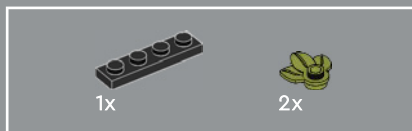
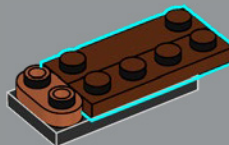

135

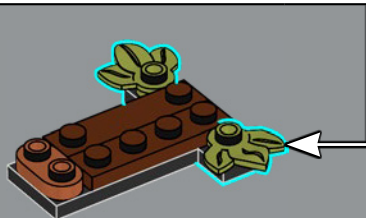
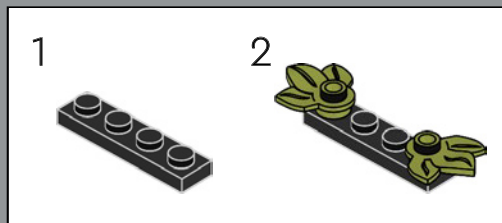

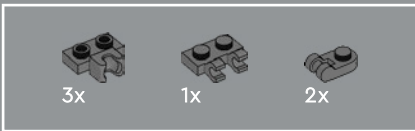

136

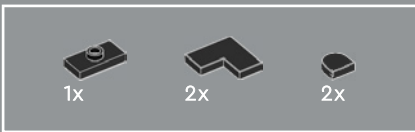
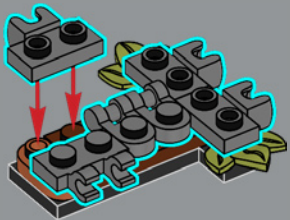

137

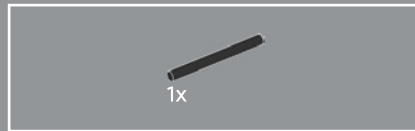
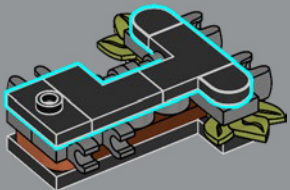

138

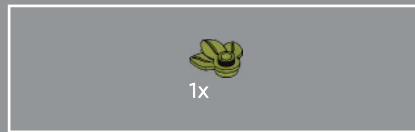
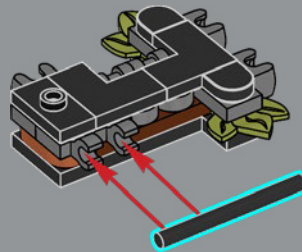

139

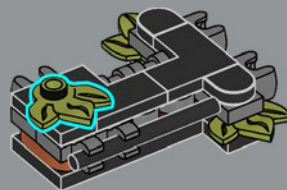

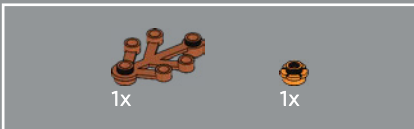
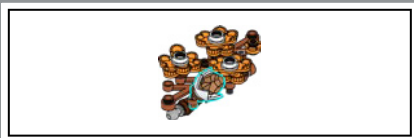

140

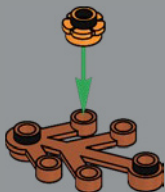

141

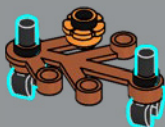

142

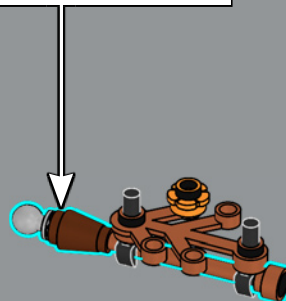
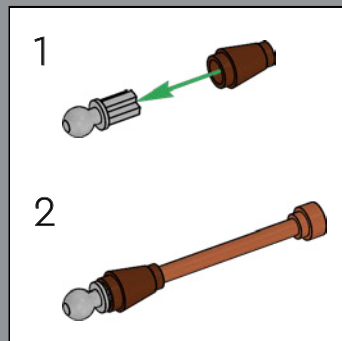

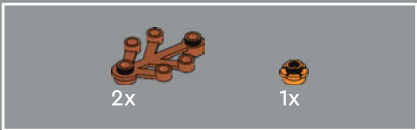

143

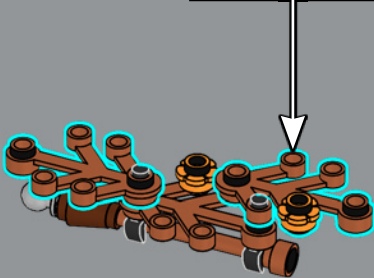
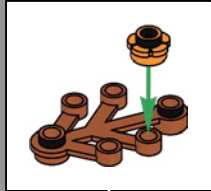

144

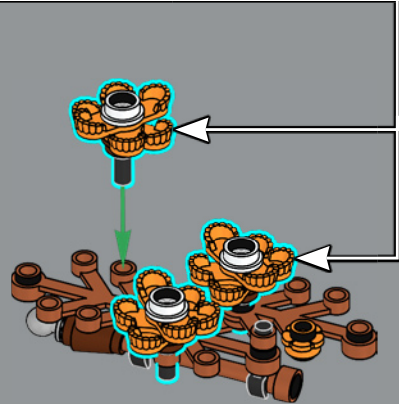
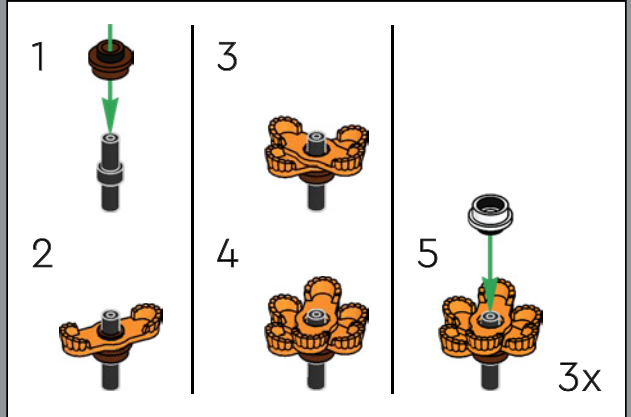



1x



1x



1x

145

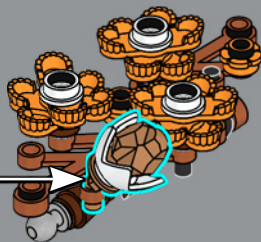
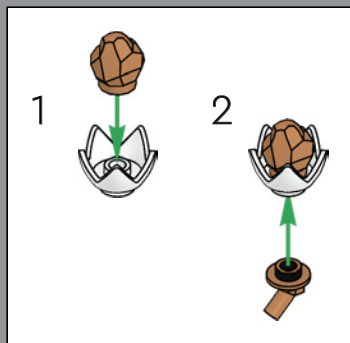

Die getrockneten Gänseblümchen werden aus einer weißen Krone und einem seltenen Felselement gebaut, das ursprünglich als Goldnugget diente.

146

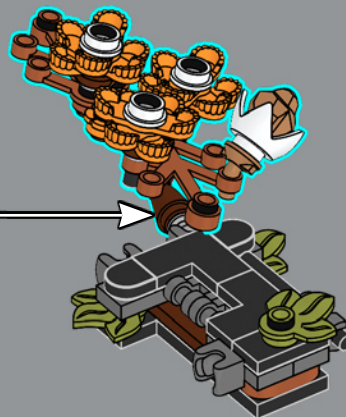

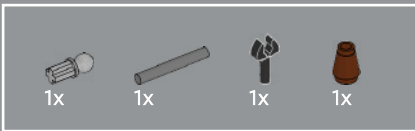

147

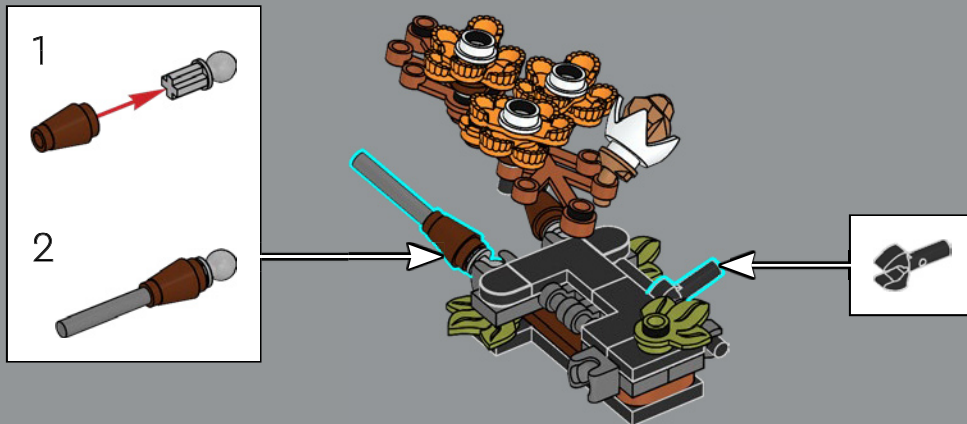



148

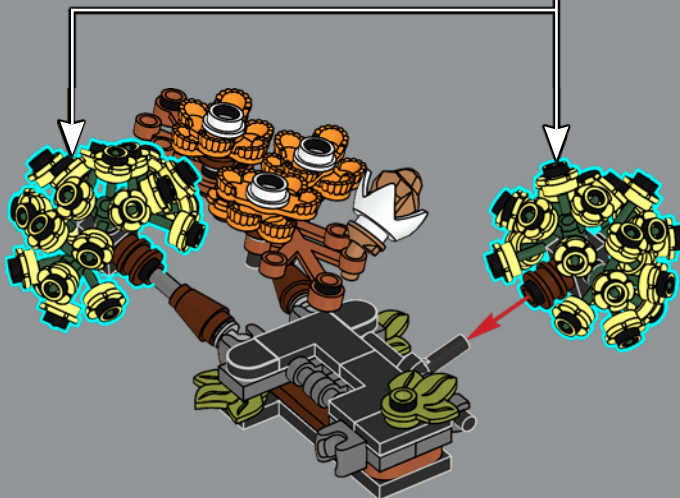
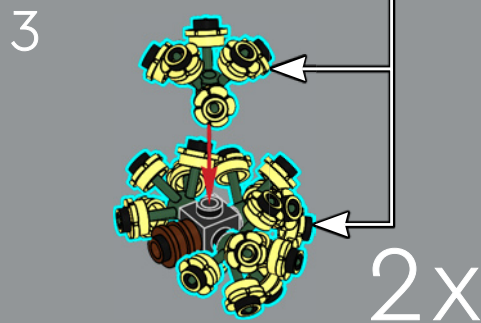
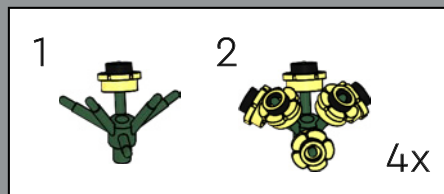
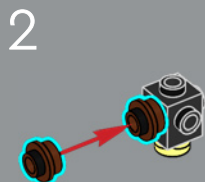
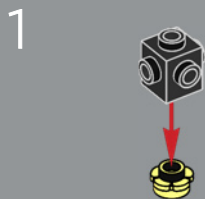



1x



2x

149

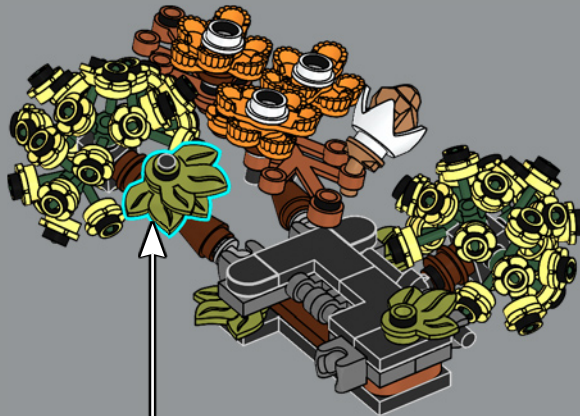

1

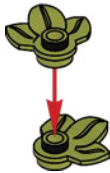

2



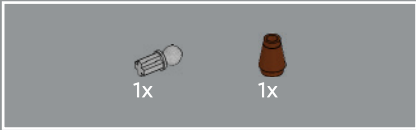

150

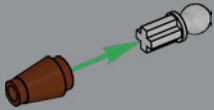

151

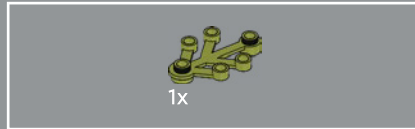
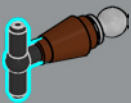

152

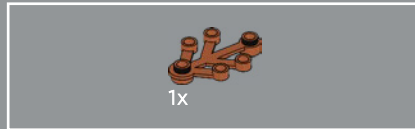
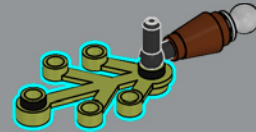

153

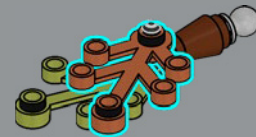

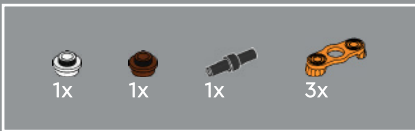

154

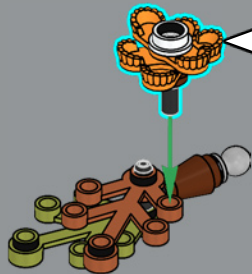
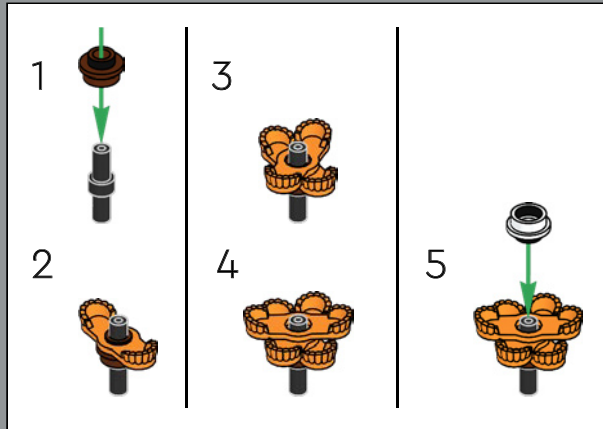

155

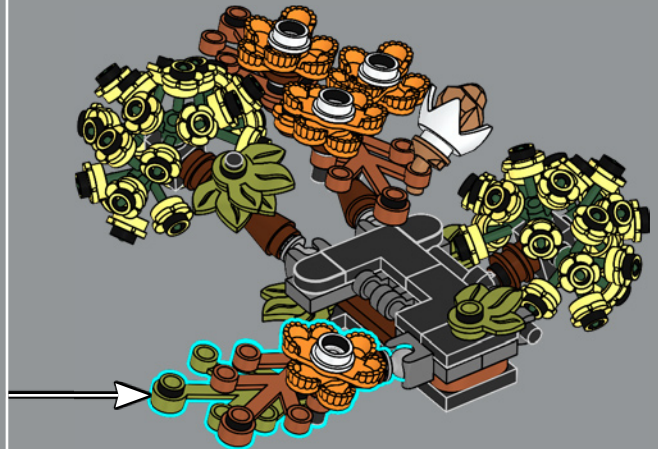

156

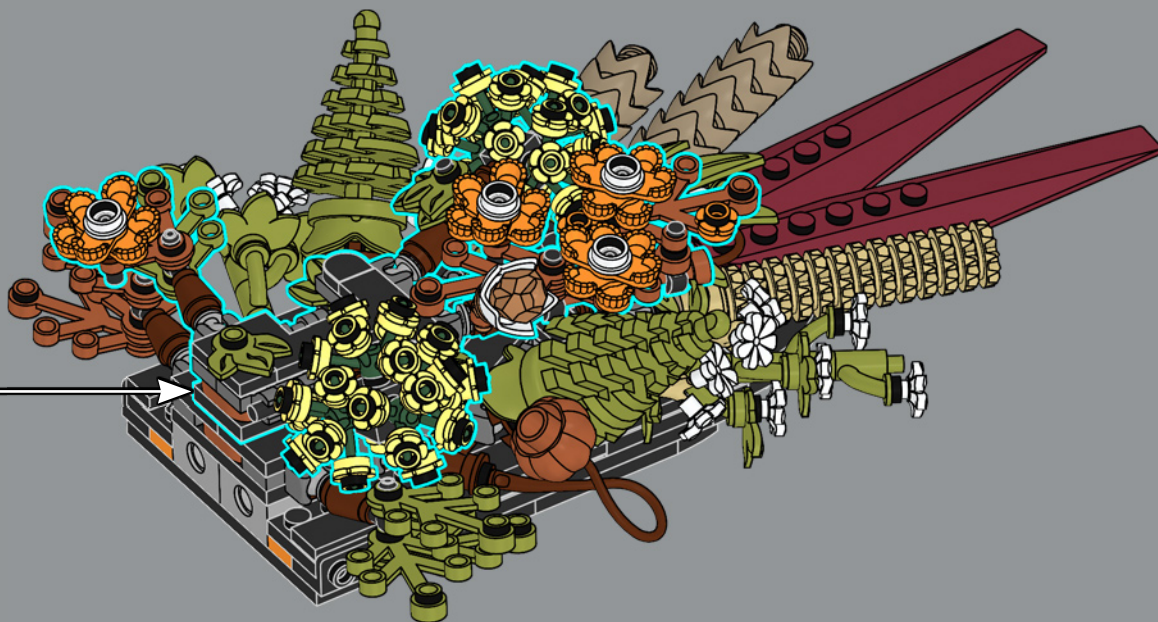

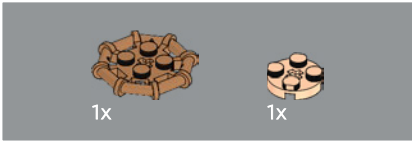
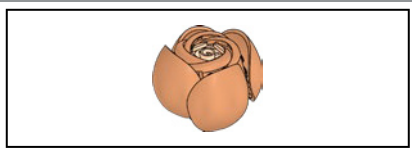

157

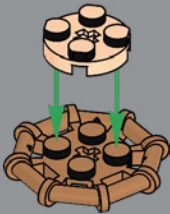

158



159

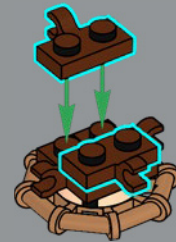

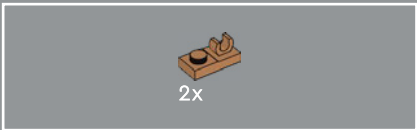

160

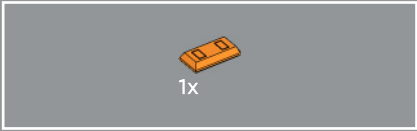
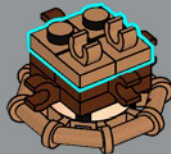

161

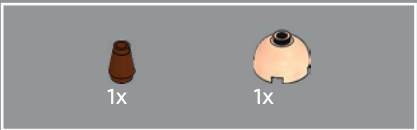

162

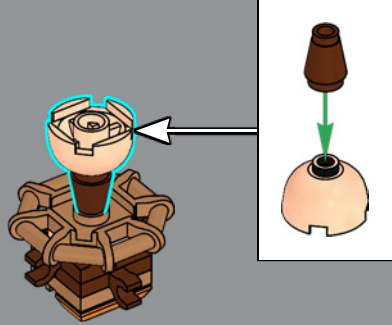

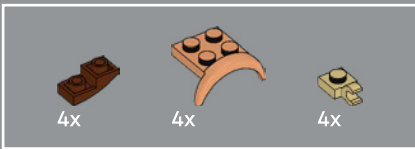

163

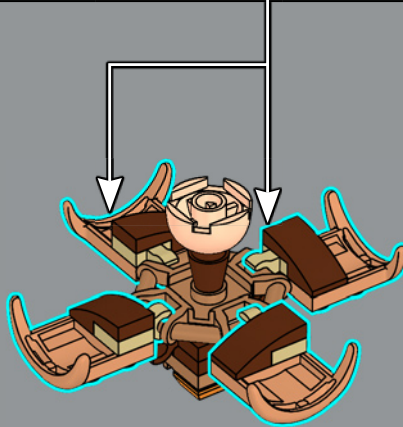
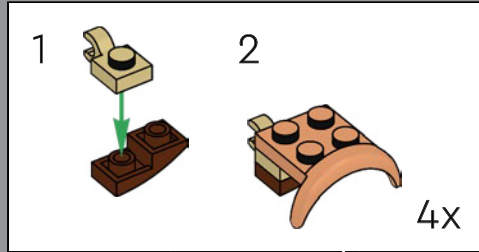

164

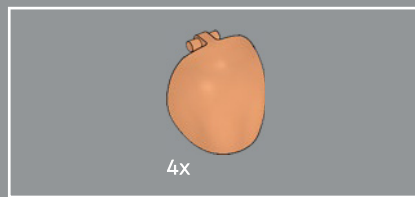
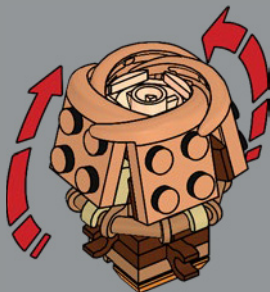

165

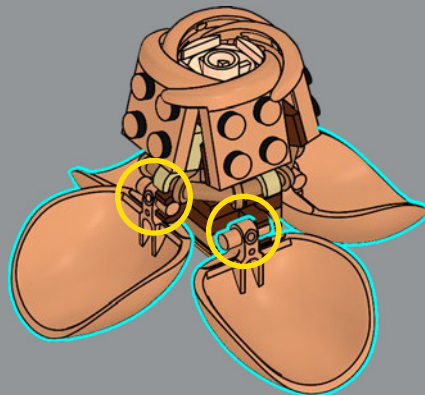

166

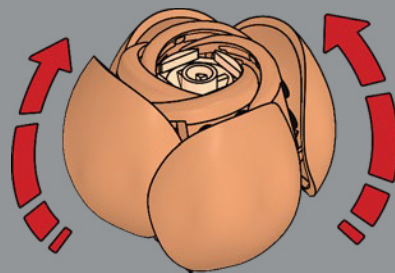



Aus neuen Schmutzfängern (innen) sowie neuen Muscheln (außen) lässt sich die filigrane Rosenblüte zusammensetzen.

167

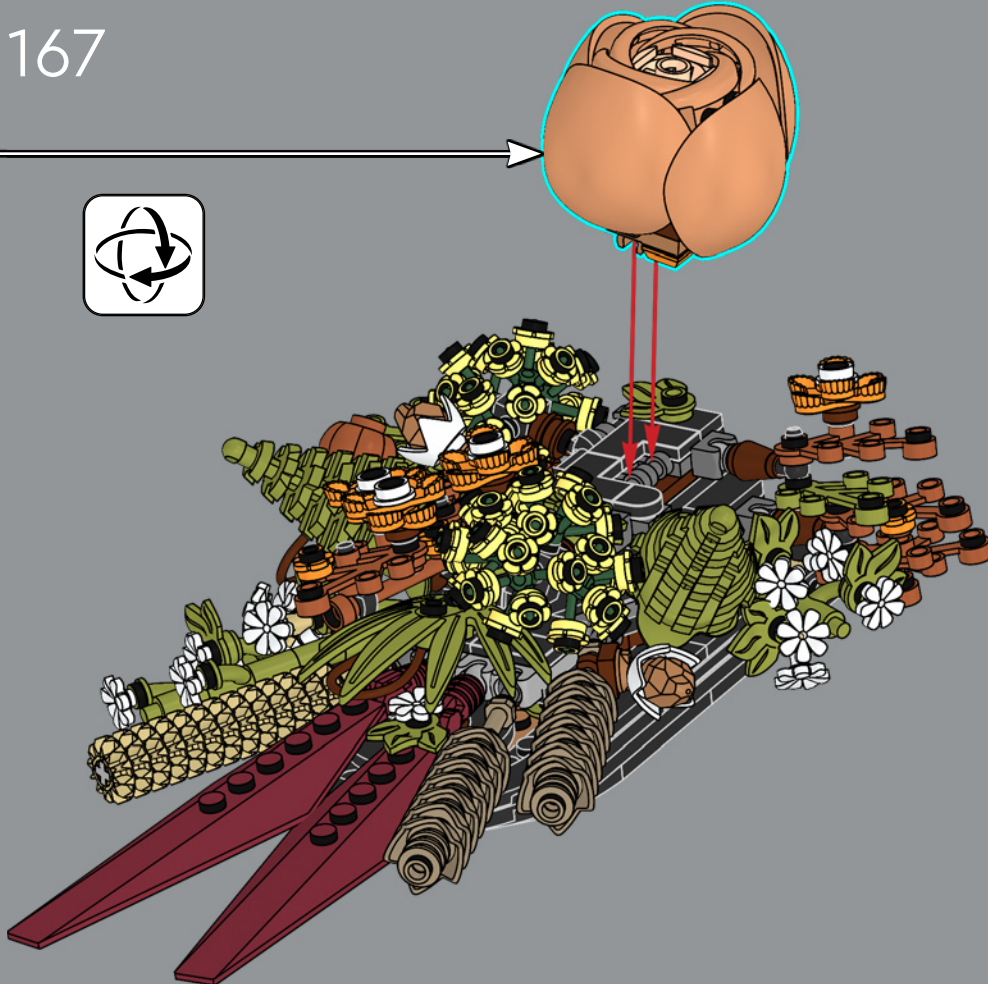



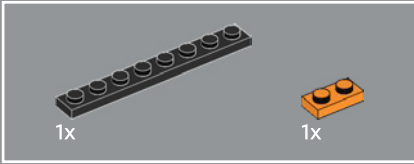

168

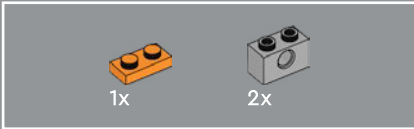
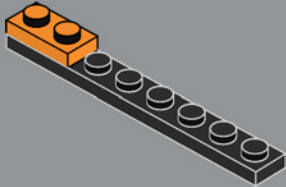

169

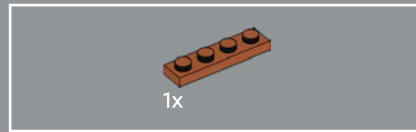
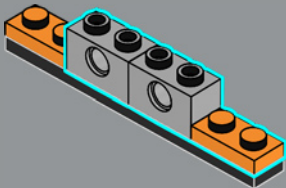

170

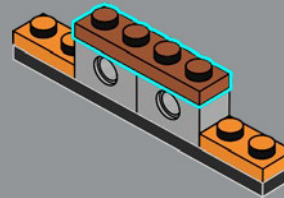

171

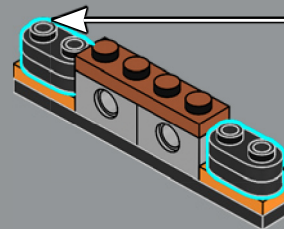
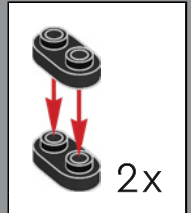



172

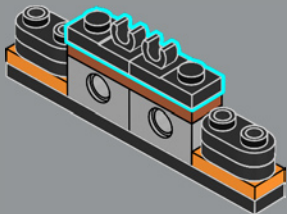

173

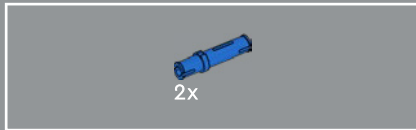
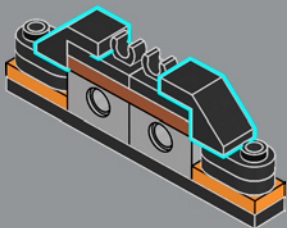

174

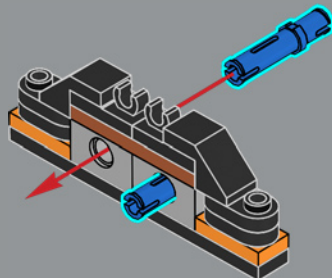



175

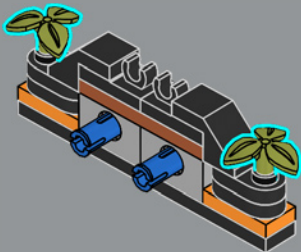

176

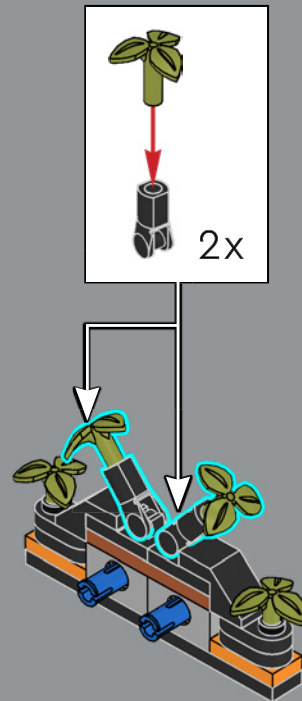

177

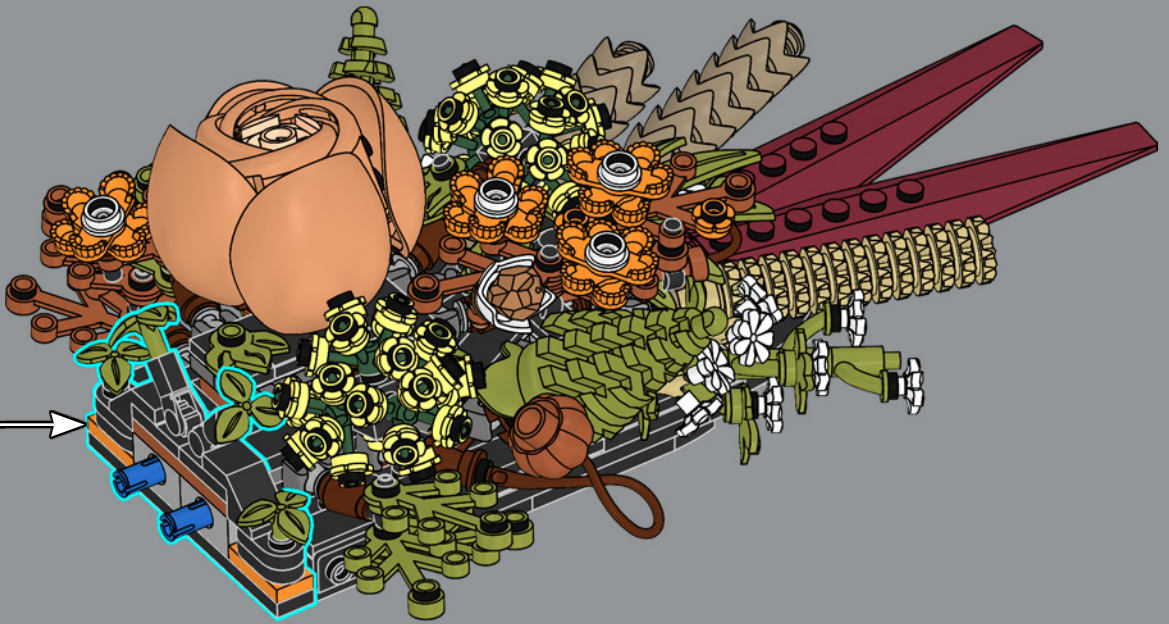



Manchmal werden Trockenblumen mithilfe einer dünnen Wachsschicht haltbar gemacht. Die glänzenden Elemente aus diesem Set sollen diese Wachsschicht nachbilden.

178

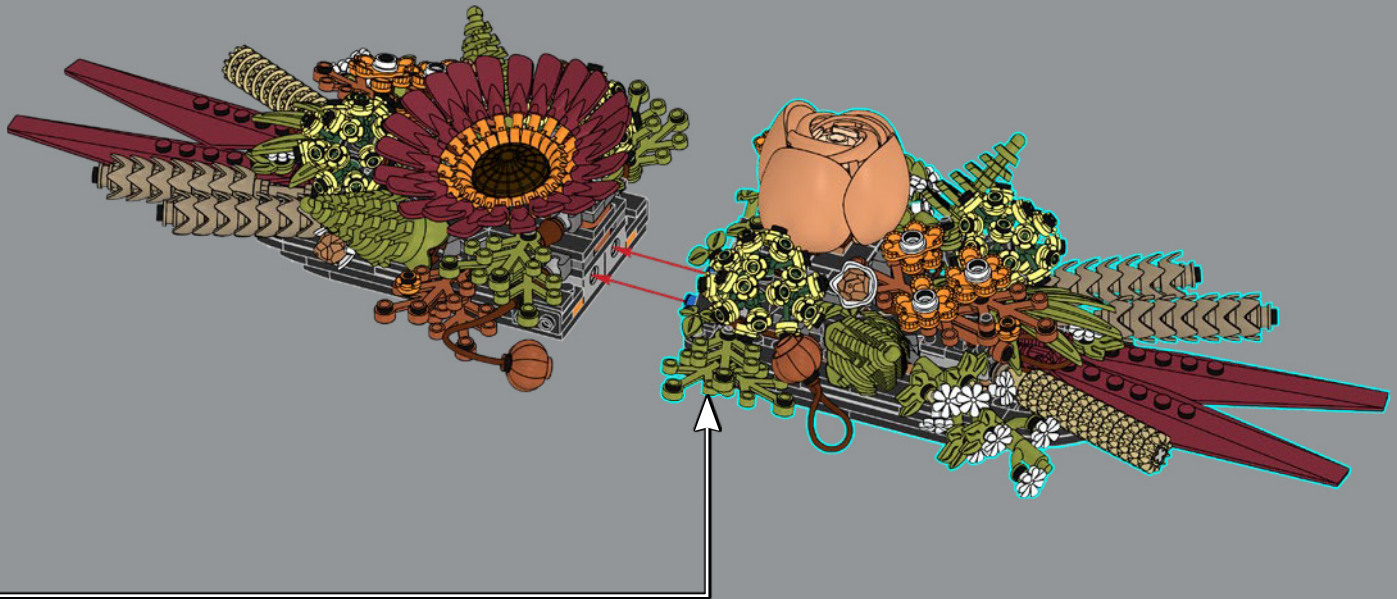

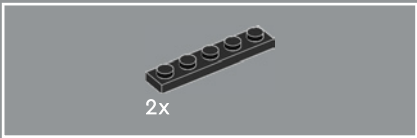

179

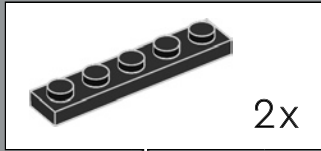

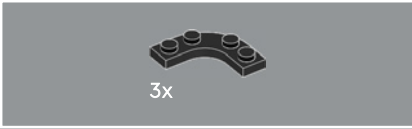
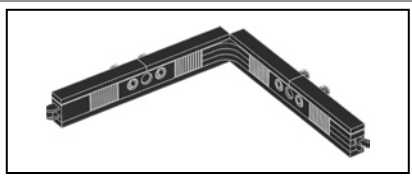

180

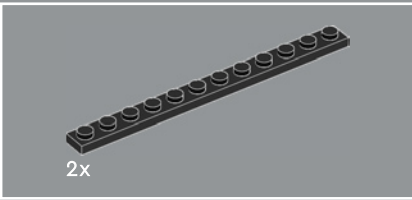
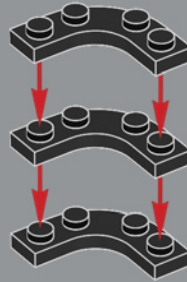

181

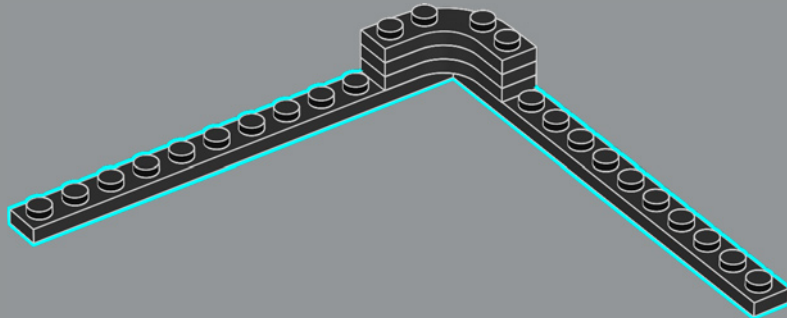

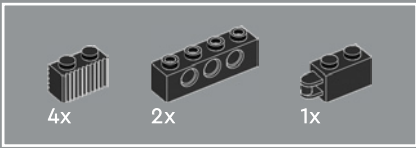

182

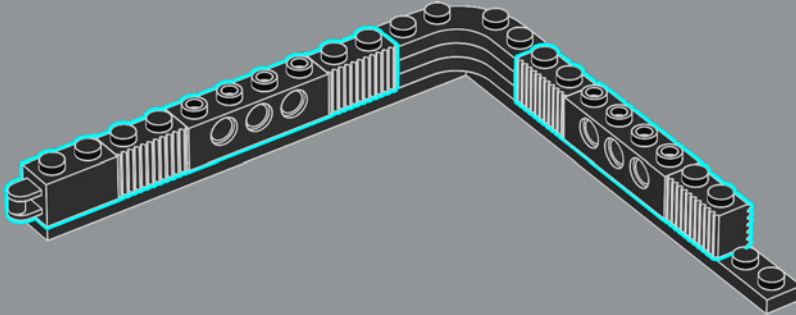

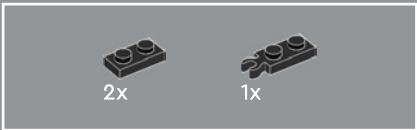

183

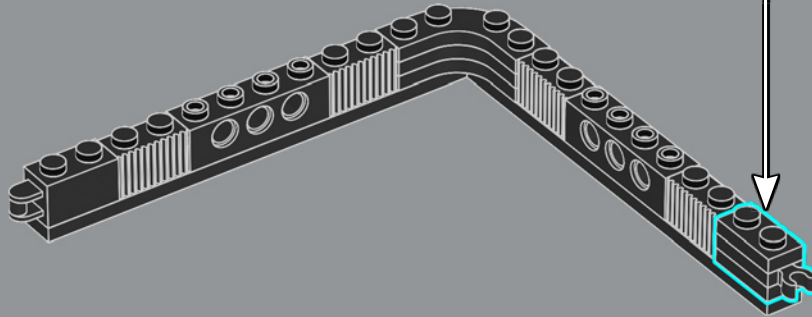
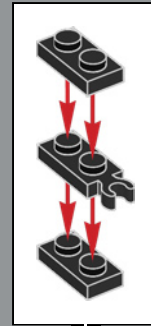

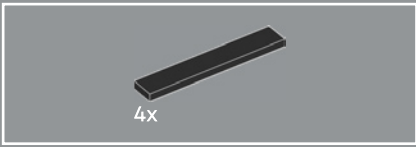

184

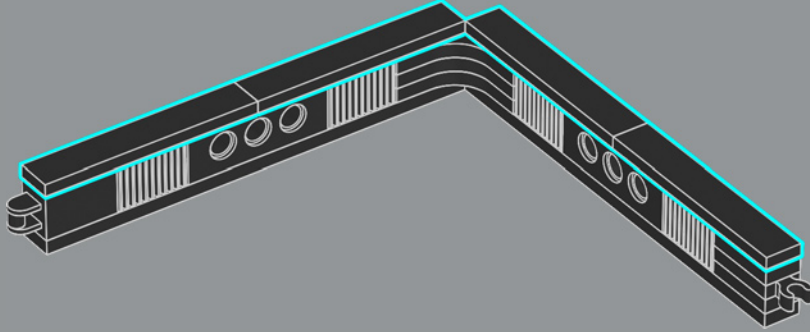

185

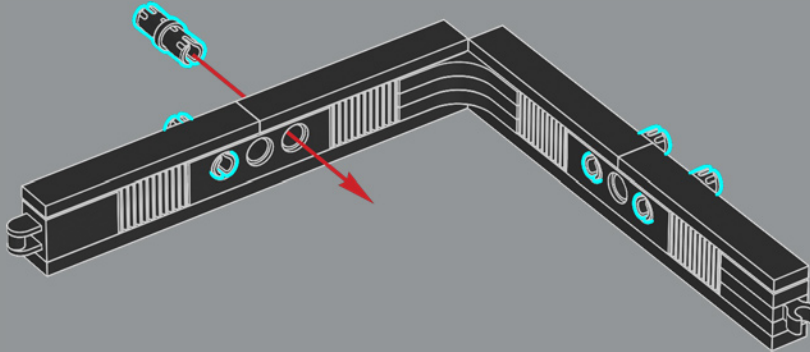

186

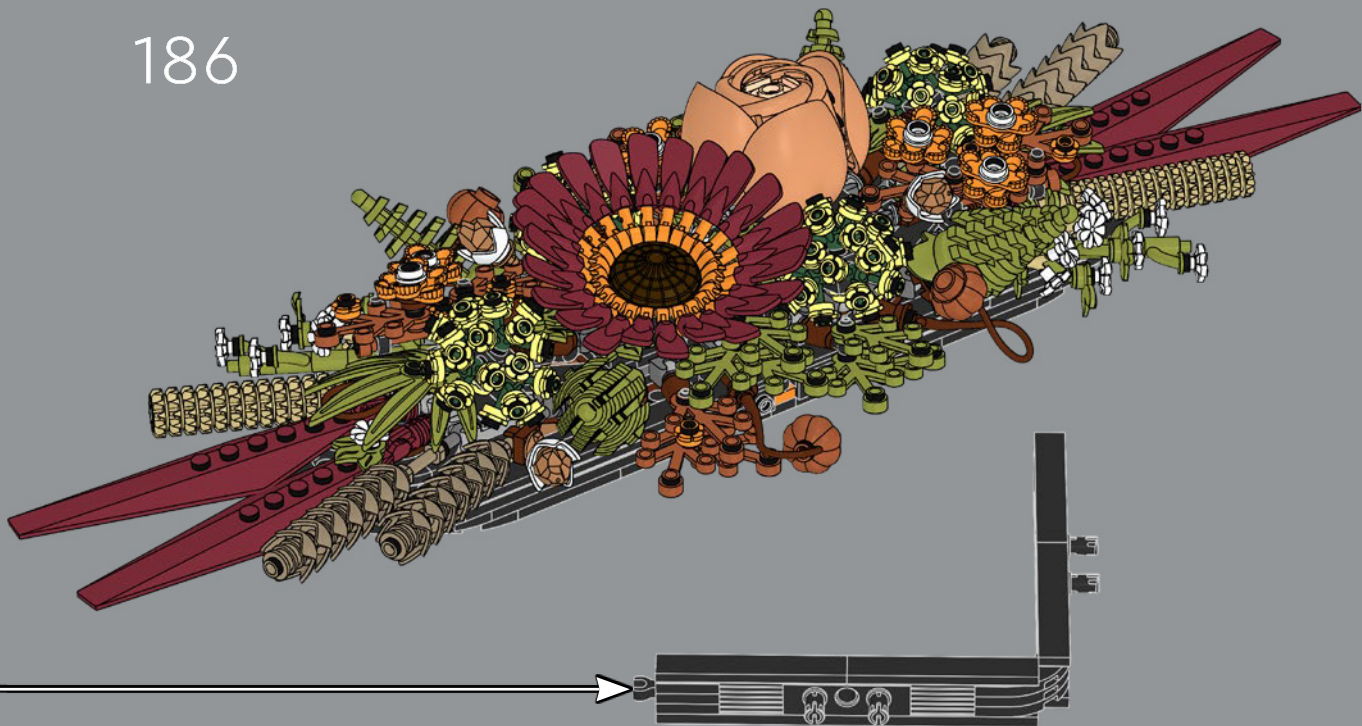



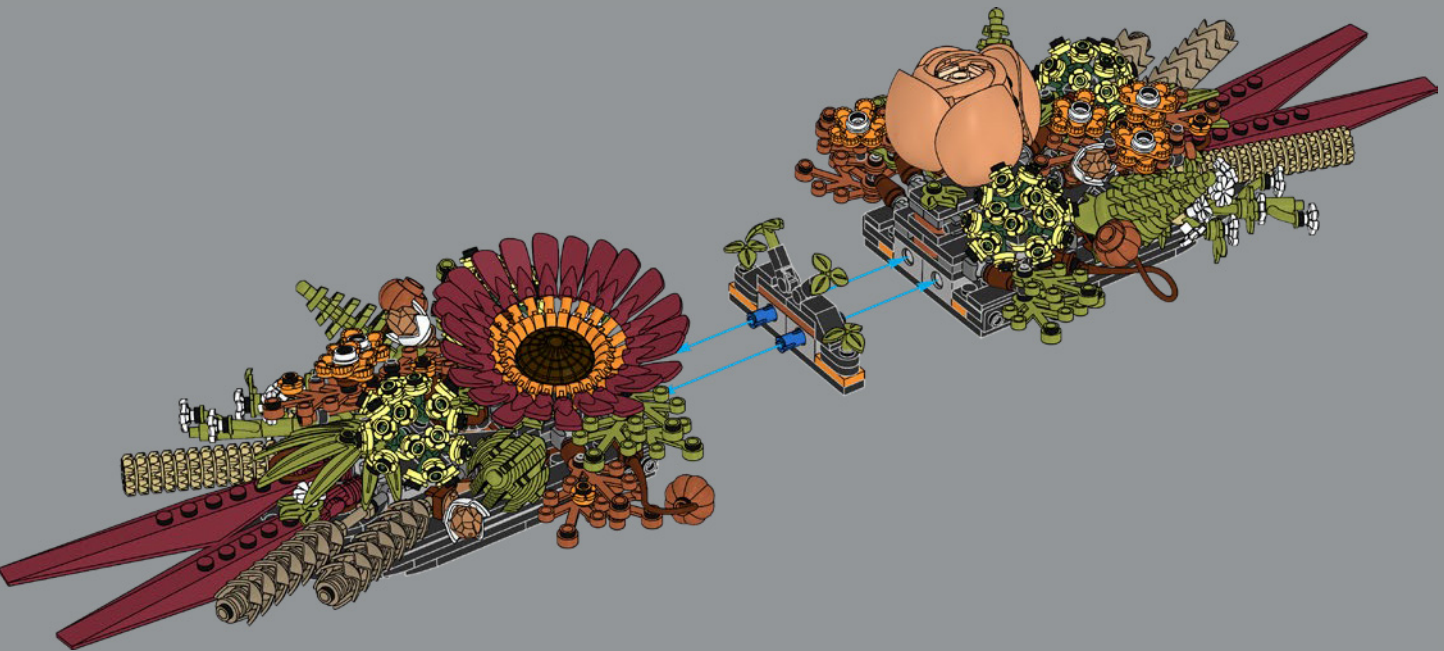

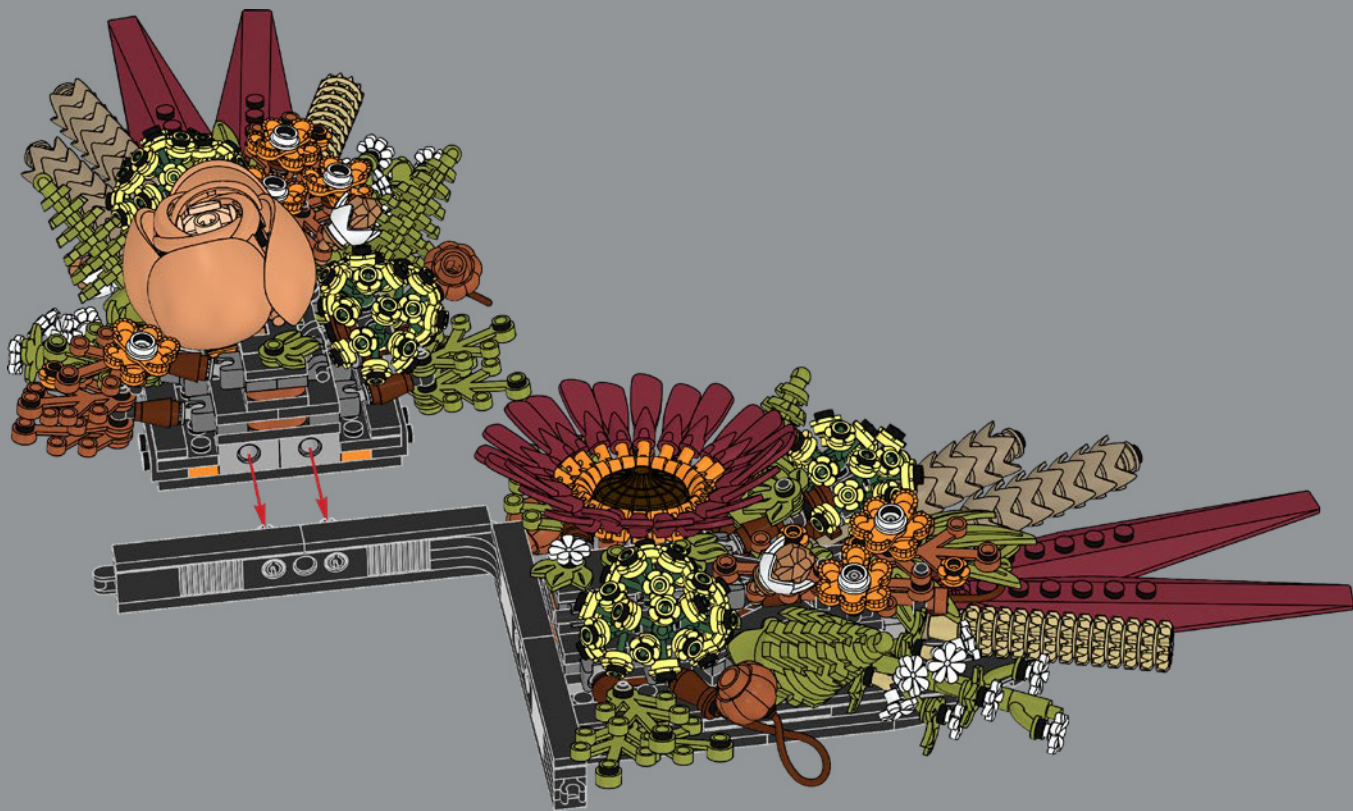



3 x 10314

