



STAR WARS



9679



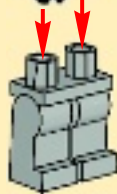
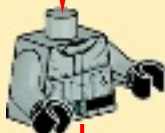

2



1x



1x

1





2x

2

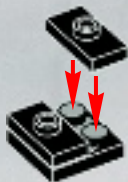

1x

3





1x



1x

4

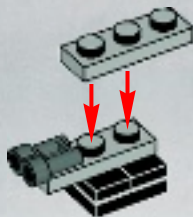

4



1x



2x

5

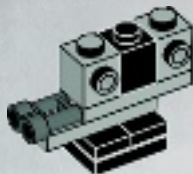



1x



1x

6

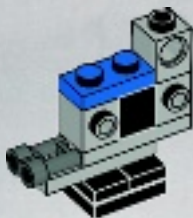

1x



1x

7

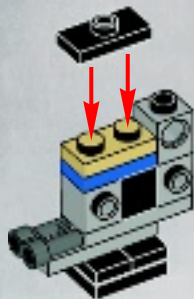



1x



1x



1x



1x

8



1

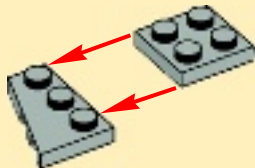

2

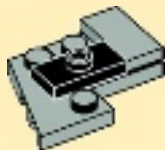



1x



1x

9

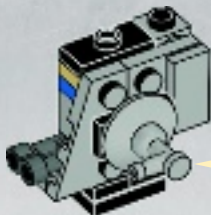
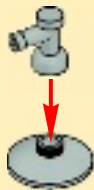



1x



1x



1x



1x

10

1

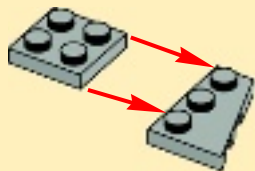

2





1x



1x

11

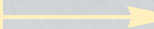
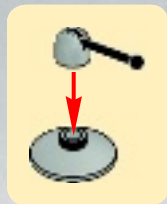



1x

12

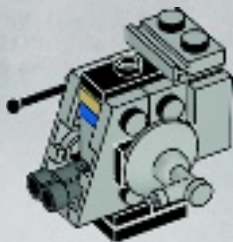



1x



1x

13

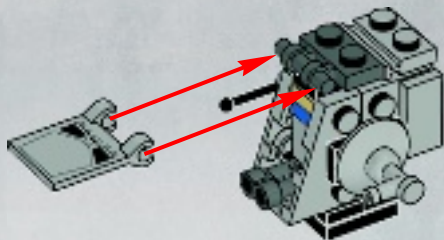



1x

14

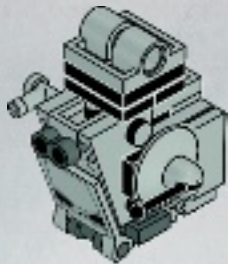

12



2x

15

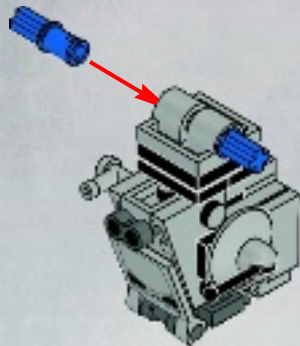



2x



1x



1x

1



1x



1x

2

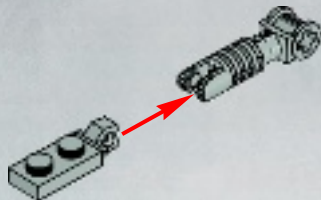



1x

3

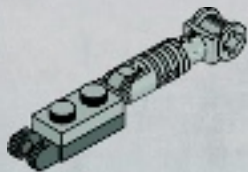

14



1x



1x

4

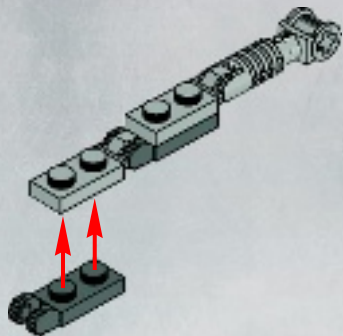



1x

5

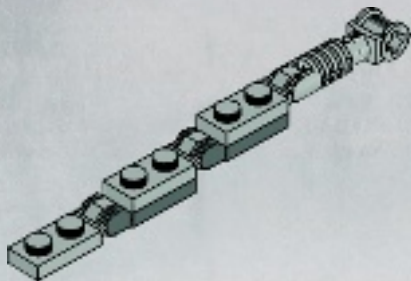

1x

6

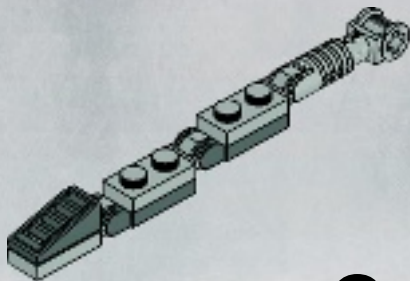

2x

16

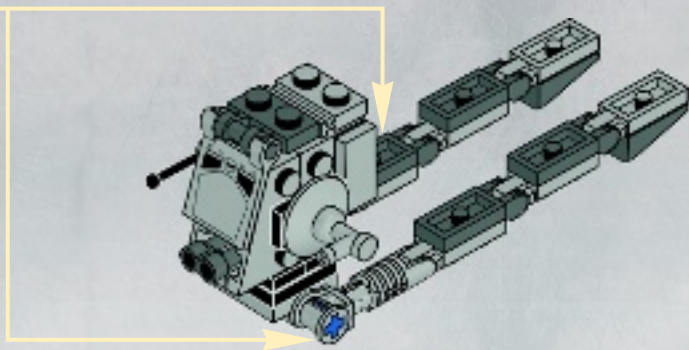

17

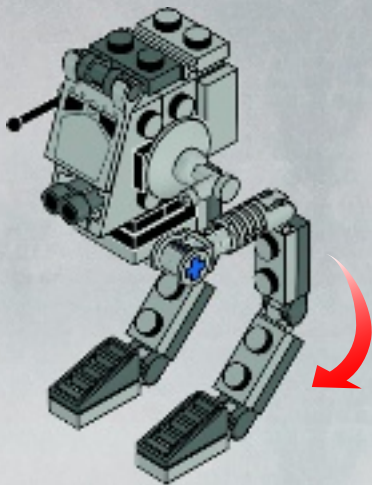



1x



1x

1

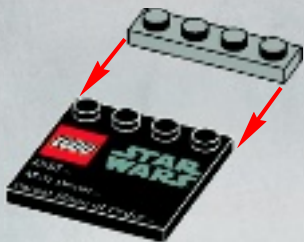

1x

2





1x

3





1x

4

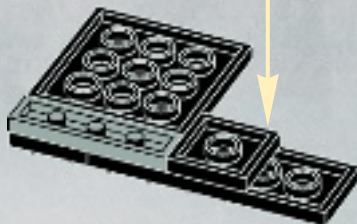



1x

5





1x

6

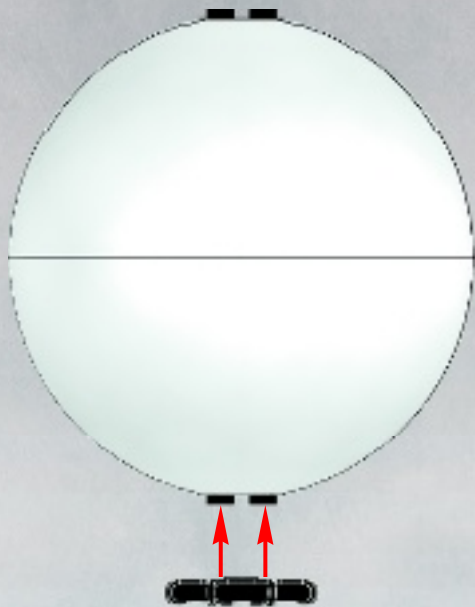

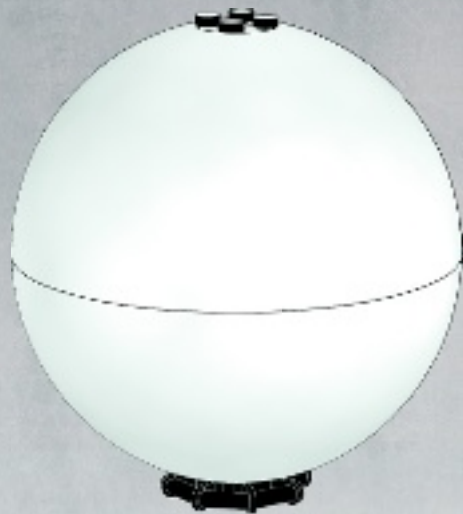



1x

7

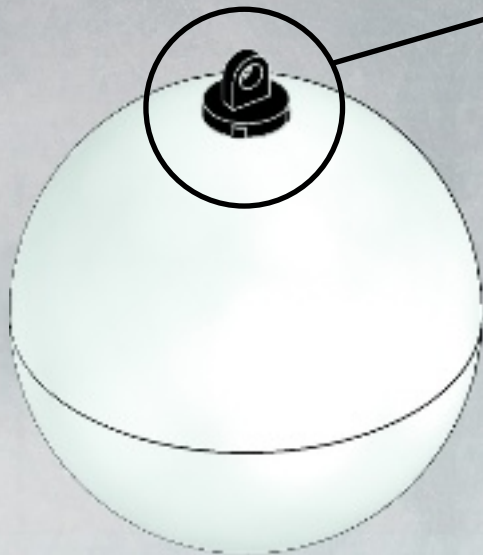

1x
302323



2x
4206482

2x
302226

1x
4609050

5x
379426

1x
300526

2x
379526

1x
4655302

1x
368026

1x
4514342

2x
4109810

1x
237626

1x
4211535



2x
4211397



2x
4211429

1x
4211445

2x
4211414

1x
4211568

1x
4211794

1x
4211791

2x
4211512

1x
4211503

1x
4221775

1x
4540203

2x
4211553



6x
4211803

2x
4213567

1x
4211376

2x
4222047

1x
4655814

1x
4227657

1x
4657633

1x
4655787

1x
4113917

4x
4210884

1x
4210660

1x
4211051

2x
4540386

1x
4655922



Customer Service

Kundenservice

Service Consommateurs

Servicio Al Consumidor

www.lego.com/service or dial





9493



9492



9491



9490



9489



9488





9488



9489



9490



9491



9492



9493



9488



9489



9490



9491



9492



9493



9488



9489



9490



9491



9492



9493



9488



9489



9490



9491



9492



9493

ACE ASSAULT II



0704



STAR
WARS

starwars.LEGO.com



STAR WARS III

THE CLONE WARS™



LucasArts and the LucasArts logo are registered trademarks of Lucasfilm Ltd. © 2005-2010 Lucasfilm Entertainment Company Ltd. or Lucasfilm Ltd. & ® or TM as indicated. All rights reserved. LEGO, the LEGO logo and the Minifigure are trademarks of The LEGO Group. © 2005-2010 The LEGO Group. All rights reserved.



STAR WARS™

BATTLE OF HOTH™

© 2012 Lucasfilm Ltd. & TM. All rights reserved.



3566
Star Wars
8+  2/4  10-20



GAMES





www.LEGOclub.com



LEGO[®] Club Email

LEGO clubTM

FREE! GRATIS! GRATUIT!



LEGO[®] Club Magazine

SIGN UP ONLINE!

www.LEGOclub.com

00800 5346 5555*



1-866-534-6258 • 1-877-518-5346

1-800-534-6258

Canada (toll-free)

B1110

- * Freephone. Mobile charges may apply.
- * Numéro sans frais. Des frais peuvent s'appliquer avec les téléphones cellulaires.
- * Gebührenfrei, Kosten für Anrufe aus Mobilfunknetzen können abweichen.
- * Gratis telefoonnummer vanaf vaste lijn.
- * Det er et gratis nummer, når du ringer fra fasttelefon.
- * Det är gratis, när du ringer från en fast telefon.
- * Numéro sans frais. Des frais peuvent s'appliquer avec les téléphones portables.



WIN!

Go to www.LEGOsurvey.com/product to fill out a survey for a chance to win a cool LEGO® Product.

No purchase necessary.

Open to all residents where not prohibited.



www.LEGO.com



www.LEGOsurvey.com/product

GEWINNE!

Nimm an der Umfrage auf www.LEGOsurvey.com/product teil und hab die Chance ein cooles LEGO® Produkt zu gewinnen! Die Teilnahme am Gewinnspiel führt zu keinerlei Kaufverpflichtungen. Teilnahme in allen nicht ausgeschlossenen Ländern möglich.

WIN!

Ga naar www.LEGOsurvey.com/product, vul een enquêteformulier in en maak kans op een cool LEGO® product. Geen aankoopverplichting. Iedereen mag deelnemen, uitgezonderd ingezetenden van landen waar een enquêteverbod geldt.

GAGNE !

Visite www.LEGOsurvey.com/product pour répondre à un questionnaire et avoir une chance de gagner un produit LEGO® très cool ! Aucune obligation d'achat. Ouvert à tous les résidents des pays autorisés.

当てよう!

www.LEGOsurvey.com/product にアクセスして、アンケートにご記入ください。当選者にはレゴ®製品を差し上げます。お買い上げの必要はありません。禁止されていない限り、すべての皆様にご利用いただけます。

6003524

LEGO and the LEGO logo are trademarks of the LEGO Group. ©2012 The LEGO Group.
© 2012 Lucasfilm Ltd. & TM. All rights reserved.