



WARNING: CHOKING HAZARD.
Small parts. Not for children under 3 years.



BIONICLE

MAKING
TOA MUPARU

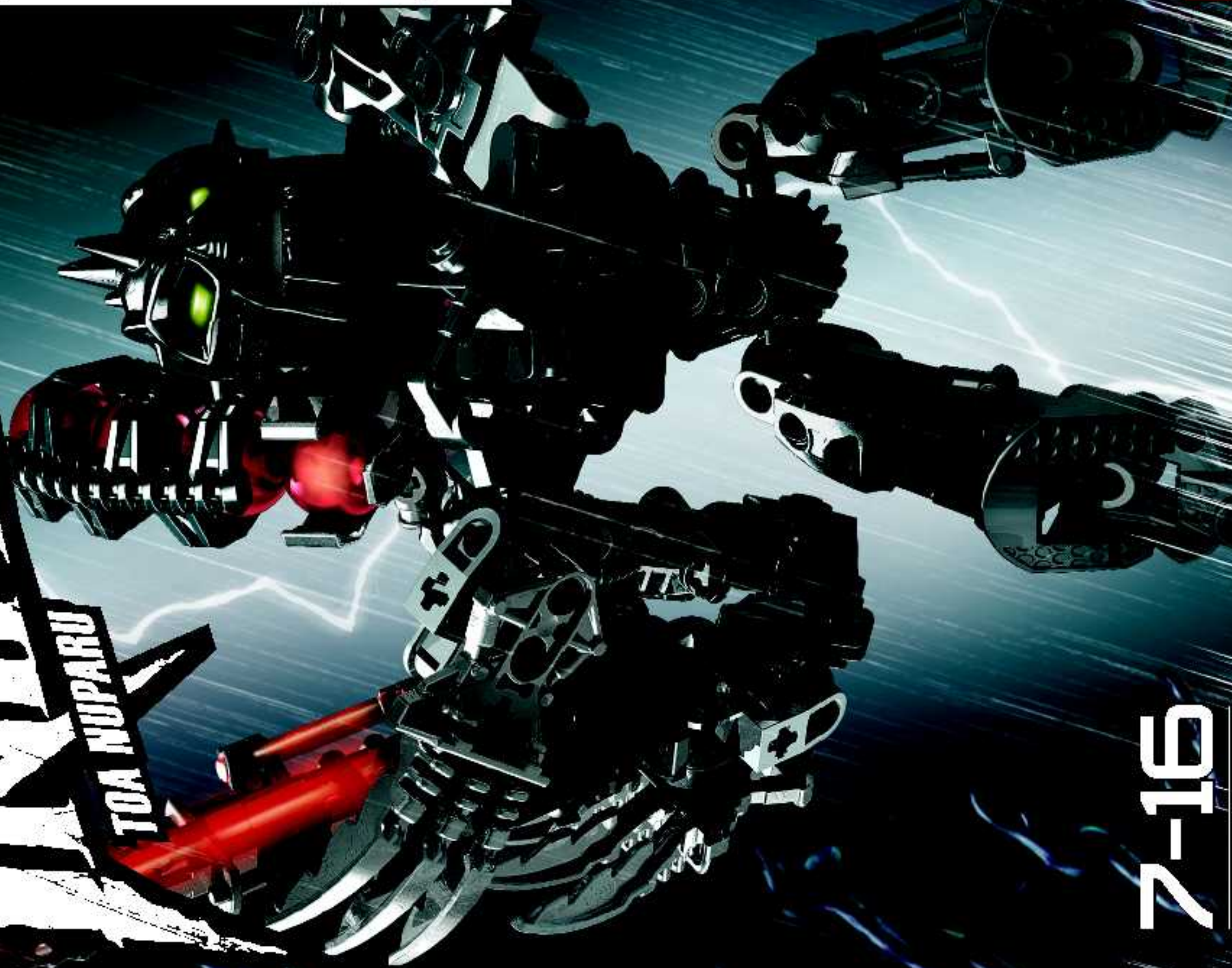

7-16

8728

1



2



AVERTISSEMENT : RISQUE D'ÉTOUFFEMENT.
Contient des petites pièces. Ne convient pas aux enfants de moins de 3 ans.



ADVERTENCIA: PELIGRO DE ASFIXIA.
No recomendado para niños menores de 3 años. Contiene piezas pequeñas.

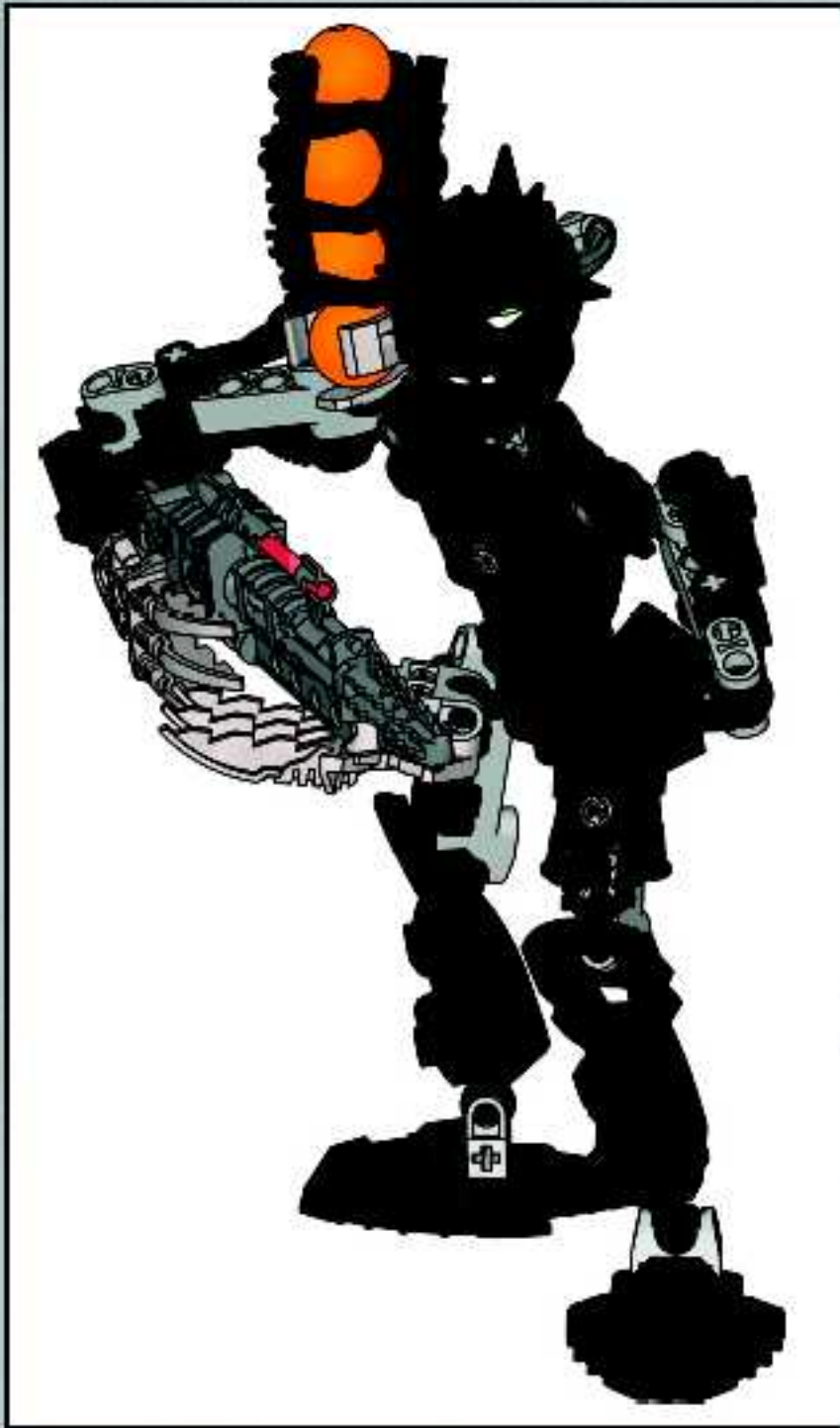



2

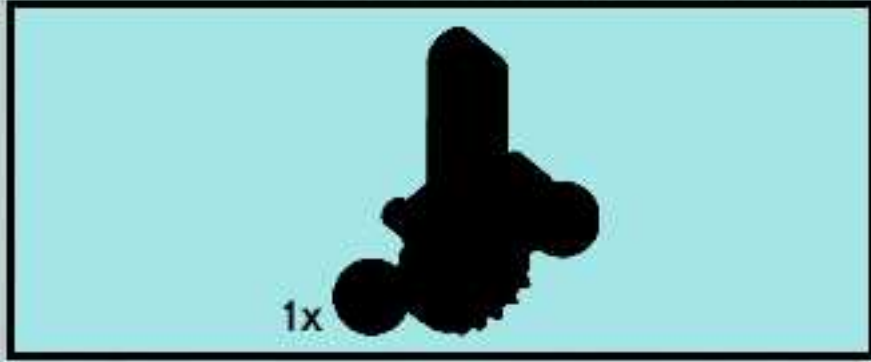

3



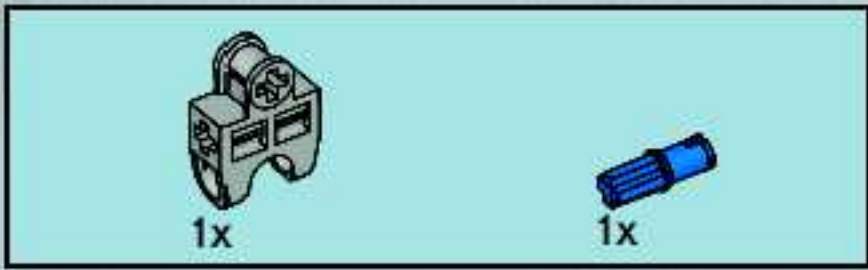

4

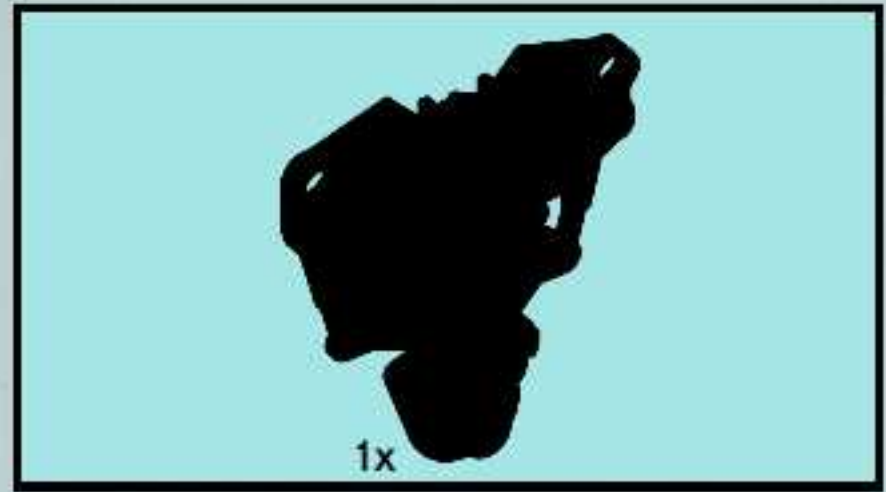
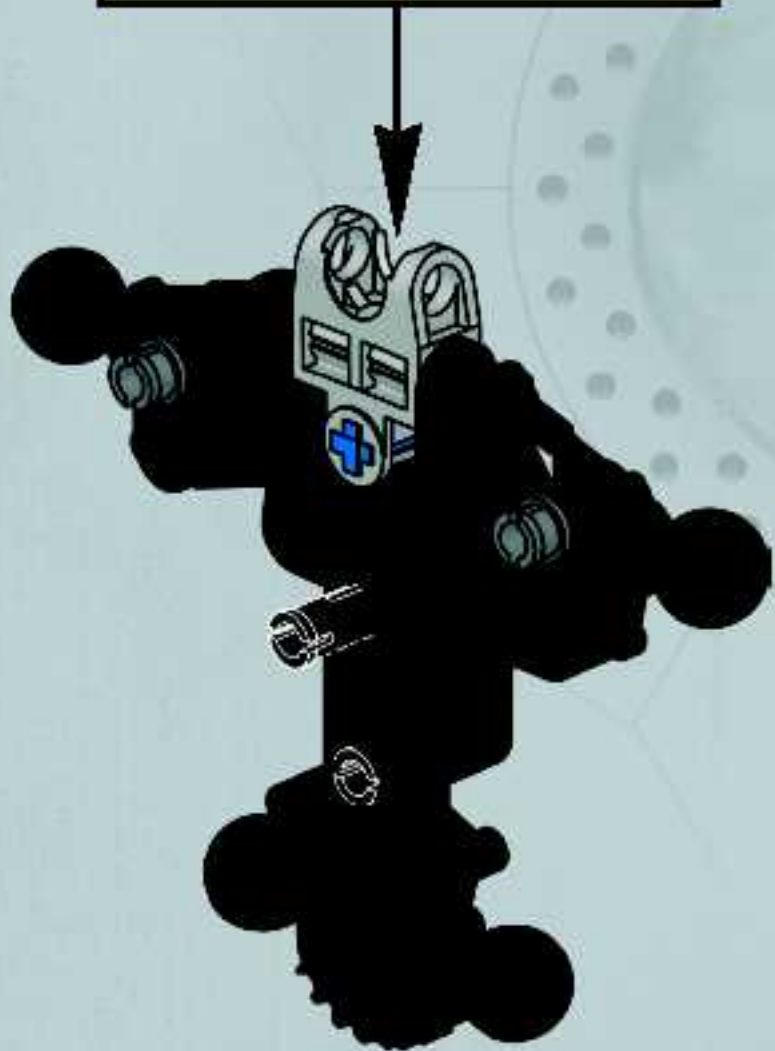
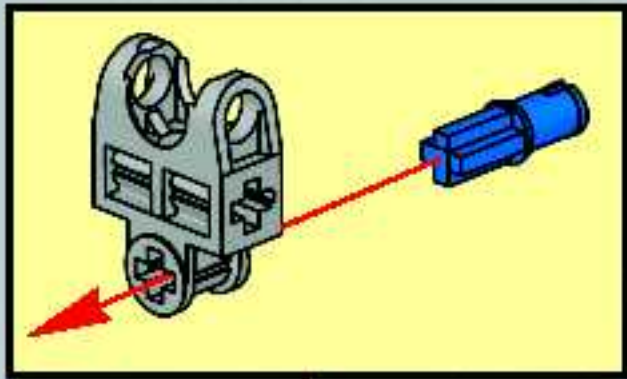

5



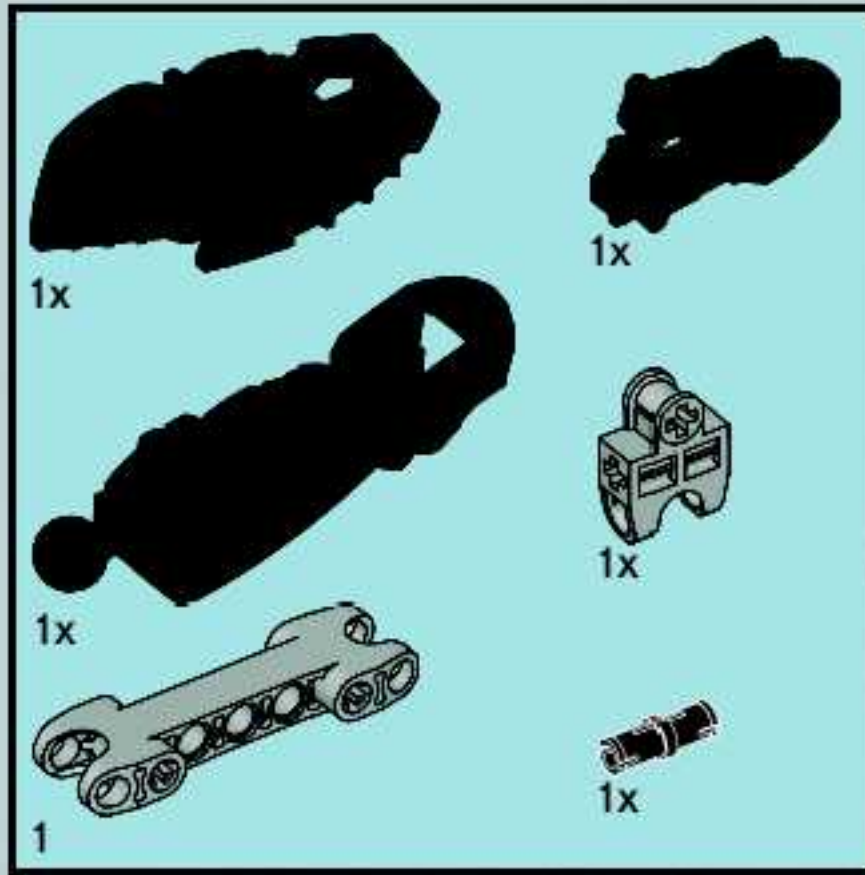

6



2



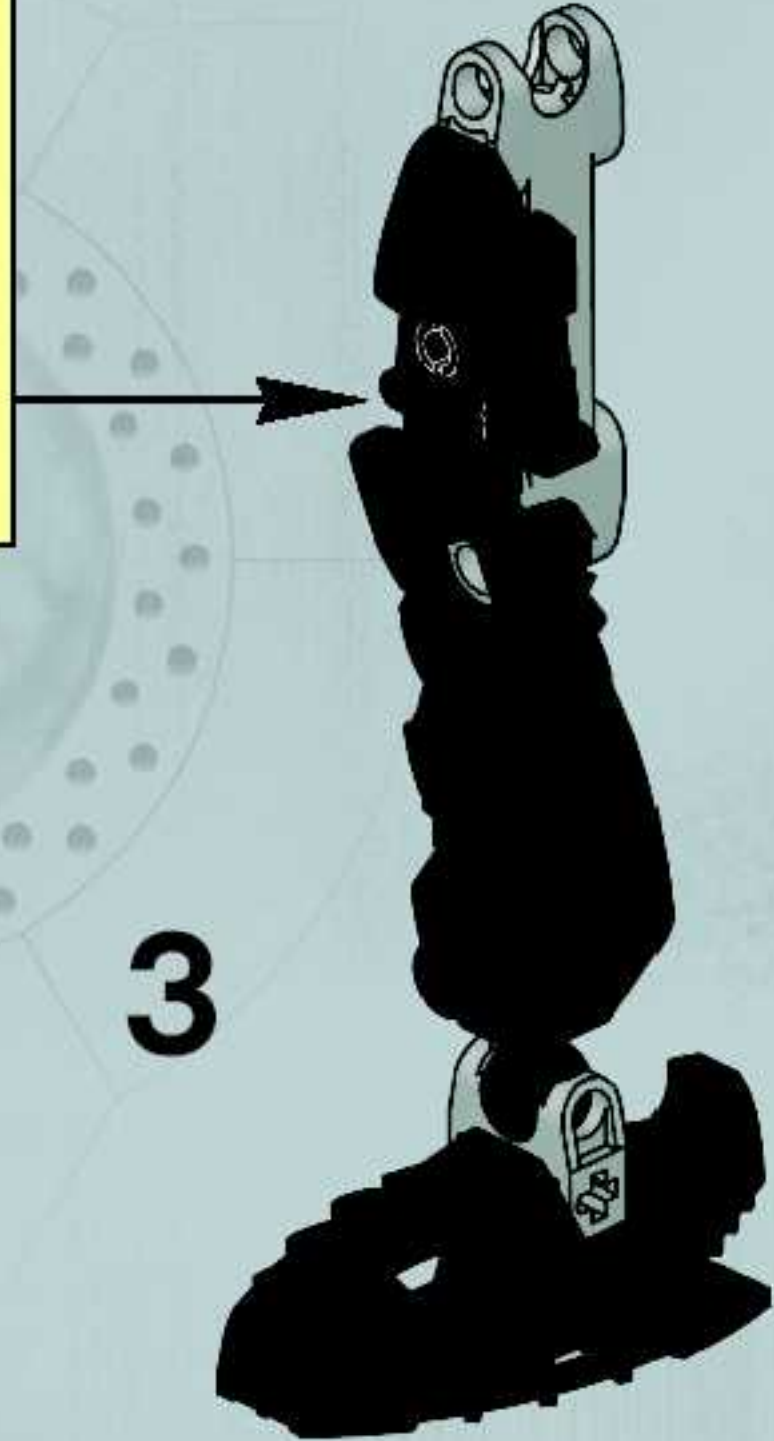
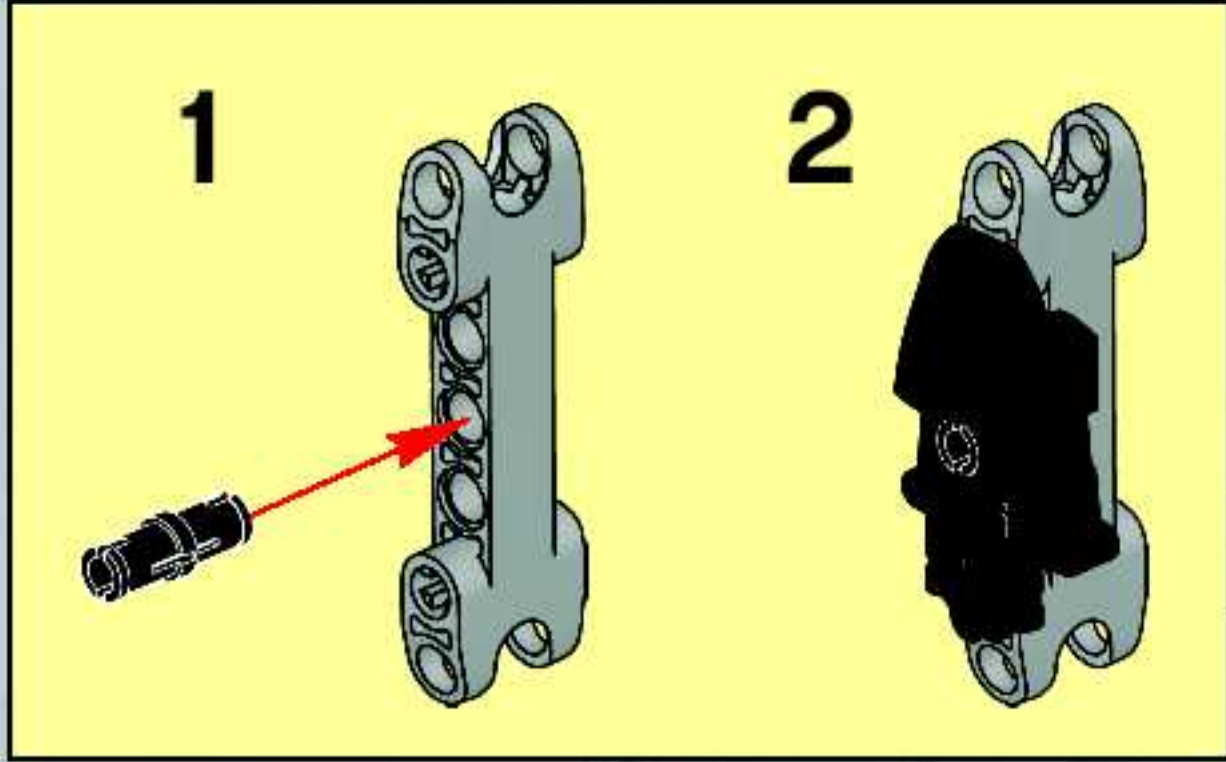

2x

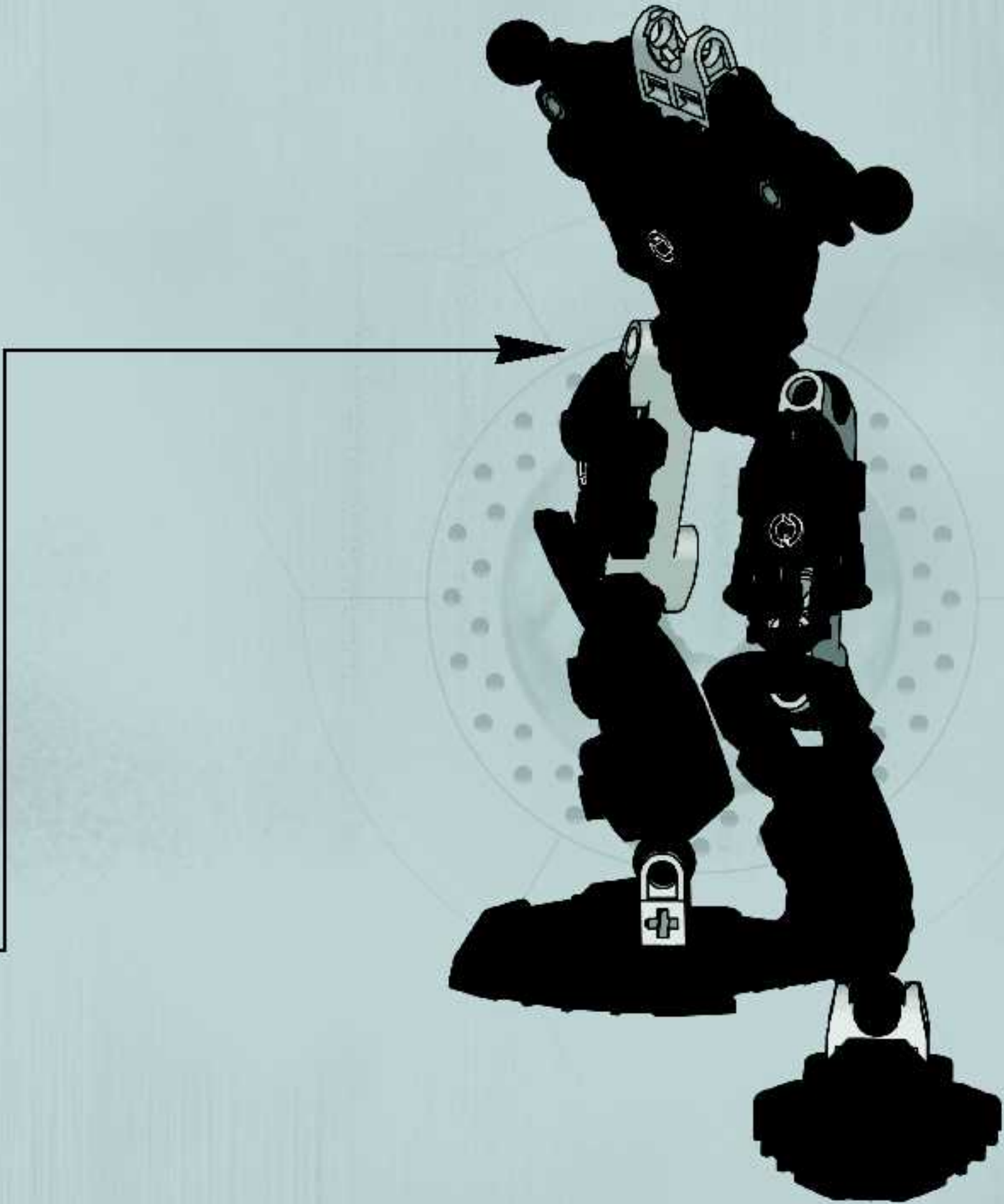

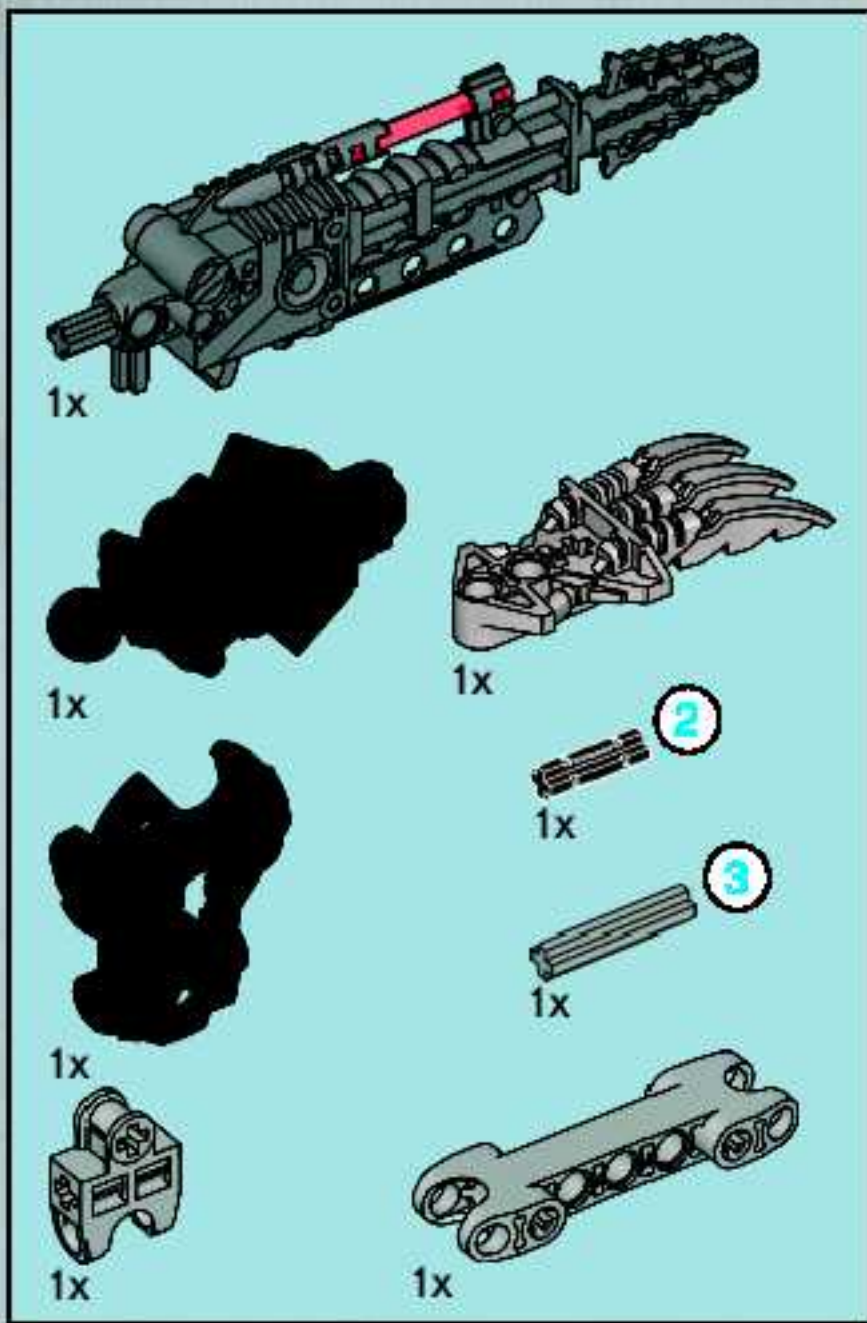

1

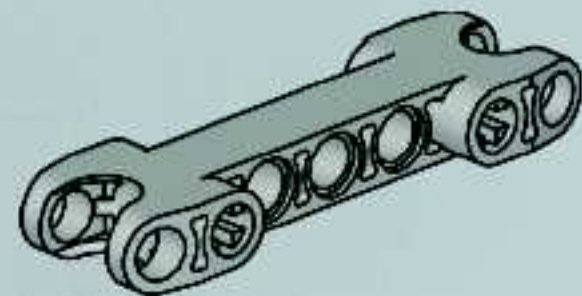

2

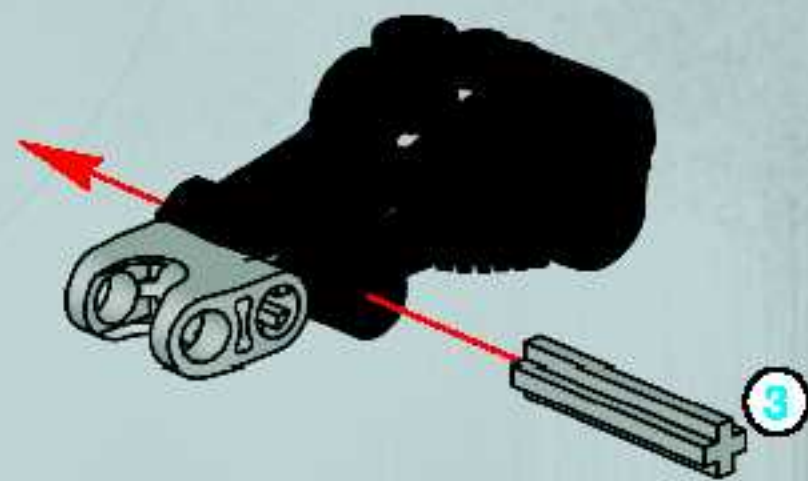

7

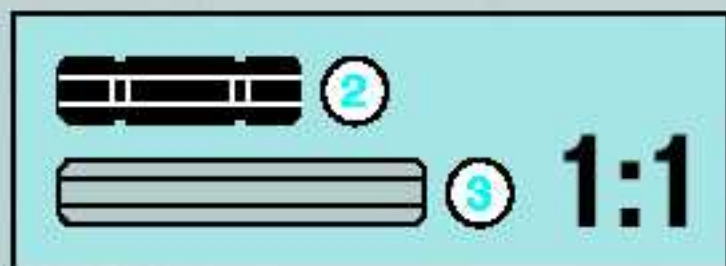

3

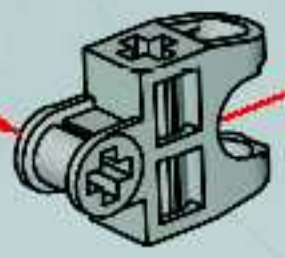
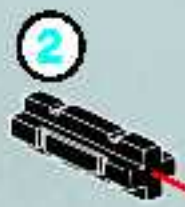

4

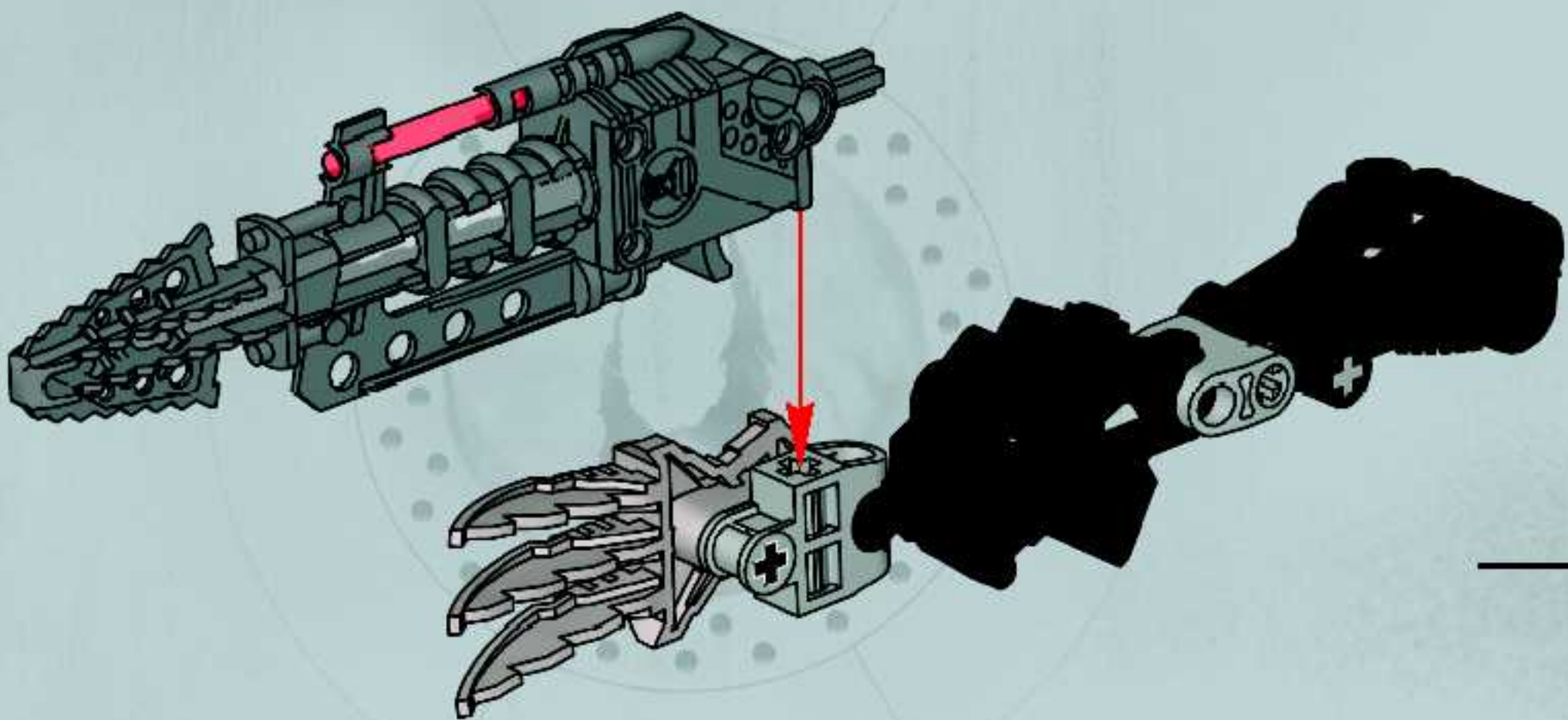

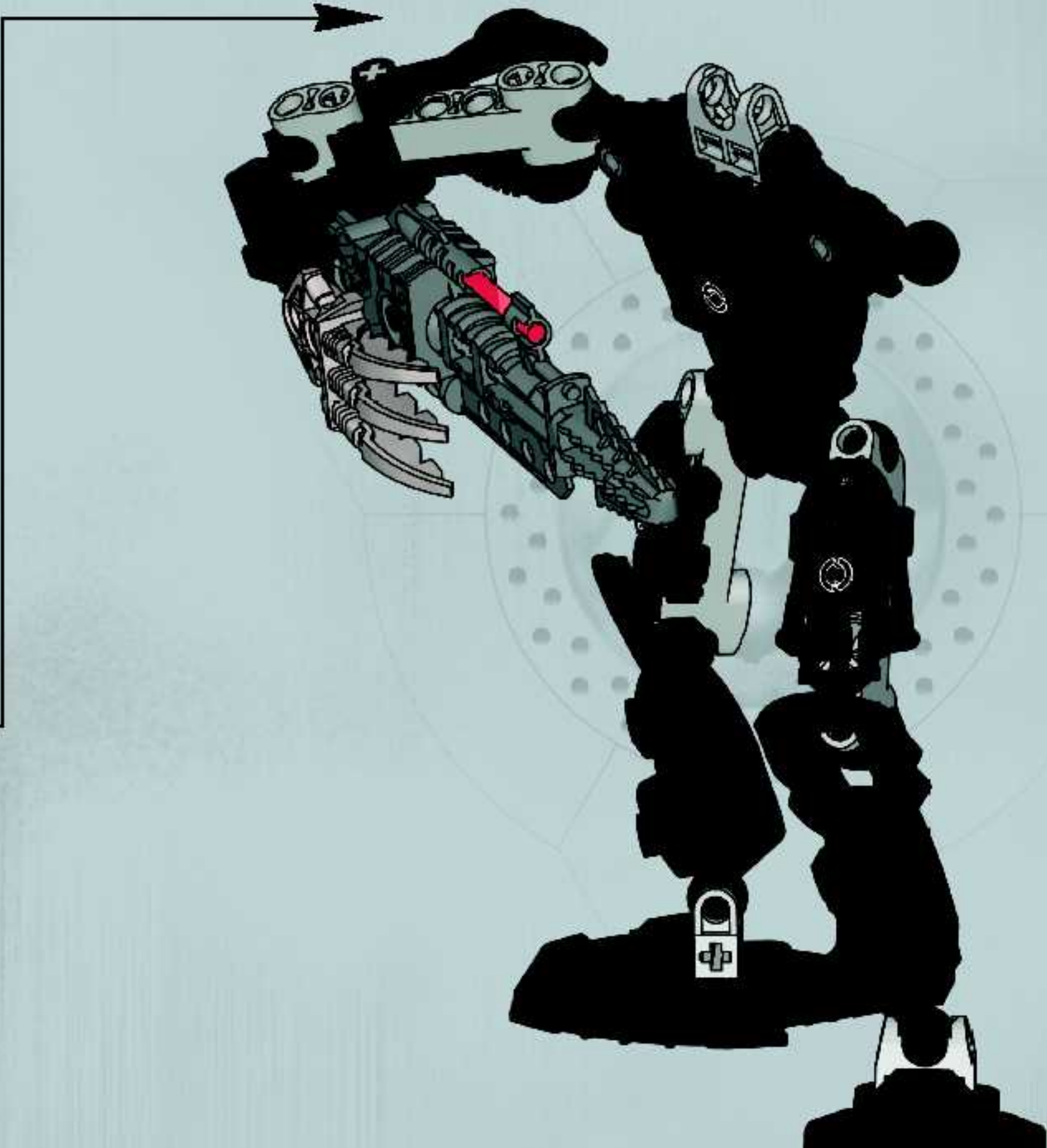

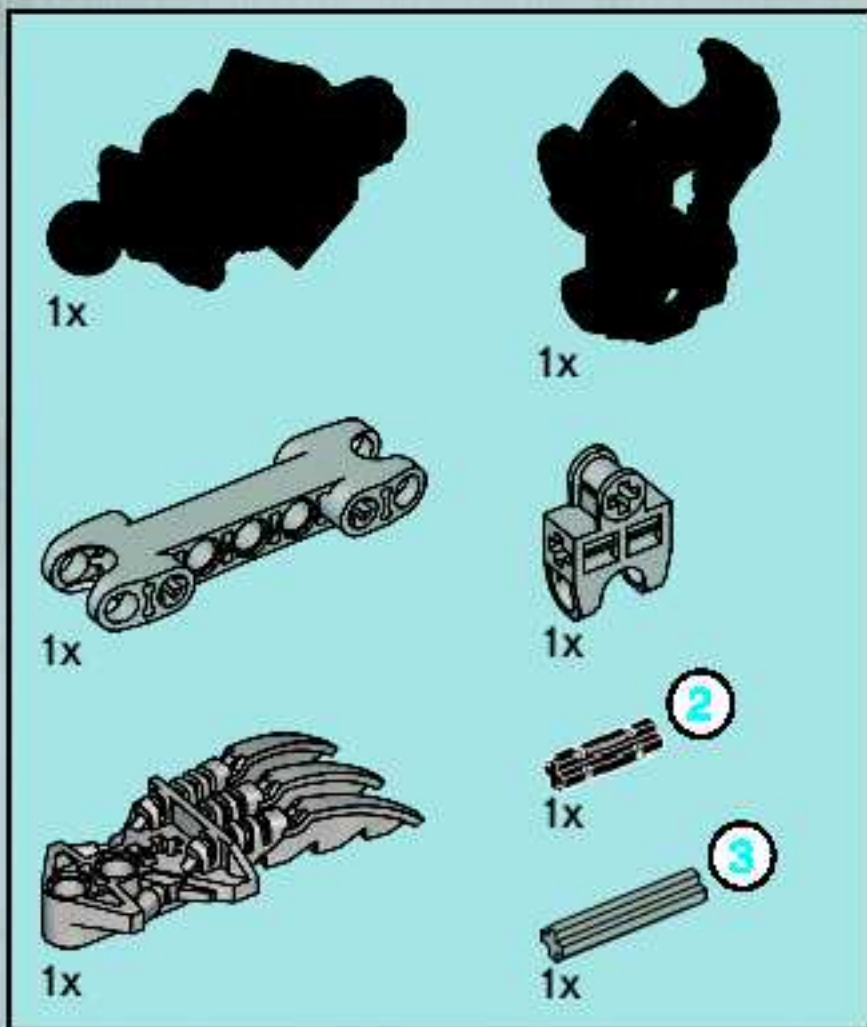

8

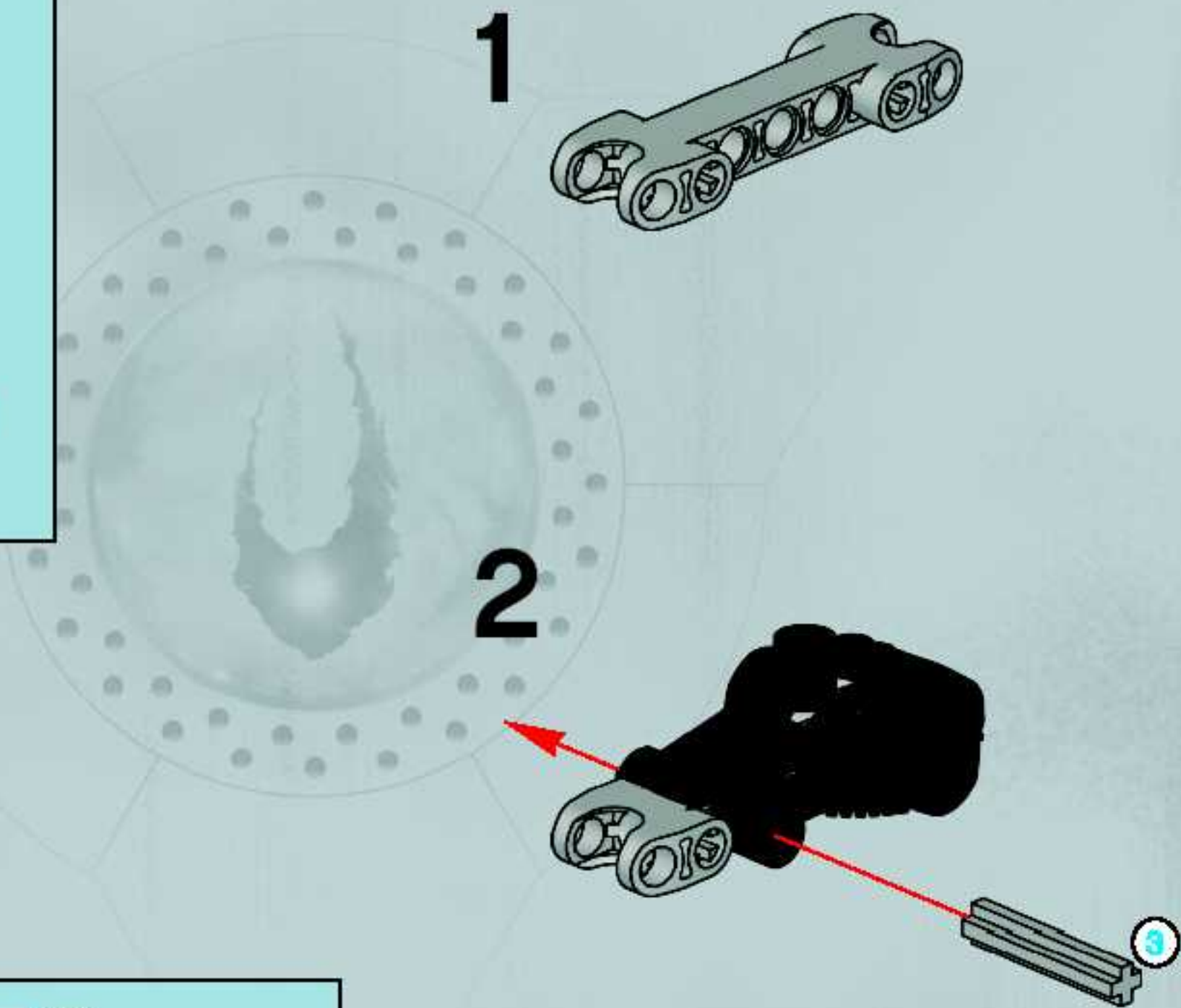
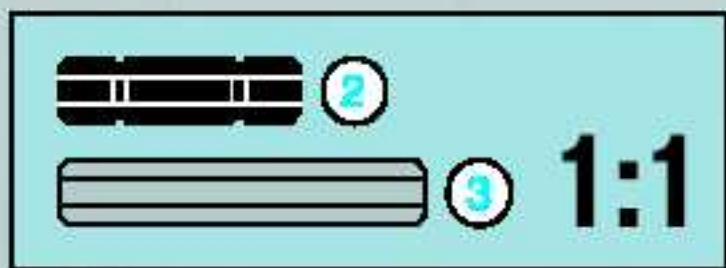

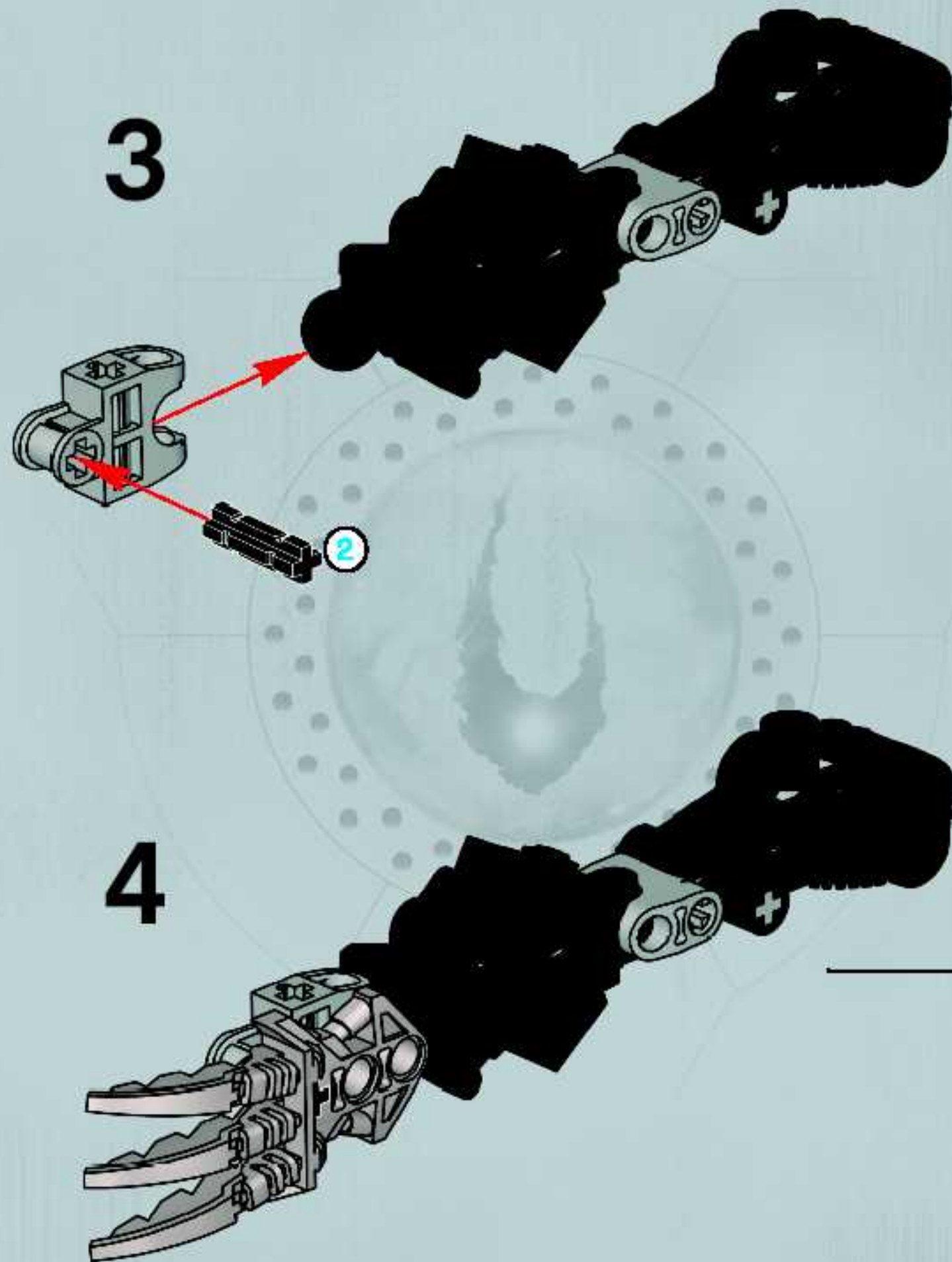

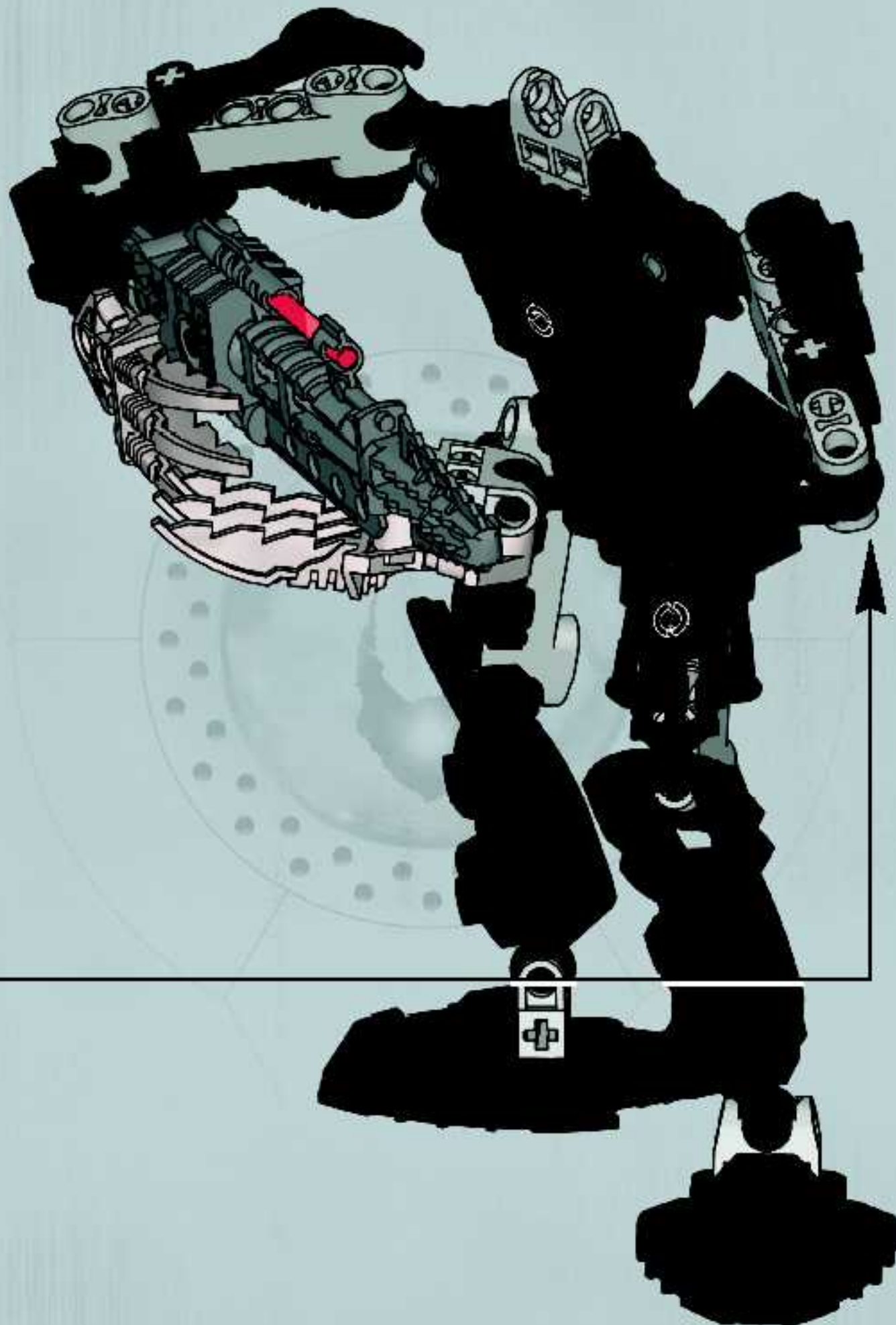

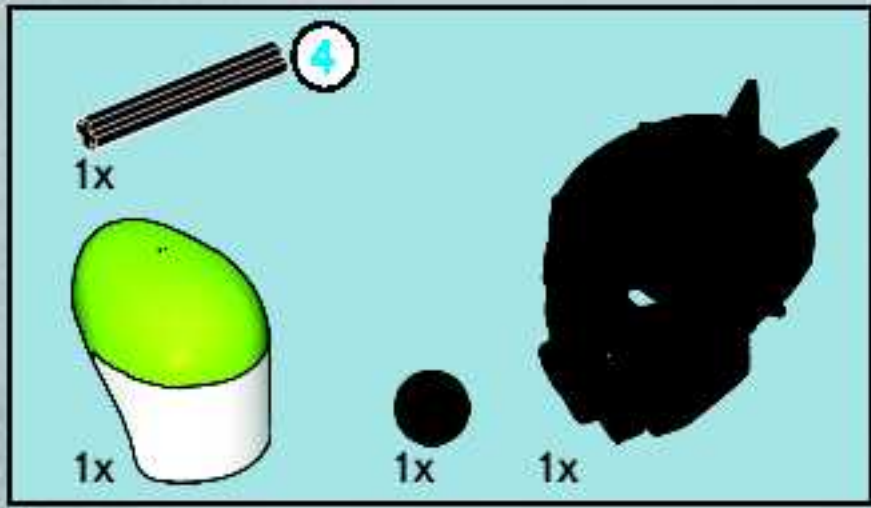

9

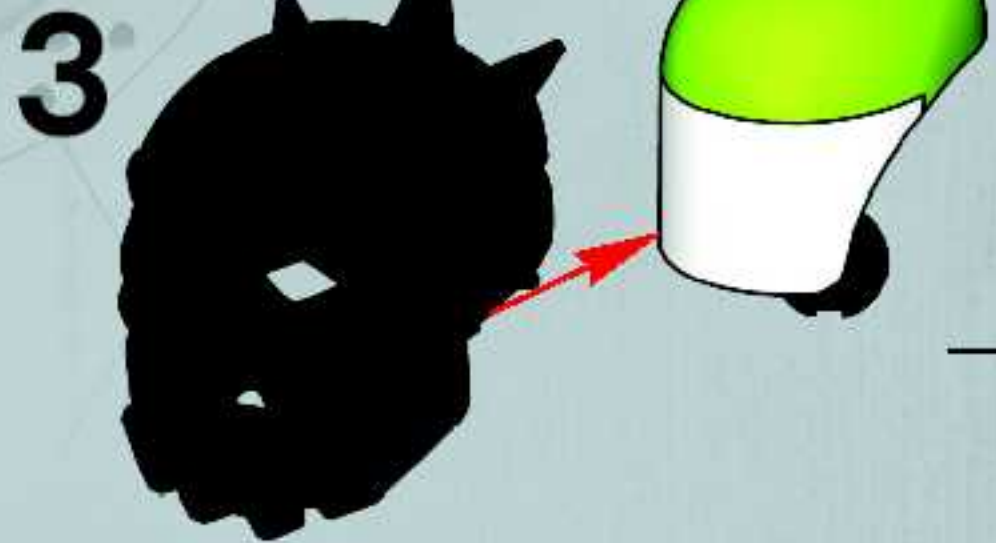
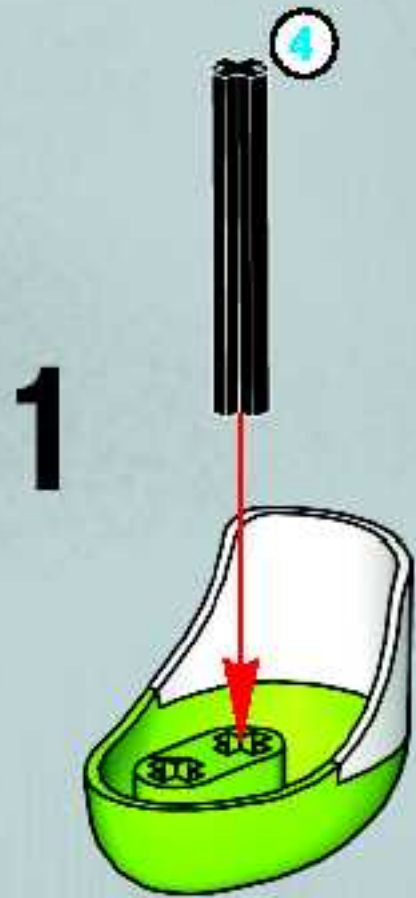

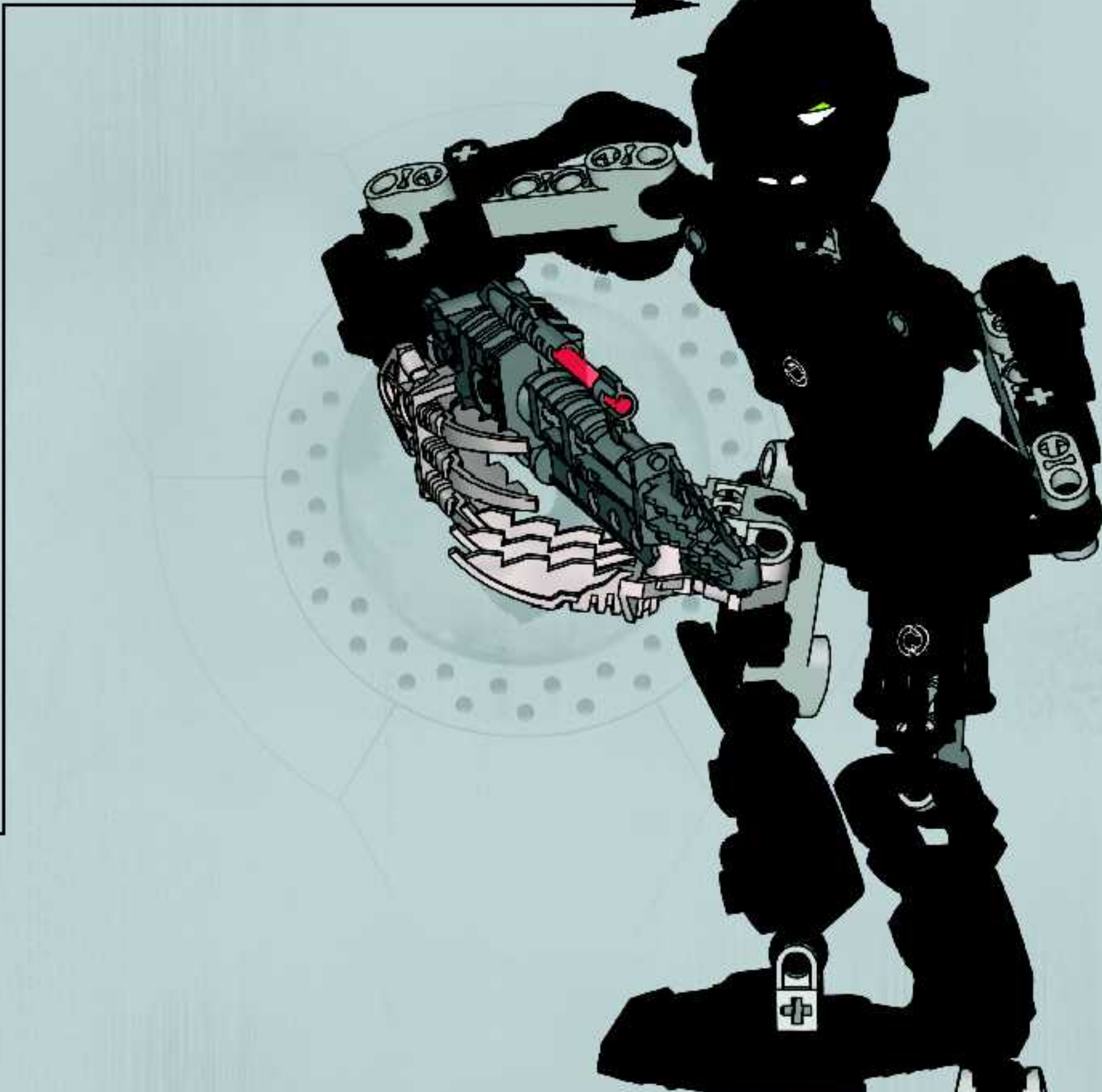

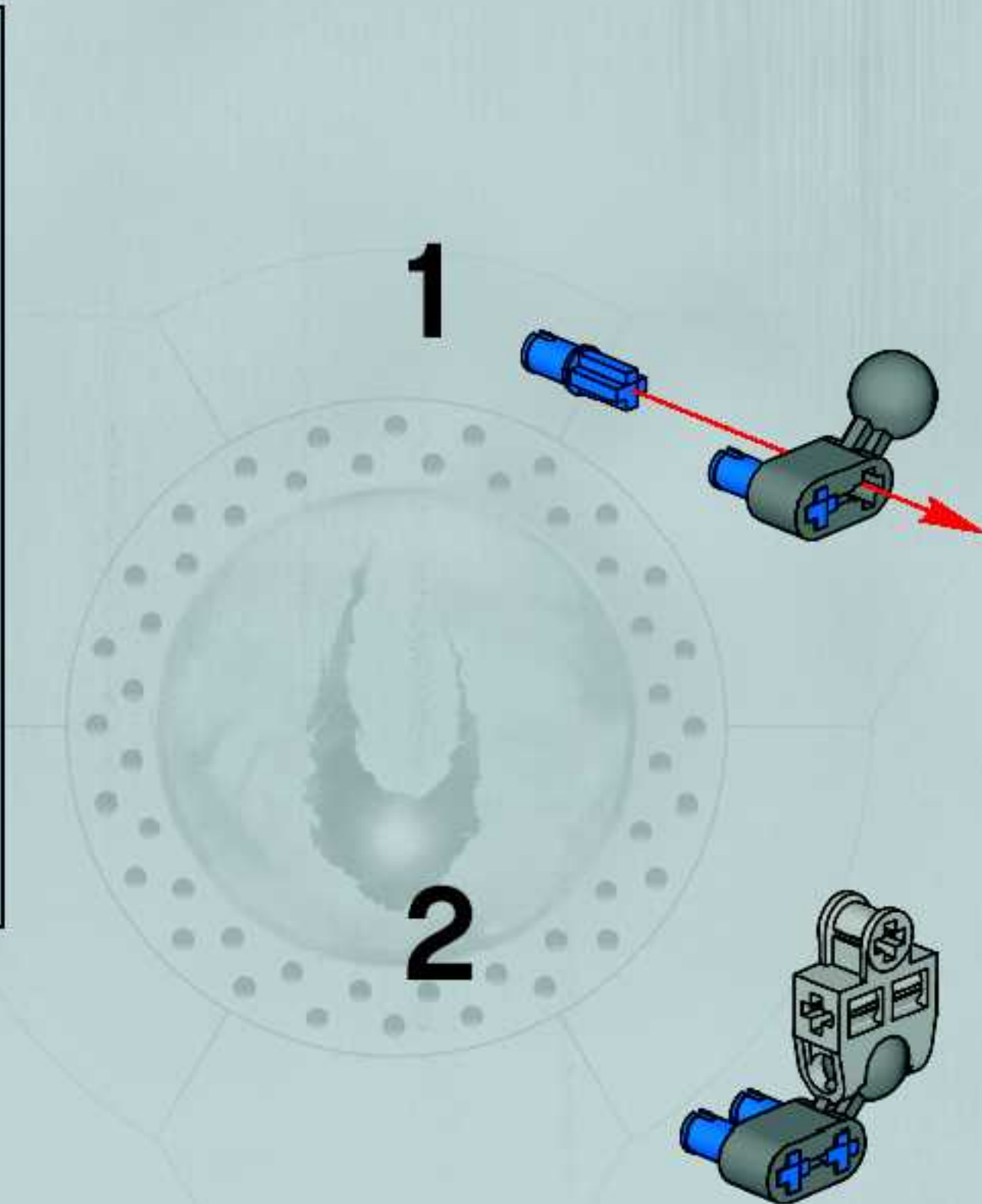
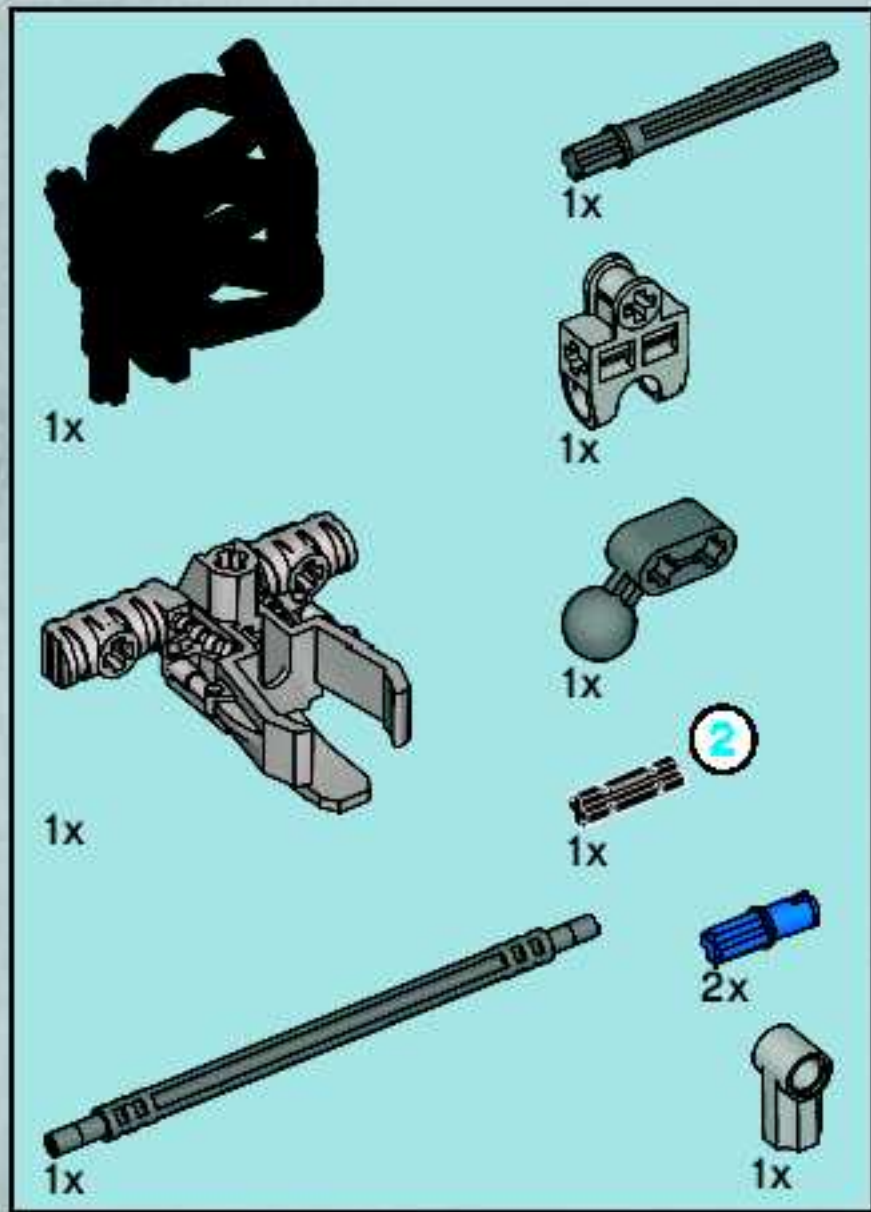

10

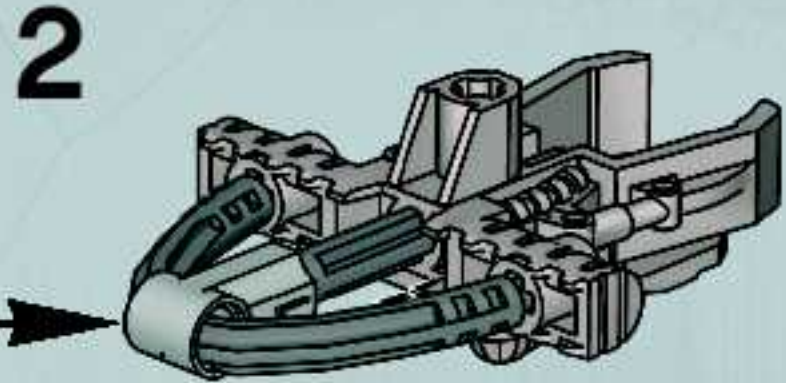
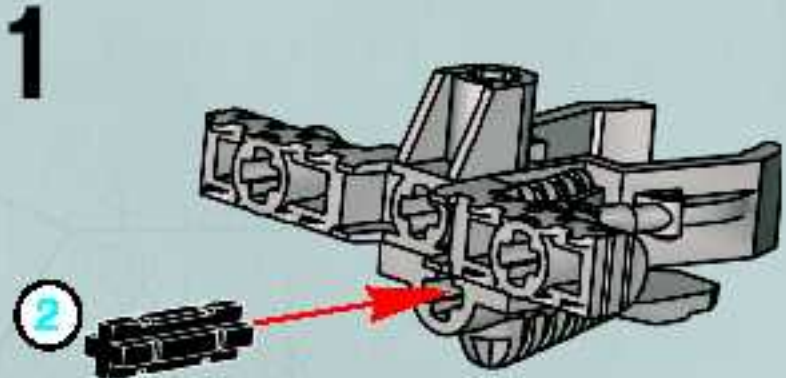
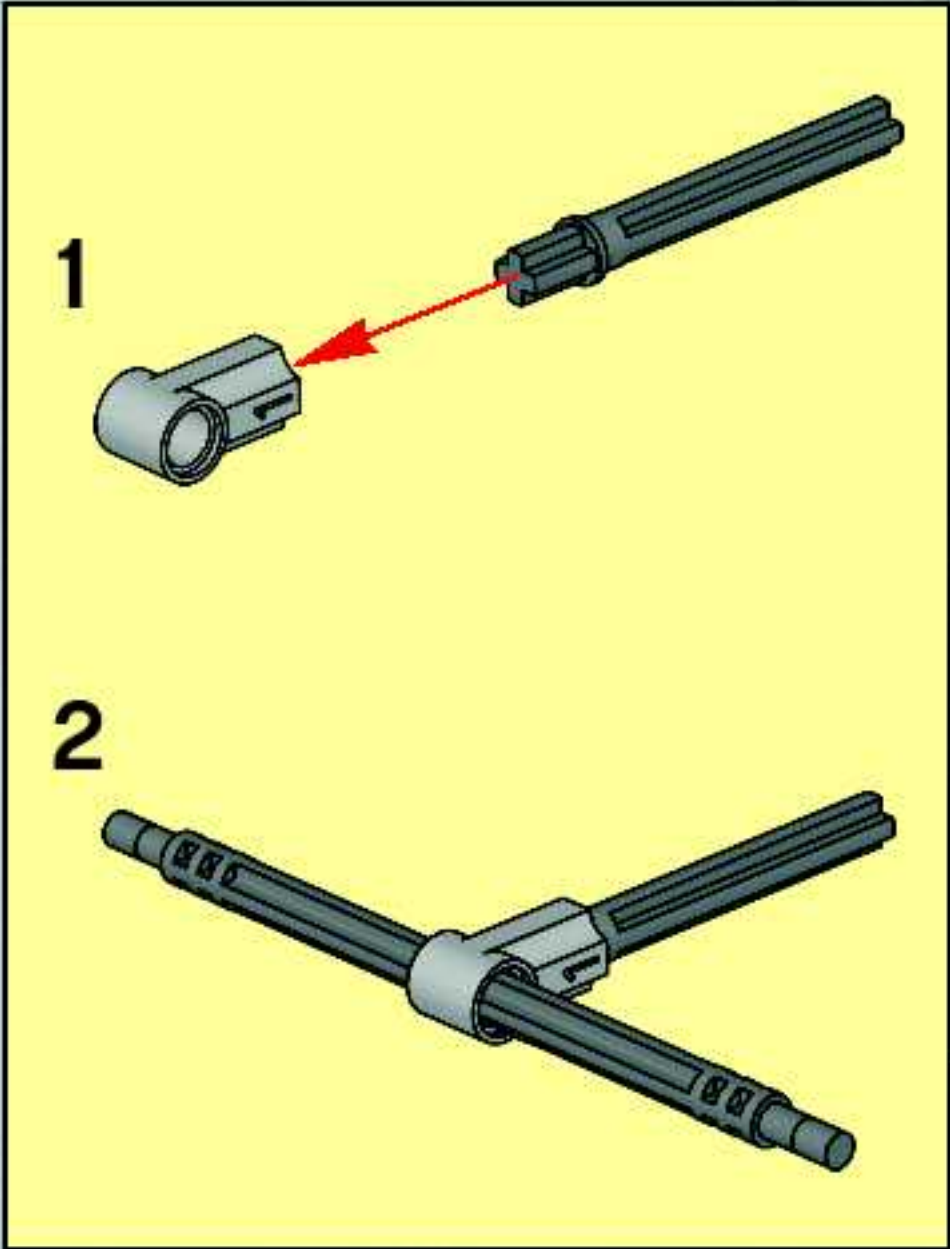

3

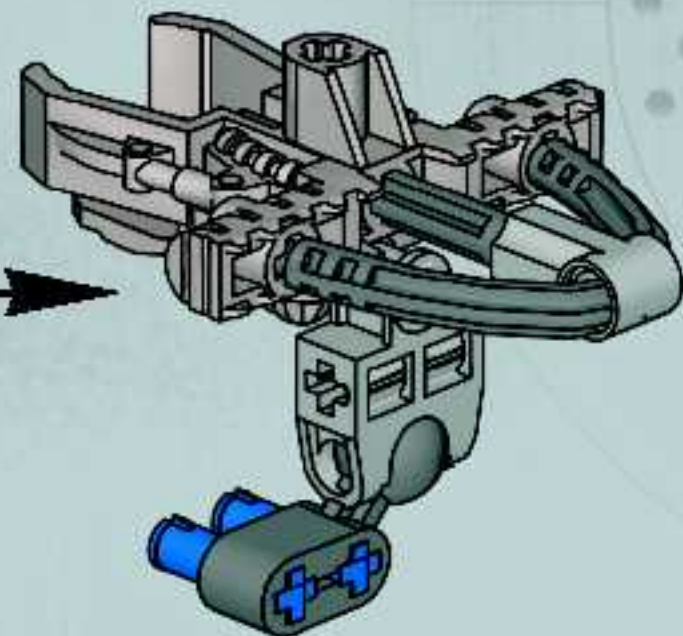

4

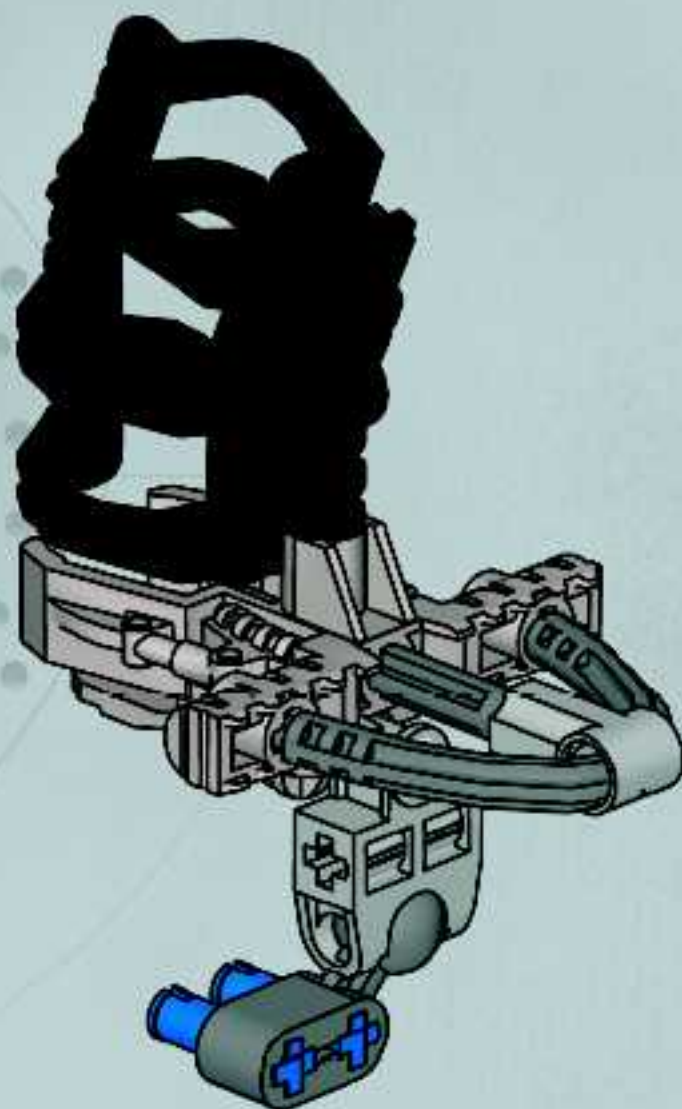

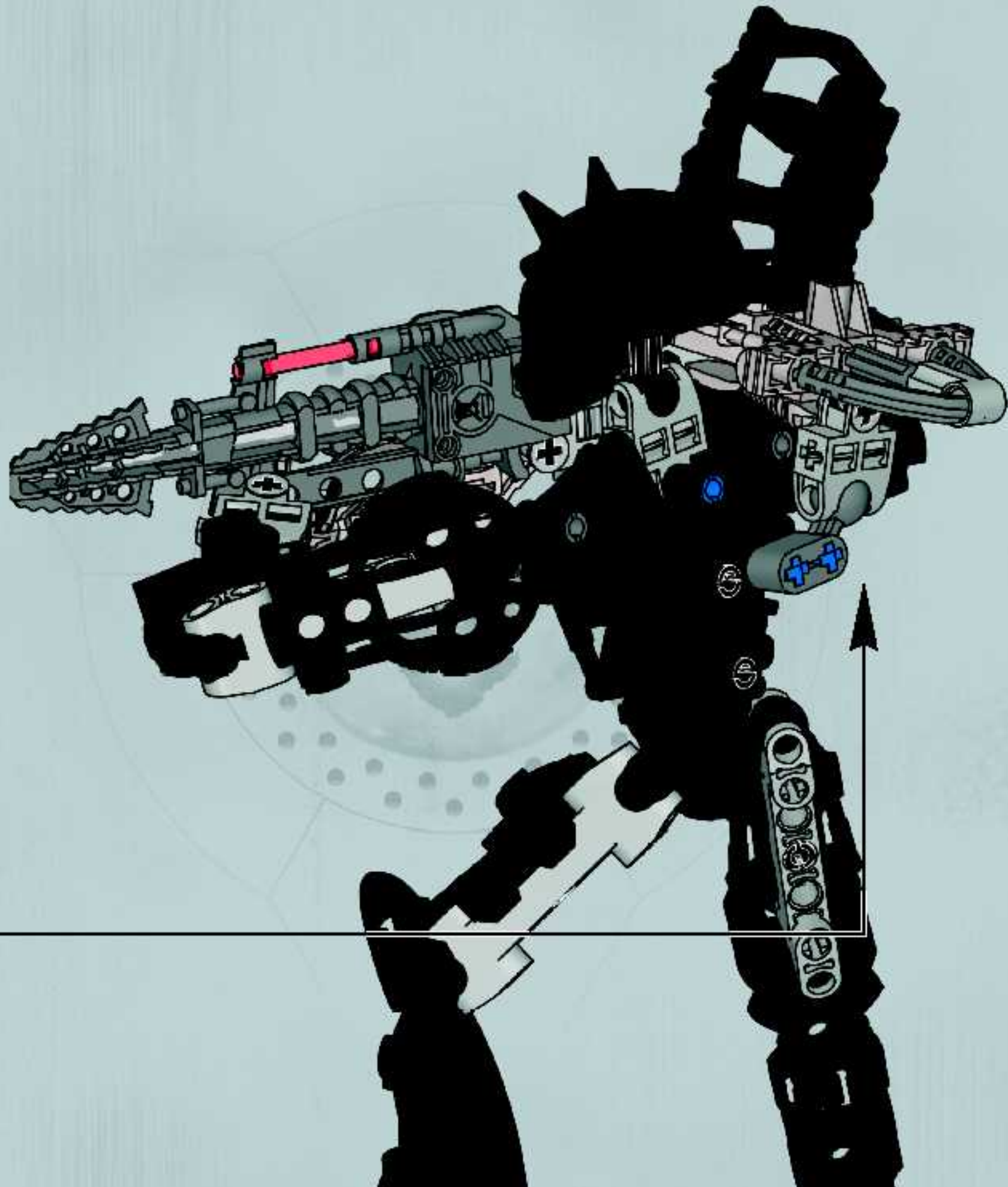

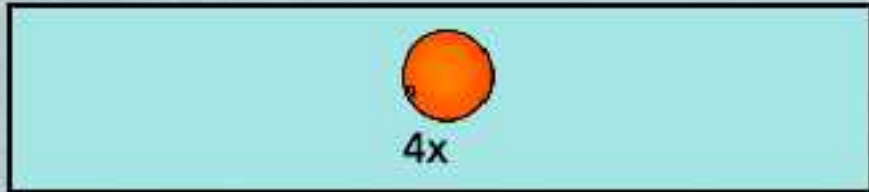

11

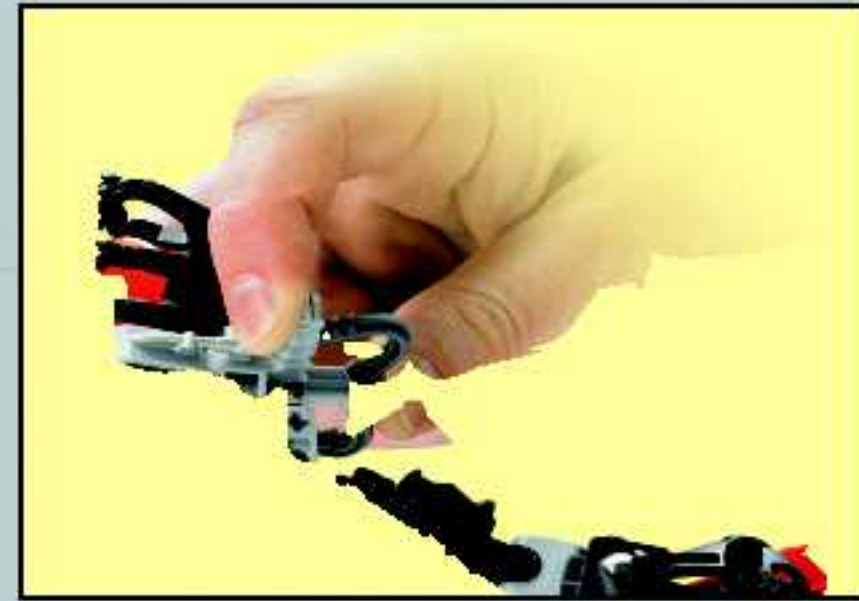
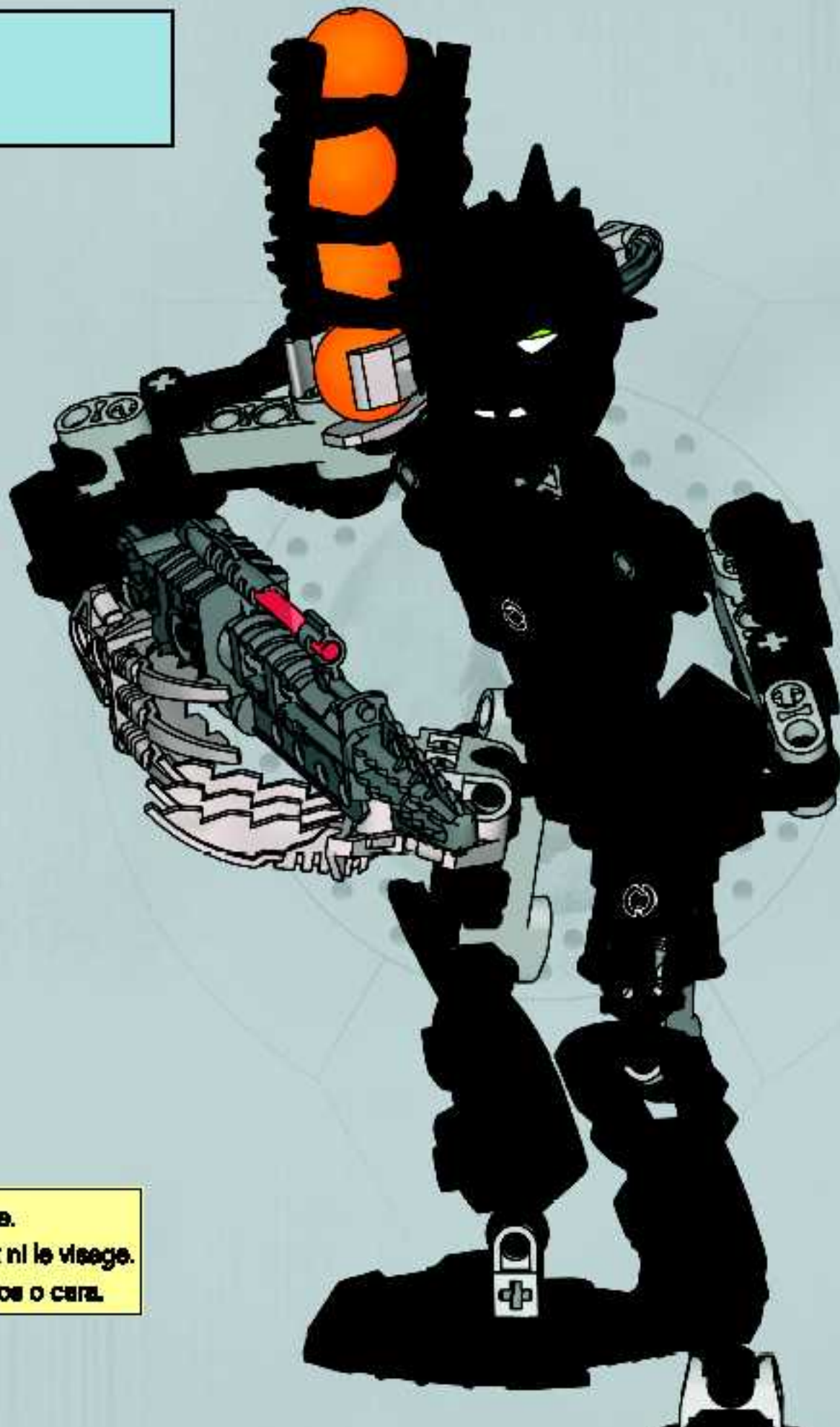

CAUTION: Do not aim at eyes or face.
ATTENTION : Ne pas viser les yeux ni le visage.
PRECAUCIÓN: No lo dirija a los ojos o cara.



1x
4492471



4x
4297030



1x
4289258



1x
4263624



2x
4211050

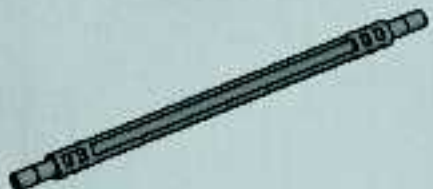

1x
4292000

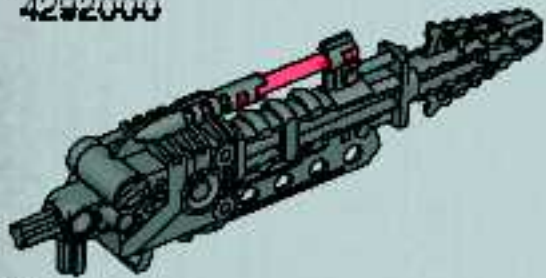

1x
4294877



1x
4278585



1x
4292482



1x
4292573



6x
4240563



1x
4211550



2x
4292543



1x
4294878



1x
4286267

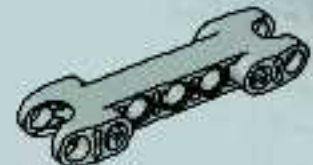

4x
4292654



2x
4289376



3x
4121715



2x
4211815



2x
4281239



1x
655826



2x
4494055



2x
4292649



1x
4292590



1x
370526

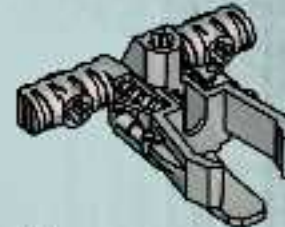

1x
4494490



3x
4109810



3x
4206482



1



2

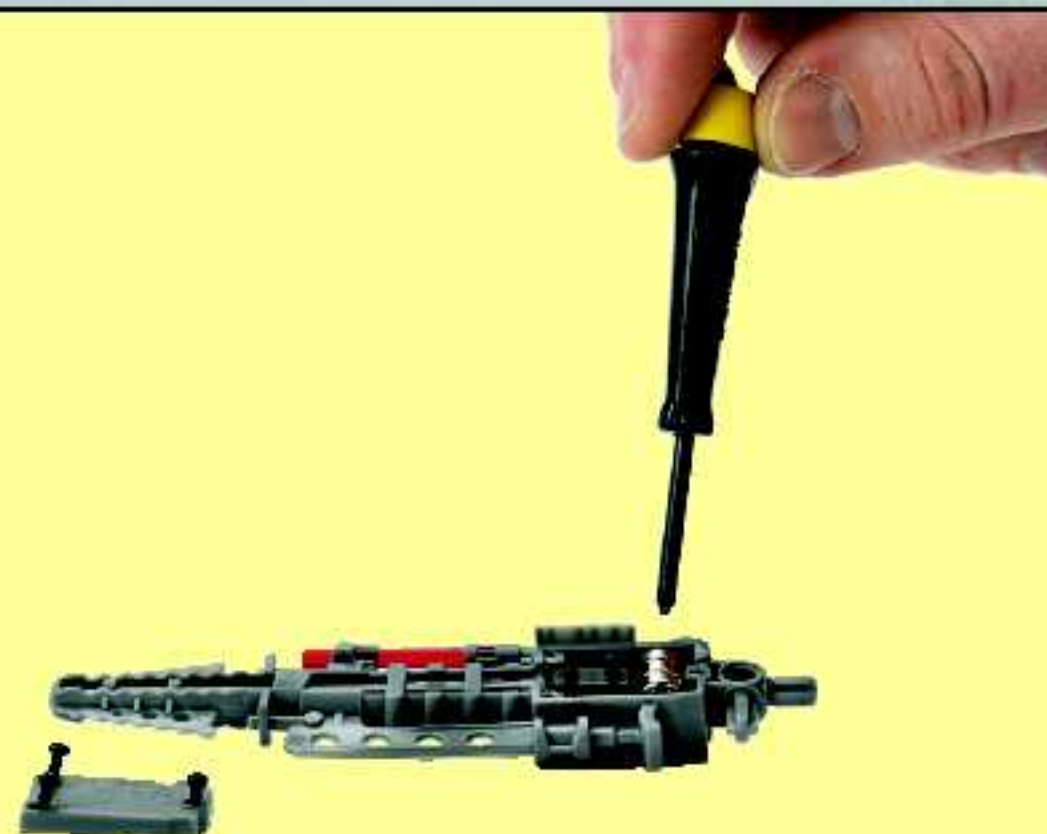

3



3x  1.5V

GB

Important information about batteries

Never use different types of batteries together, or a combination of old and new batteries. Always remove the batteries if the product is not to be used for a long time or if the batteries have run down. Never use damaged batteries. Only use batteries of the type recommended, or a corresponding type. Insert the batteries so that the poles are correctly positioned. Rechargeable batteries must be recharged using the correct battery charger under the supervision of an adult. You cannot recharge batteries while they are still in the product, and you must never try to do so. Never attempt to recharge non-rechargeable batteries. Never short-circuit the battery holder.

ES

Importante información sobre las baterías

No mezclar nunca diferentes tipos de baterías, ni utilizar baterías antiguas y nuevas a la vez. Sacar siempre las baterías, si el producto no se utiliza por un largo periodo de tiempo o si las baterías están descargadas. No utilizar nunca baterías dañadas. Utilizar solo el tipo de baterías recomendado o uno correspondiente. Colocar las baterías de manera que los polos estén en su posición correcta. Las baterías recargables deben cargarse con un cargador adecuado bajo la supervisión de un adulto. Las baterías no pueden, ni deben recargarse mientras permanecen en el producto. No intentar nunca recargar baterías no recargables. Asegurarse que no se produzca un cortocircuito en el porta-baterías.

FR

Informations importantes concernant les piles

Ne jamais utiliser un mélange de différents types de piles, ou de piles neuves et de piles anciennes ou déjà utilisées. Toujours retirer les piles si le produit n'est pas utilisé durant une période prolongée ou si les piles sont vides. Ne jamais utiliser de piles endommagées. Utiliser uniquement des piles du type recommandé ou d'un type équivalent. En insérant les piles, respecter scrupuleusement le sens d'orientation des piles (+/-). Les piles rechargeables doivent être rechargées en utilisant un chargeur de piles adéquat et sous la surveillance d'un adulte. Il est impossible de recharger les piles quand elles sont installées dans le produit. Ne jamais tenter de le faire. Ne jamais essayer de recharger des piles non-rechargeables. Ne jamais court-circuiter le compartiment des piles.



VOYA NUI



10 ZAMORS

8719



ΑΧΟΝΝ
8733



BRUTAKA
8734





BIONICLE® Heroes
The new official video game
Coming Soon

BIONICLE® Heroes
Das neue offizielle Videospiel
Demnächst erhältlich.

BIONICLE® Heroes
Le nouveau jeu vidéo officiel
Prochainement?!

BIONICLE® Heroes
El nuevo videojuego oficial
Muy pronto

BIONICLE® Heroes
O novo jogo de vídeo oficial
A chegar brevemente

BIONICLE® Heroes
Az új hivatalos videojáték
hamarosan a boltokban

RATING PENDING



CONTENT RATED BY
ESRB



GAME BOY ADVANCE



NINTENDO DS



PlayStation 2



BIONICLE® game software © TT Games Publishing Ltd 2006. Developed by Traveller's Tales Ltd. Published by Eidos and TT Games under license from the LEGO Group. LEGO, the LEGO logo and BIONICLE® are trademarks of the/ont des marques de commerce de/son marcas registradas de LEGO Group. ©2006 The LEGO Group. Eidos and the Eidos logo are trademarks of the SCI Entertainment Group. All rights reserved. * * and "PlayStation" are registered trademarks of Sony Computer Entertainment Inc. All Rights Reserved. Xbox, and the Xbox logos are either registered trademarks or trademarks of Microsoft Corporation in the United States and/or other countries and are used under license from Microsoft. All Rights Reserved. NINTENDO GAMECUBE, THE NINTENDO GAMECUBE LOGO, GAME BOY ADVANCE AND NINTENDO DS ARE TRADEMARKS OF NINTENDO.



FREE!

Each LEGO Magazine Features...

- Awesome creations by Kids like you!
- Cool Comics & Stories
- Building Tips & Ideas
- Special Offers & Contests to WIN Prizes!

GRATUIT!

Chaque Magazine LEGO offre...

- Des créations épatantes par des jeunes comme toi !
- Des bandes dessinées et des récits super cool
- Des idées de construction
- Des offres spéciales et des concours pour gagner des prix !

Join Today! Abonne-toi dès aujourd'hui !

1-866-534-6258

www.LEGOclub.com

YES! I WANT TO JOIN THE LEGO® CLUB!

This coupon is good for 1 **FREE** 2-year Club membership. Additional kids may sign up for \$7.95 in the US and in Canada 10.70 (including taxes).

PLEASE PRINT IN ALL CAPITAL LETTERS

OUI! JOIGNEZ-MOI AU CLUB LEGO® !

Ce coupon est valide pour 1 abonnement **GRATUIT** de 2 ans. Enfants additionnels peuvent s'inscrire pour 10,70 \$ (taxes incluses).

S.V.P. IMPRIMER EN LETTRES MAJUSCULES.

BIC26

Name/Nom _____ Age _____

Français English

Address/Adresse _____

Girl/Fille Boy/Garçon

City/Ville _____ State/Prov. _____ Postal Code _____

E-mail Address/Courriel _____ Date of Birth _____

Date de Naissance ____ / ____ / ____
M D/J Y/A

Parent's Signature/Signature d'un parent _____

Mail to/Poster à:
LEGO Club
P. O. Box 1157
Enfield, CT 06083-1157



Offer limited to residents of US and Canada. No photocopies will be accepted. Offer limited to two free memberships per family, group or organization. Please allow 4-6 weeks for delivery of your first mailing.

Offre limitée pour résidents du US et Canada. Photocopies ne seront pas acceptées. Offrir limitée à deux abonnements gratuits par famille, groupe, ou organisation. Allouez 4-6 semaines pour la première livraison.





SHOP(at)HOME

The World's Biggest LEGO® Shop!



Any questions regarding your new LEGO product, please contact:
Customer Service |

Service Consommateurs | Servicio :



1-800-422-5346

or

www.lego.com/service

For a Free Catalog in the U.S.
and Canada, call toll-free:
1-866-534-6737

Or go online:
www.LEGOshop.com/catalog

Pour obtenir un Catalogue GRATUIT
aux États-Unis et au Canada,
téléphonez sans frais au :
1-866-534-6737

Ou venez en ligne sur :
www.LEGOshop.com/catalog

FREE LEGO® Catalog!

Please print with a pen in capital letters.

First Name / Prénom _____

Last Name / Nom _____

Address / Adresse _____

City / Ville _____ State / Prov _____ Zip Code / Code Postal _____

Phone (optional) / No de téléphone (optionnel) _____

Email (optional) / Courriel (optionnel) _____

Check Below / Indiquer ci-bas

- I speak English Je parle Français Boy/Garçon Girl/Fille

Catalogue LEGO® Gratuit!

S.V.P. Écrire en lettres majuscules avec un stylo à bille noir.

Mail to/Poster à: **CRBP26**



P. O. Box 1221
Enfield, CT 06083-1221



Please allow 2-4 weeks for delivery.
Veuillez s.v.p. allouer 2 à 4 semaines pour l'expédition.

U.S. and Canada only
É.-U. et Canada seulement

BIONICLE

NIKA

TGA MOPARU
8728

TGA JALLER
8727

TGA HARLI
8729

TGA KONGU
8731

TGA MATARO
8732

TGA HEWKII
8730

©2006 The LEGO Group - 4493606

LEGO