



# MONKIE KID 悟空小侠

80040





### **Get excited about our new packaging!**

We're switching from plastic to paper-based packaging. That's why you might find a mix of paper and plastic in our boxes!

### **Nos nouveaux emballages vous emballeront !**

Nous passons des emballages en plastique aux emballages à base de papier. C'est pourquoi vous pourriez trouver un mélange de papier et de plastique dans nos boîtes !

### **¡Te presentamos nuestros nuevos empaques!**

Estamos sustituyendo las bolsas de plástico por bolsas con base de papel. ¡Por eso, puedes encontrar una mezcla de papel y de plástico en nuestras cajas!

**[LEGO.com/sustainable-packaging](https://www.lego.com/sustainable-packaging)**

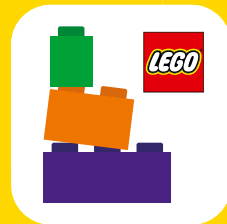

# BUILDER



Apple and the Apple logo are trademarks of Apple Inc., registered in the U.S. and other countries and regions. App Store is a service mark of Apple Inc. Google Play and the Google Play logo are trademarks of Google LLC. Tencent and the Tencent logo are trademarks of Tencent Inc.

**EN** Ask parents' permission before going online | **DE** Eltern um Erlaubnis bitten, bevor du online gehst | **FR** Demande l'autorisation d'un parent avant d'aller en ligne | **IT** Chiedi il permesso ai tuoi genitori prima di andare online | **ES** Pídeles permiso a tus papás antes de conectarte a Internet | **PT** Pede autorização aos pais antes de acederes online | **JA** オンラインになる前に ほご者の方のきよかをもらおう | **ZH** 上网前应先征得父母的同意 | **KO** 온라인 접속 전에 보호자 동의가 필요합니다 | **RU** Спроси разрешения у родителей, прежде чем заходить в интернет | **PL** Poproś rodziców o zgodę, zanim wejdziesz do Internetu | **CS** Než půjdeš na internet, požádej rodiče o svolení | **SK** Skôr než pôjdeš na internet, vypýtaj si povolenie od rodičov | **HU** Kérj szülői engedélyt, mielőtt online csatlakoznál! | **RO** Cere permisiunea părinților înainte de a te conecta online | **BG** Поискайте разрешение от родител, преди да влезете онлайн | **LV** Pirms došanās tiešsaistē palūdz atļauju vecākiem | **ET** Enne Interneti kasutamist küsi vanematelt luba | **LT** Prieš prisijungdami prie interneto, atsklauskite tėvų

Q [LEGO.com/devicecheck](https://www.lego.com/devicecheck)

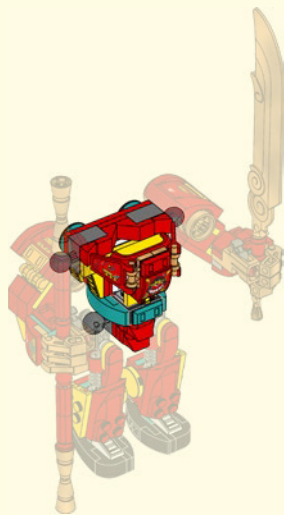

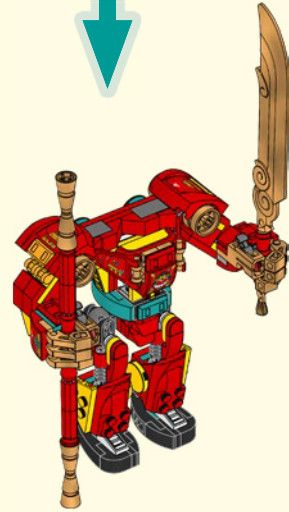
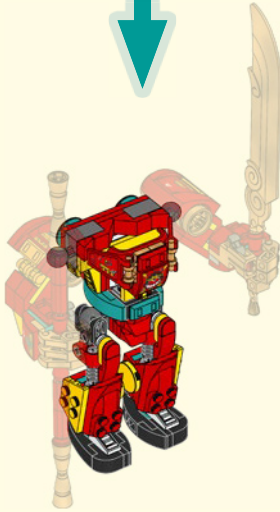

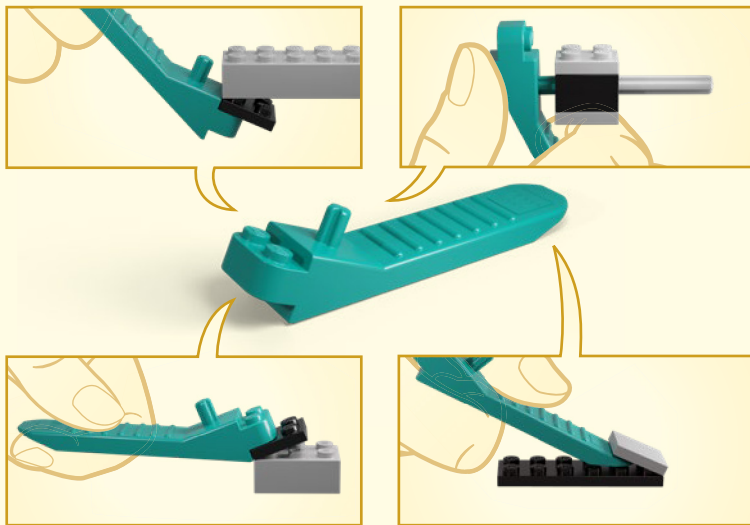

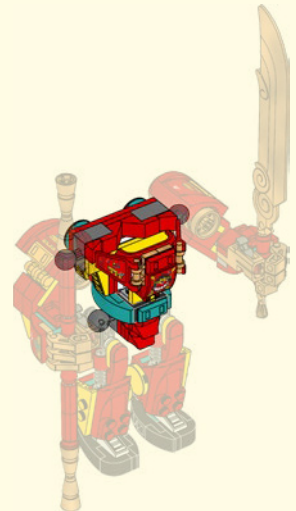



1

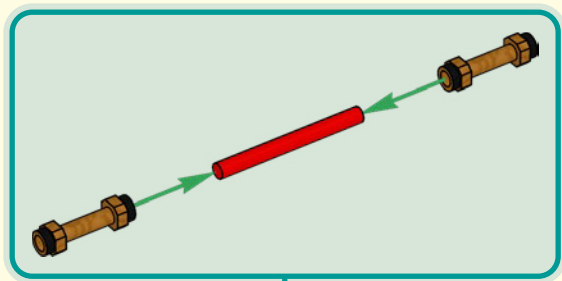

2





# MONKIE KID



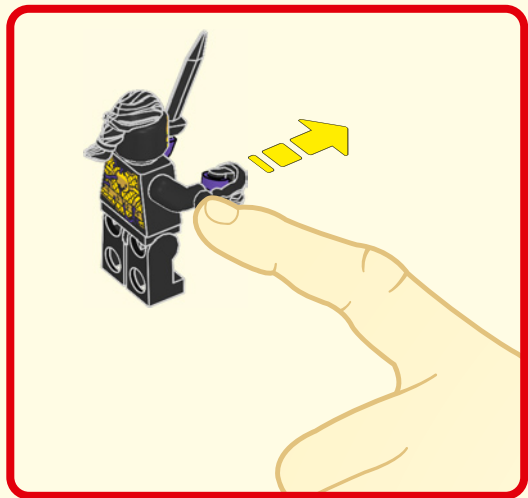
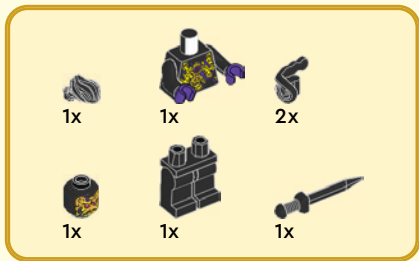

1

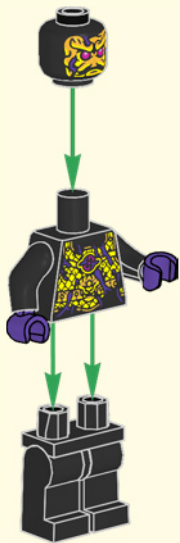

2





1x

1

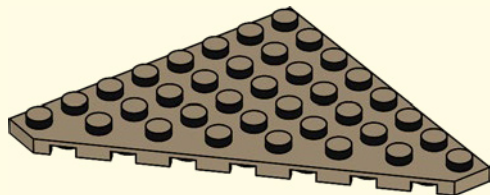

1x



1x

2

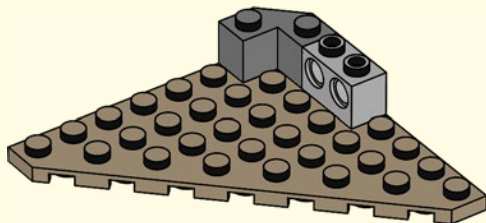



1x



2x

3

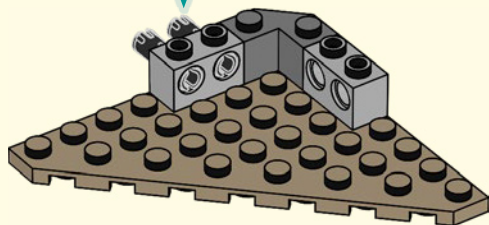
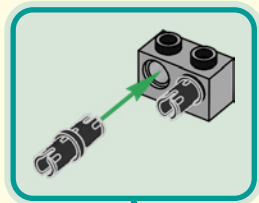

1x



1x

4

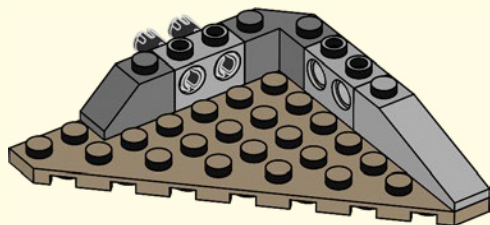



2x

5

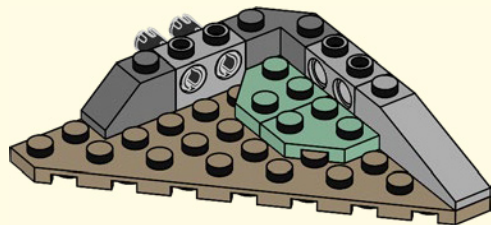

1x



2x

6

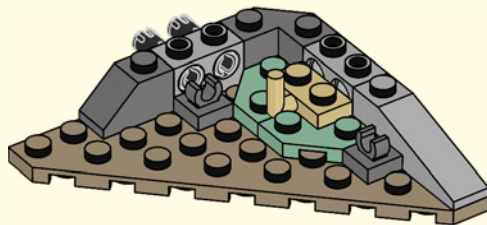



1x

7

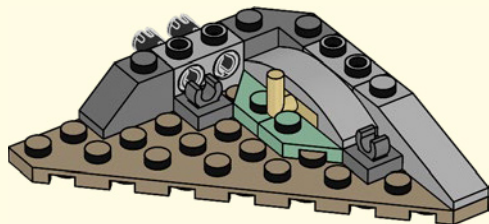

14



2x

8

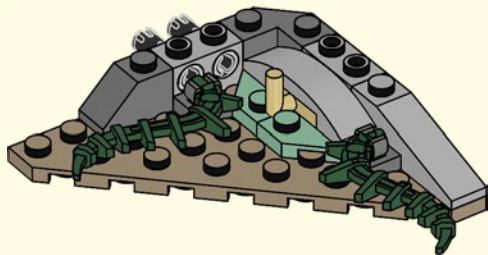



2x

9

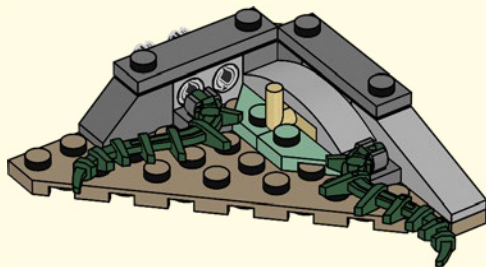

1x



1x

10

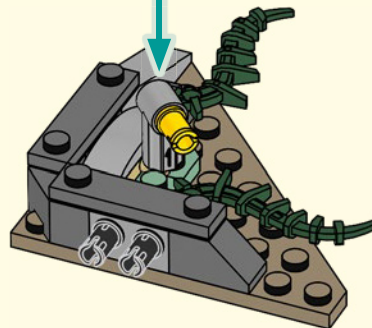
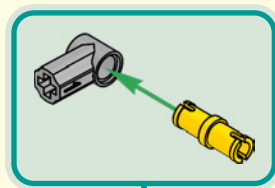

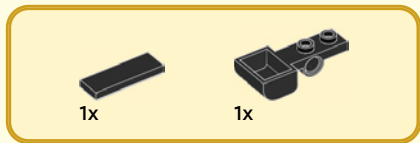

11

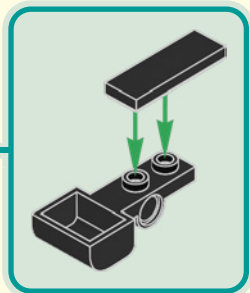
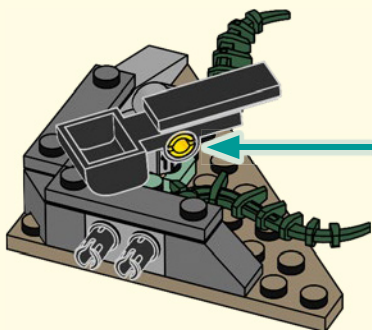

12

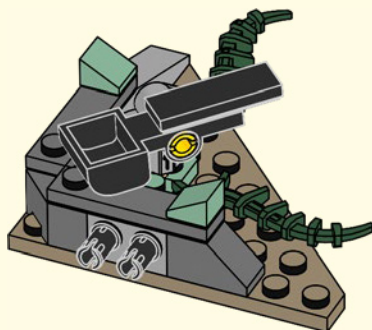





3x

13

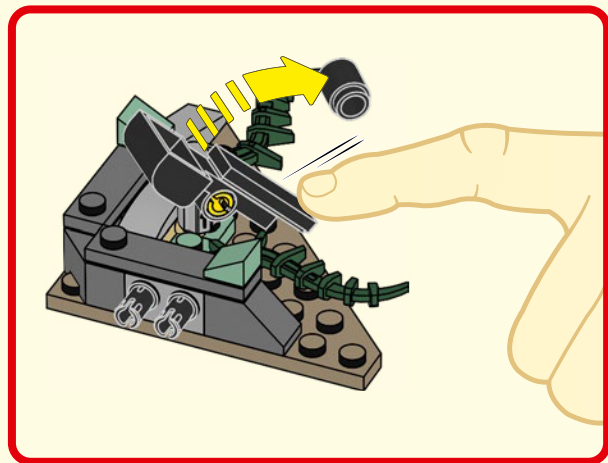



1x

2x

1

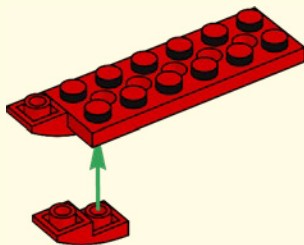



1x

2

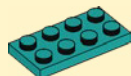
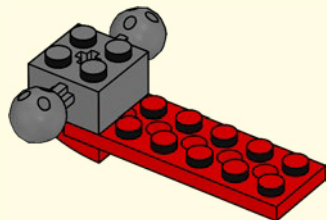

1x

3

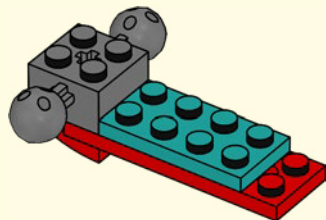



1x



1x

4

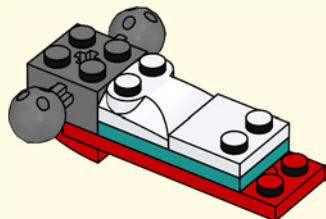

2x



2x

5

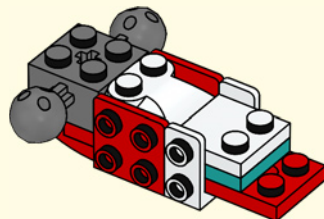

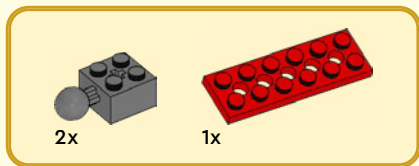

6

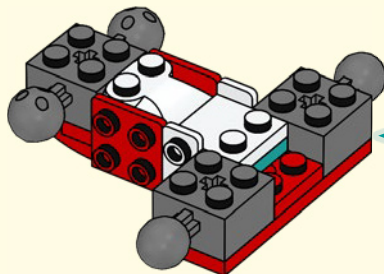
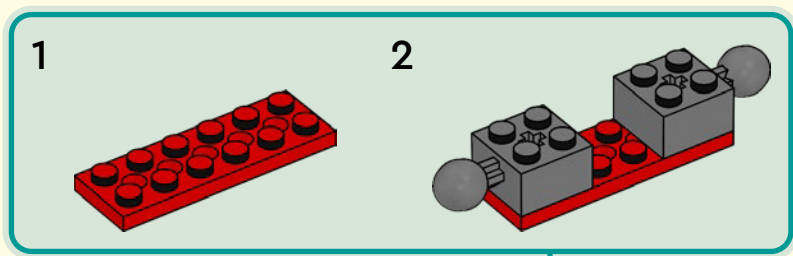



1x

7

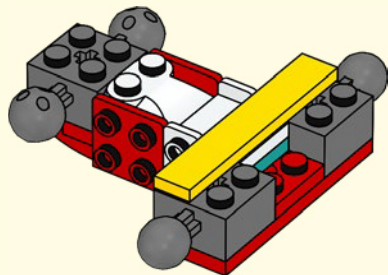

2x



2x

8

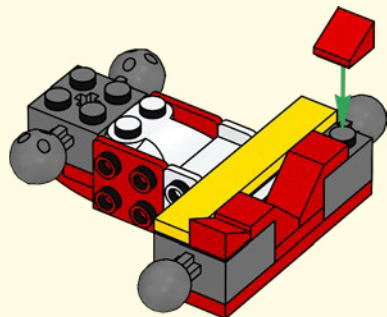

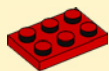

2x

9

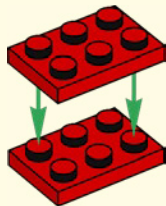

2x

10

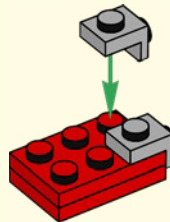



2x



1x

11

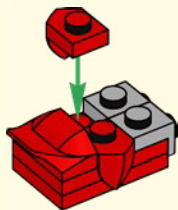

1x

12

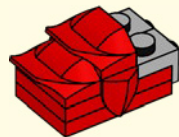





1x

13

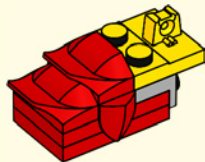

2x

14

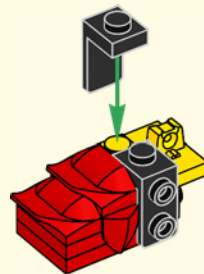



15



16

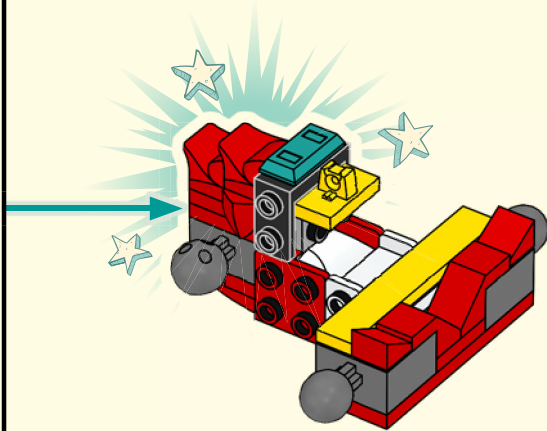



17

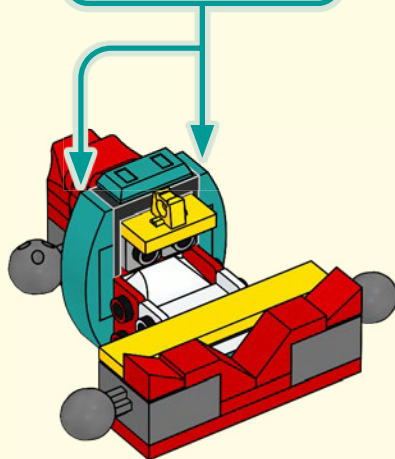
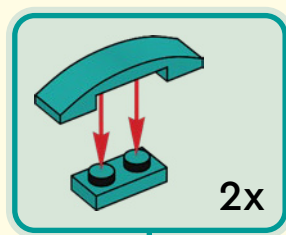



1x



1x

18

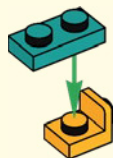

1x

19

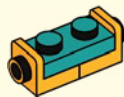



2x

20

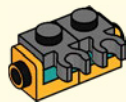

1x

21

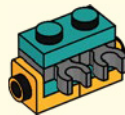



2x

22



1x



2x



1x

23

1

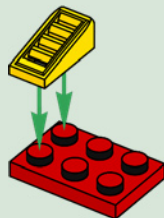

2

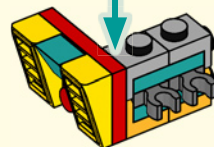
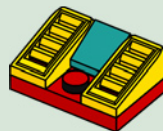

24

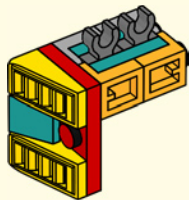

25

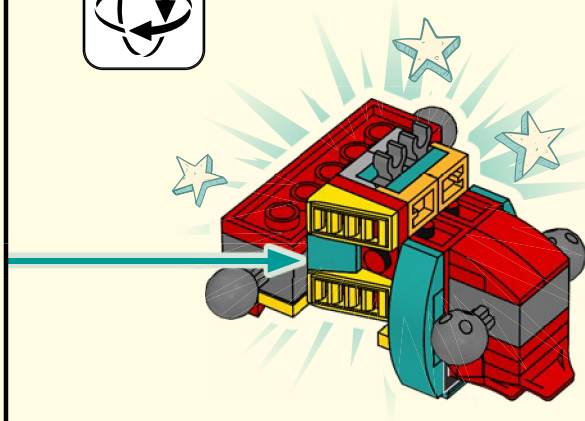



26

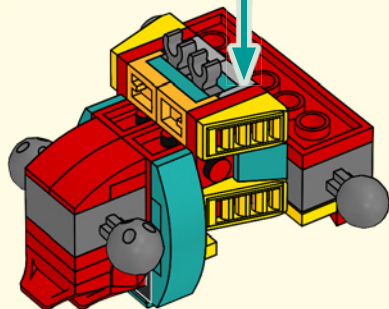
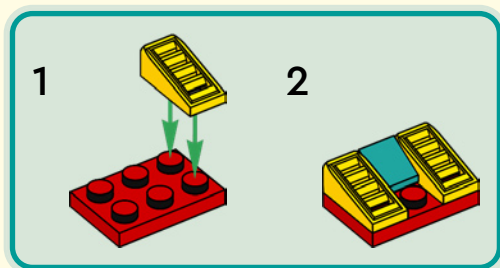





27

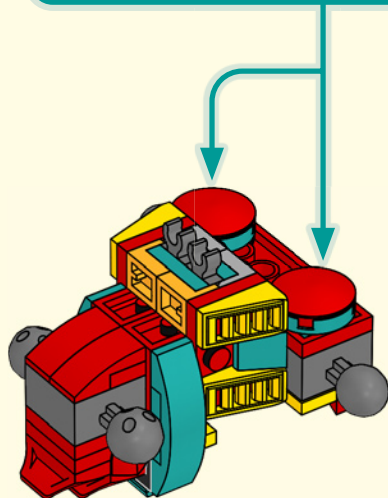
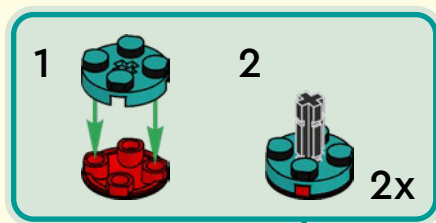



1x



1x

28

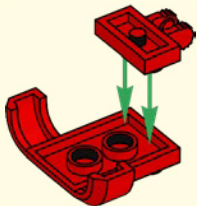

1x

29



30

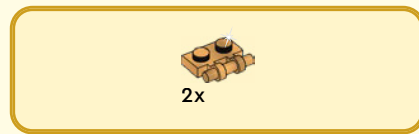
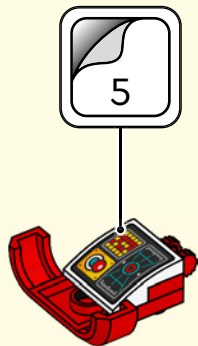

31





1x

32

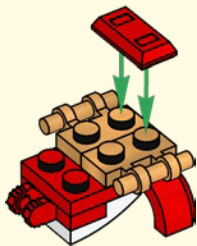

1x

33





2x

34

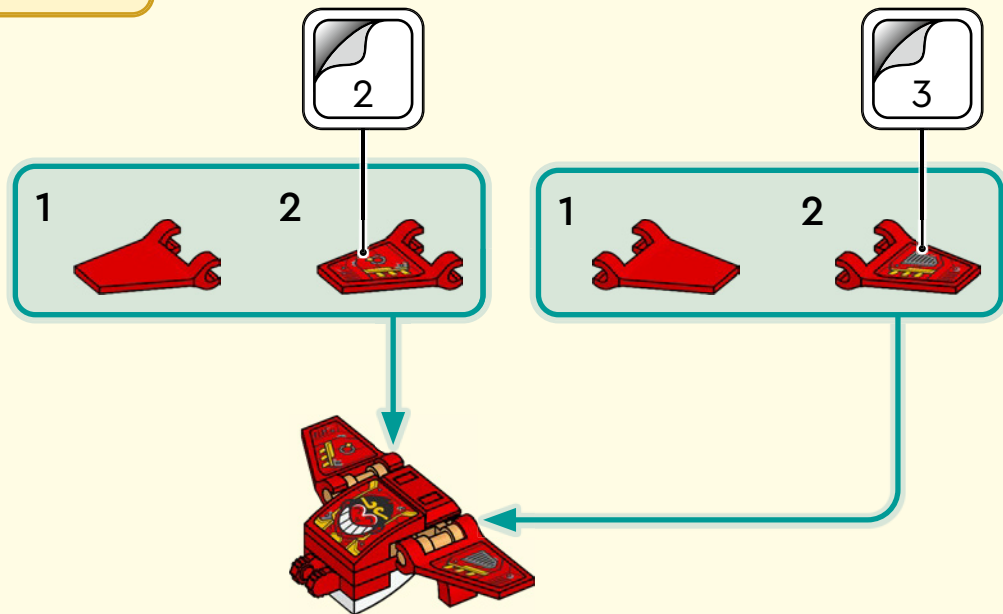

35

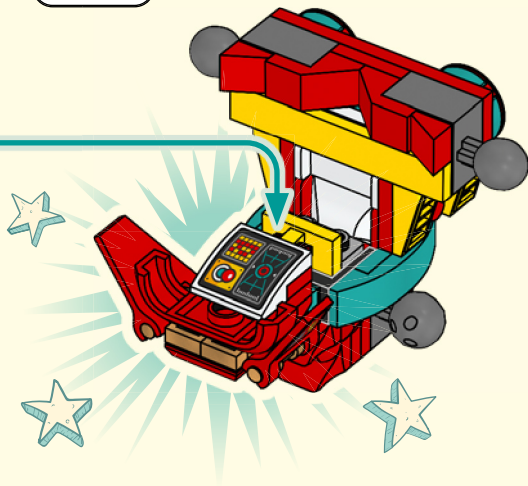

36

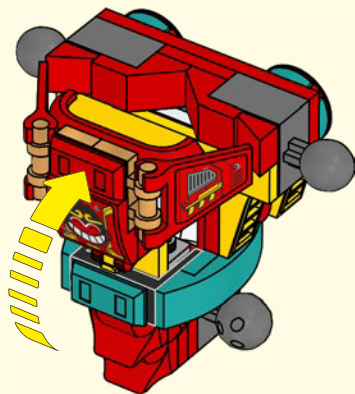

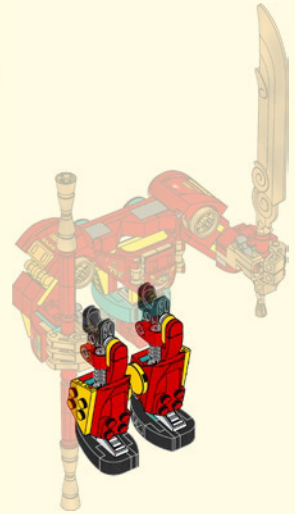

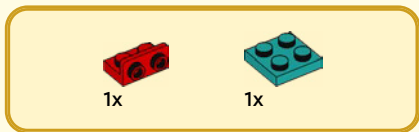

37

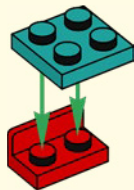

38

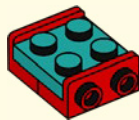





1x

39

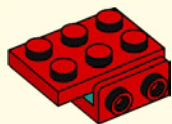

1x



2x

40

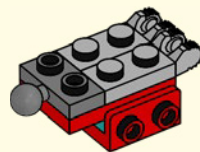



1x

41

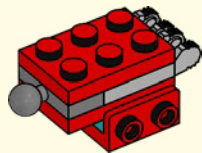

2x

42

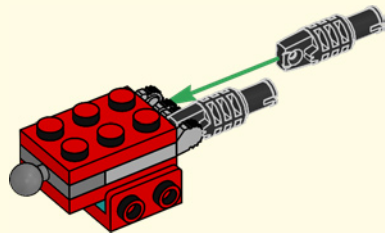



1x

43

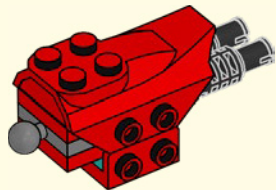

1x

44

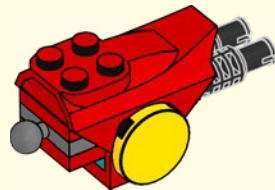



1x

45

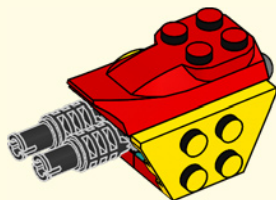

1x

46

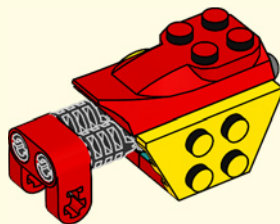



1x



1x

47

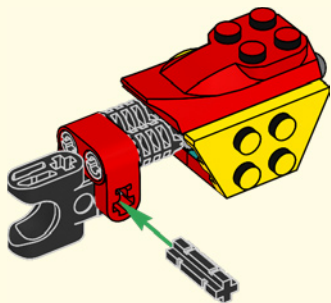

1x

48

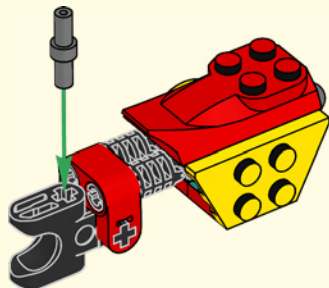



49

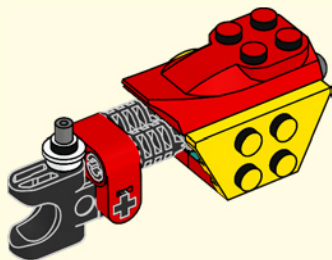

50

1

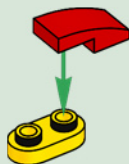

2

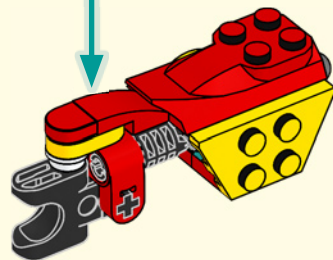



1x



1x

51

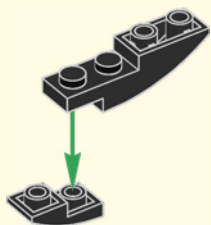

1x



1x

52

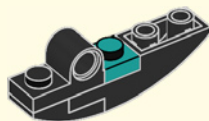



1x

53

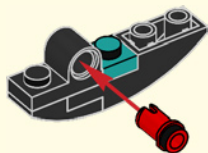

1x



1x

54

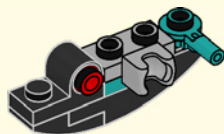





1x

55

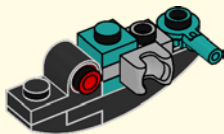

1x

56

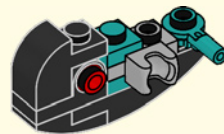



1x

57

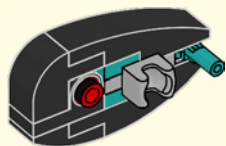

1x



1x



1x

58

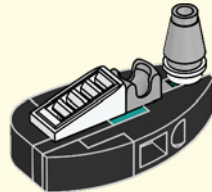
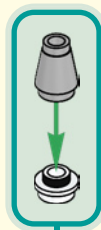

59

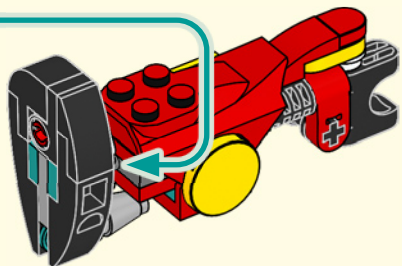

60

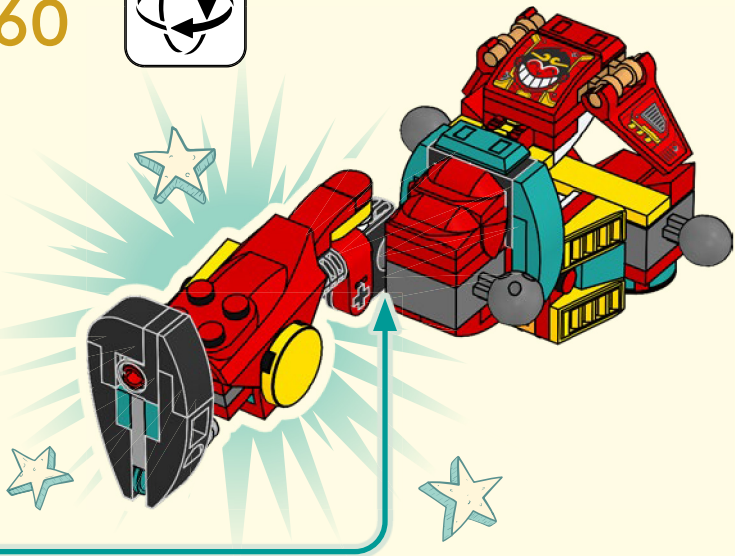

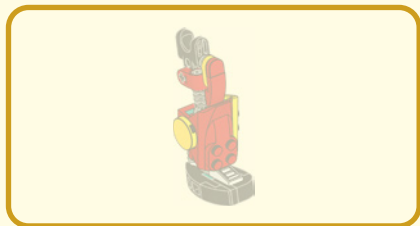

61

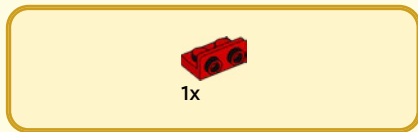
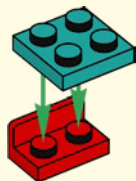

62

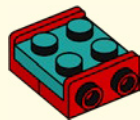



1x

63

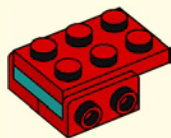

1x



2x

64

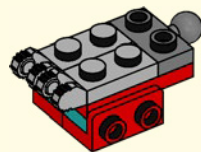



1x

65

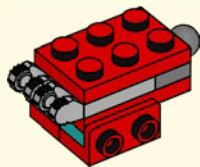

2x

66

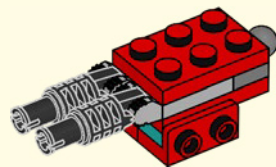



1x

67

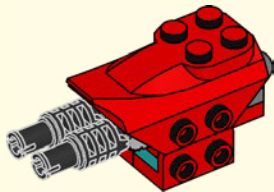

1x

68

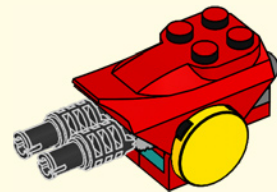



1x

69

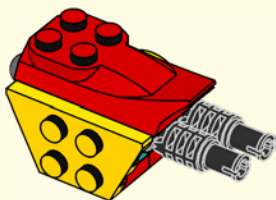

1x

70

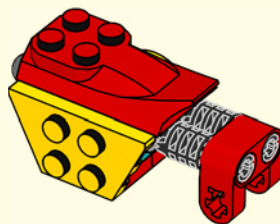





1x



1x

71

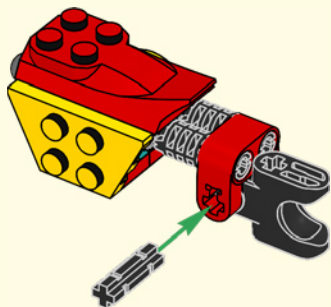

1x

72

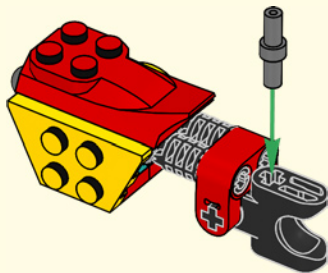



1x

73

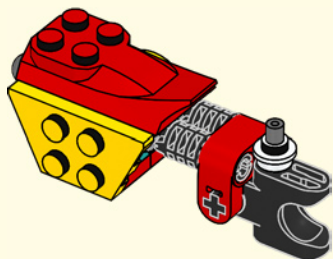

1x



1x



1x

74

1



2

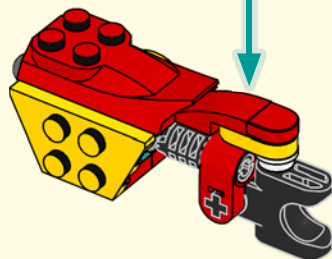



1x



1x

75

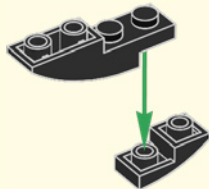

1x



1x

76

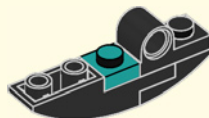



1x

77

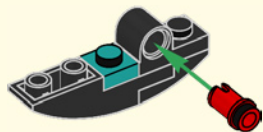

1x



1x

78

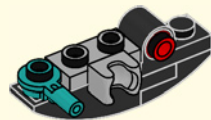



1x

79

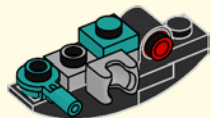

1x

80

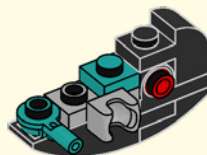



1x

81

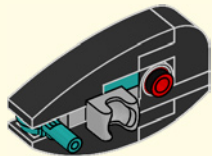

1x



1x



1x

82

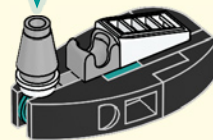
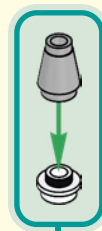

83

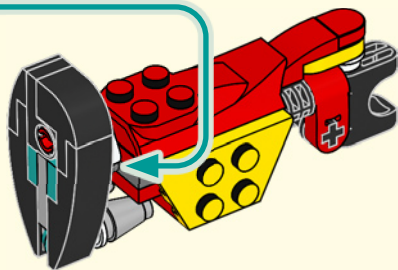

84

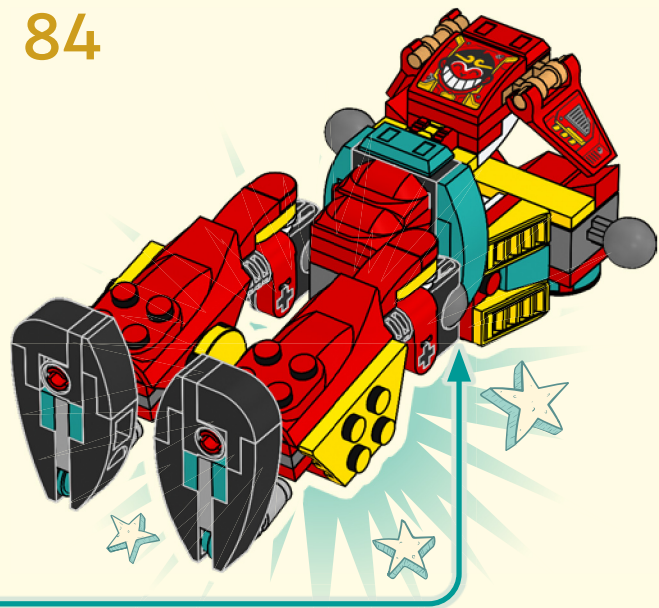

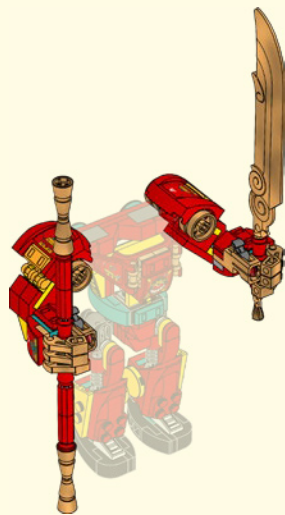





1x

85

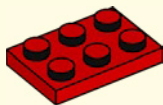

1x



1x

86

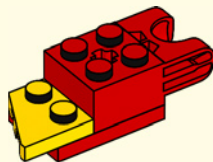



1x

87

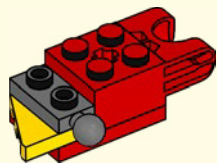

2x

88

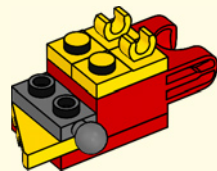



2x

89

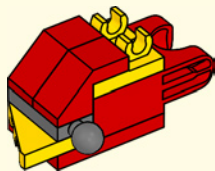

90

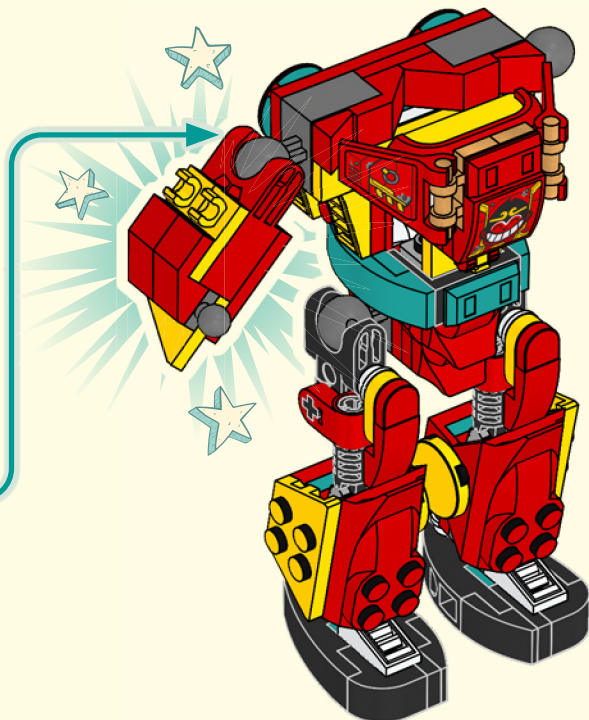



1x



1x

91

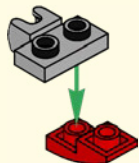

1x



1x

92

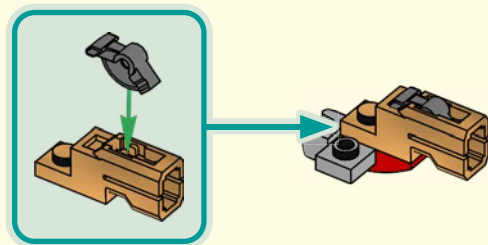



1x



1x

93

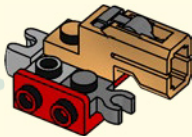
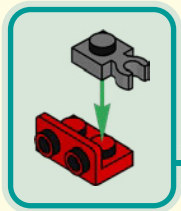

1x

94

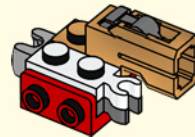



1x

95

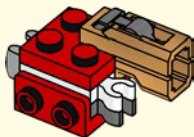



1x



1x

96

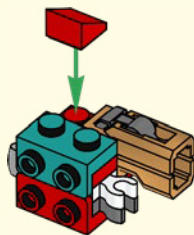

1x

97





1x



1x

98

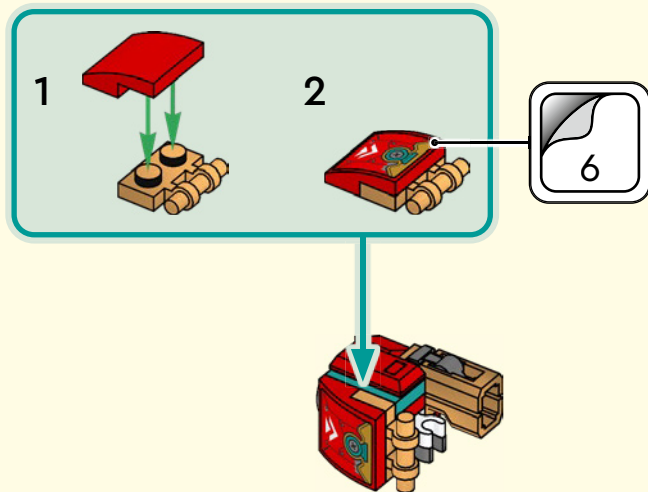





3x

99



100

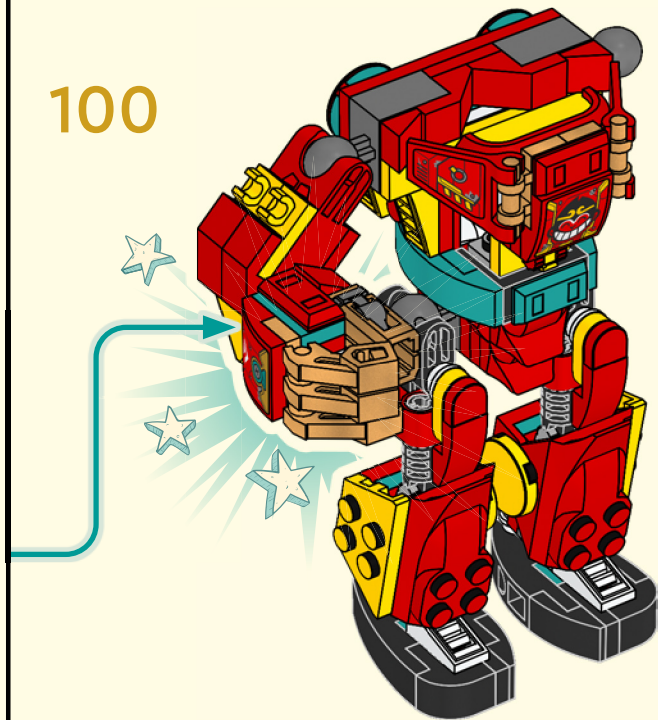



1x

101



1x



1x

102

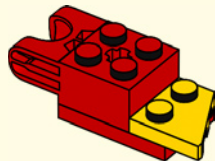



1x

103

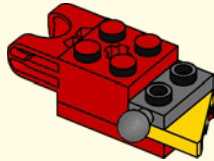

2x

104

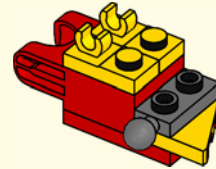



2x

105

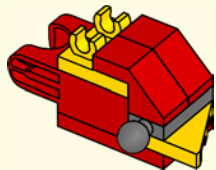

106

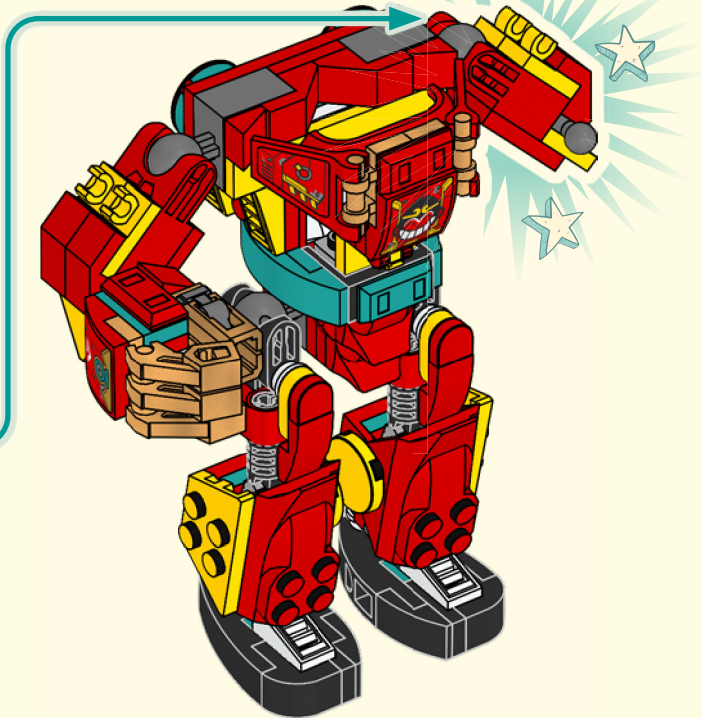



1x



1x

107

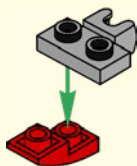

1x



1x

108

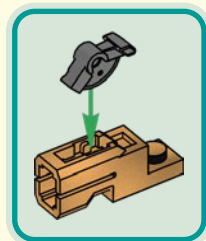



1x



1x

109

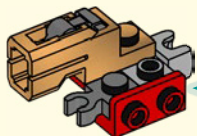
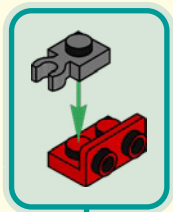

1x

110

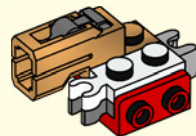



111

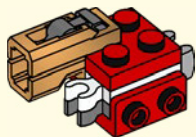

112

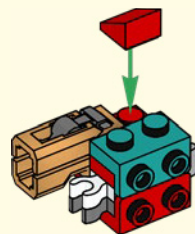



1x

113

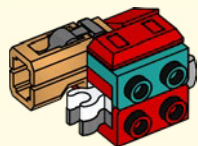





1x



1x

# 114

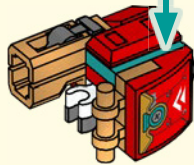
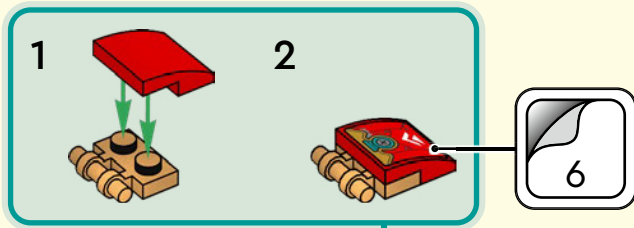

3x

# 115



116

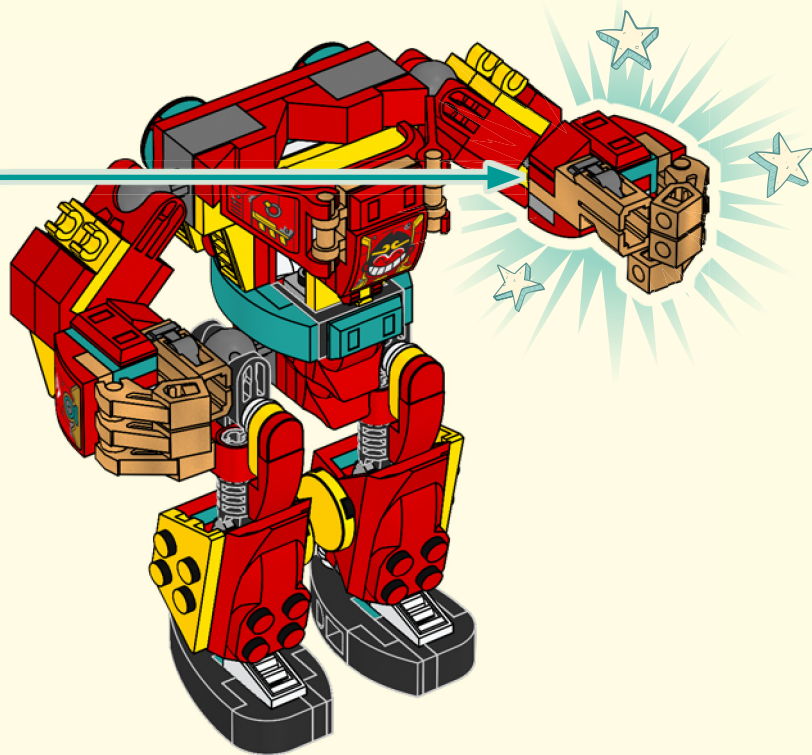



2x



2x



2x



4x



4x



2x

117

1

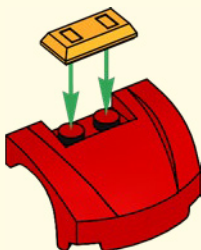

2

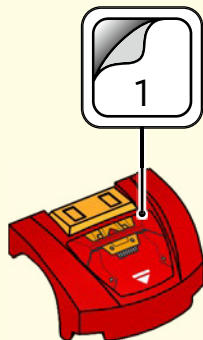

3

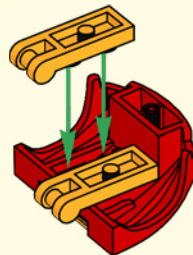

4

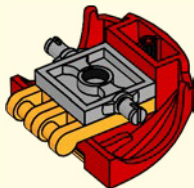

5

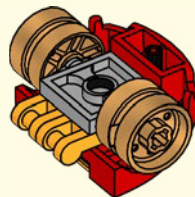

2x

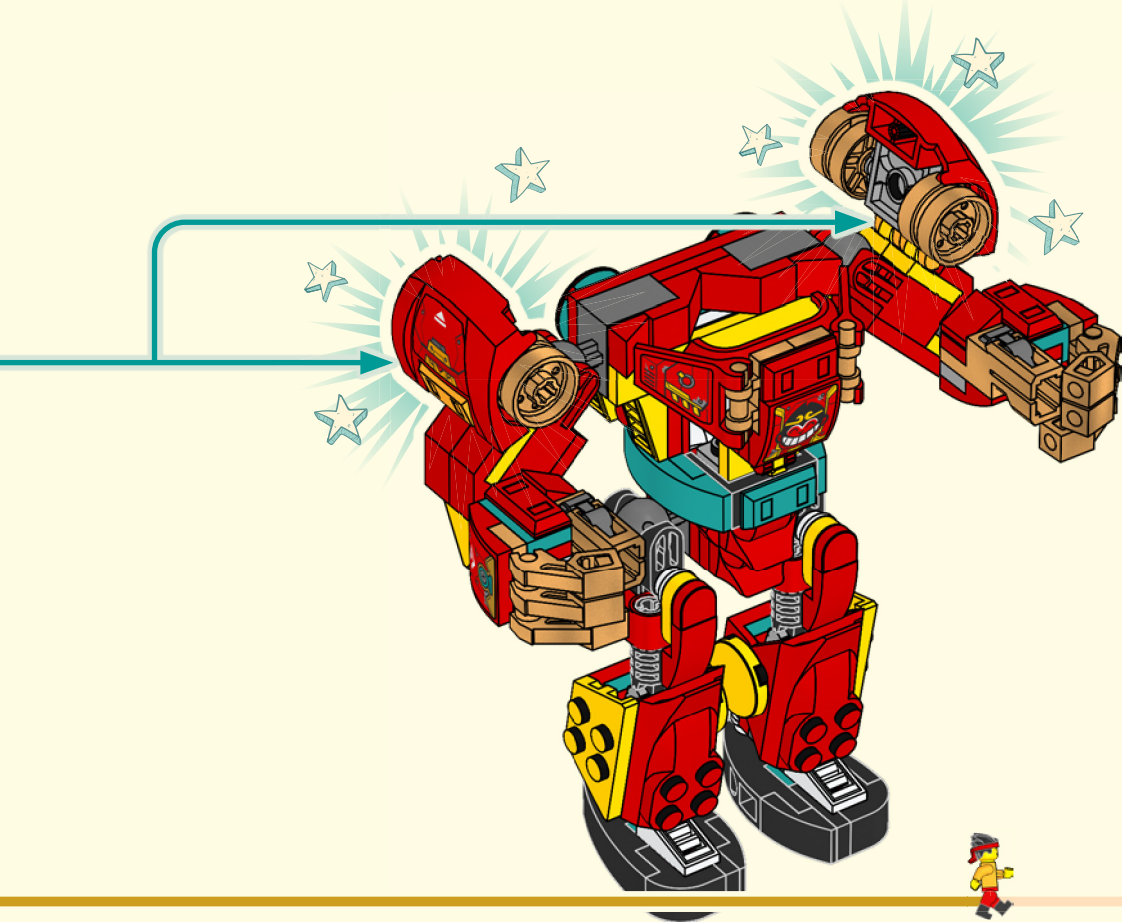

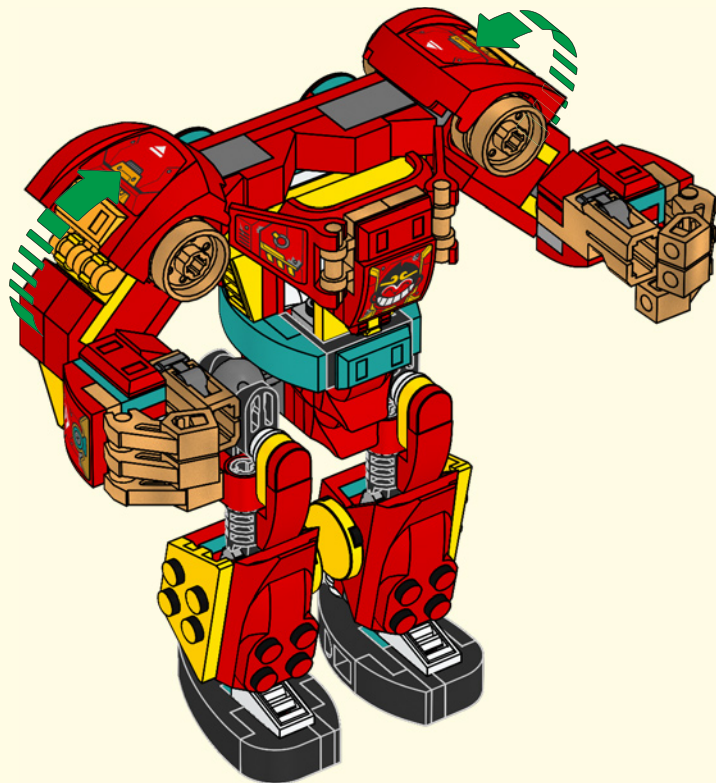

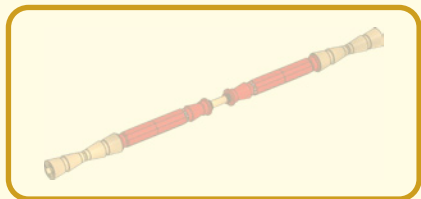

119

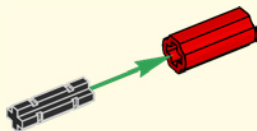

120

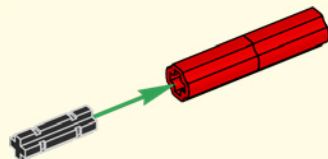



1x



1x

121

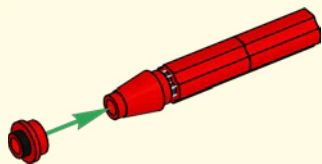

1x

122







2x



2x



1x



1x

# 123

1

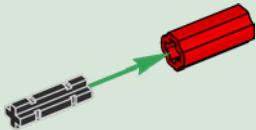

2

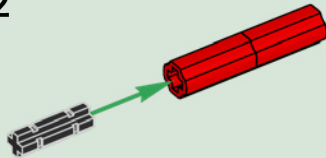

3

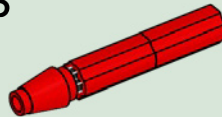

4

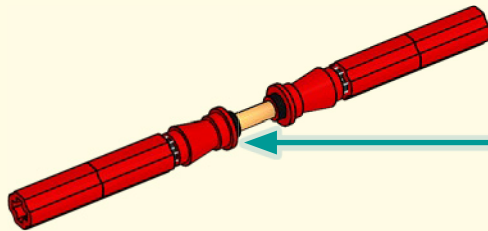
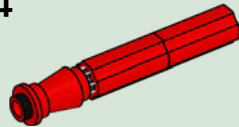



2x



1x



1x

124

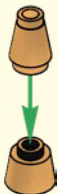

1x

125

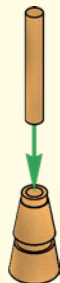



1x



1x



1x

# 126

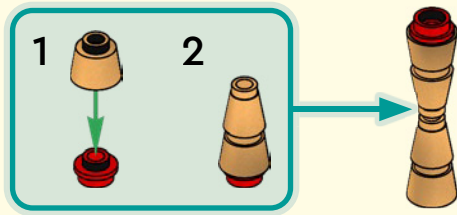

1x

# 127

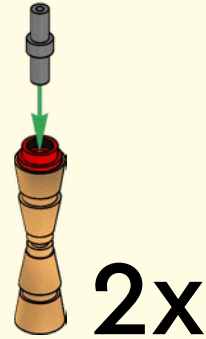

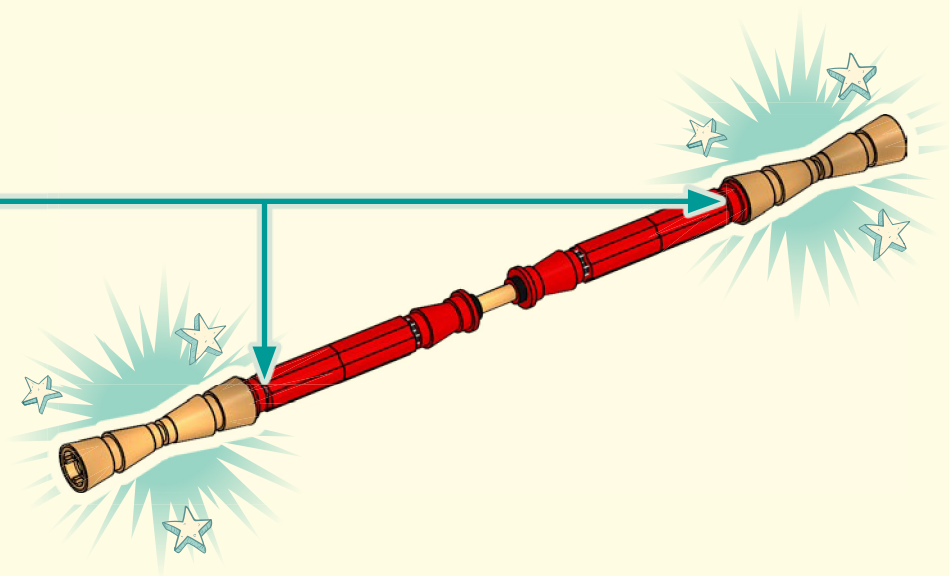

129

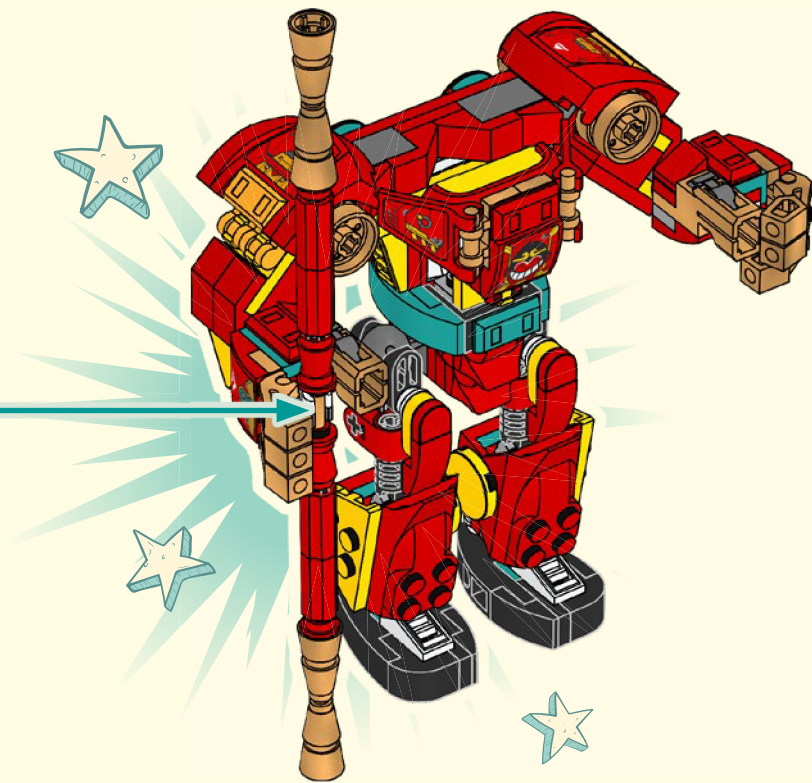

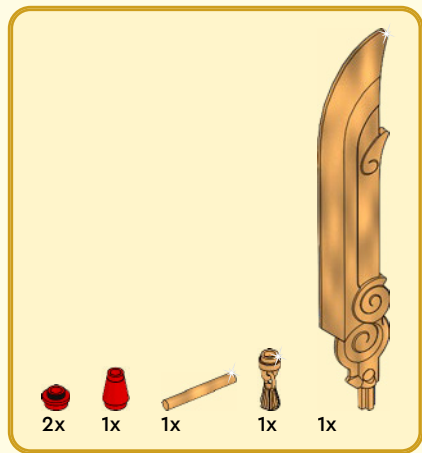

130

1

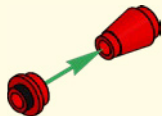

2

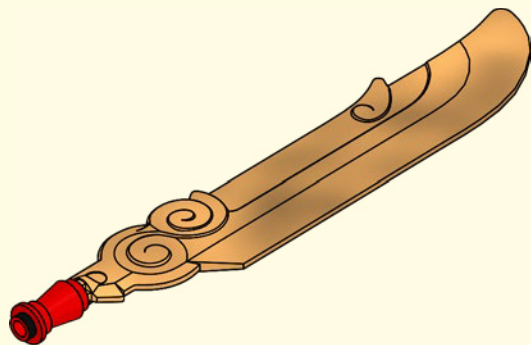

3

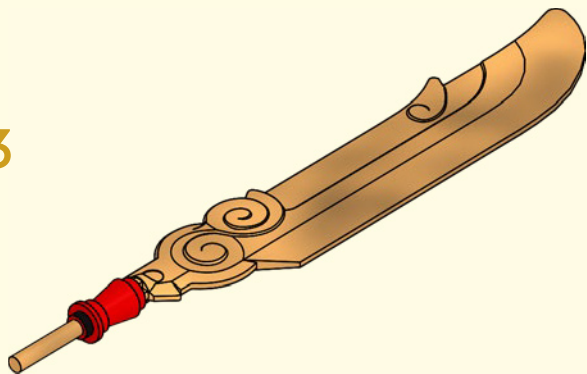

4

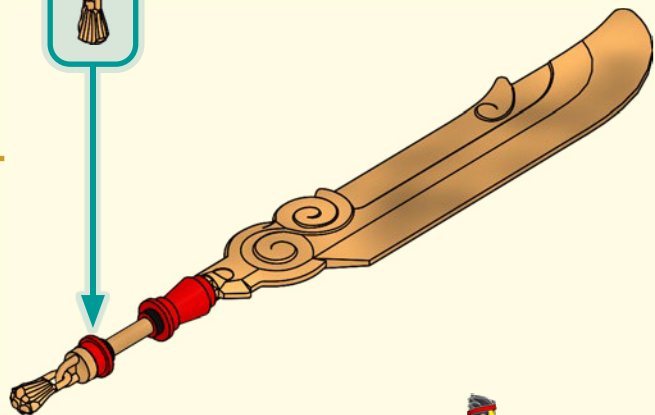

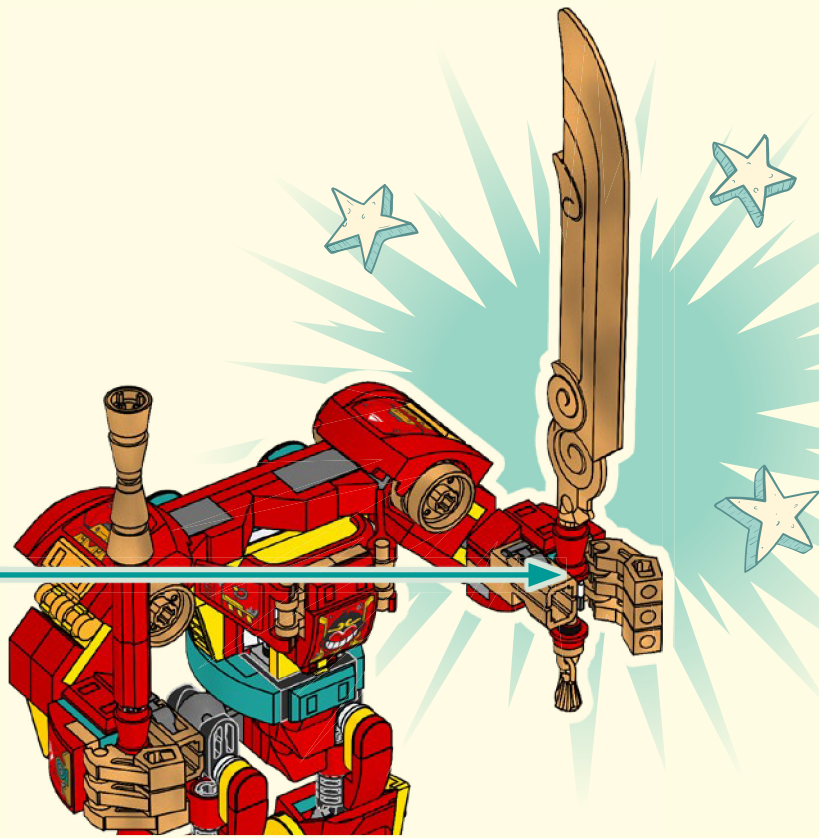



4x

131

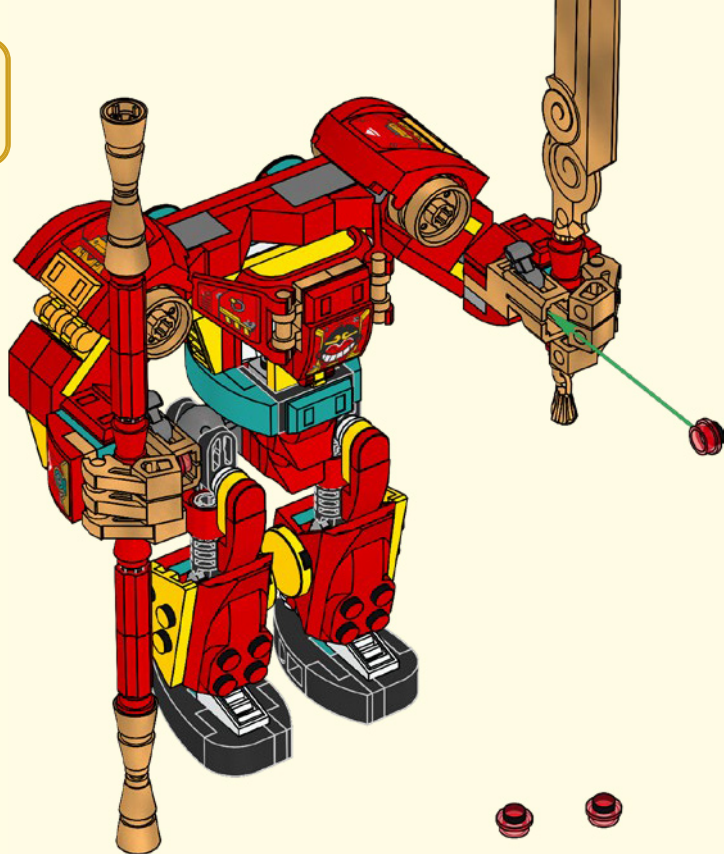

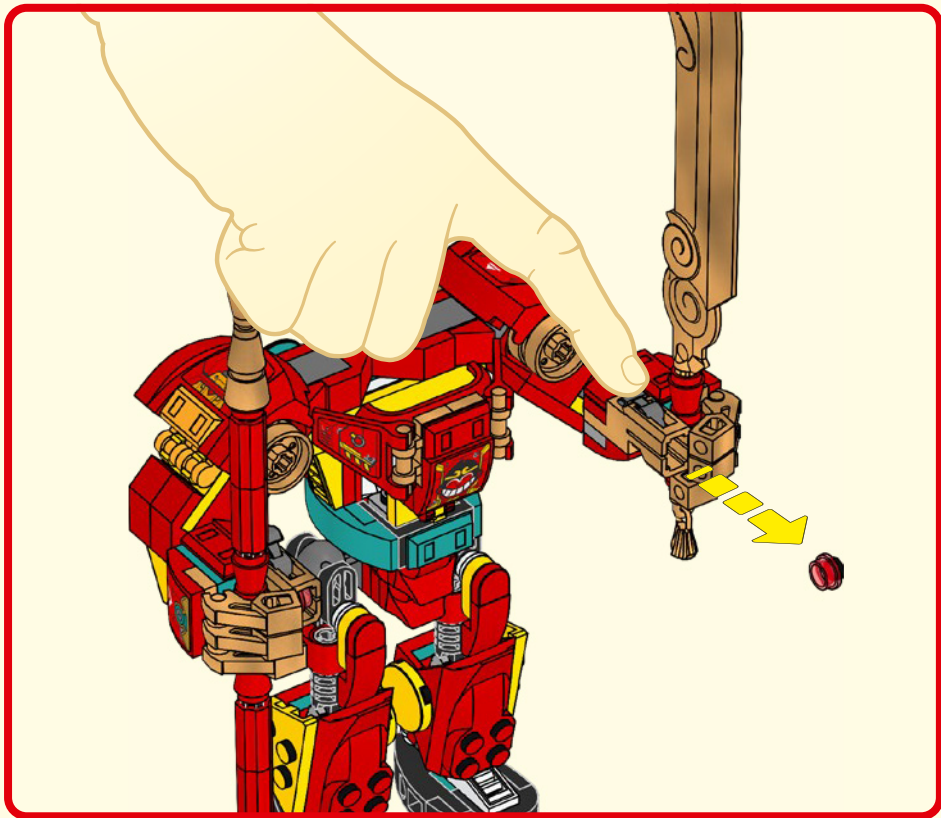

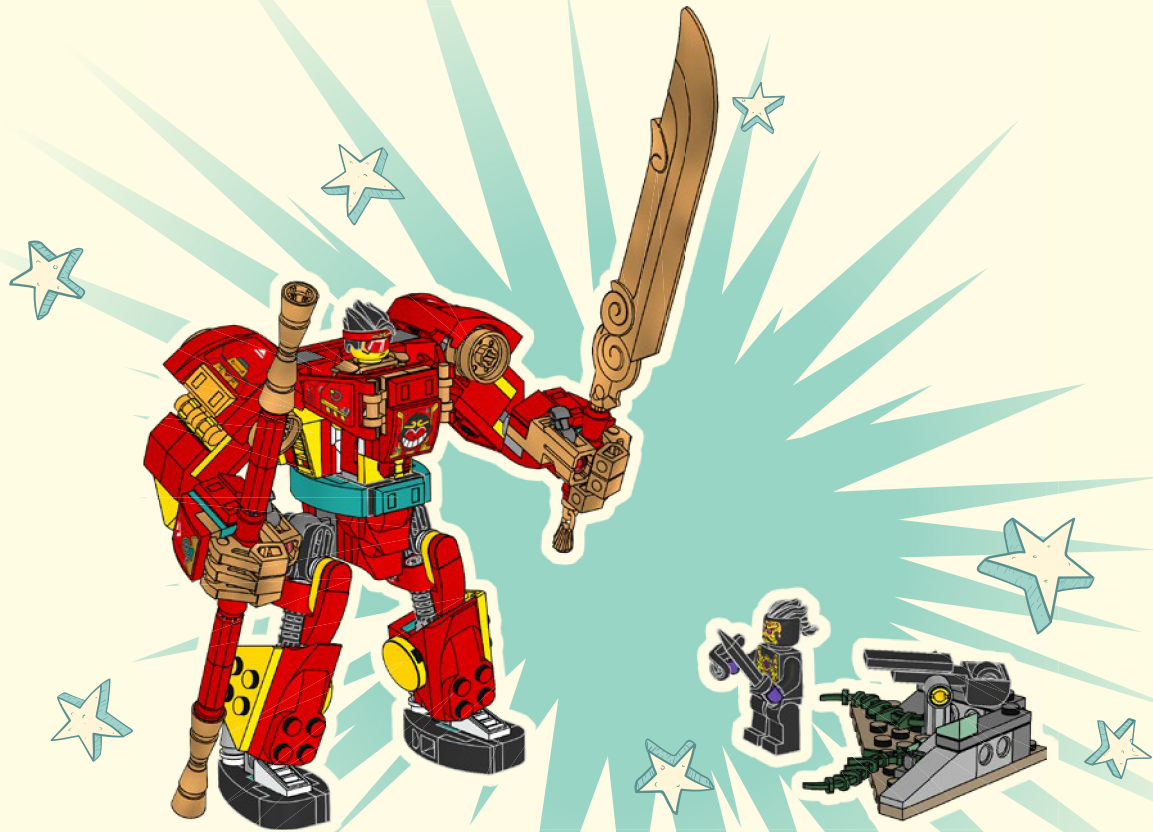



# MONKIE KID 悟空小侠



**COMBINE  
80040+80041**

**À COMBINER AVEC  
80040 ET 80041**

**COMBINA  
80040+80041**



**LEGO**

# MONKIE KID 悟空小侠

**COMBINE  
80036+80044**

**À COMBINER AVEC  
80036 ET 80044**

**COMBINA  
80036+80044**



|               |               |               |               |               |               |               |               |
|---------------|---------------|---------------|---------------|---------------|---------------|---------------|---------------|
| 4x<br>6168642 | 2x<br>6258973 | 2x<br>6375708 | 1x<br>6296954 | 1x<br>6132609 | 3x<br>306226  | 2x<br>6114987 | 1x<br>6225386 |
| 2x<br>6337079 | 2x<br>6378120 | 4x<br>6186398 | 10x<br>302121 | 2x<br>6248971 | 2x<br>6422913 | 2x<br>6184784 | 4x<br>6208450 |
| 2x<br>6023804 | 4x<br>4504379 | 1x<br>6266205 | 2x<br>6406930 | 1x<br>6132201 | 1x<br>6417491 | 4x<br>6271542 | 4x<br>6213778 |
| 2x<br>6372037 | 2x<br>6224467 | 6x<br>6275178 | 2x<br>6078279 | 2x<br>6078279 | 1x<br>6422914 | 2x<br>6338289 | 2x<br>6278172 |
| 1x<br>6218822 | 2x<br>4278275 | 2x<br>6001806 | 1x<br>6331822 | 1x<br>6331822 | 2x<br>6380236 | 1x<br>6424050 | 2x<br>6333124 |
| 1x<br>4494474 | 4x<br>4513174 | 6x<br>6089698 | 2x<br>6170382 | 4x<br>4540384 | 1x<br>6303189 | 1x<br>6424050 | 2x<br>6210400 |
| 1x<br>6210385 | 1x<br>6366646 | 2x<br>6365503 | 2x<br>6422923 | 4x<br>6360077 | 2x<br>6279875 | 1x<br>4558170 | 1x<br>6391344 |
| 1x<br>6261357 | 2x<br>6349275 | 2x<br>242021  | 2x<br>6371695 | 1x<br>6410523 | 8x<br>4109810 | 1x<br>6349964 | 4x<br>6213777 |
| 6x<br>6223427 | 3x<br>6394880 | 3x<br>6105976 | 2x<br>4582843 | 2x<br>4260192 | 1x<br>9339    | 2x<br>6037746 | 2x<br>6249418 |
| 3x<br>4529234 | 2x<br>6029946 | 1x<br>6375861 | 1x<br>6366649 | 1x<br>663624  | 2x<br>6147050 | 2x<br>6039869 | 2x<br>6249390 |



2x  
6249299



1x  
6338181

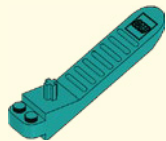

1x  
6254100



1x  
6395743



2x  
6369999



2x  
4652205



2x  
6233984



2x  
6249235



2x  
6236454



4x  
6248671



2x  
4529241



1x  
6296859



4x  
6248078



4x  
6043656



2x  
4211541



4x  
6267048



2x  
6408022



1x  
4622803



1x  
6013497



2x  
6344022



2x  
6360675



4x  
6350724



4x  
6296892



2x  
6039479



1x  
4211135



2x  
6123814



1x  
4624186



2x  
4497253



2x  
6257592



1x  
6065816



1x  
6274711



4x  
4529247



4x  
6173139



6x  
6262192

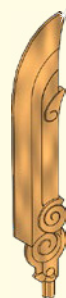

1x  
6408777



4x  
6279731



4x  
6268401



4x  
6093529



1x  
6303532



2x  
6345949



2x  
6294553



[LEGO.com/service](https://www.LEGO.com/service)



**YOU COULD**  
**WIN**



Scan this QR code or go to  
**LEGO.COM/PRODUCTFEEDBACK** and give  
us your short feedback about this LEGO® set  
for a chance to win a cool LEGO prize.

Terms and Conditions apply\*

**DE: Du könntest GEWINNEN.** Es gelten die Teilnahmebedingungen\* **FR: Tu pourrais GAGNER.** Des conditions s'appliquent\* **IT: Potresti VINCERE tu.** Termini e condizioni sono applicabili\* **ES: Puedes GANAR.** Aplican términos y condiciones\* **PT: Poderá GANHAR.** Aplicam-se termos e condições\* **JA: プレゼント付き! 利用規約が適用されます\*** **ZH: 轻松获奖. 条款和条件适用\*** **KO: 상품의 주인이 되어보세요. 소정의 약관이 적용됩니다\*** **RU: Вы можете ВЫИГРАТЬ.** Действуют положения и условия\* **PL: Szansa na WYGRANĄ.** Obowiązują warunki korzystania\* **CS: Máte šanci VYHRÁT.** Platí všeobecné smluvní podmínky\* **SK: Máte šancu VYHRAŤ.** Platia všeobecné zmluvné podmienky\* **HU: TE IS NYERHETSZ.** Felhasználási feltételek érvényesek\* **RO: Ai putea CÂȘTIGA.** Se aplică termenii și condițiile\* **BG: Можете да СПЕЧЕЛИТЕ.** Има определени правила и условия\* **LV: Tu vari LAIMĒT.** Ir spēkā noteikumi un nosacījumi.\* **ET: Sul on võimalus VÕITA.** Kehtivad tingimused\* **LT: Jūs galite LAIMĖTI.** Taikomos sąlygos\*

\*[LEGO.com/productfeedback-terms](https://www.lego.com/productfeedback-terms)

LEGO and the LEGO logo are trademarks of the/sont des marques de commerce du/  
son marcas registradas de LEGO Group. ©2023 The LEGO Group.

6446312