



# STAR WARS

TM



7964





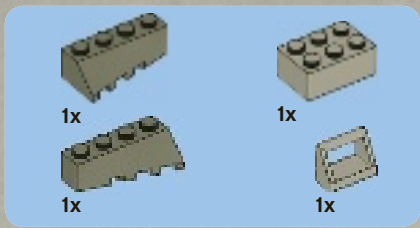

# 21

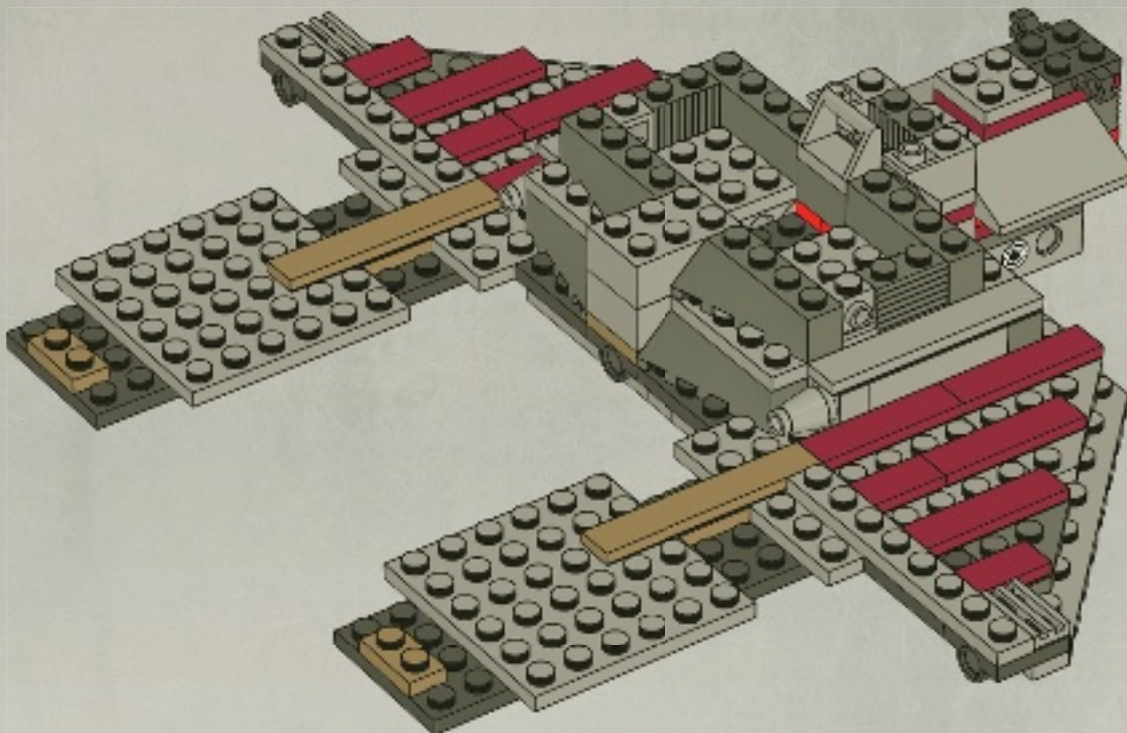



2x



2x



2x



4x



4x

# 22

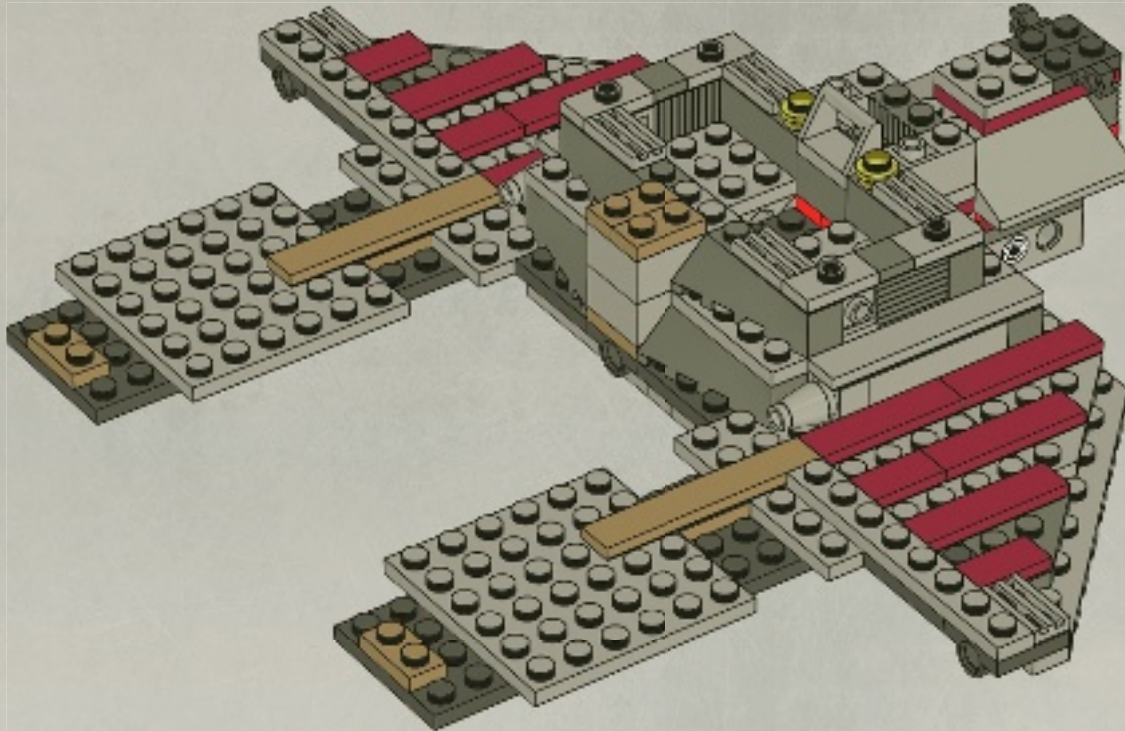



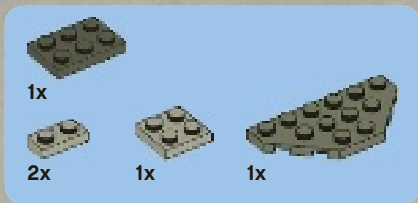

23

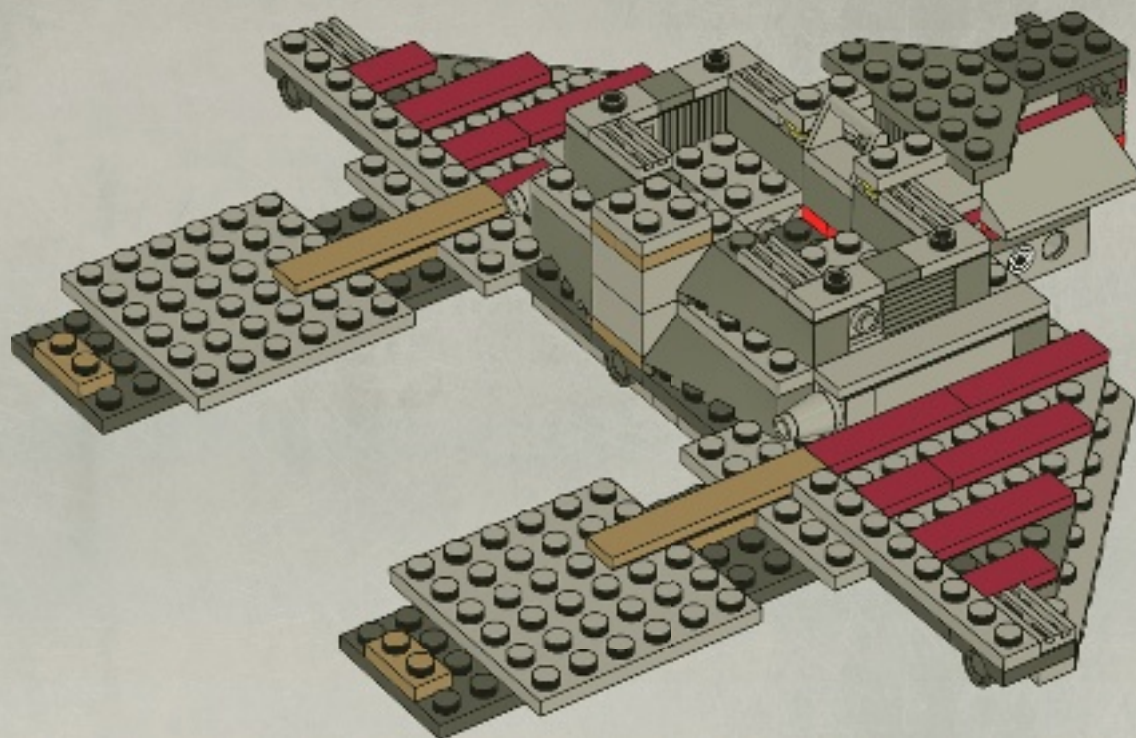



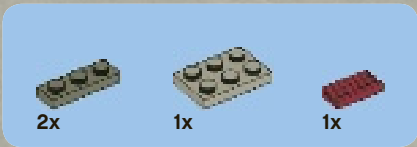

24

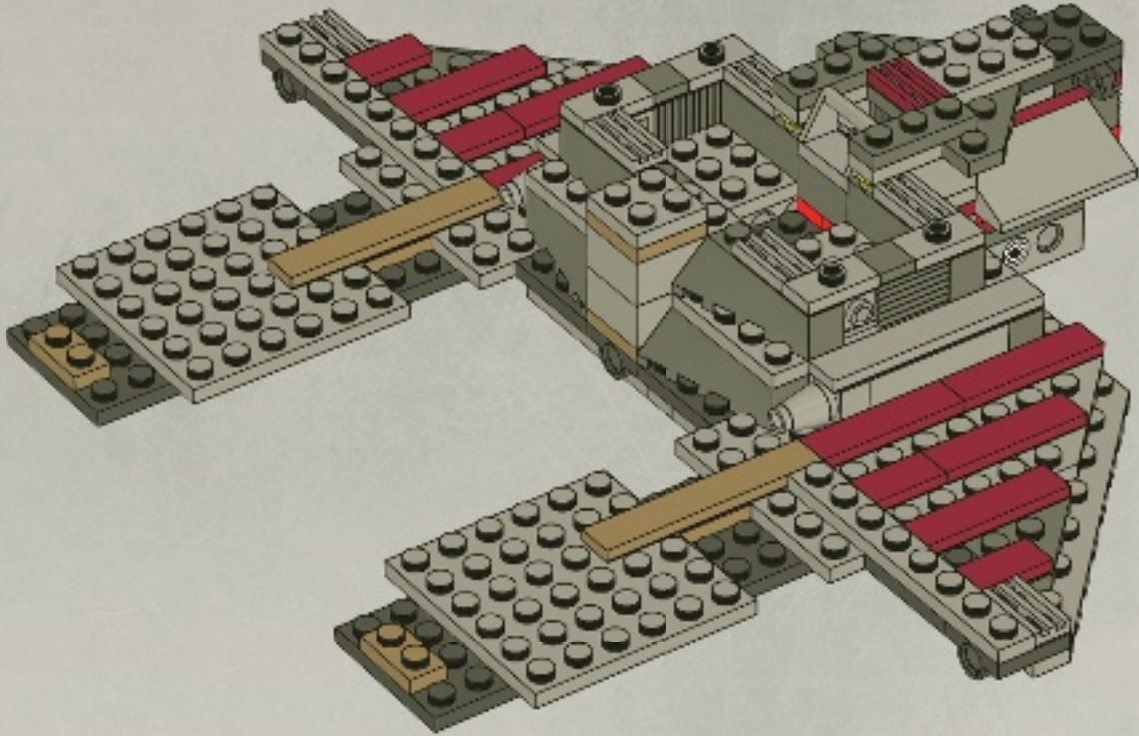

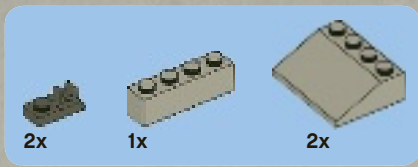

25

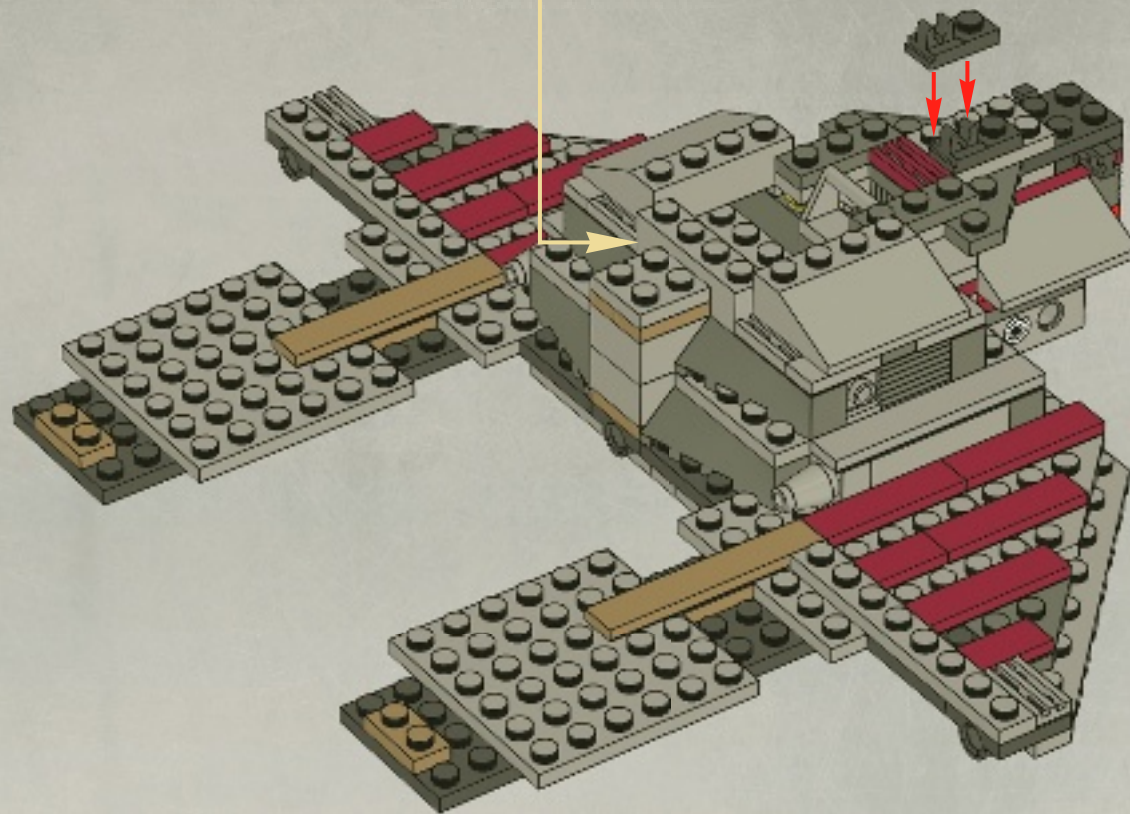
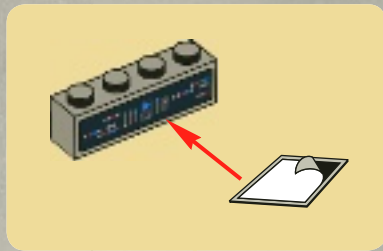



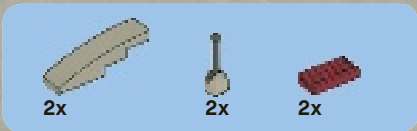

# 26

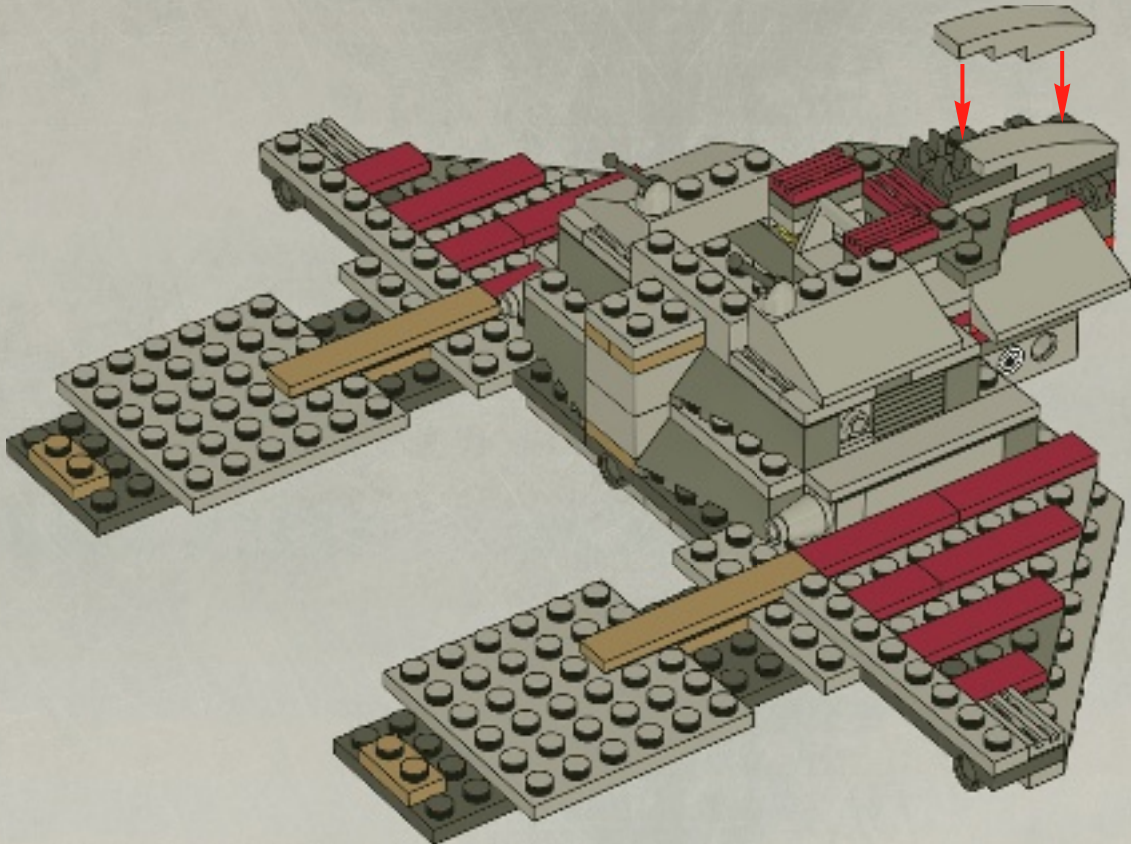



27

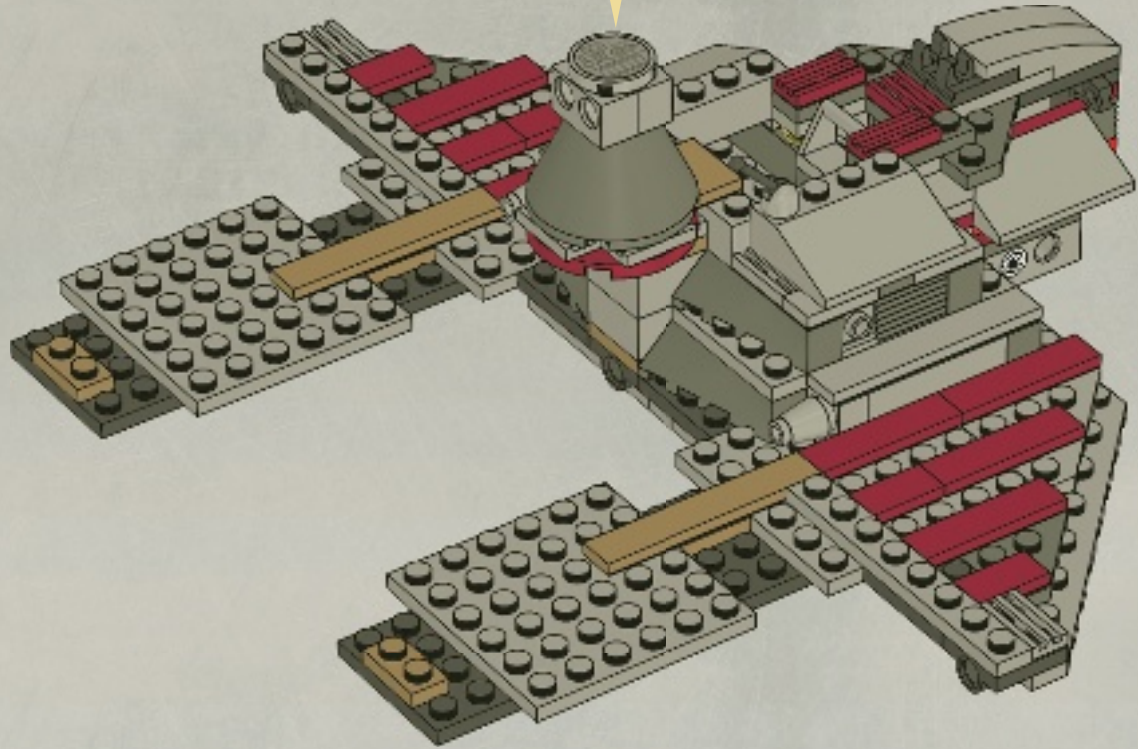
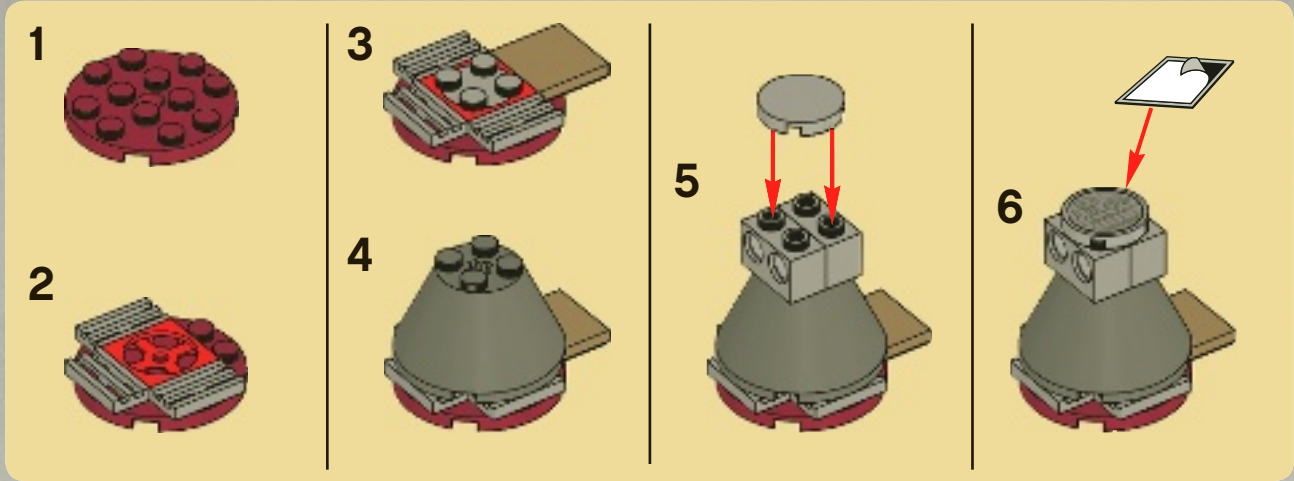



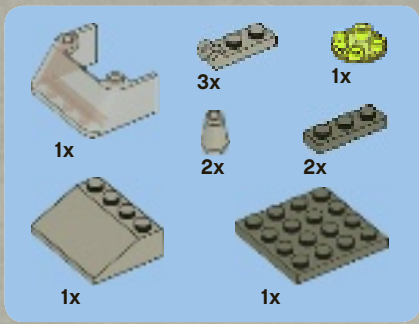

28

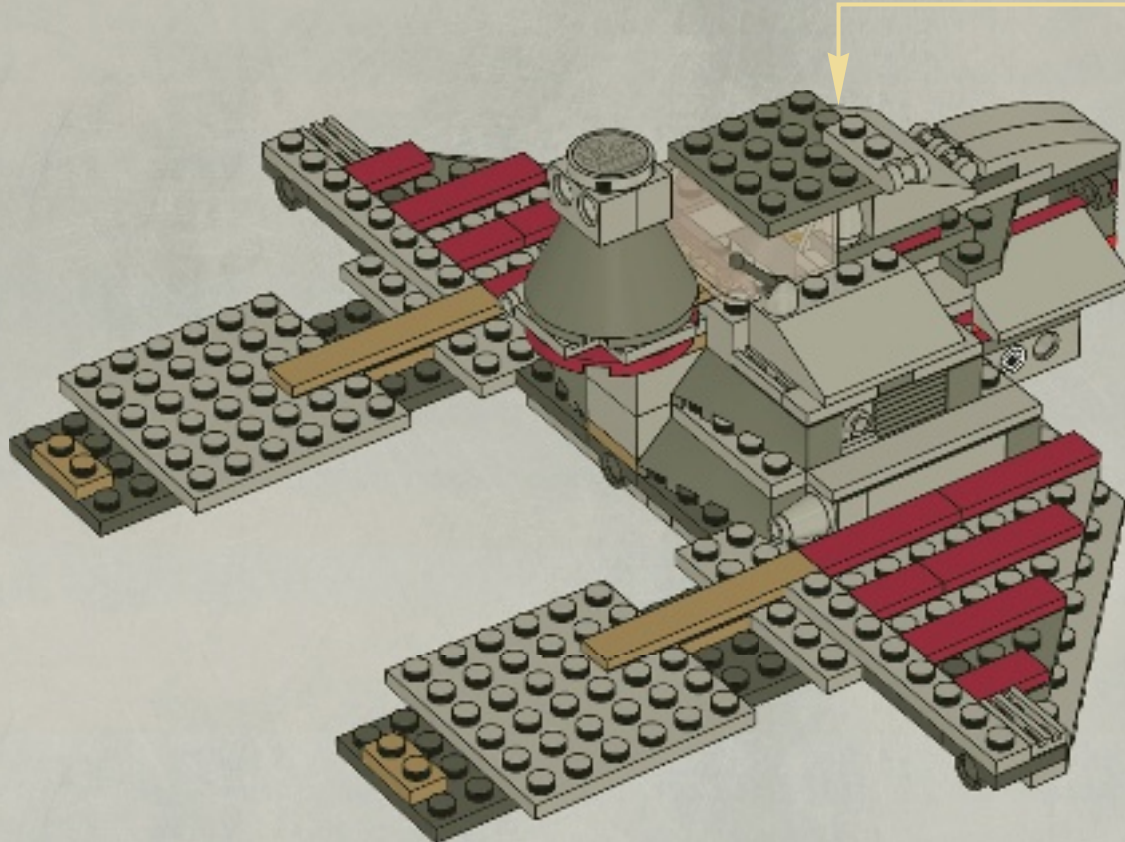
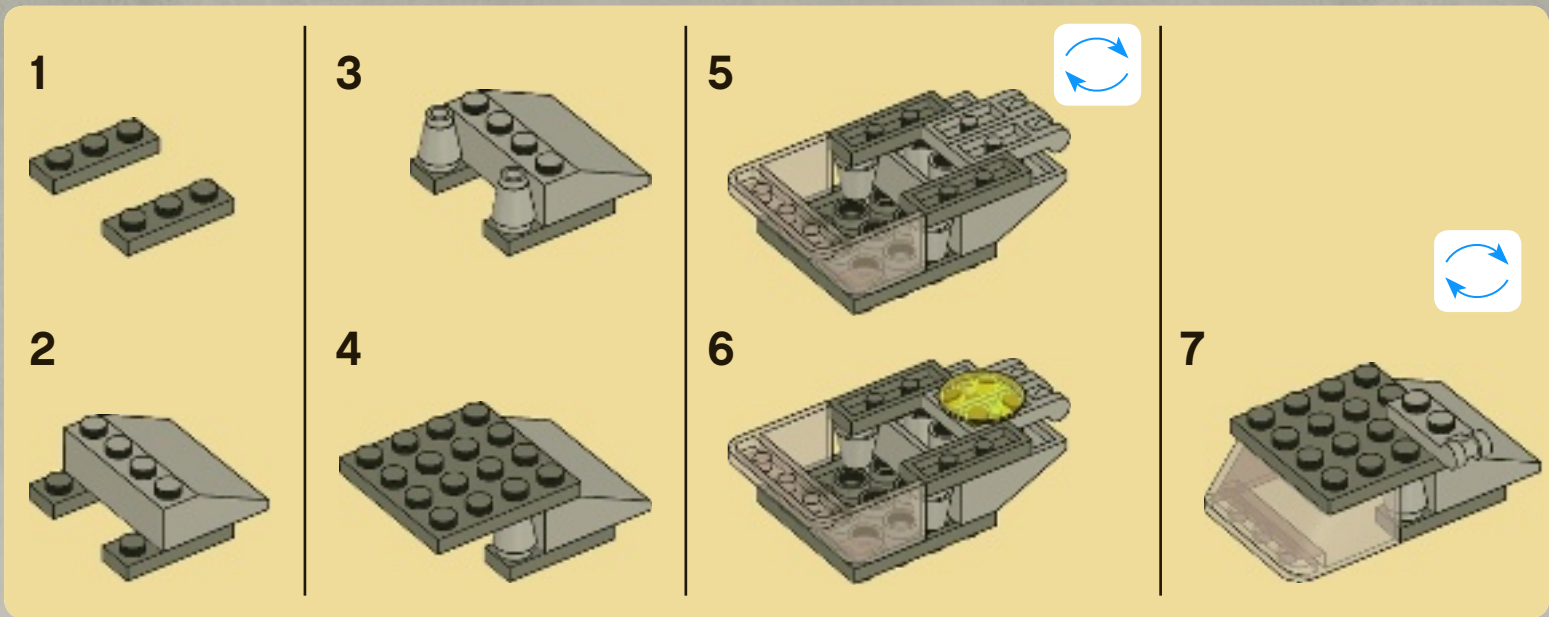



1x

# 29

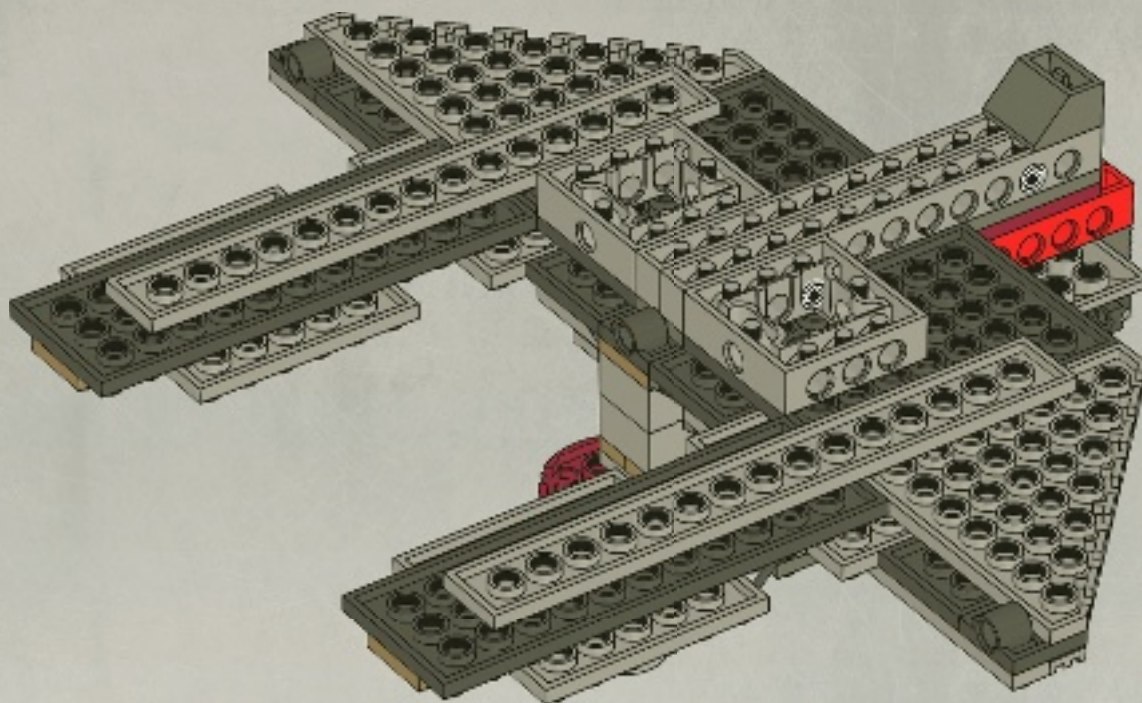



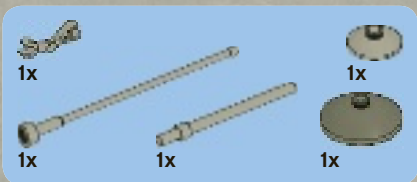

30

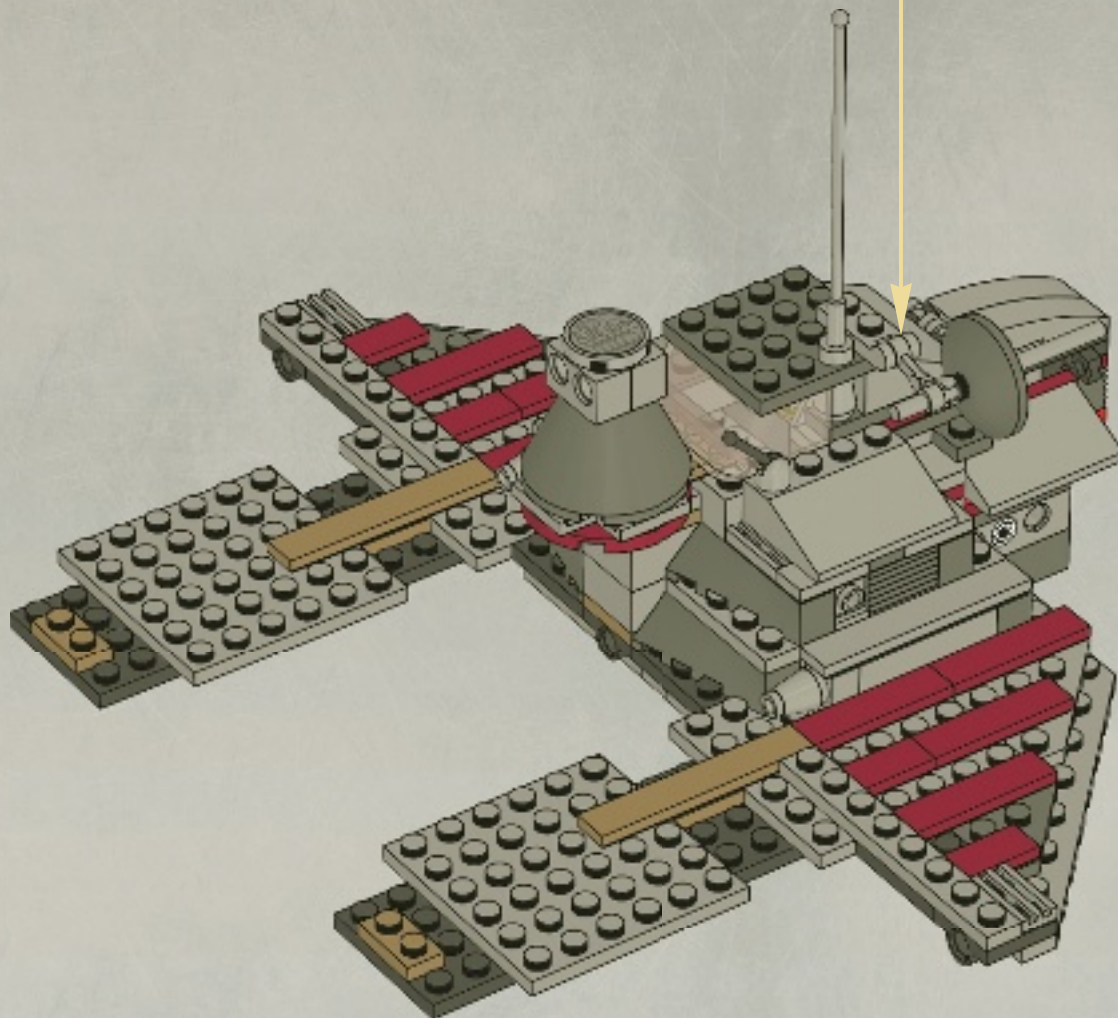

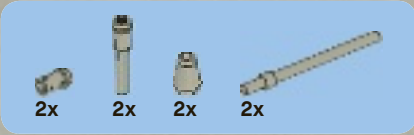

31

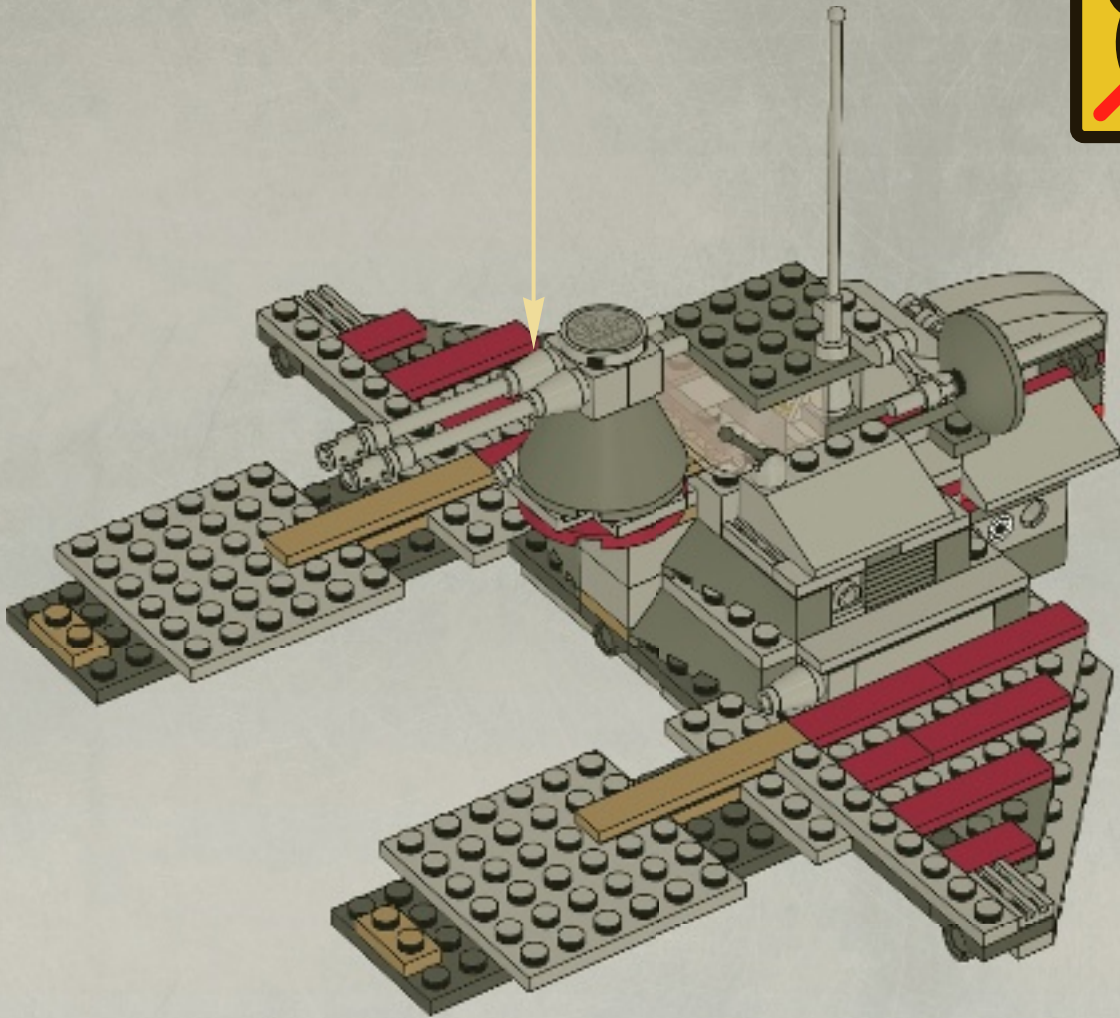
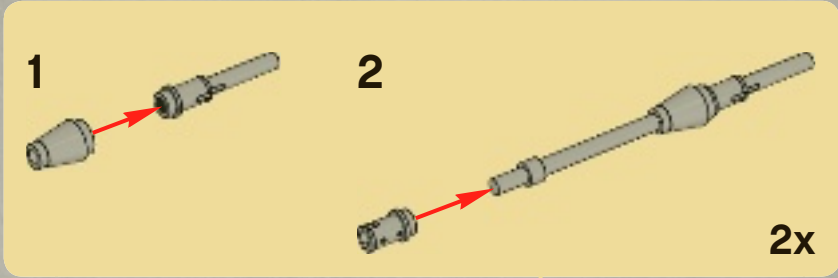



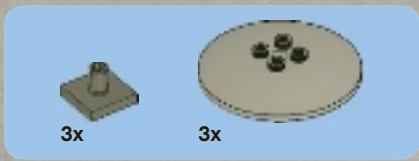

32

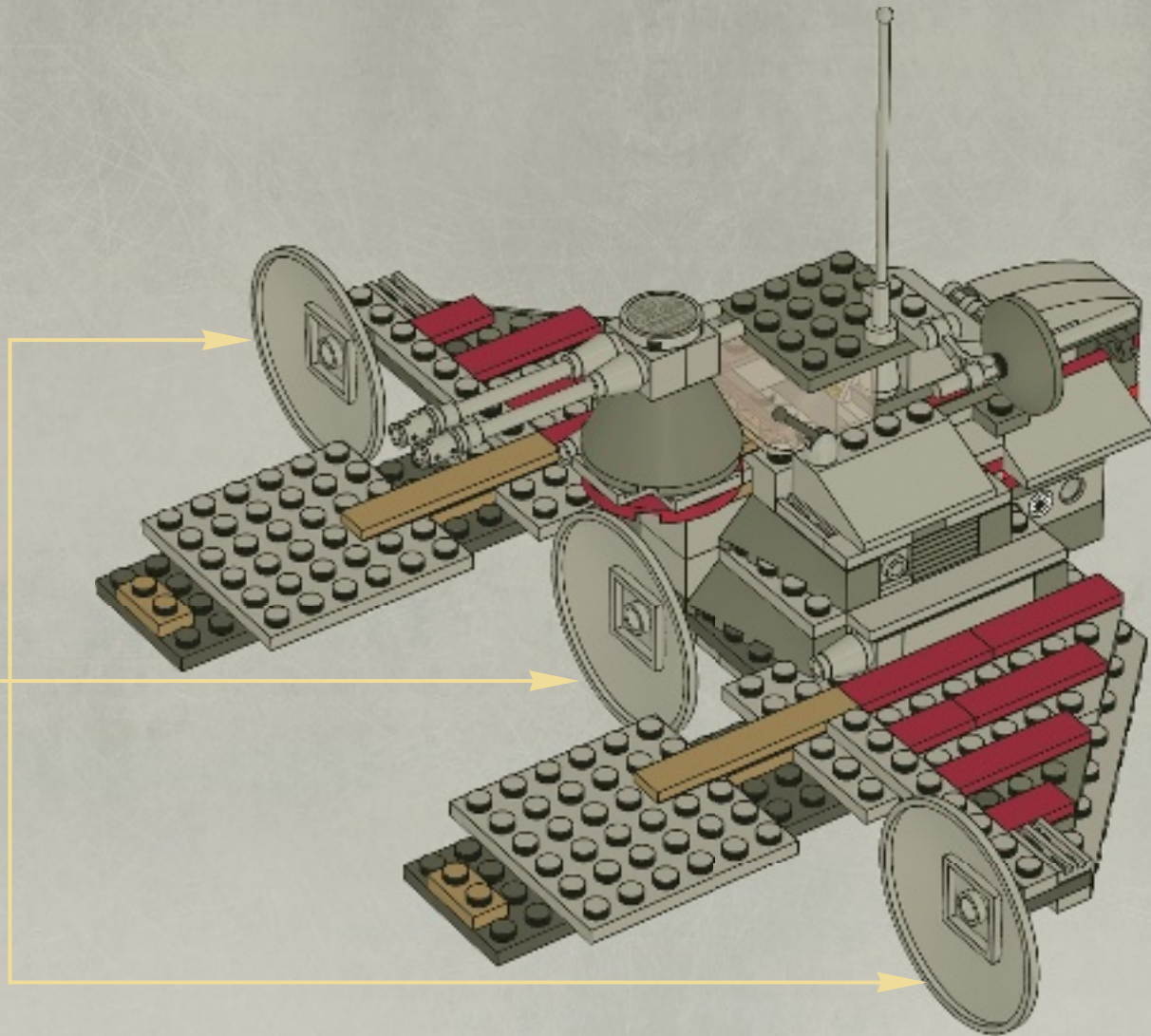
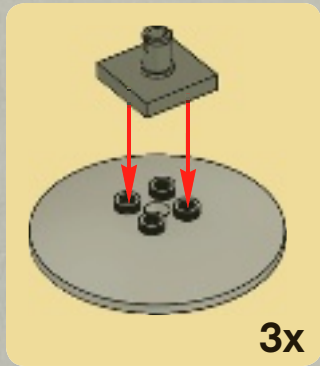

33

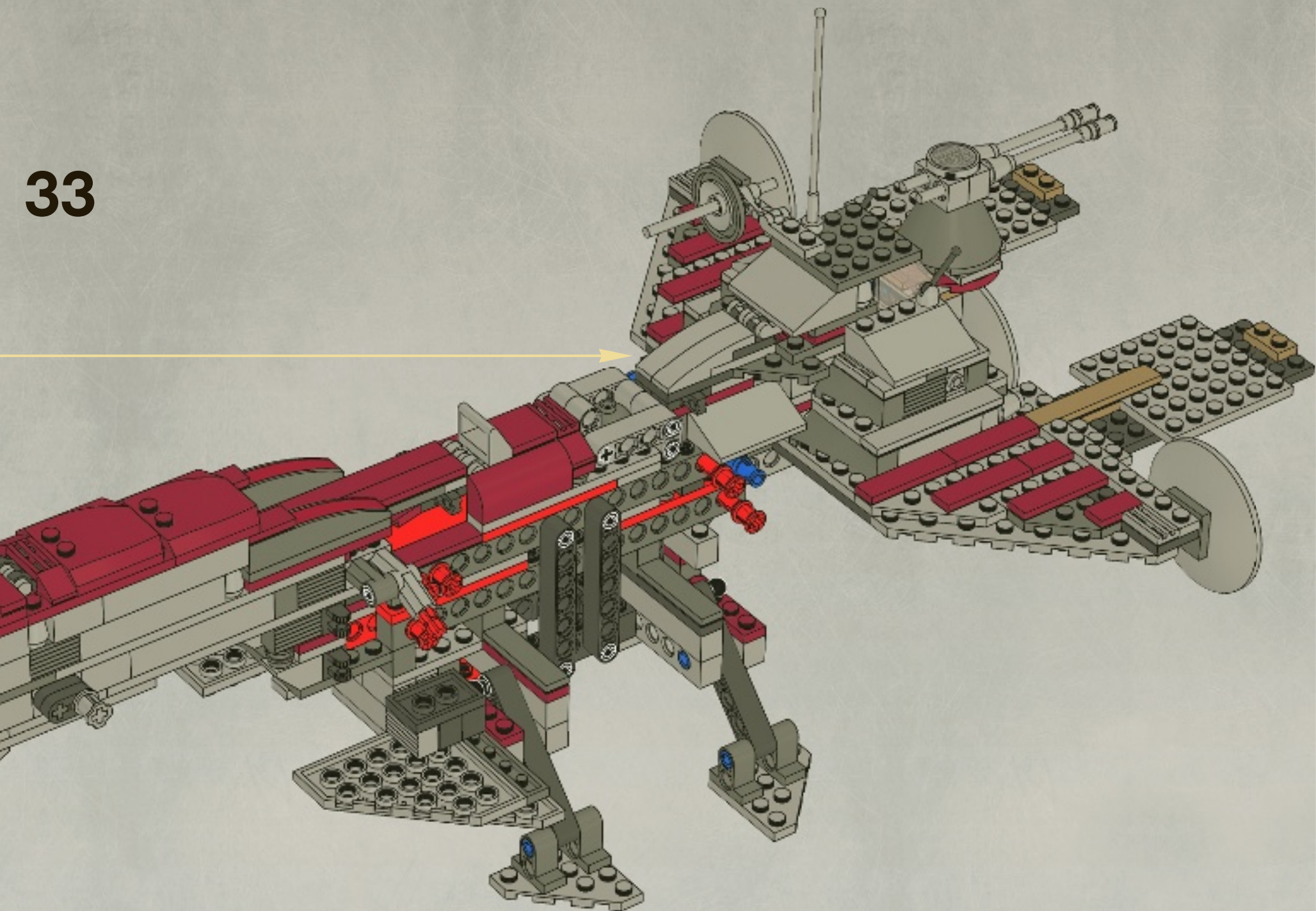



34

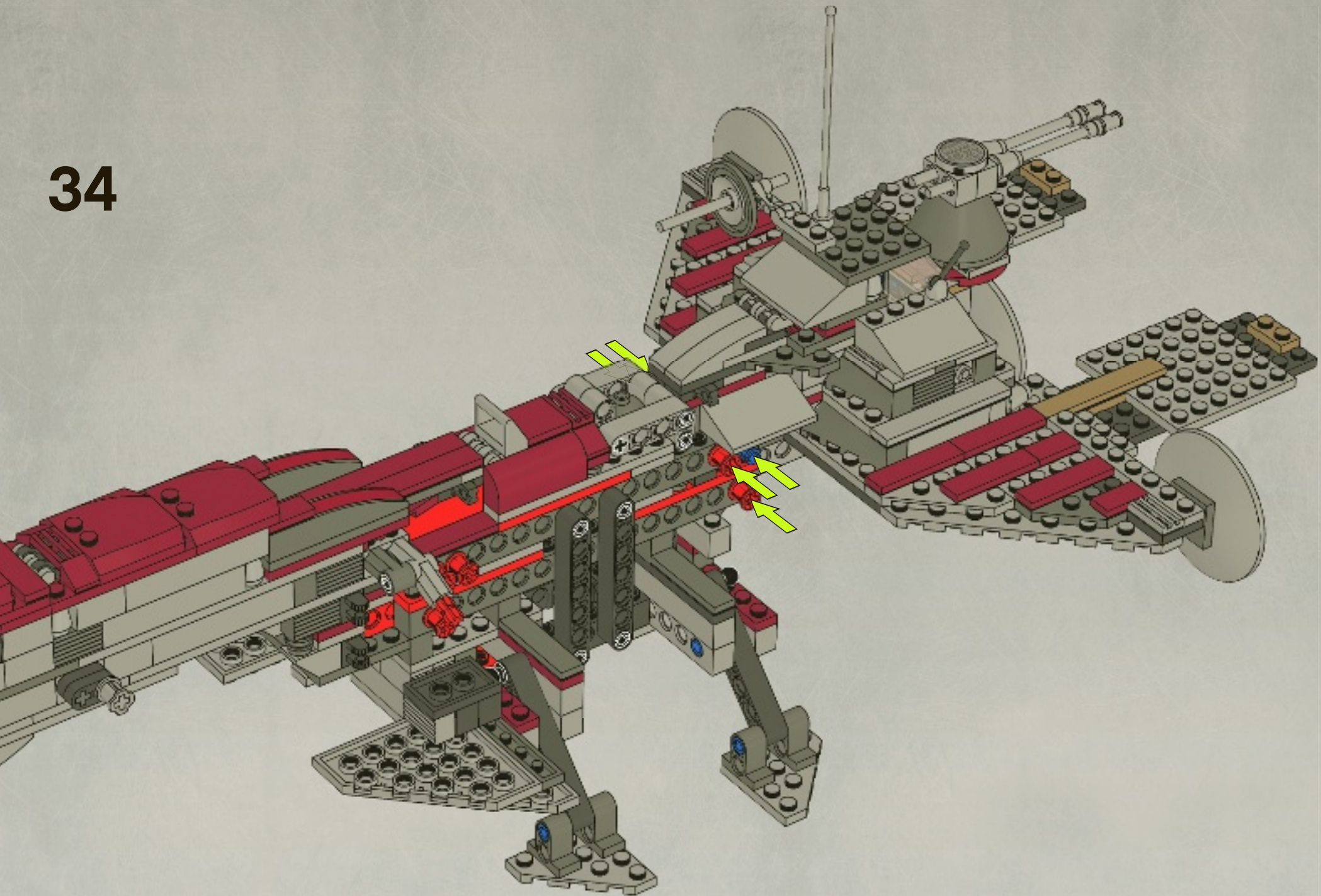







4

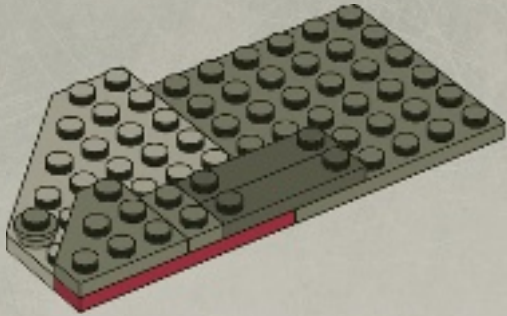

5

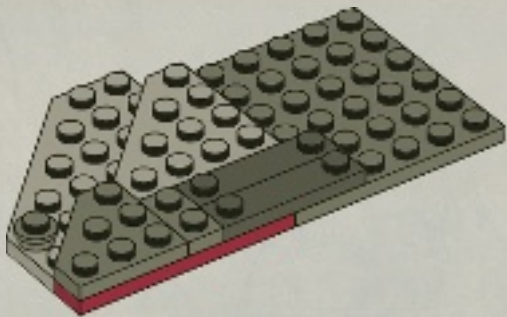

6

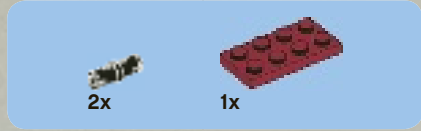

7

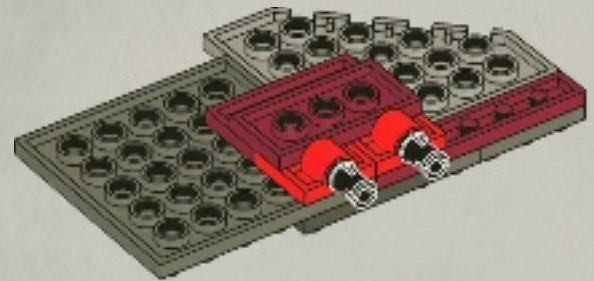



1x

1x

# 8

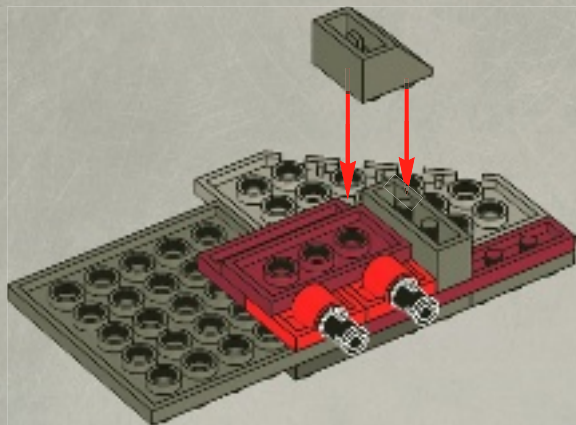

1x

4x

# 9

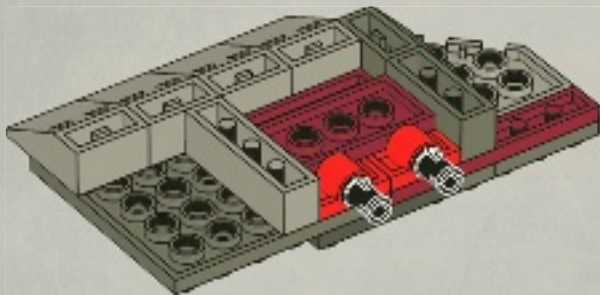

1x

# 10

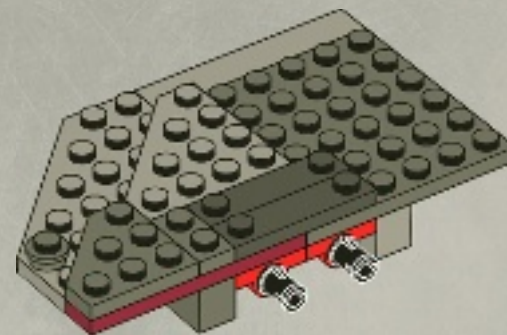

1x

1x

# 11

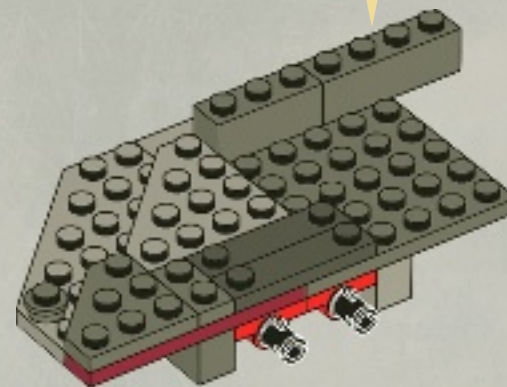
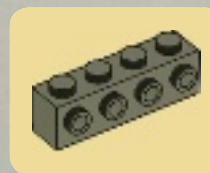



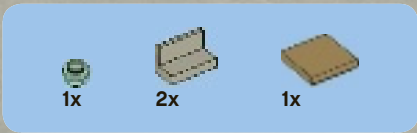

12

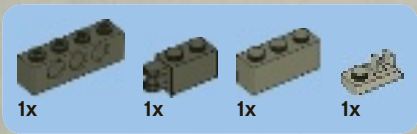
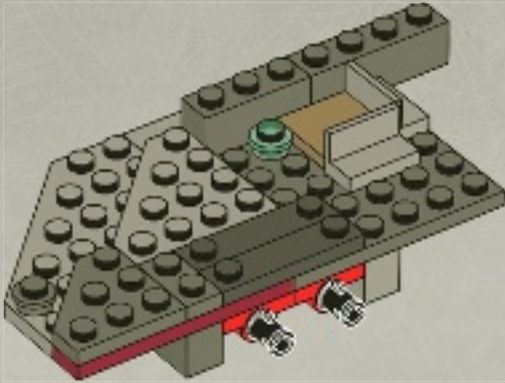

13

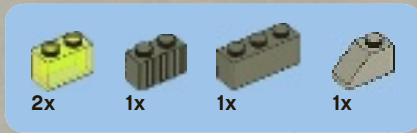
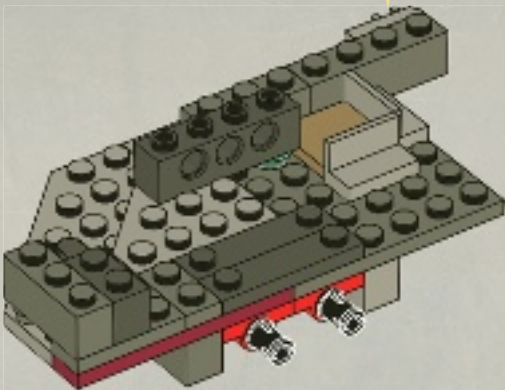
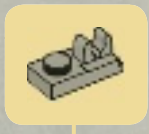

14

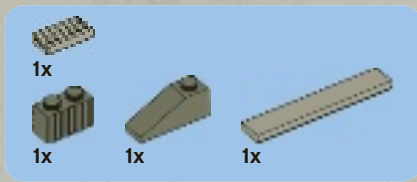
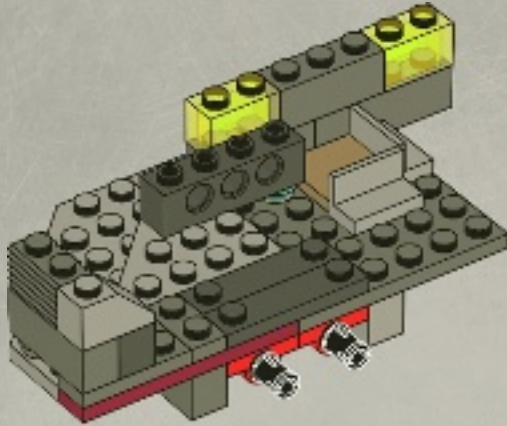

15

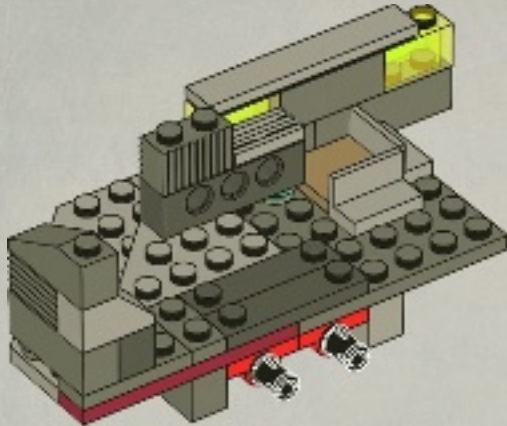

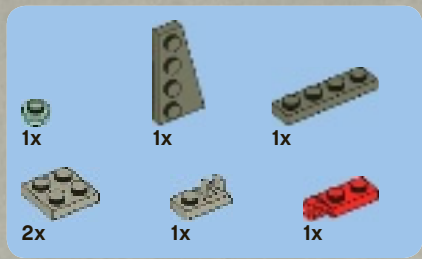

# 16

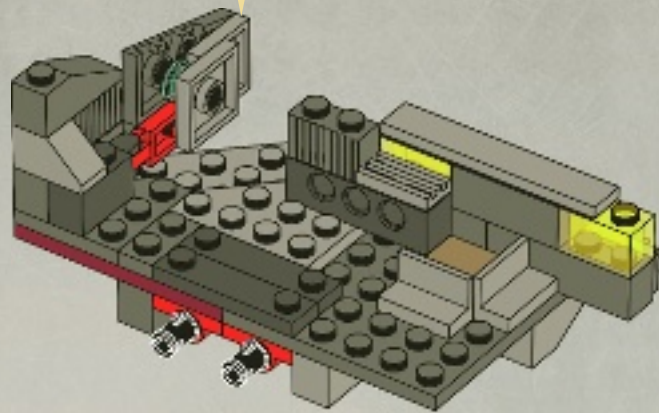
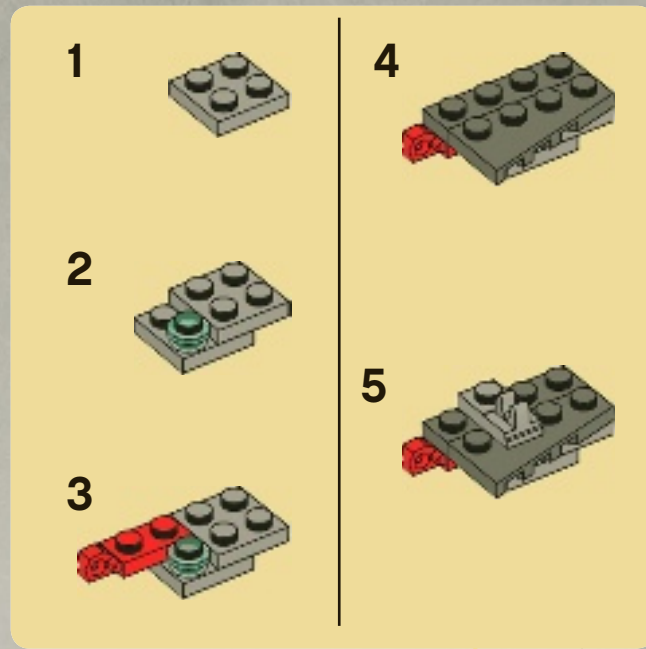



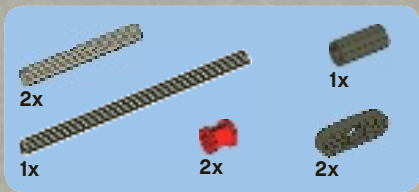

17

1



2

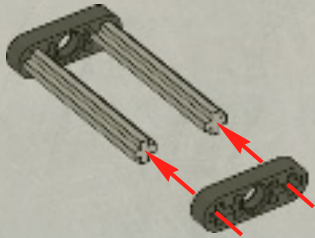

4

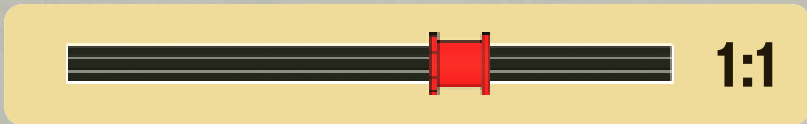
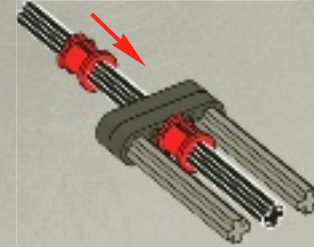

3

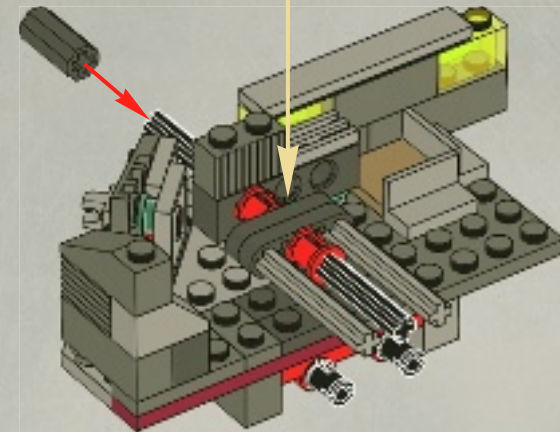
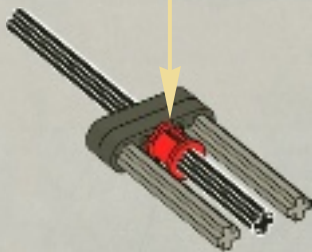



3x



6x

# 18



3x

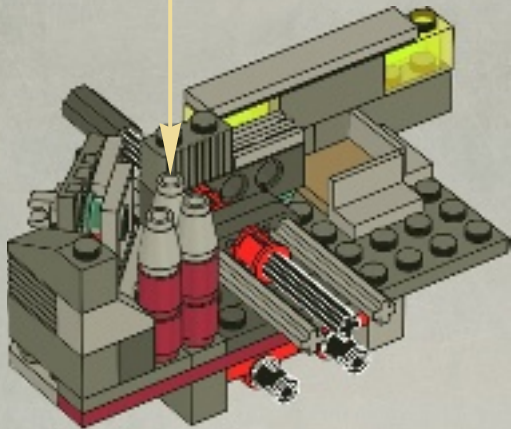

1x



2x



1x



2x



1x



1x

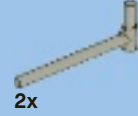

2x



2x



2x

# 19

1

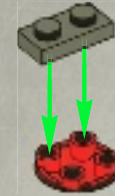

2

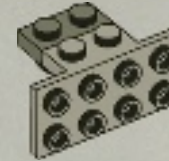

3

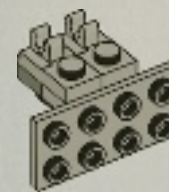



4

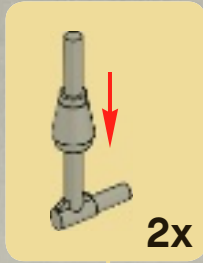
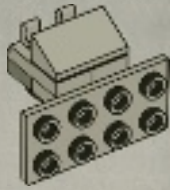

5

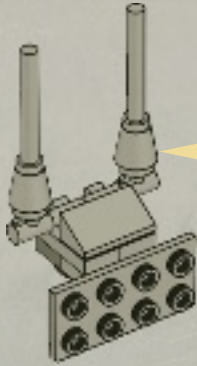

6

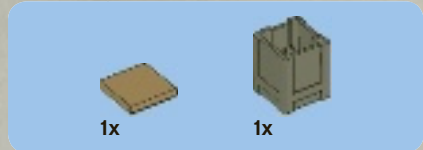
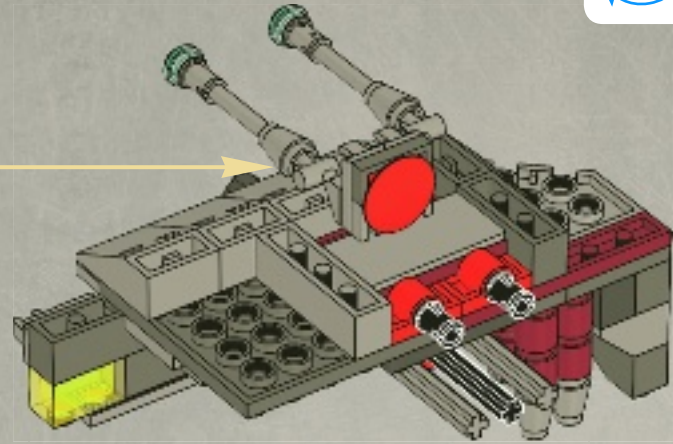
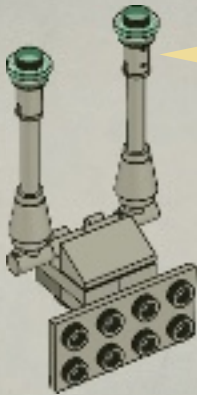

20

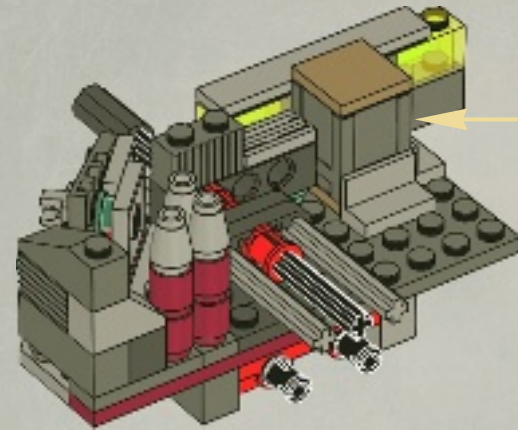
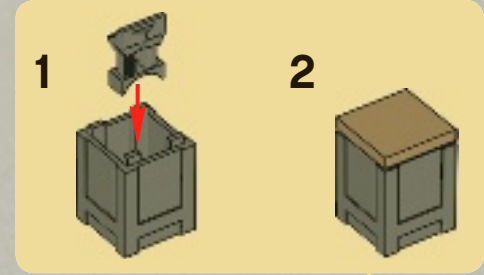

21

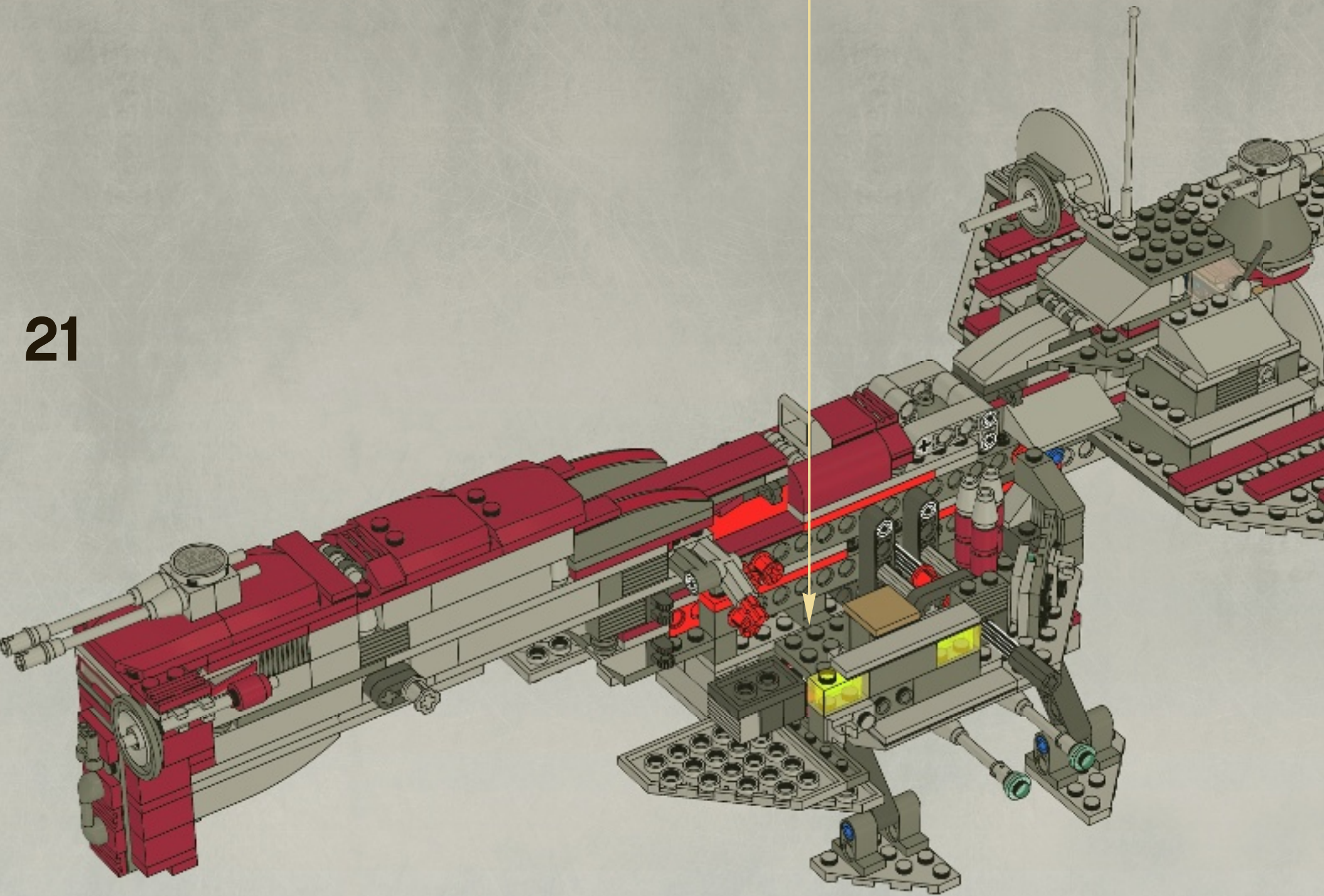



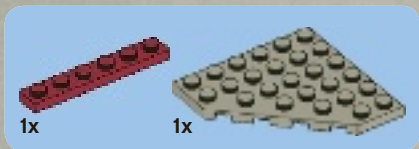

1

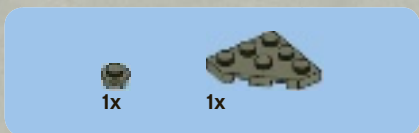
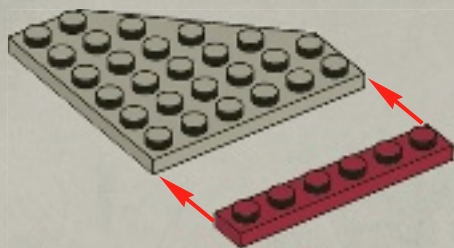

2

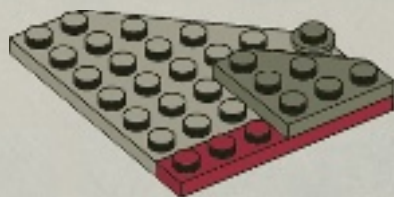

3

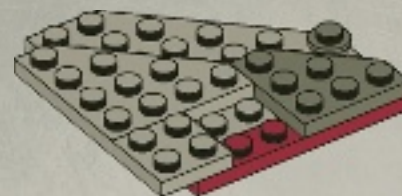

4

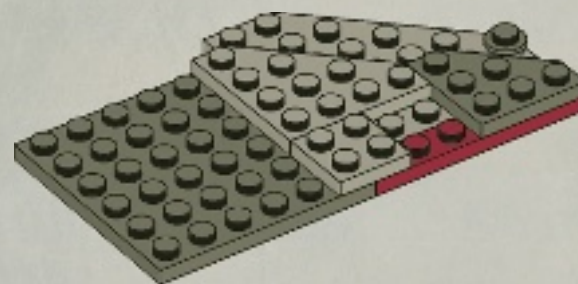



1x

# 5

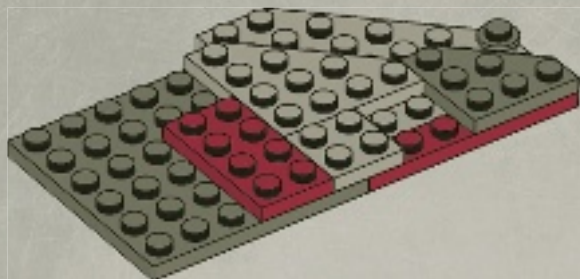

2x



1x

# 6

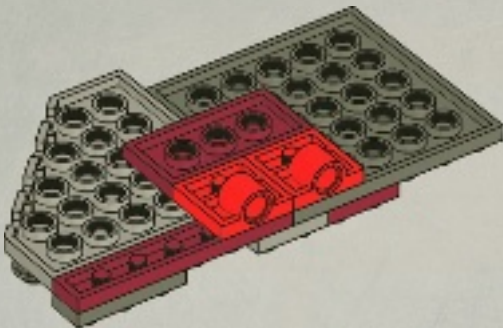

1x

# 7

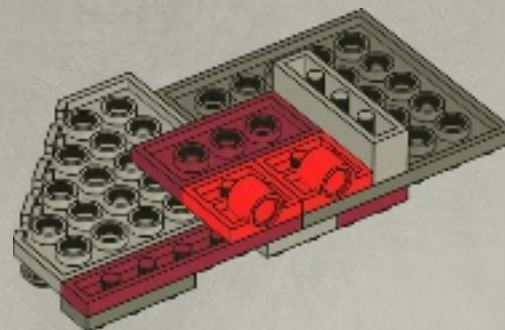

2x



1x

# 8

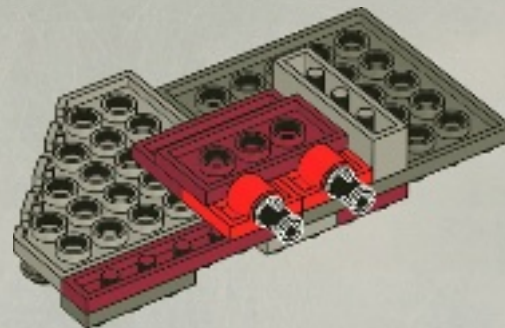





4x

# 9

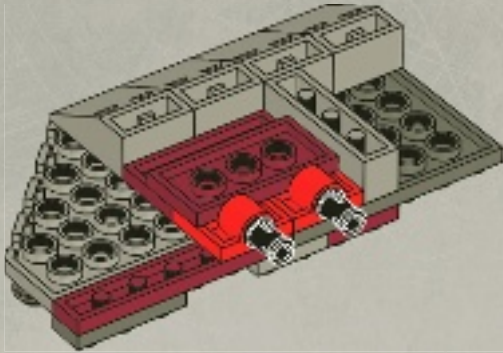

1x



1x

# 10

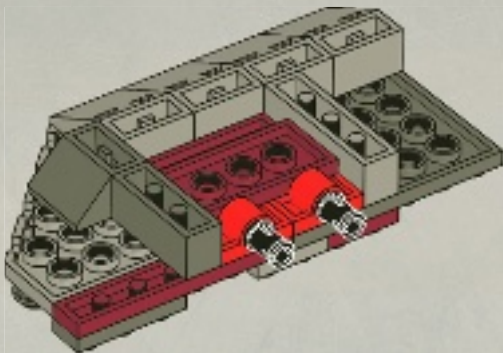

1x

# 11



1x



1x

# 12

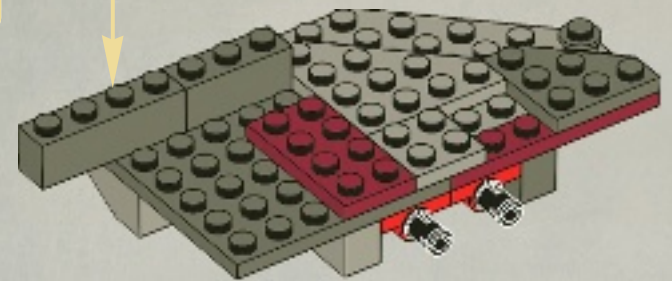
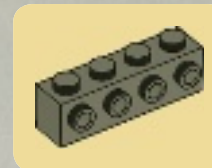

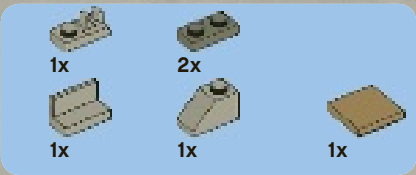

13

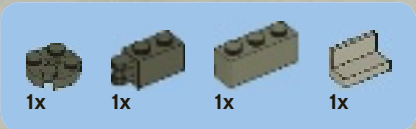
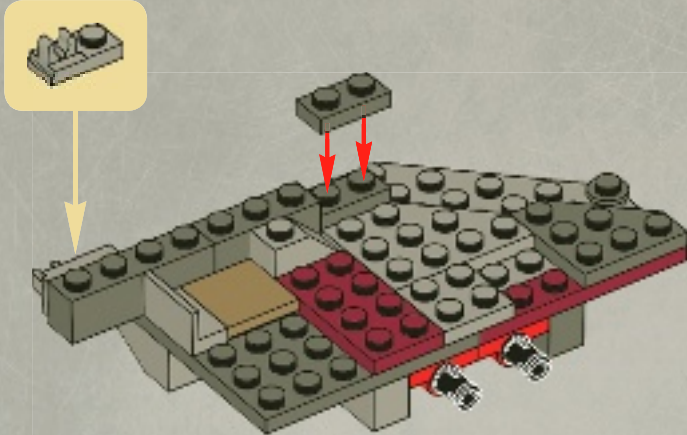

14

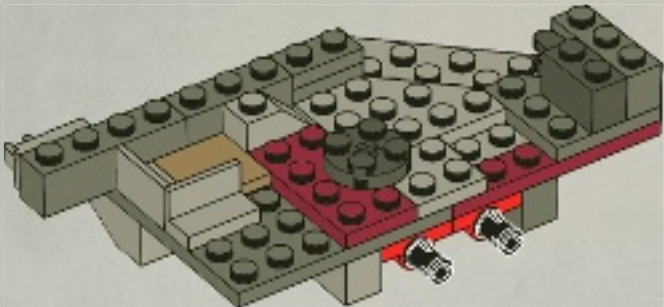

15

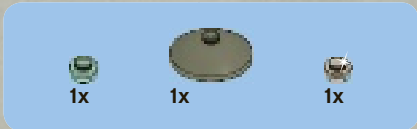
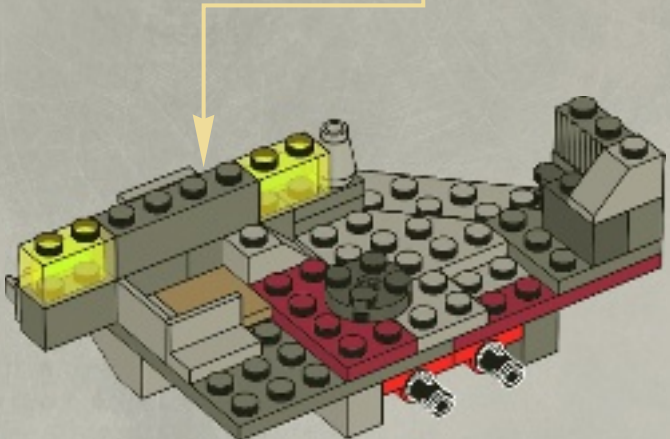
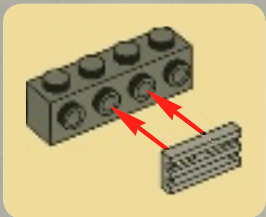

16

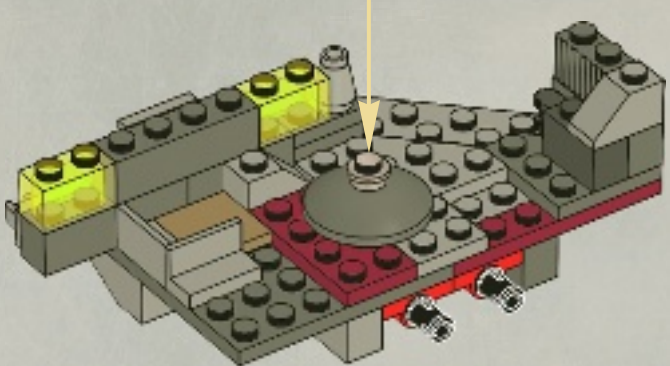
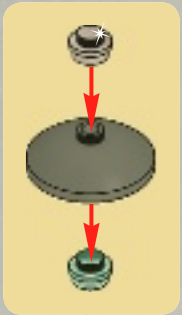



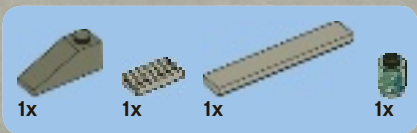

17

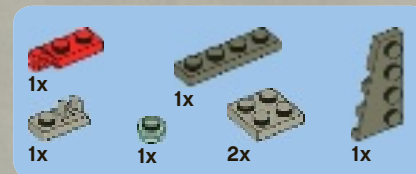
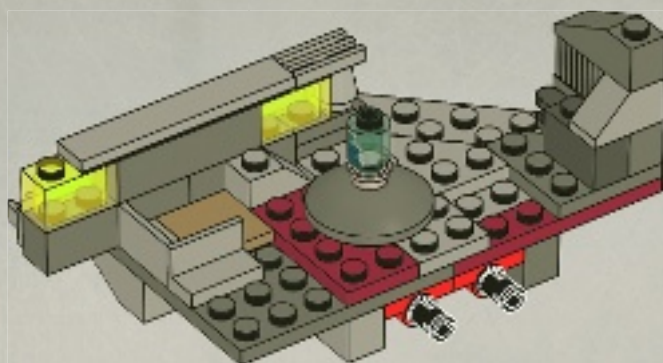

18

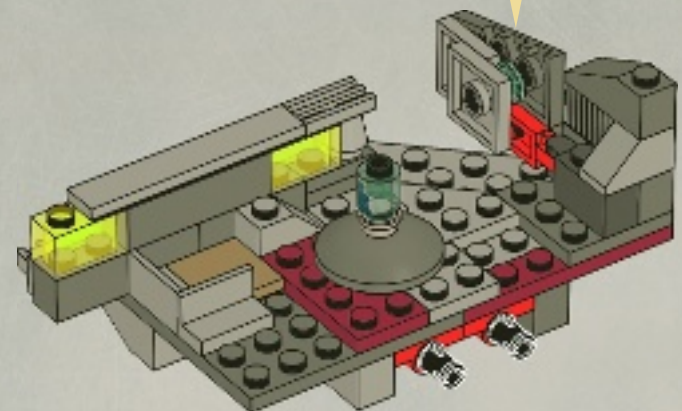
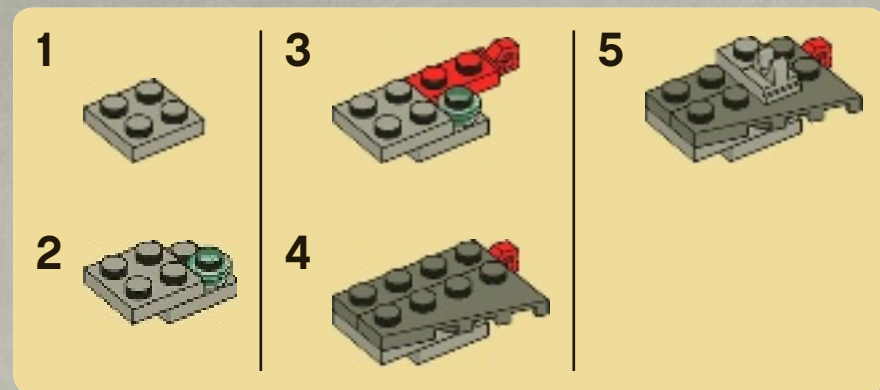

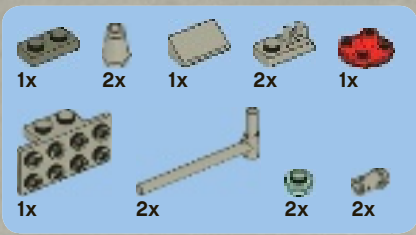

# 19

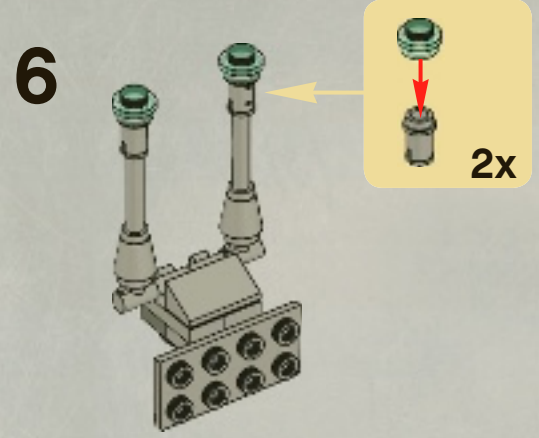
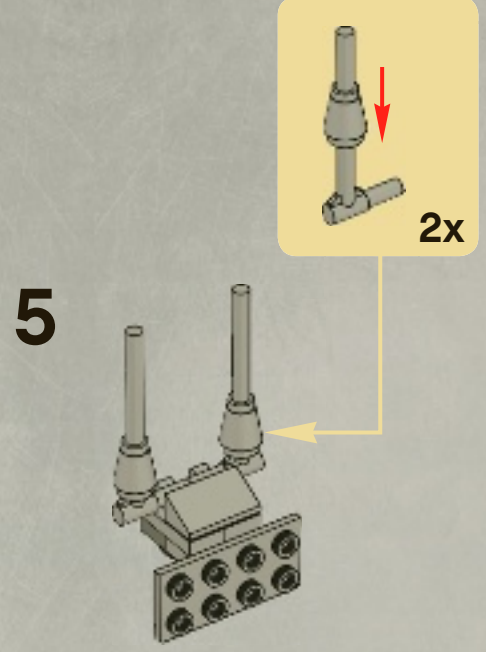
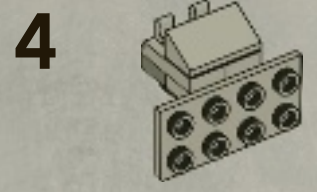
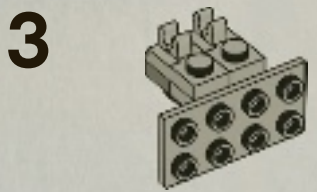
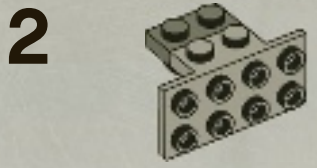





1x



1x



1x



2x

# 20

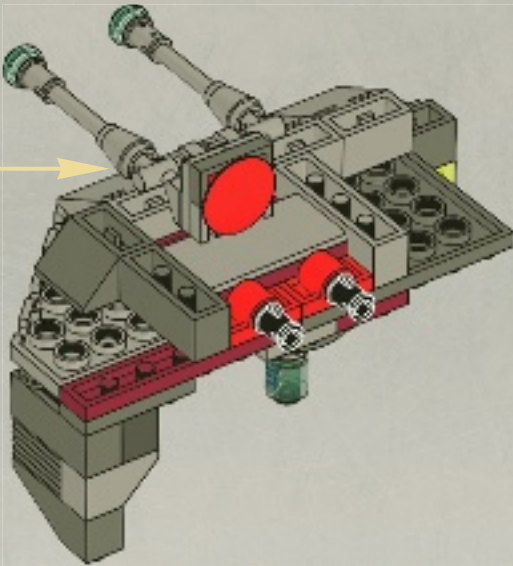

1

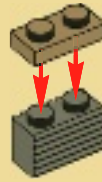

2



3

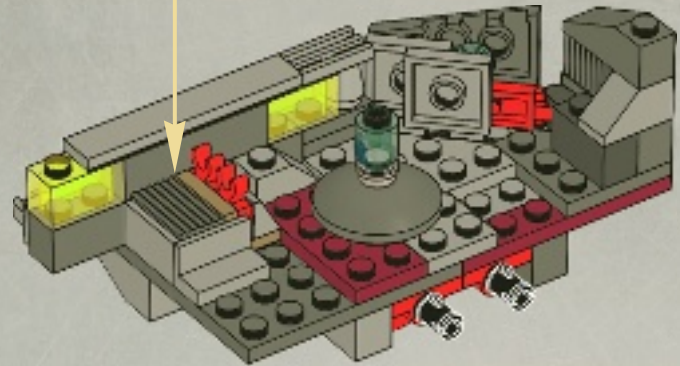

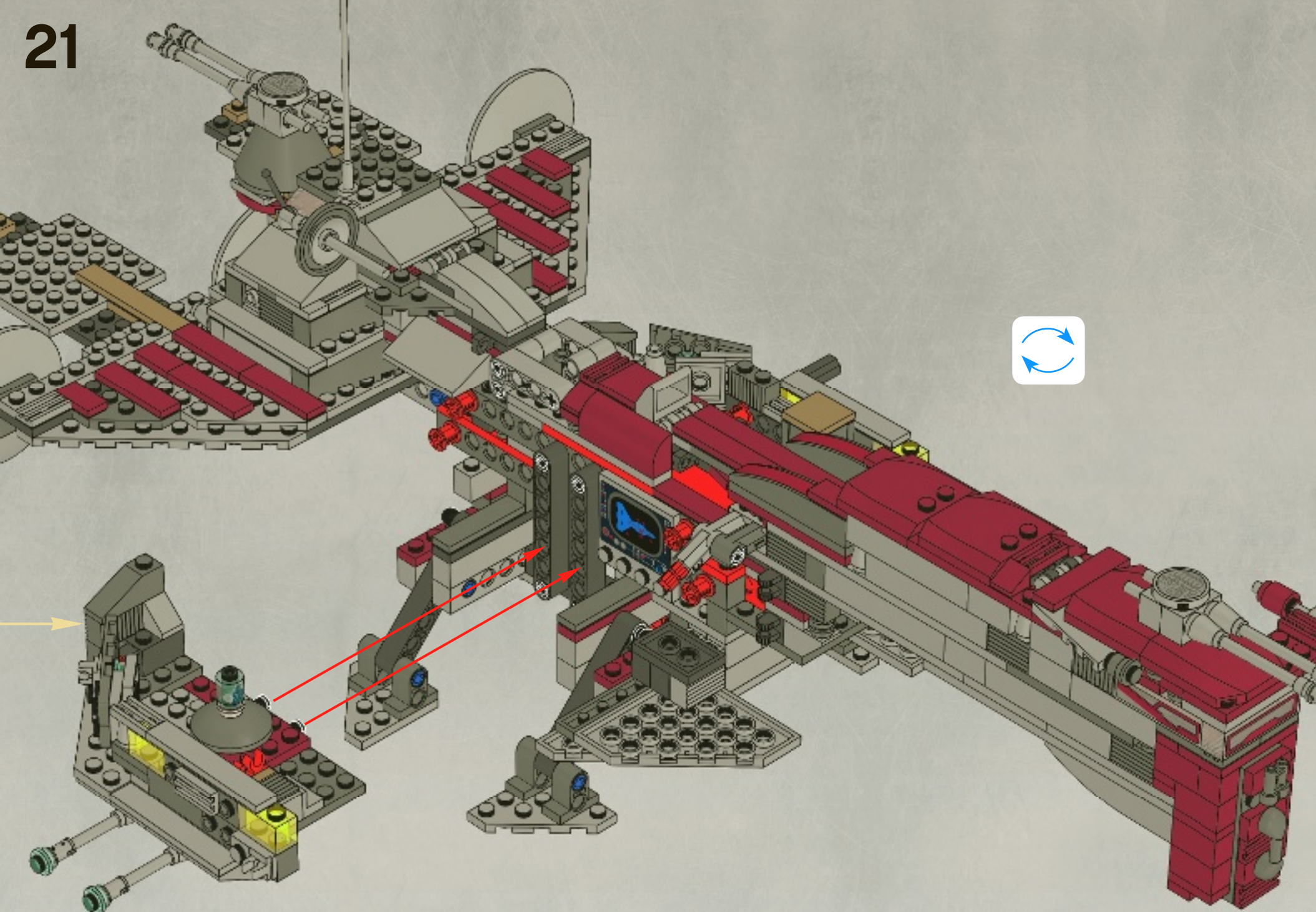



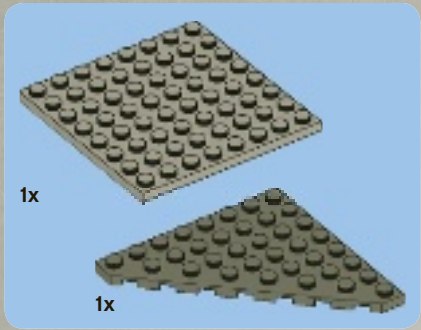

1

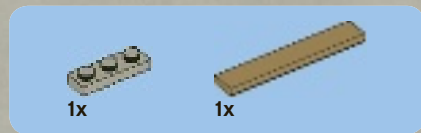
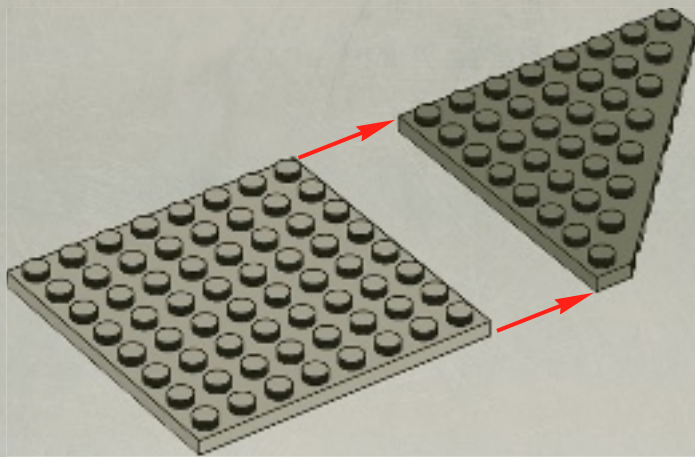

2

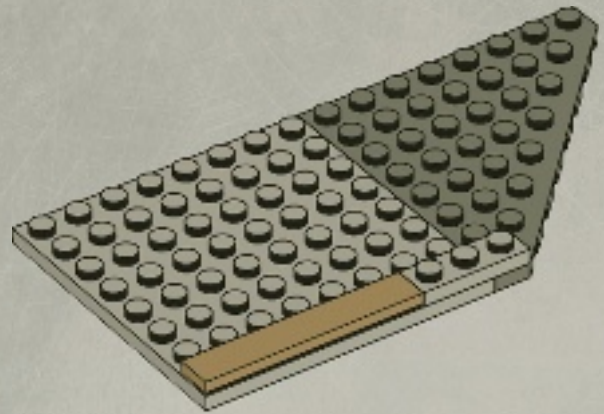

3

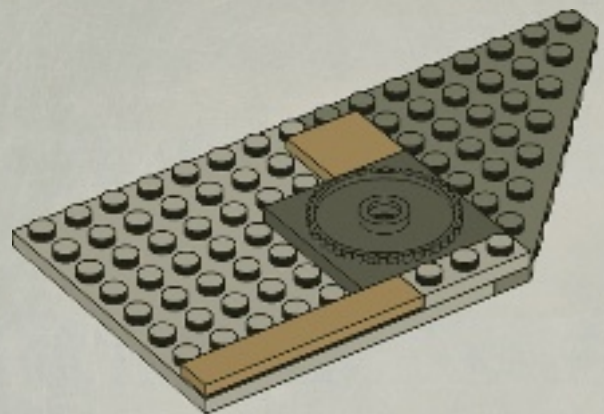

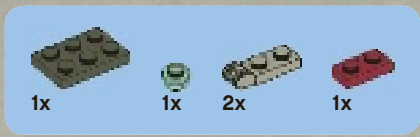

4

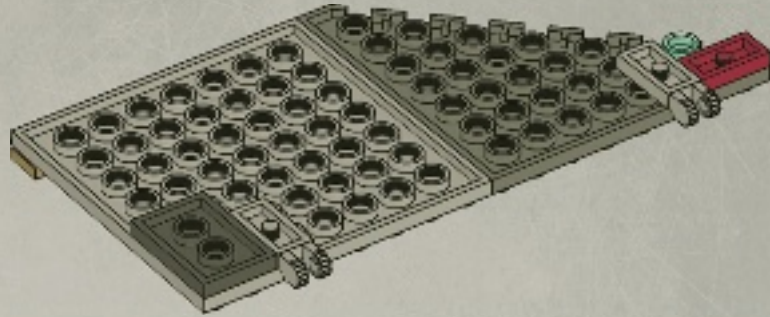

5

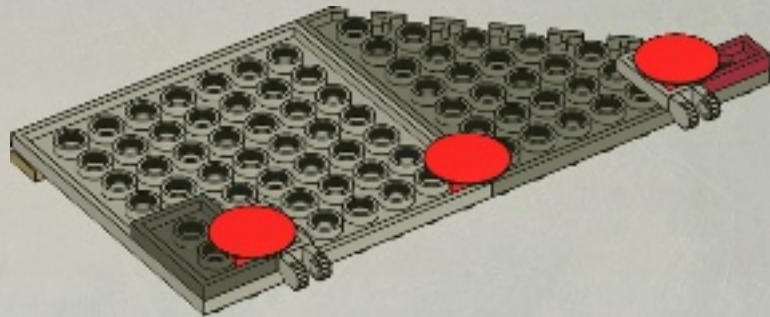



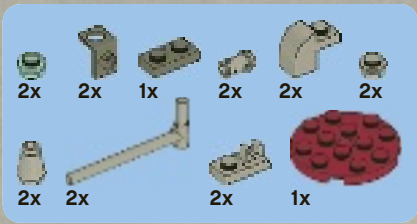

# 6

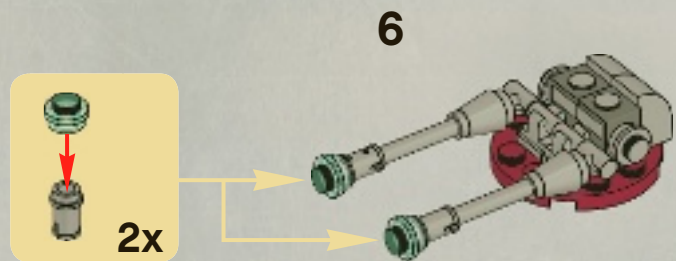
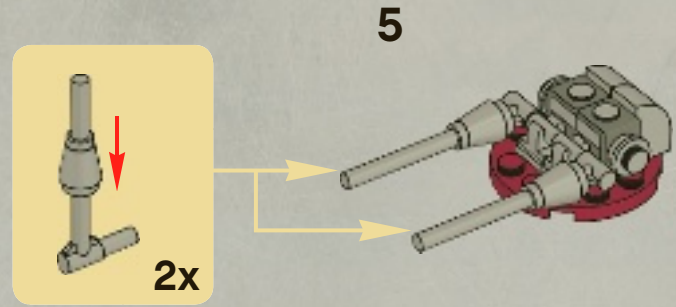
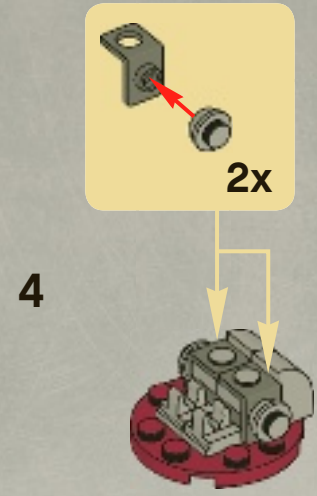
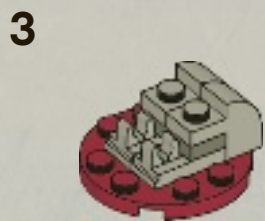

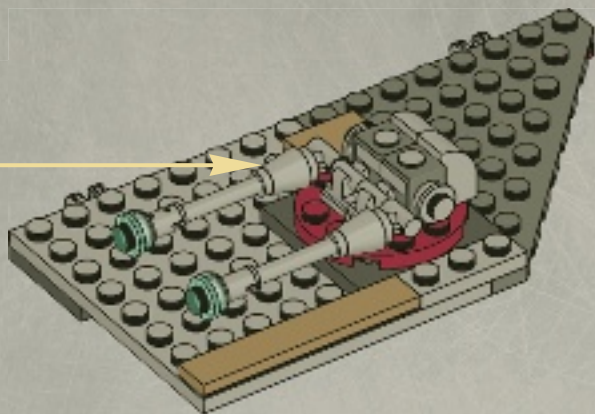

22

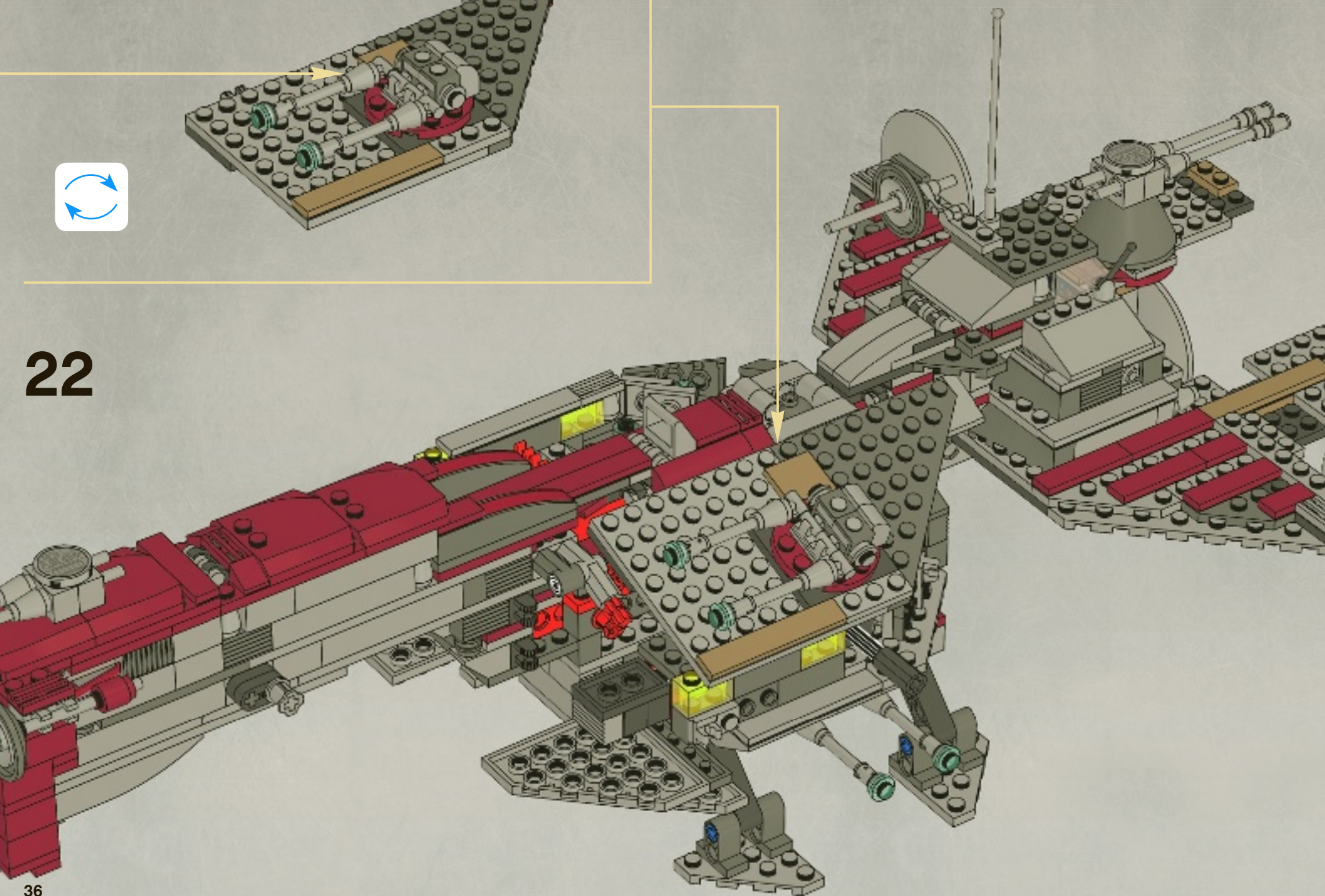



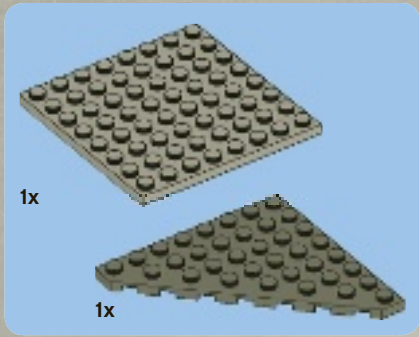

1

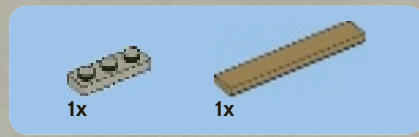
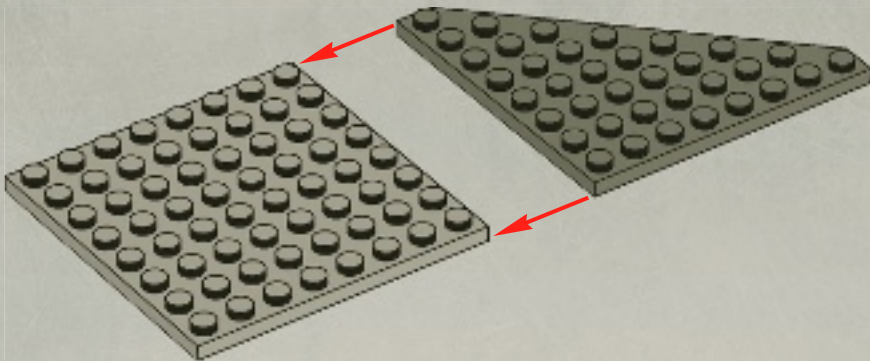

2

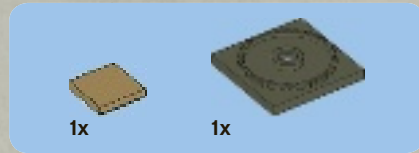
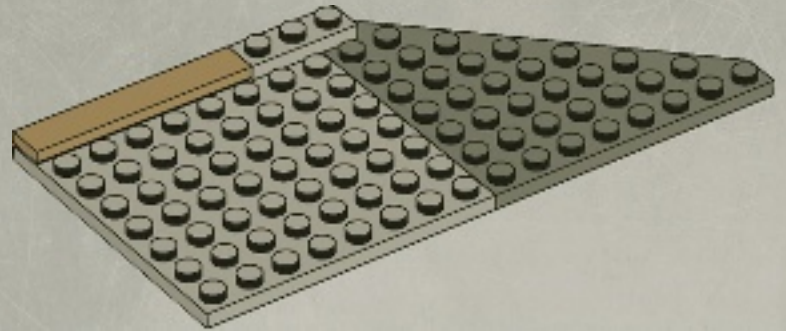

3

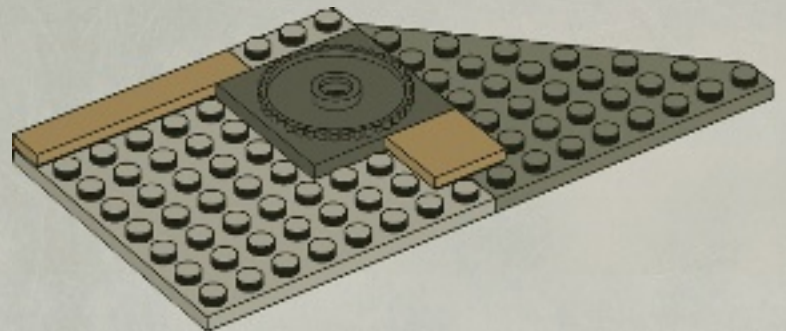

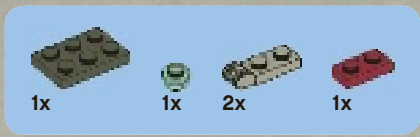

4

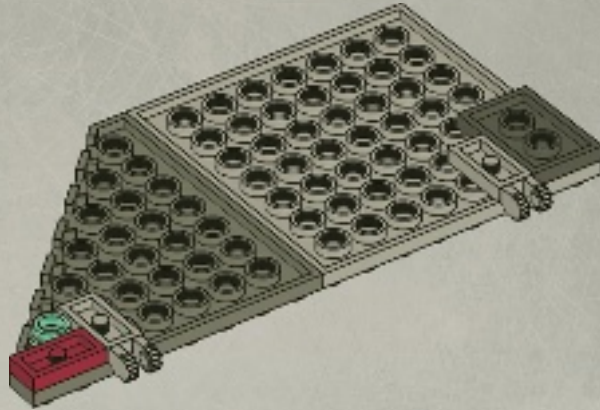

5

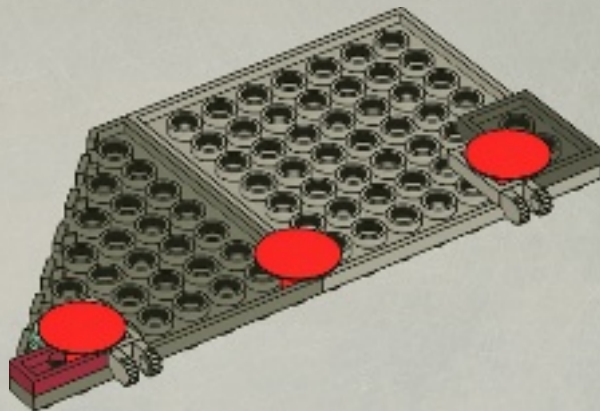



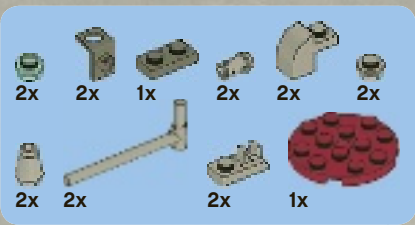

# 6

1

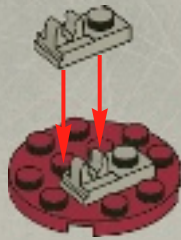

2



3

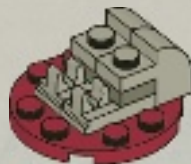

4

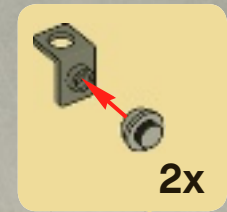

5

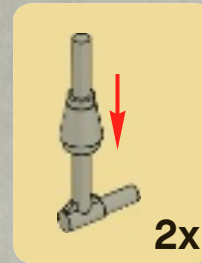

6

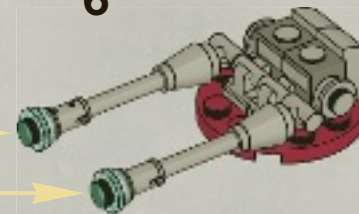
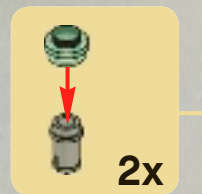





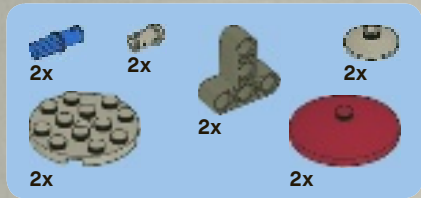

24

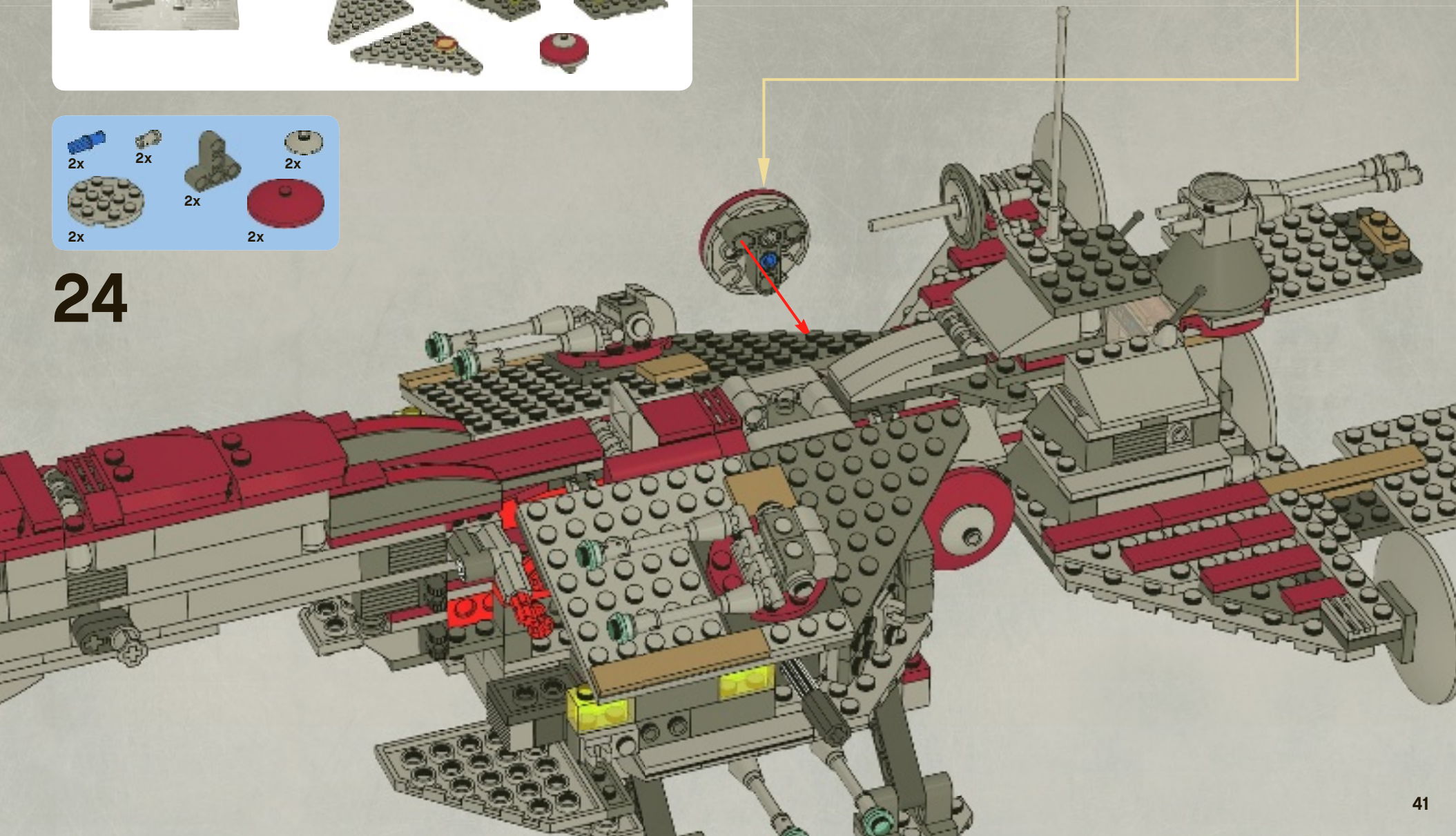



1

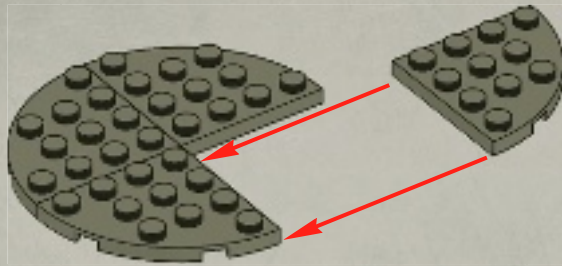

2

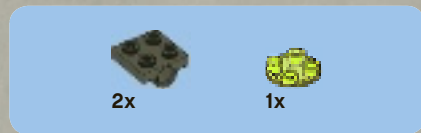
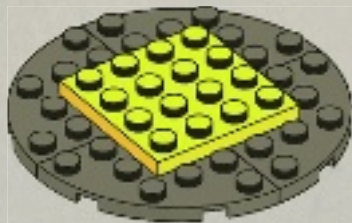

3

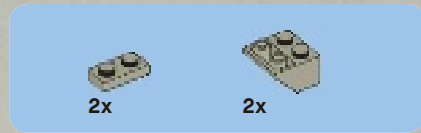
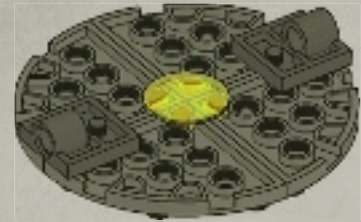

4







5

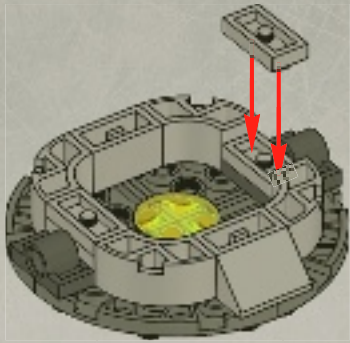

6

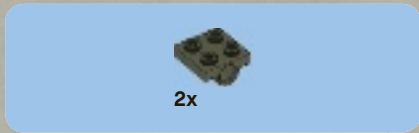
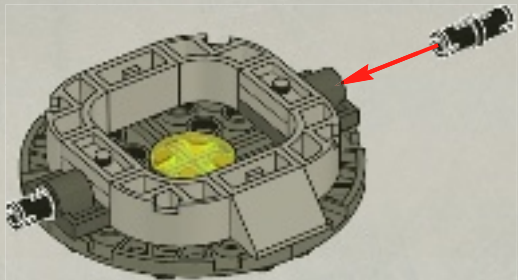

7

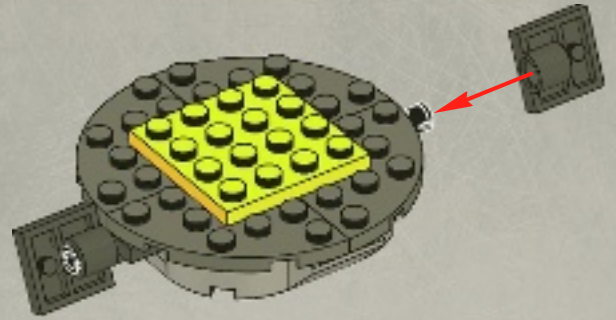

8

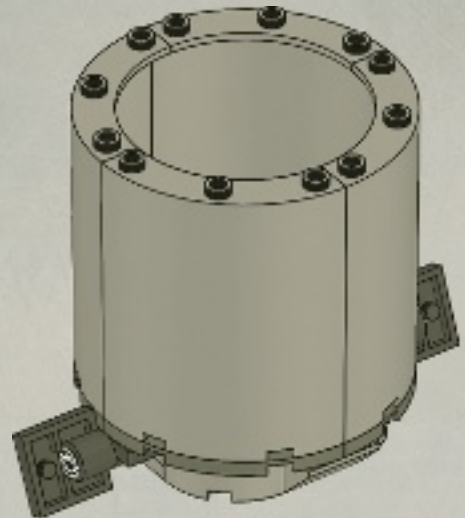

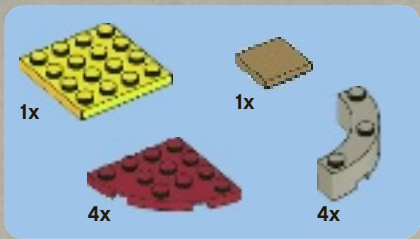

9

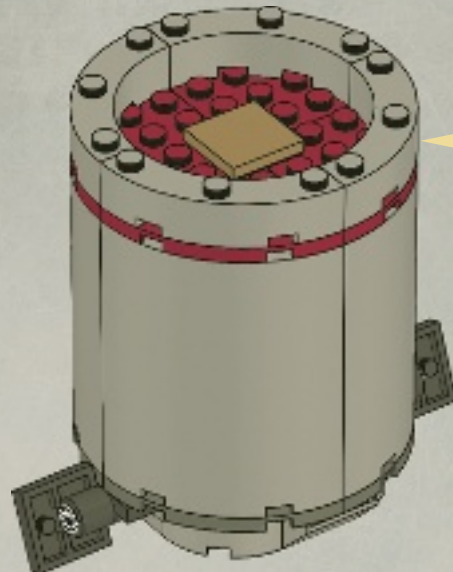
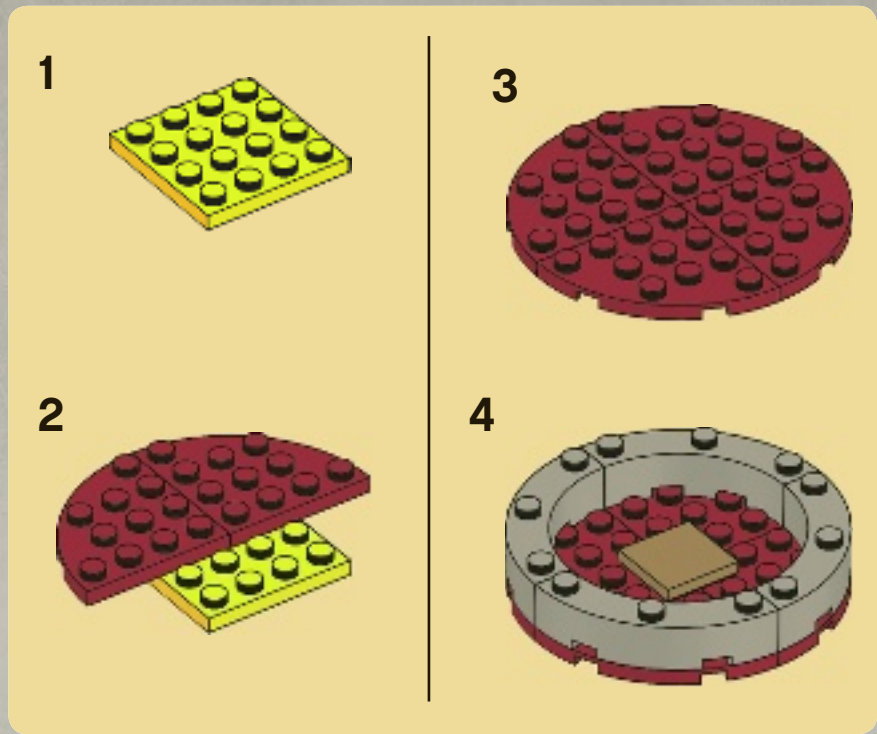



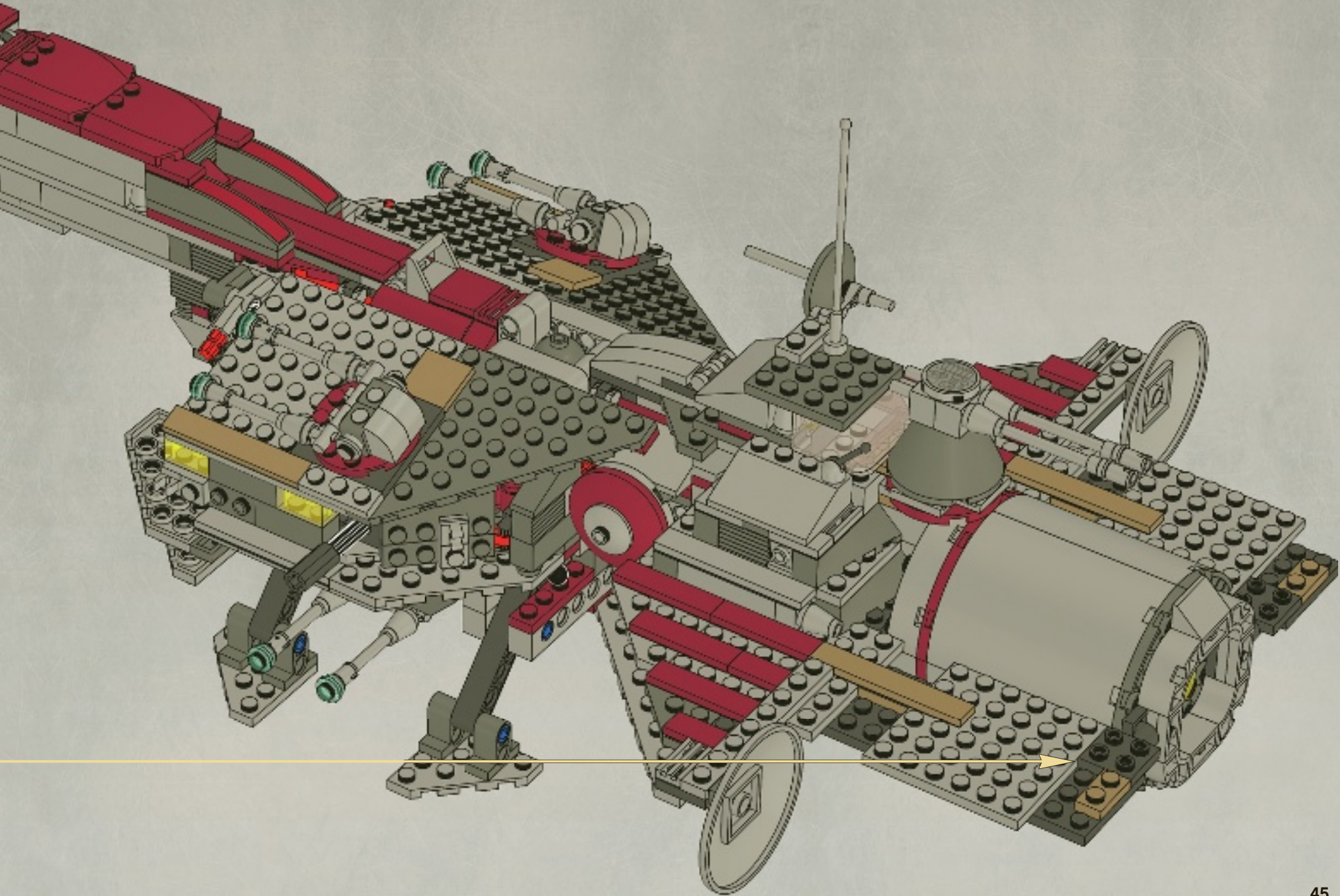

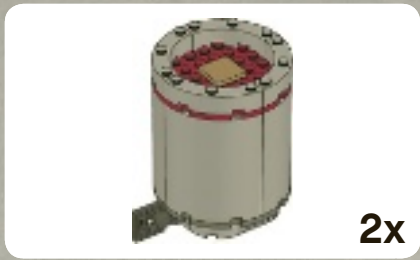

2x



4x

1

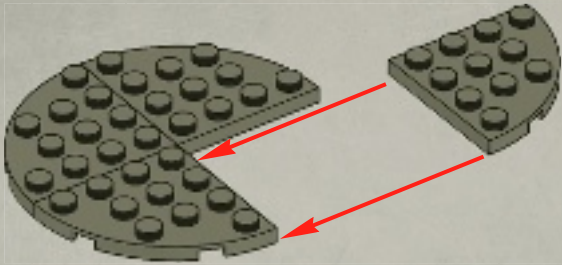

1x

2

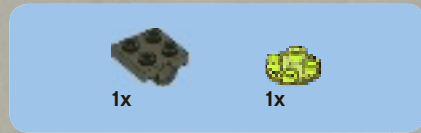

1x

1x

3

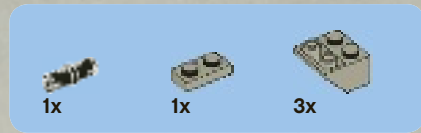

1x

1x

3x

4

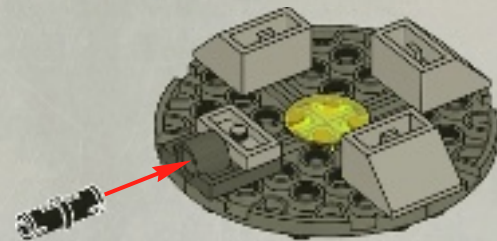



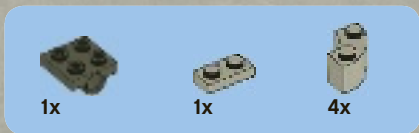

5

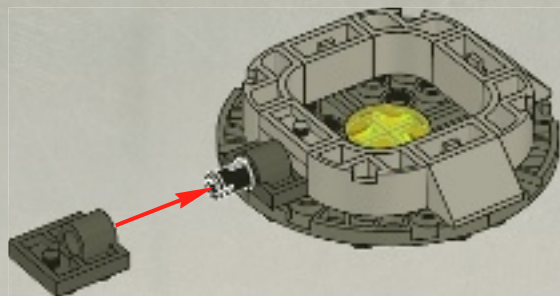

6

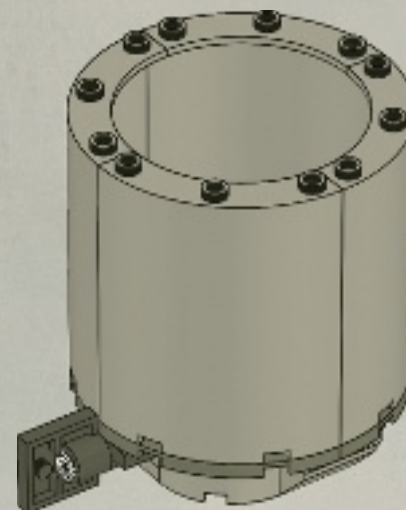

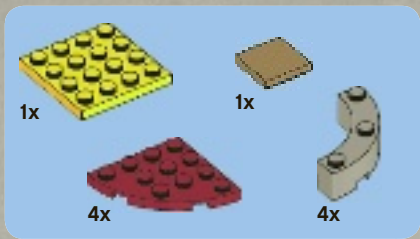

7

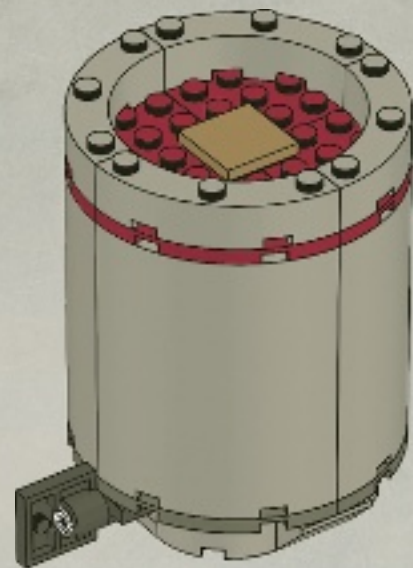
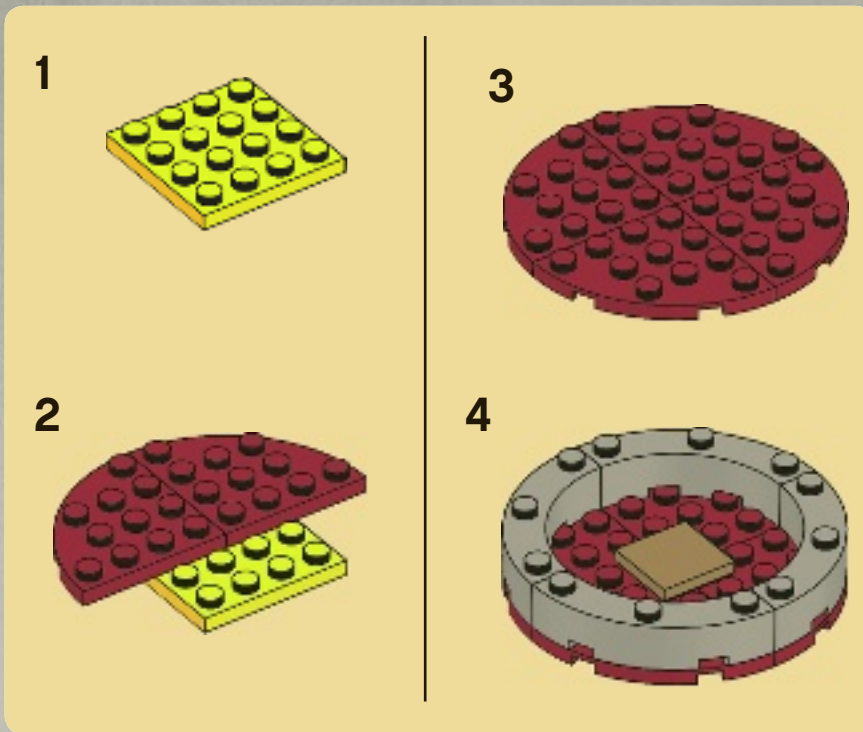

2x



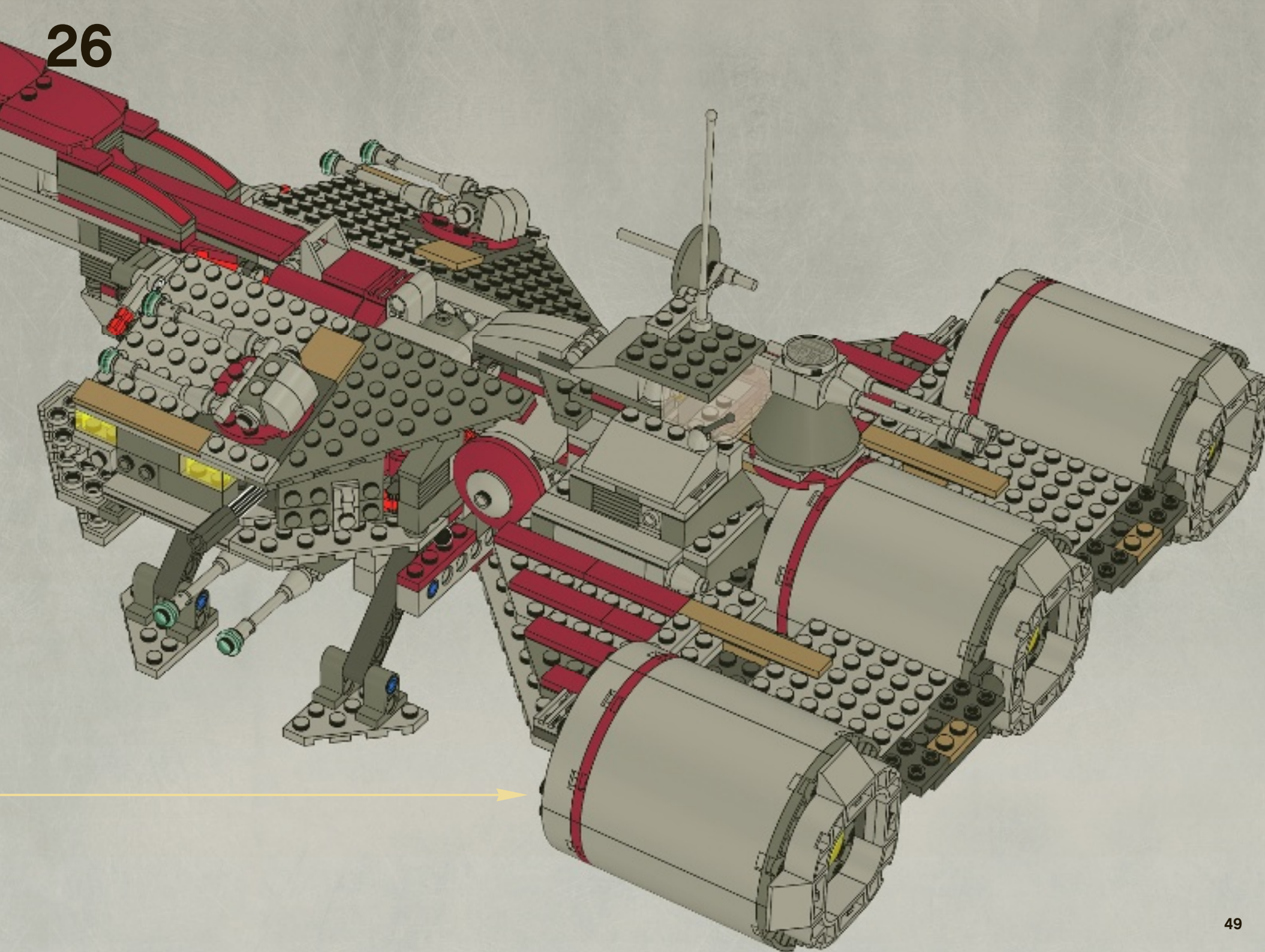



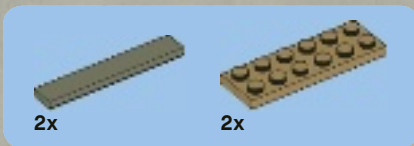

27

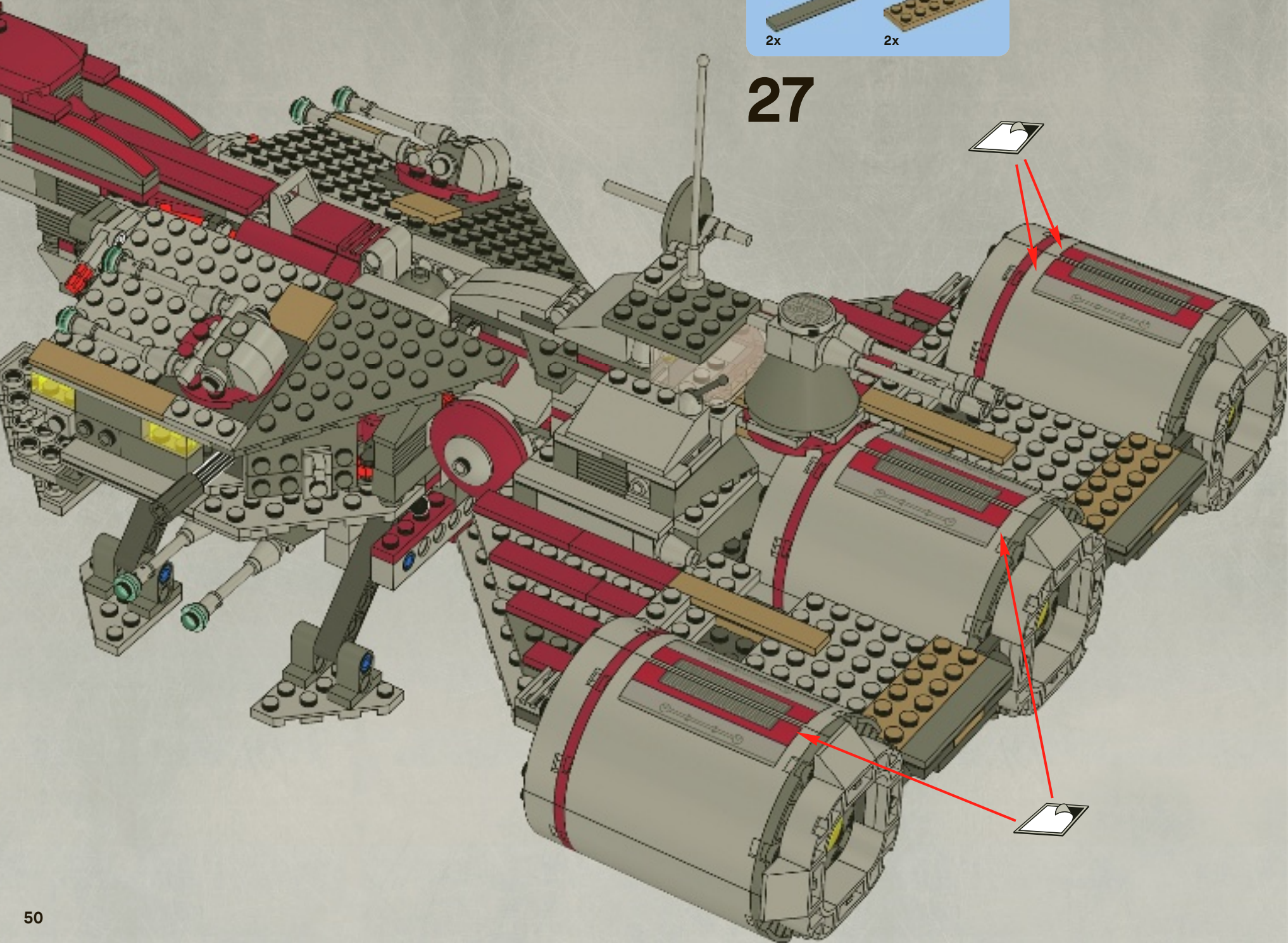



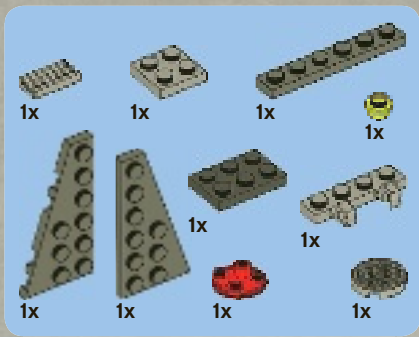

# 28

1



2

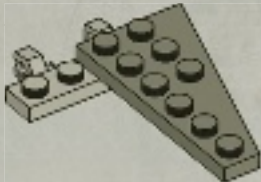

3

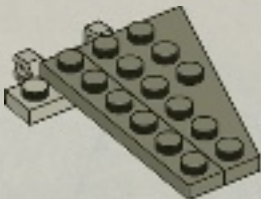

4

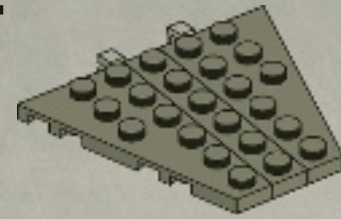

5

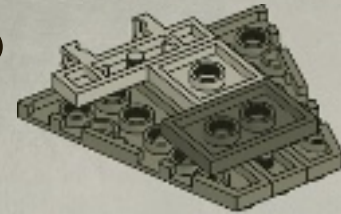

6

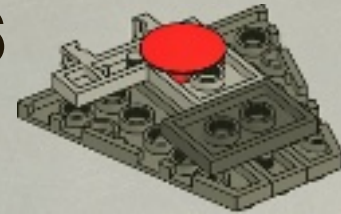

7

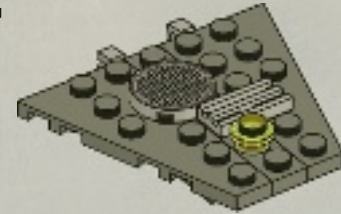

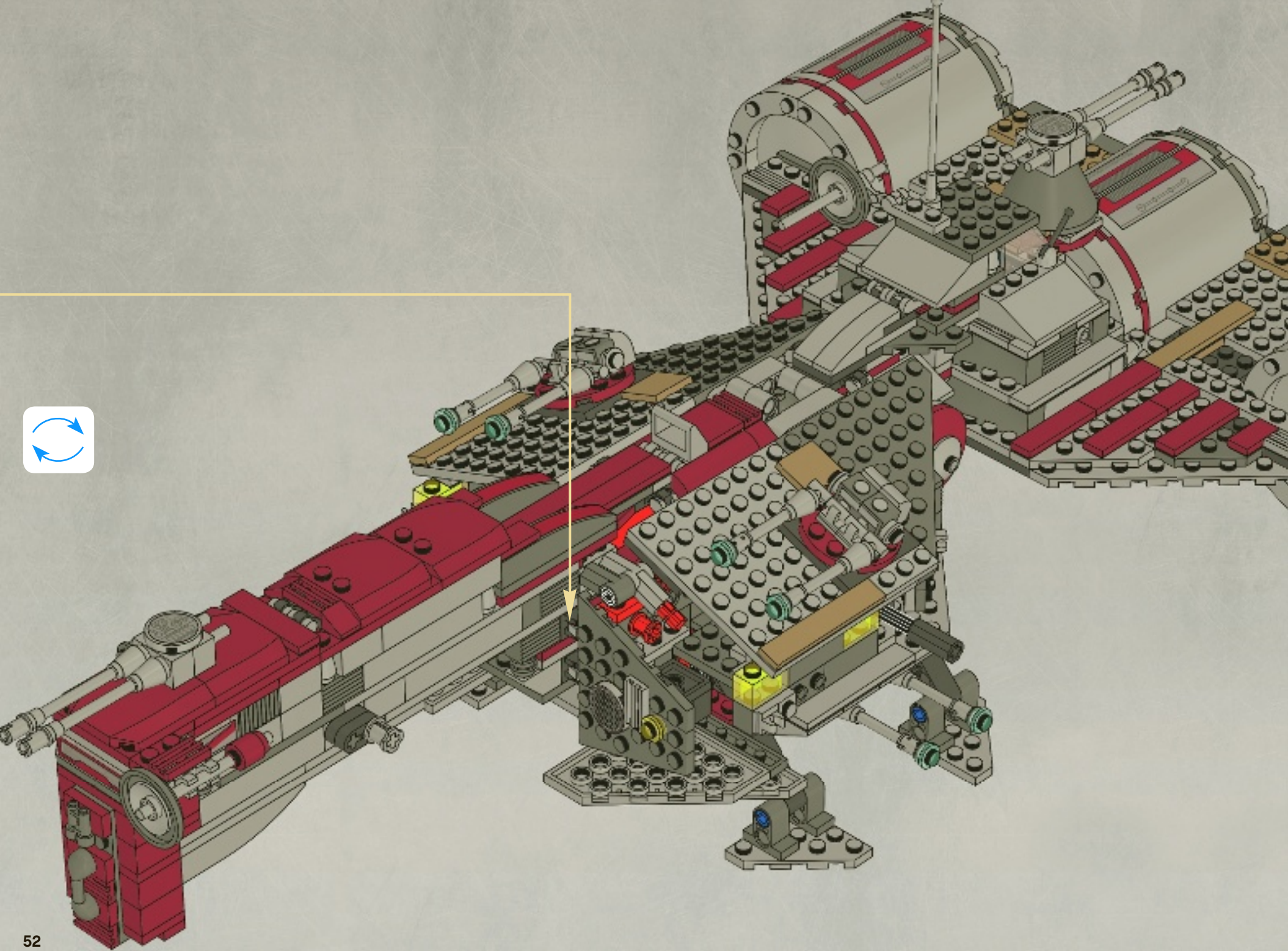



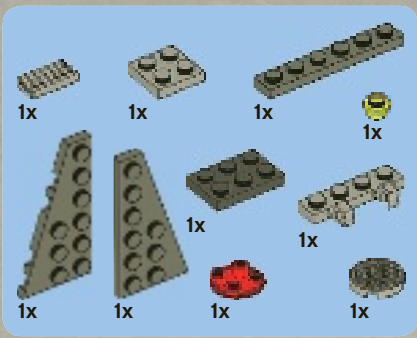

# 29

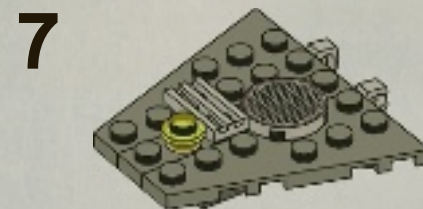
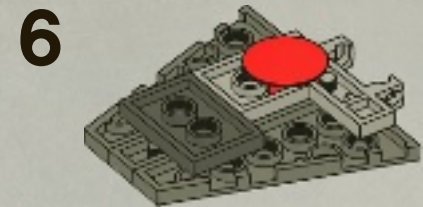
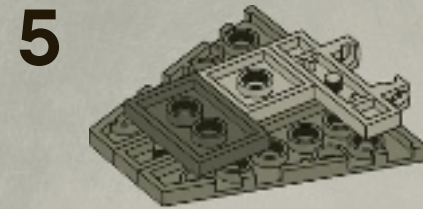
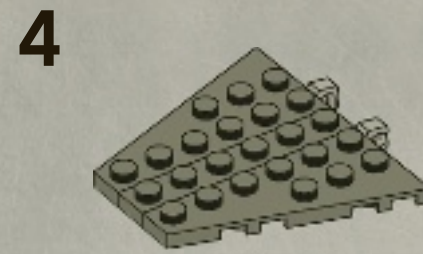
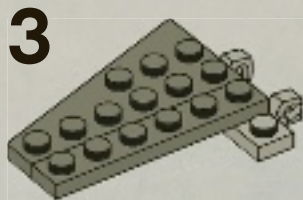
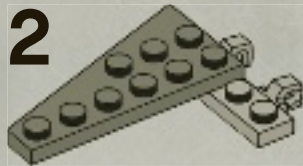

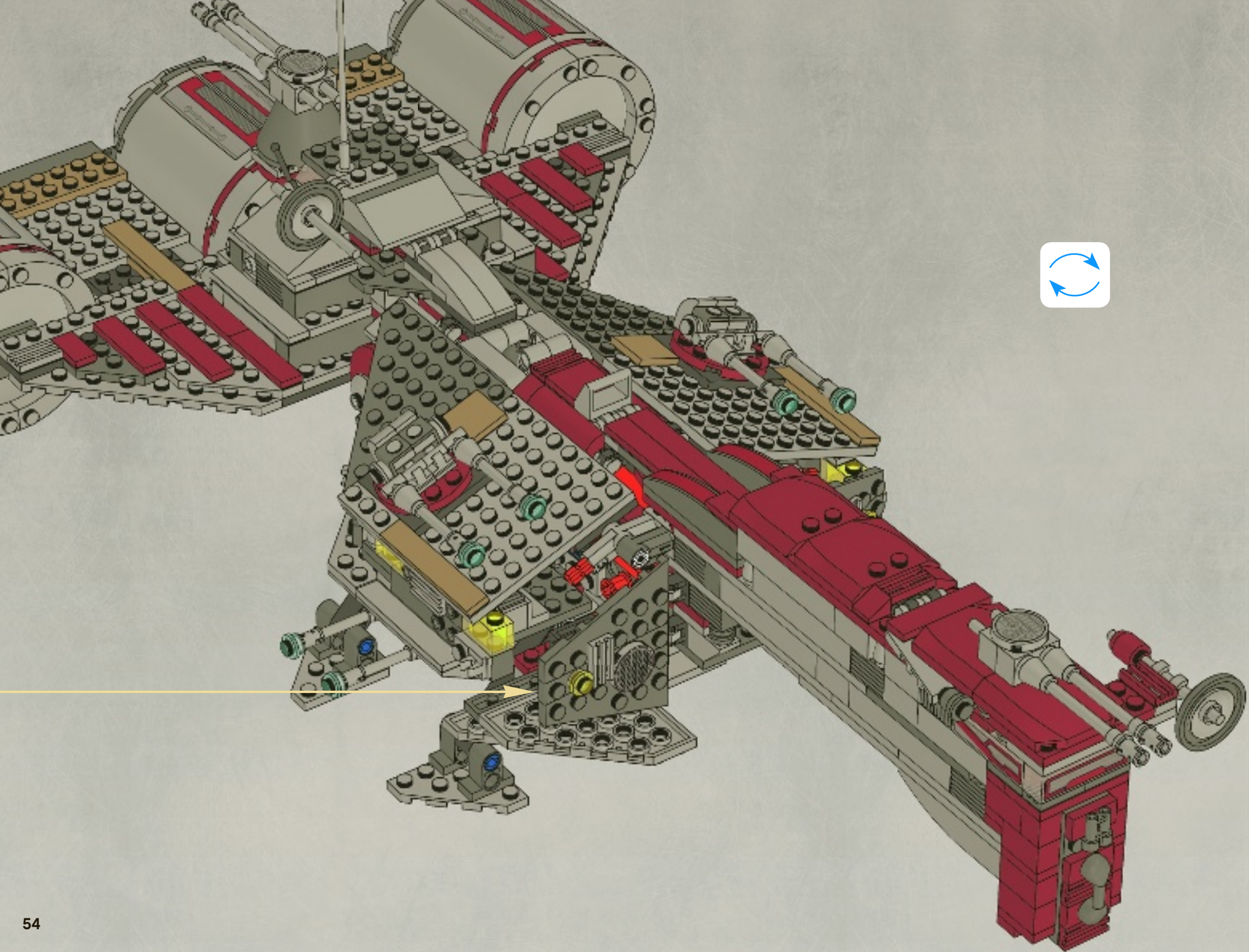





30

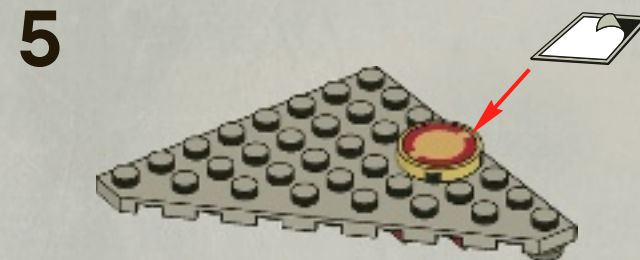
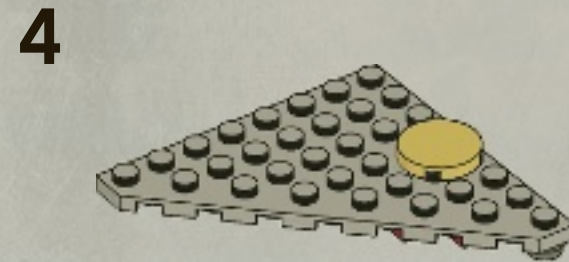
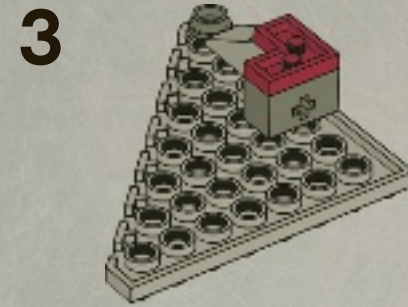
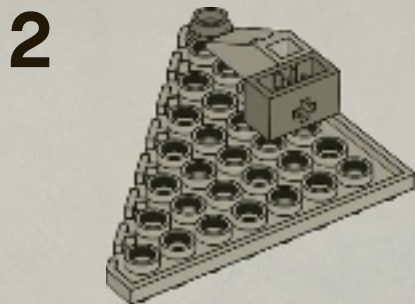
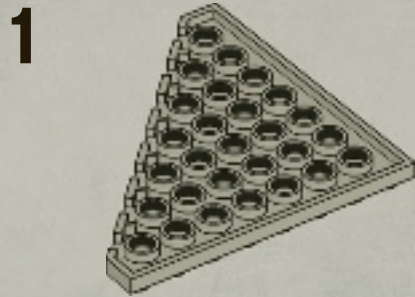

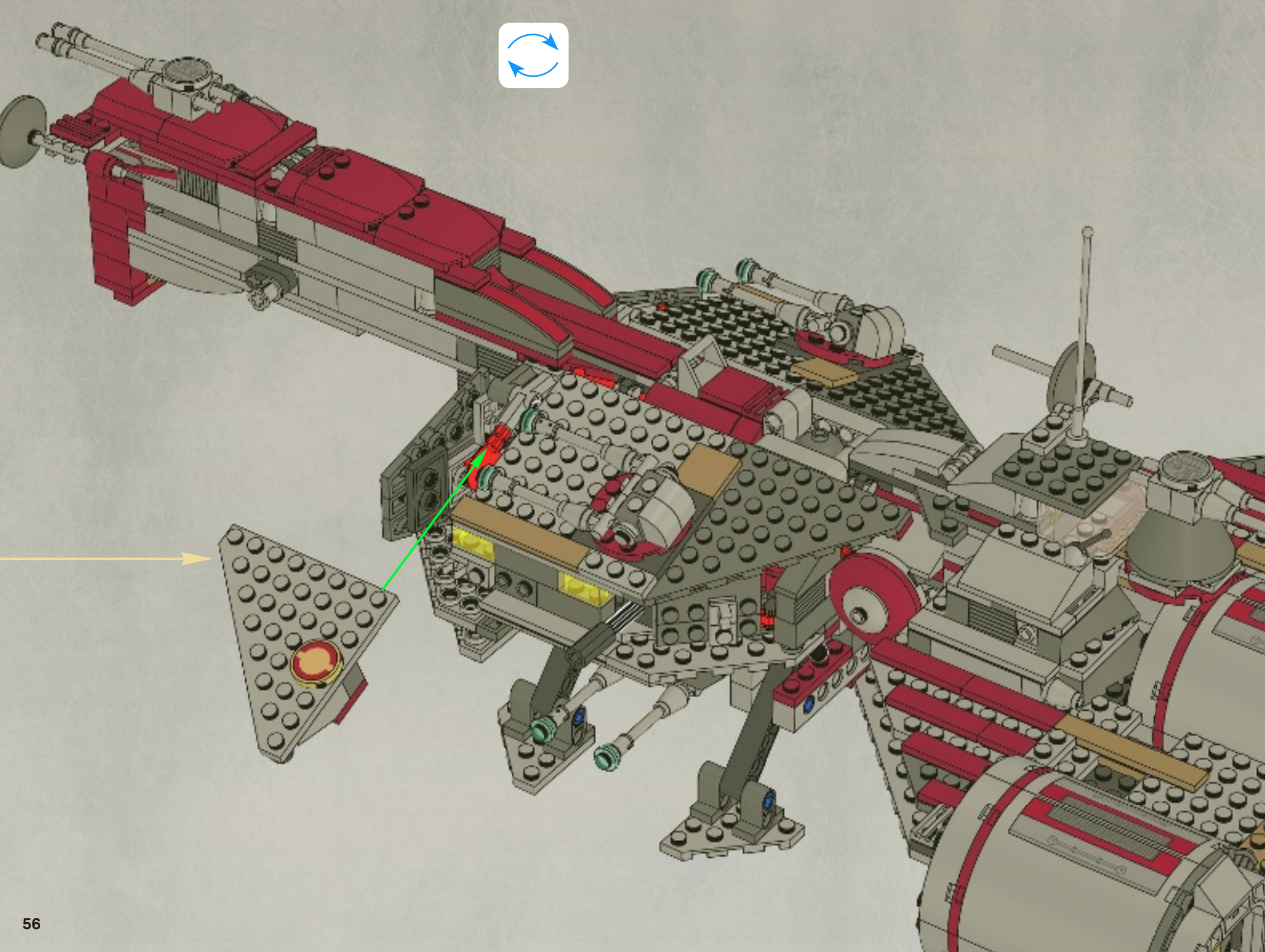





31

1

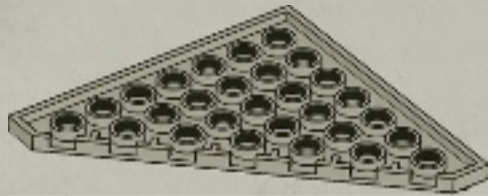

2

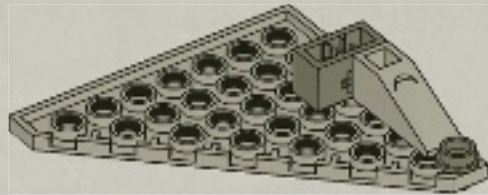

3

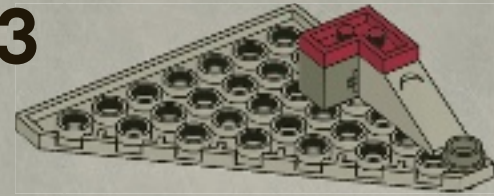

4

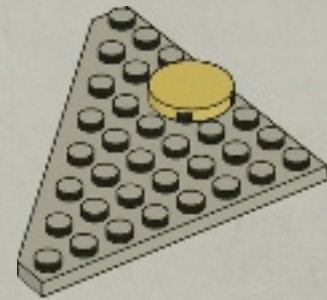

5

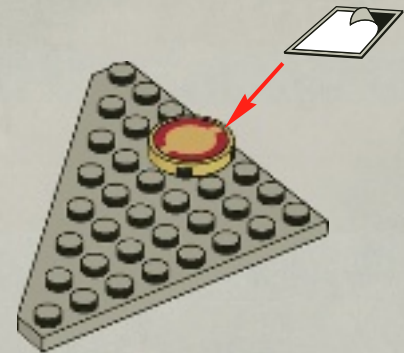



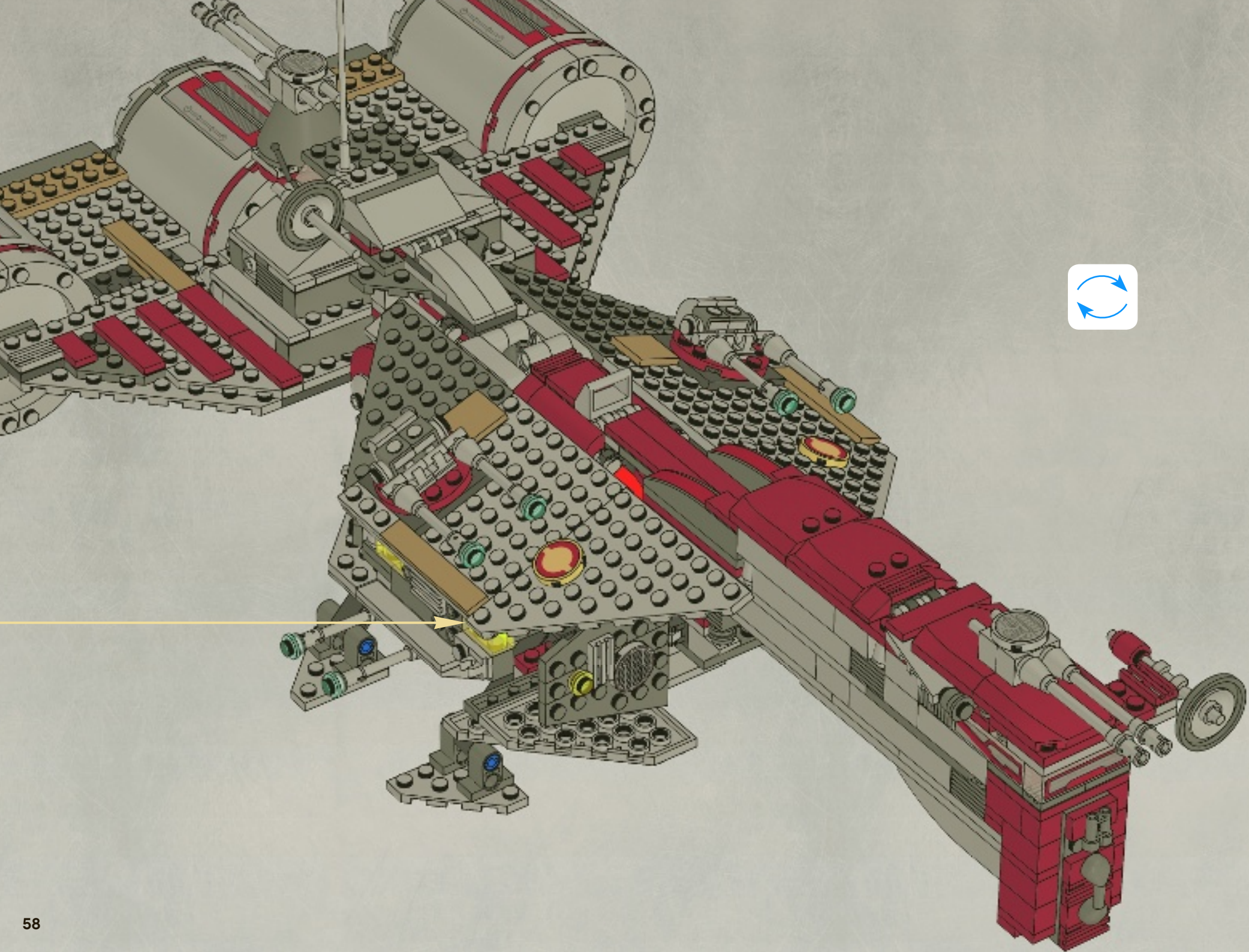



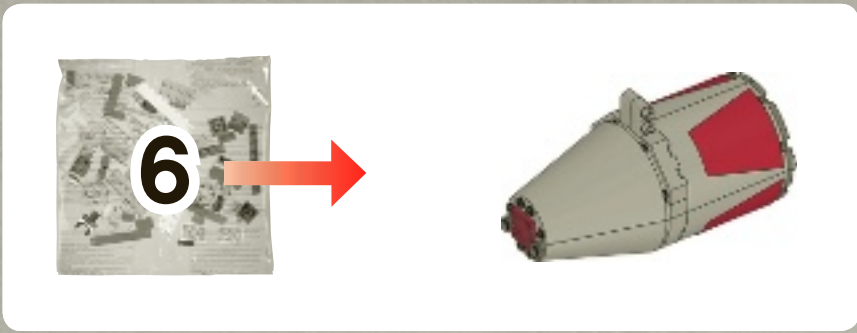

1

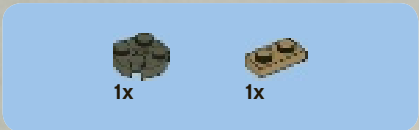
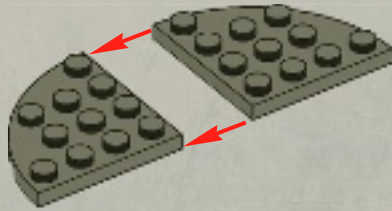

2

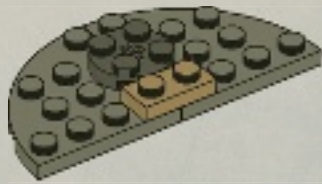

3

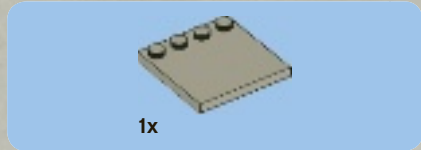
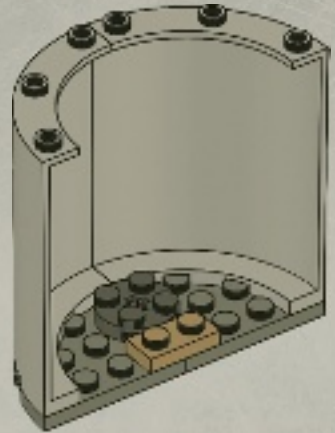

4

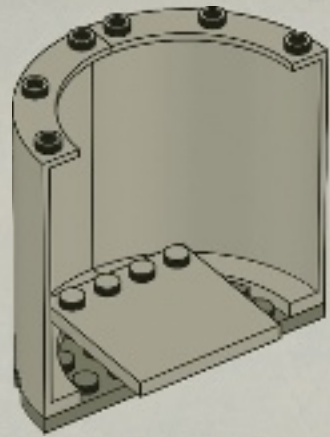



# 5

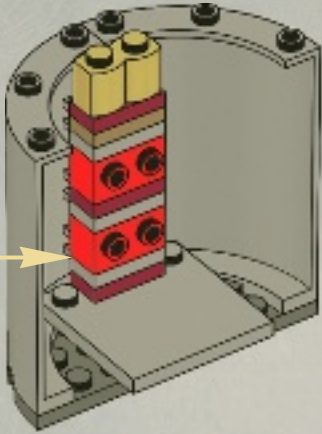



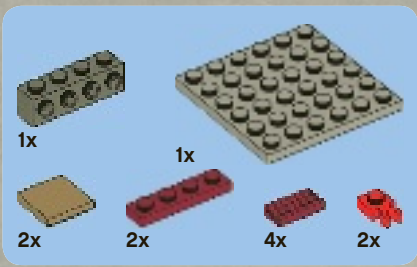

6

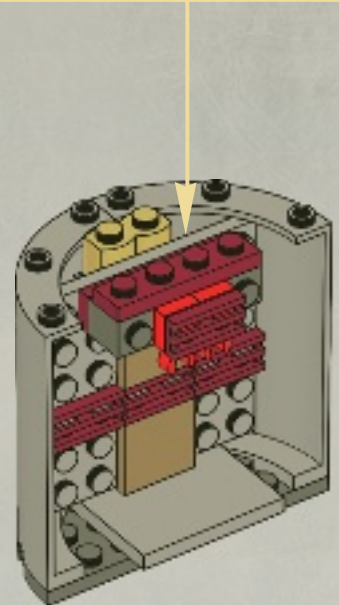
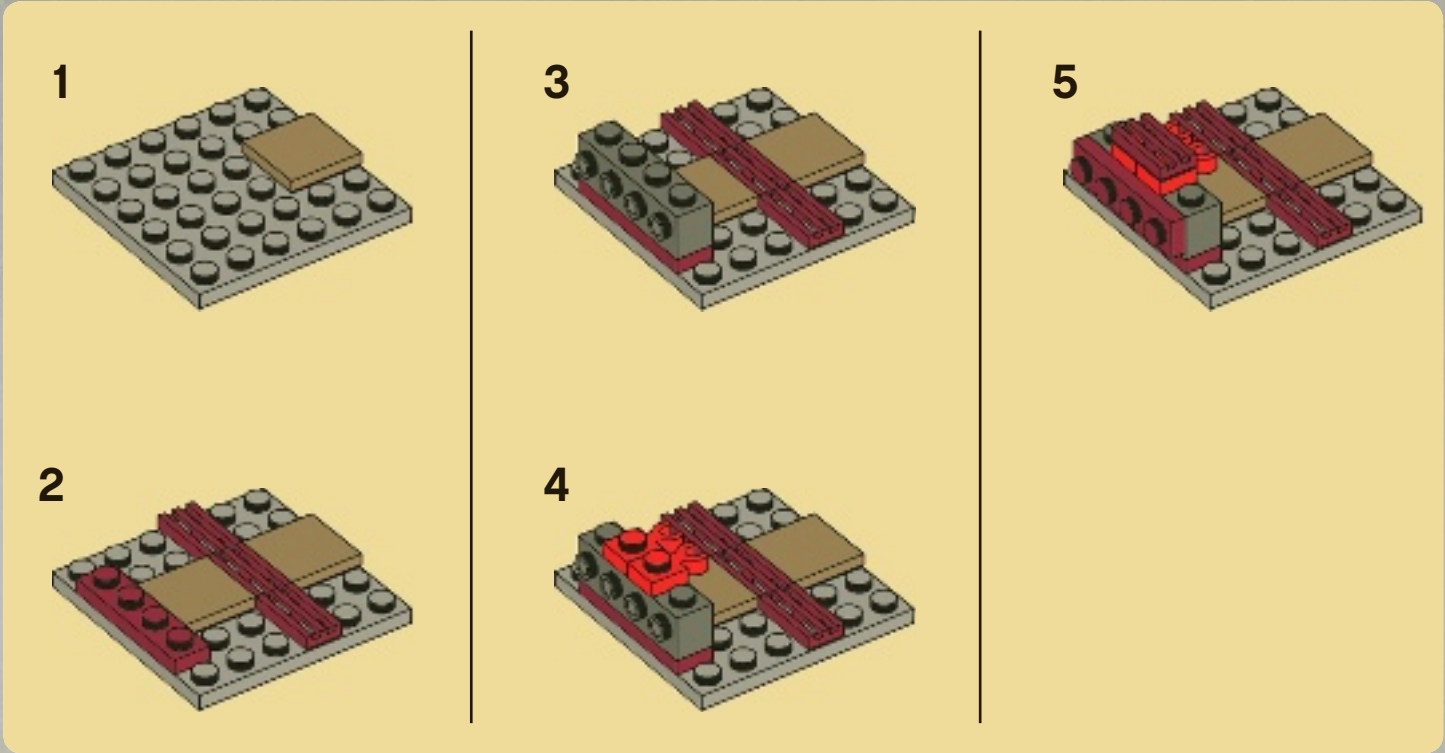

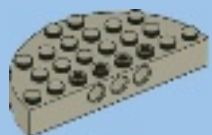

1x

7

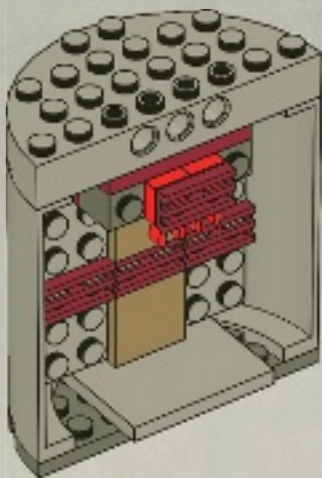

2x

8

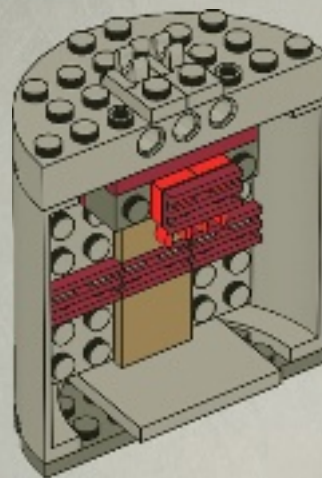





9

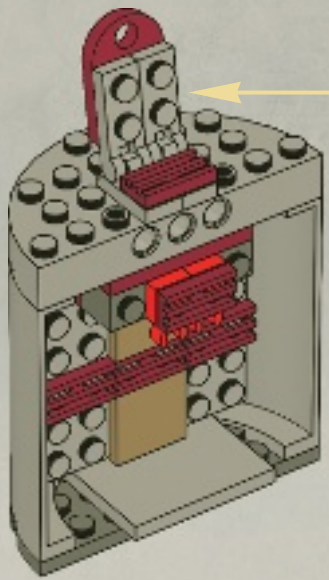

10

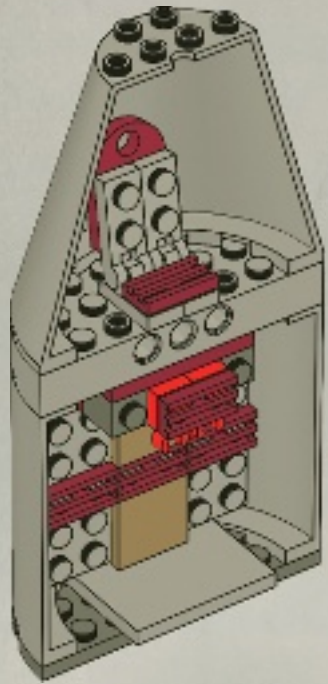

2x

1x

# 11

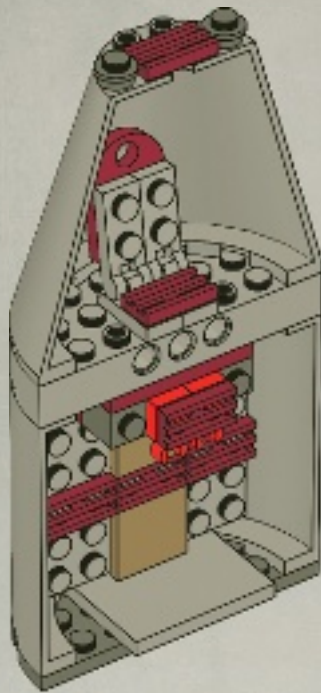

2x

2x

# 12

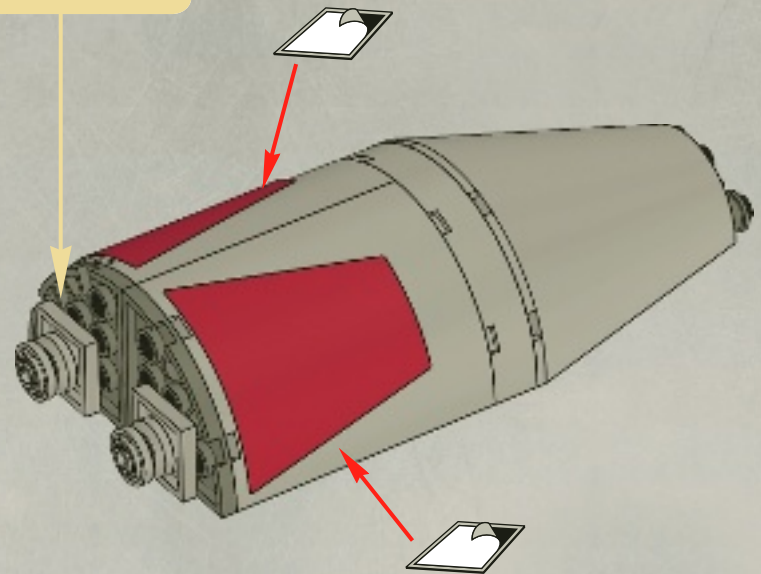
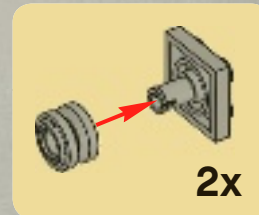





# 13

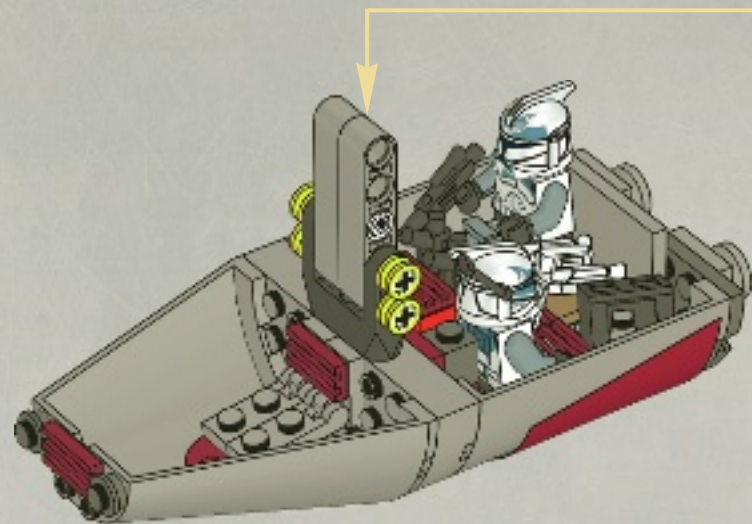
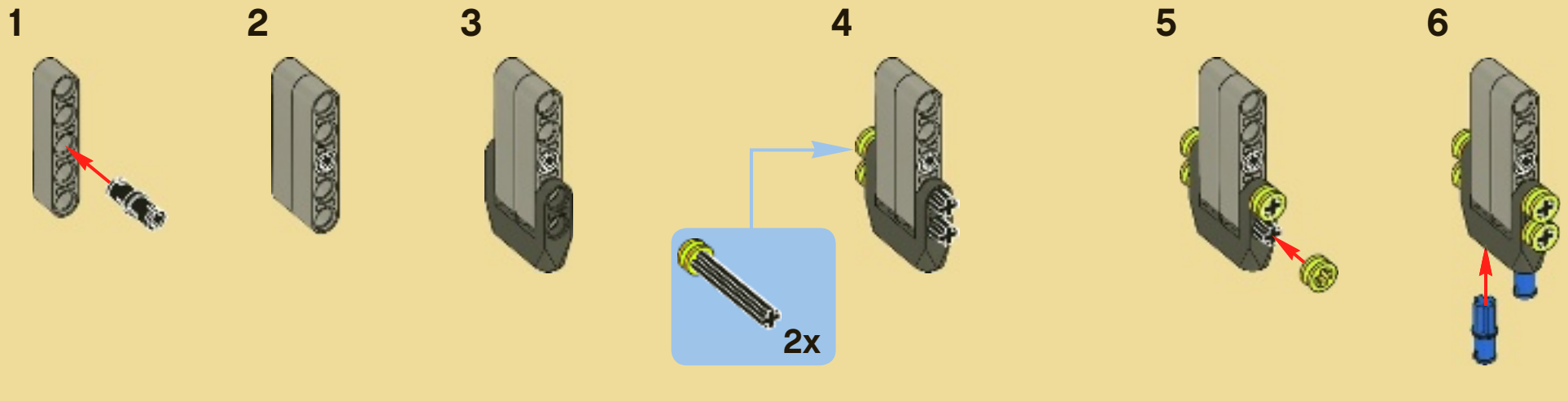

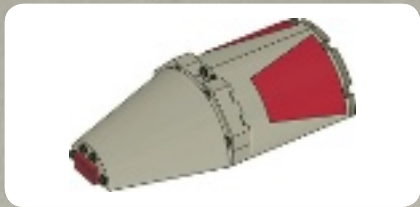

1

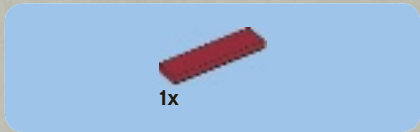
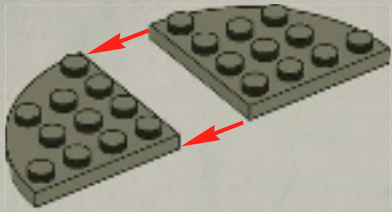

2

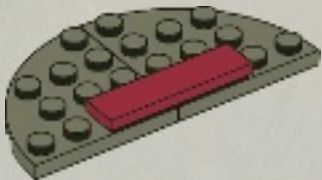

3

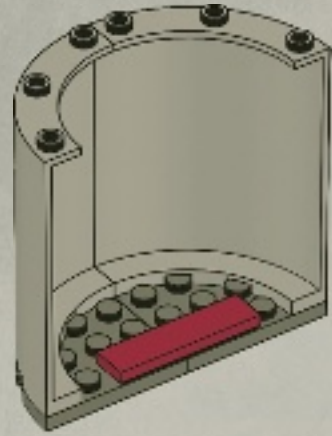

4

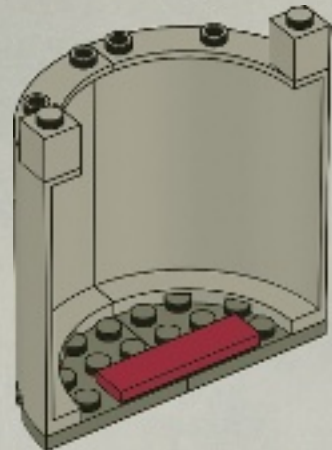





2x

5

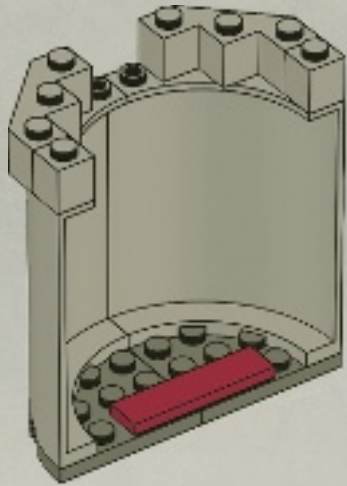

1x

6

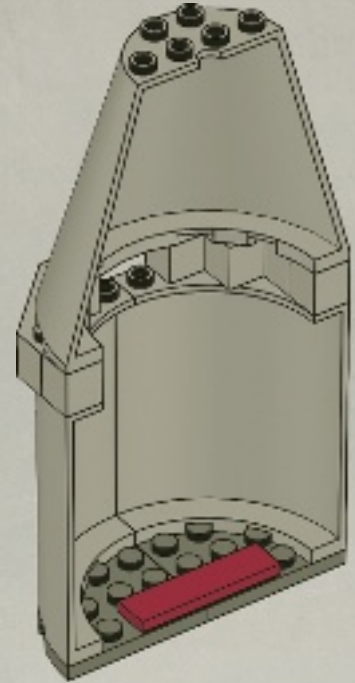



7

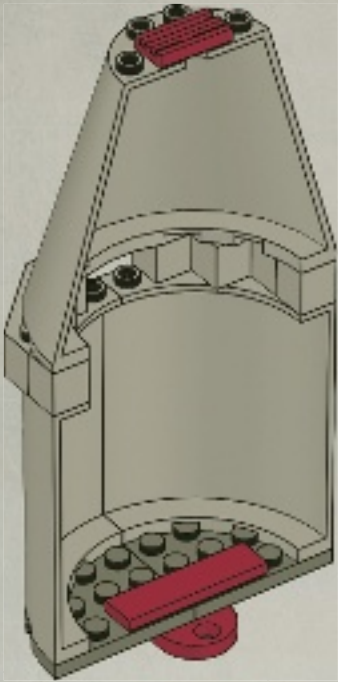

8

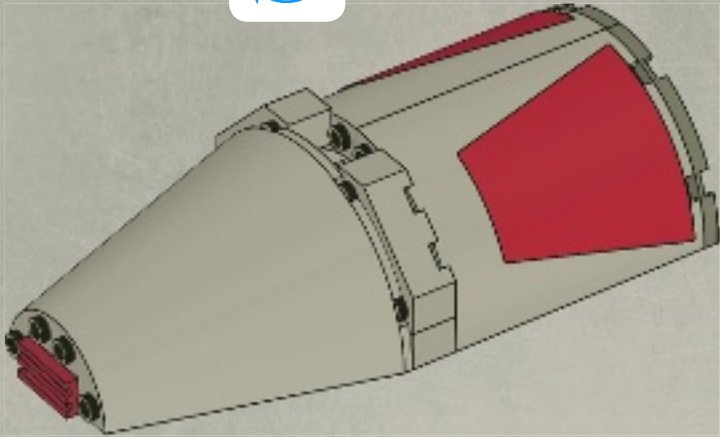

9

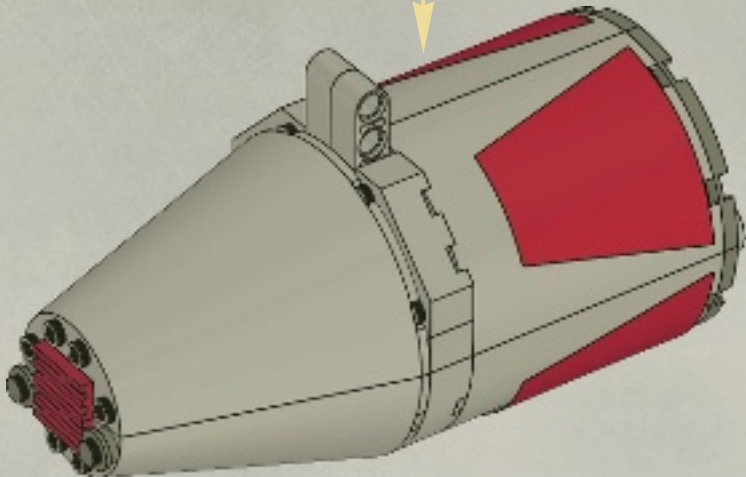



32

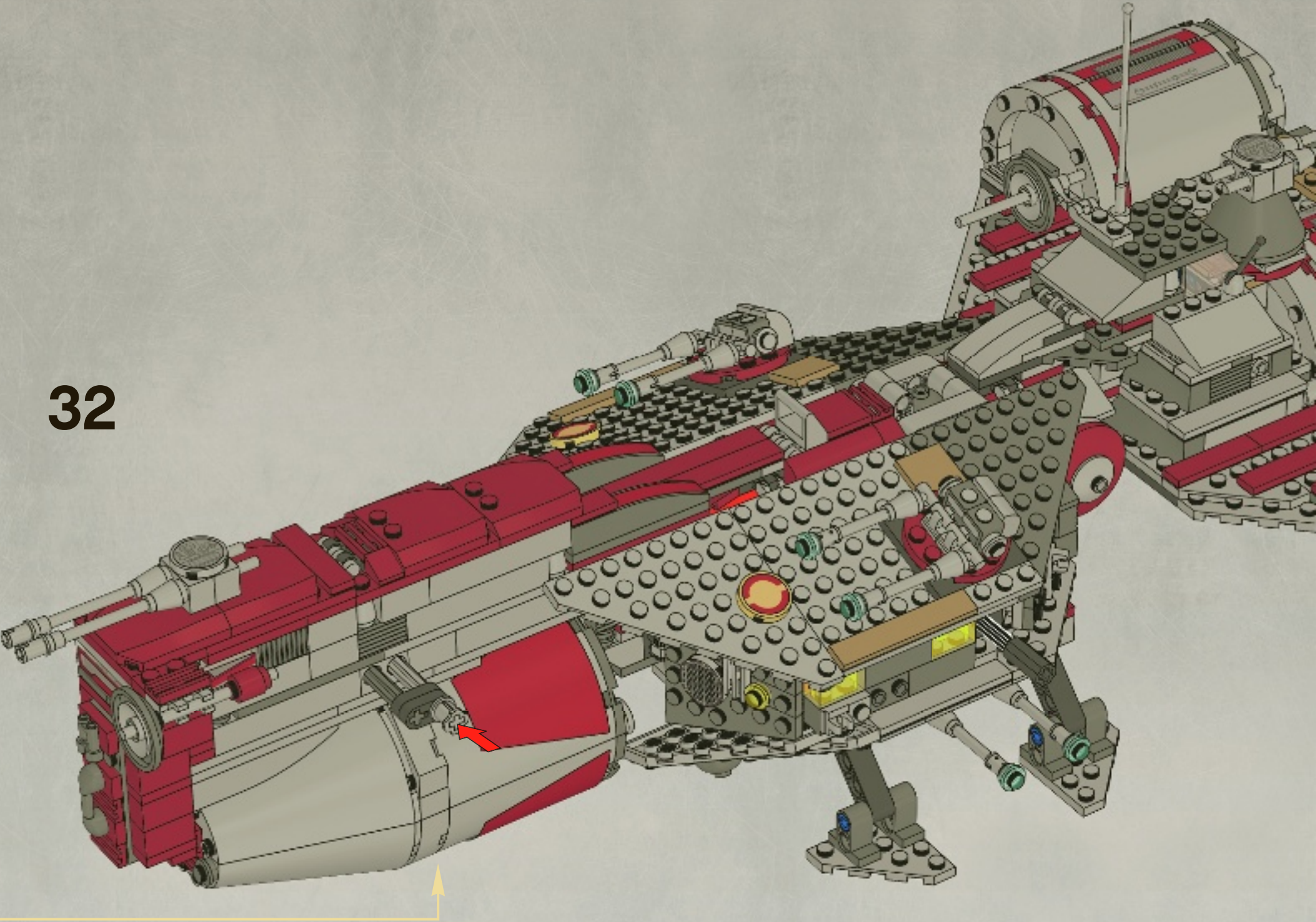



33

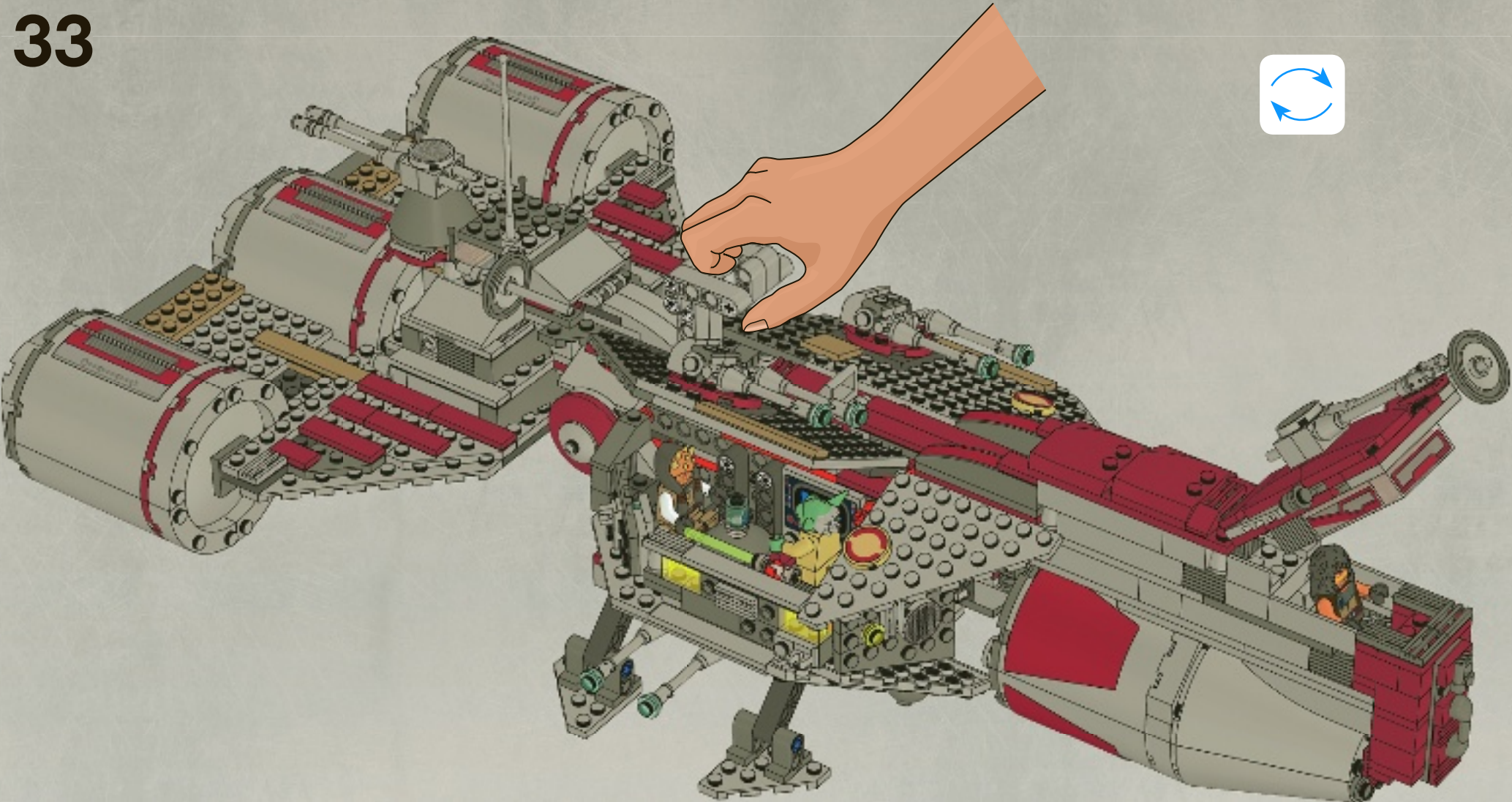











**Customer Service**  
**Kundenservice**  
**Service Consommateurs**  
**Servicio Al Consumidor**  
[www.lego.com/service](http://www.lego.com/service) or dial

00800 5346 5555 :         
 1-800-422-5346 :  





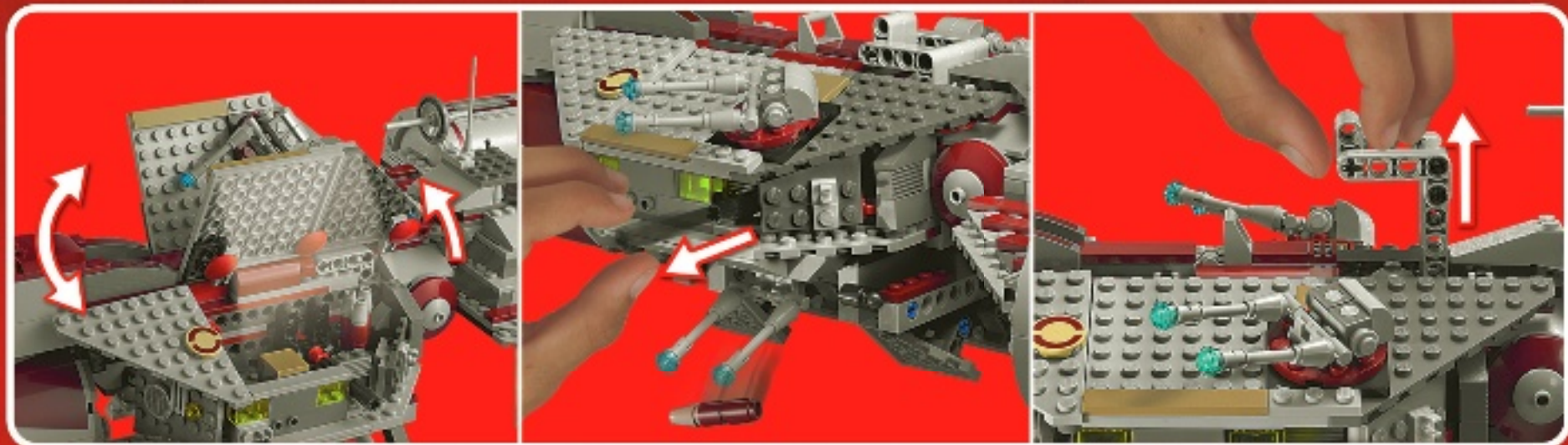

**Clone Commander  
Wolffe™**



**Wolfpack™  
Clone Trooper**



**Eeth Koth™**



**Quinlan Vos™**



**Yoda™**





7913



7914



7915



7868



7869



7929



7930



7931





7956



7957



7961



7962



7964



7965



# STAR WARS™







# STAR WARS III

THE CLONE WARS™



[videogames.LEGO.com](http://videogames.LEGO.com)  
[www.LucasArts.com](http://www.LucasArts.com)

LucasArts and the LucasArts logo are registered trademarks of Lucasfilm Ltd. © 2006-2010, Lucasfilm Entertainment Company Ltd. or Lucasfilm Ltd. & © or TM as indicated. All rights reserved. LEGO, the LEGO logo and the Minifigure are trademarks of The LEGO Group. © 2005-2010 The LEGO Group. All rights reserved.

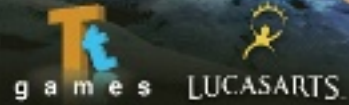





www.LEGOclub.com

# LEGO club

FREE! GRATIS! GRATUIT!



LEGO Club Magazine



LEGO Club Email

VISIT THE WORLD'S BIGGEST LEGO SHOP  
www.LEGOshop.com  
www.LEGOclub.com

00800 5346 5555  
1-866-534-6258 • 1-877-518-5346

\* Freephone. Mobile charges may apply. \* Numéro sans frais. Des frais peuvent s'appliquer avec les téléphones cellulaires. \* Gebührener, Kosten für Anrufe aus Mobilfunknetzen können abweichen. \* Gratis telefonnummer vanaf vaste lijn. \* Det er et gratis nummer, når du ringer fra fasttelefon. \* Det är gratis, när du ringer från en fast telefon. \* Numéro sans frais. Des frais peuvent s'appliquer avec les téléphones portables.

YES! I want to join the LEGO Club FREE! OUI! Je veux m'abonner au LEGO Club GRATUITEMENT!  
Ja! Ich möchte Mitglied im kostenlosen LEGO Club werden. Ja! Ik wil graag GRATIS lid worden van de LEGO Club.  
Ja! Jeg ønsker å melde meg inn i LEGO Club gratis! Ja! Jag vill gå med i LEGO Club GRATIS!

First name · Prénom  
Vorname · Voornaam  
Fornavn · Förnamn

Last name · Nom de famille  
Name · Achternaam  
Etternavn · Efternamn

Date of Birth · Date de naissance  
Geburtsdag · Geboortedatum  
Fødselsdato · Födelsedatum

Boy · Garçon · Junge ·  
Jongen Gutt · Pojke

Girl · Fille Mädchen ·  
Meisje Jente · Flicka

Street · Adresse  
Straße, Hausnr.  
Straat, huisnr.  
Address

City · Ville  
Ort · Woonplaats  
Poststed · Postort

State  
Prov.  
County

Zip/Postcode · Code  
Postal · PLZ · Postcode ·  
Postnummer

Country  
Pays ·  
Land

Email · Courriel ·  
E-Mail · E-post

- Fill in your email address and we will send you a membership confirmation and monthly email newsletters. If you do not wish to receive the newsletters please tick here. Remplis ton adresse e-mail et nous t'enverrons une confirmation d'adhésion ainsi que le bulletin e-mail mensuel. Si tu ne désires pas recevoir le bulletin, coche cette case. Vul je e-mailadres in en we sturen je een bevestiging van je lidmaatschap en maandelijke e-mail nieuwsbrieven. Als je geen e-mail wilt ontvangen, kruis dan dit vakje aan.
- Ich möchte per E-Mail den monatlichen LEGO Club Newsletter erhalten. Ønsker du at vi skal sende en liten hilsen til barnet ditt for å bekrefte medlemskapet, ber vi deg krysse av i feltet, samt oppgi e-postadressen som hilsen skal sendes til. Om du vill att vi ska skicka en bekräftelse på ditt barns medlemskap, ber vi dig sätta ett kryss i rutan och skriva den e-post adress som bekräftelsen ska skickas till.
- If you do not wish to receive additional mailings from the LEGO Club please tick here. Si tu ne désires pas recevoir de courrier supplémentaire du Club LEGO, coche cette case. Als je geen verdere post van de LEGO Club wilt ontvangen, kruis dan dit vakje aan.
- Dersom du ønsker å motta annen informasjon fra LEGO Gruppen, setter du et kryss her.

Mail to: / Poster à:	LEGO Club P.O. Box 1157 Enfield, CT USA 06083-1157	Per Post an:	LEGO Club Postfach 14 15 D-36243 Niederaula	Send til:	LEGO Club Norge Postboks 58 1314 Vøyenenga
Mail to:	LEGO Club 33 Bath Road Slough SL1 3UF United Kingdom	Stuur op naar:	LEGO Club Postbus 40250 3504 AB Utrecht	Skickas till:	LEGO Club Sverige Ubox 841 202 29 Malmö
Poster à:	LEGO Club 21 rue de la banque 75 002 PARIS FRANCE				

The English language version of the magazine can only be mailed to addresses in the US, Canada, the UK, and Republic of Ireland. Club membership is valid for two years and includes free copies of the LEGO Club Magazine and e-mail newsletters. In the US and Canada please allow up to 6 weeks for delivery of your first magazine. In the UK and Republic of Ireland please allow six to 14 weeks for delivery of your first magazine. By signing this form you consent the LEGO Club to use your child's data for LEGO mailings. The data will only be used for LEGO mailings and will not be sold, rented or otherwise disclosed to any company outside the LEGO Group except for disclosure to companies acting as our agents to help us provide services requested by the child. This coupon is valid for one free membership per person, group or organization. Photocopied coupons are accepted. La version française du magazine peut être postée uniquement au Canada. L'abonnement est valide pour 2 ans et inclut des exemplaires gratuits du Magazine LEGO. Aux É.-U. et au Canada, allouer 6 semaines pour la livraison initiale. En remplissant ce formulaire, vous consentez ce que LEGO utilise les informations de votre enfant pour des envois postaux de LEGO. L'information sera utilisée uniquement pour des envois postaux par LEGO et ne sera en aucun cas, vendue, louée, échangée ou divulguée à d'autres compagnies autres que la compagnie LEGO à l'exception des compagnies affiliées qui nous procurent des services auxquels l'enfant en a fait la demande. Formulaire des photocopies acceptées. Mit der folgenden Unterschrift erkläre ich, für mein Kind den Beitritt als Mitglied zum kostenlosen LEGO Club, der von der LEGO GmbH, D-85627 Grasbrunn, betrieben wird. Die Mitgliedschaft beinhaltet die Zusendung des LEGO Club Magazins und kann beiderseits jederzeit beendet werden. Mit der Mitgliedschaft im LEGO Club sind keinerlei Verpflichtungen verbunden. Das deutschsprachige LEGO Club Magazin wird nur an Adressen in Deutschland, Österreich und der Schweiz versendet. Eine Anmeldebestätigung kann nur per E-Mail geschickt werden. Das Magazin erscheint fünfmal jährlich. Daher kann die Zustellung des ersten Heftes bis zu drei Monate dauern. Die Mitgliedschaft ist beidseitig jederzeit kündbar, ohne dass Ihnen Kosten entstehen. Sie können der werblichen Nutzung Ihrer Daten jederzeit widersprechen. Kündigung und Widerspruch können Sie telefonisch erklären (00800 / 5346 5555, Anruf gebührenfrei, Kosten für Anrufe aus dem Mobilfunknetz können abweichen) oder an die LEGO GmbH senden. Het Nederlandse LEGO Club Magazine kan alleen worden gestuurd naar adressen in Nederland. Het lidmaatschap is 2 jaar geldig en geeft recht op toezending van het gratis LEGO Club Magazine en LEGO Club e-mails. Het eerste magazine zal binnen 12 tot 14 weken toegestuurd worden. Het lidmaatschap kan op ieder moment opgezegd worden en kan na 2 jaar gratis worden verlengd, tenzij LEGO met deze activiteit stopt. Uw gegevens worden uitsluitend gebruikt voor mailings van LEGO en zullen niet worden verkocht, verhuurd of op welke wijze dan ook verstrekt aan derden buiten de LEGO Group, uitgezonderd de organisaties die namens ons optreden om de informatie te sturen waarvoor toestemming is verleend. Den norske utgaven av magasinet sendes kun til adresser i Norge. Medlemskap i klubben gjelder i 2 år og inkluderer gratisutgaver av LEGO Club Magazine. Påregnet minimum opp til seks uker leveringstid for dette skjemaet. Ved å undertegne dette skjemaet, gir du ditt samtykke til at LEGO Club kan bruke opplysningene om barnet ditt i LEGO forsendelser. Dataene vil utelukkende bli brukt i LEGO forsendelser og vil ikke bli solgt, utleid eller på annen måte gjøres tilgjengelig for selskaper utenfor LEGO gruppen, unntatt selskaper som er våre agenter og som hjelper oss å tilby tjenestene barnet etterspør. Dette skjemaet gjelder for ett gratis medlemskap per person, gruppe eller organisasjon. Den svenska versionen av tidningen kan endast skickas till adresser i Sverige. Club-medlemskapet är giltigt i 2 år och innefattar gratis exemplar av LEGO Club Magazine. Vånilgen räkna med minimum 6 veckor för leverans av din första tidning. Genom att skicka in det här formuläret godkänner du att LEGO Club använder barnets uppgifter för LEGO utskick. Uppgifterna kommer bara att användas för LEGO utskick och kommer inte att säljas, hyras ut eller vidarebefordras till något företag som inte tillhör LEGO Gruppen, med undantag av företag som agerar som våra ombud för att tillhandahålla tjänster som barnet har begärt. Den här kupongen gäller för ett gratis medlemskap per person, grupp eller organisation. En complément ce bulletin d'adhésion, vous acceptez que LEGO Club utilise les données relatives à votre enfant pour l'envoi de courriers concernant LEGO. Ces données seront uniquement utilisées pour l'envoi d'information concernant LEGO et ne seront ni vendues, ni louées, ni utilisées par d'autres sociétés que le groupe LEGO, à l'exception des sociétés agissant pour le compte de LEGO en tant que sous-traitant de services divers. L'abonnement au LEGO Club est valable pour une période de 2 ans. Il inclut l'envoi par courrier du magazine LEGO Club et par email des newsletters. Un délai de 6 à 14 semaines est à prévoir pour la réception de votre premier magazine. Ce bulletin d'adhésion gratuit est valable pour l'inscription d'une seule personne. Les photocopies sont acceptées. ATTENTION! Le bulletin d'adhésion doit être rempli et signé par un parent ou un tuteur.

Parent's signature · Signature d'un parent ou d'un tuteur  
Unterschrift Erziehungsberechtigte/r · Handtekening ouders  
Foreldres/foresattes underskrift · Förälders /förmyndares underskrift

Date  
Datum  
Date





# WIN

Go to [www.LEGOsurvey.com/product](http://www.LEGOsurvey.com/product) to fill out a survey for a chance to win a cool LEGO® Product. No purchase necessary. Open to all residents where not prohibited.

 [www.LEGO.com](http://www.LEGO.com)



# [www.LEGOsurvey.com/product](http://www.LEGOsurvey.com/product)

## GEWINNE!

Nimm an der Umfrage auf [www.LEGOsurvey.com/product](http://www.LEGOsurvey.com/product) teil und hab die Chance ein cooles LEGO® Produkt zu gewinnen!

Die Teilnahme am Gewinnspiel führt zu keinerlei Kaufverpflichtungen. Teilnahme in allen nicht ausgeschlossenen Ländern möglich.

6008541

## WIN!

Ga naar [www.LEGOsurvey.com/product](http://www.LEGOsurvey.com/product), vul een enquêteformulier in en maak kans op een cool LEGO® product.

Geen aankoopverplichting. Iedereen mag deelnemen, uitgezonderd ingezetenden van landen waar een enquêteverbod geldt.

## GAGNE !

Visite [www.LEGOsurvey.com/product](http://www.LEGOsurvey.com/product) pour répondre à un questionnaire et avoir une chance de gagner un produit LEGO® très cool !

Aucune obligation d'achat. Ouvert à tous les résidents des pays autorisés.

LEGO and the LEGO logo are trademarks of the LEGO Group. ©2011 The LEGO Group

## 当選

www.LEGOsurvey.com/product  
アンケート  
製品

お買い  
禁止さ

