



CITY

7938



WARNING: CHOKING HAZARD.
Small parts. Not for children under 3 years.



1

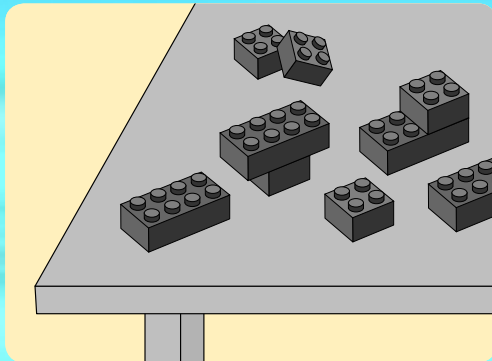
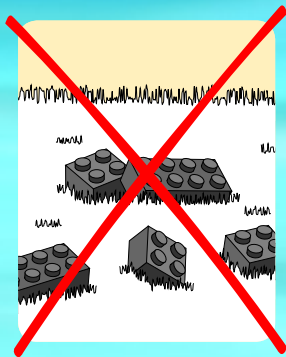

2

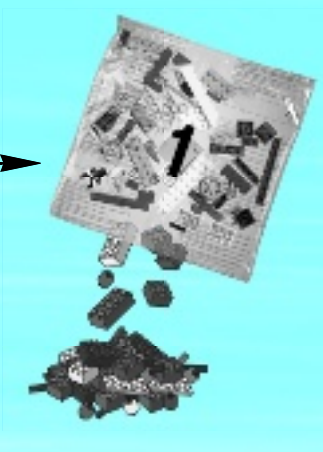
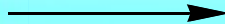

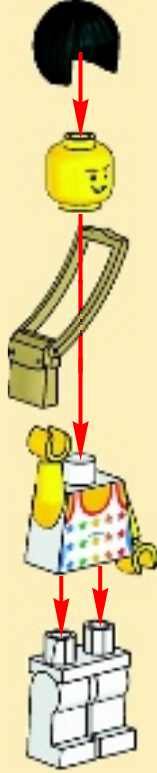
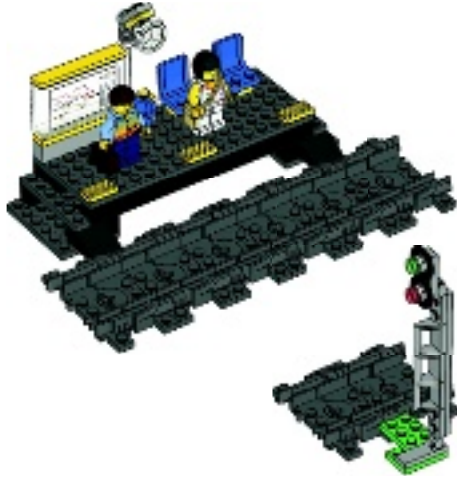

AVERTISSEMENT : RISQUE D'ÉTOUFFEMENT.
Contient des petites pièces. Ne convient pas aux enfants de moins de 3 ans.



ADVERTENCIA: PELIGRO DE ASFIXIA.
No recomendado para niños menores de 3 años. Contiene piezas pequeñas.

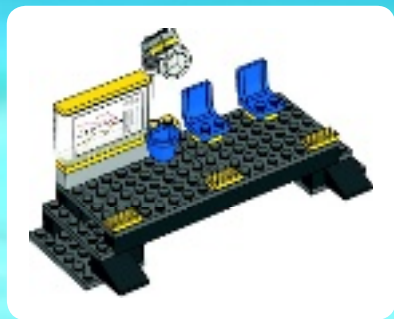

1



2



3



4

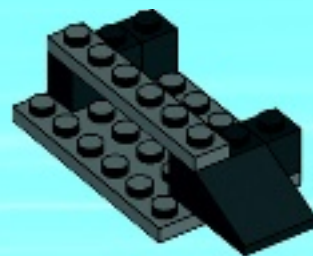

5

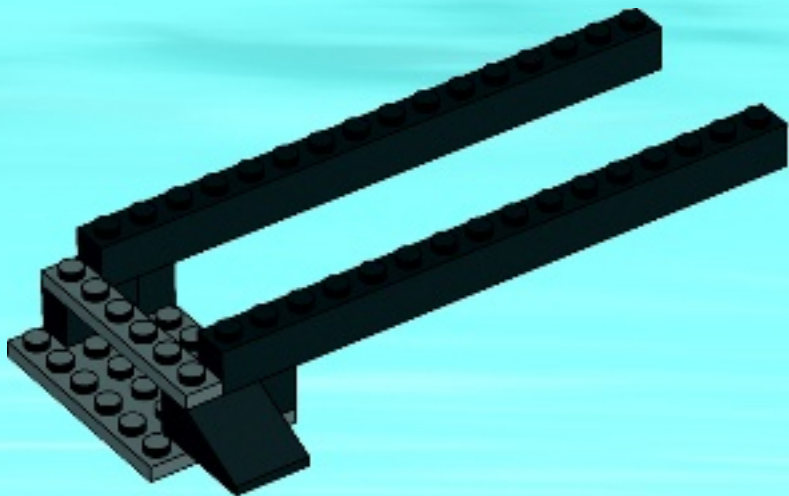



1



2



3



4



6



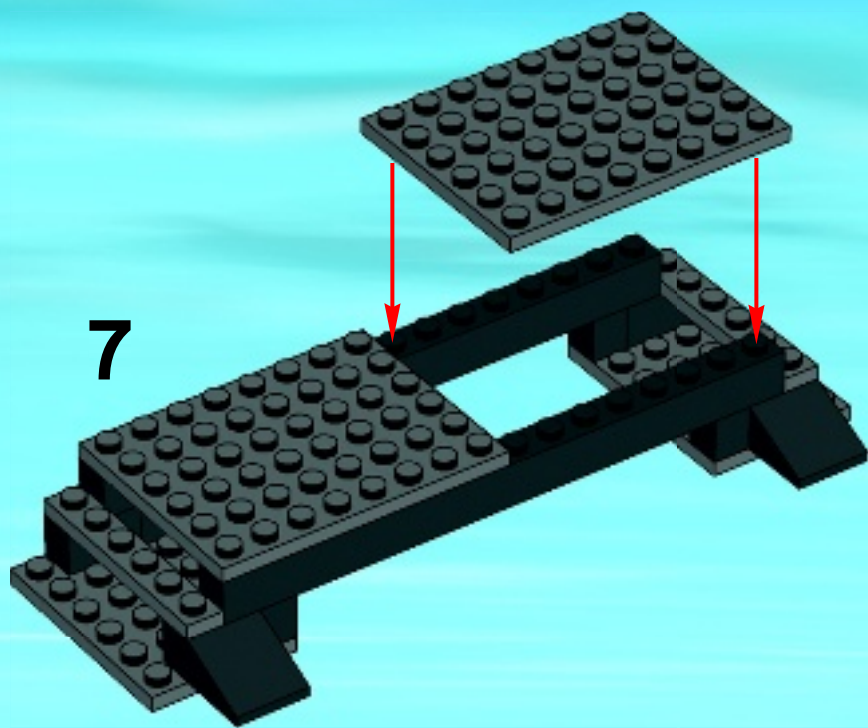

8

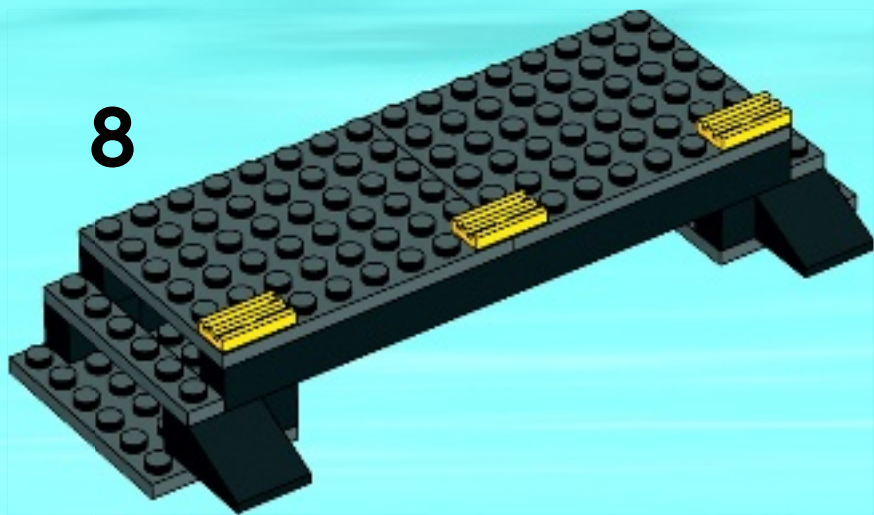

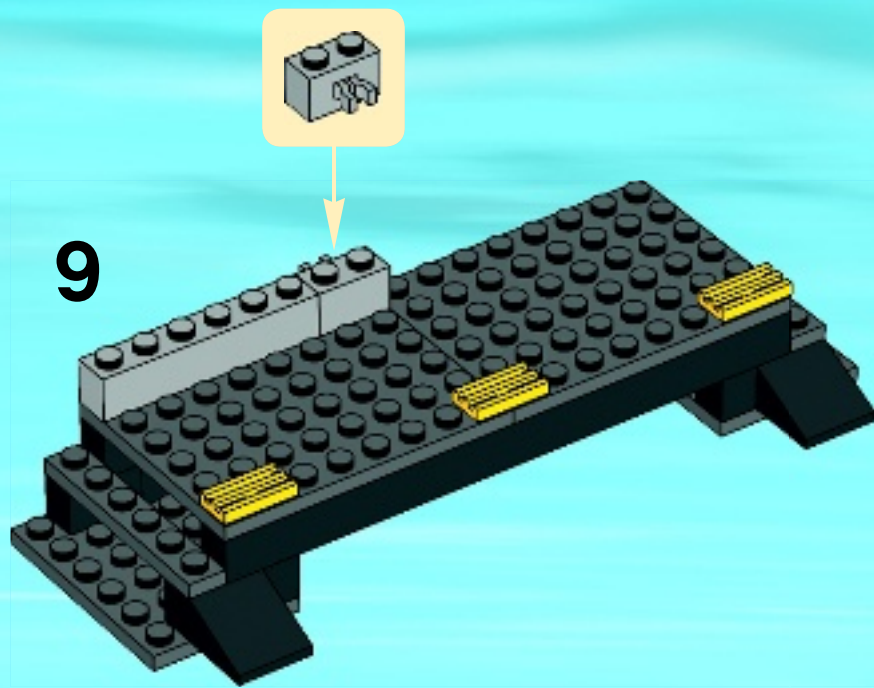



1

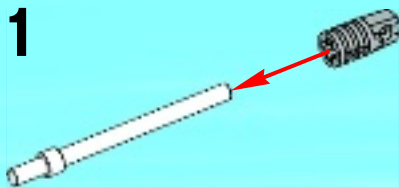

2

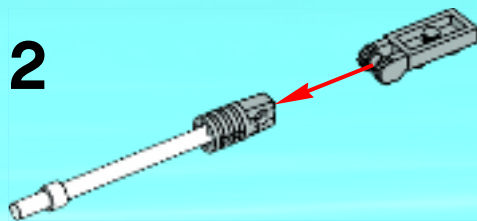

3

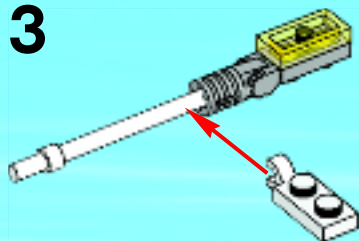

4

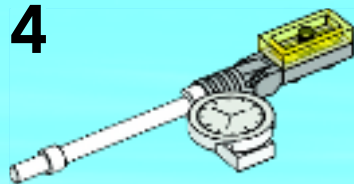

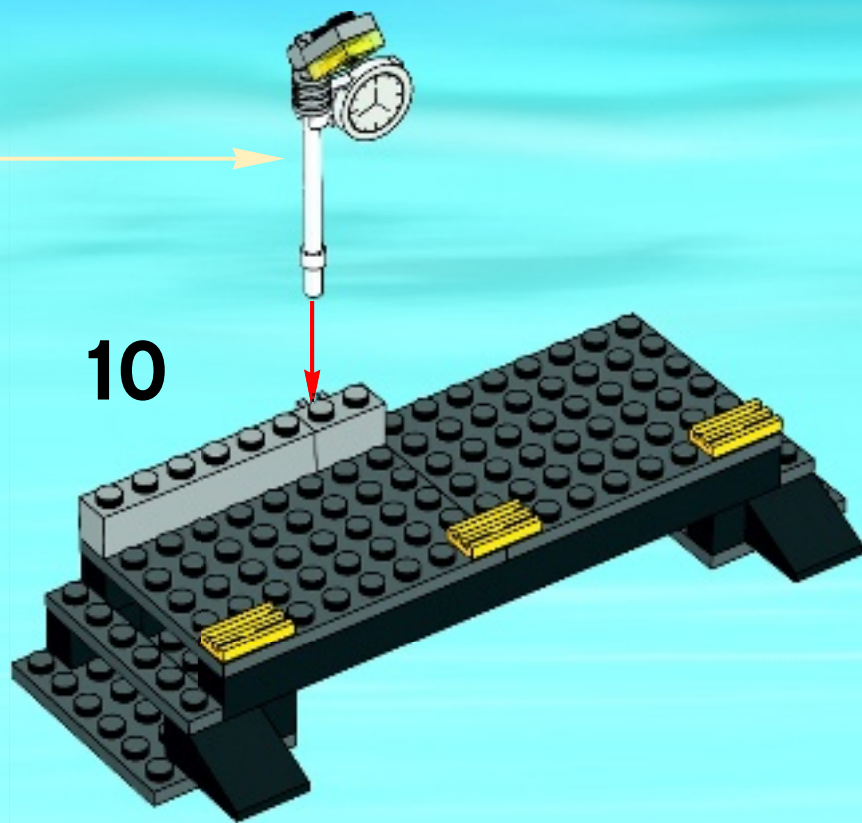

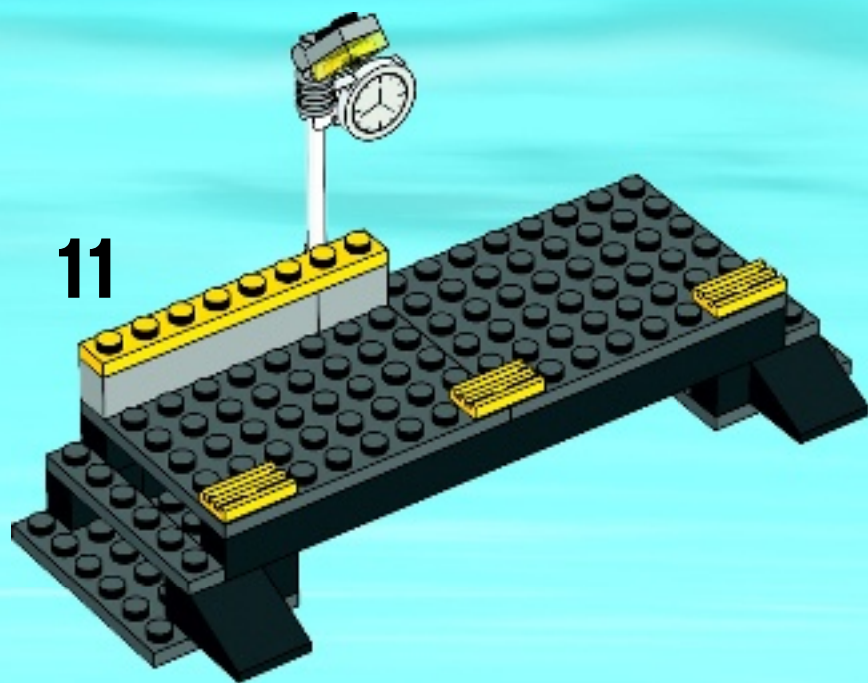

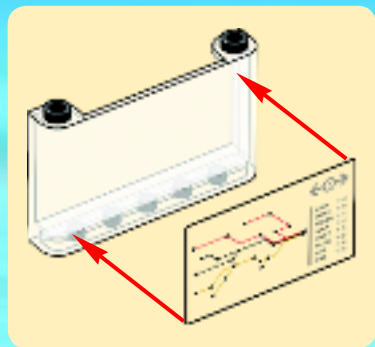

12

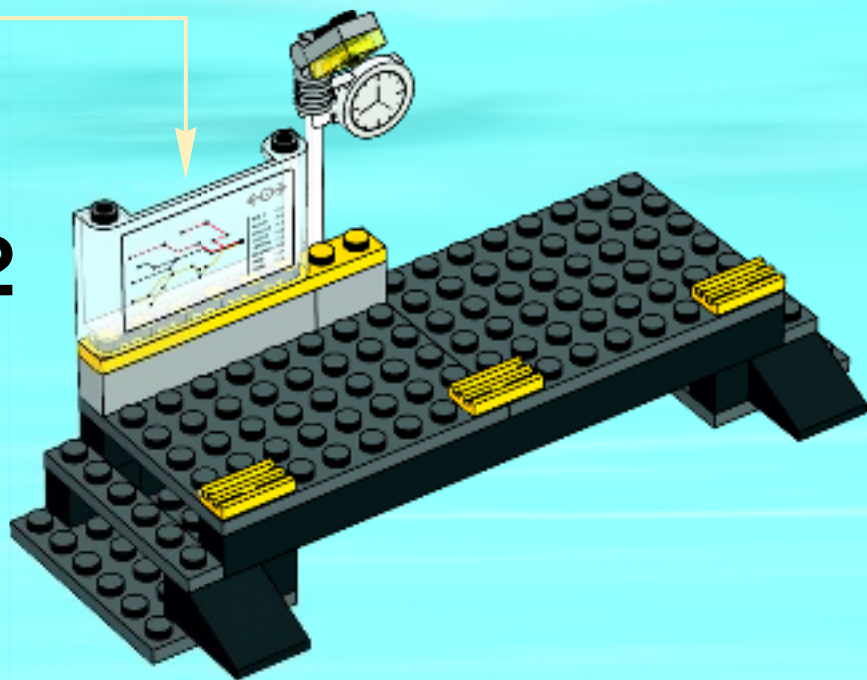

13

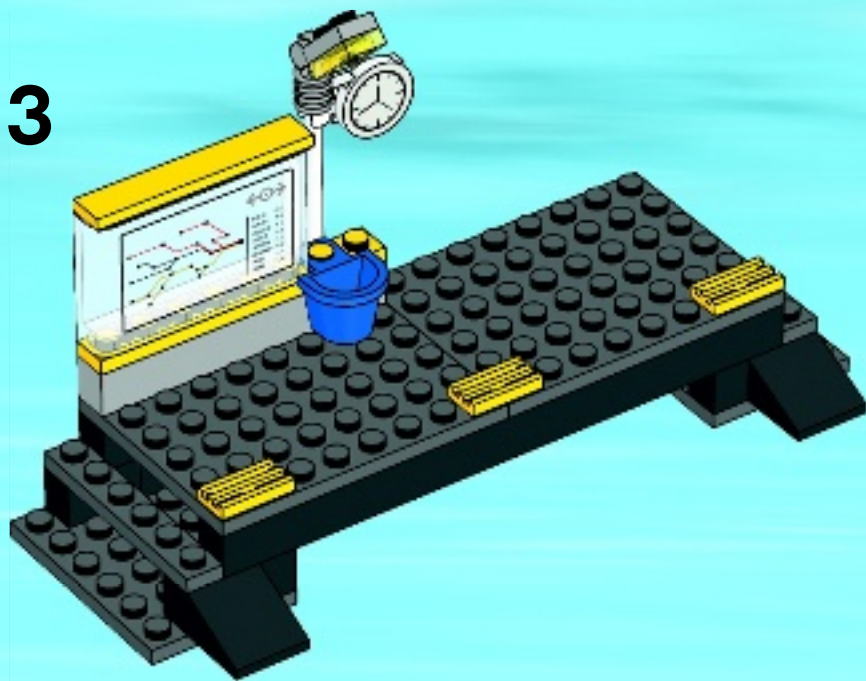

14

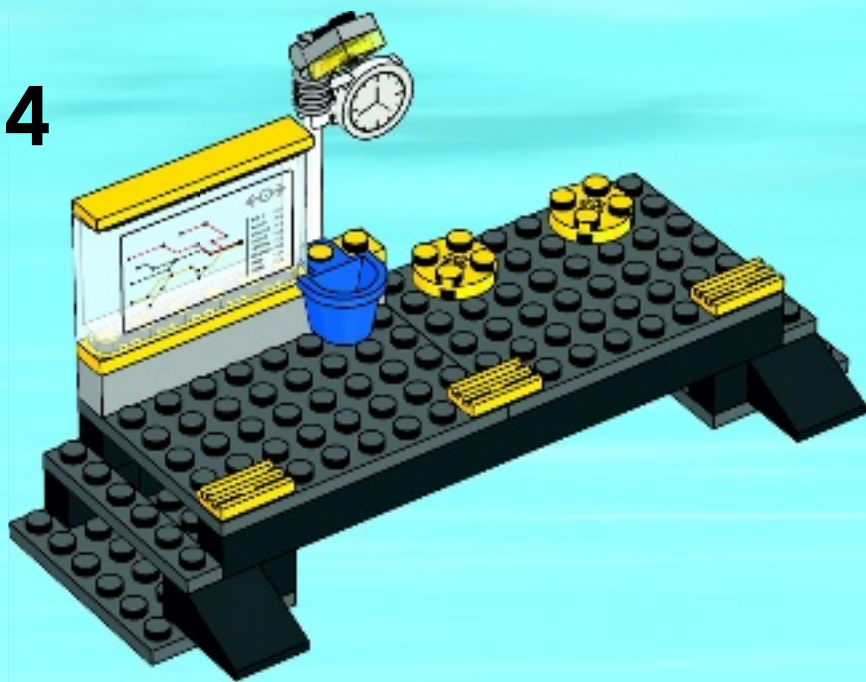

15

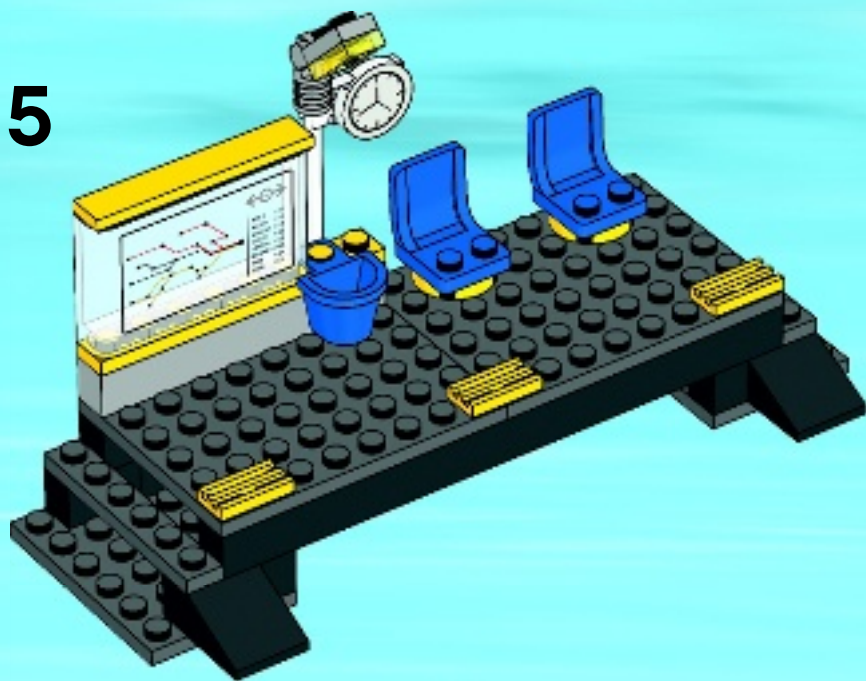

16

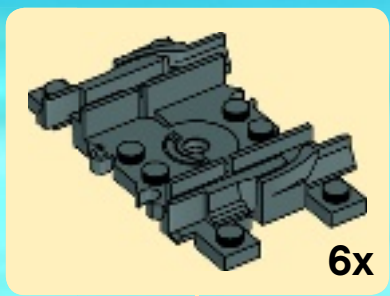
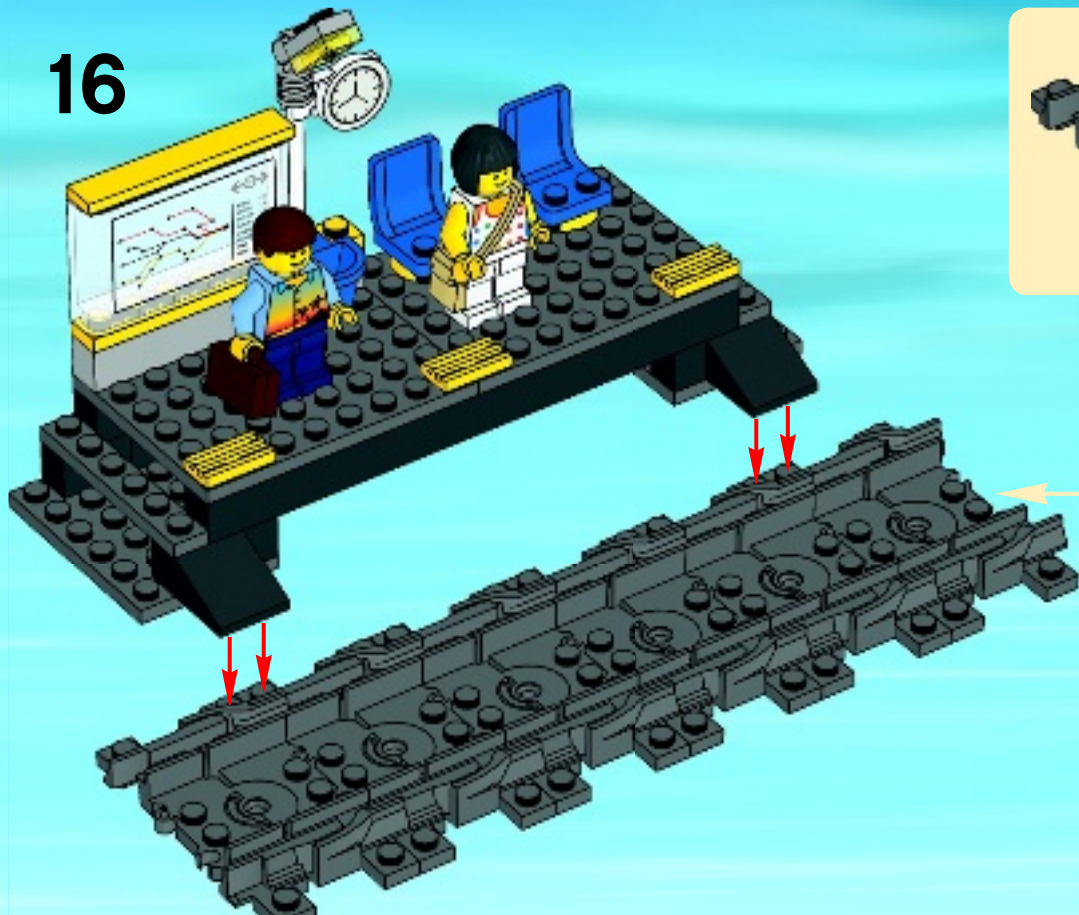



1

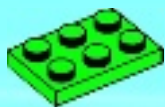

2

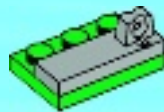

3

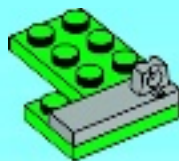

4

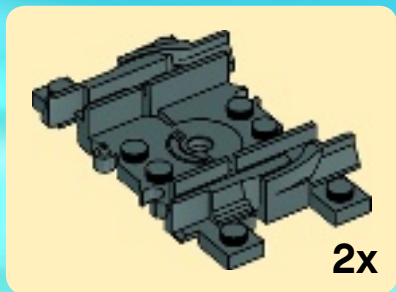
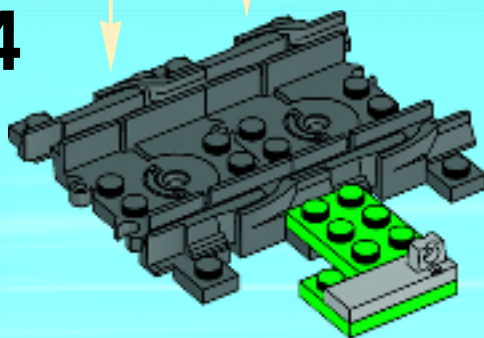



1

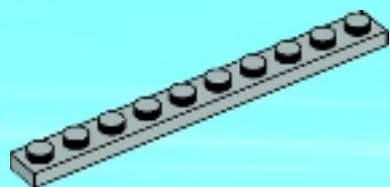

2

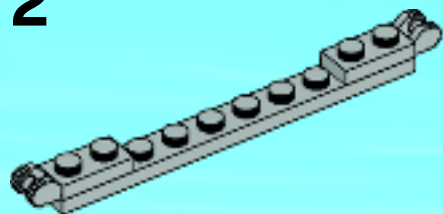

3

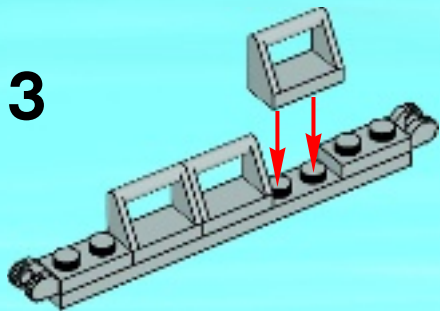

4

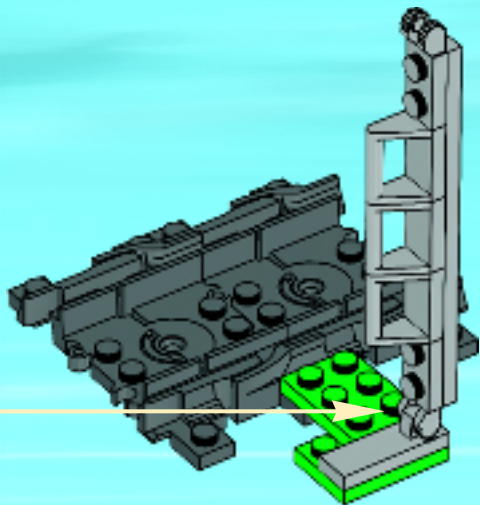

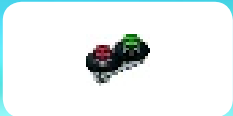

1

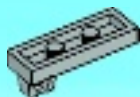

2



3

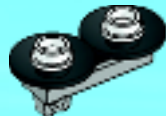

4



5

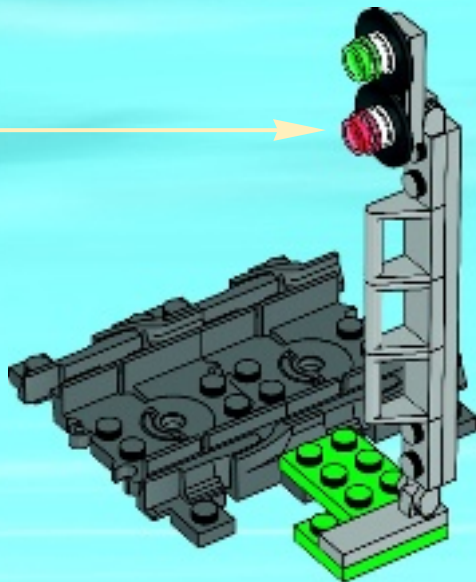

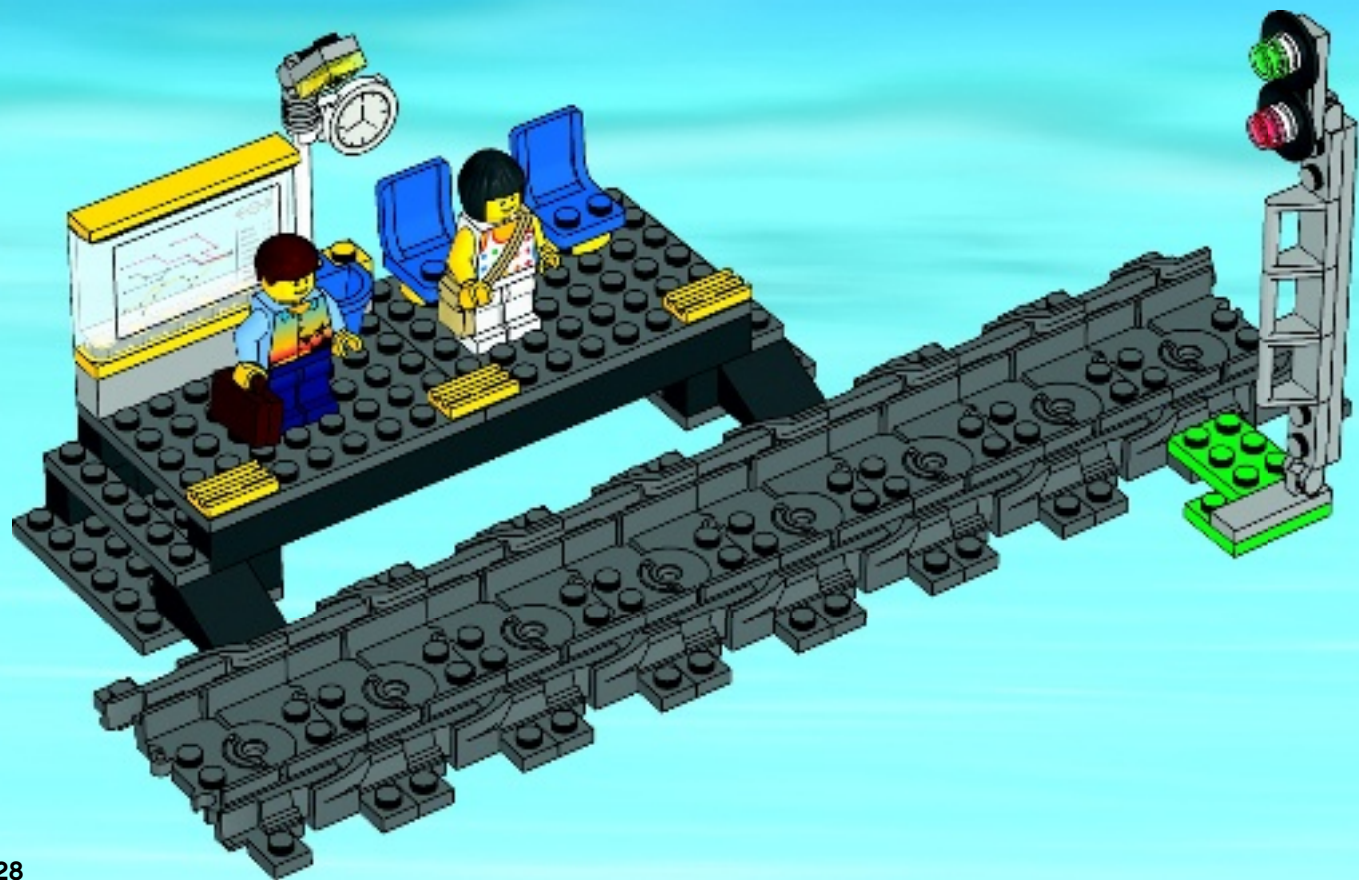

LEGO

CITY



7895

7896

7936

7937

7938

7939



CITY



4440



4439



4441



4437



4436



CITY



7279



7285



7286



7287



7288



7498



www.LEGOclub.com



LEGO® Club Email



LEGO® Club Magazine

LEGO club™

FREE! GRATIS! GRATUIT!

SIGN UP ONLINE!

www.LEGOclub.com



00800 5346 5555*



1-866-534-6258 • 1-877-518-5346

US & Canada only

Outside call charges

- * Freephone. Mobile charges may apply.
- * Numéro sans frais. Des frais peuvent s'appliquer avec les téléphones cellulaires.
- * Gebührenfrei, Kosten für Anrufe aus Mobilfunknetzen können abweichen.
- * Gratis telefonnummer vanaf vaste lijn.
- * Det er et gratis nummer, når du ringer fra fasttelefon.
- * Det är gratis, när du ringer från en fast telefon.
- * Numéro sans frais. Des frais peuvent s'appliquer avec les téléphones portables.

LEGO and the LEGO logo are trademarks of the/son des marques de commerce de/son marcas registradas de LEGO Group. ©2010, 2011 The LEGO Group. 6012200

BI114