



DC UNIVERSE™

SUPER HEROES



76009



1



2



3



4





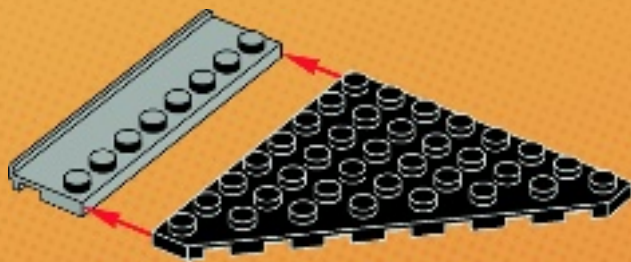
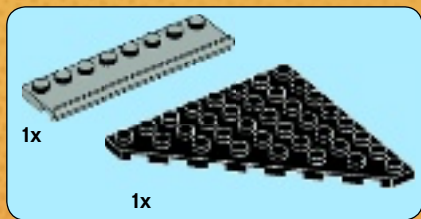

1



1x



1x

2



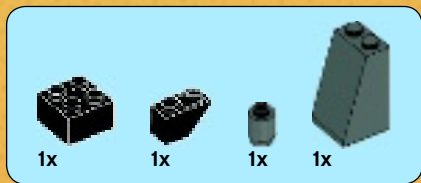

3

1

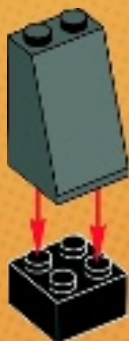

2



3

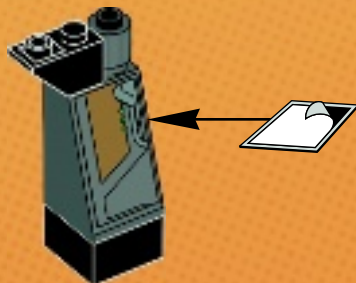

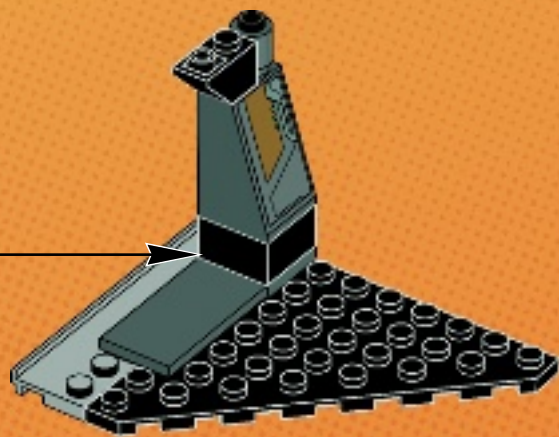

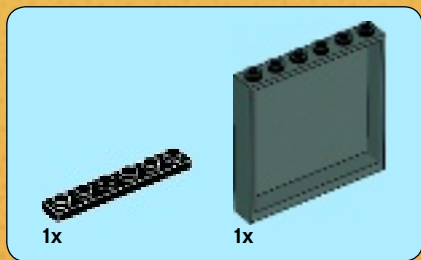

4

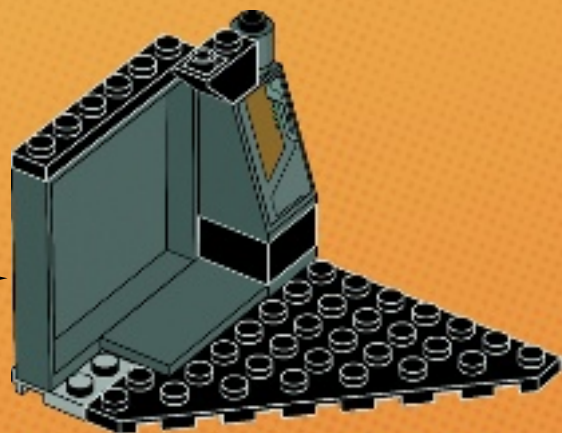
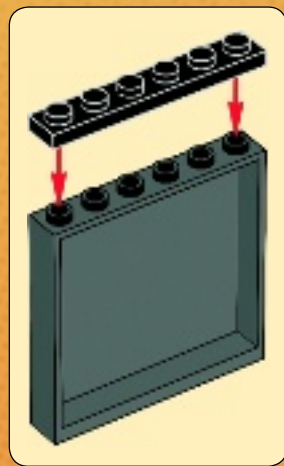

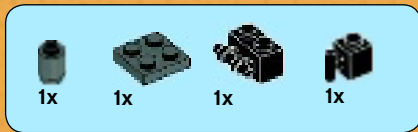

5

1



2



3

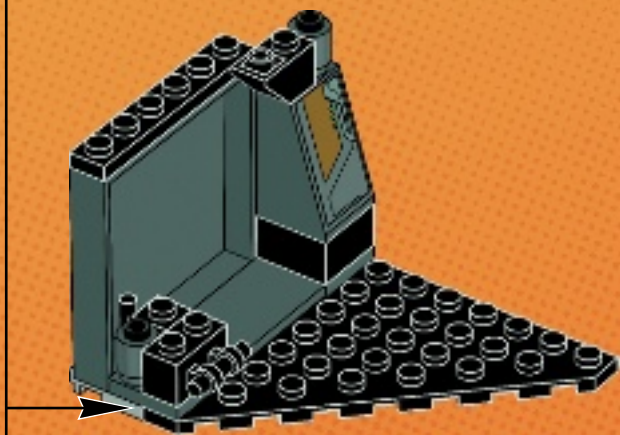

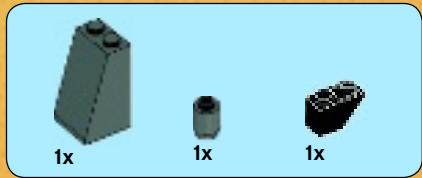

6

1



2

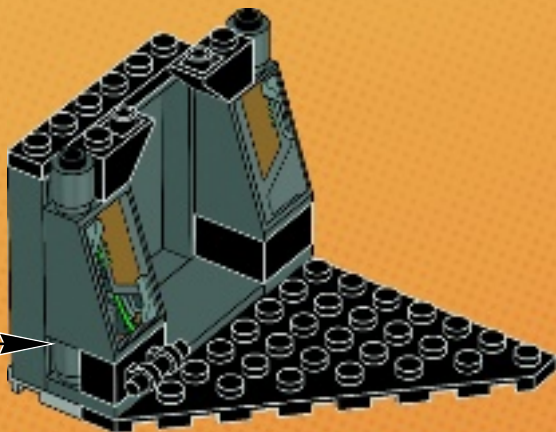

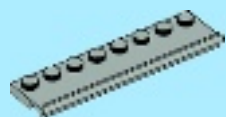

1x

7

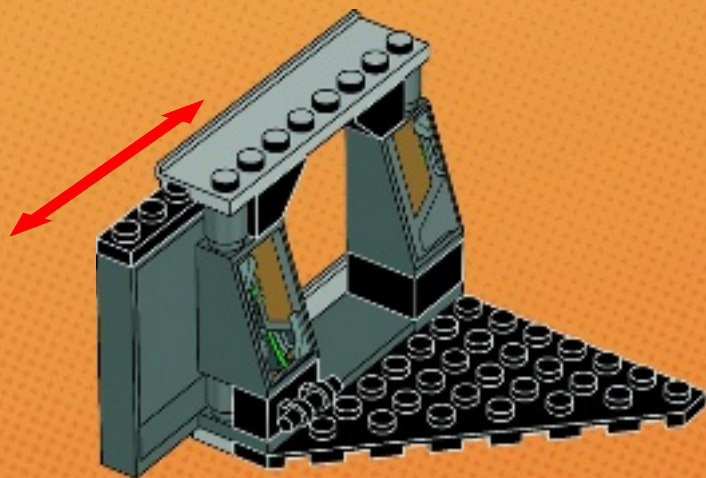



1x



1x

8

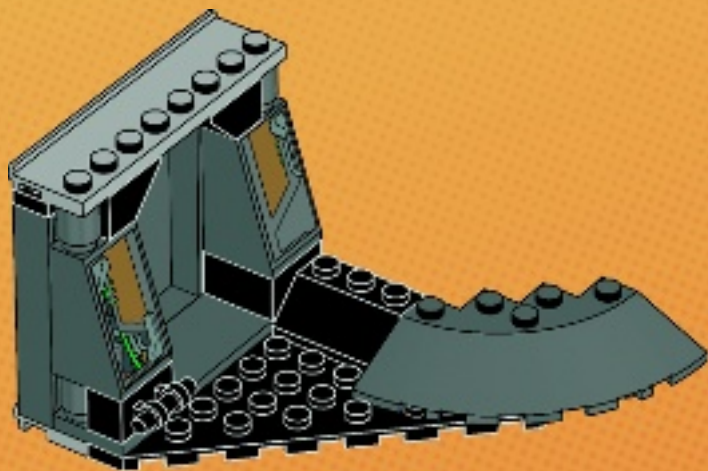



9

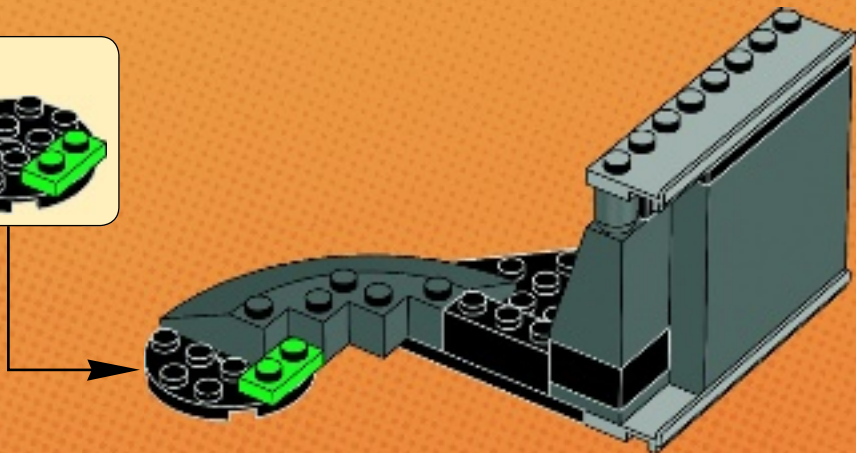



10

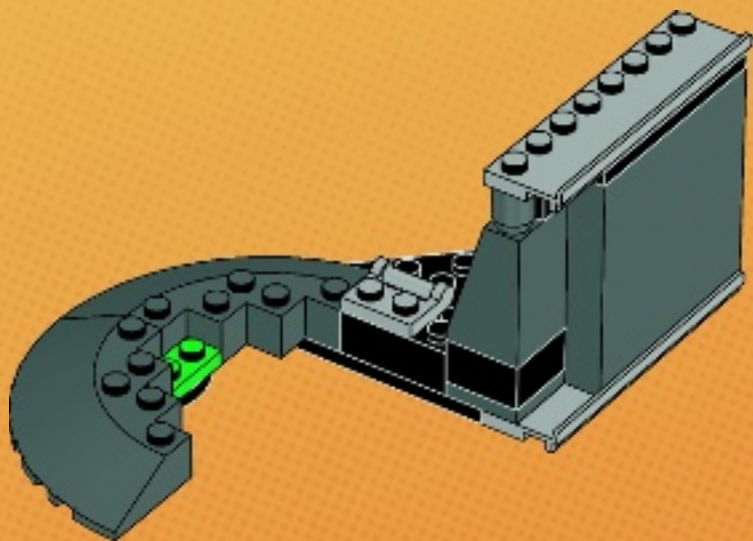



1x

11

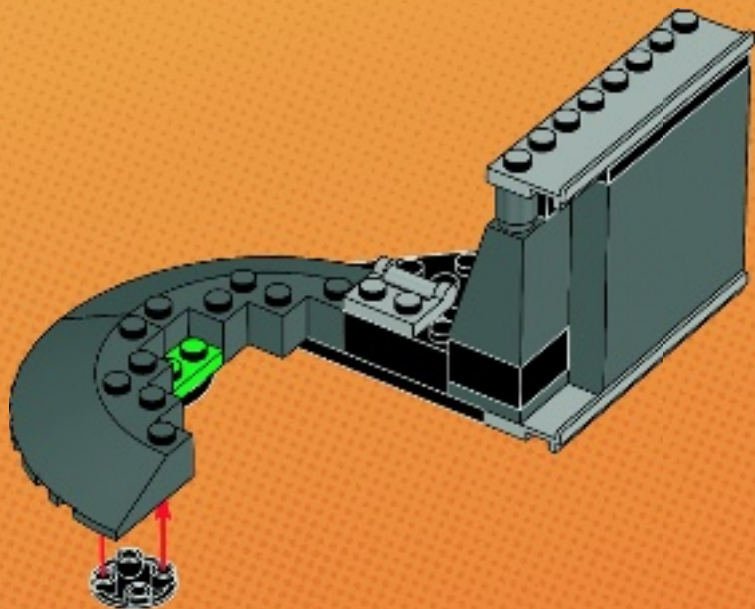

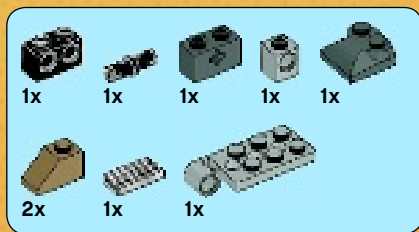

12

1

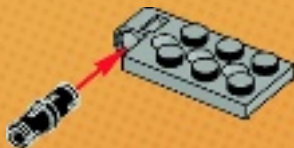

2

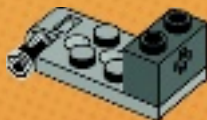

3

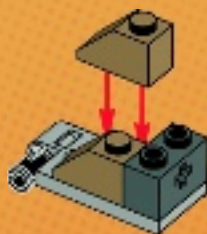

4



5

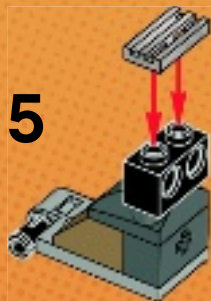

6

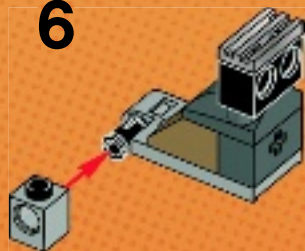

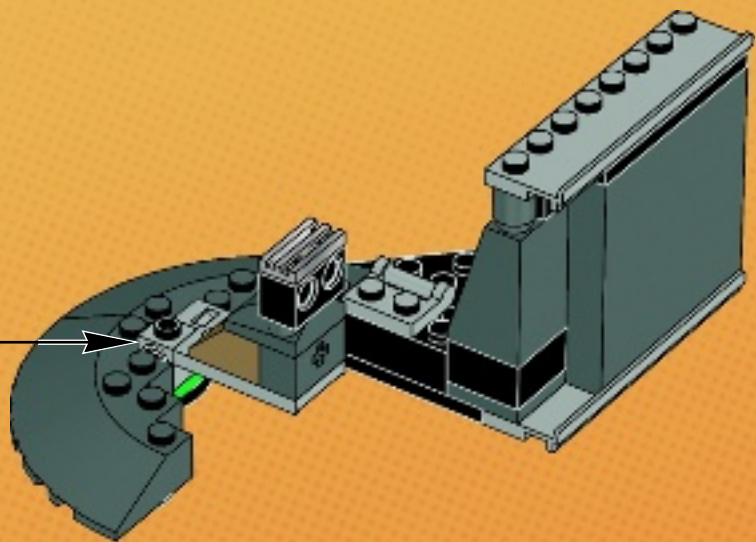



13

1

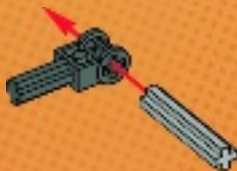

2



3



4



5

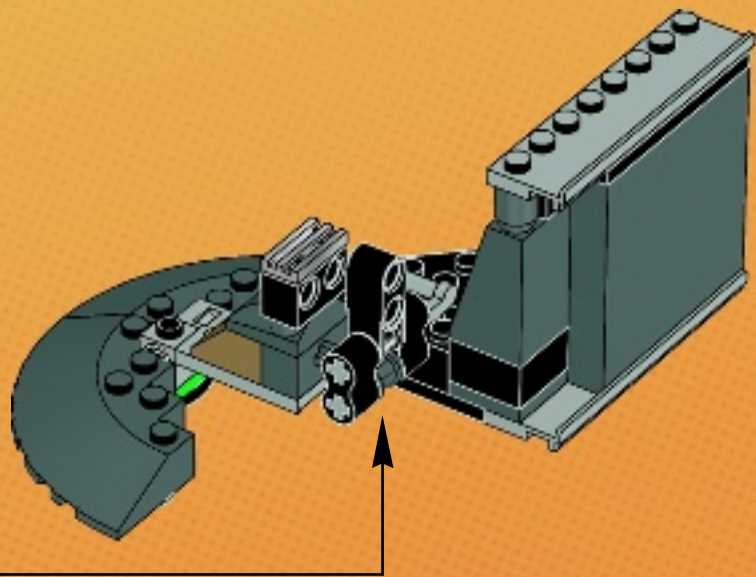
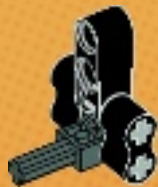



2x

14

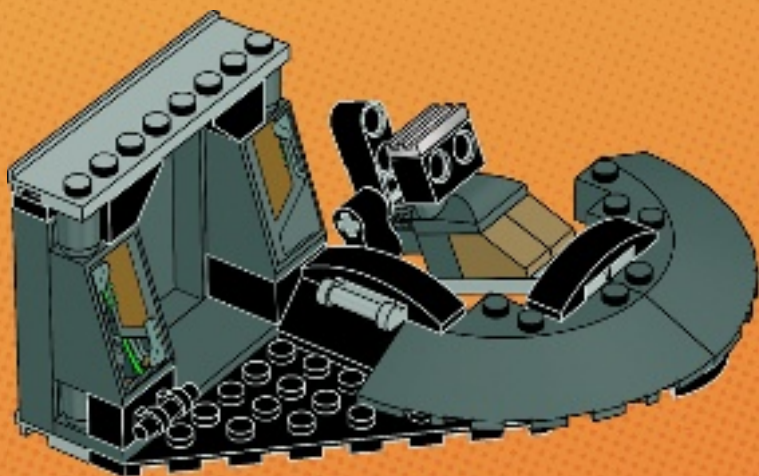
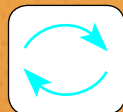



1x

15

1



2

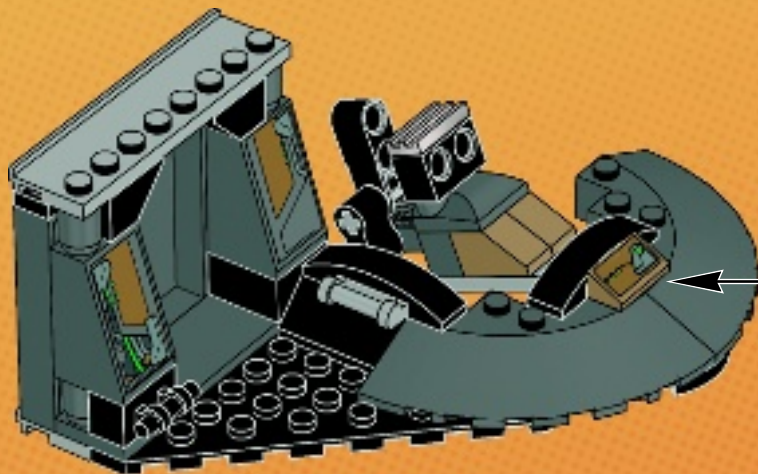



2x



2x

16

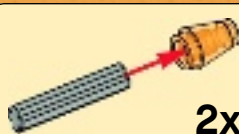

2x

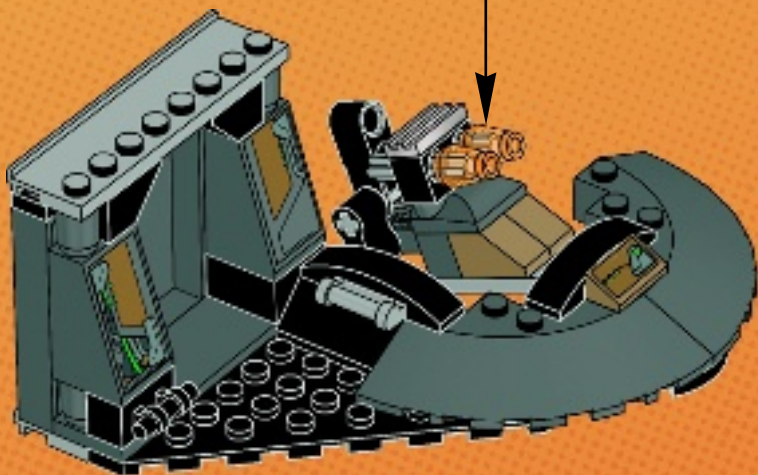



1x

17

1



2

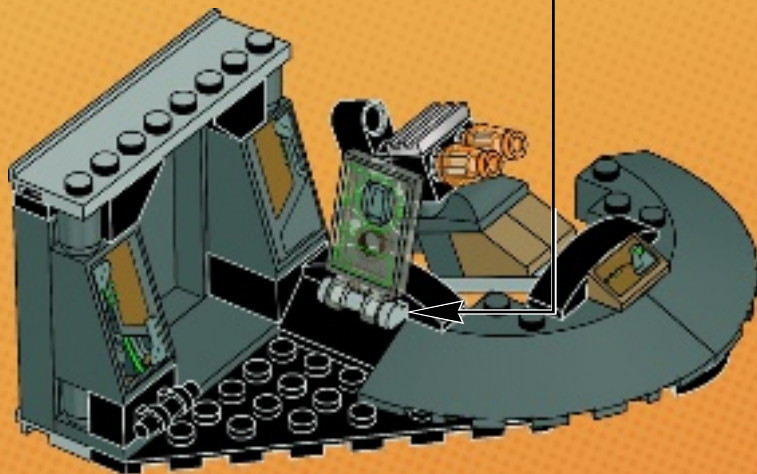



1

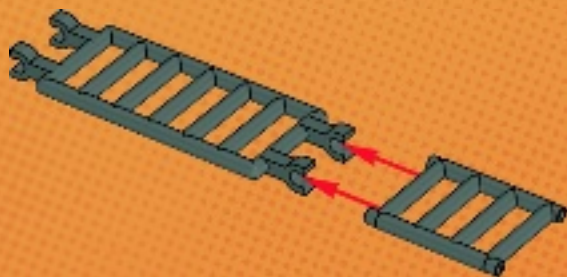

2

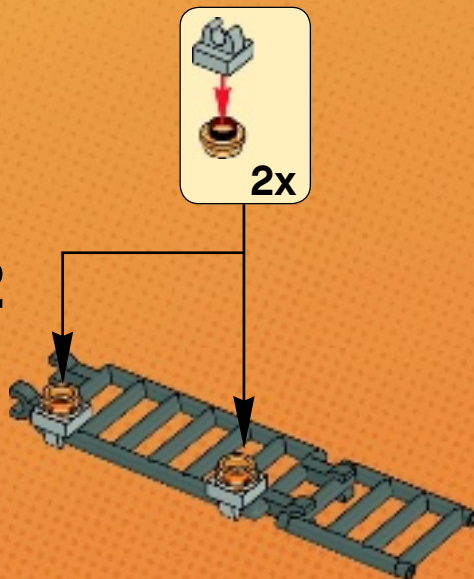

18

3

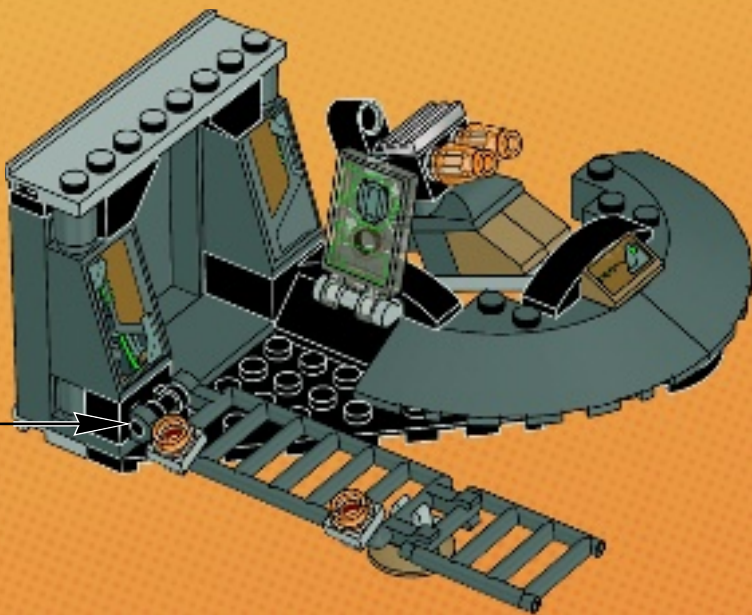
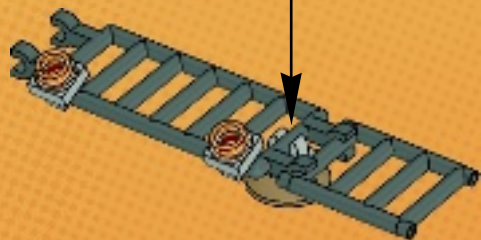
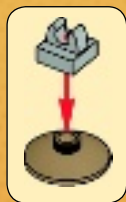

19

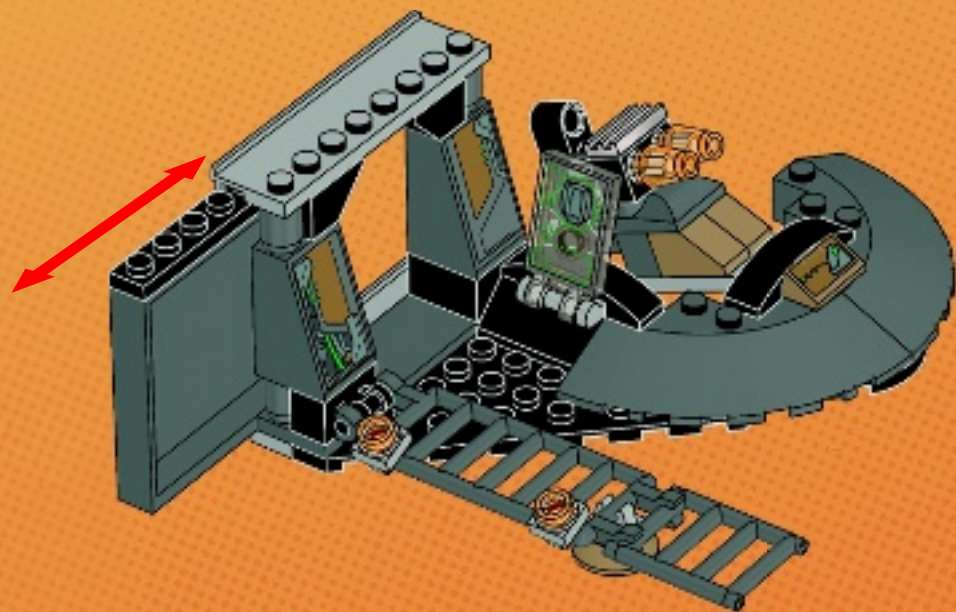

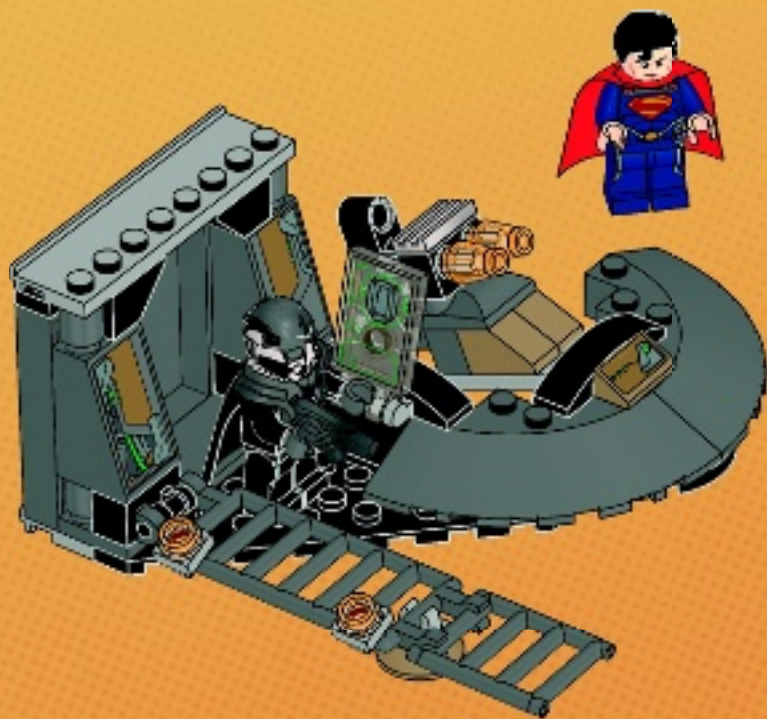

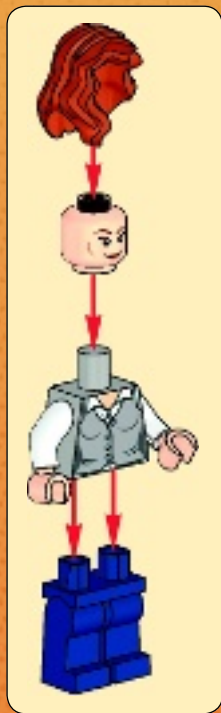



2x

1



2x

2





2x

3



2x

4





1x



2x

5

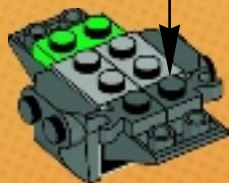

1x

6





1x

7



2x

8





1x



1x

1

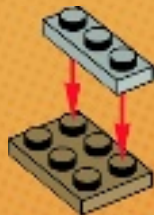

1x

2





1x

3



1x

4





2x



1x

5

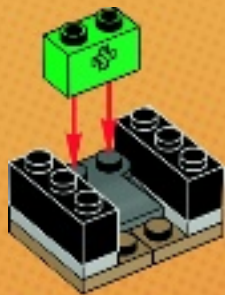

1x



1x

6

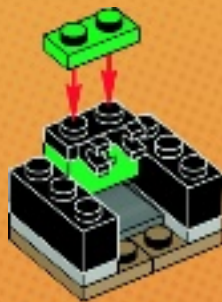



2x

7

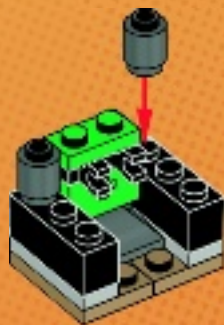

1x



1x



1x

8



1

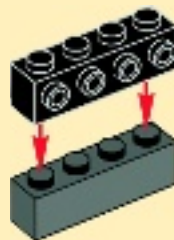

2

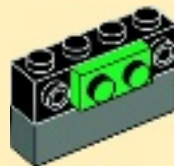



2x

9

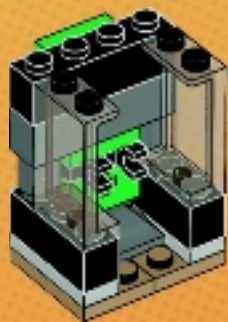

1x

10





2x

11



2x



1x

12

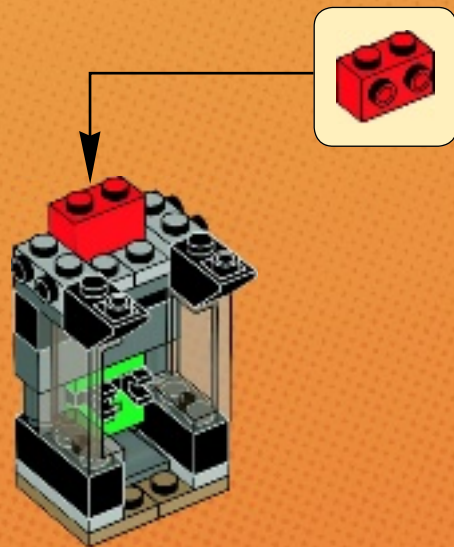



1x

13



2x



1x

14





1x

15

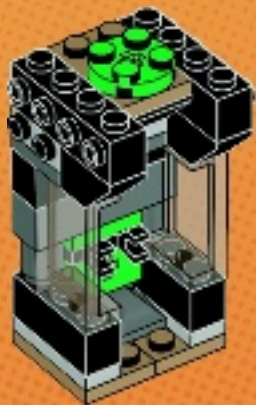

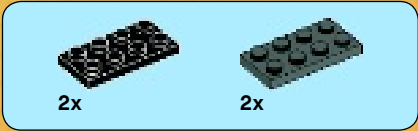

16

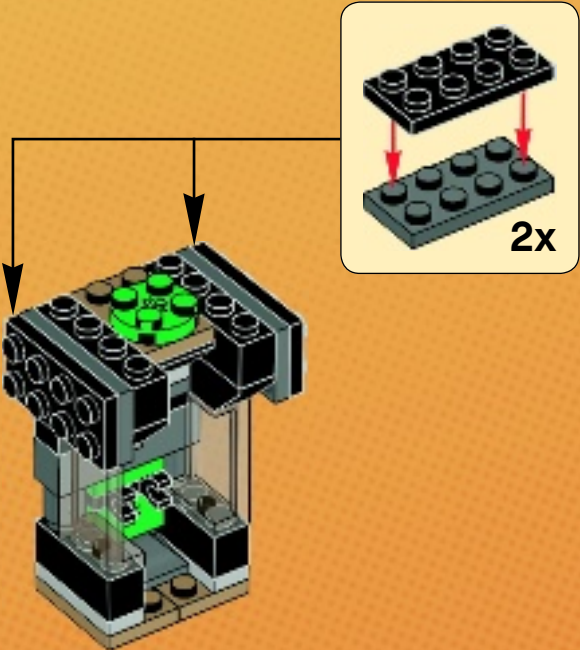

17

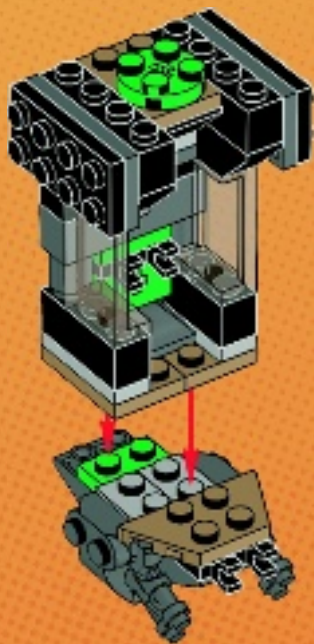



1x

18

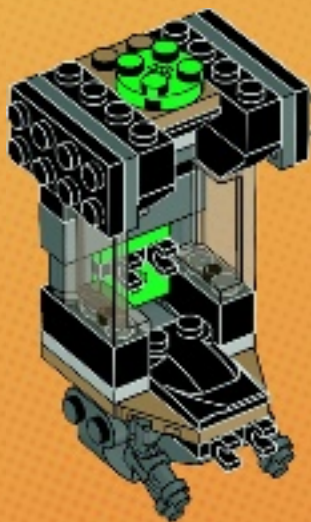



2x



1x

19

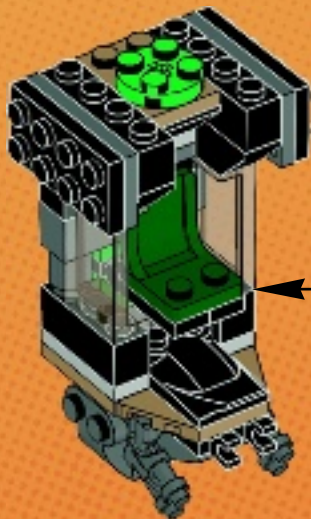

1

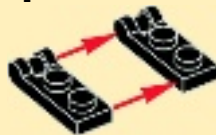

2



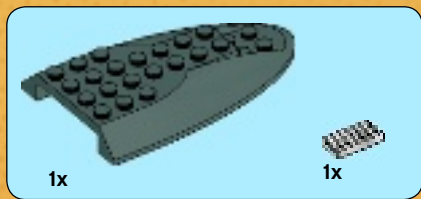

1

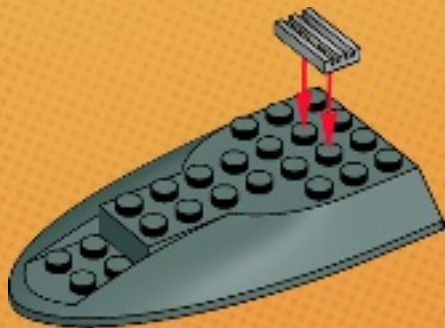

2

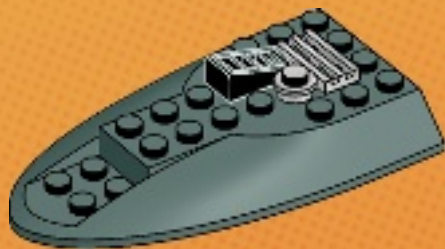



1x



1x

3

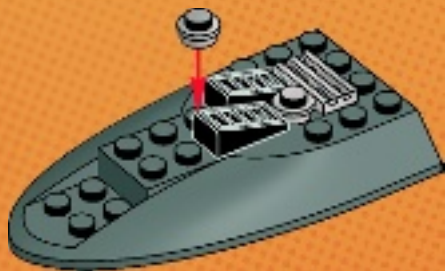

1x



1x

4

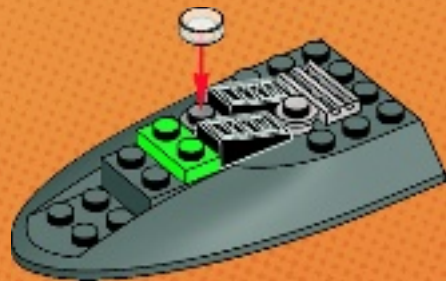



1x

5



6

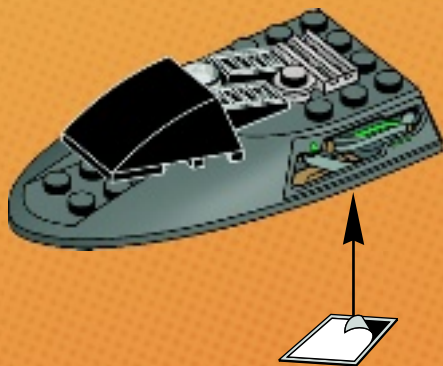

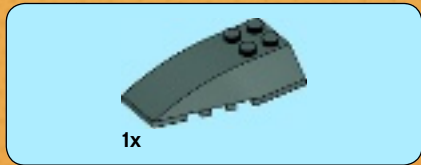

7

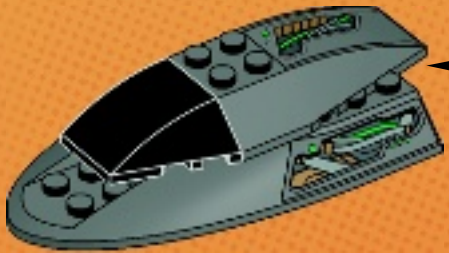

20



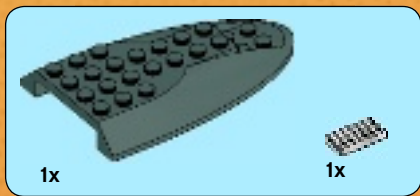

1

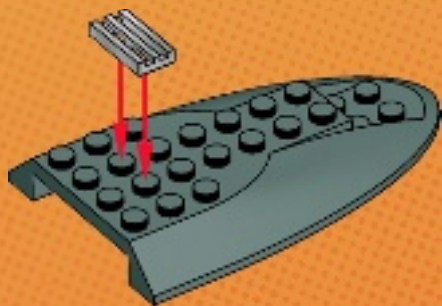

2





1x



1x

3

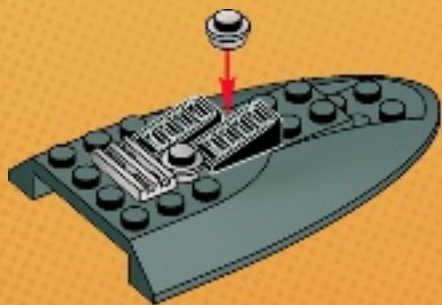

1x



1x

4

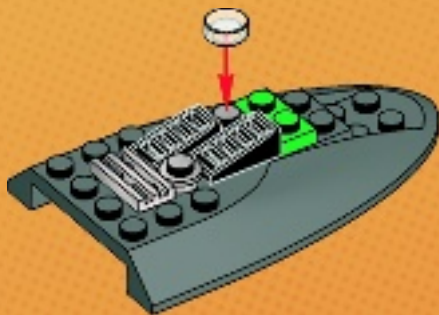



1x

5



6

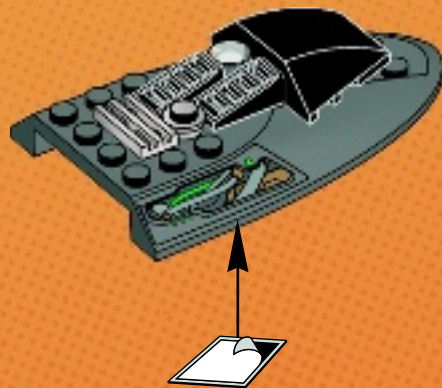

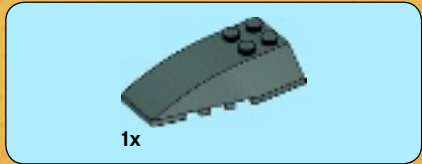

7

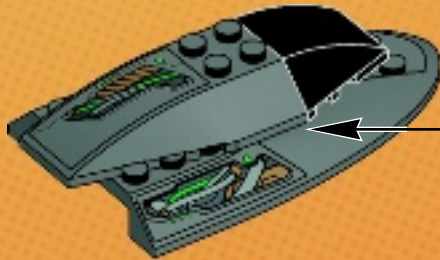
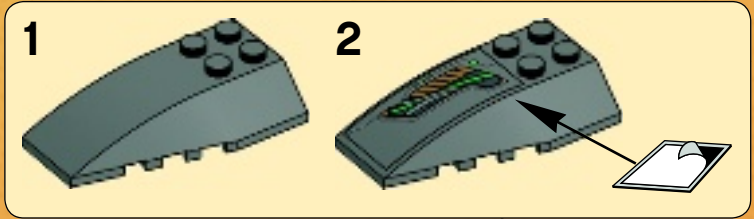

21





2x

22





1x

23





1x

24

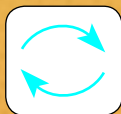



1x



1x

1



1x



1x



1x

2

1



2



25

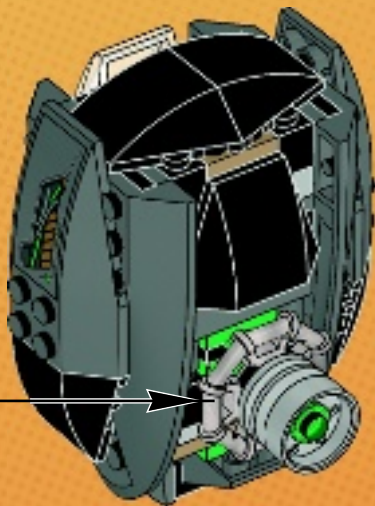

26

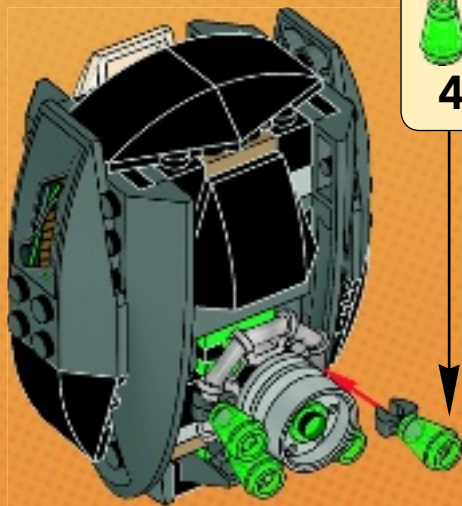



2x



2x



2x

27

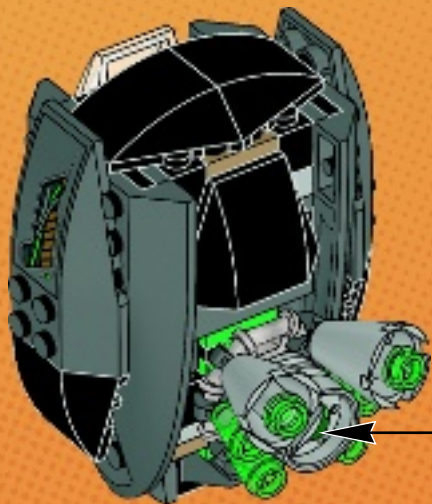

1



2

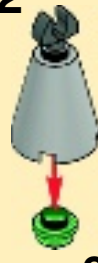

2x

28

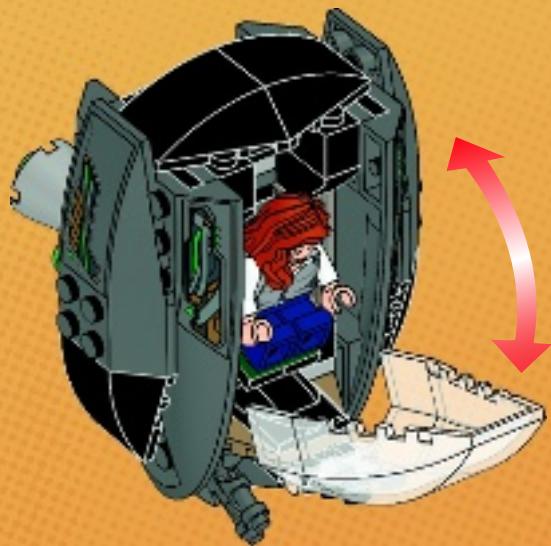

29

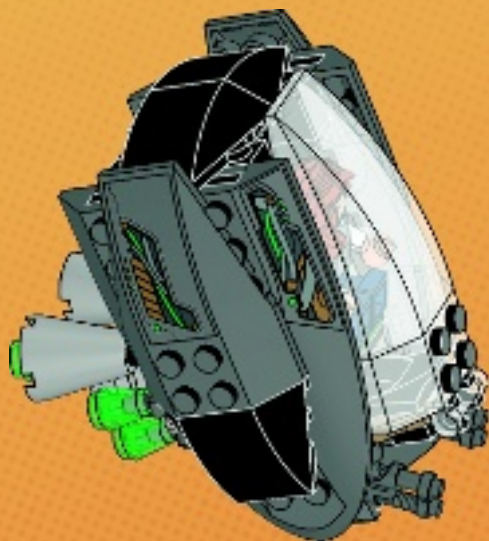

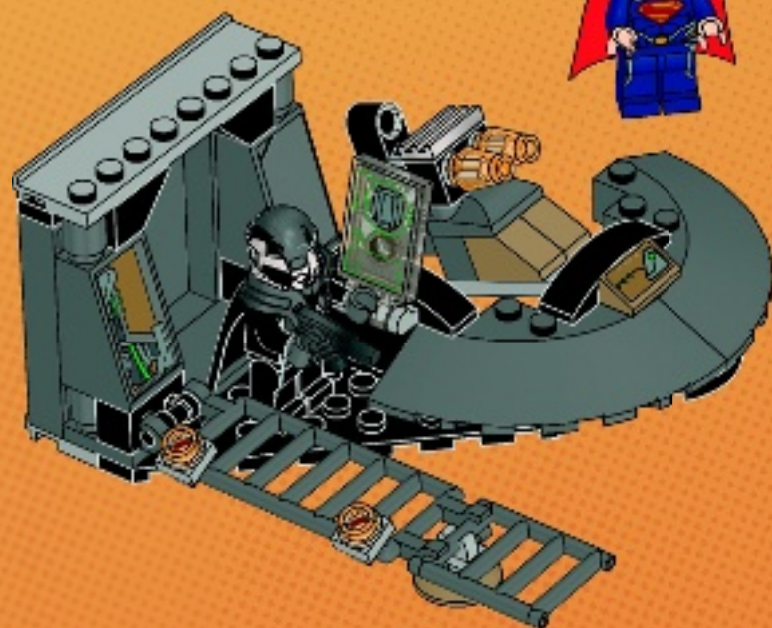



1x
6019155



1x
4143210



1x
300326



2x
362226



1x
4288212



3x
4162443



1x
3200026



4x
366526

64



1x
366026



1x
303826



1x
292126



2x
4613153



5x
6009018



2x
302026



1x
366626



2x
6020193



2x
4515368



2x
4556158



1x
4515350



1x
6041729



1x
6039687



1x
4654944



1x
4651571



1x
4124171



1x
4205347



1x
4278359



4x
4541191



1x
4285883



1x
4173970



1x
4121715



2x
4198367



1x
4233489



6x
302328



2x
403228



1x
6004435



4x
4567333



3x
3005748



1x
6030356



2x
6010736



2x
4530678



1x
6015449



3x
6035540



2x
4650498



1x
4597715



1x
6003379



1x
6021969



1x
6031821



1x
6041728



1x
4162916



1x
6039684



1x
4538760



2x
4567338



2x
4222960



2x
6022155



1x
4211535



2x
4211429



3x
6030711



2x
4654582



1x
4244627



2x
4654577



1x
6041719



2x
4222019



1x
4490127



1x
4646513



4x
4211815



1x
4211103



1x
4210935



5x
4211090



2x
4622338



2x
4180486



2x
4211064



4x
4218696



2x
4211094



3x
4211065



2x
4587212



1x
4560184



1x
4521886



2x
6005670



1x
4505068



1x
4667977



2x
6000853



2x
4623236



6x
4289542



1x
4210665



3x
4619636



1x
6020990



4x
4633691



1x
6038189



1x
6037246



1x
6038228



1x
6037913



1x
6037902



1x
6037903



Customer Service

Kundenservice

Service Consommateurs

Servicio Al Consumidor

LEGO.com/service or dial



: 00800 5346 5555

: 1-800-422-5346



DC SUPER HEROES BATMAN



7+ 15-25



LEGO and the LEGO logo are trademarks of the LEGO Group.
son marques registradas de LEGO Group.
©2013 The LEGO Group. TM & DC Comics. WB SHIELD. TM & © Warner Bros.
Entertainment Inc. (s18)

Available on the
App Store



LEGO.com/SuperHeroes



DC UNIVERSE™
**SUPER
HEROES**

MOVIE MAKER **CRÉATEUR DE FILM**

SHOOT, EDIT & SHARE YOUR STOP MOTION MOVIE
TOURNE, MONTE ET PARTAGE TON FILM D'ANIMATION

LEGO and the LEGO logo are trademarks of the LEGO Group. TM & © DC Comics. (s13)



WIN!

Go to www.LEGOsurvey.com/product to fill out a survey for a chance to win a cool LEGO® Product.

No purchase necessary.

Open to all residents where not prohibited.



www.LEGOsurvey.com/product

GEWINNE!

Nimm an der Umfrage auf www.LEGOsurvey.com/product teil und hab die Chance ein cooles LEGO® Produkt zu gewinnen!

Die Teilnahme am Gewinnspiel führt zu keinerlei Kaufverpflichtungen. Teilnahme in allen nicht ausgeschlossenen Ländern möglich.

WIN!

Ga naar www.LEGOsurvey.com/product, vul een enquêteformulier in en maak kans op een cool LEGO® product.

Geen aankoopverplichting. Iedereen mag deelnemen, uitgezonderd ingezetenden van landen waar een enquêteverbod geldt.

GAGNE!

Visite www.LEGOsurvey.com/product pour répondre à un questionnaire et avoir une chance de gagner un produit LEGO® très cool!

Aucune obligation d'achat. Ouvert à tous les résidents des pays autorisés.

当てよう!

www.LEGOsurvey.com/product にアクセスして、アンケートにご記入ください。当選者にはレゴ®製品を差し上げます。

お買い上げの必要はありません。

禁止されていない限り、すべての皆様にご利用いただけます。



LEGO.com



DC COMICS™ TM & © DC Comics.

6047355



WB SHIELD: TM & © Warner Bros. Entertainment Inc. (s13)

LEGO and the LEGO logo are trademarks of the/son des marques de commerce de/son marcas registradas de LEGO Group. ©2013 The LEGO Group.