

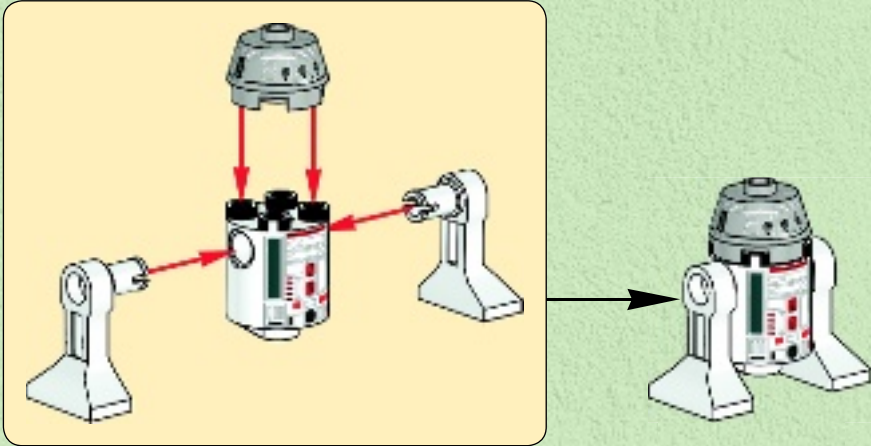

# STAR WARS

75018

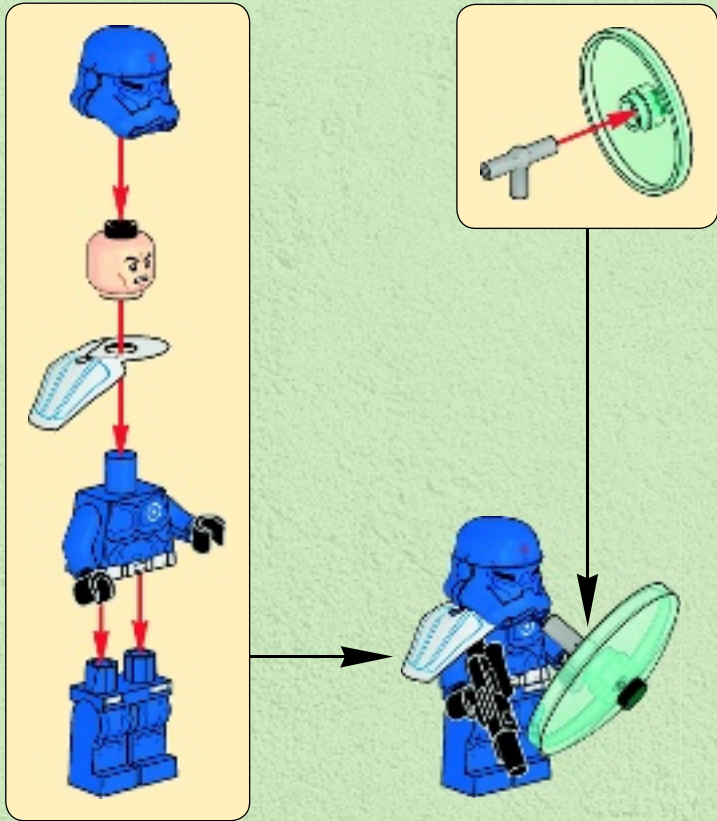

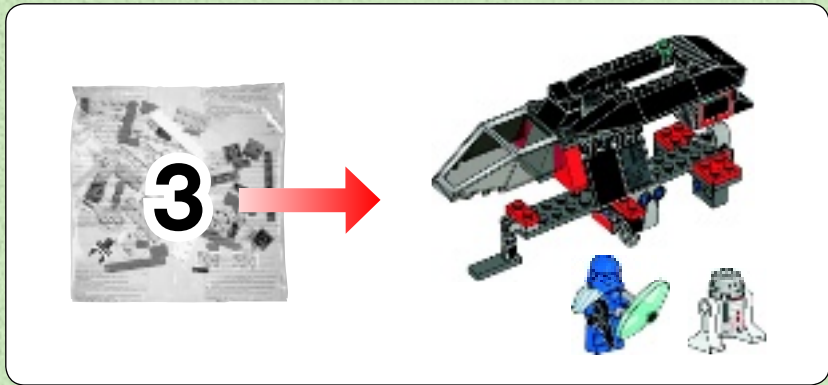



37

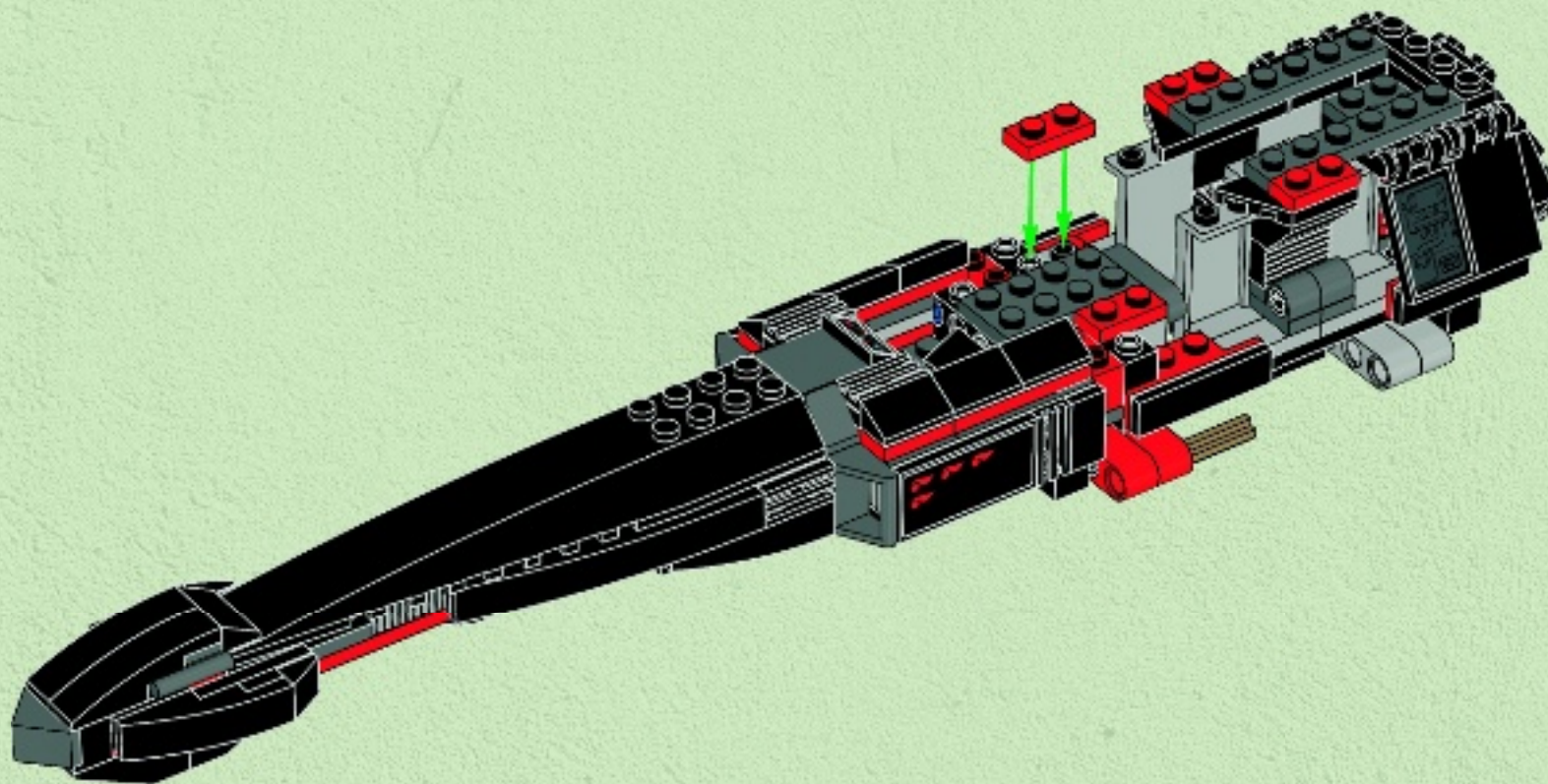

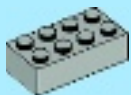

1x

38

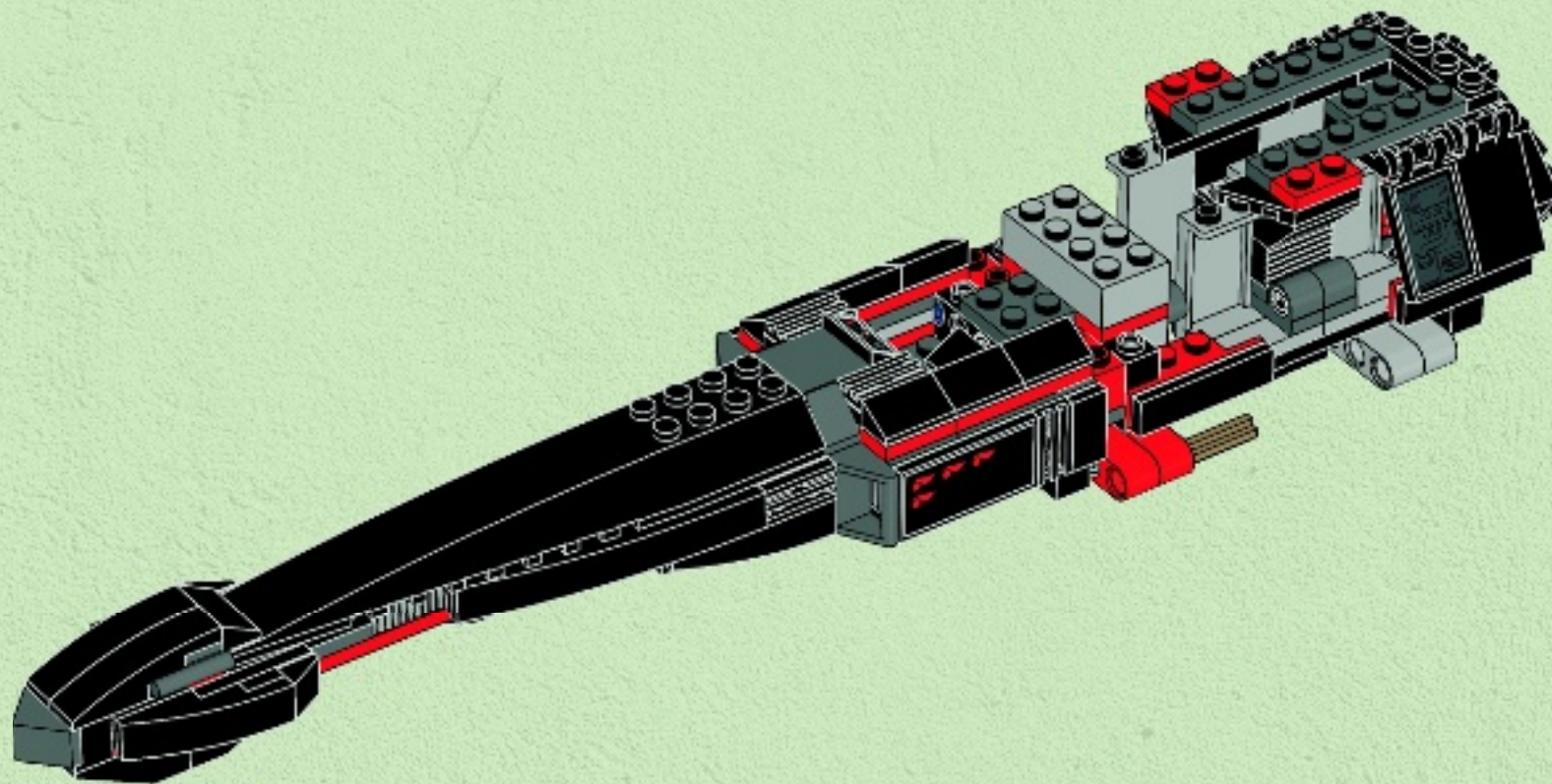

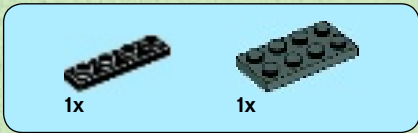

39

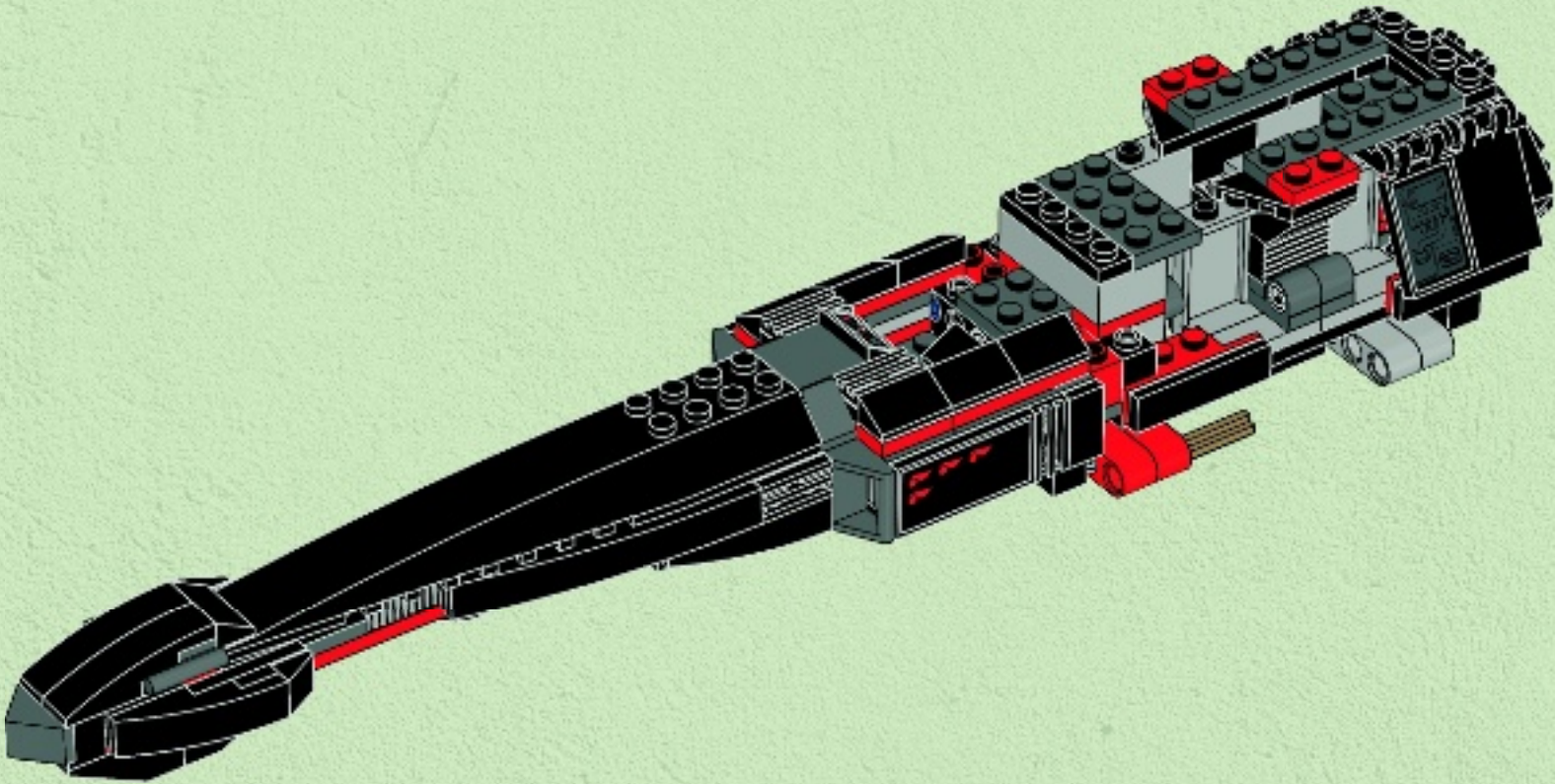

1x  4x 

40

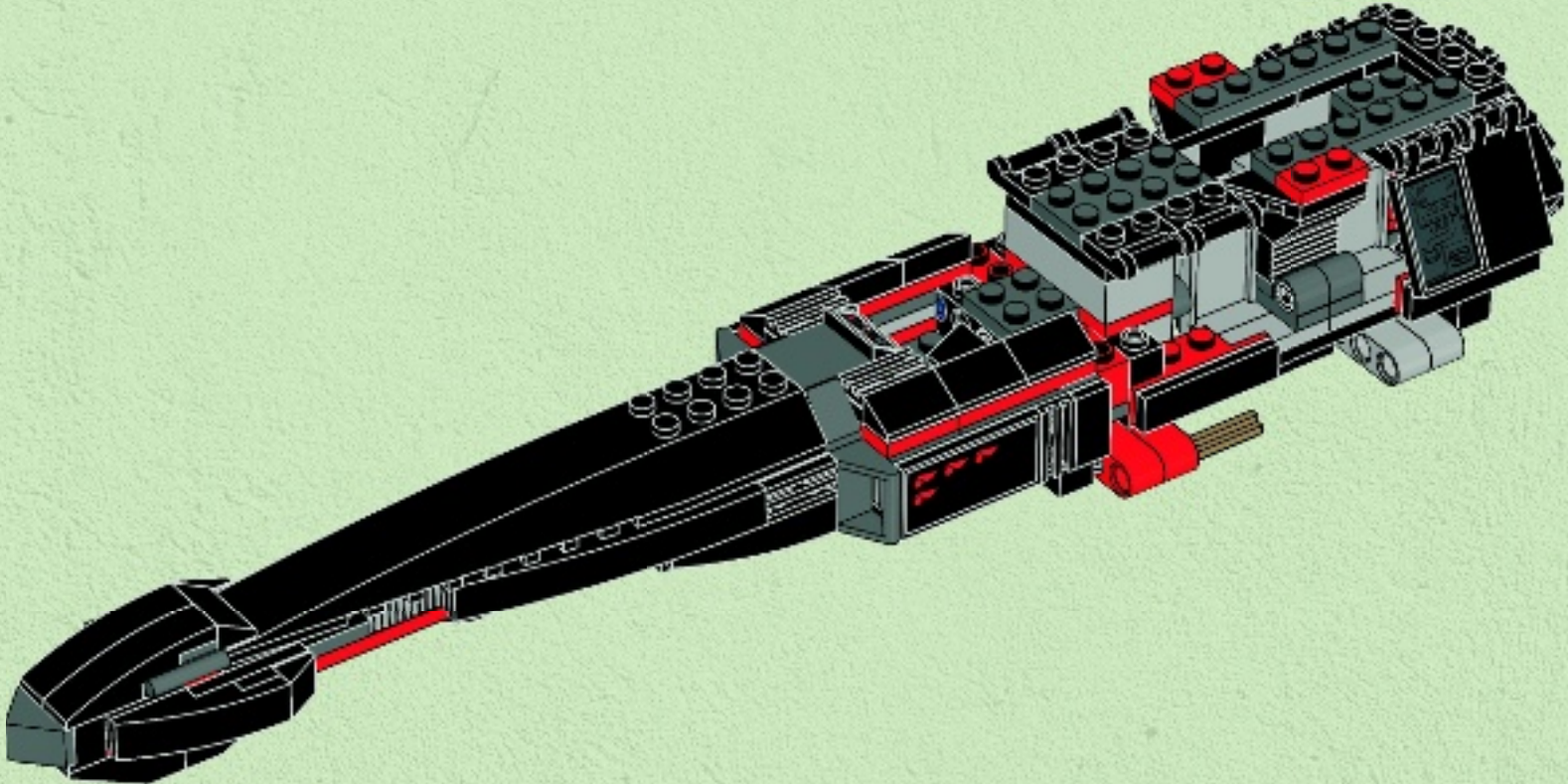

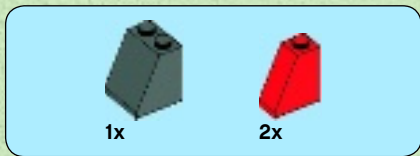

41

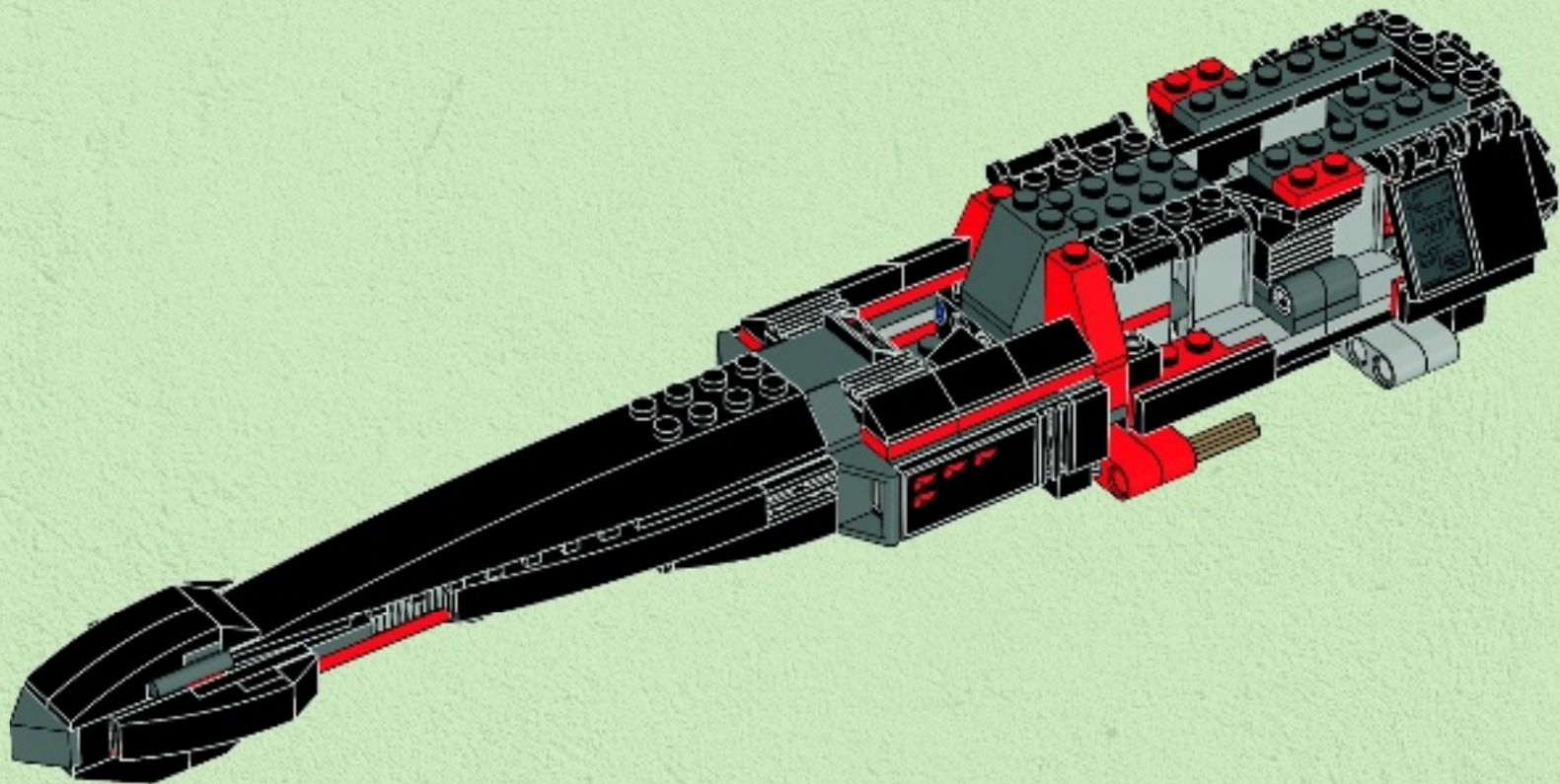



1x



2x

42

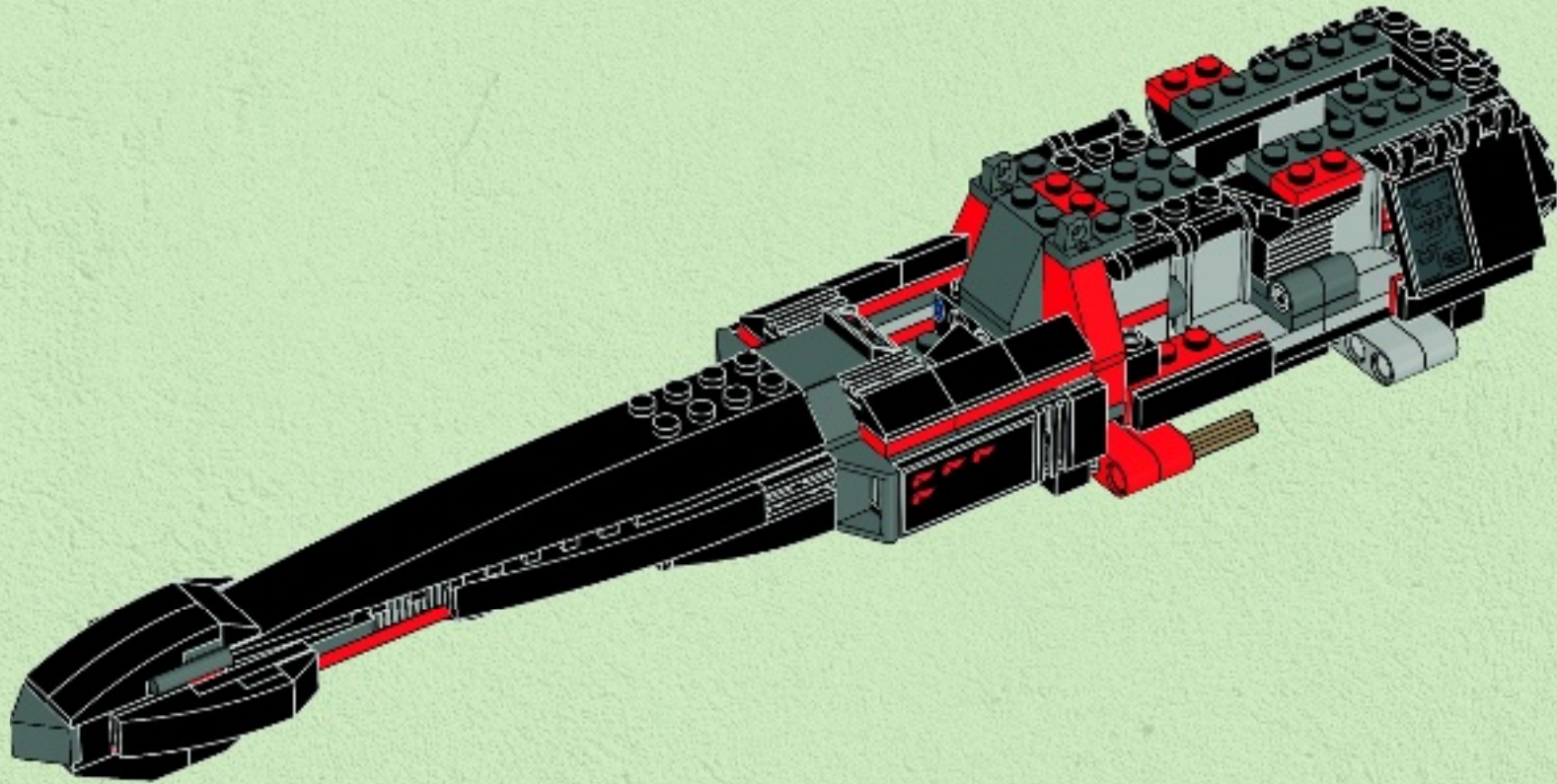





2x

# 43

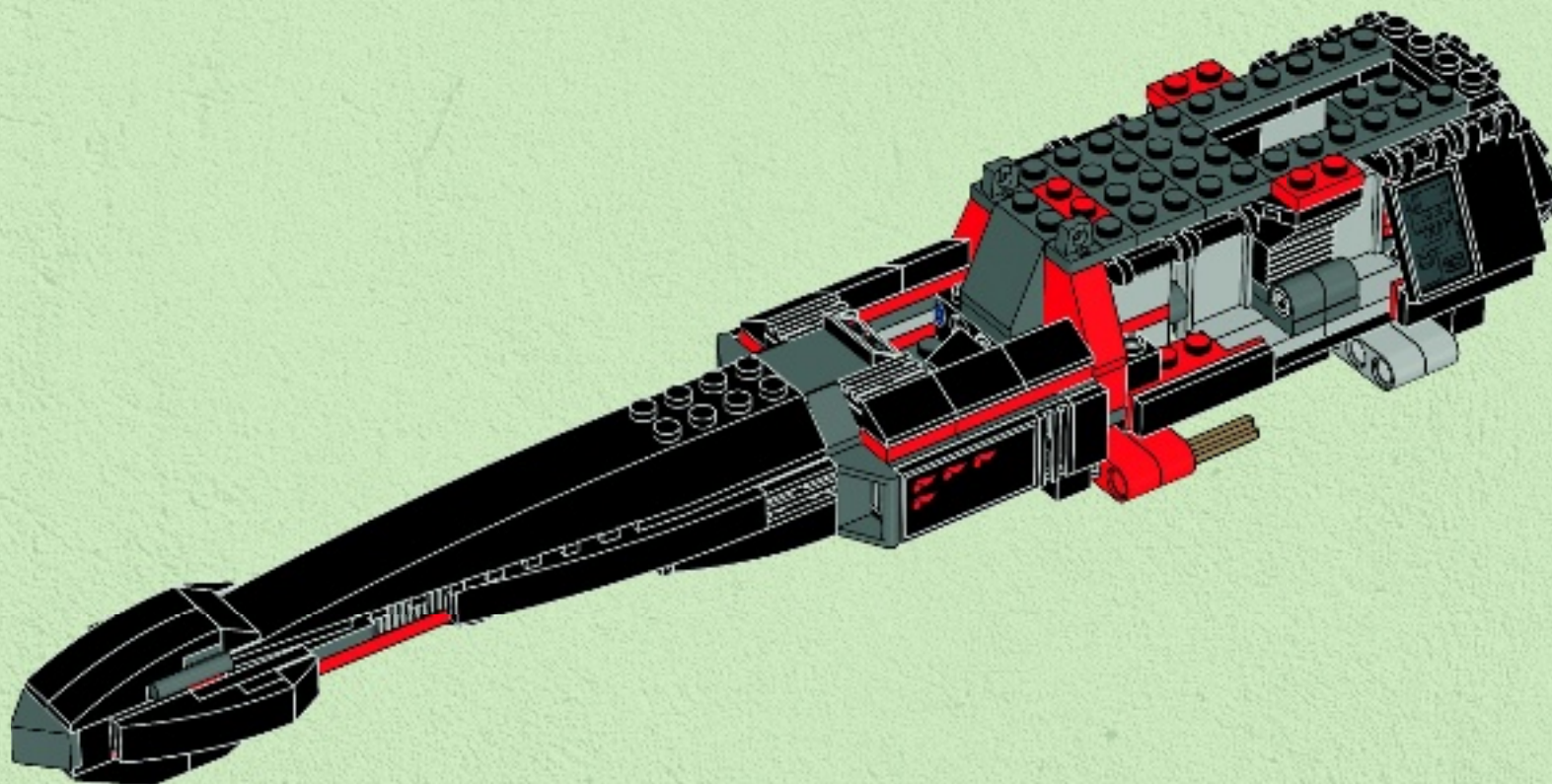



2x

44

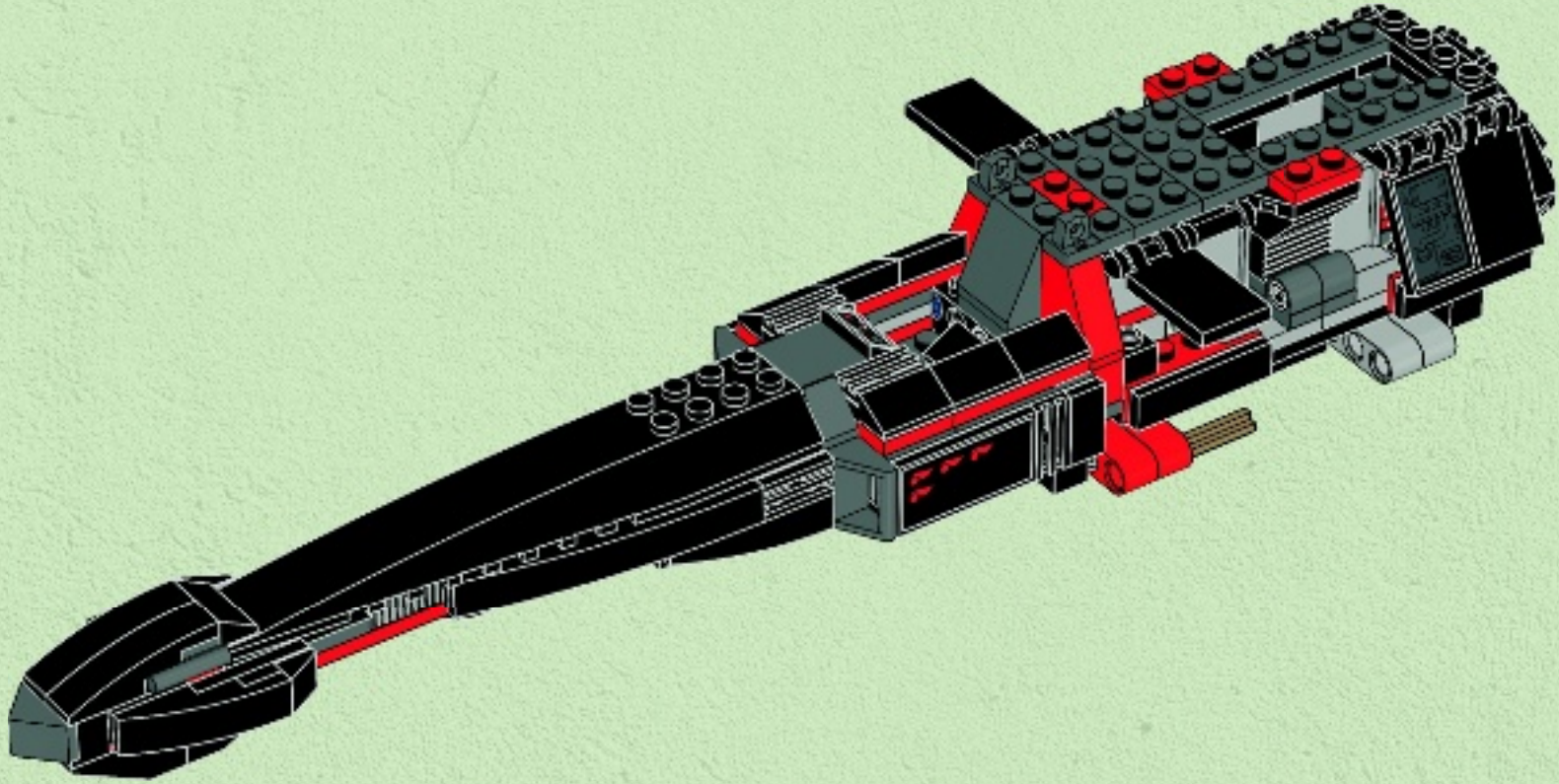



2x

# 45

1



2

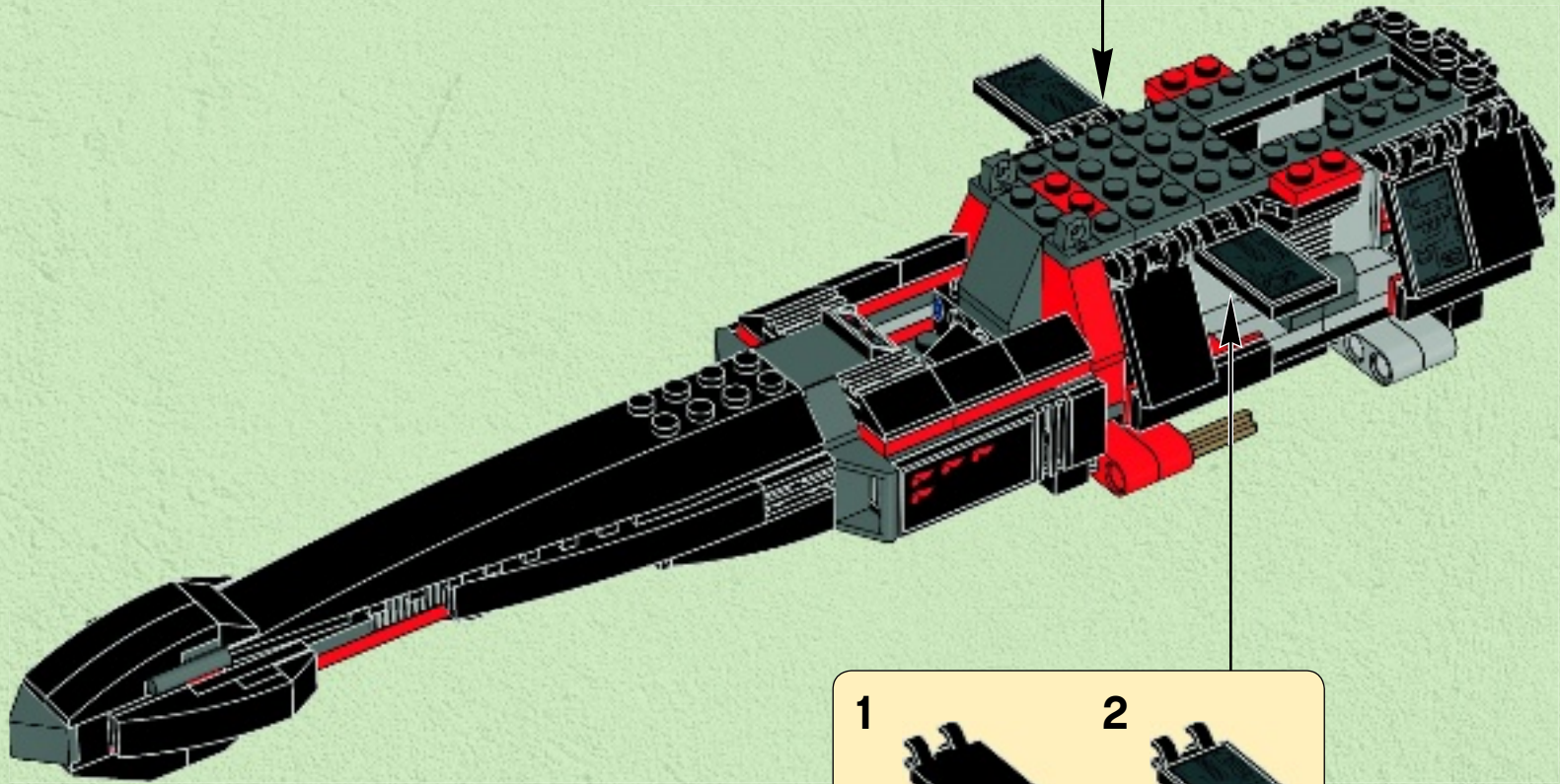

1



2





# 46

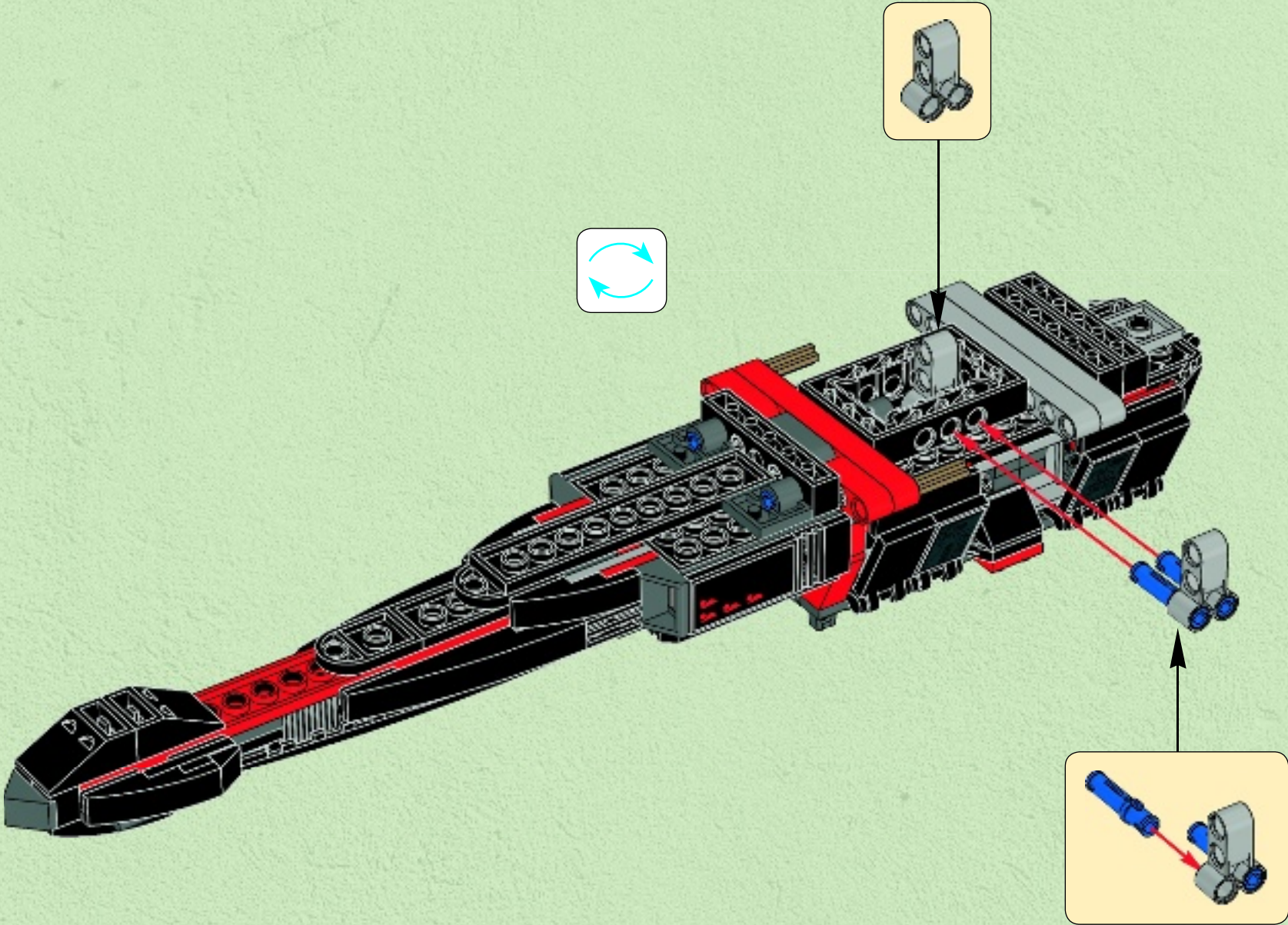

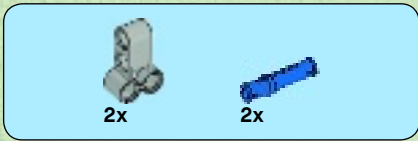

47

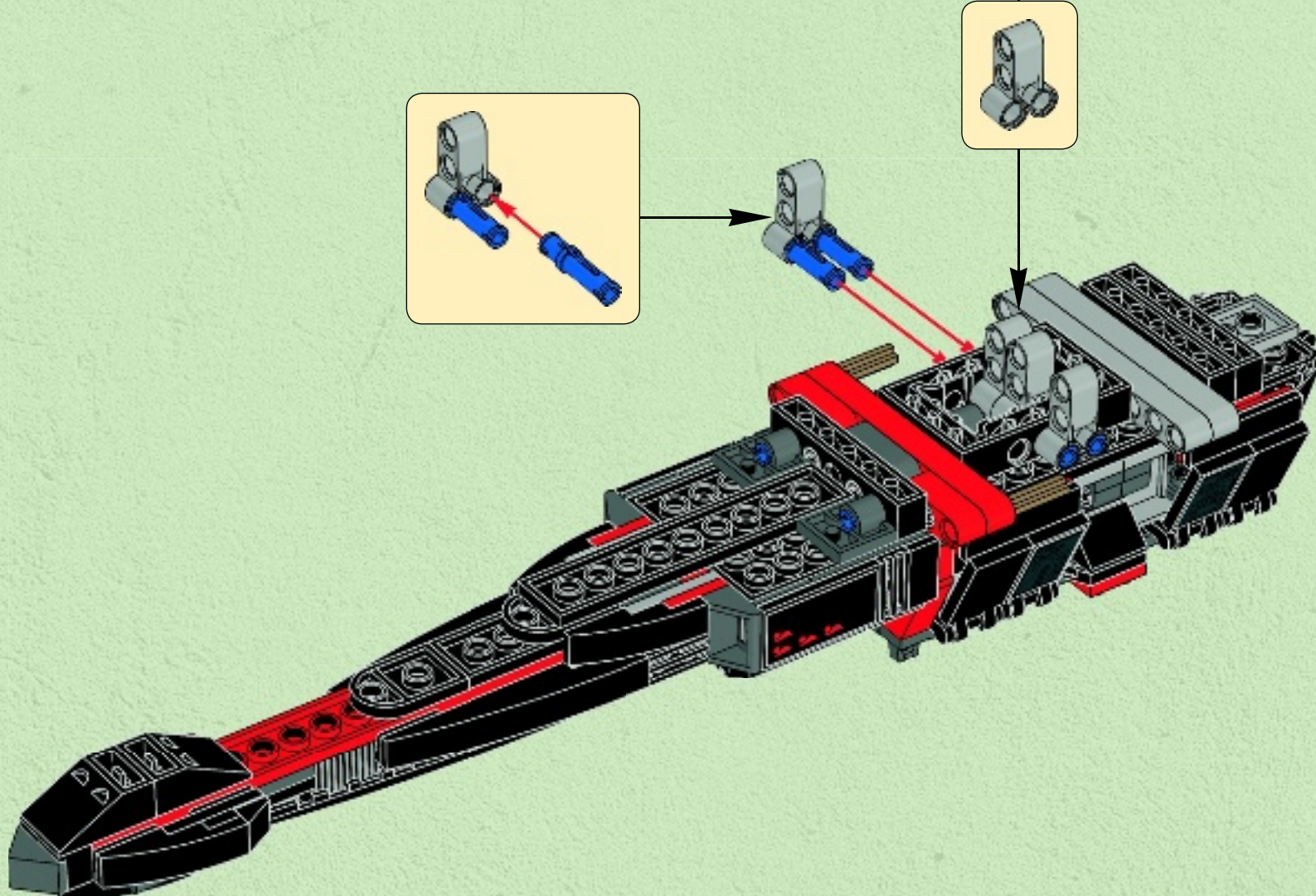

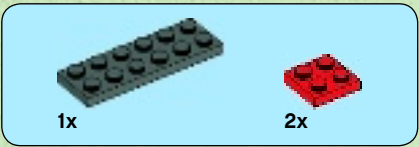

48

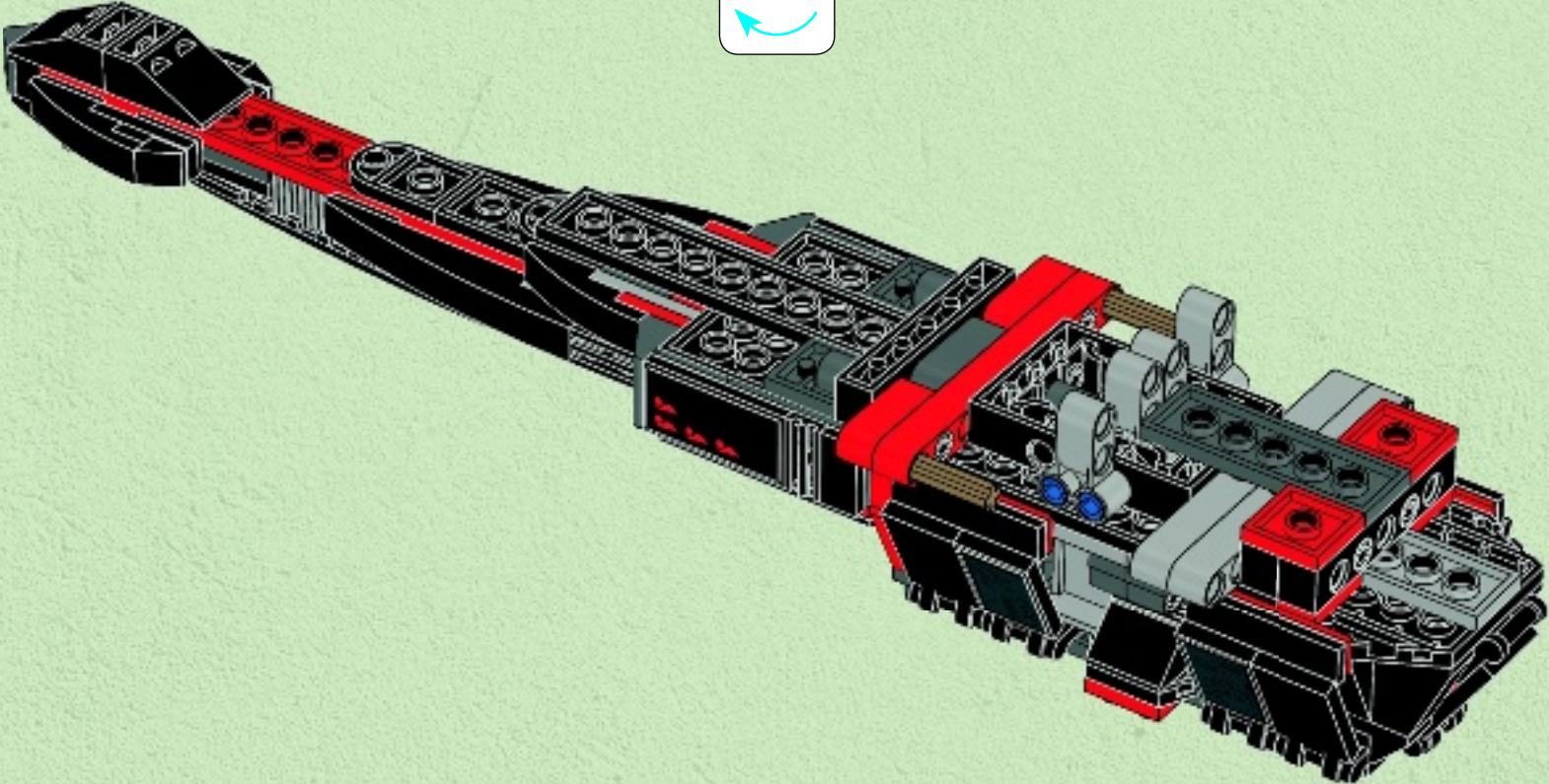

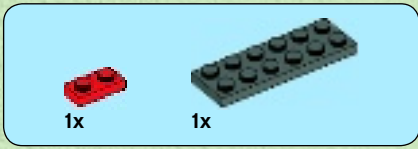

49

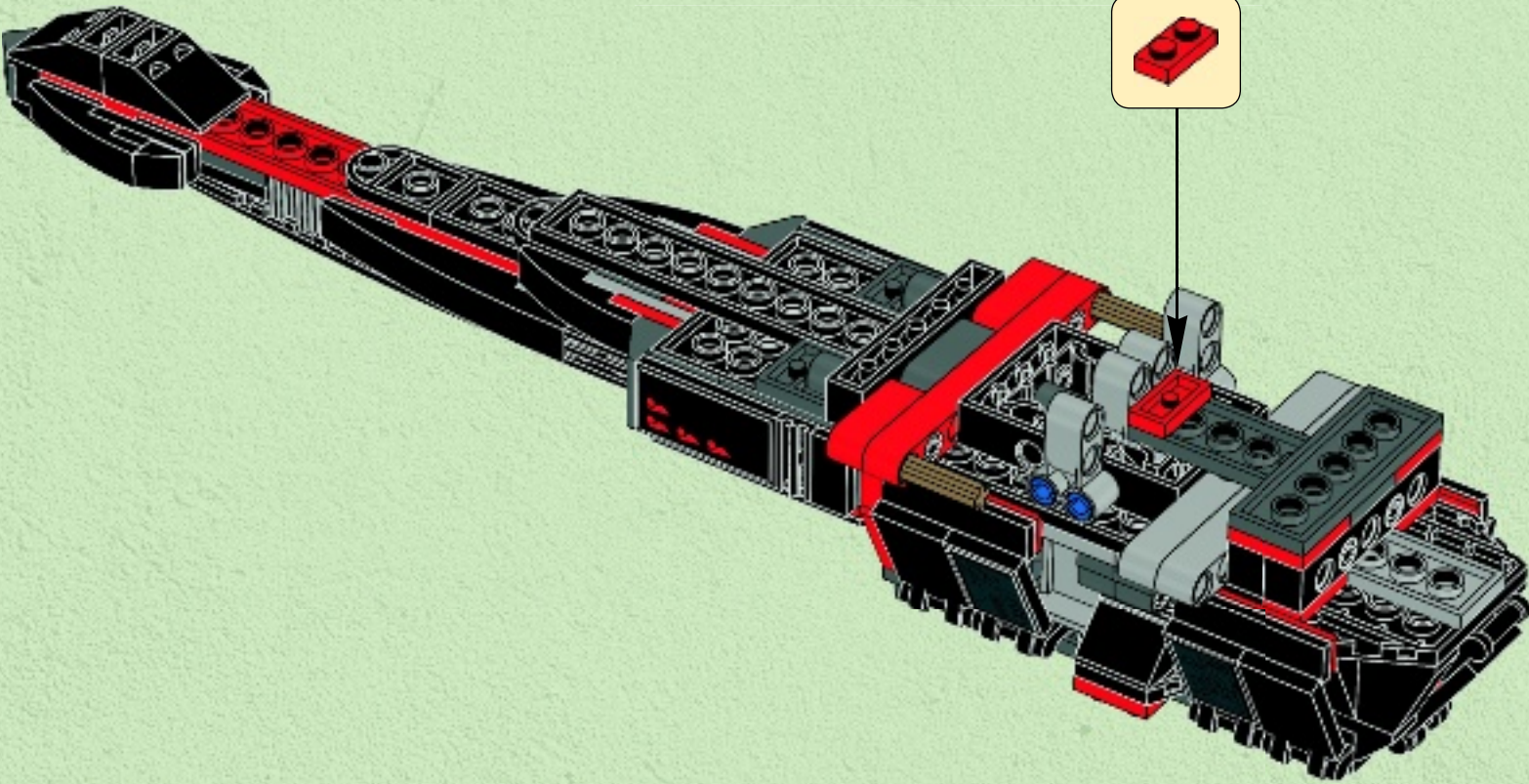



3x

50

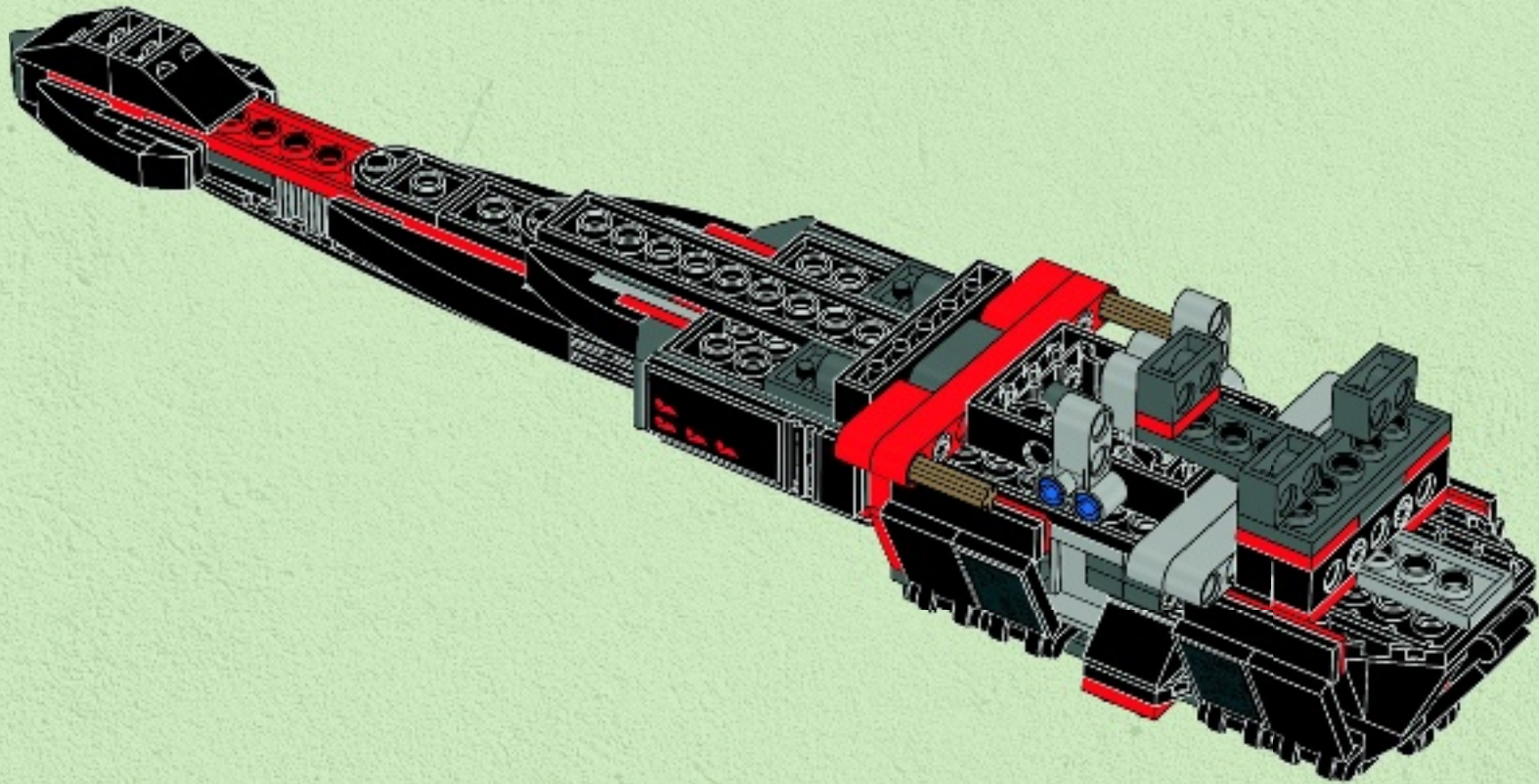





# 51

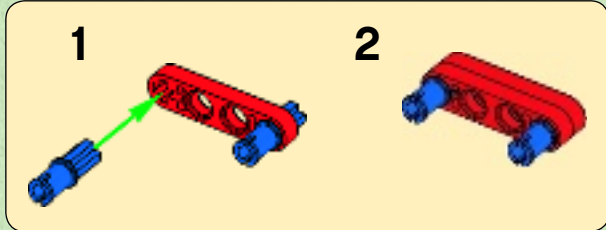
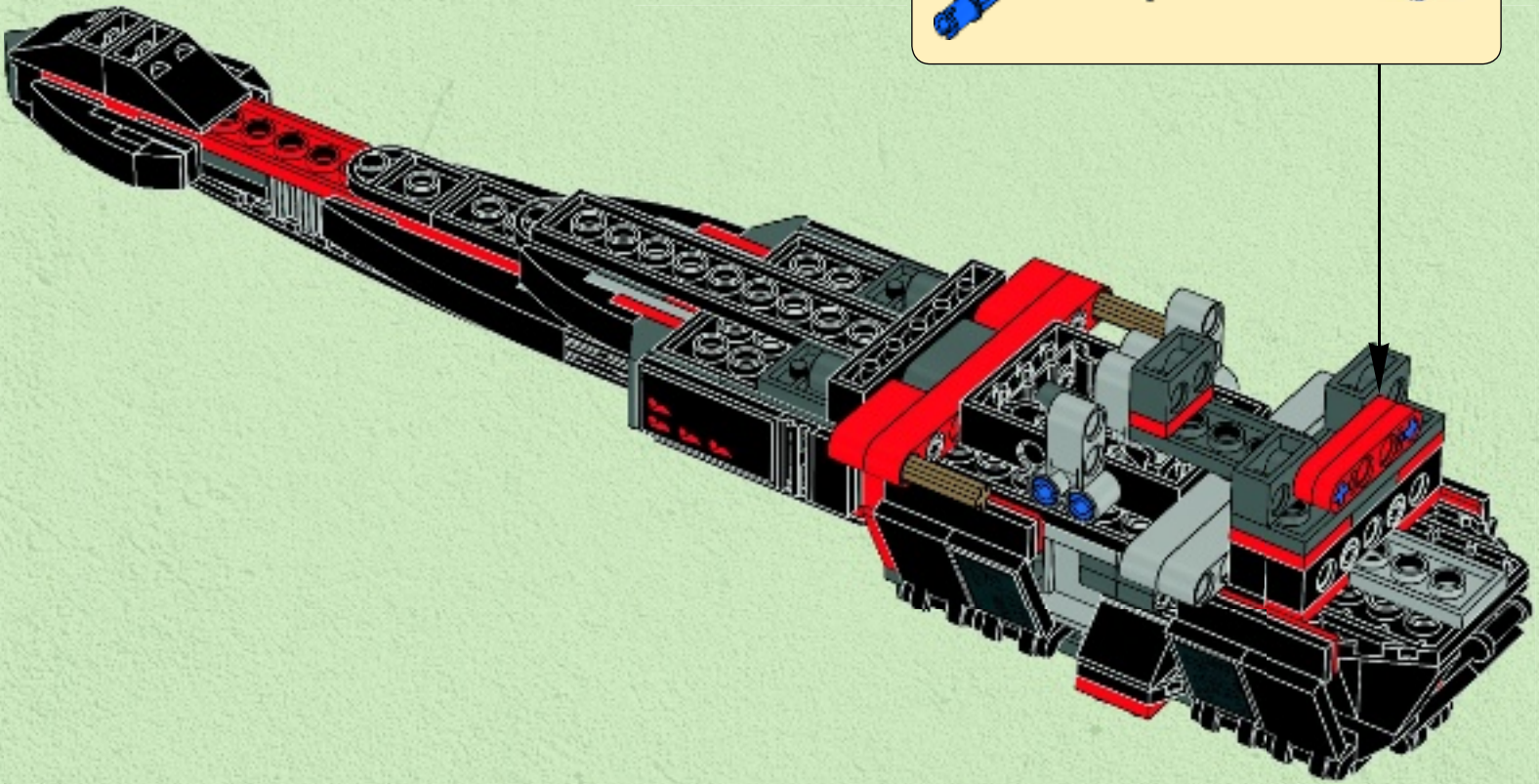



# 52

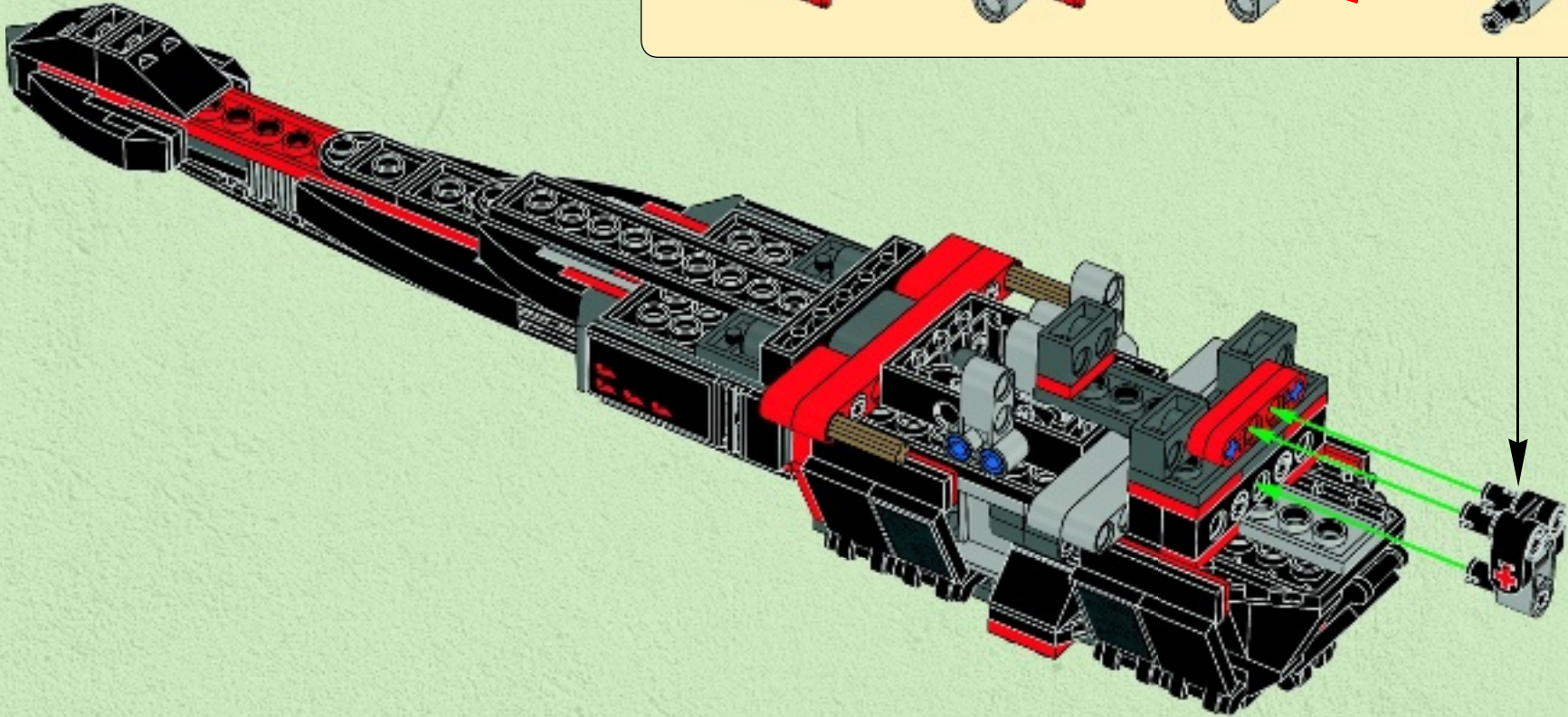
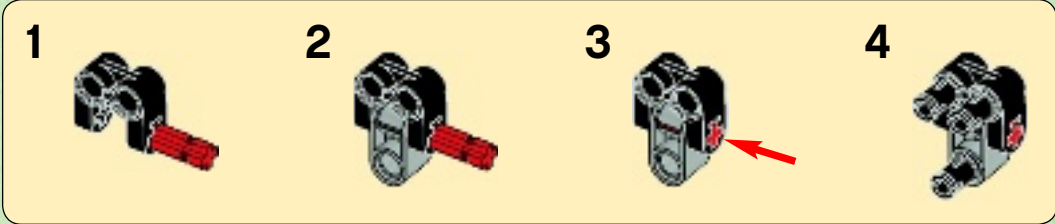



1x



1x

# 53

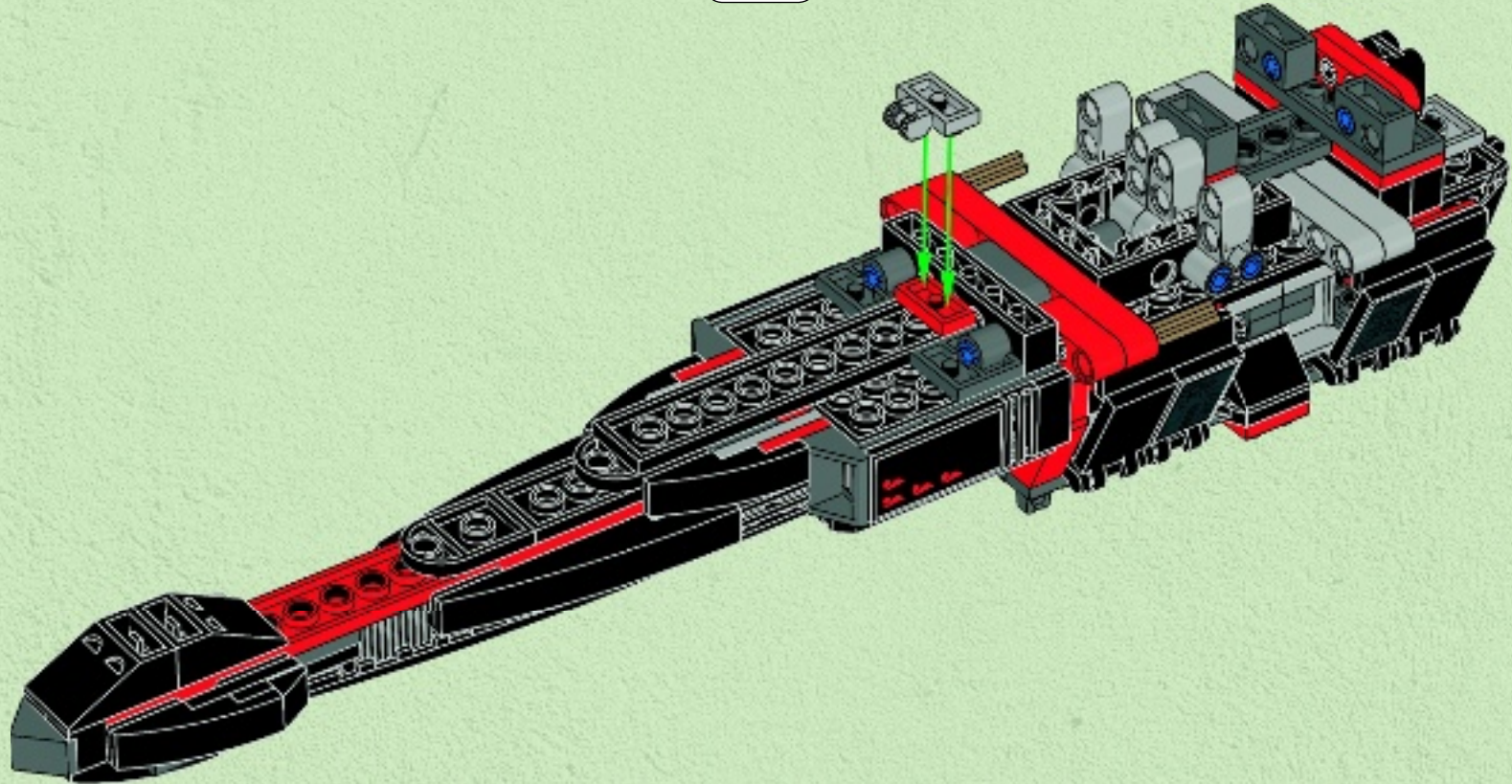
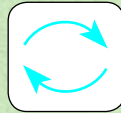

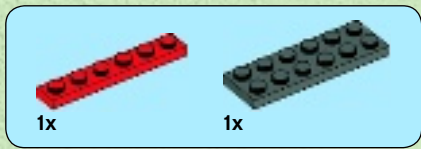

54

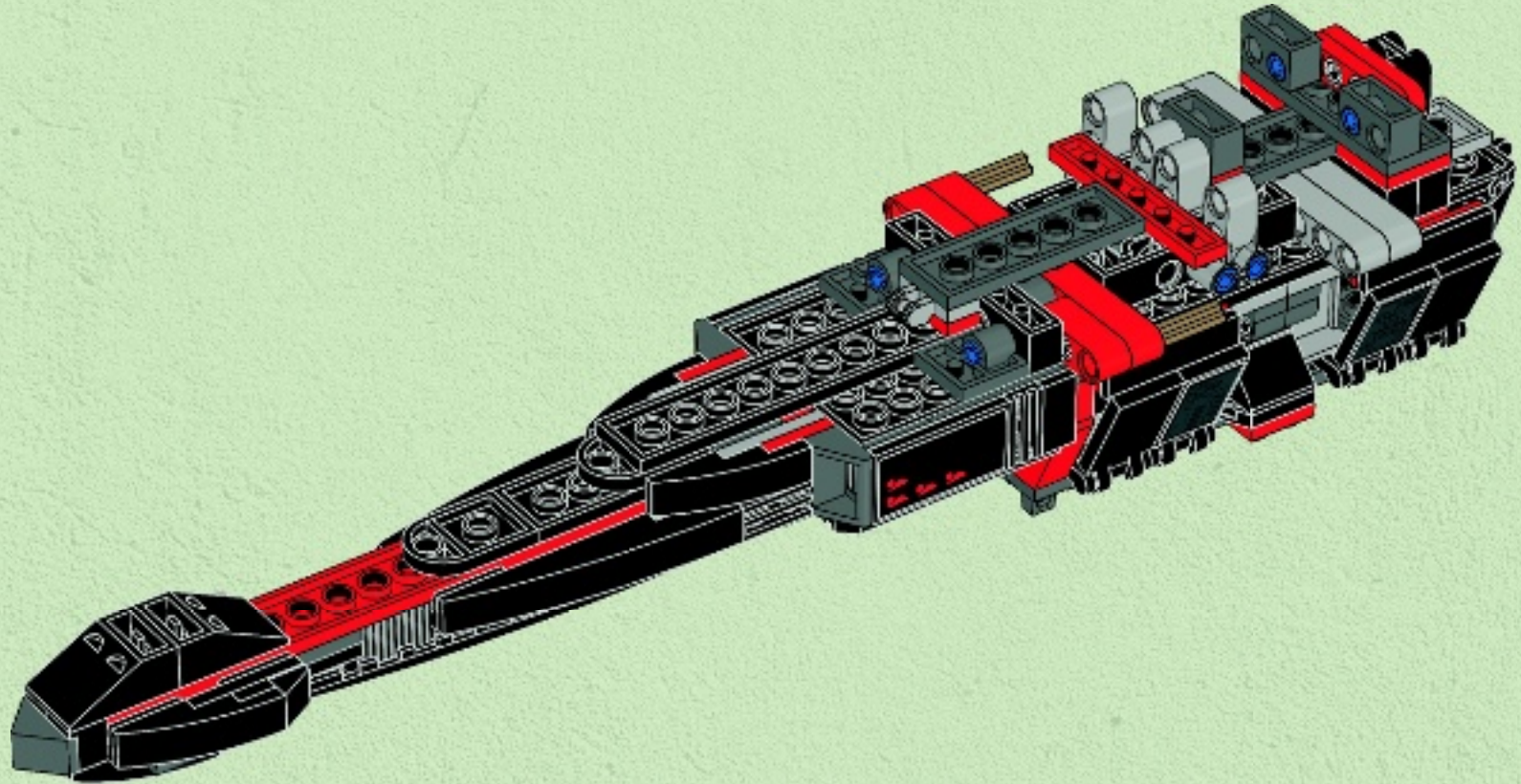



2x

55

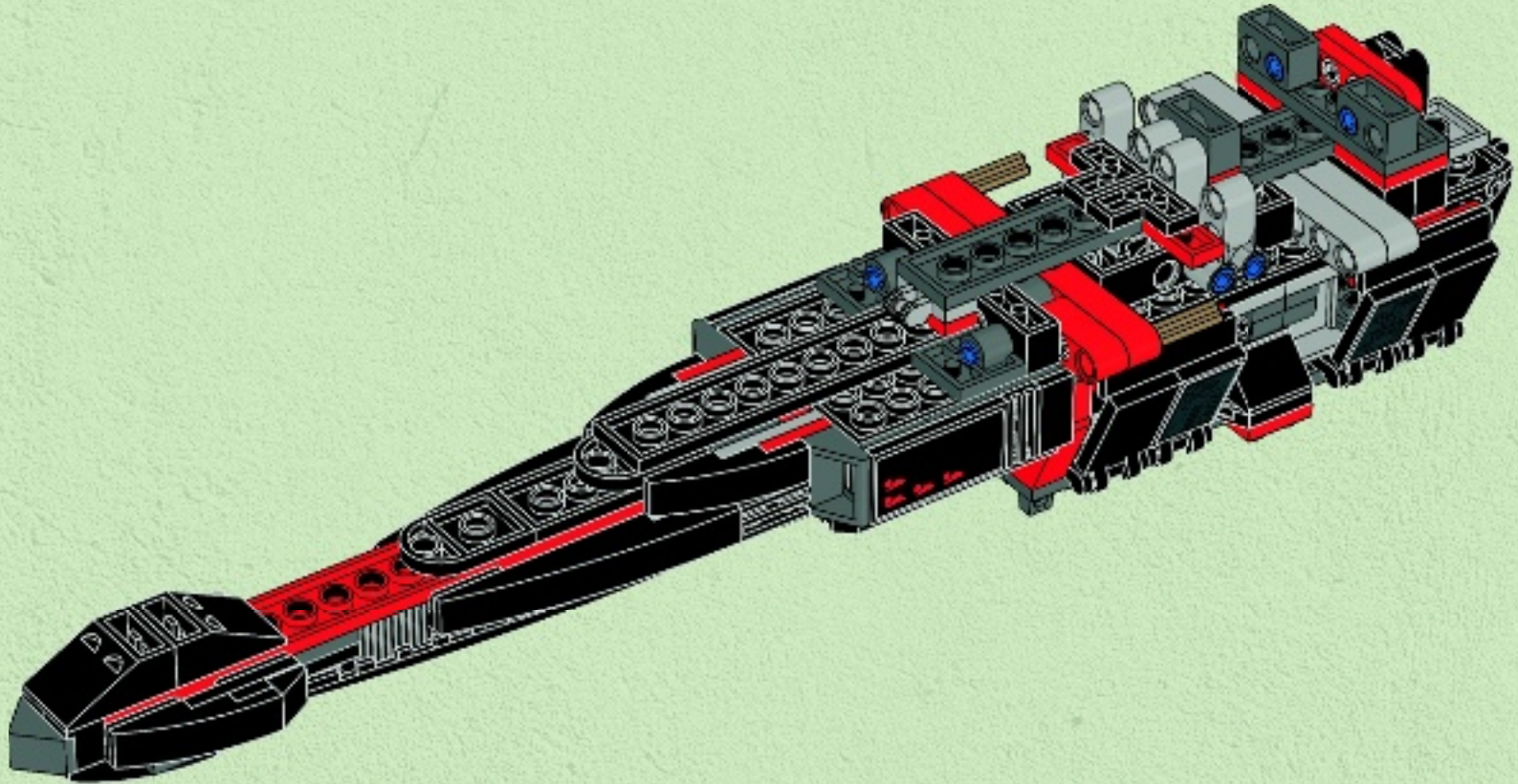



2x

# 56



2x

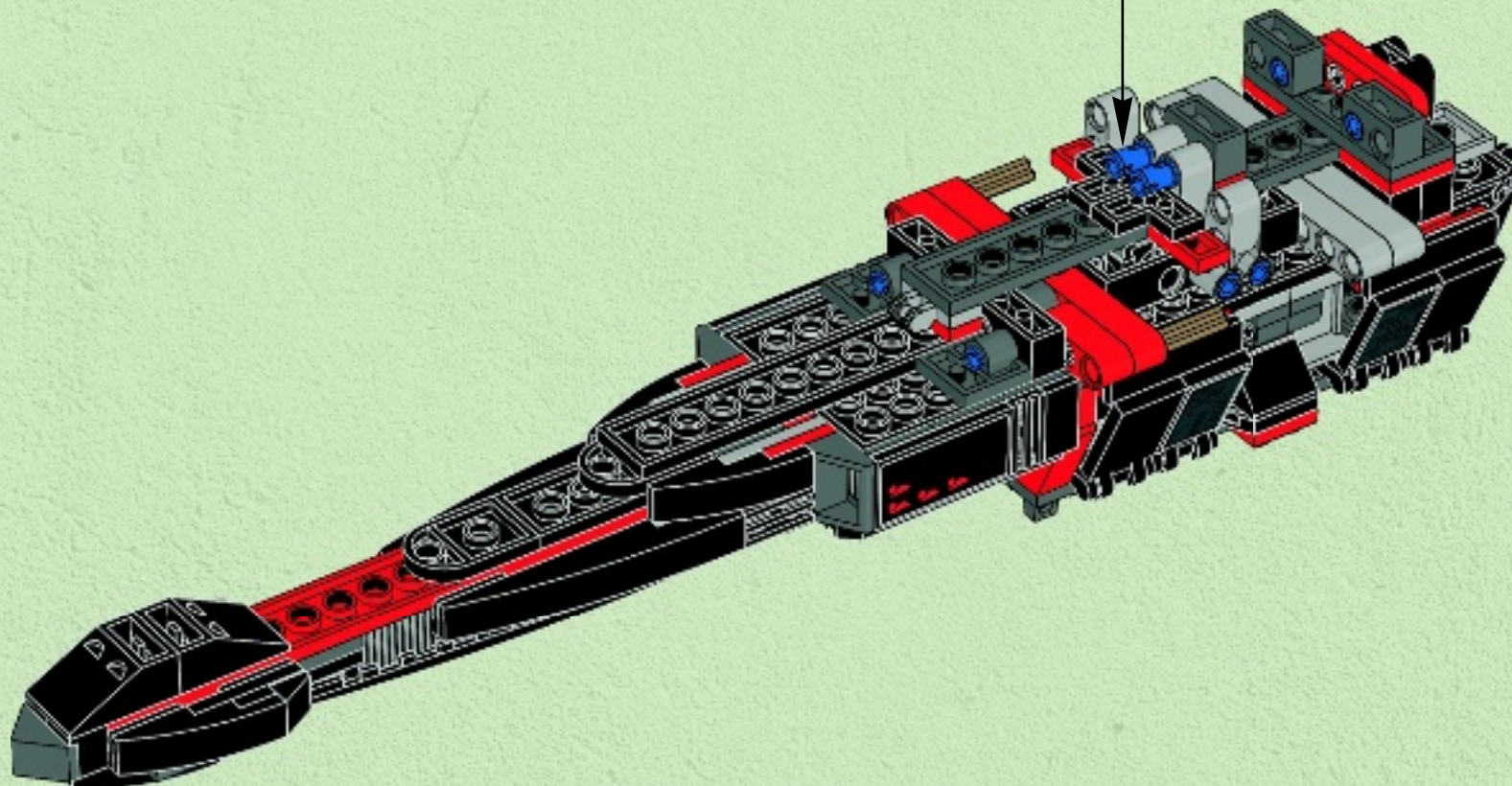

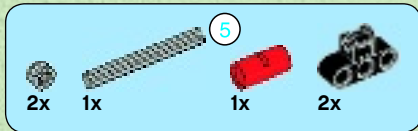

57

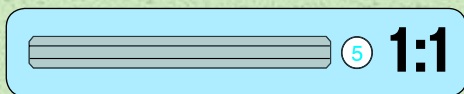
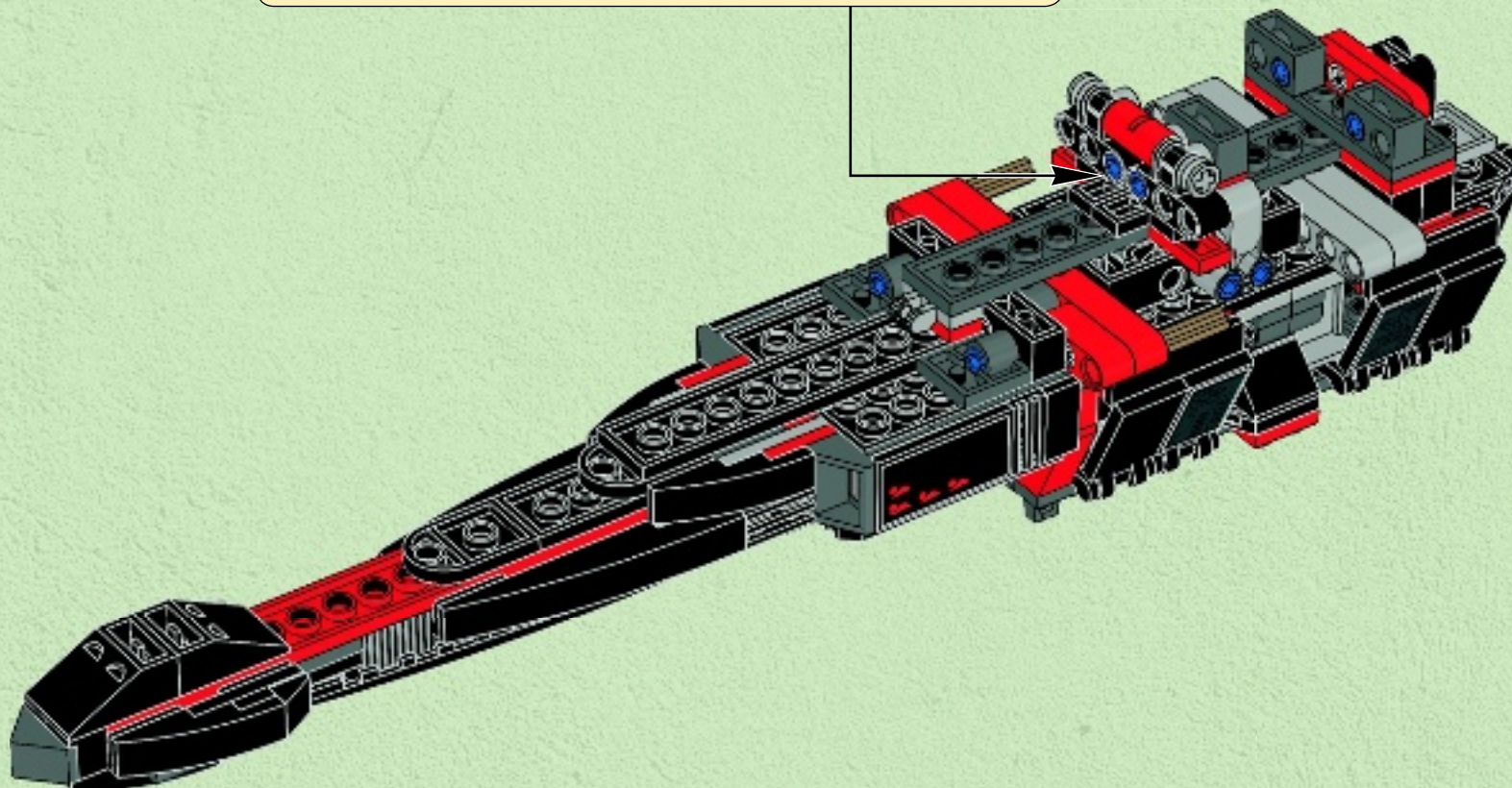
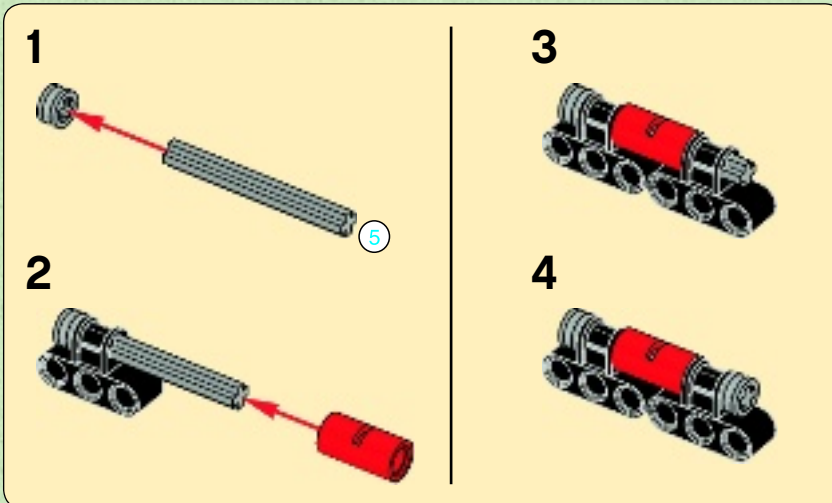



# 58

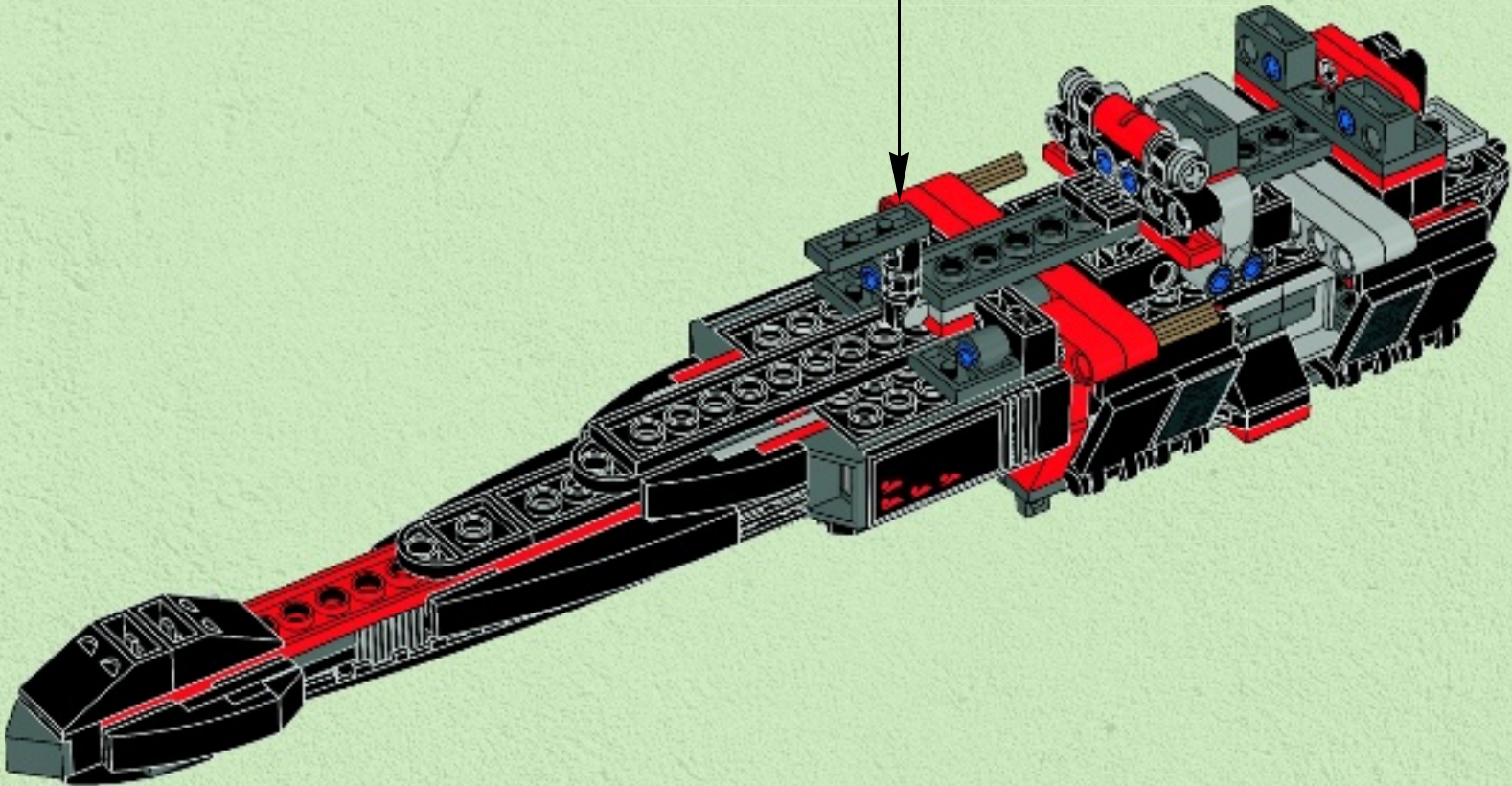
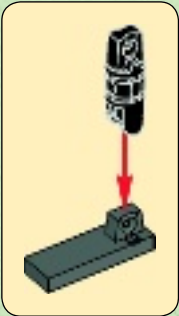



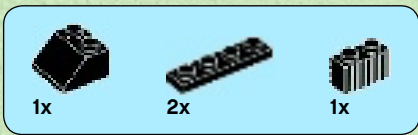

# 59

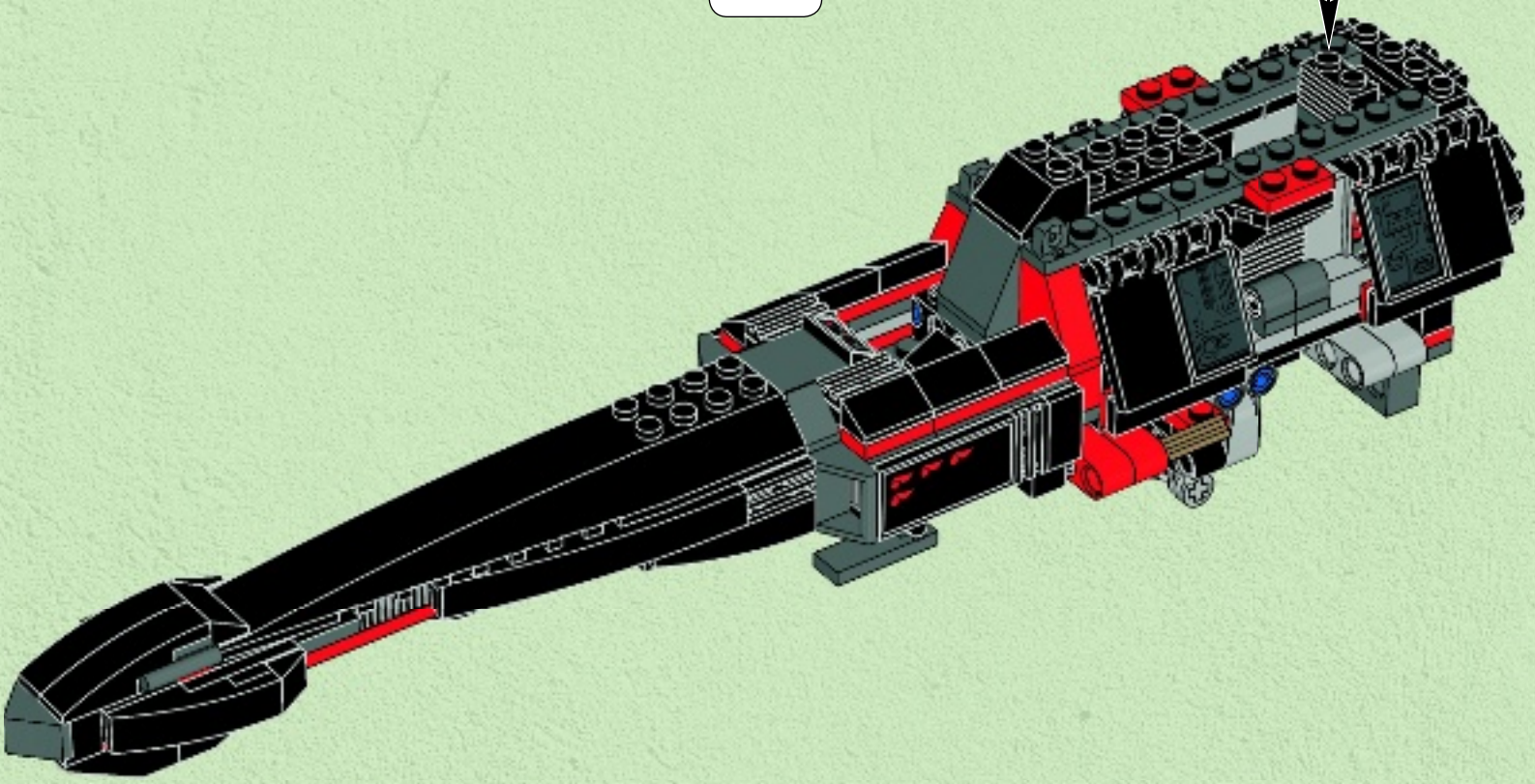
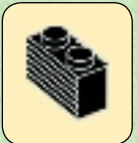
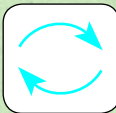



60

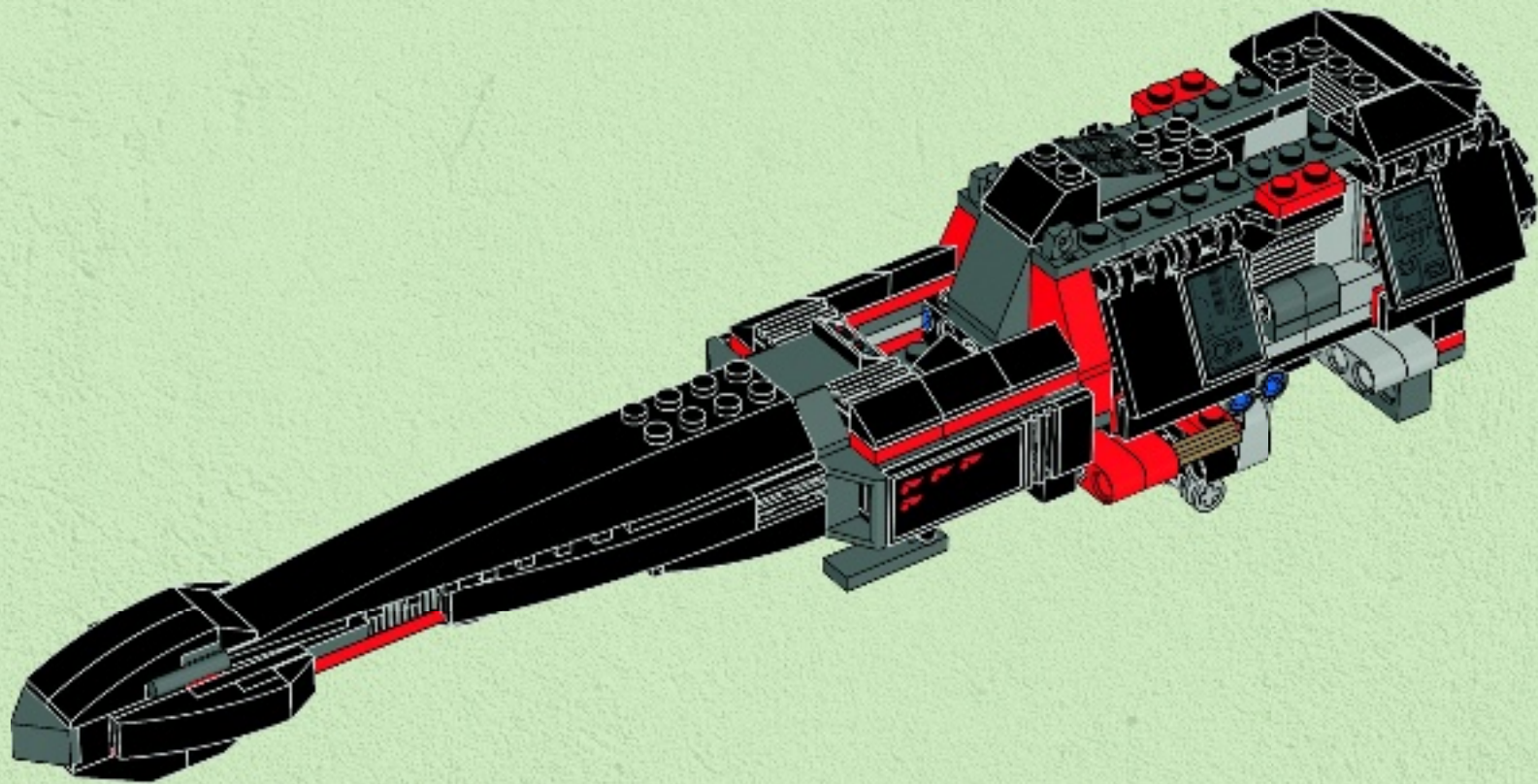



61

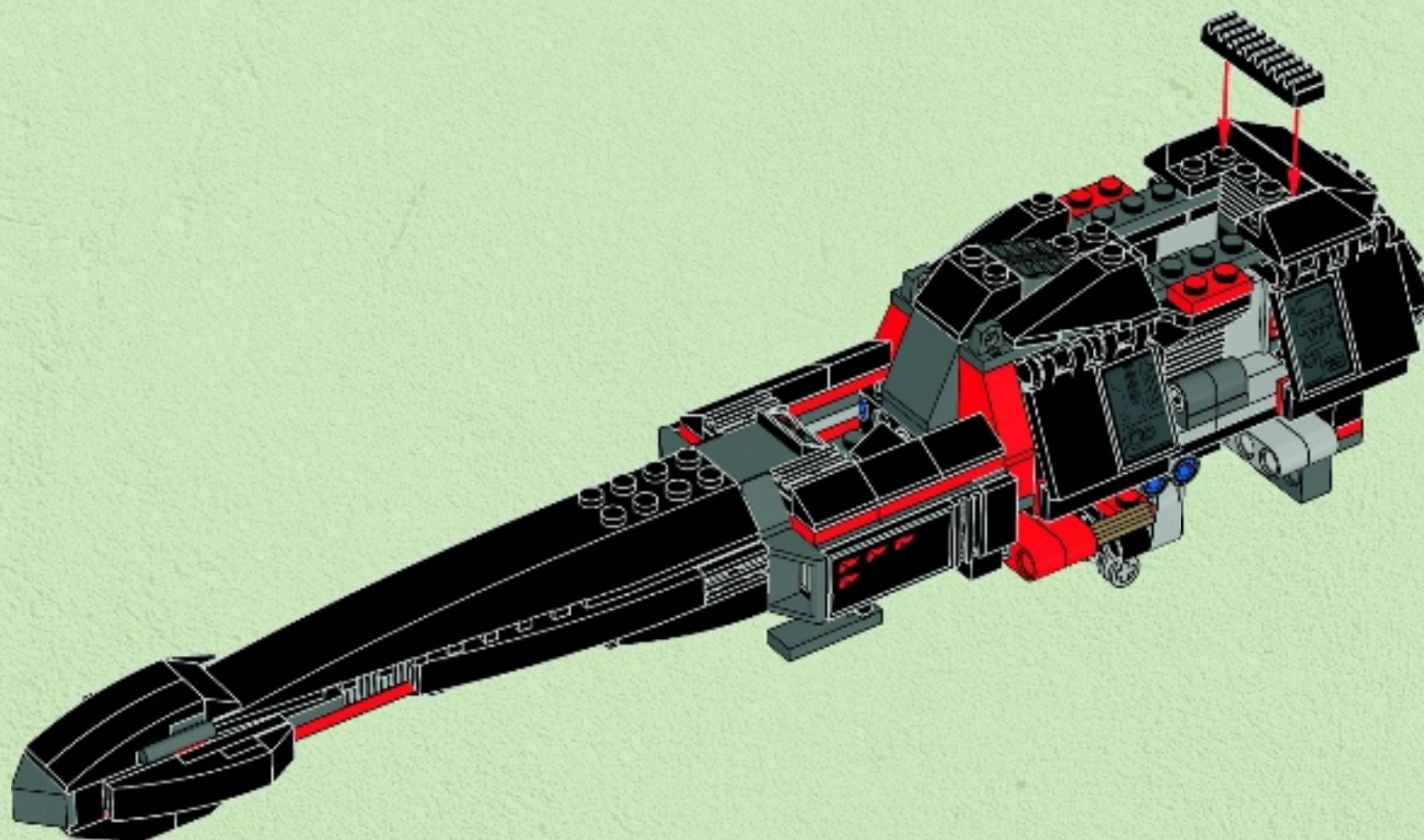

2x 1x 1x 2x

62

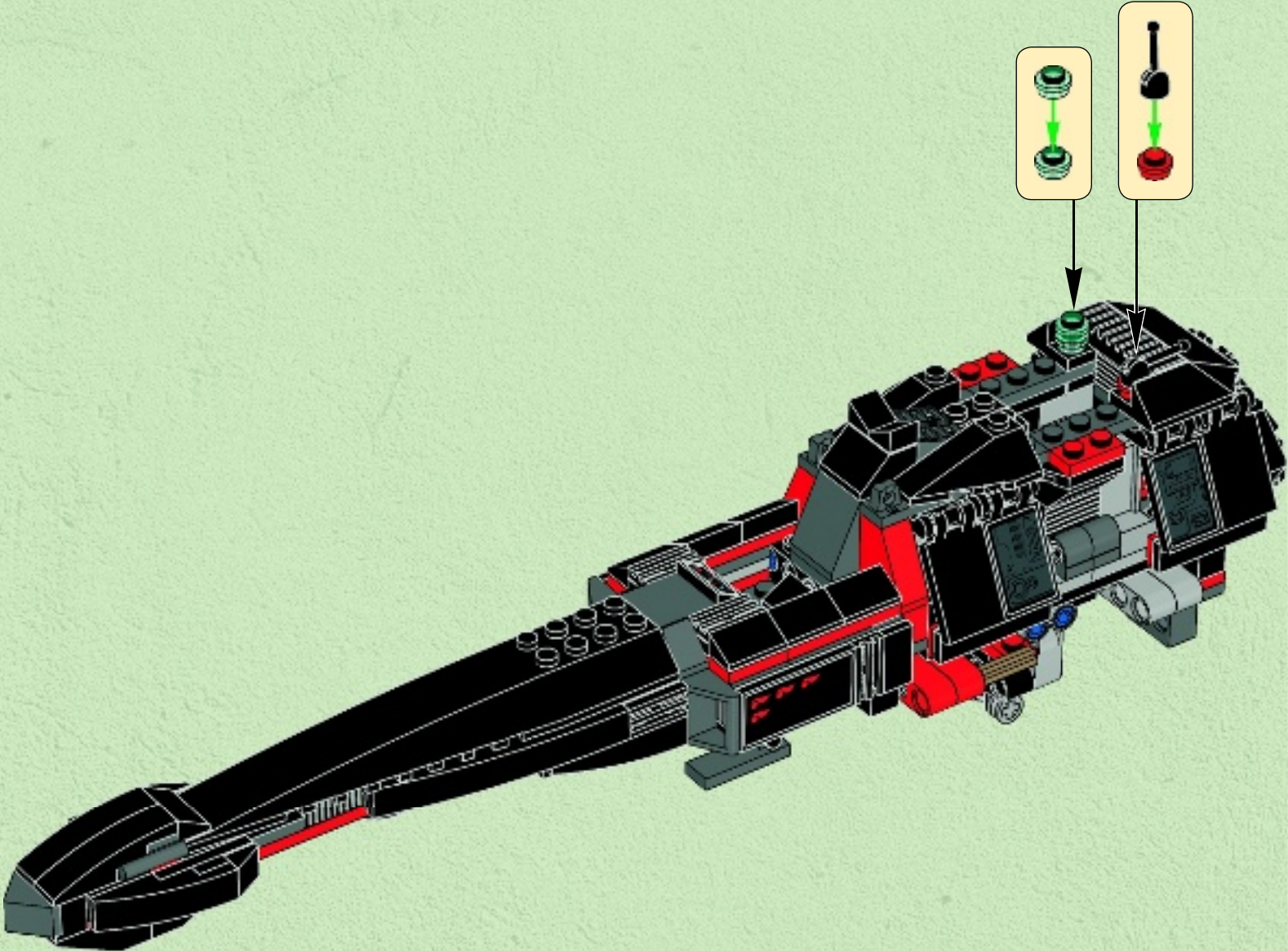



2x

63

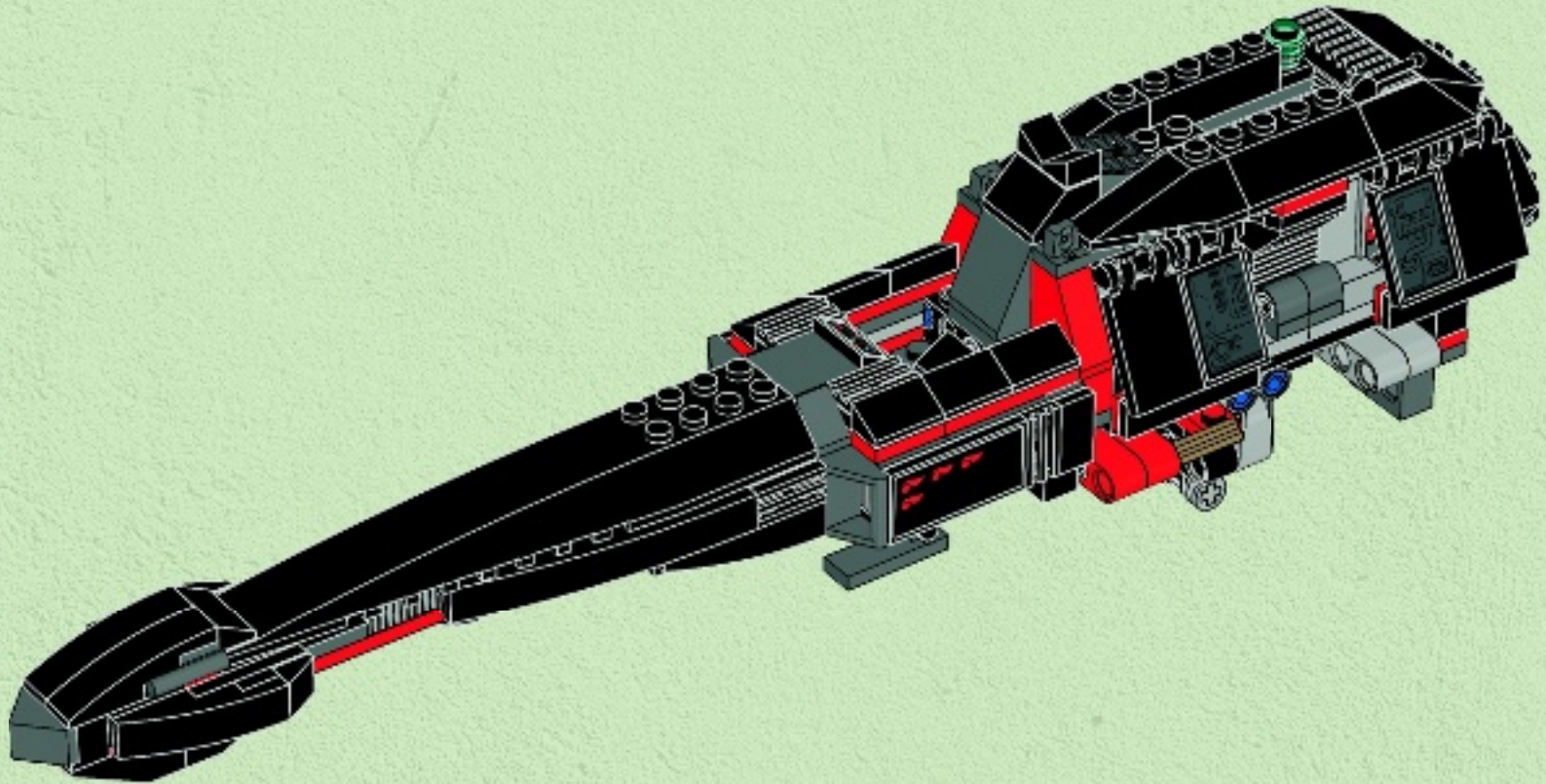

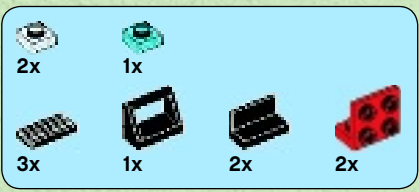

# 64

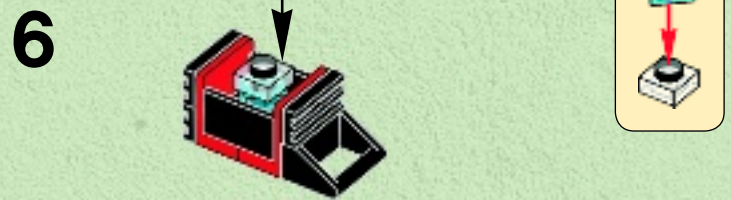
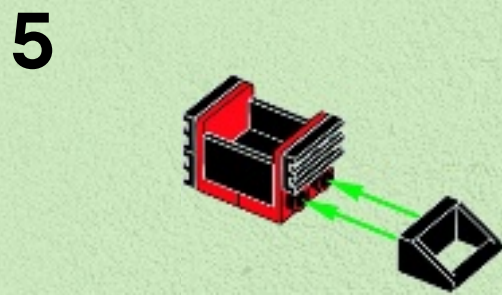
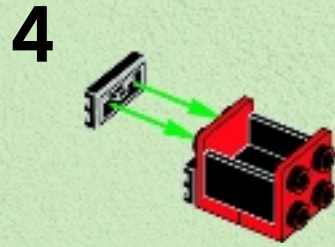
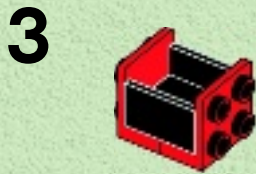
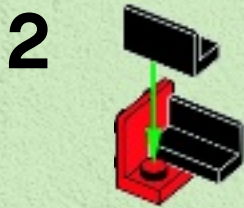
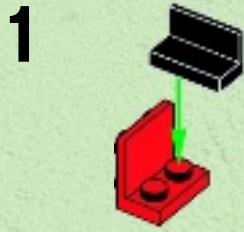

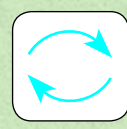

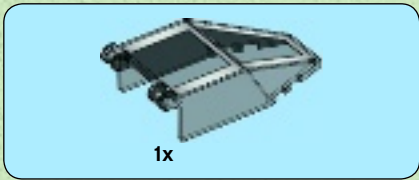

65

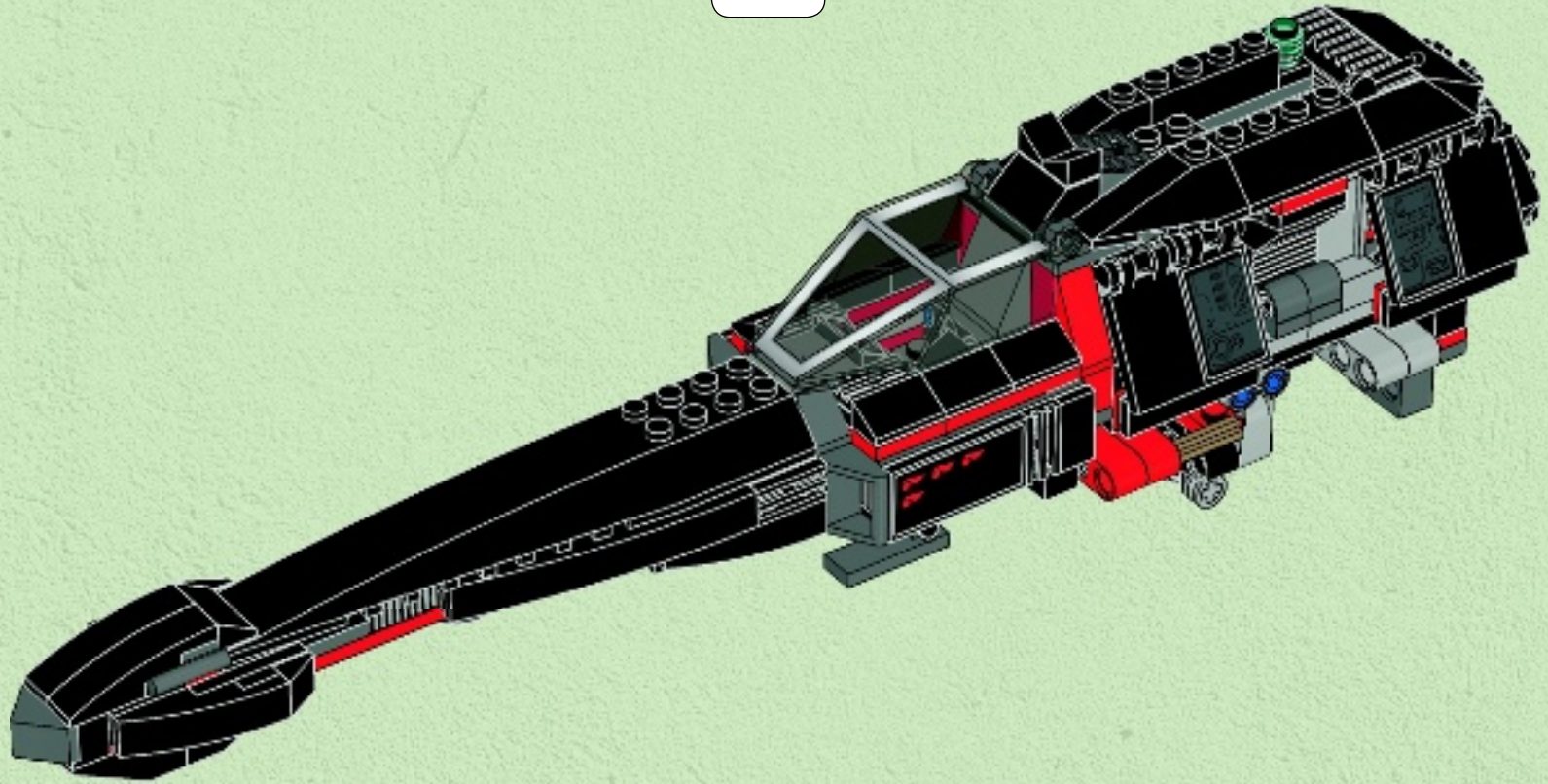
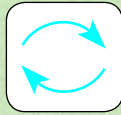



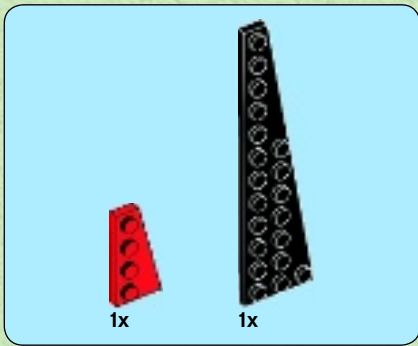
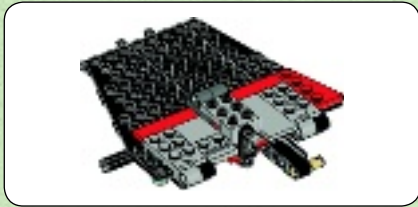
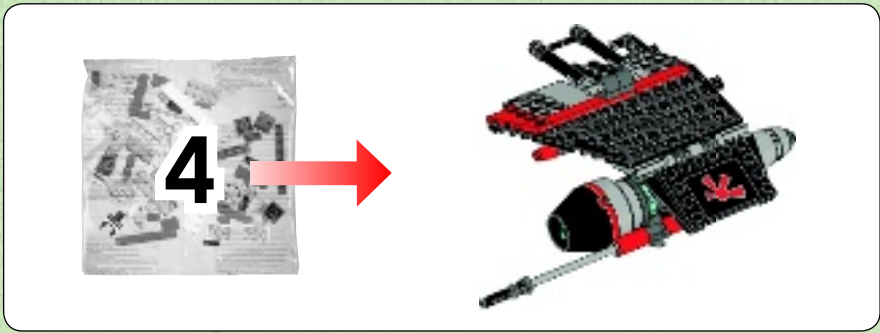

**1**

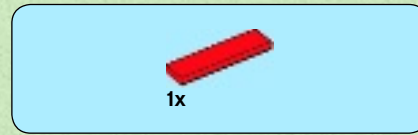
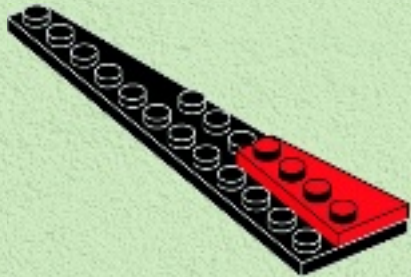

**2**

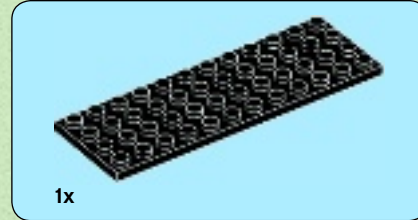
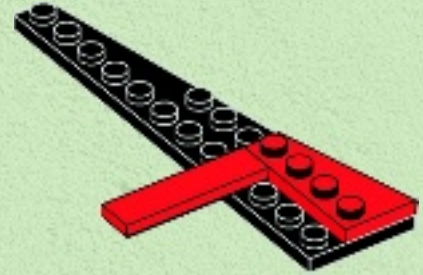

**3**



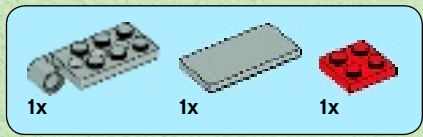

4

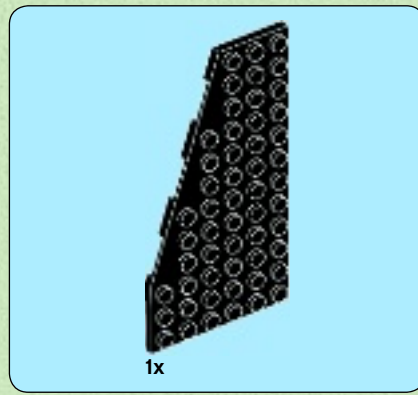
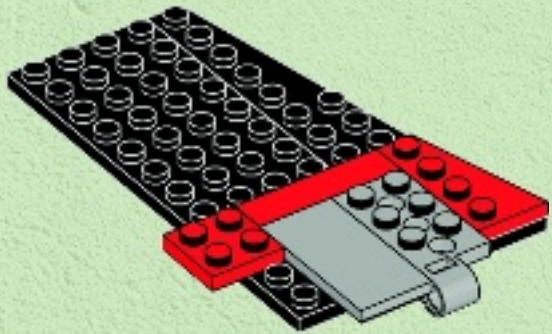

5

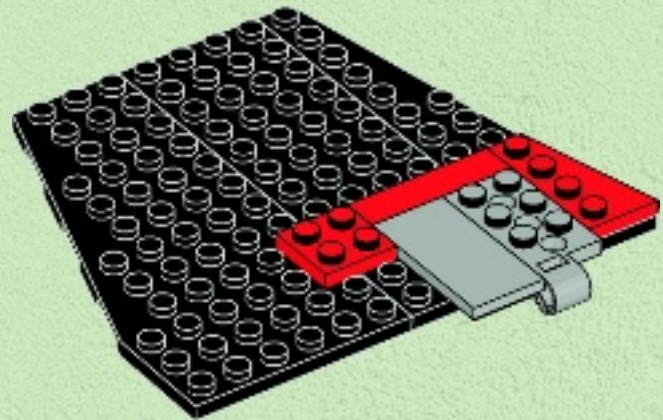

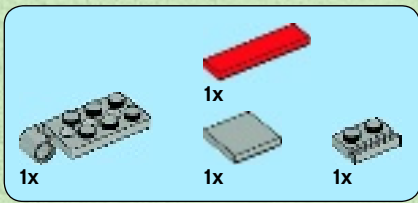

6

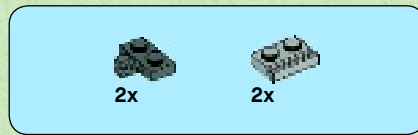
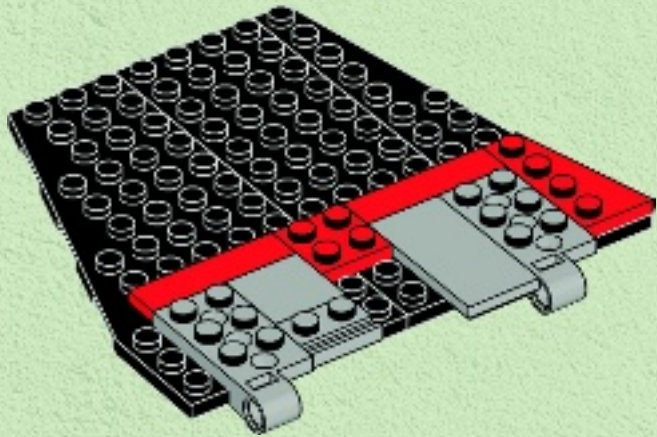

7

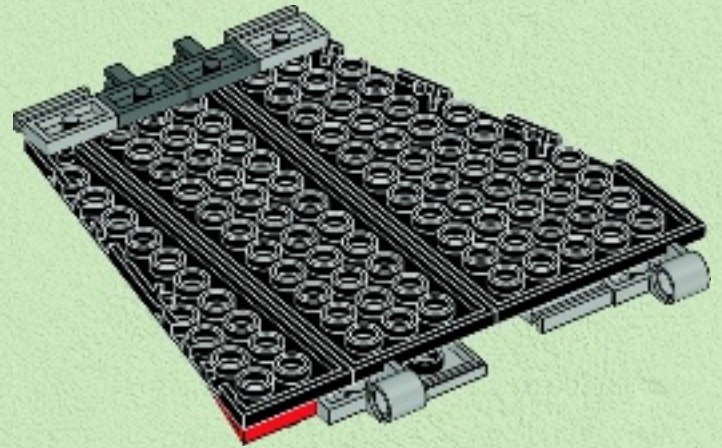
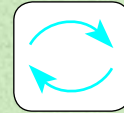

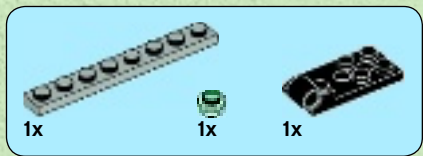

8

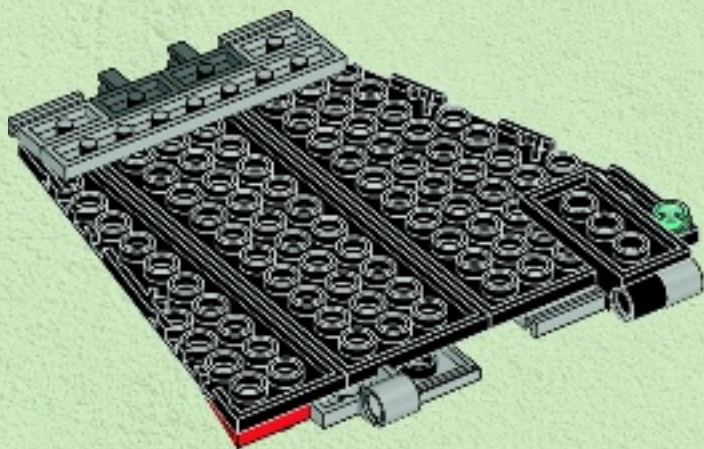

9

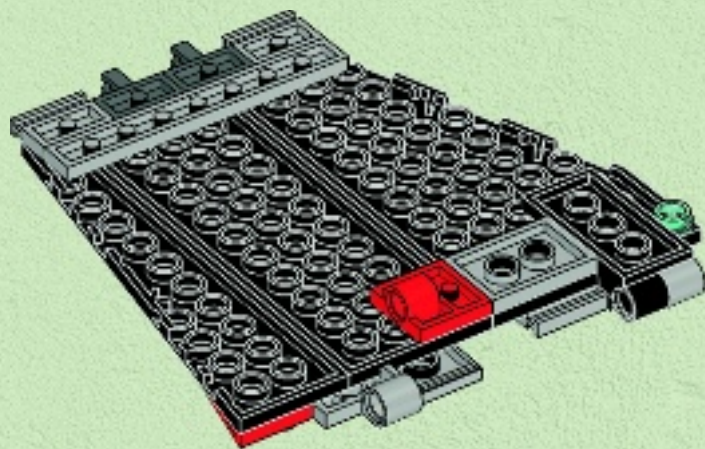



10

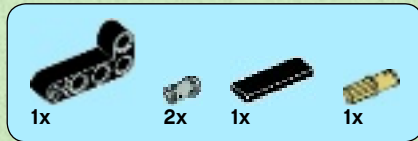
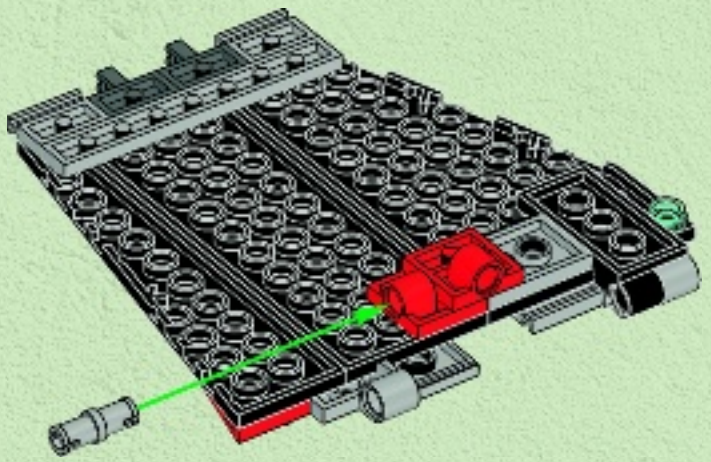

11

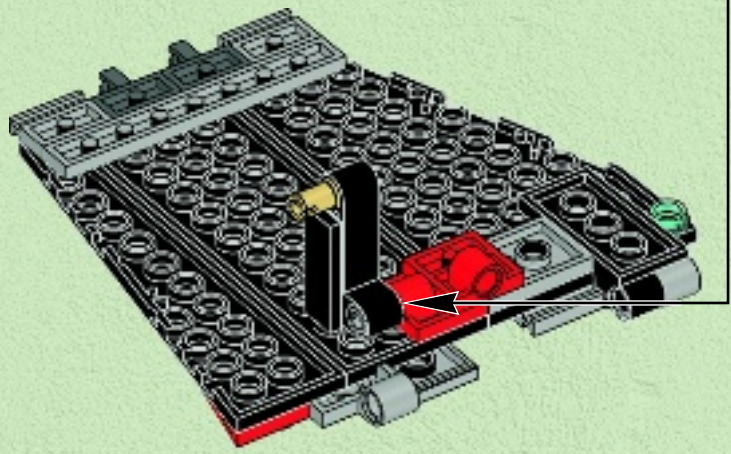
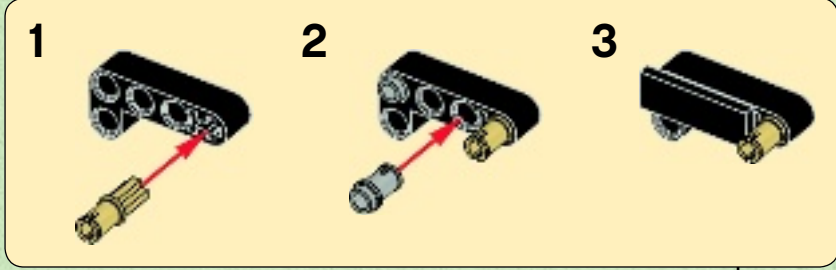



12

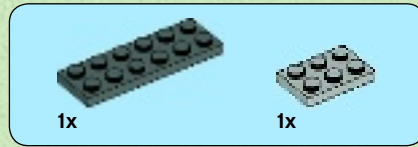
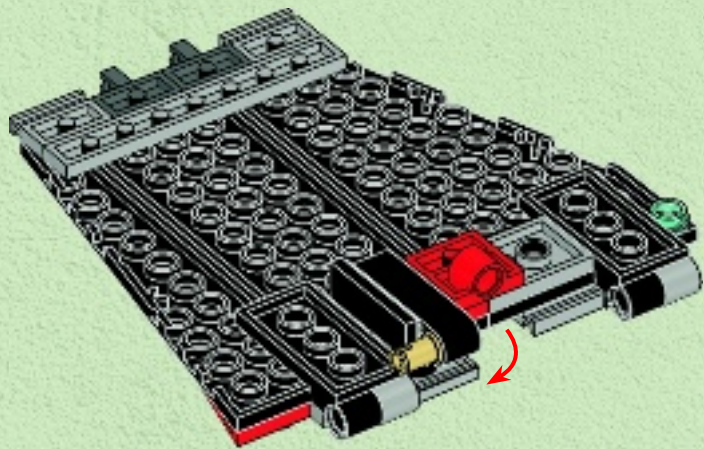

13

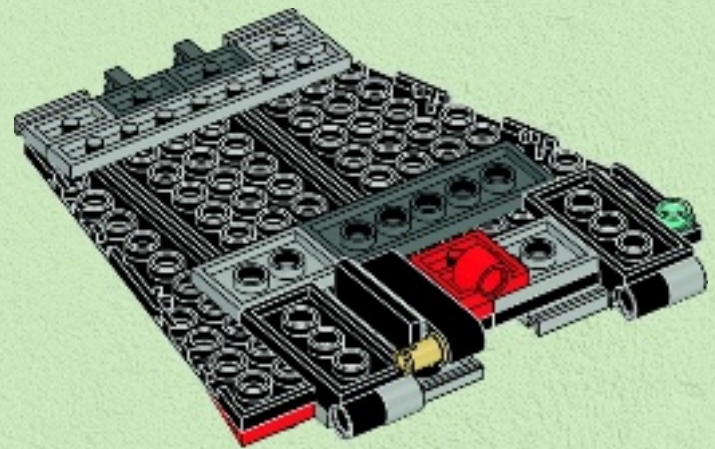



2x

14

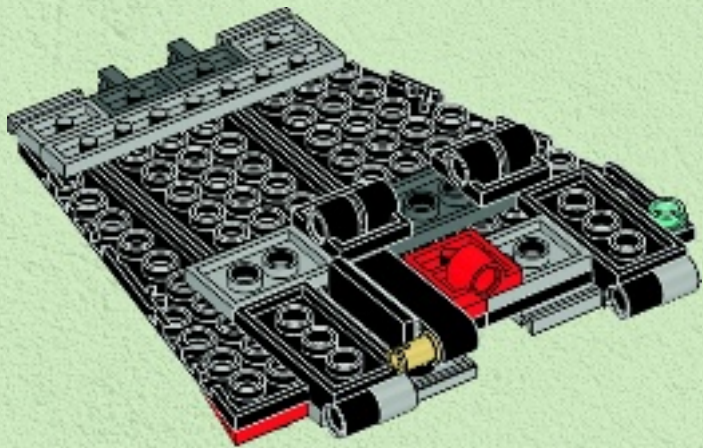

1x



1x

15

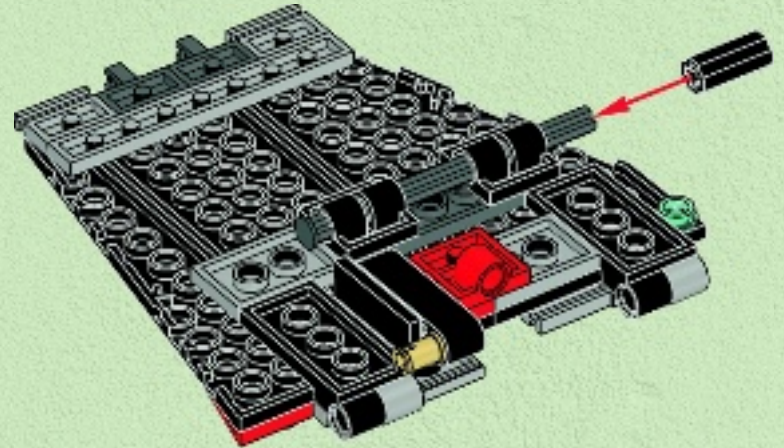



1x

16

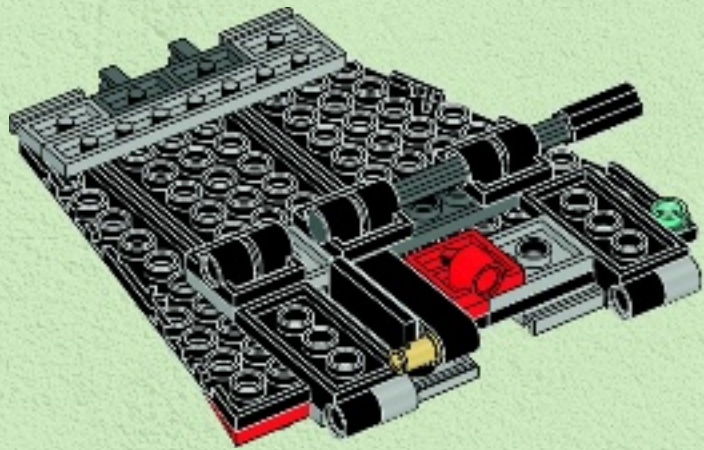

1x



1x

17

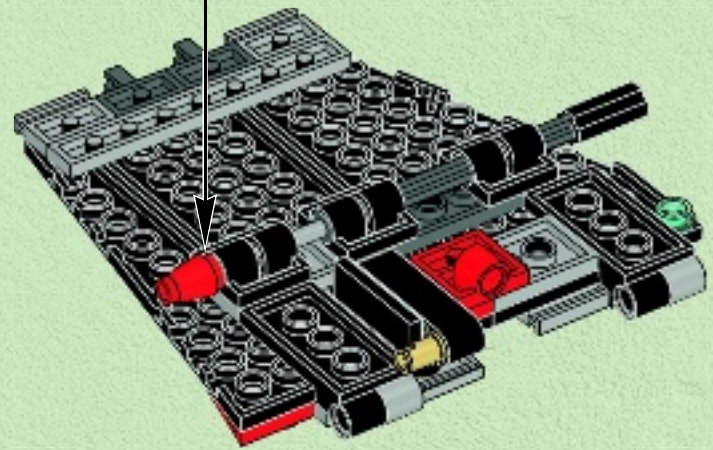
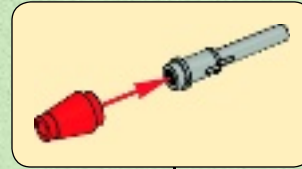



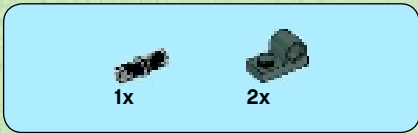

# 18

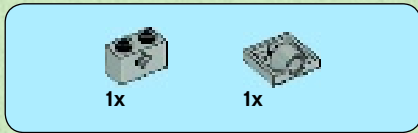
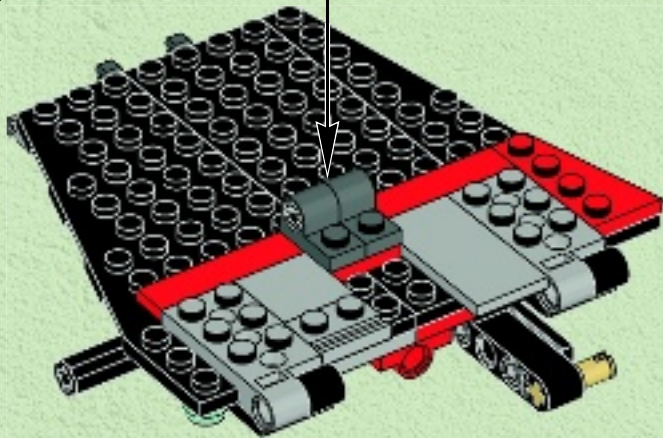
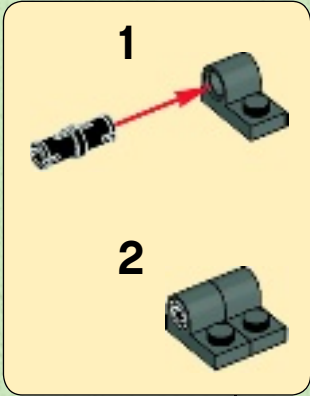

# 19

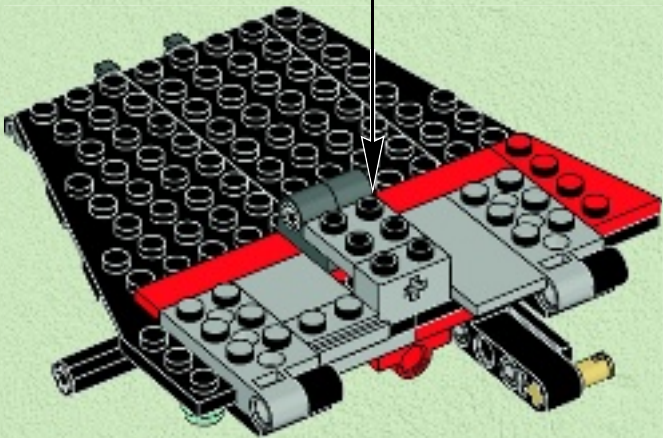

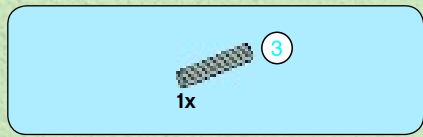

20

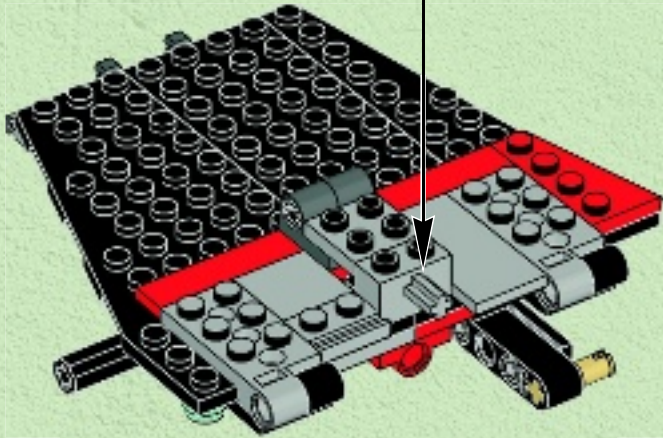
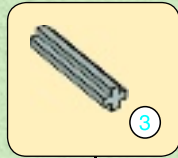

21

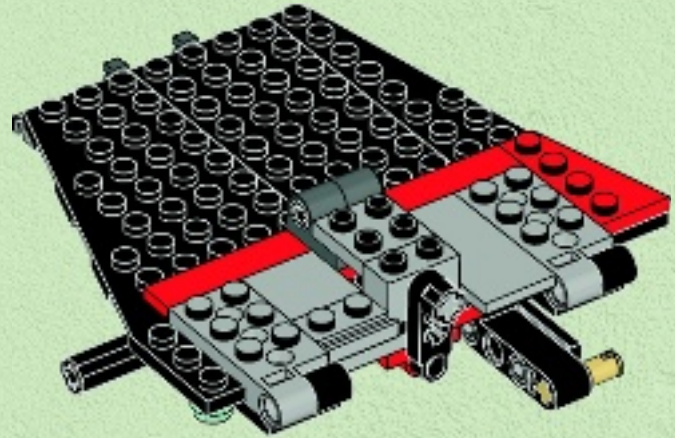

66

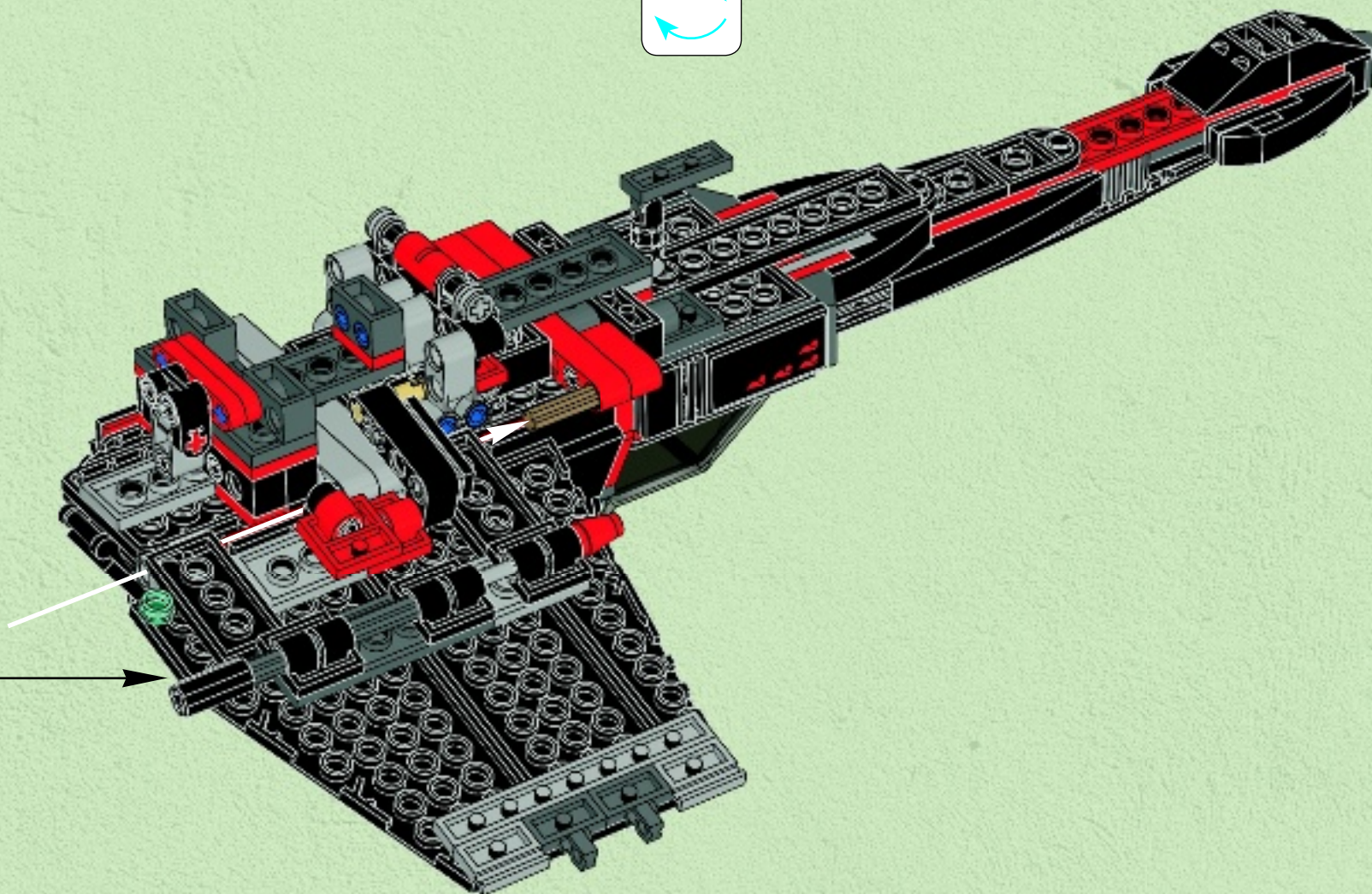
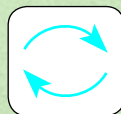

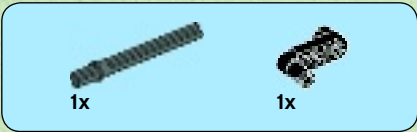

67

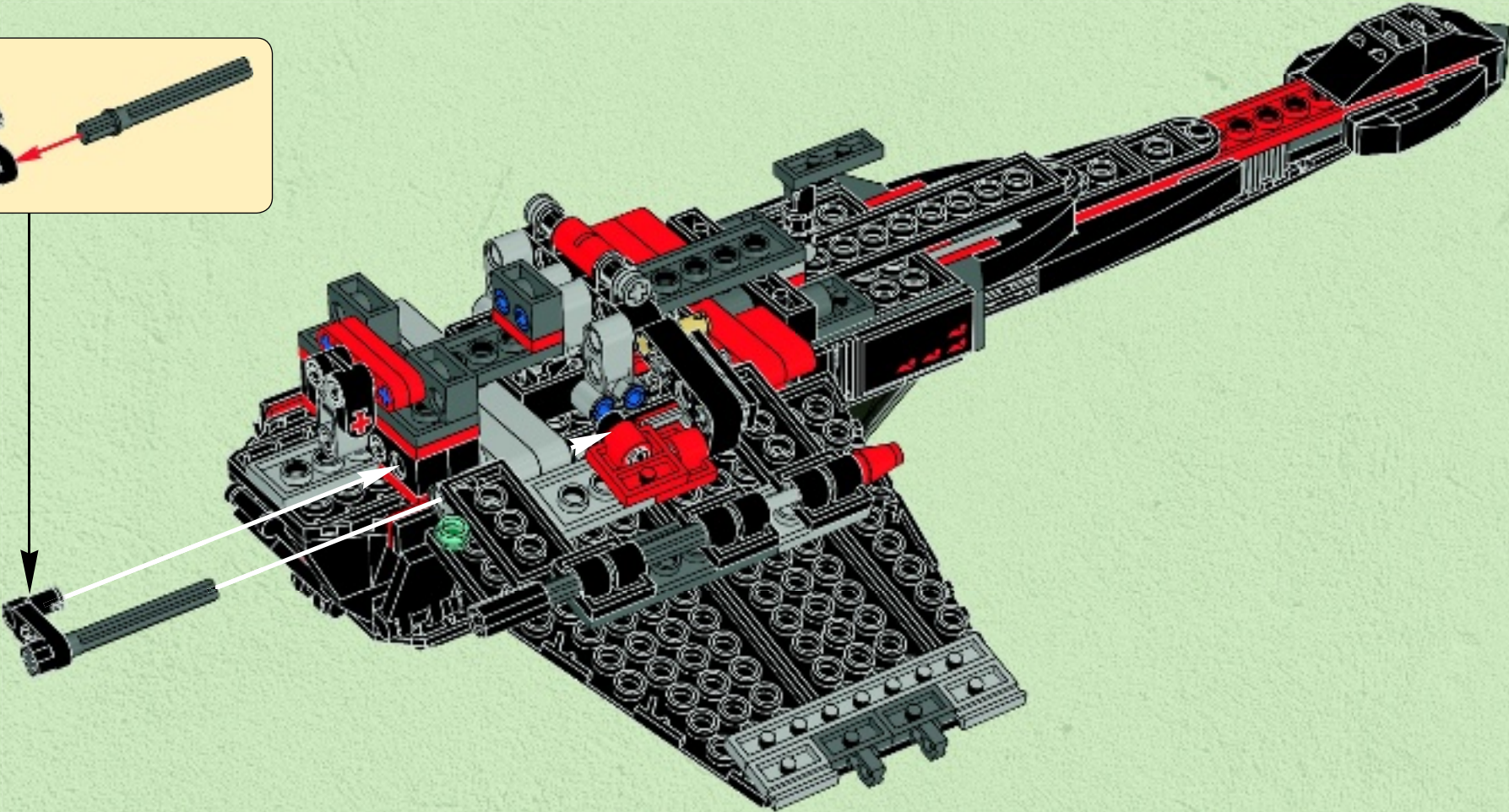
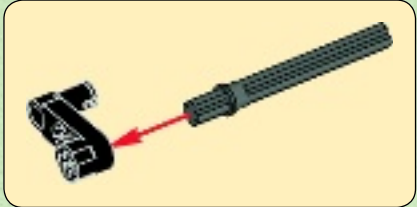

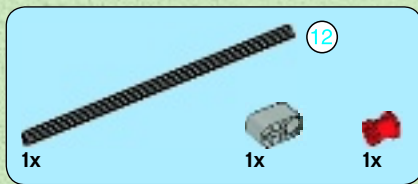

68

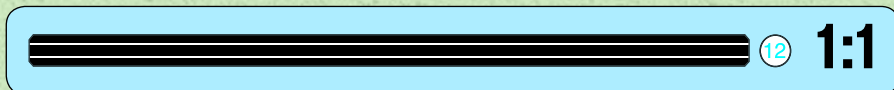
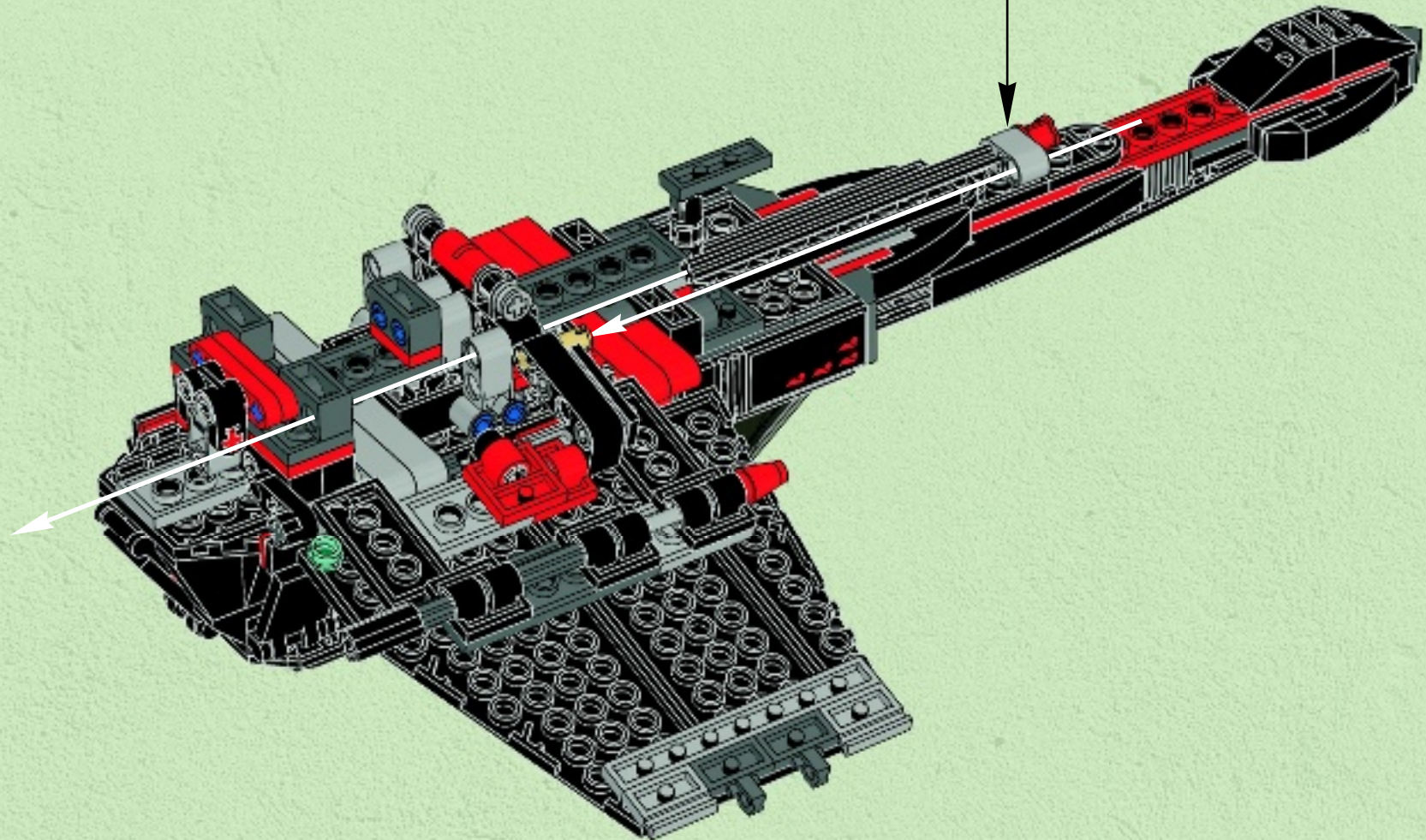
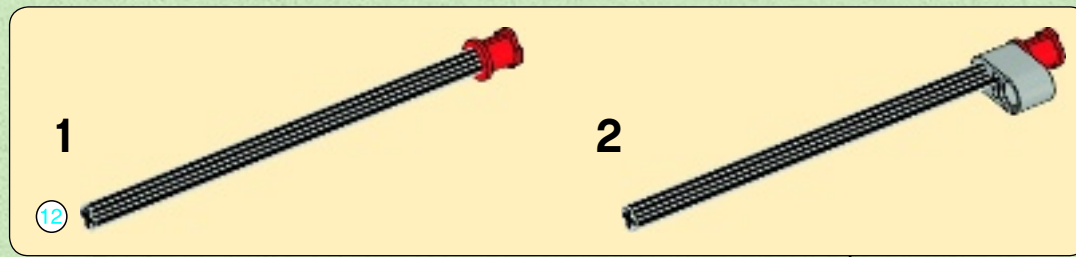



1x



1x

# 69

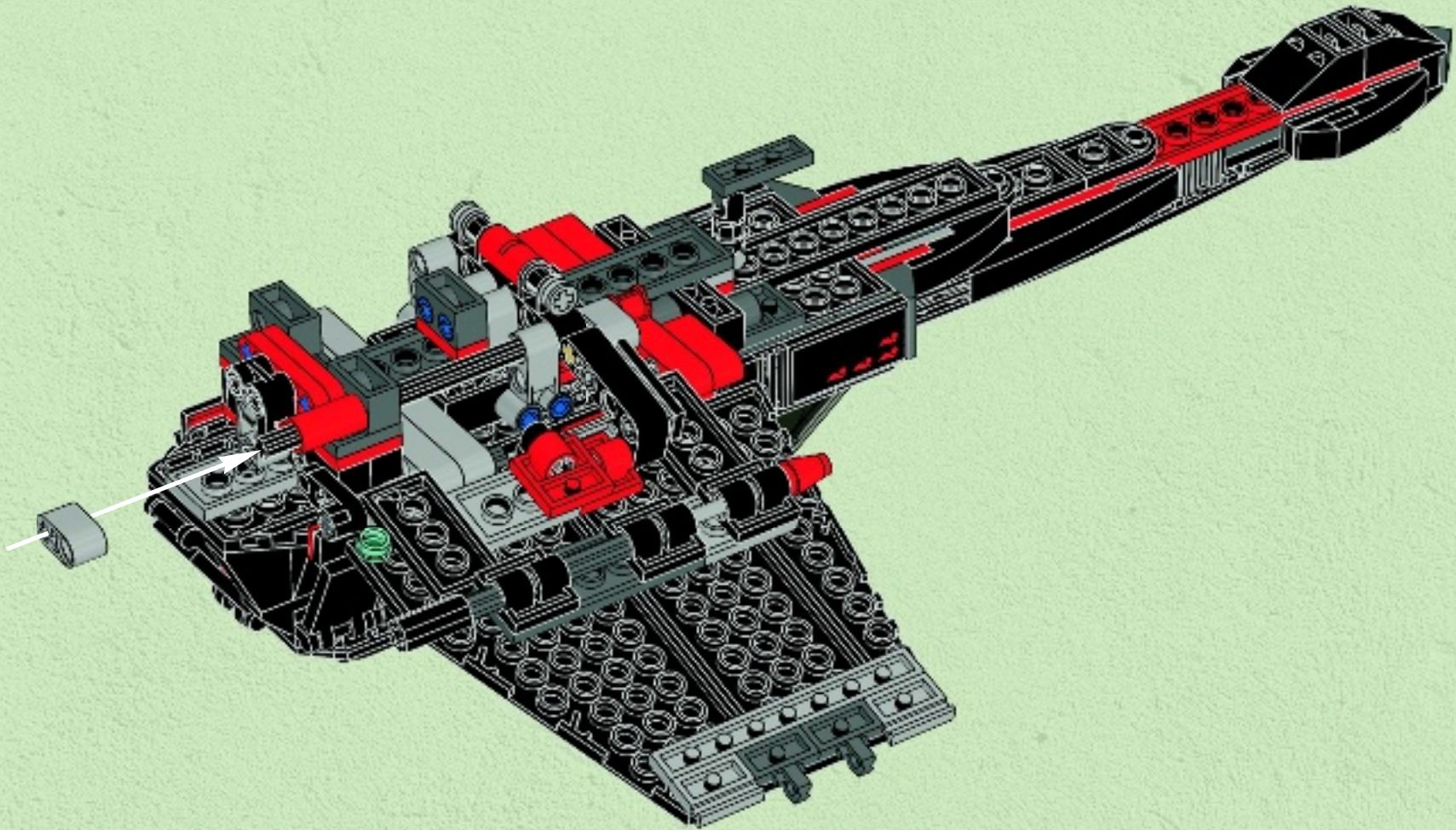

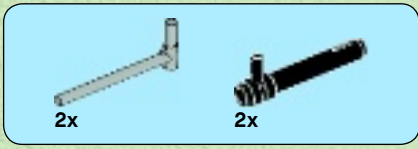

70

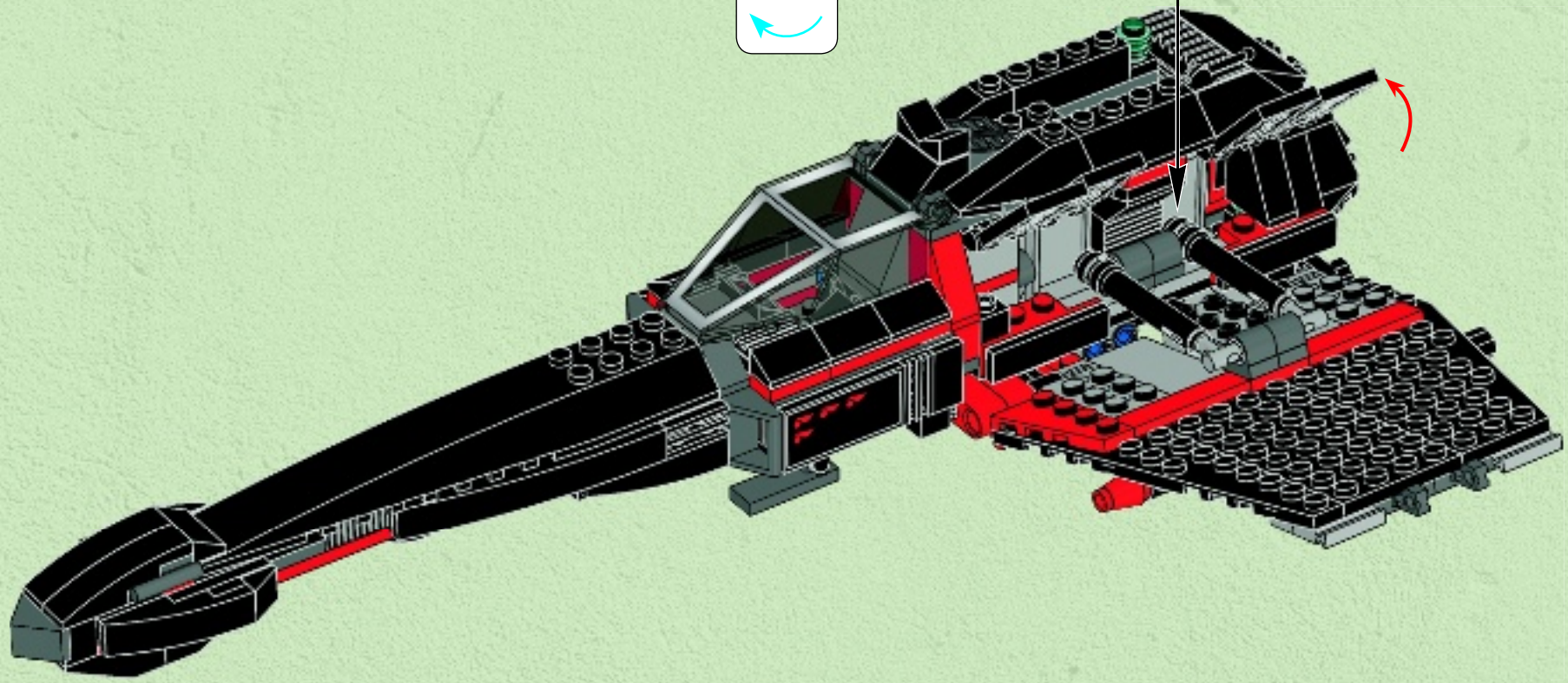
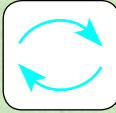
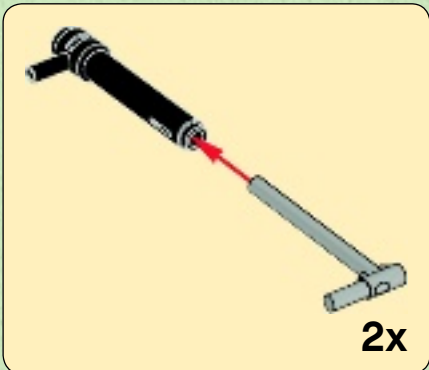

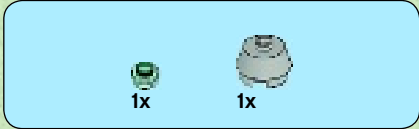
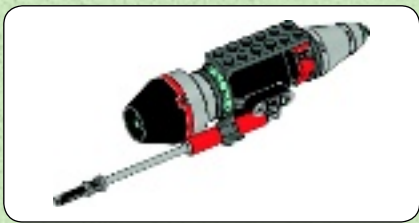

1

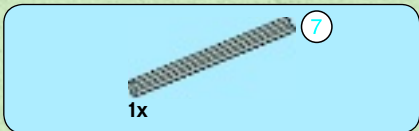

2

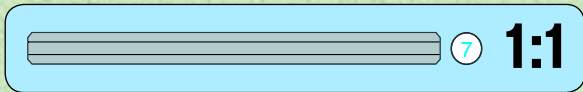
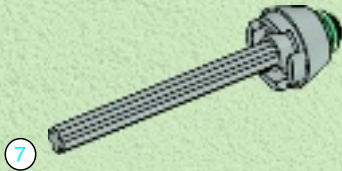

3

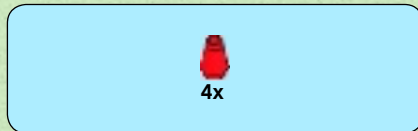
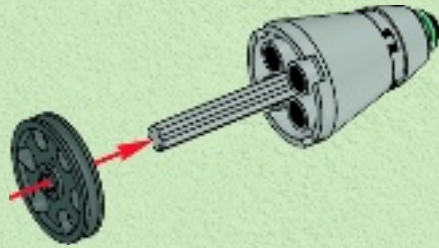

4

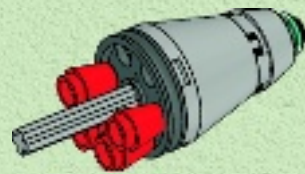





5

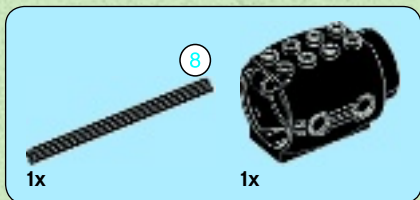
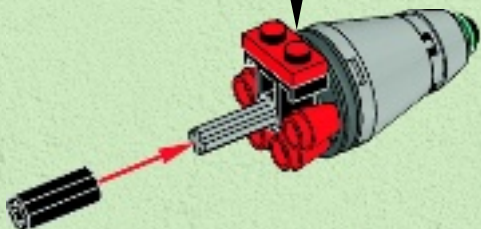

6

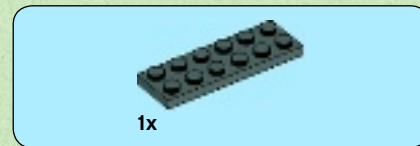
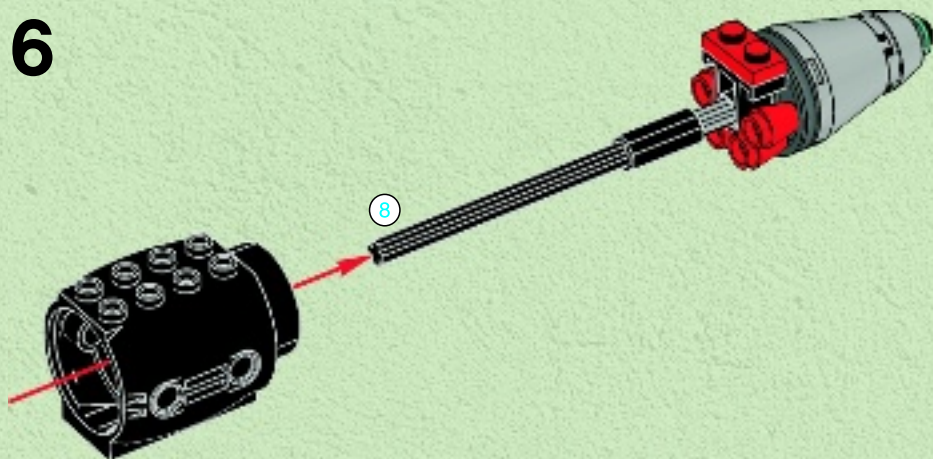

7

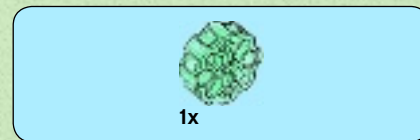

8

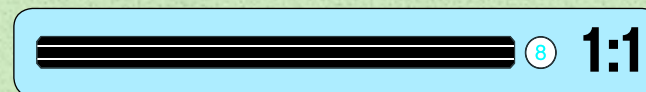
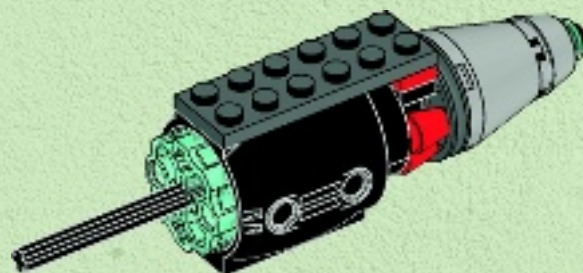

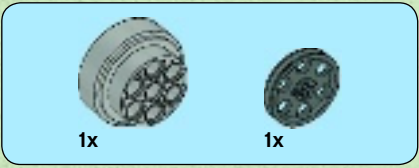

9

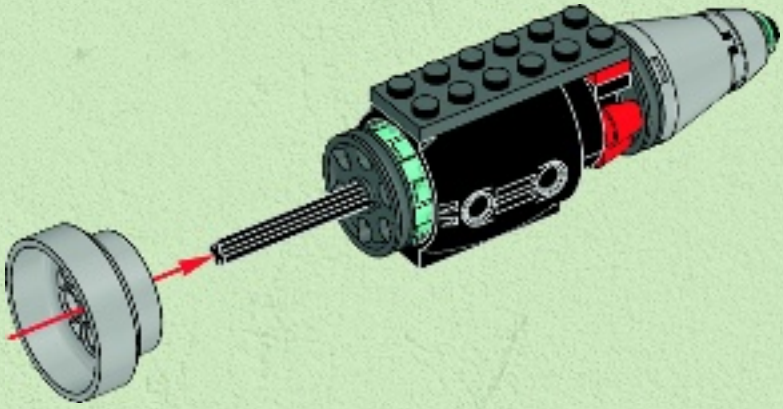

10

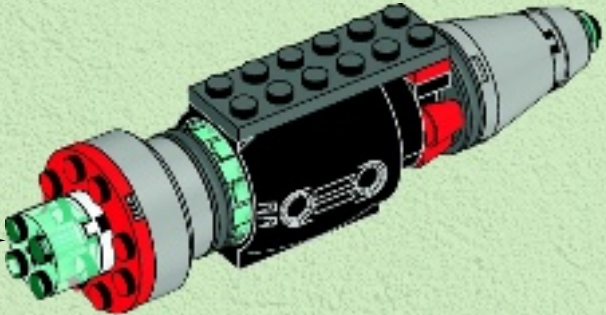

11

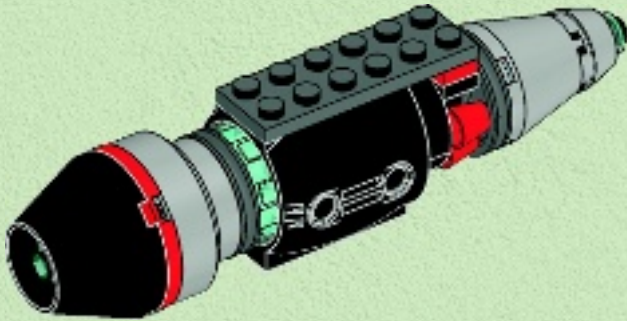

12

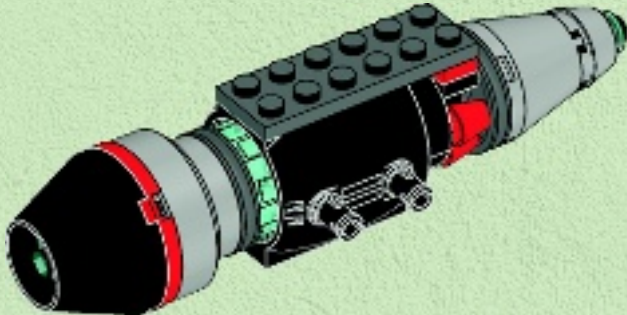

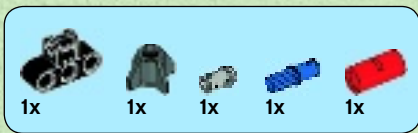

# 13

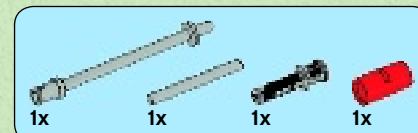
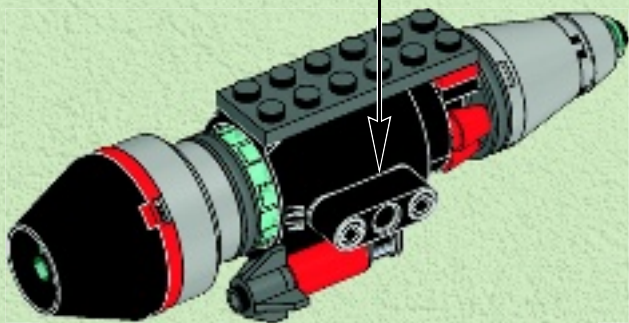
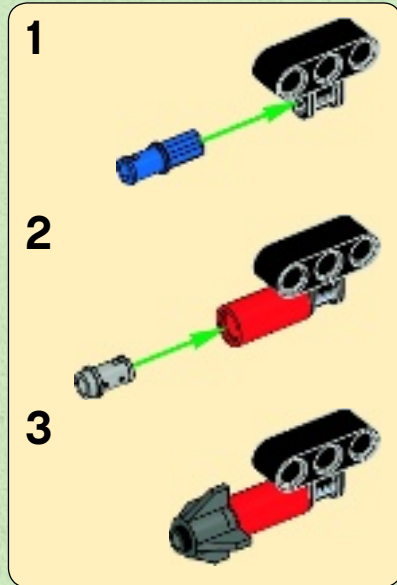

# 14

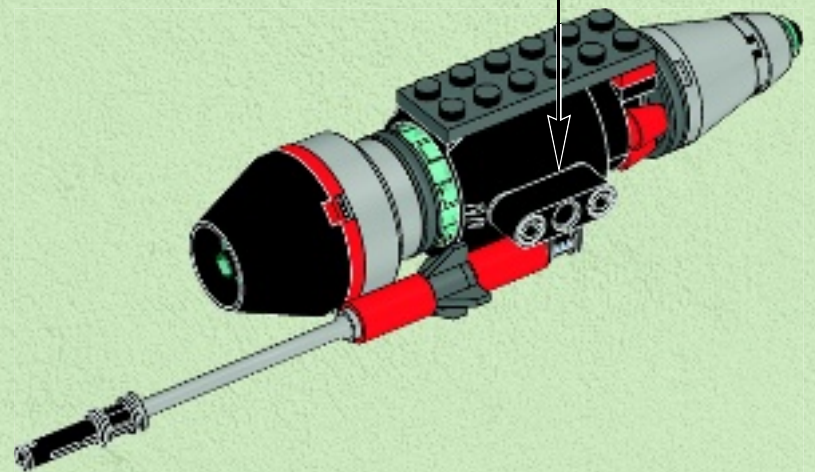
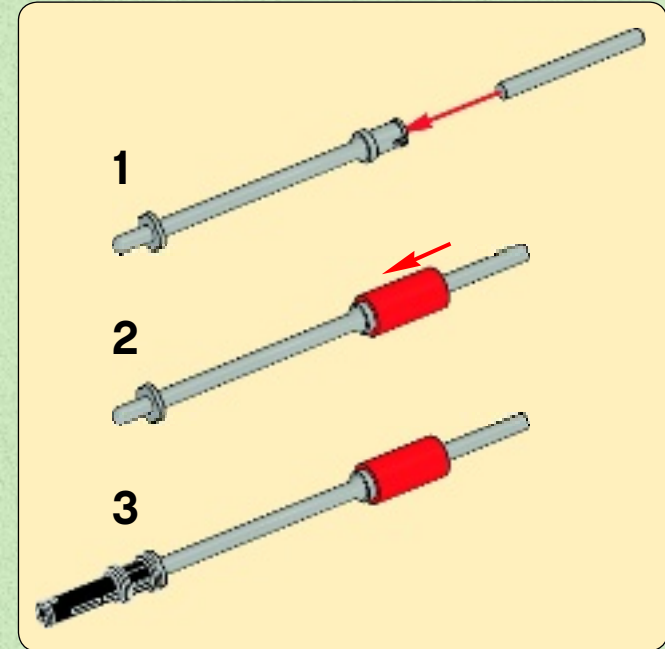

71

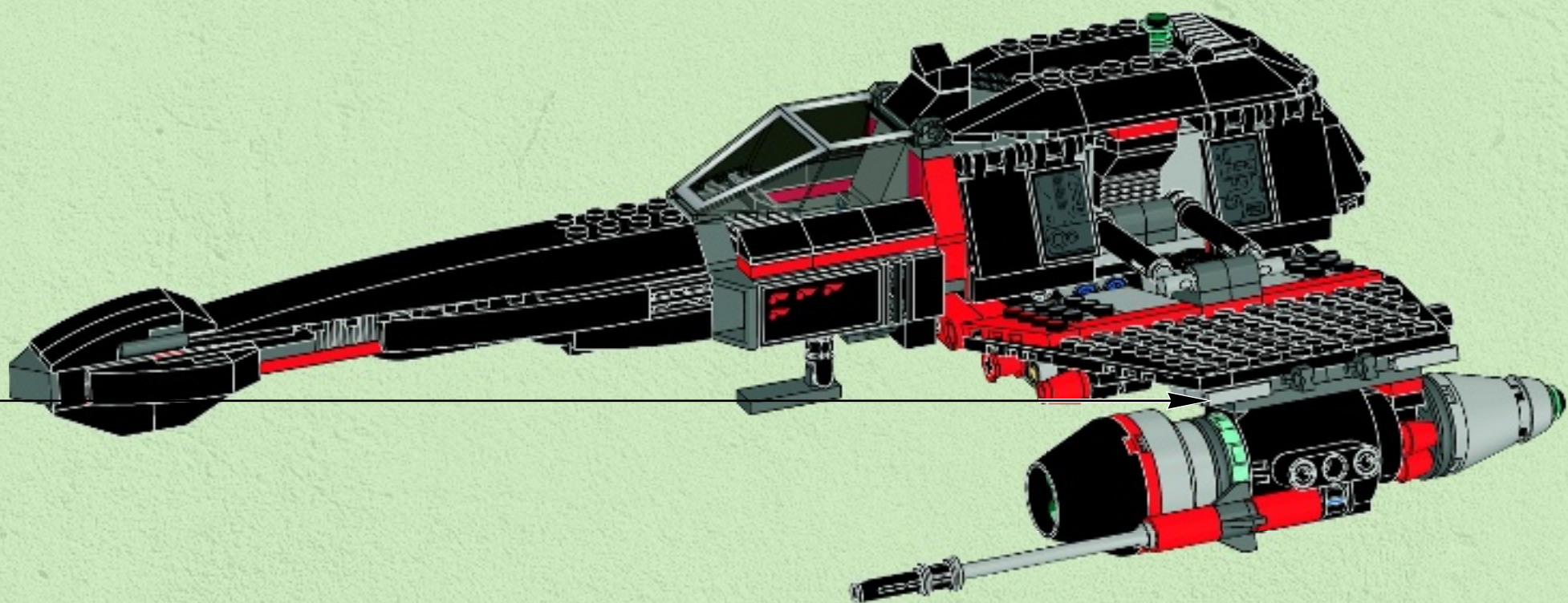

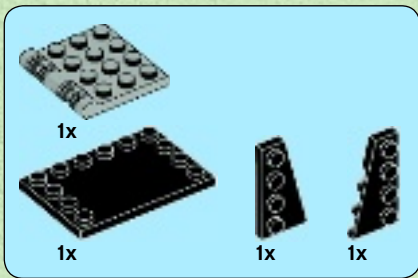

1



2

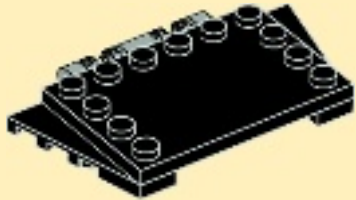

3

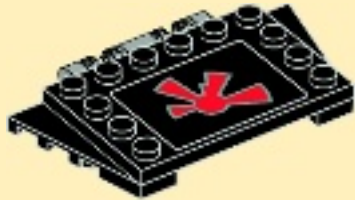

72

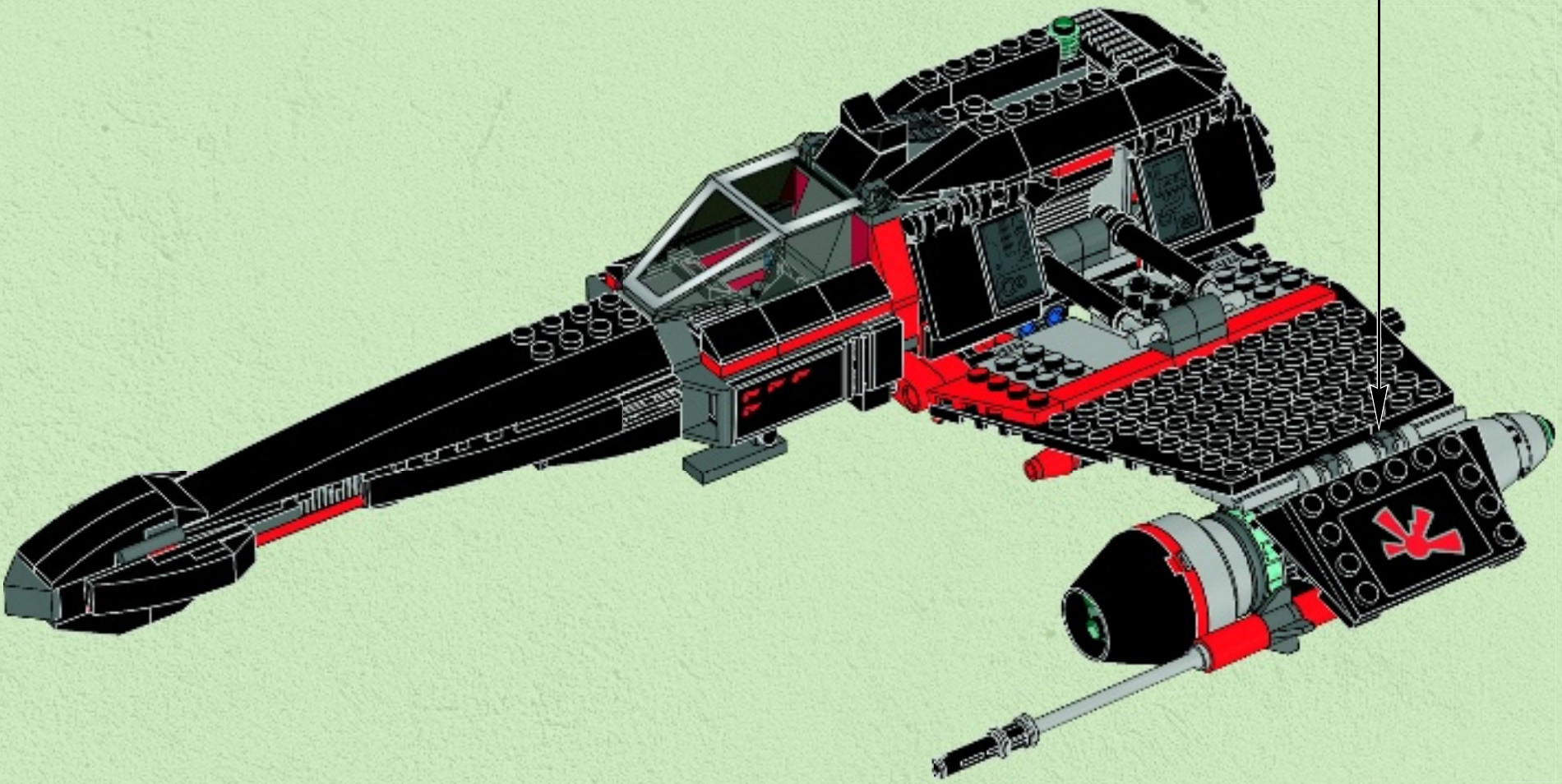

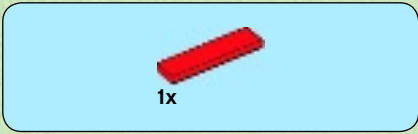
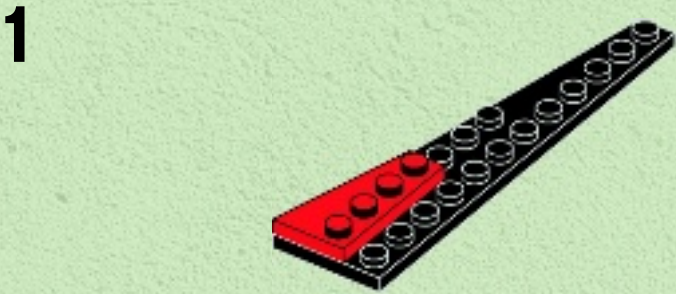
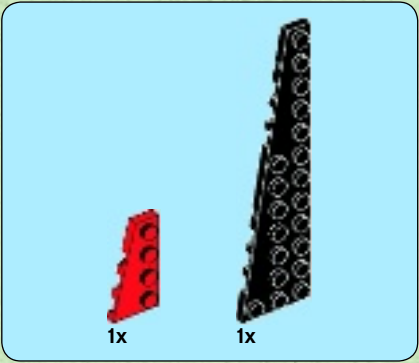
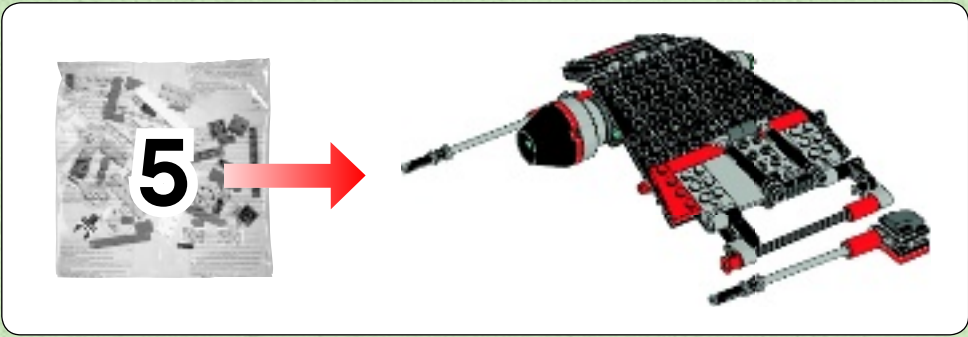

**2**

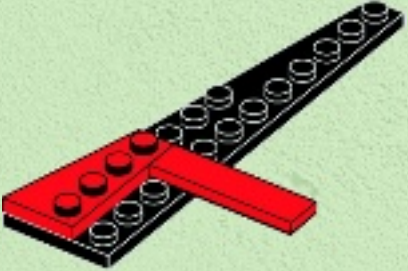

**3**



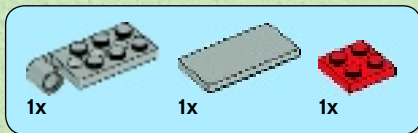

4

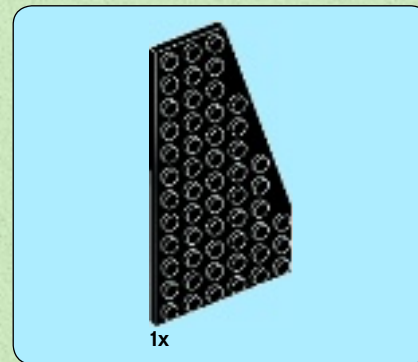
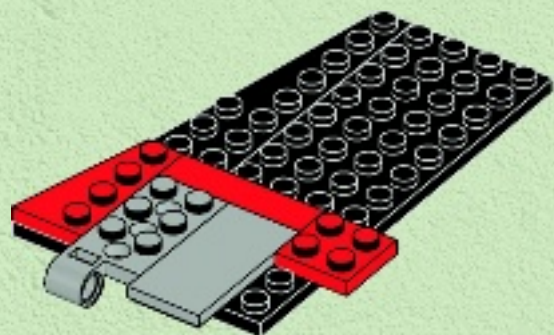

5

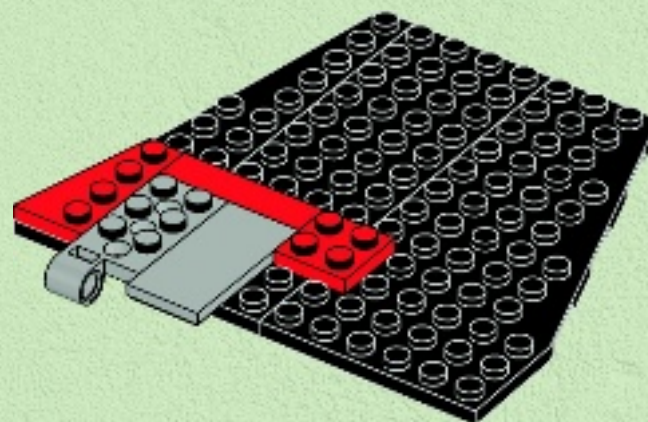

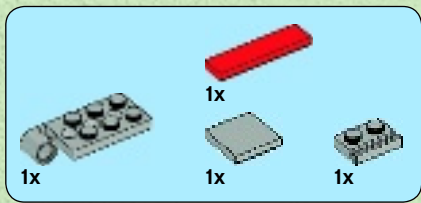

6

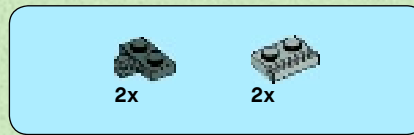
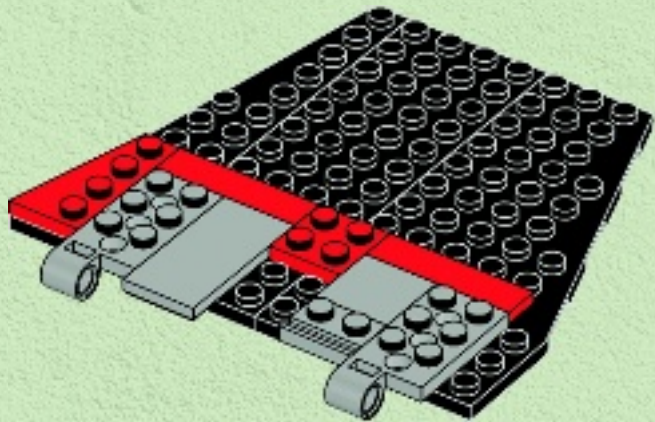

7

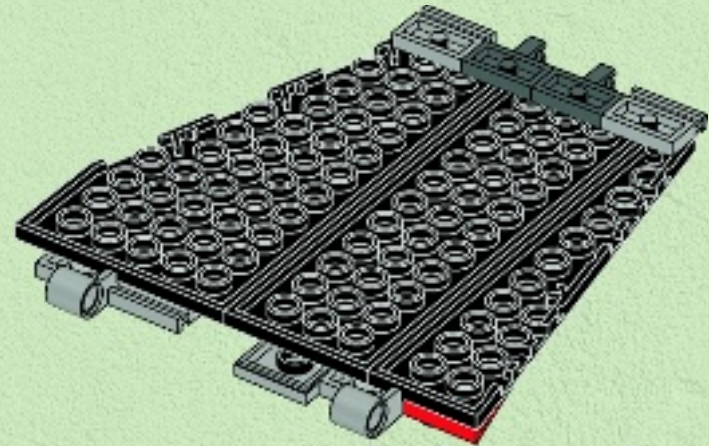
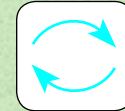



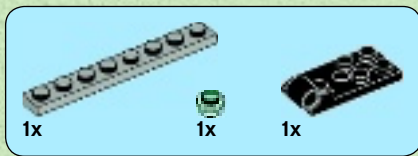

8

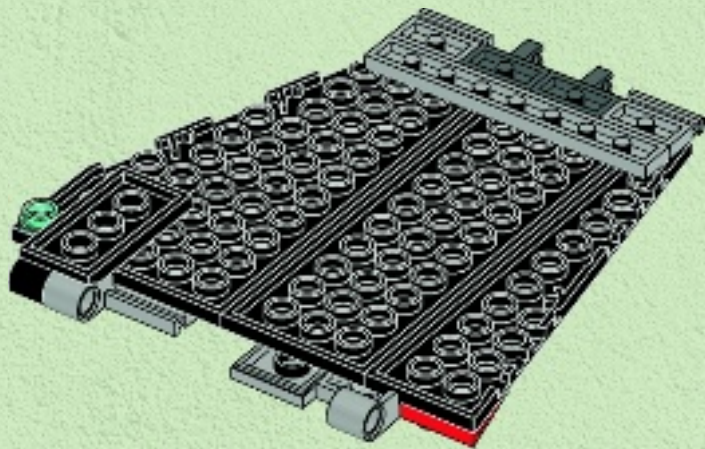

9

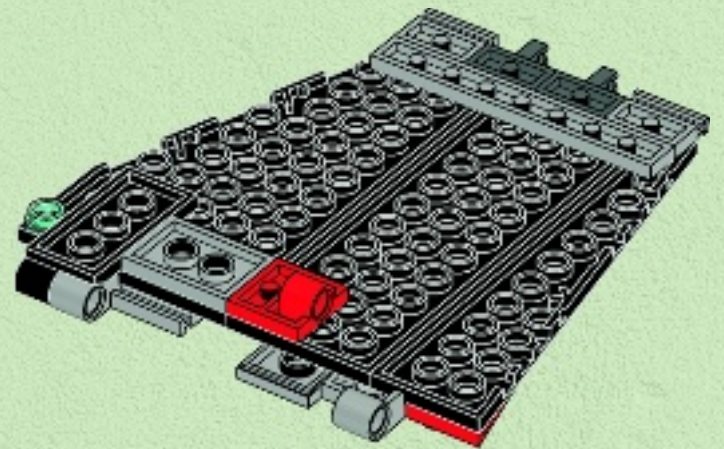



# 10

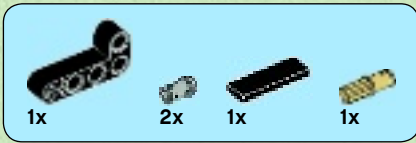
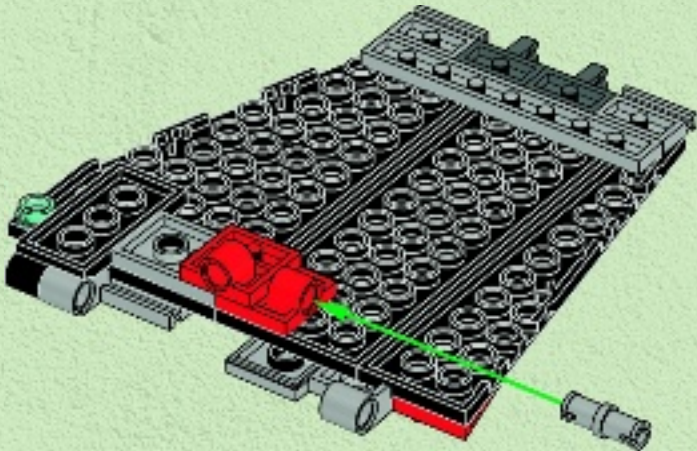

# 11

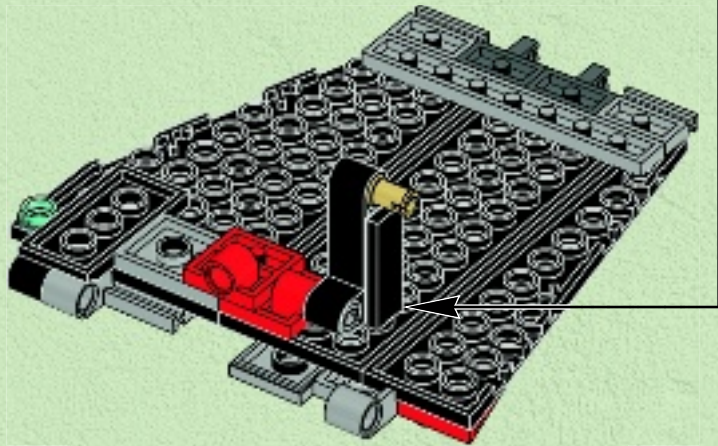
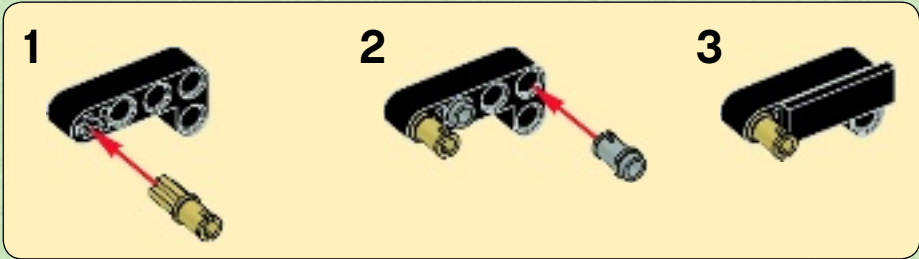

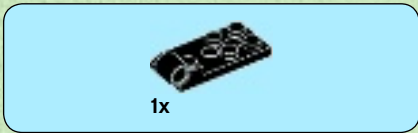

12

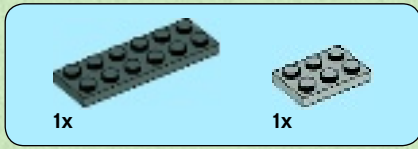
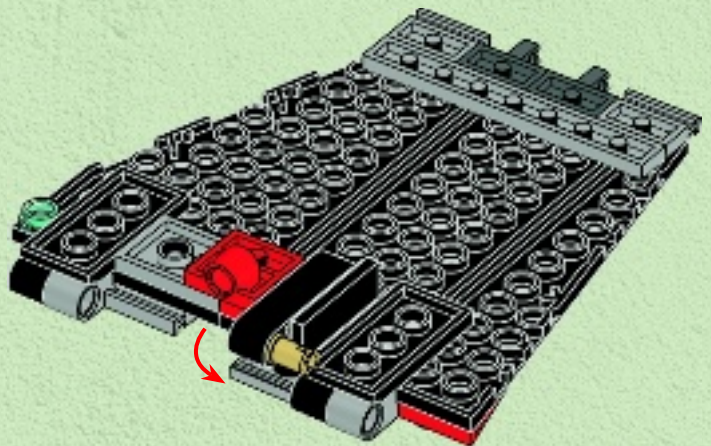

13

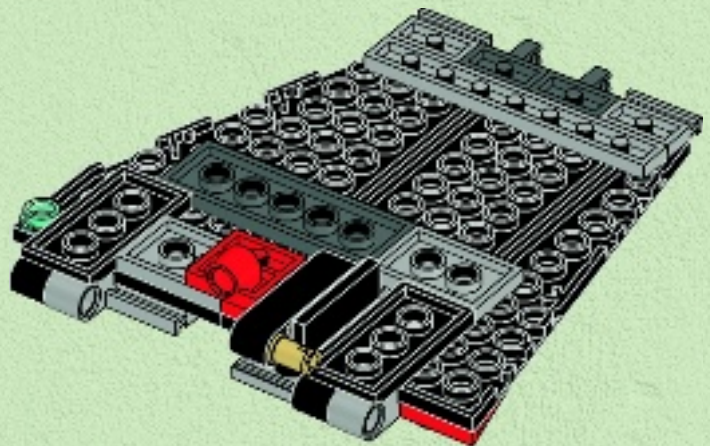



2x

14

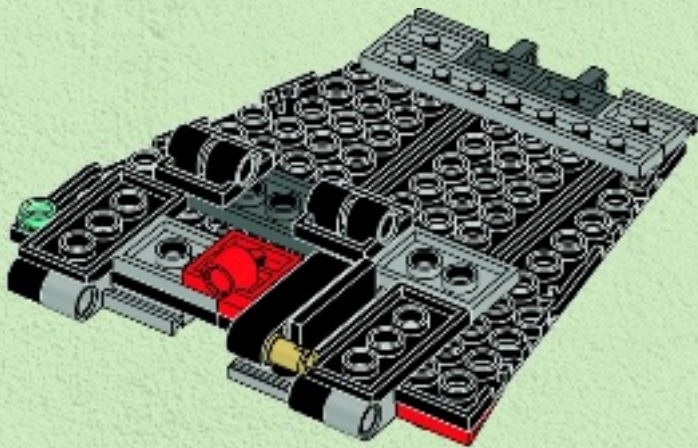

1x



1x

15

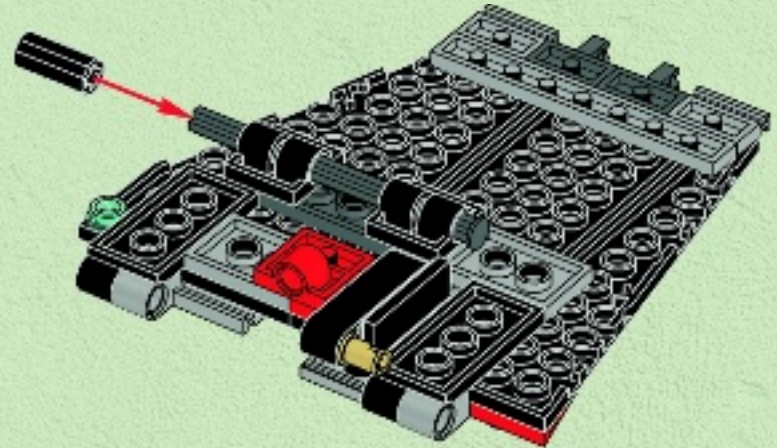



1x

16

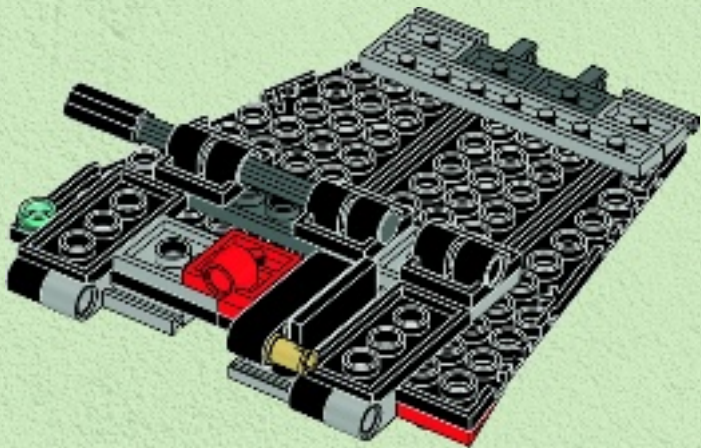

1x



1x

17

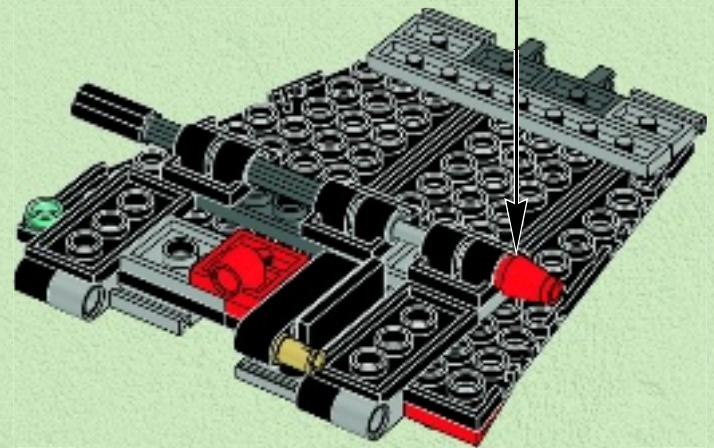
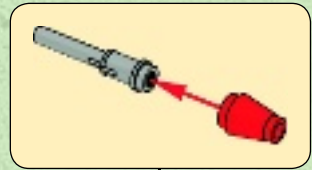

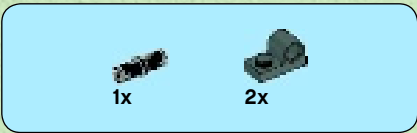

18

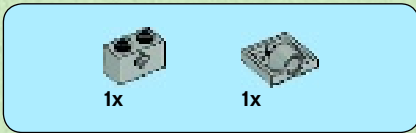
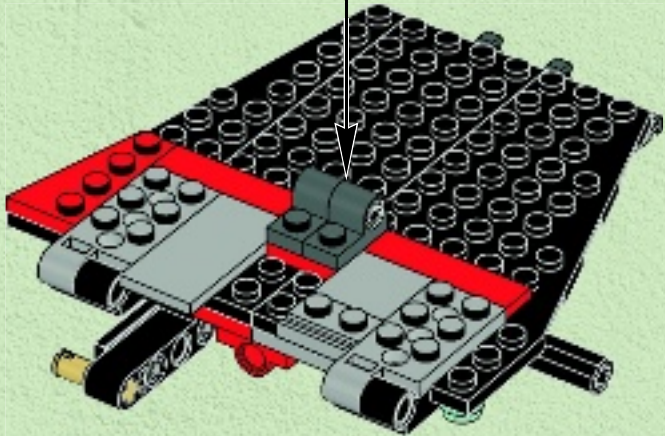
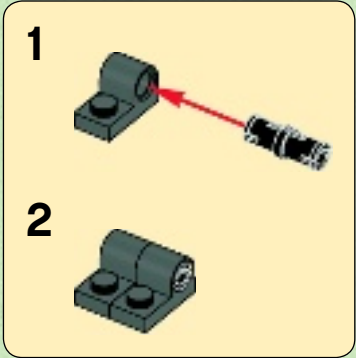

19

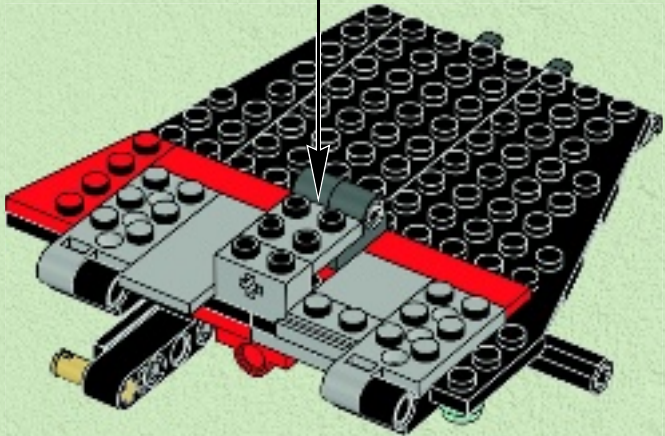

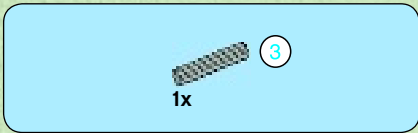

20

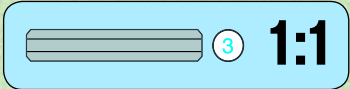
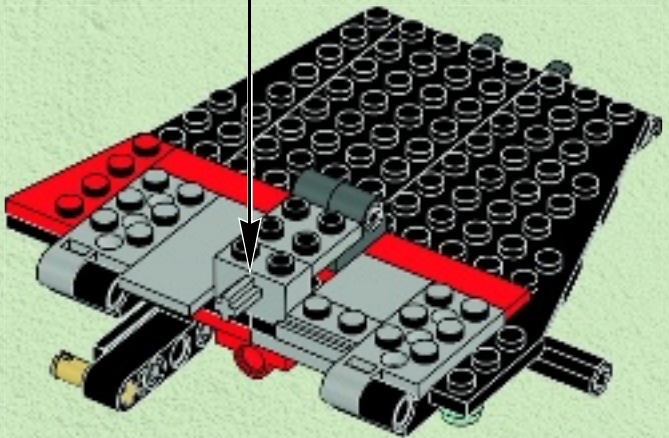
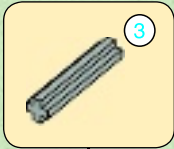

21

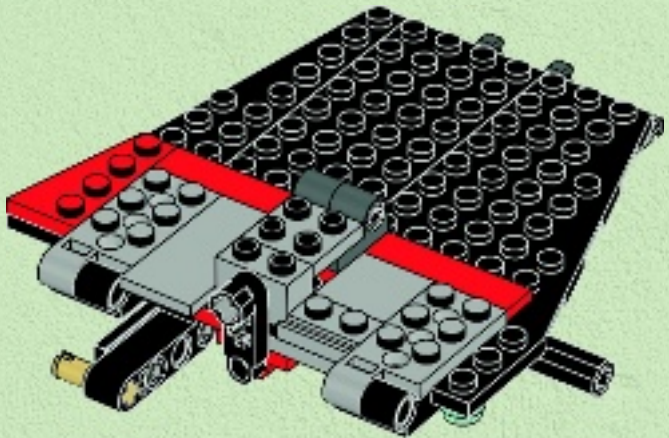

73

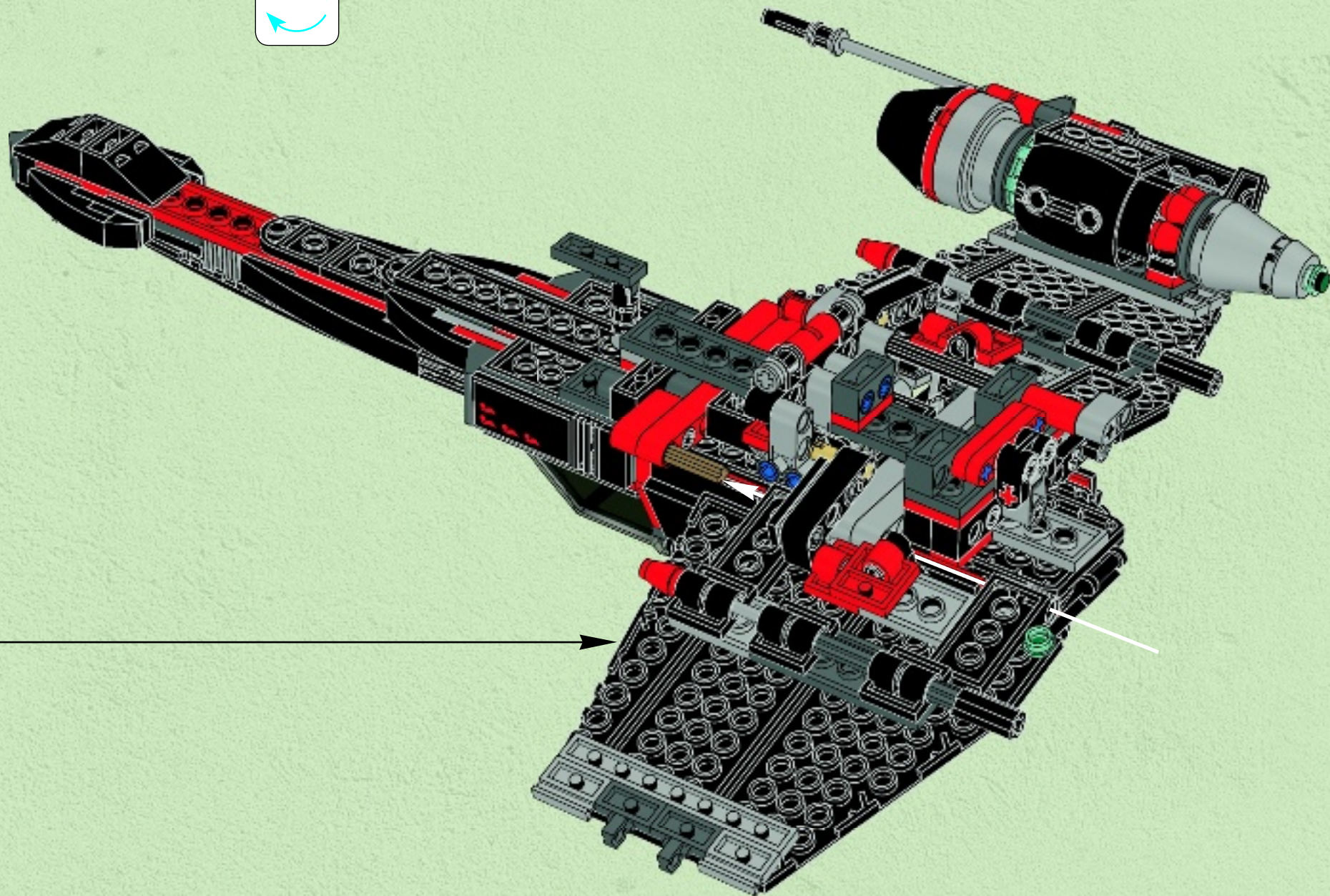
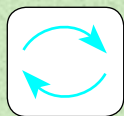





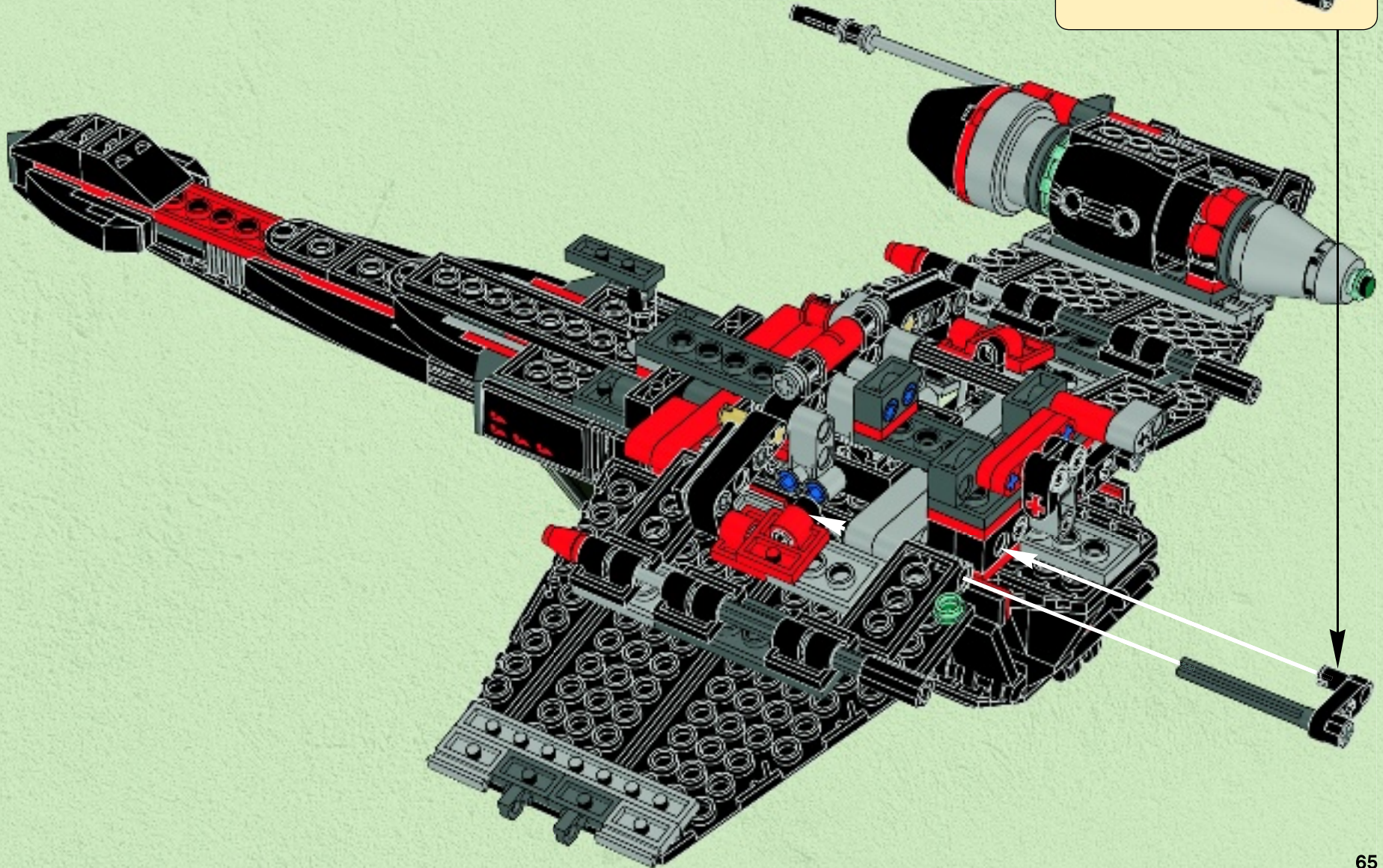
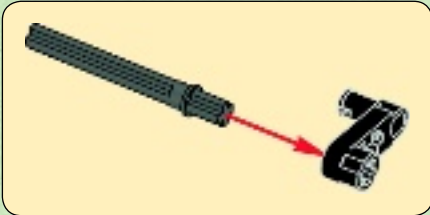

74

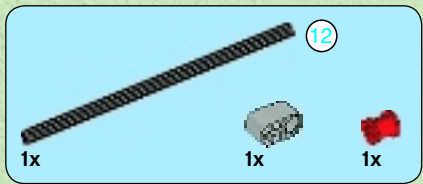

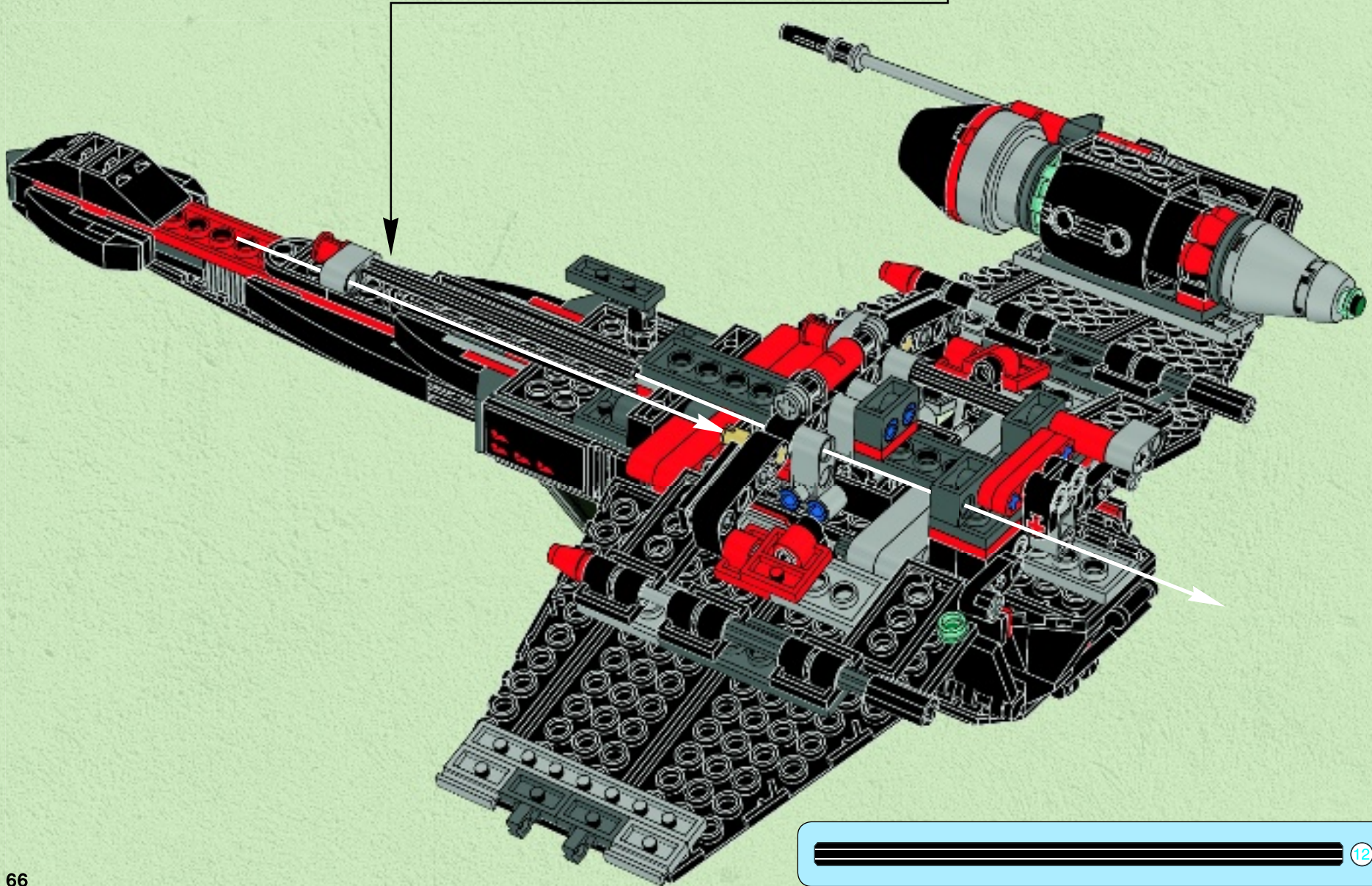
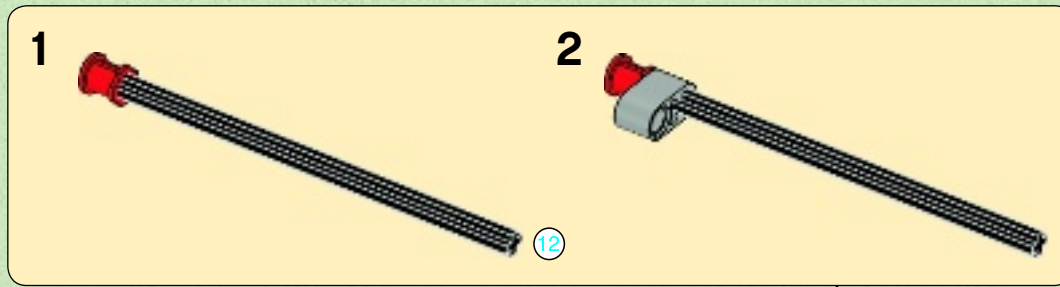

75



1x  1x 

# 76

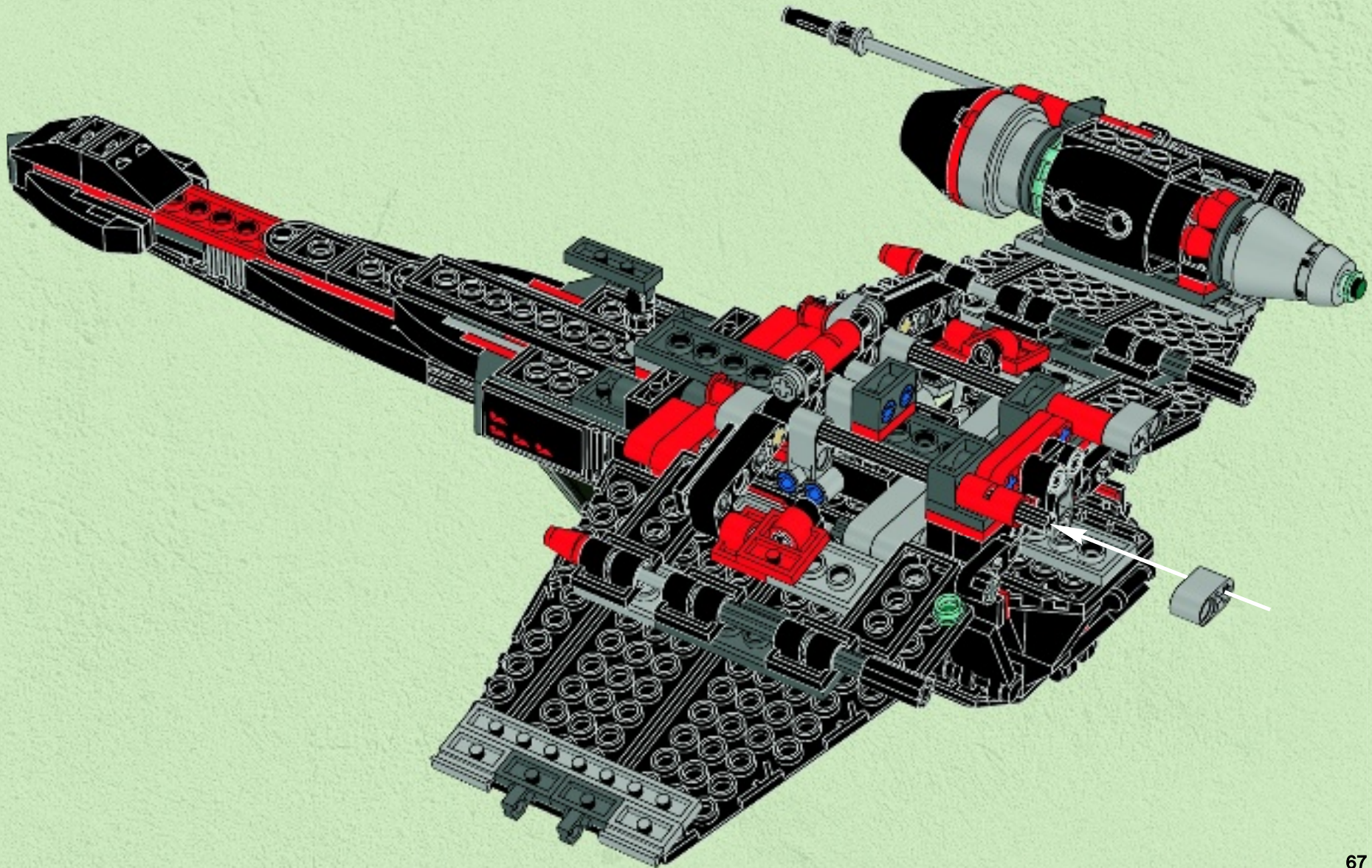

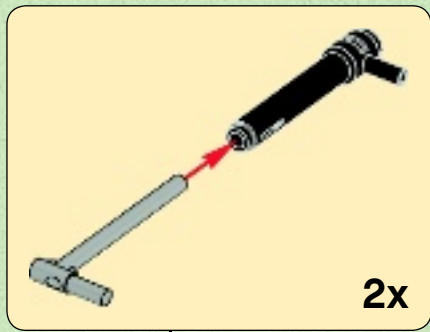
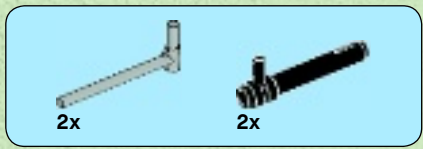

77

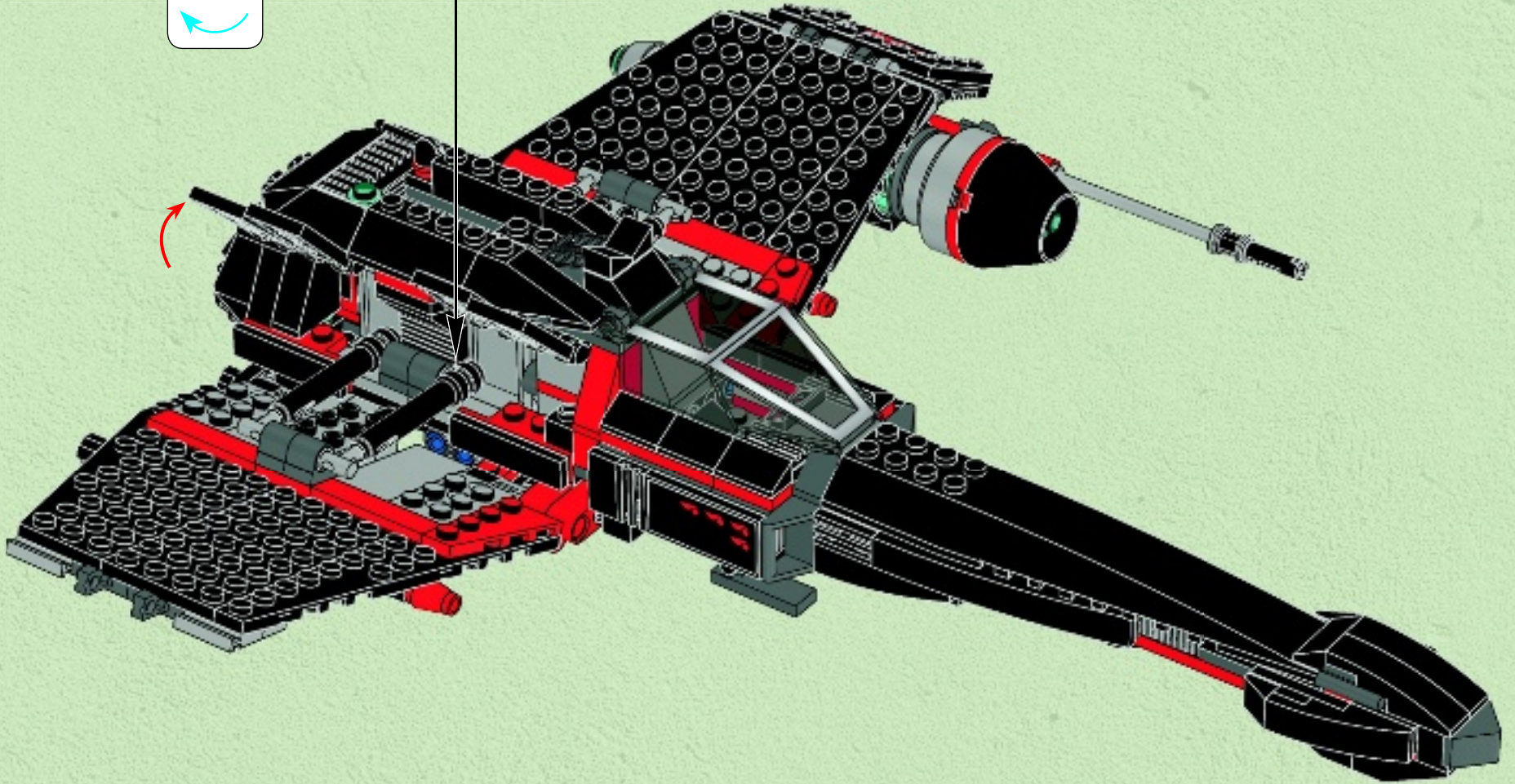

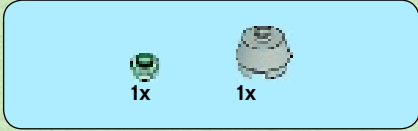
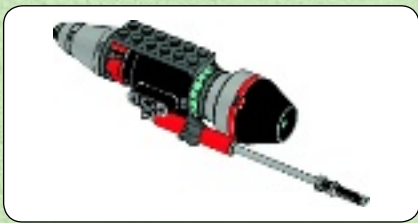

1

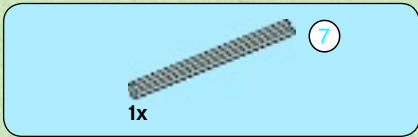

2

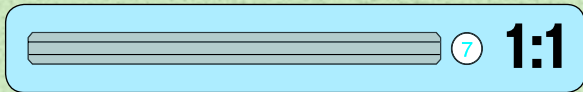
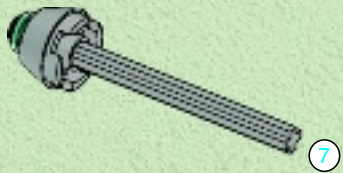
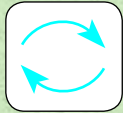

3

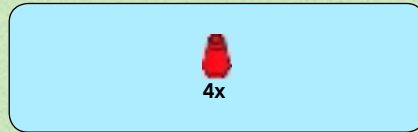
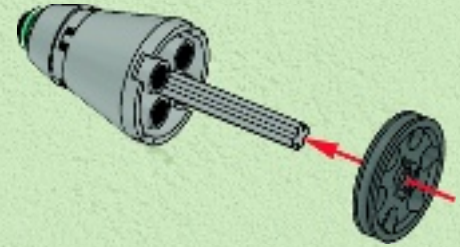

4

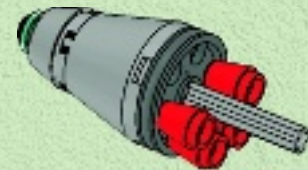



5

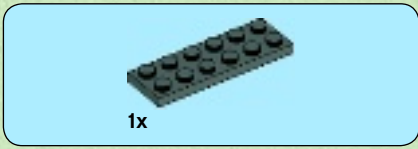
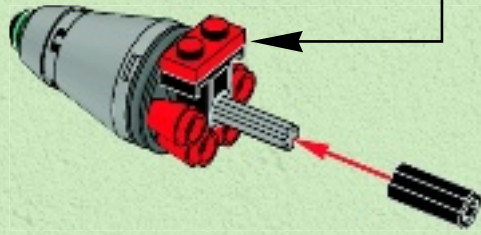

7

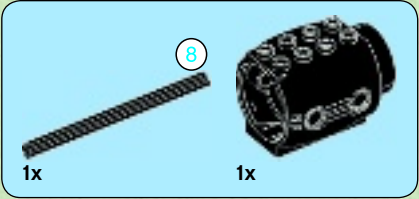
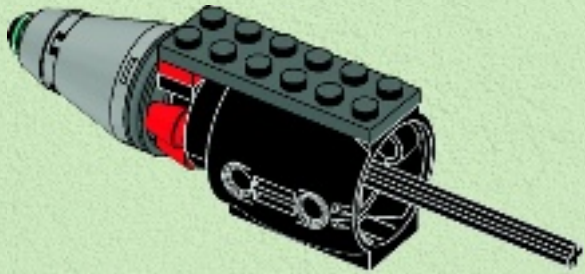

6

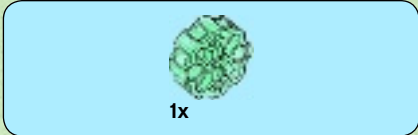
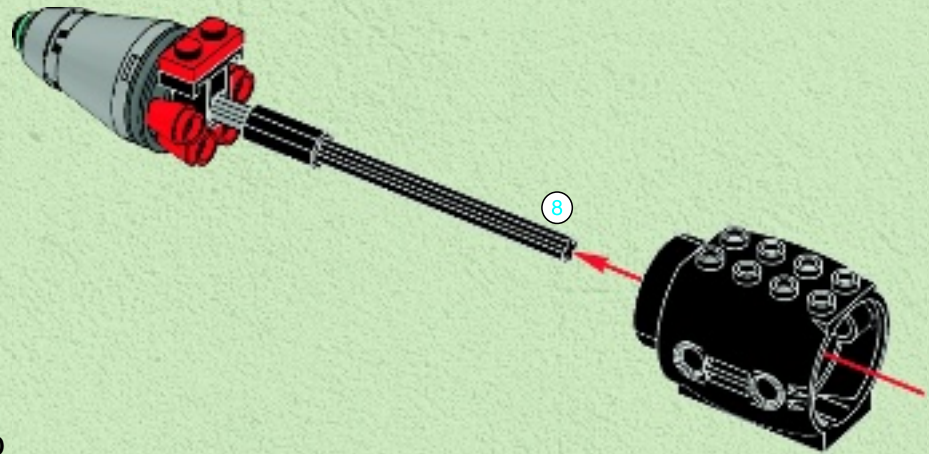

8

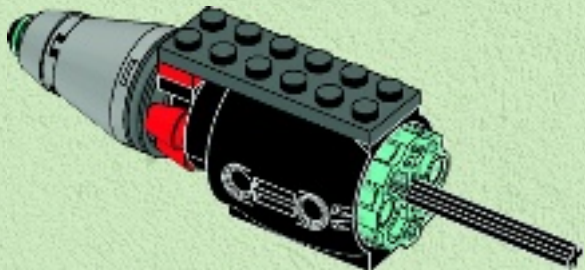

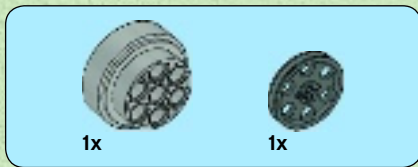

9

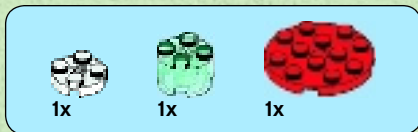
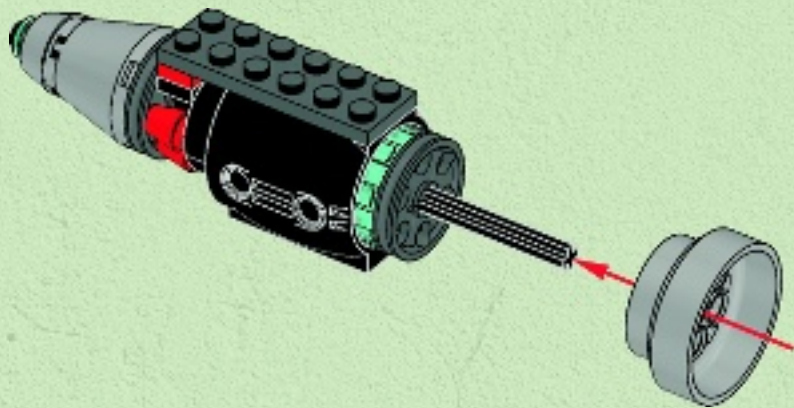

10

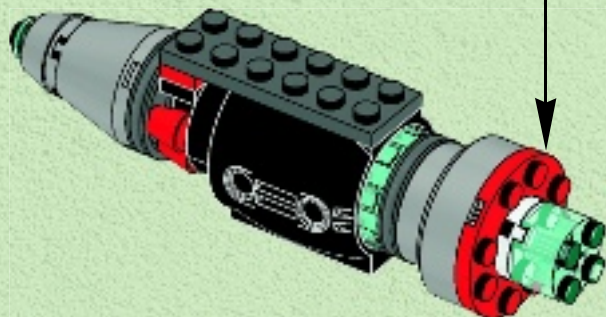

11

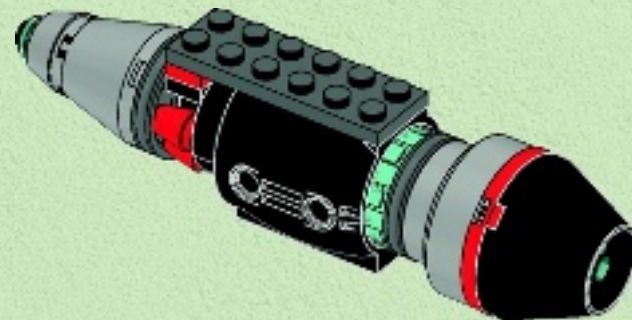

12

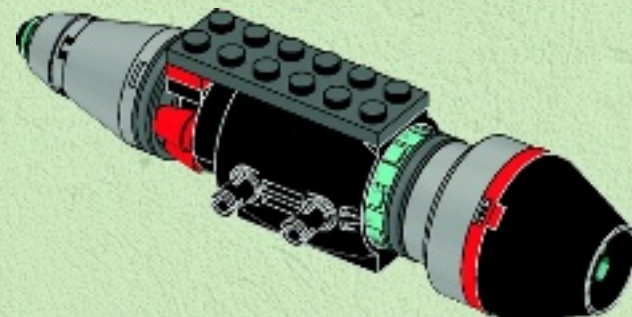



# 13

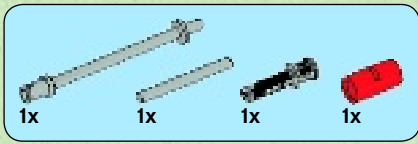
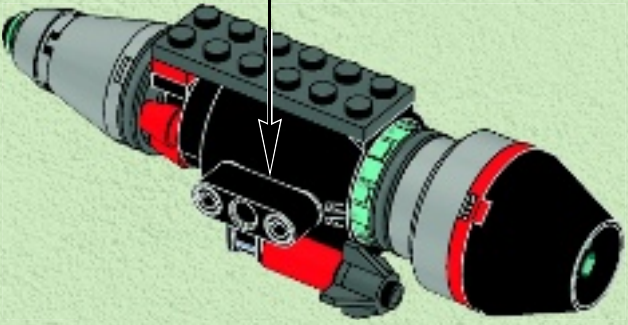
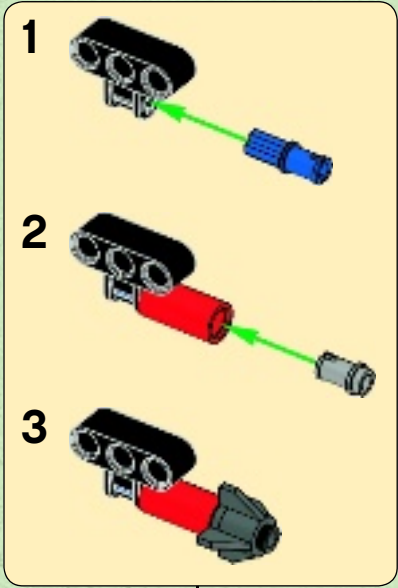

# 14

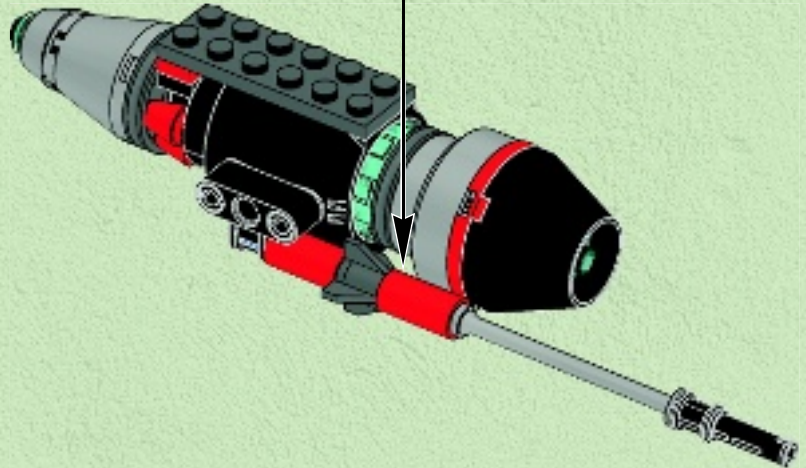
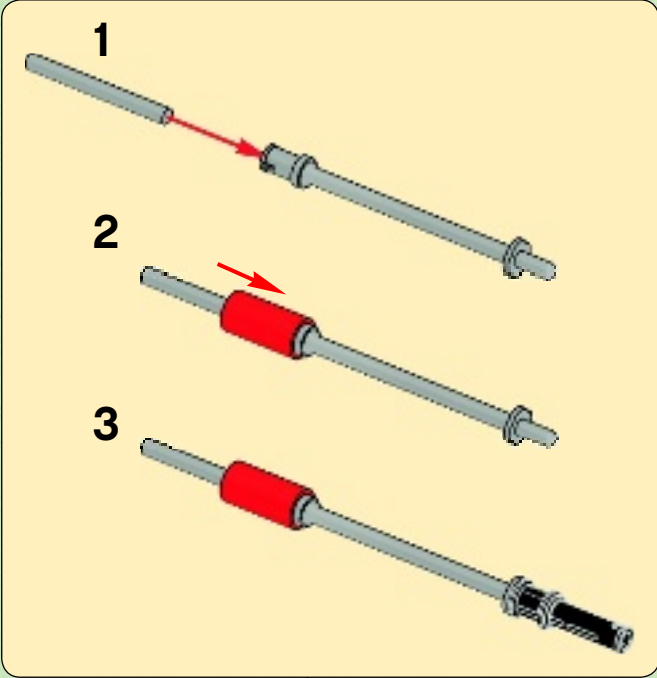



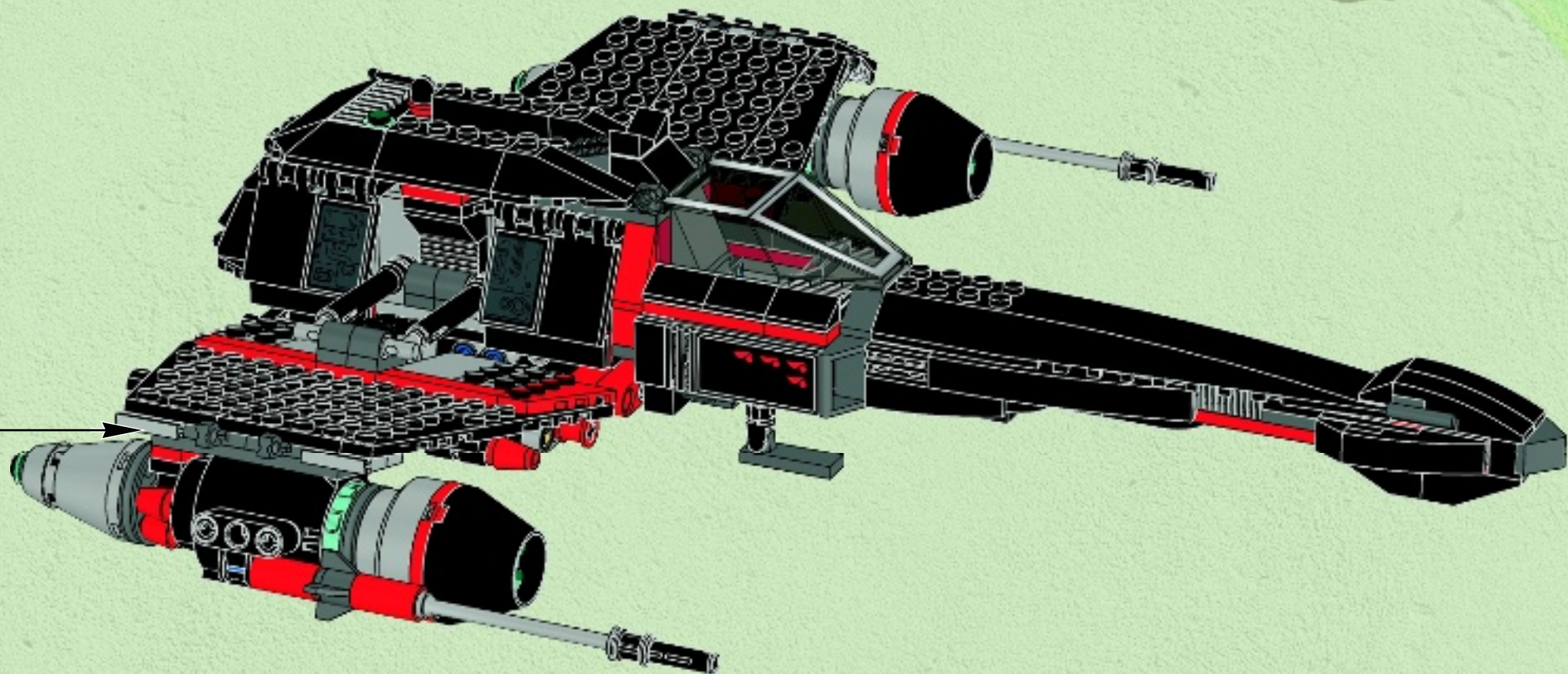

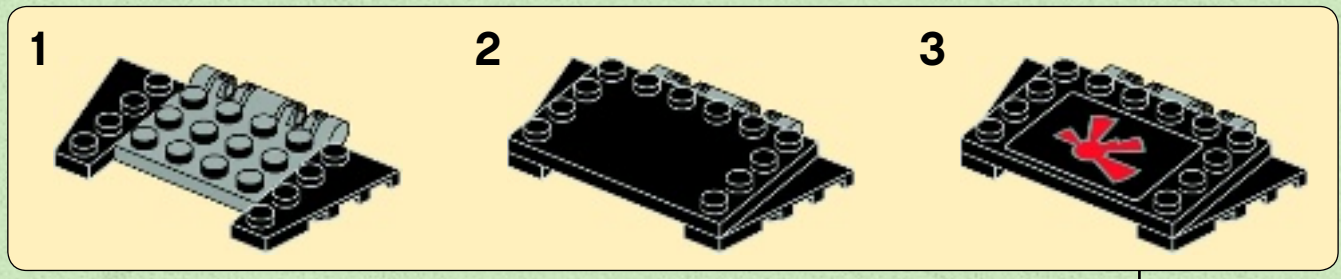
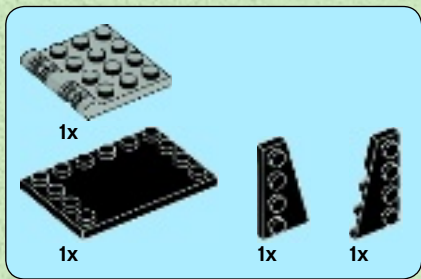

79

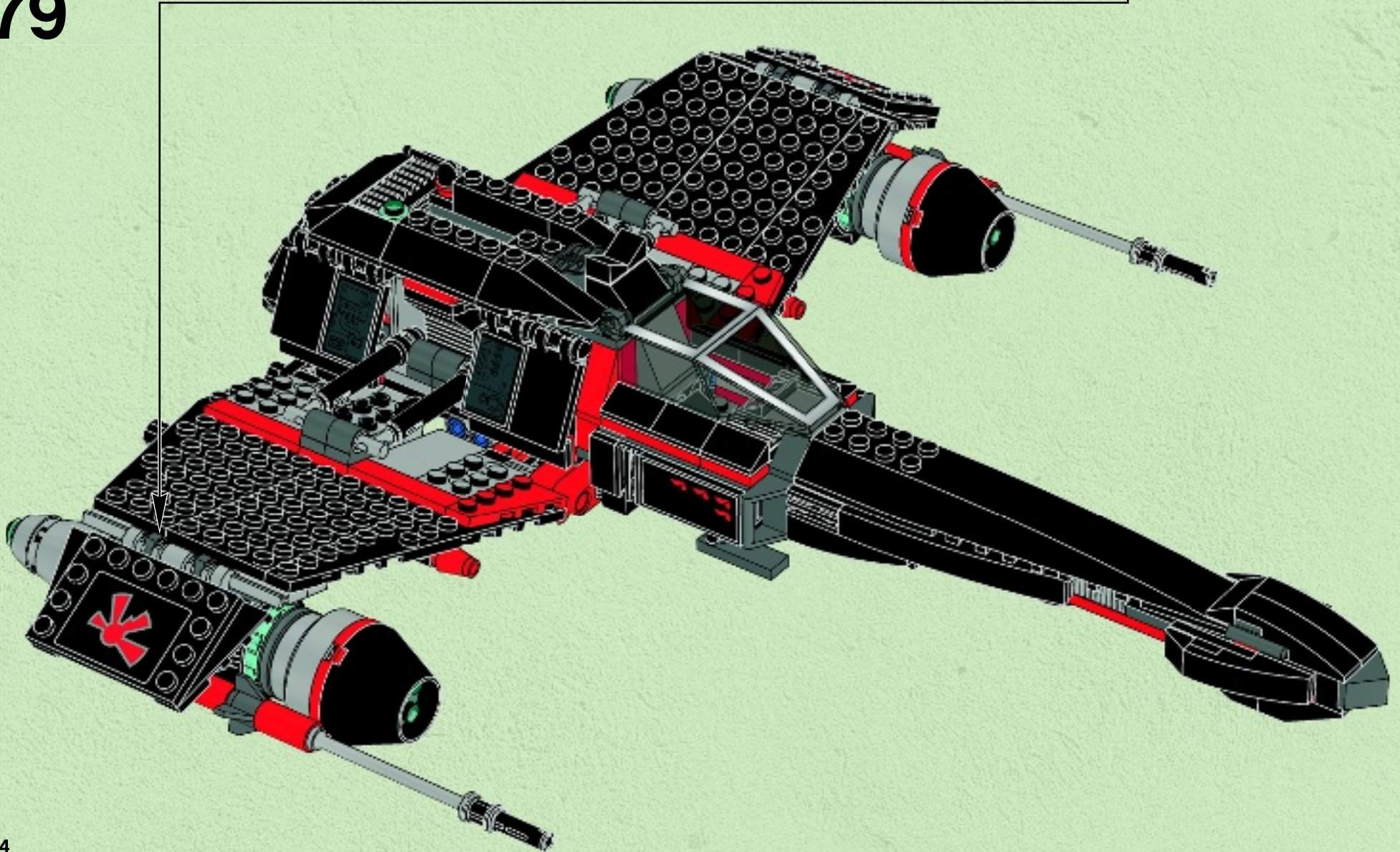

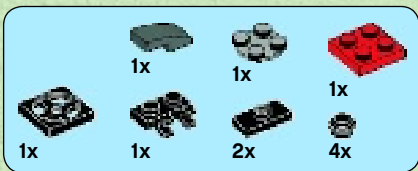

# 80

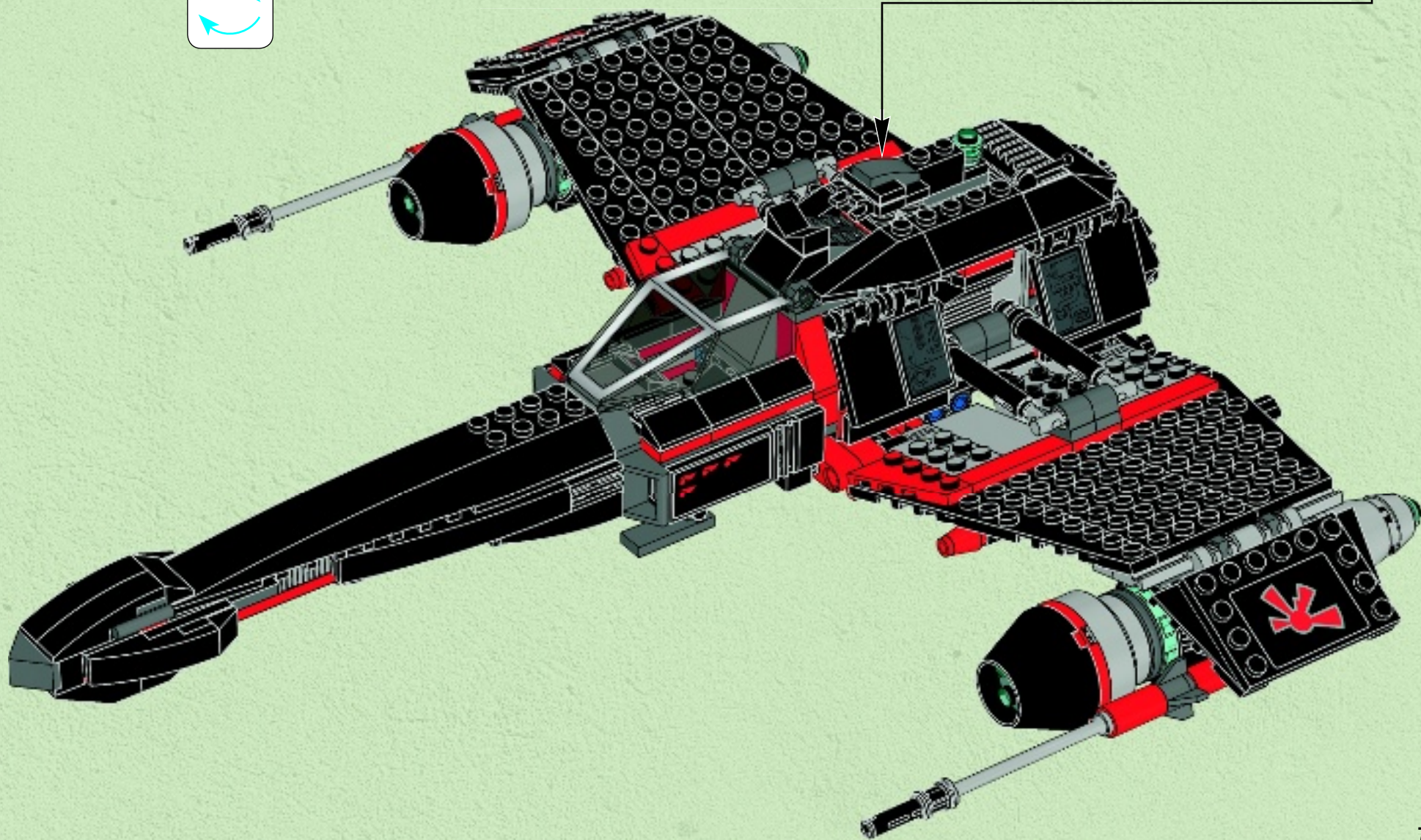
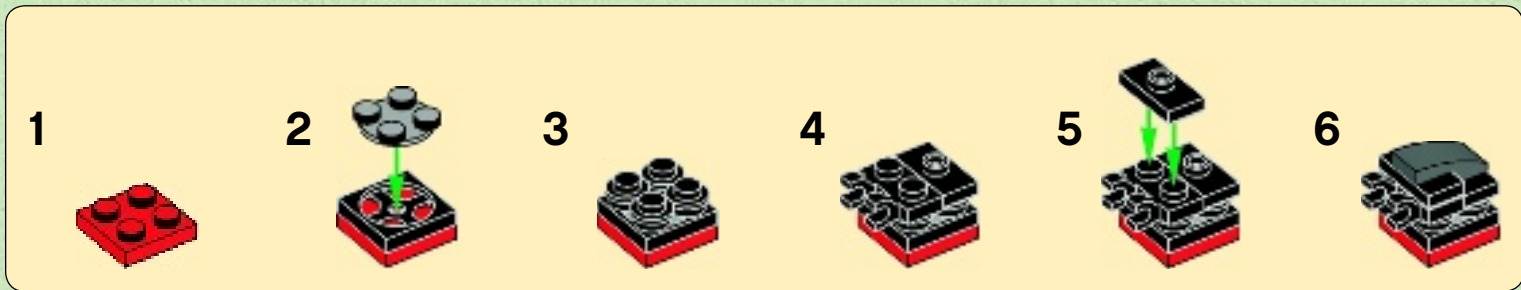

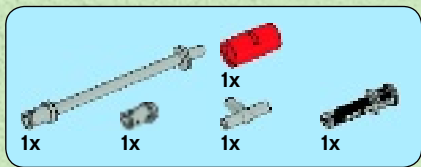

81

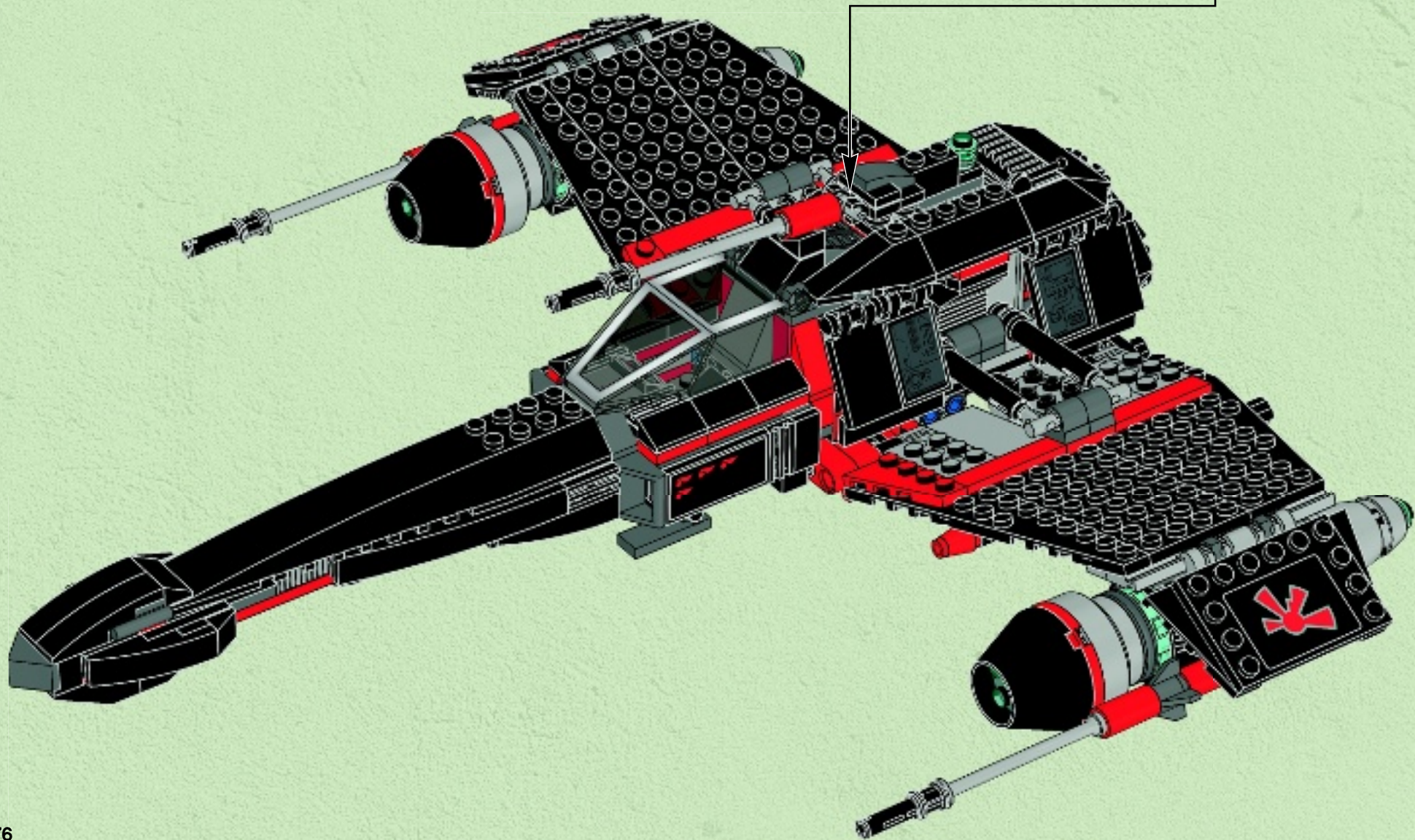
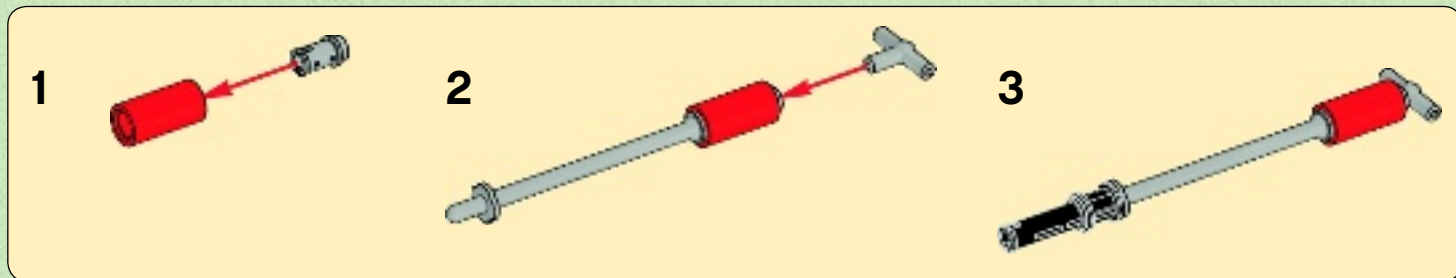

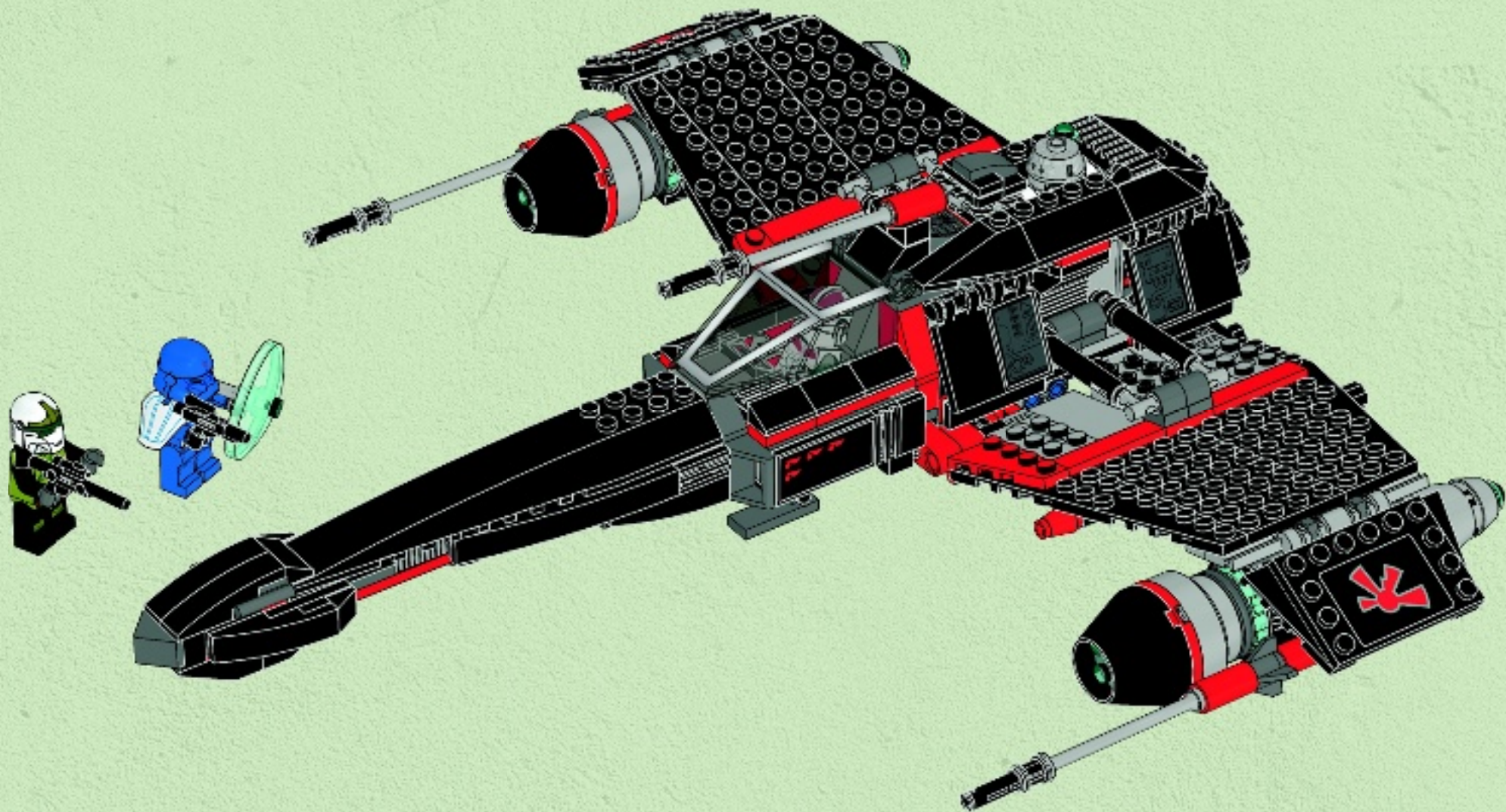



- 1x 6038302
- 1x 6040144
- 2x 403201
- 1x 6040482
- 1x 6046583
- 1x 6040293
- 1x 6040487
- 1x 6040333
- 2x 4124113
- 1x 244501
- 1x 4114306
- 2x 4666579
- 10x 4529234
- 2x 370021
- 2x 4121934
- 2x 4515371
- 2x 6001806
- 4x 6014616
- 6x 4282742
- 6x 243121
- 1x 614121
- 1x 4161329
- 2x 4515348
- 19x 302321
- 10x 302221
- 2x 242021
- 2x 371021
- 2x 366621
- 1x 379521
- 1x 428221
- 1x 4160866
- 2x 4153718
- 1x 4645733
- 2x 4141811
- 2x 4227155
- 1x 4142865
- 8x 4526984
- 1x 6043443
- 1x 6043331
- 1x 6043316
- 4x 4206482
- 15x 4514553
- 2x 407026
- 3x 287726
- 1x 4200486

- 2x 4550922
- 5x 389426
- 1x 4144025
- 4x 4504382
- 9x 4548180
- 2x 4653087
- 6x 4515373
- 2x 366026
- 1x 303926
- 2x 374726
- 2x 303726
- 1x 6040298
- 1x 4160866

- 6x 6037746
- 2x 6037664
- 1x 6040297
- 1x 6031790
- 2x 302426
- 2x 379426
- 2x 302326
- 2x 302226
- 2x 242026
- 2x 362326
- 5x 371026
- 2x 4160869
- 2x 4531412

- 2x 4144023
- 2x 306926
- 11x 241226
- 6x 6016172
- 1x 4556158
- 10x 4225201
- 6x 281726
- 2x 4558170
- 2x 317626
- 4x 243126
- 9x 4297713
- 2x 4560182
- 4x 614126
- 2x 4161332
- 5x 383226
- 2x 302926

- 2x 4100378
- 1x 395826
- 1x 4129572
- 1x 4209003
- 1x 4209013
- 1x 4143181
- 1x 4143180

- 2x 486526
- 1x 243226
- 1x 73587
- 1x 4654944
- 1x 4498713
- 1x 4498712
- 2x 4295395
- 1x 4507820
- 1x 368026
- 1x 4205760
- 4x 6038385
- 4x 4569407
- 2x 4120017
- 4x 6007966
- 1x 4162857
- 4x 4563044
- 22x 4121715
- 4x 4512363
- 3x 4140801
- 2x 370726
- 2x 370826
- 1x 4293877
- 2x 4178398
- 8x 4163917

8

12

- 1x 4124073
- 2x 4654432
- 2x 3000840
- 1x 4266417
- 1x 4654448
- 1x 4499899
- 2x 6031821
- 1x 4211385
- 4x 4211383
- 2x 4233493
- 2x 6028324
- 1x 6040142
- 2x 4497653
- 1x 4211441
- 10x 4211398

- 1x 4565393
- 6x 4211396
- 4x 4599498
- 2x 4211425
- 2x 4211406
- 1x 4515341
- 6x 4211568
- 2x 6045988
- 2x 4211413
- 2x 4560183
- 2x 4211841
- 4x 4585429
- 2x 4211628
- 4x 4565433

- 2x 4511007
- 3x 4211859
- 1x 4540203
- 4x 4646513
- 2x 4520320
- 2x 4211866
- 1x 4211775
- 4x 4211714
- 4x 6004888
- 2x 4211573
- 7x 4211483
- 2x 4211807
- 2x 4211815
- 2x 4211639
- 1x 4211639
- 2x 4211805
- 2x 4211508

3

5



7

- 8x 6019987
- 3x 4210762
- 1x 4226221
- 2x 4621917
- 1x 4234534
- 1x 6029948
- 11x 4211065
- 2x 4211056
- 12x 4211002
- 4x 4210892
- 2x 4210726
- 2x 6048854
- 2x 6000606
- 2x 4196768
- 1x 4211055

- 1x 4210882
- 2x 4648067
- 1x 4263176
- 2x 4211039
- 2x 4212352
- 2x 4540386
- 2x 4552349
- 4x 4587275
- 2x 4508553
- 2x 4499858
- 1x 6021888
- 1x 6040153
- 1x 6005531
- 1x 6043456
- 1x 6040469



**Customer Service**  
**Kundenservice**  
**Service Consommateurs**  
**Servicio Al Consumidor**  
**LEGO.com/service or dial**

00800 5346 5555 :          

1-800-422-5346 :  



75016



75017



75018



75019



75020



75015



75021



75022





 [LEGO.com/starwars](https://www.LEGO.com/starwars)



Internet Connection Required  
Connexion Internet requise  
Se requiere conexión a Internet

**LEGO.com/starwars**



# WIN!



Go to [www.LEGOsurvey.com/product](http://www.LEGOsurvey.com/product) to fill out a survey for a chance to win a cool LEGO® Product. No purchase necessary. Open to all residents where not prohibited.

 [LEGO.com](http://LEGO.com)

## [www.LEGOsurvey.com/product](http://www.LEGOsurvey.com/product)

### GEWINNE!

Nimm an der Umfrage auf [www.LEGOsurvey.com/product](http://www.LEGOsurvey.com/product) teil und hab die Chance ein cooles LEGO® Produkt zu gewinnen! Die Teilnahme am Gewinnspiel führt zu keinerlei Kaufverpflichtungen. Teilnahme in allen nicht ausgeschlossenen Ländern möglich.

### WIN!

Ga naar [www.LEGOsurvey.com/product](http://www.LEGOsurvey.com/product), vul een enquêteformulier in en maak kans op een cool LEGO® product. Geen aankoopverplichting. Iedereen mag deelnemen, uitgezonderd ingezetenden van landen waar een enquêteverbod geldt.

### GAGNE!

Visite [www.LEGOsurvey.com/product](http://www.LEGOsurvey.com/product) pour répondre à un questionnaire et avoir une chance de gagner un produit LEGO® très cool ! Aucune obligation d'achat. Ouvert à tous les résidents des pays autorisés.

### 当てよう!

[www.LEGOsurvey.com/product](http://www.LEGOsurvey.com/product) にアクセスして、アンケートにご記入ください。当選者にはレゴ製品を差し上げます。お買い上げの必要はありません。禁止されていない限り、すべての皆様にご利用いただけます。