



# NINJAGO

71782





### **Get excited about our new packaging!**

We're switching from plastic to paper-based packaging. That's why you might find a mix of paper and plastic in our boxes!

### **Nos nouveaux emballages vous emballeront !**

Nous passons des emballages en plastique aux emballages à base de papier. C'est pourquoi vous pourriez trouver un mélange de papier et de plastique dans nos boîtes !

### **¡Te presentamos nuestros nuevos empaques!**

Estamos sustituyendo las bolsas de plástico por bolsas con base de papel. ¡Por eso, puedes encontrar una mezcla de papel y de plástico en nuestras cajas!

**[LEGO.com/sustainable-packaging](https://www.lego.com/sustainable-packaging)**



# BUILDER



Apple and the Apple logo are trademarks of Apple Inc., registered in the U.S. and other countries and regions. App Store is a service mark of Apple Inc. Google Play and the Google Play logo are trademarks of Google LLC. Tencent and the Tencent logo are trademarks of Tencent Inc.

[LEGO.com/devicecheck](https://www.lego.com/devicecheck)

**EN** Ask parents' permission before going online | **DE** Eltern um Erlaubnis bitten, bevor du online gehst | **FR** Demande l'autorisation d'un parent avant d'aller en ligne | **IT** Chiedi il permesso ai tuoi genitori prima di andare online | **ES** Pídeles permiso a tus papás antes de conectarte a Internet | **PT** Pede autorização aos pais antes de acederes online | **JA** オンラインになる前に ほか者の方のきよかをもらおう | **ZH** 上网前应先征得父母的同意 | **KO** 온라인 접속 전에 보호자 동의가 필요합니다 | **RU** Спроси разрешения у родителей, прежде чем заходить в интернет | **PL** Poproś rodziców o zgodę, zanim wejdiesz do Internetu | **CS** Než půjdeš na internet, požádej rodiče o svolení | **SK** Skôr než pôjdeš na internet, vypýtaj si povolenie od rodičov | **HU** Kérj szülői engedélyt, mielőtt online csatlakoznál! | **RO** Cere permisiunea părinților înainte de a te conecta online | **BG** Поискайте разрешение от родител, преди да влезете онлайн | **LV** Pirms došanās tiešsaistē palūdz atļauju vecākiem | **ET** Enne Interneti kasutamist küsi vanematelt luba | **LT** Prieš prisijungdami prie interneto, atsklauskite tėvų

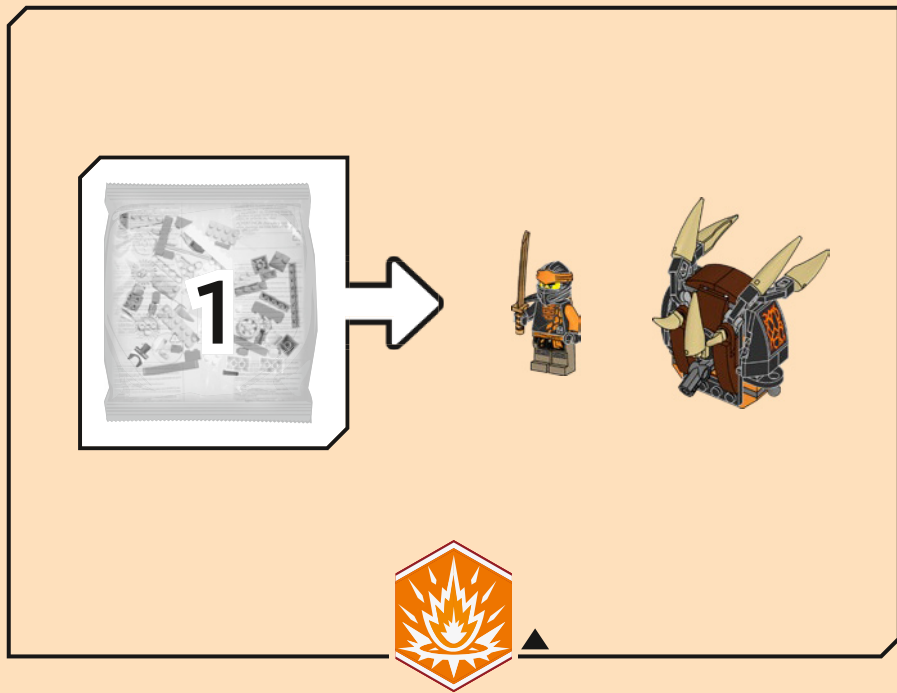

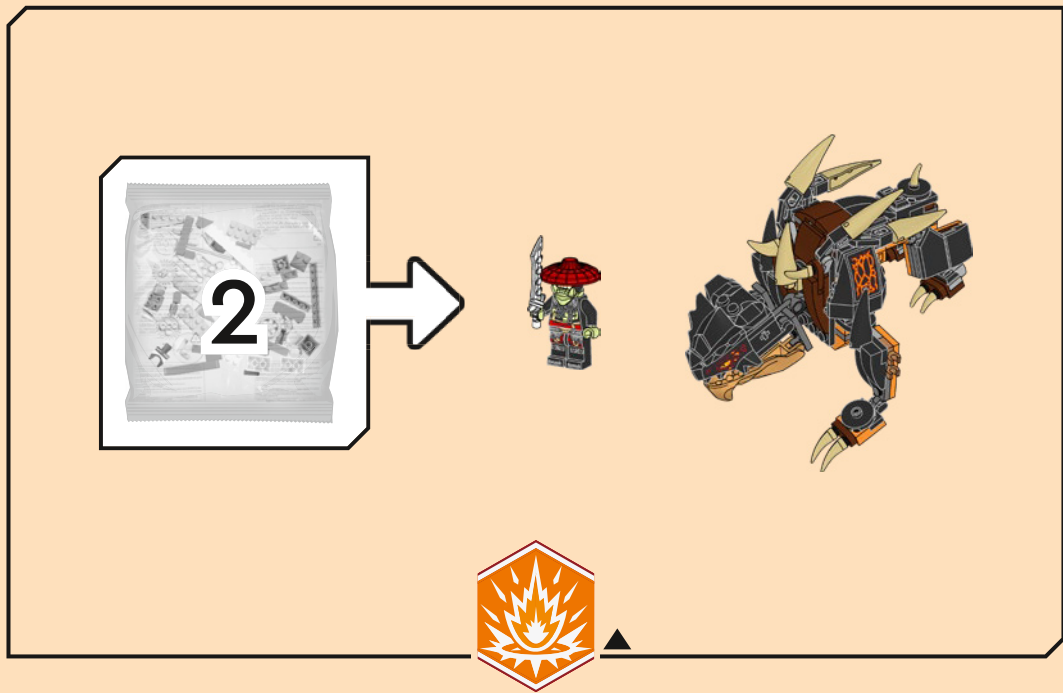

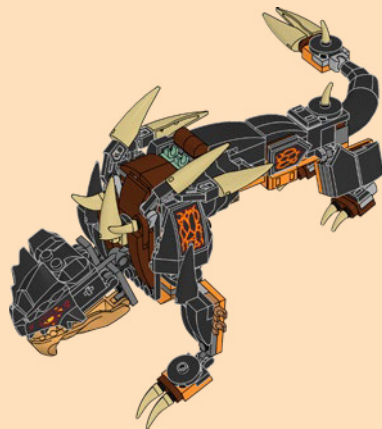
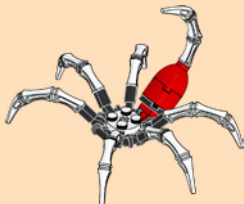
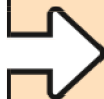



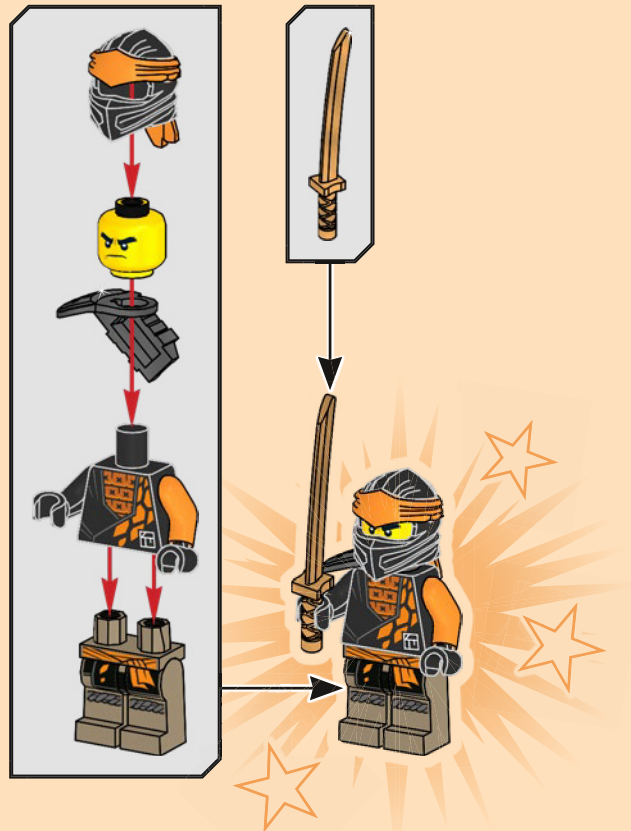







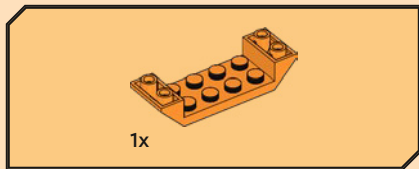

1

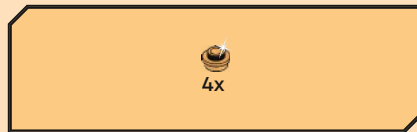
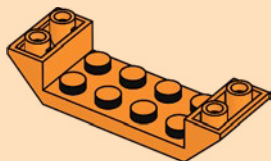

2

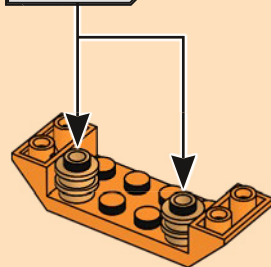
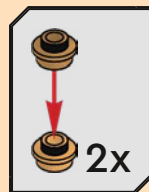

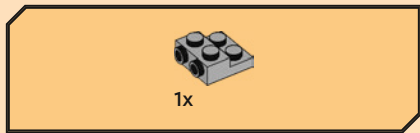

3

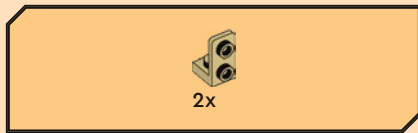
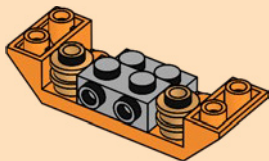

4

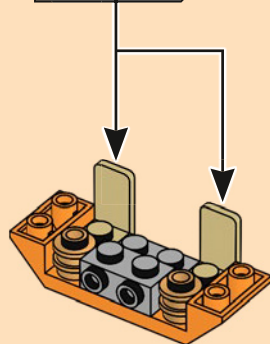

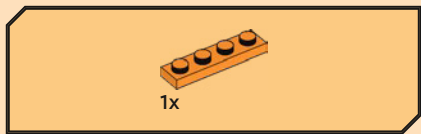

5

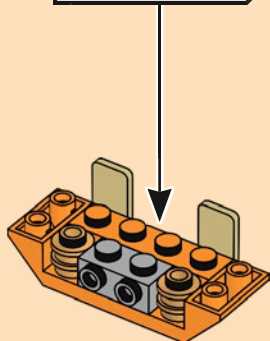
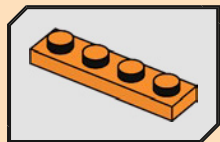

6

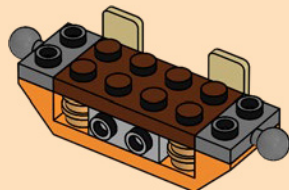

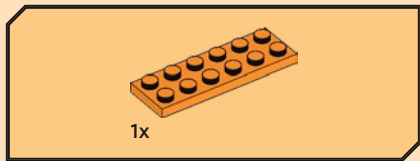

7

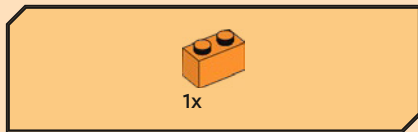
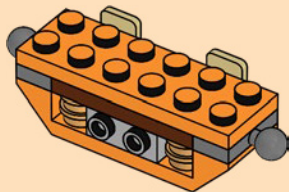

8

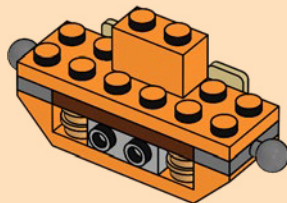

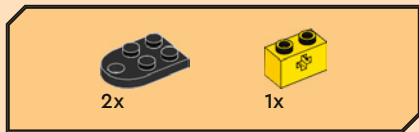

9

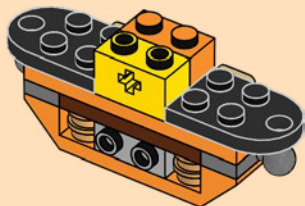

10

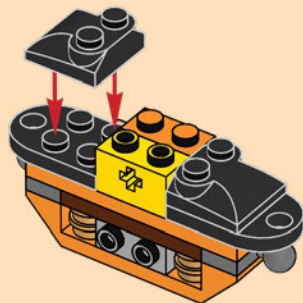

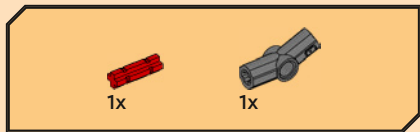

11

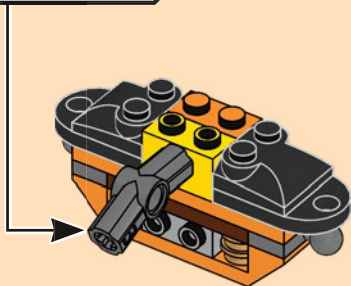
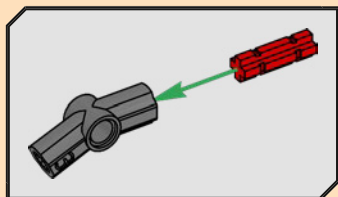

12

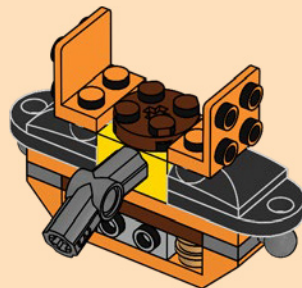



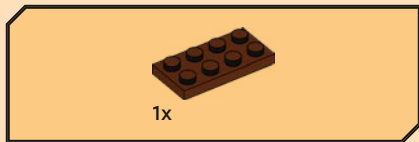

13

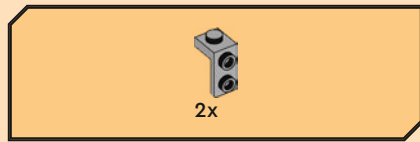
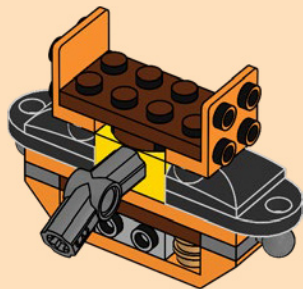

14

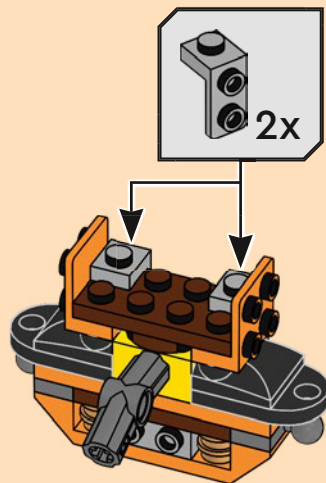

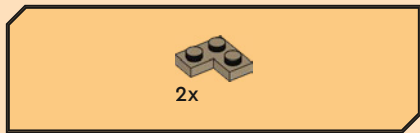

15

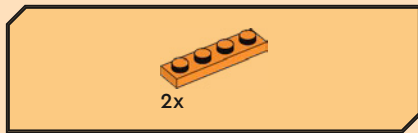
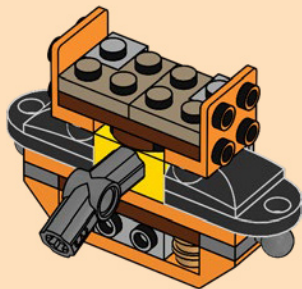

16

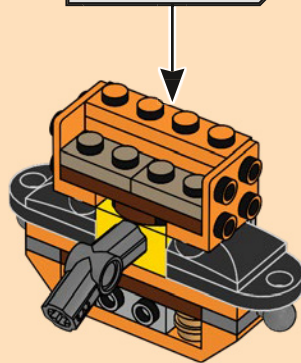
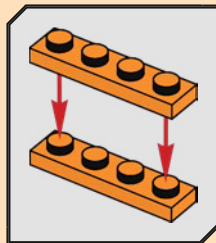



17

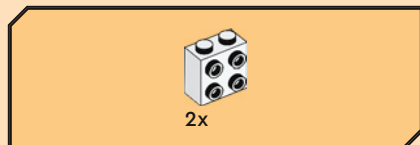
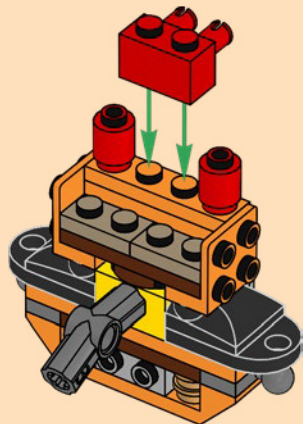

18



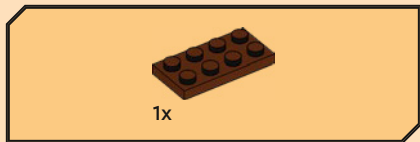

19

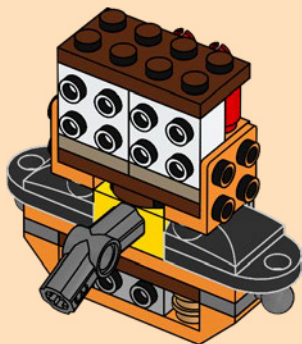

20

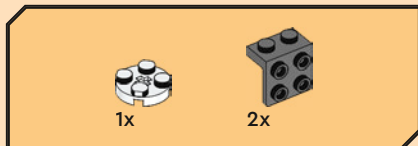

20

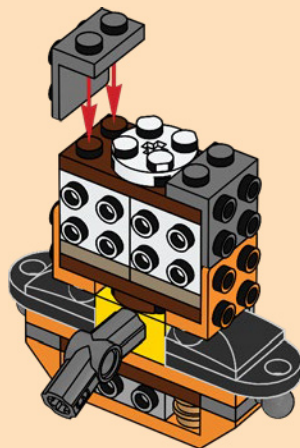



21

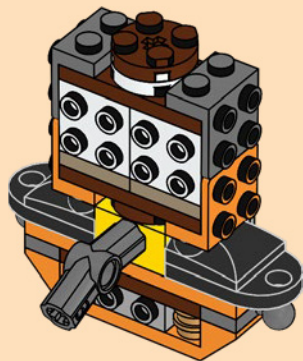

22

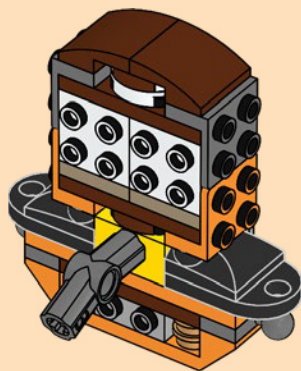

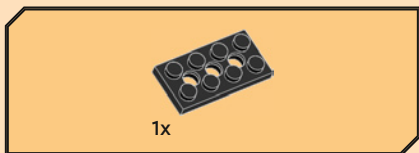

23



22

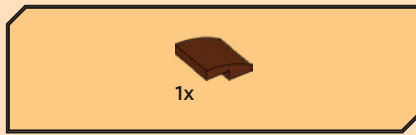

24

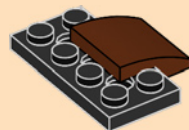



25

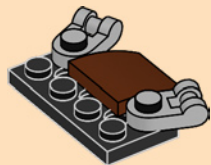

26



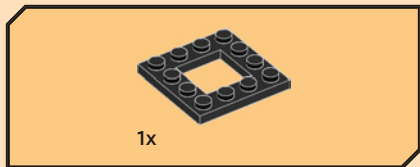

27

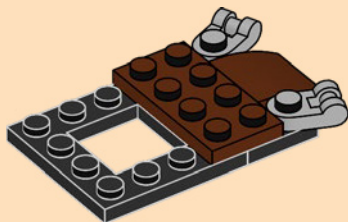

24

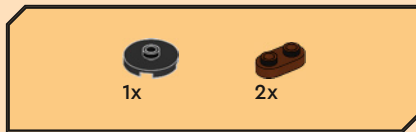

28

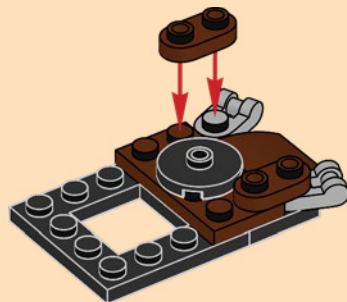





29

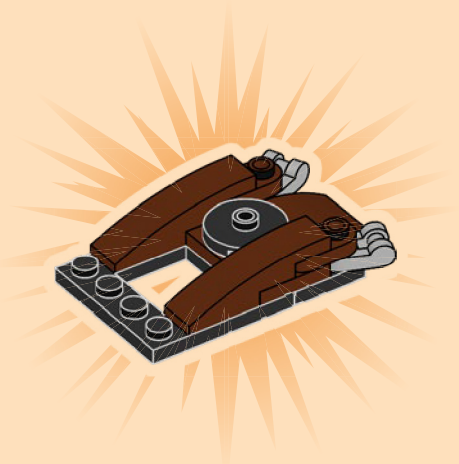

30

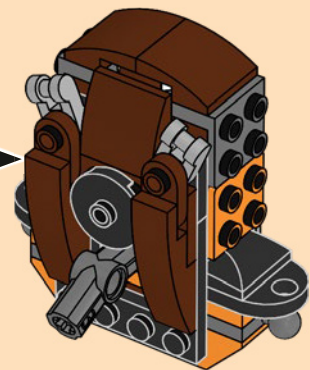



31

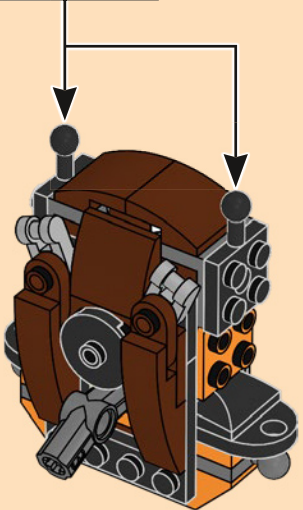
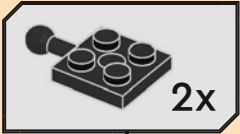



32

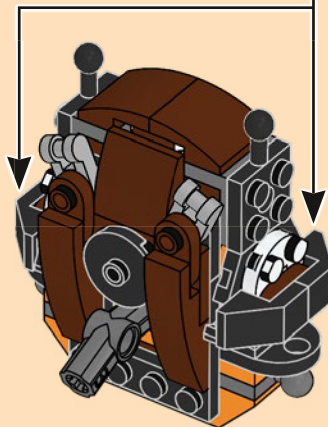
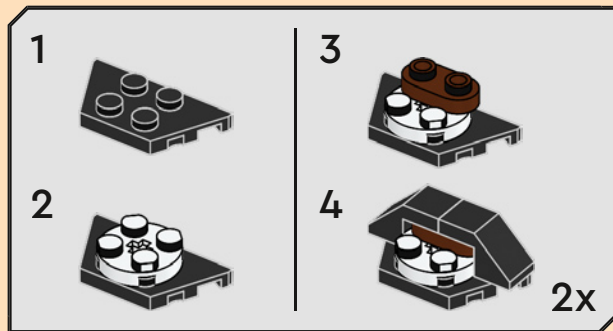



33

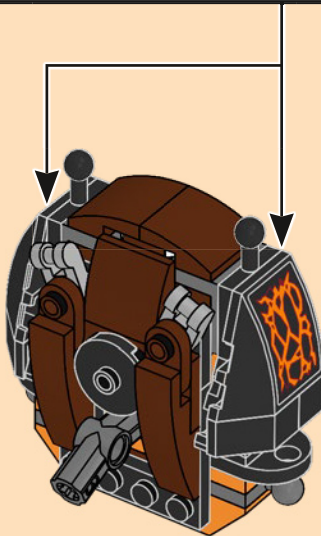
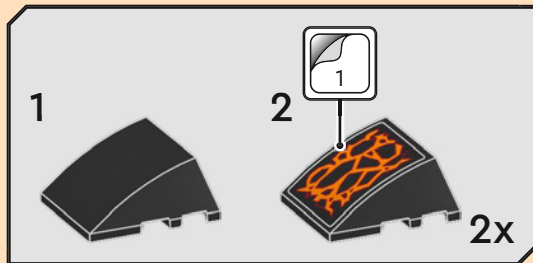

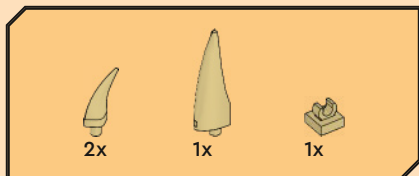

34

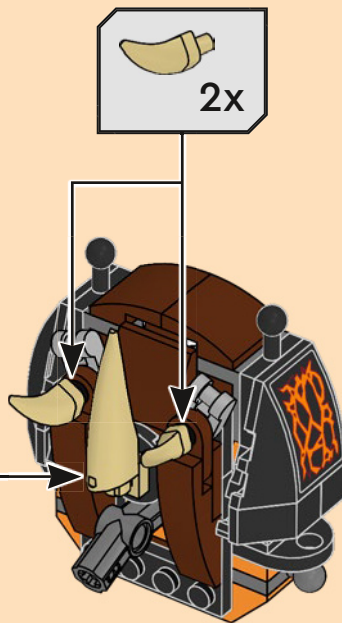
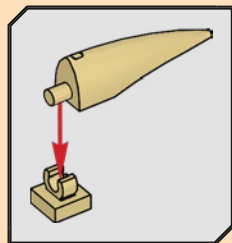



35

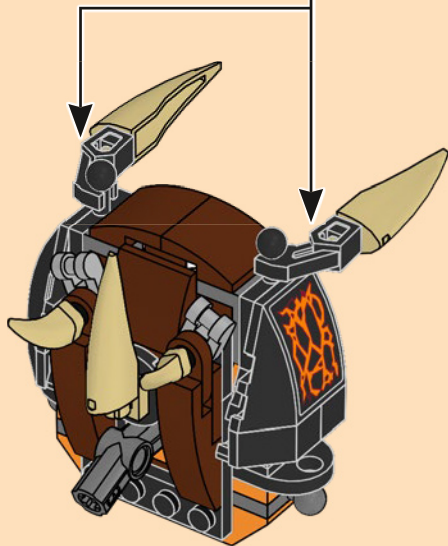
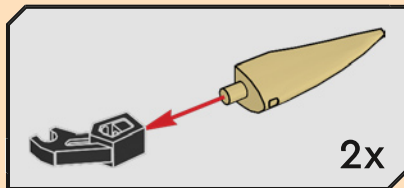



36

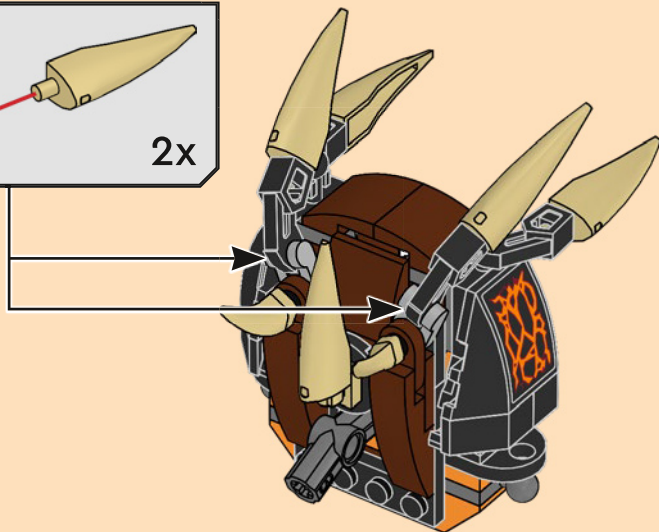
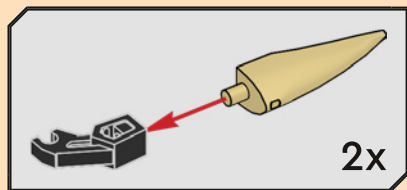



37

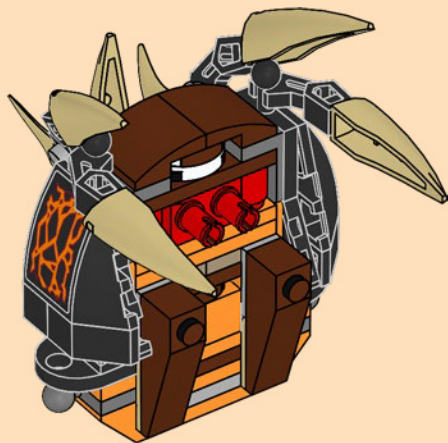



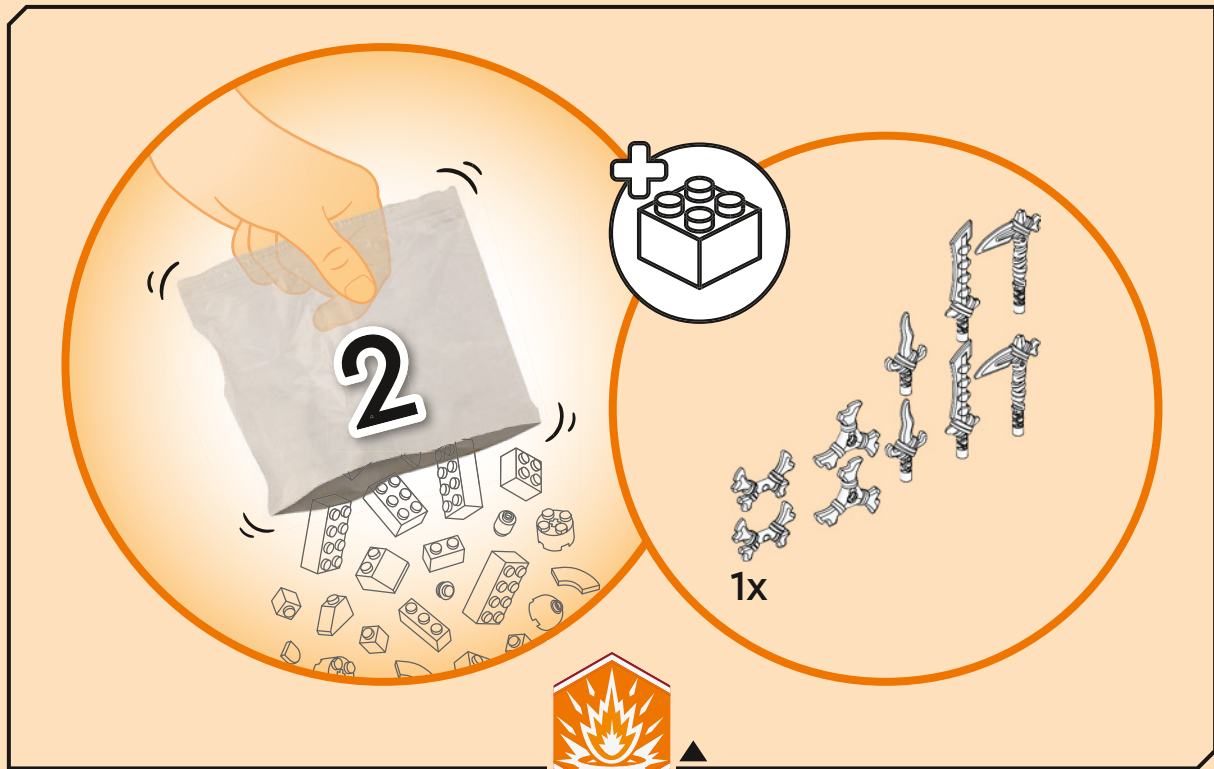

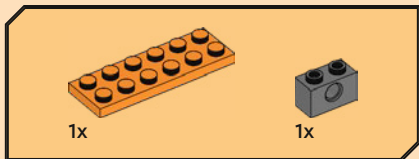

38

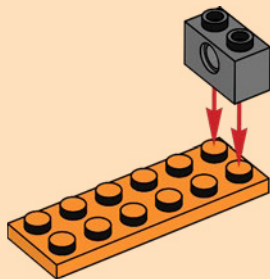



39

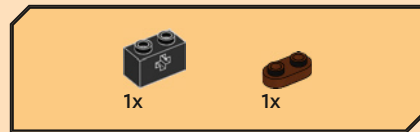
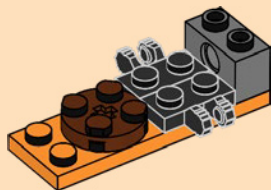

40

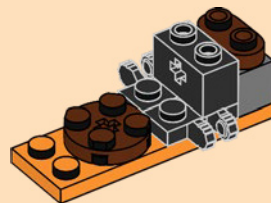

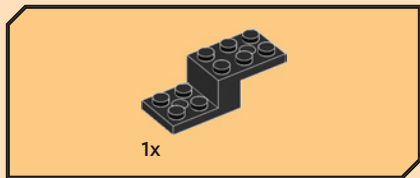

41

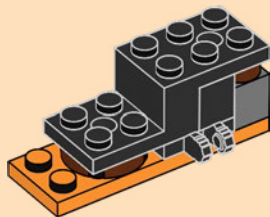



42

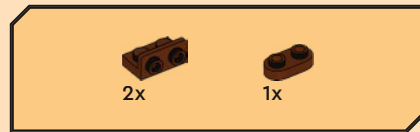
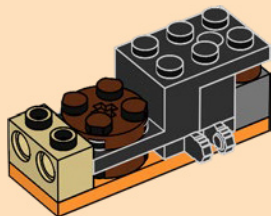

43

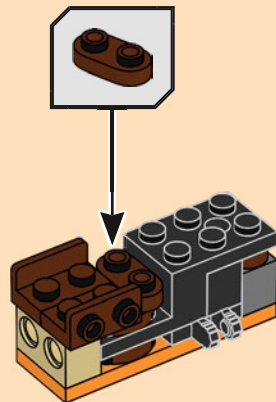



44

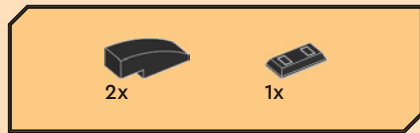
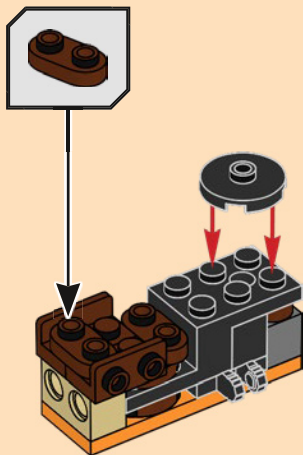

45

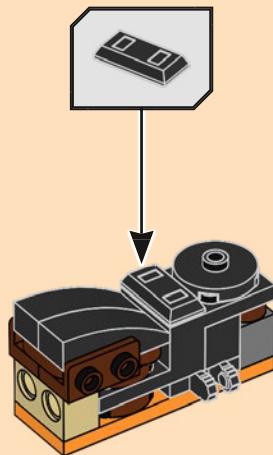



46

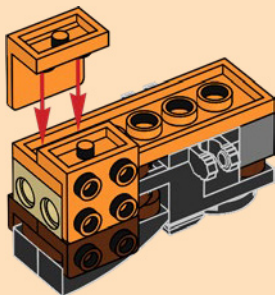

47

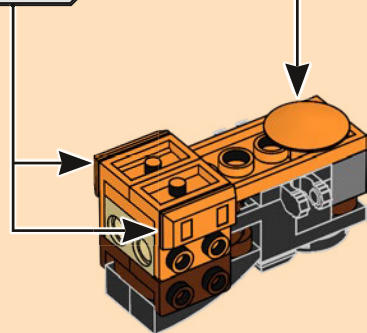



48

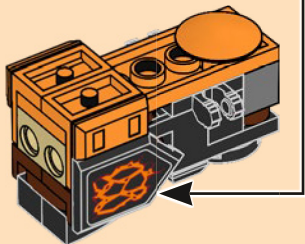
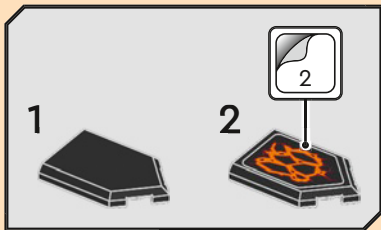

49

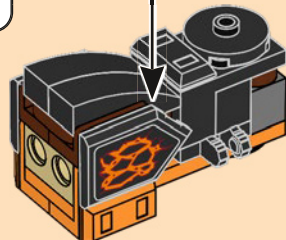
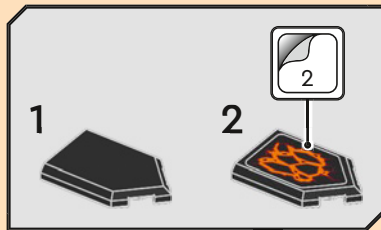



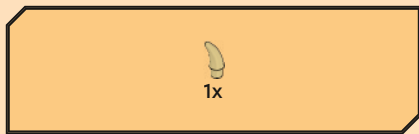

50

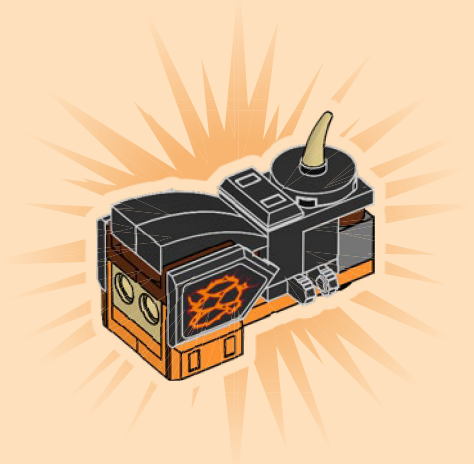

51

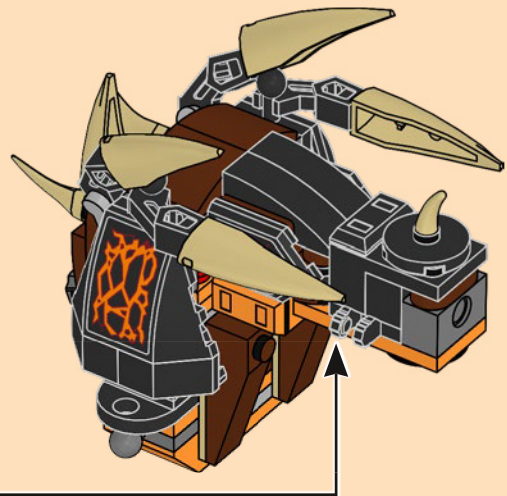

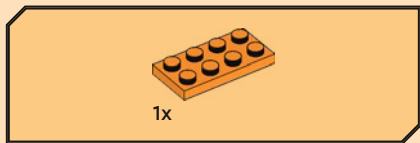

52

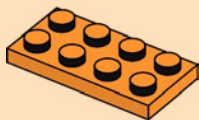

53

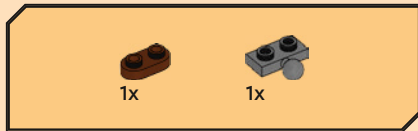
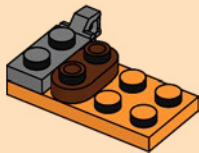

54

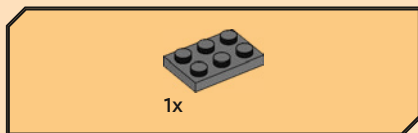
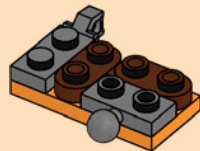

55

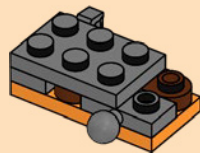

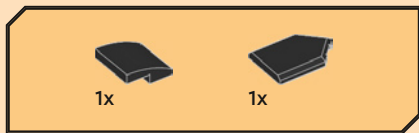

56

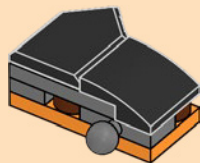

57

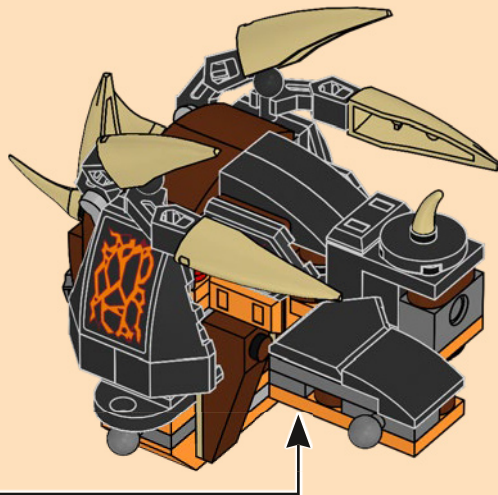

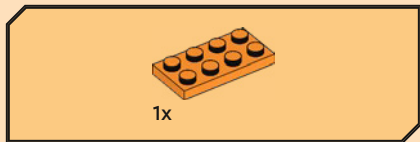

58

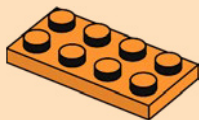

59

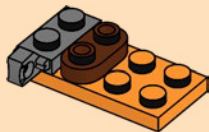

60

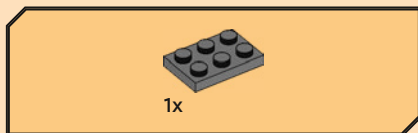
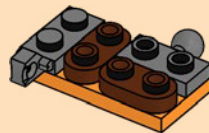

61

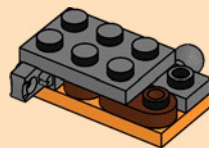

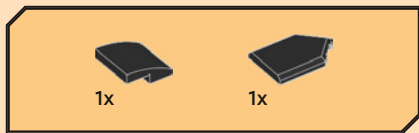

62

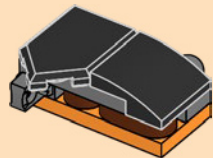

63

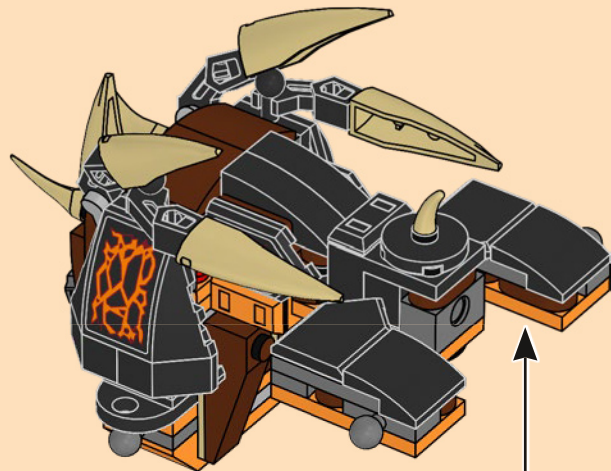



64

1

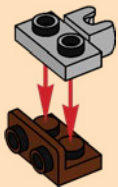

2



3

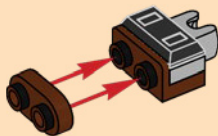

4

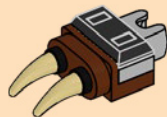

2x

65

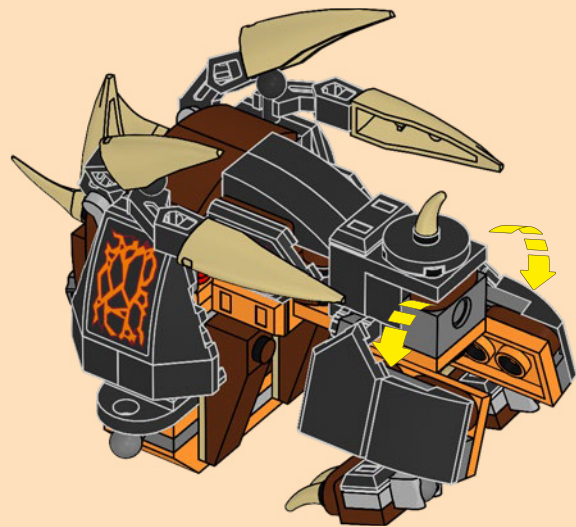
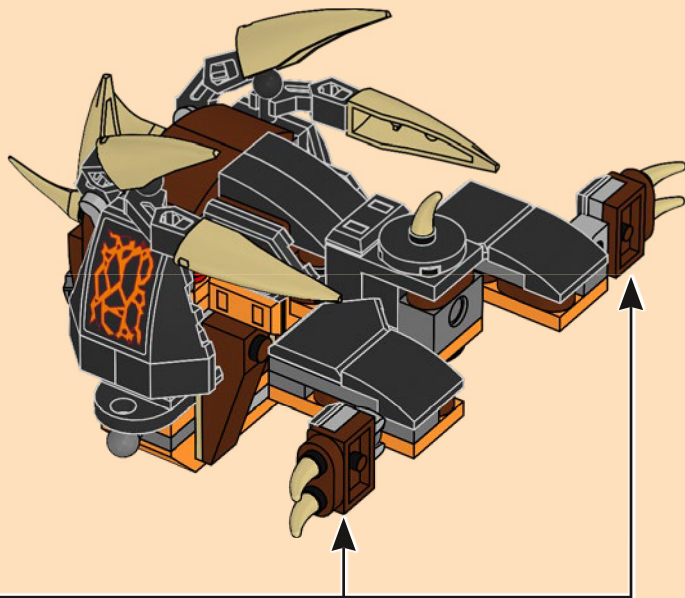

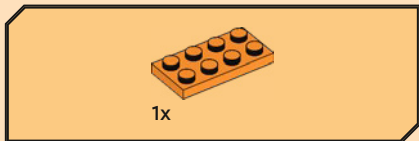

66

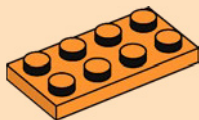

67

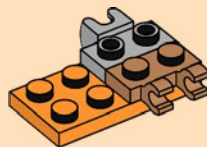





68

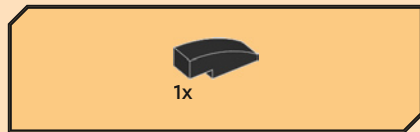
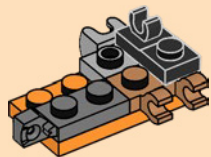

69

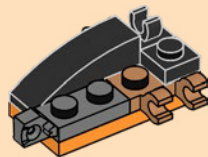

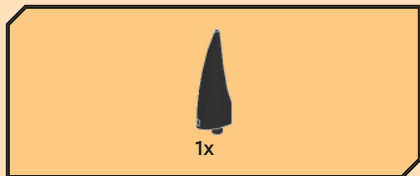

70

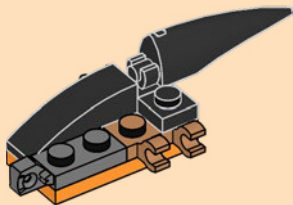

71

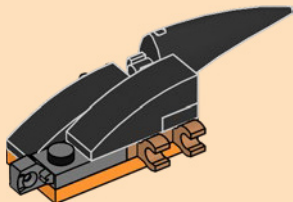

50

72

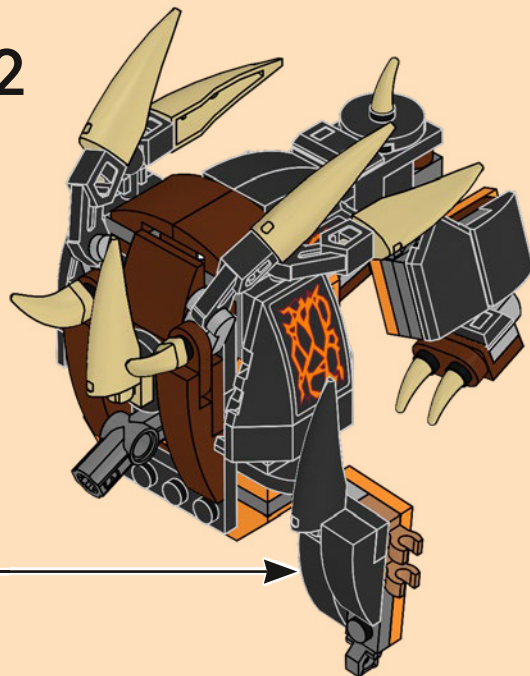

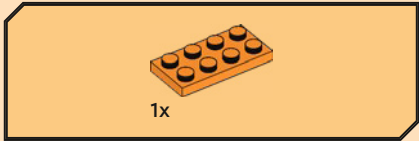

73

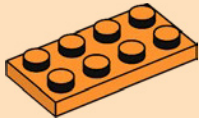

74

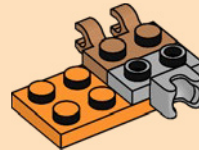



75

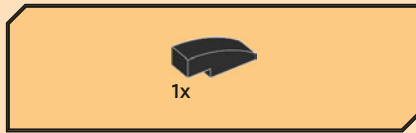
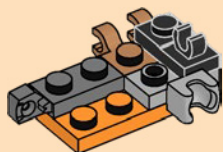

76

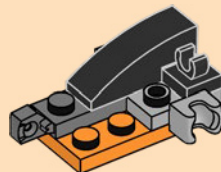

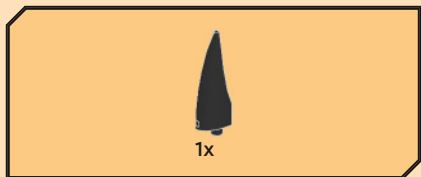

77

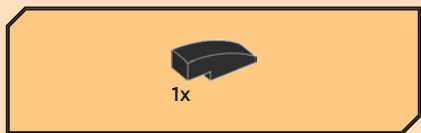
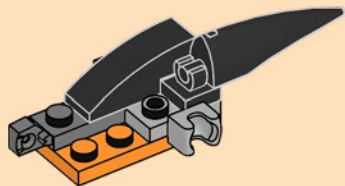

78

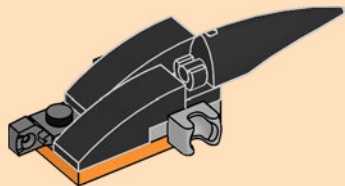

79

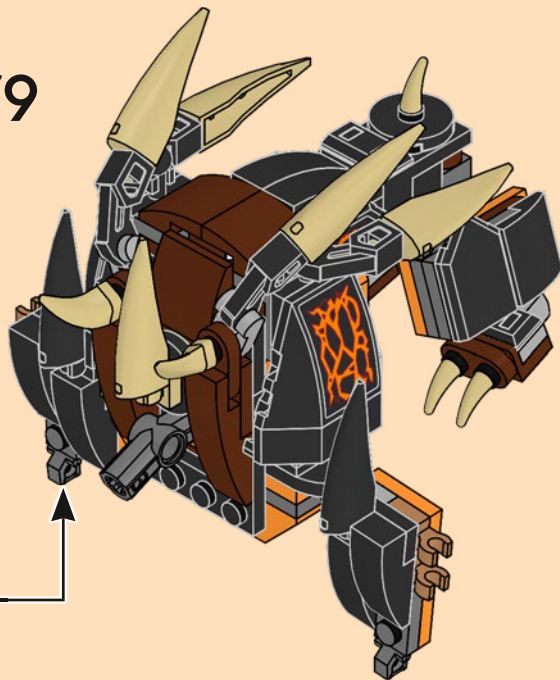



80

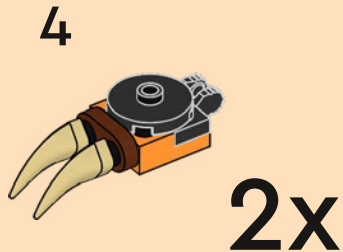
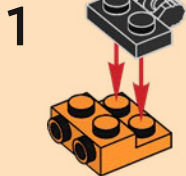

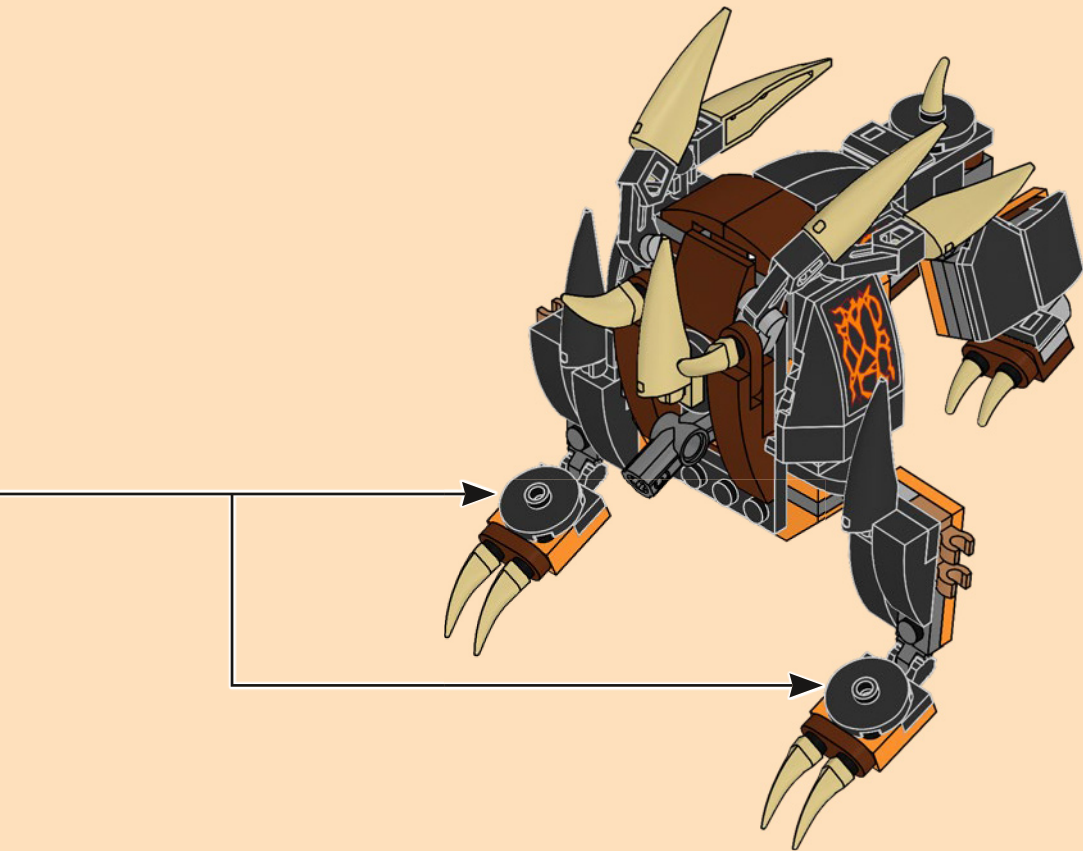

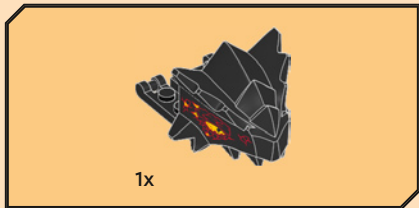

81

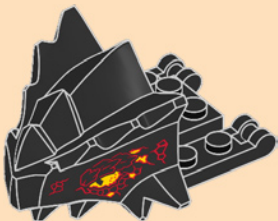

82







83

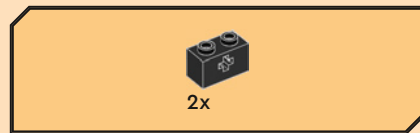

84





1x

85



1x

86

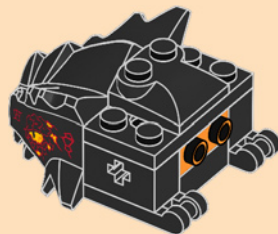



2x

87

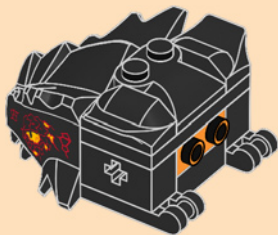

1x



1x

88

1



2

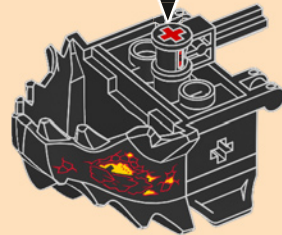
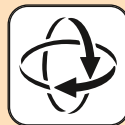



2x

89

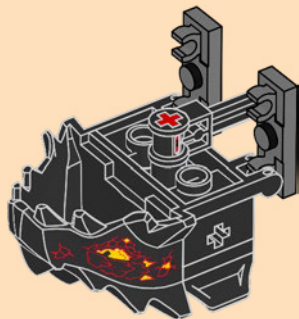

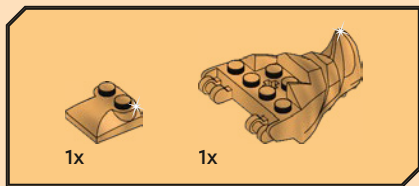

90

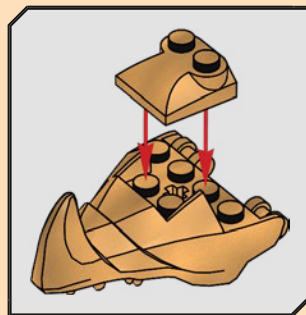

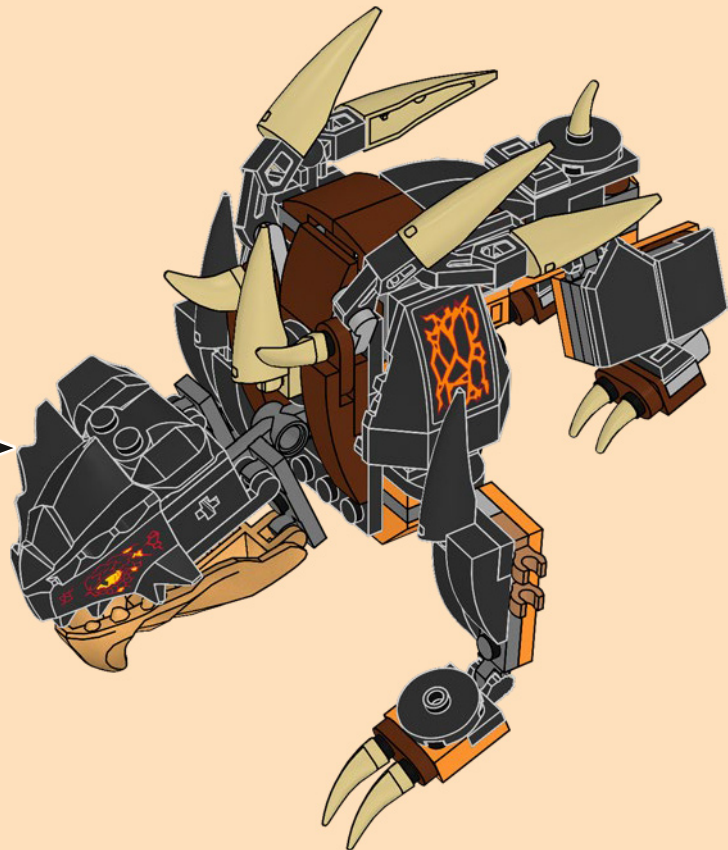



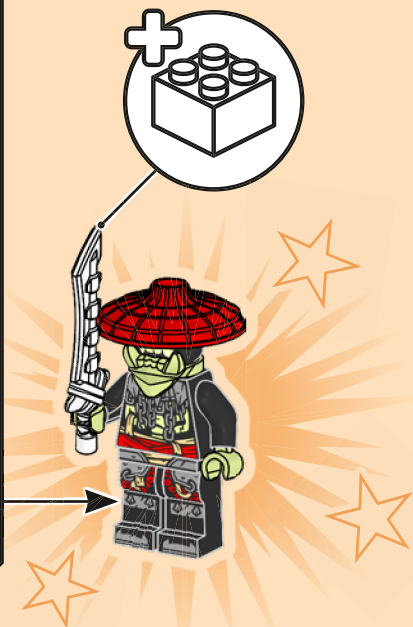
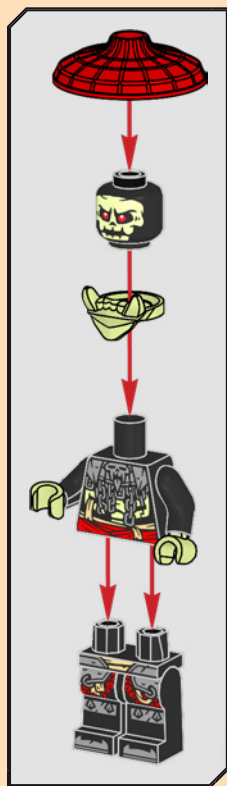







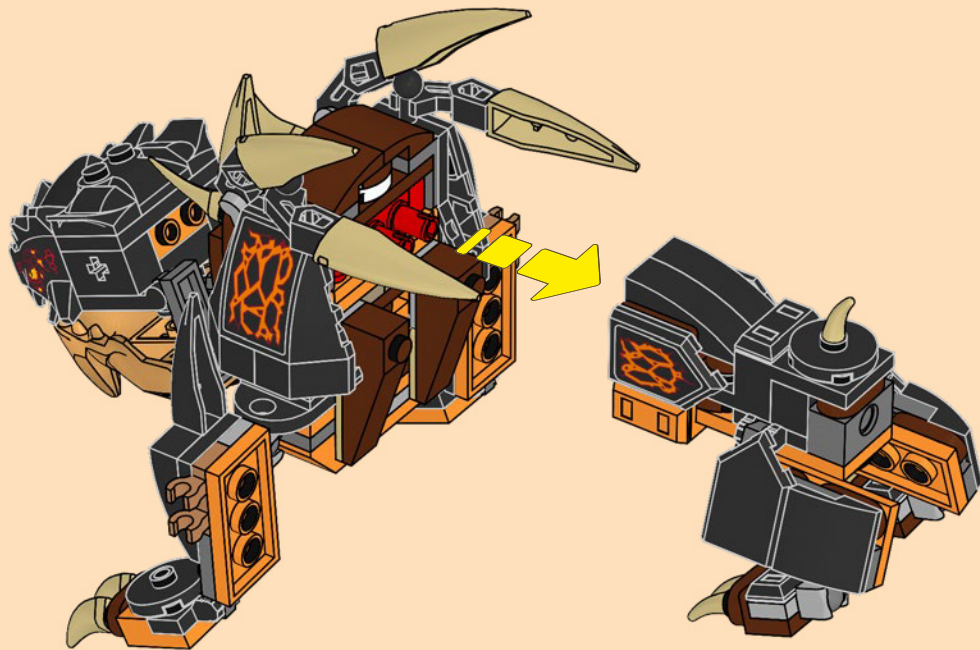

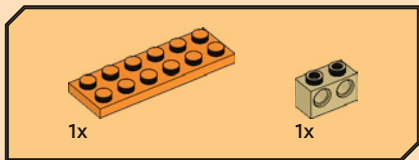
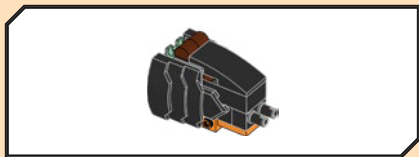

93

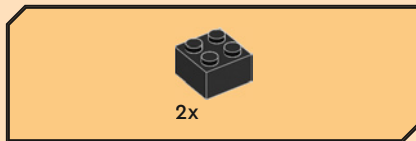
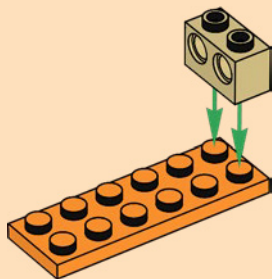

94

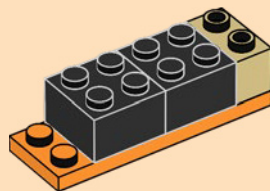

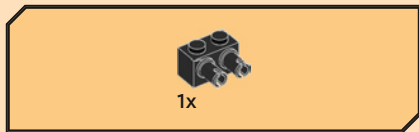

95

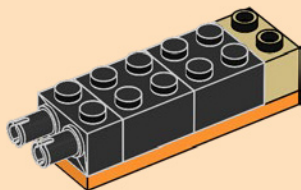

96

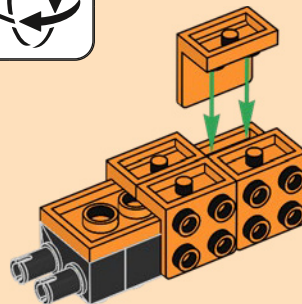

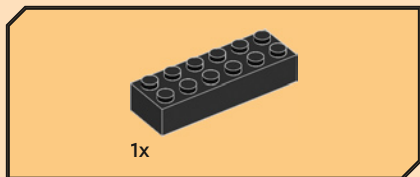

97

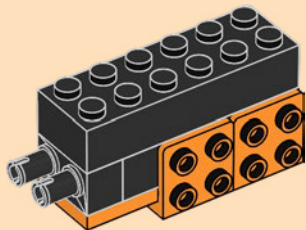

70



98

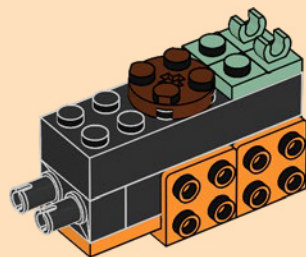

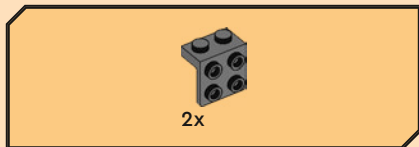

99

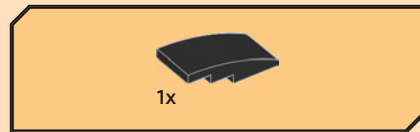
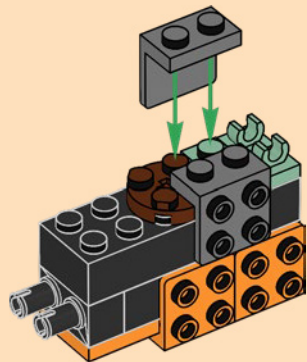

100

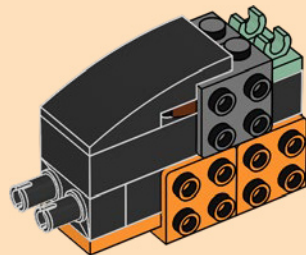



101

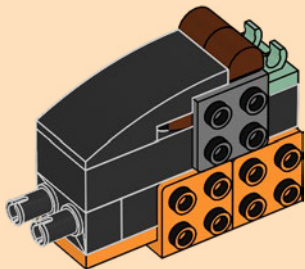

102

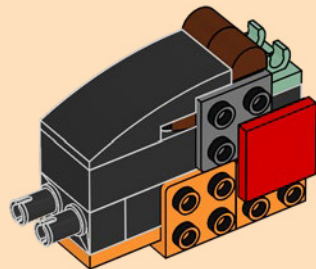





103

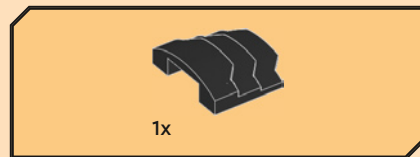
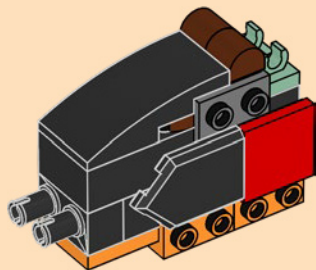

104

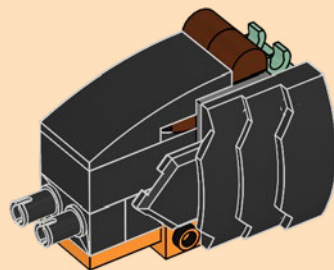



105

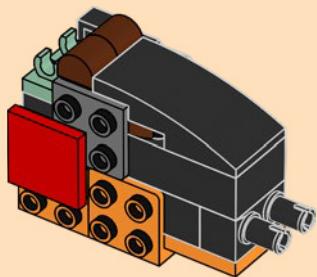

106

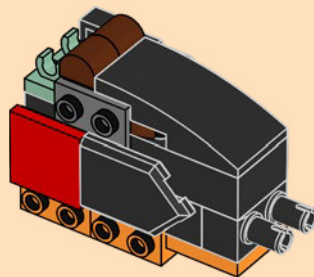

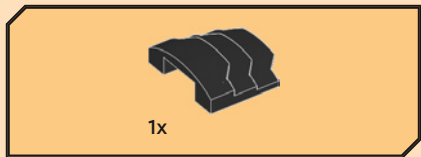

107

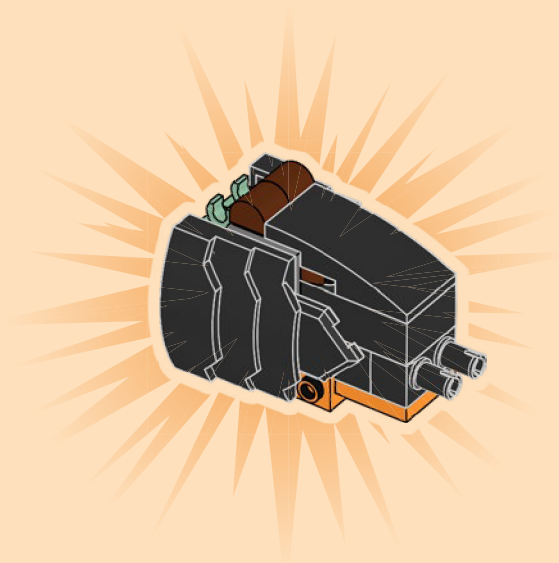

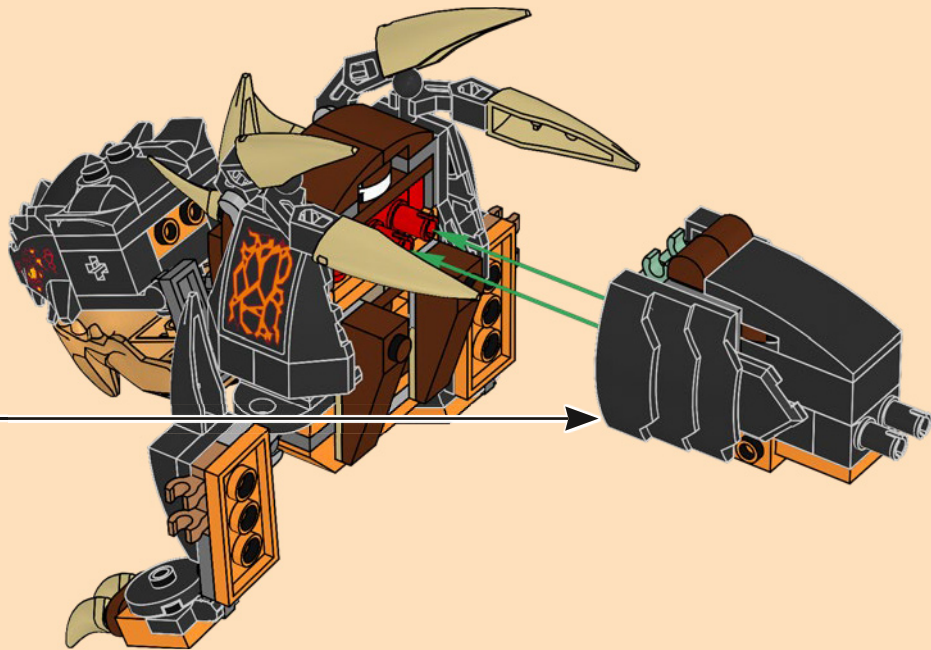

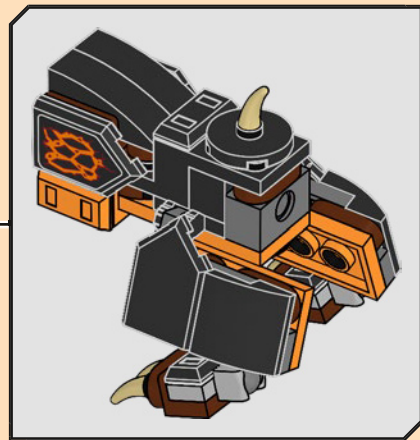
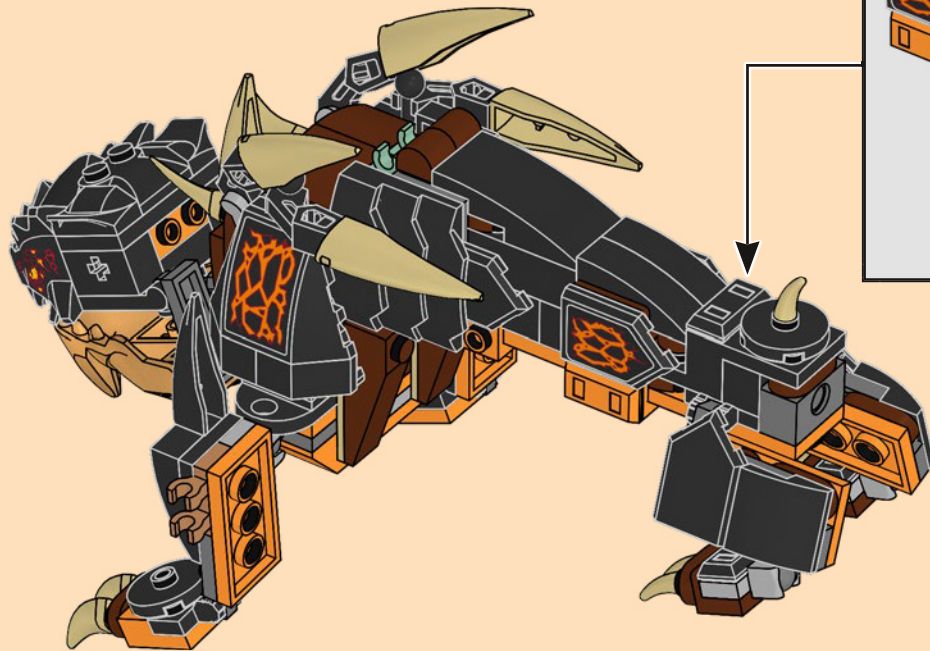

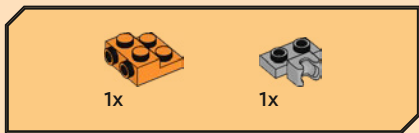
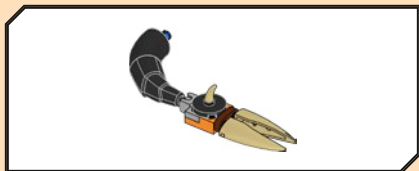

110

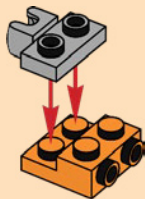

111

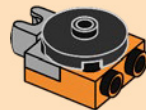



112

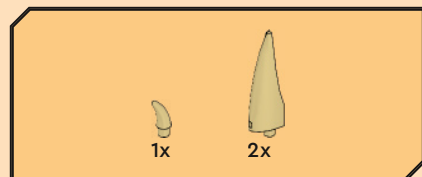
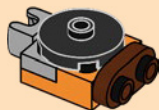

113

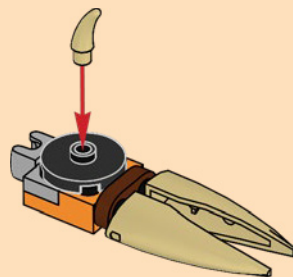

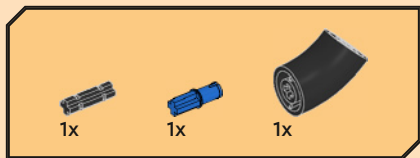

114



115

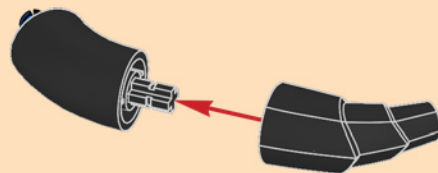



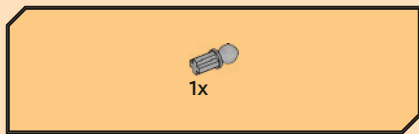

116

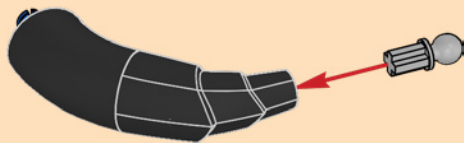

117

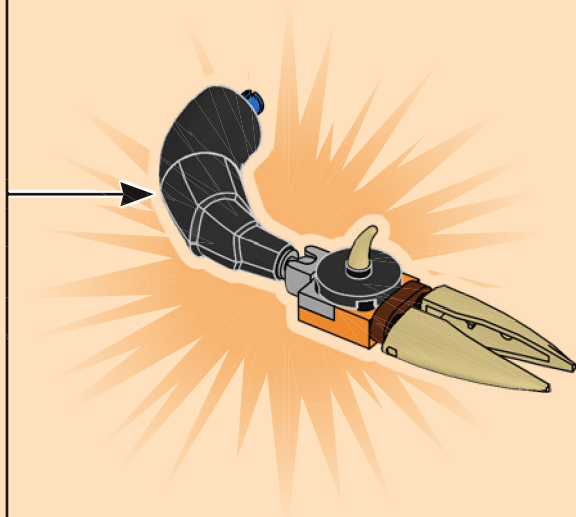

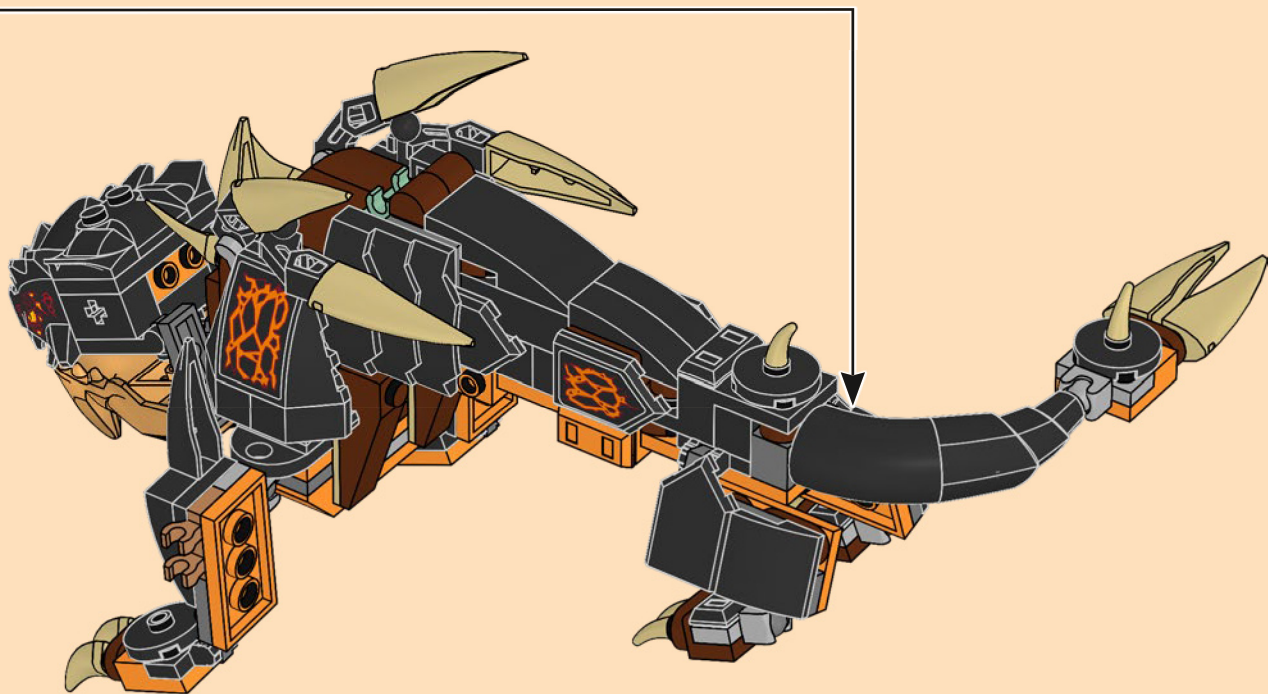

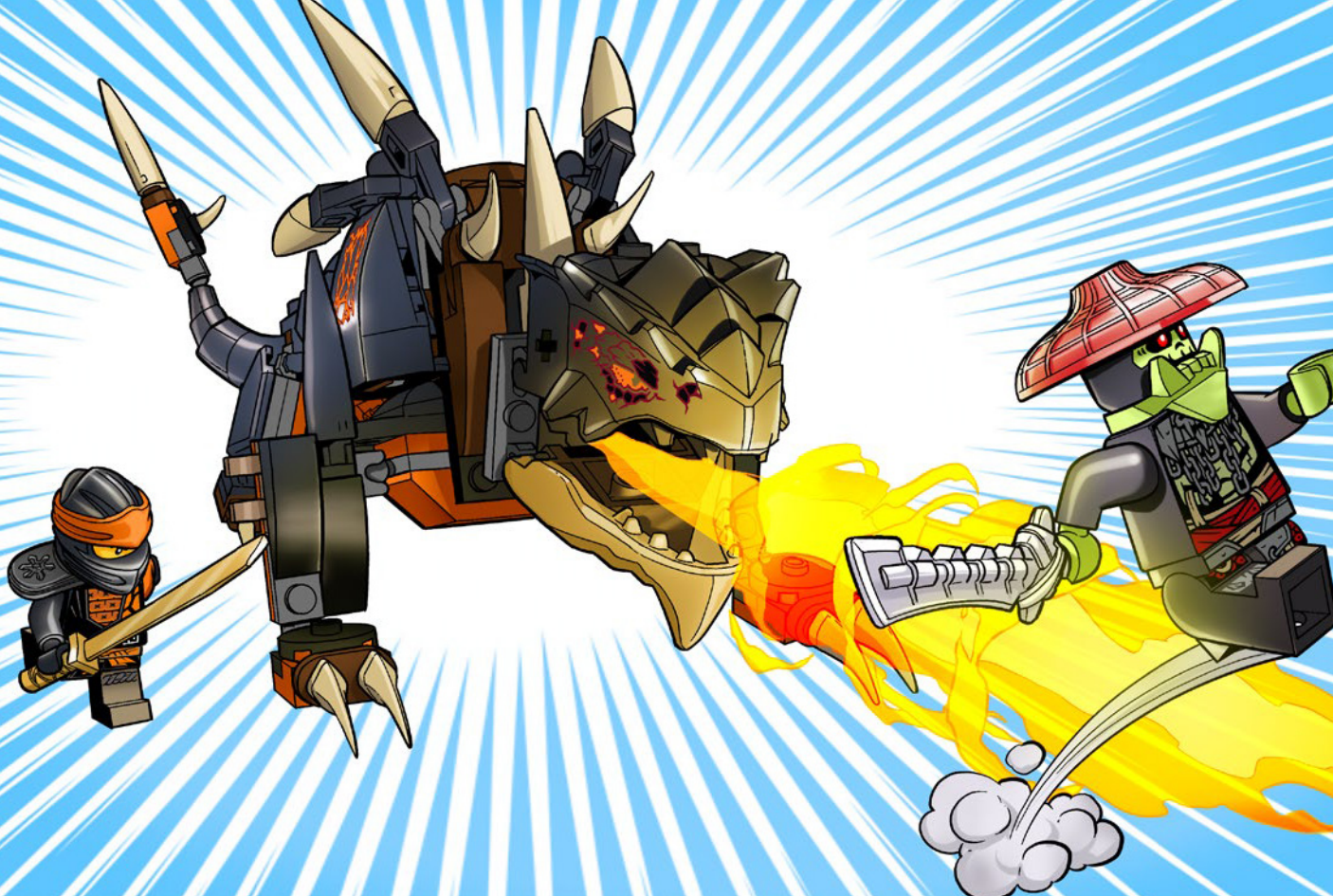

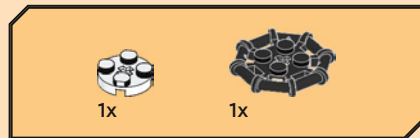

119

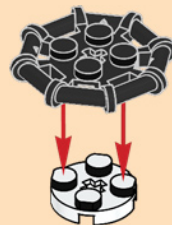

120

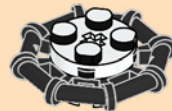

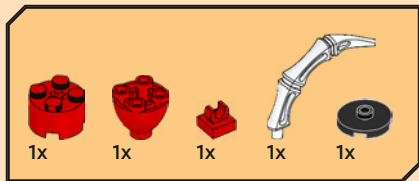

121

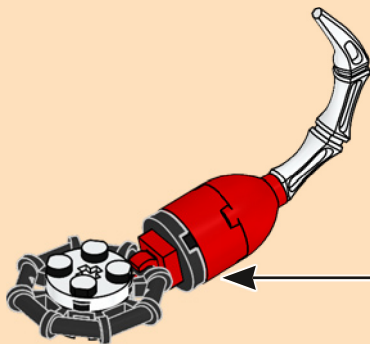
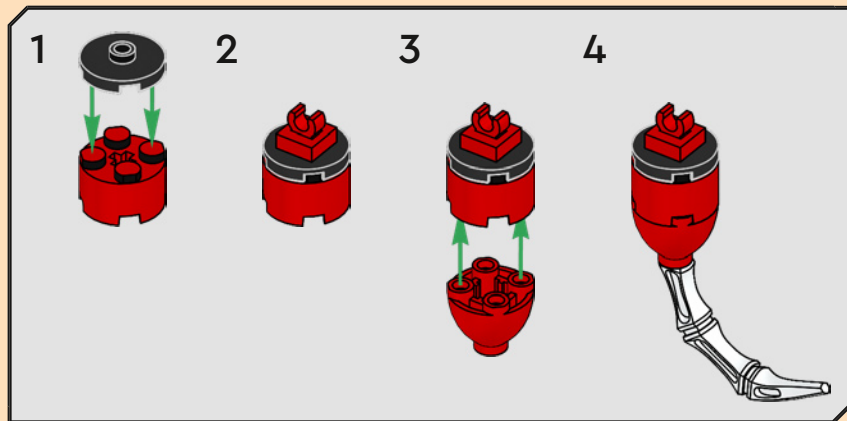

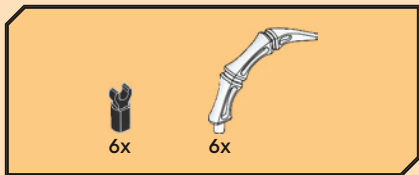

122

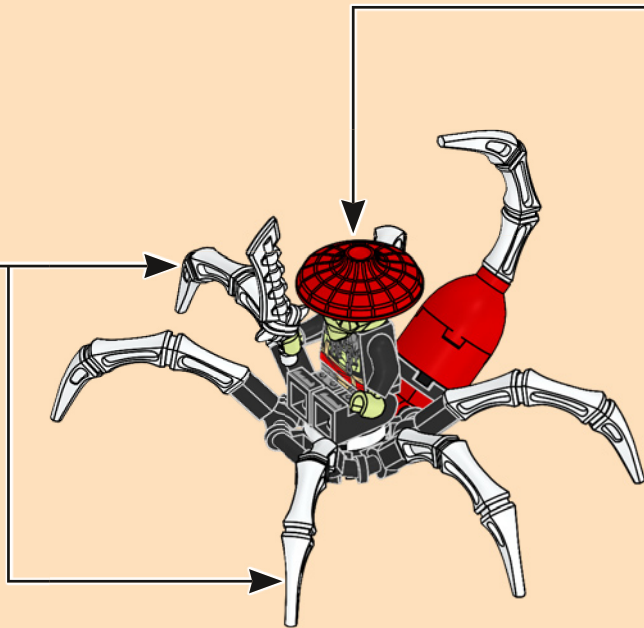
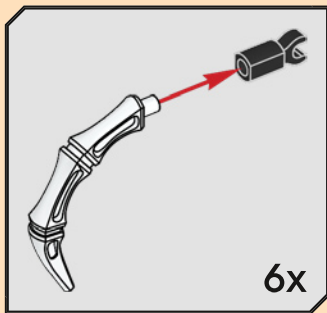



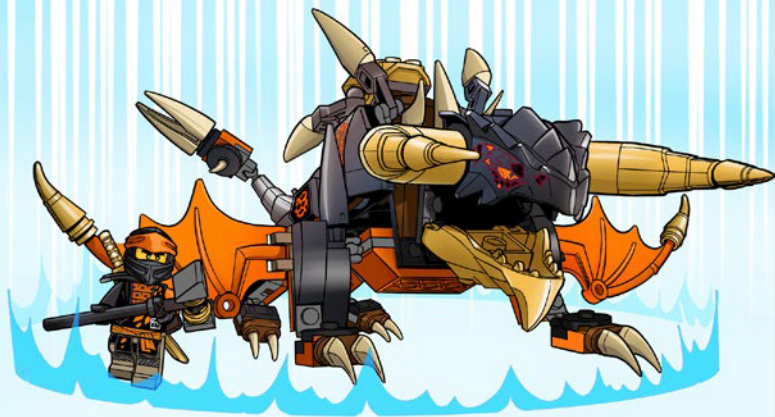



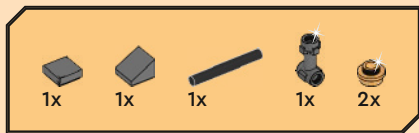

123

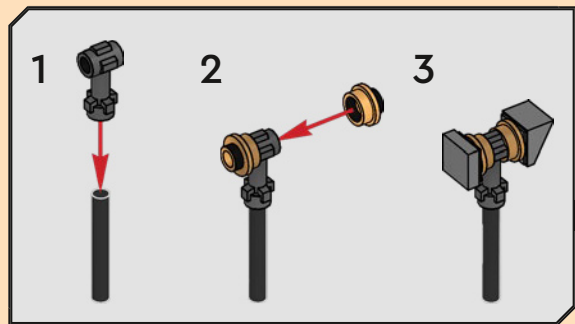



124

1



2



3

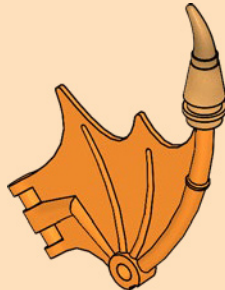

2x

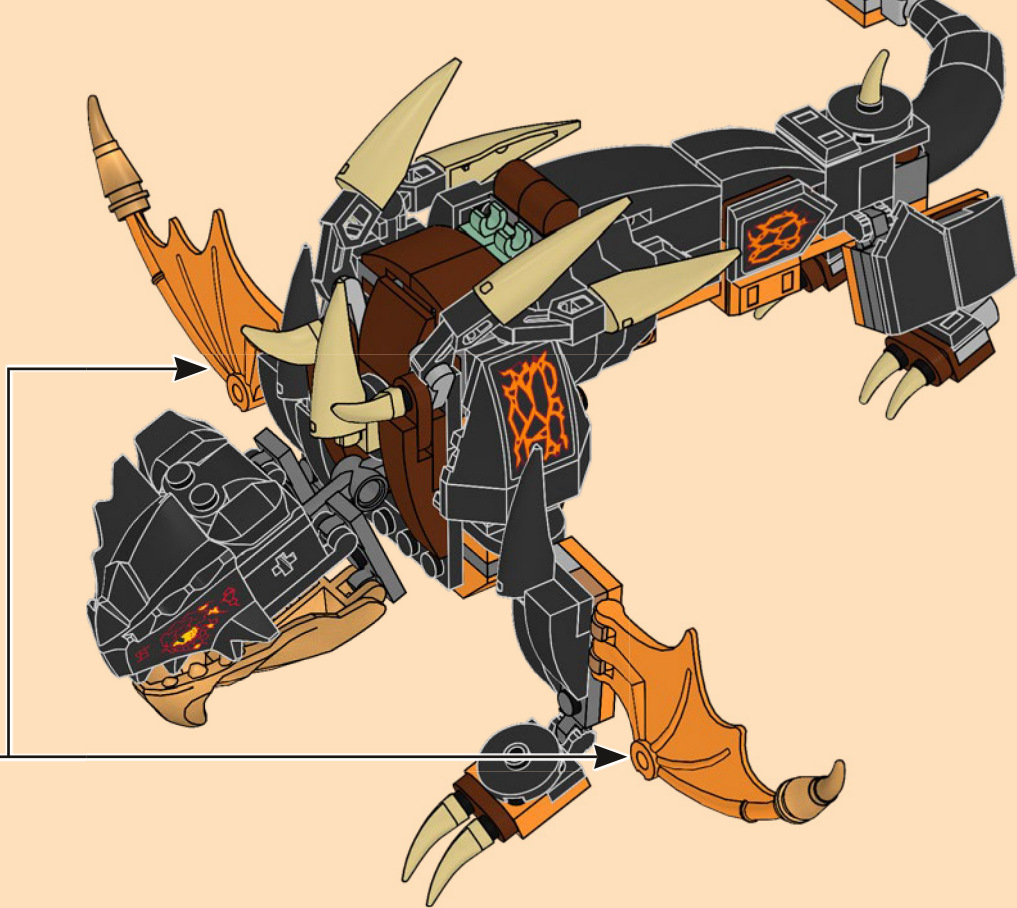

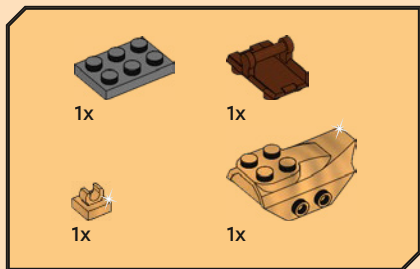

125

1



2



3

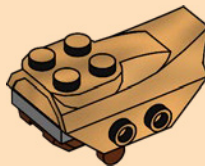

4

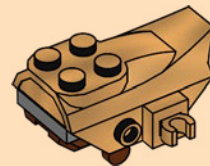

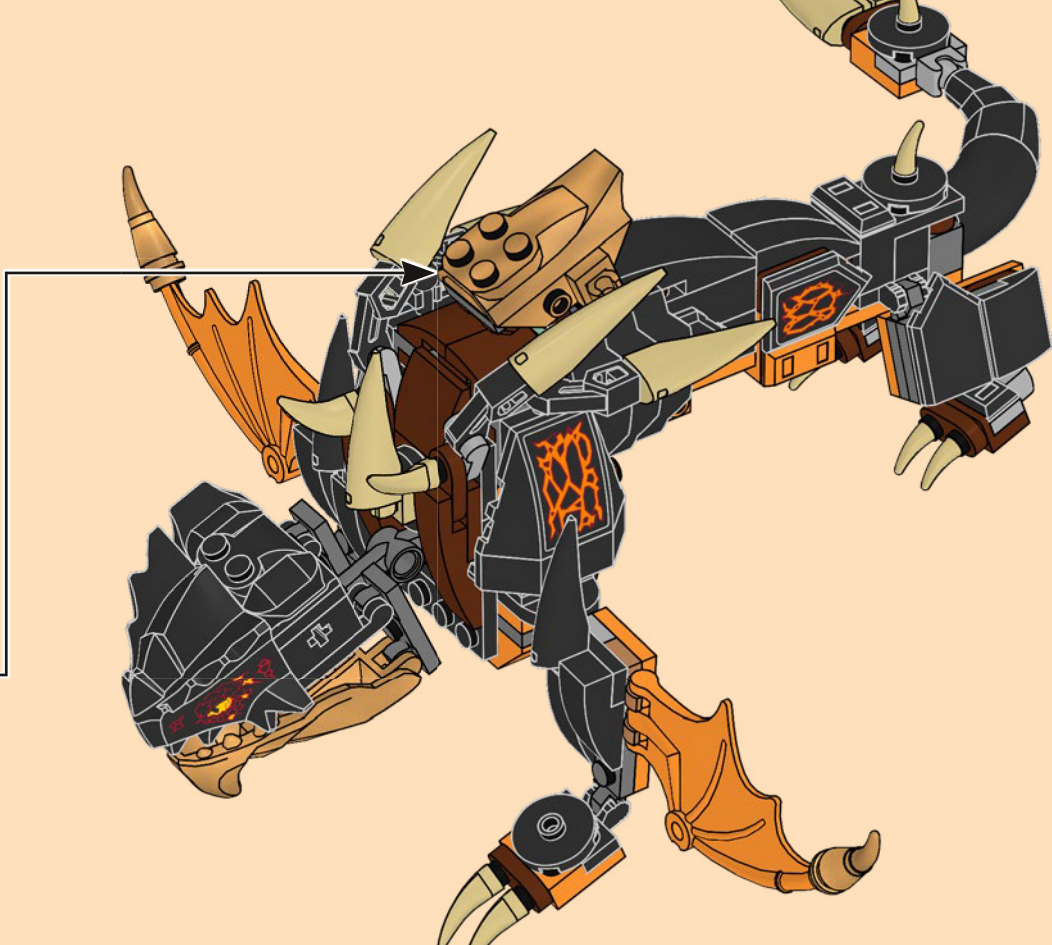

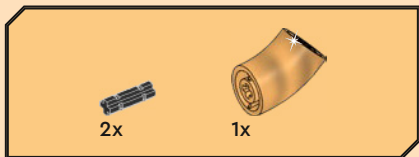
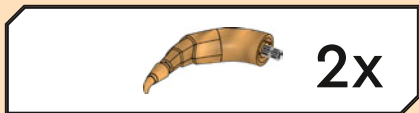

126

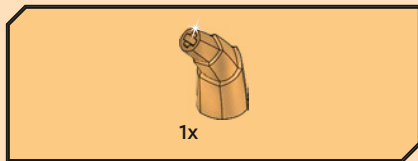
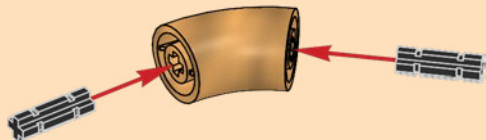

127

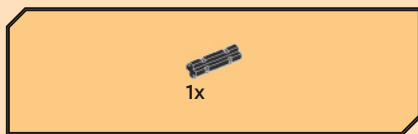
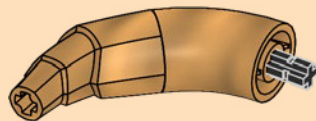

128

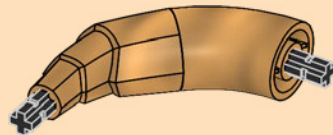



129

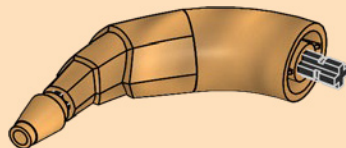

130

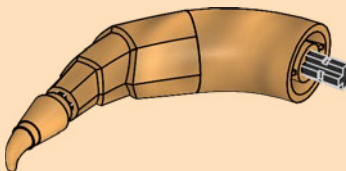

2x

131

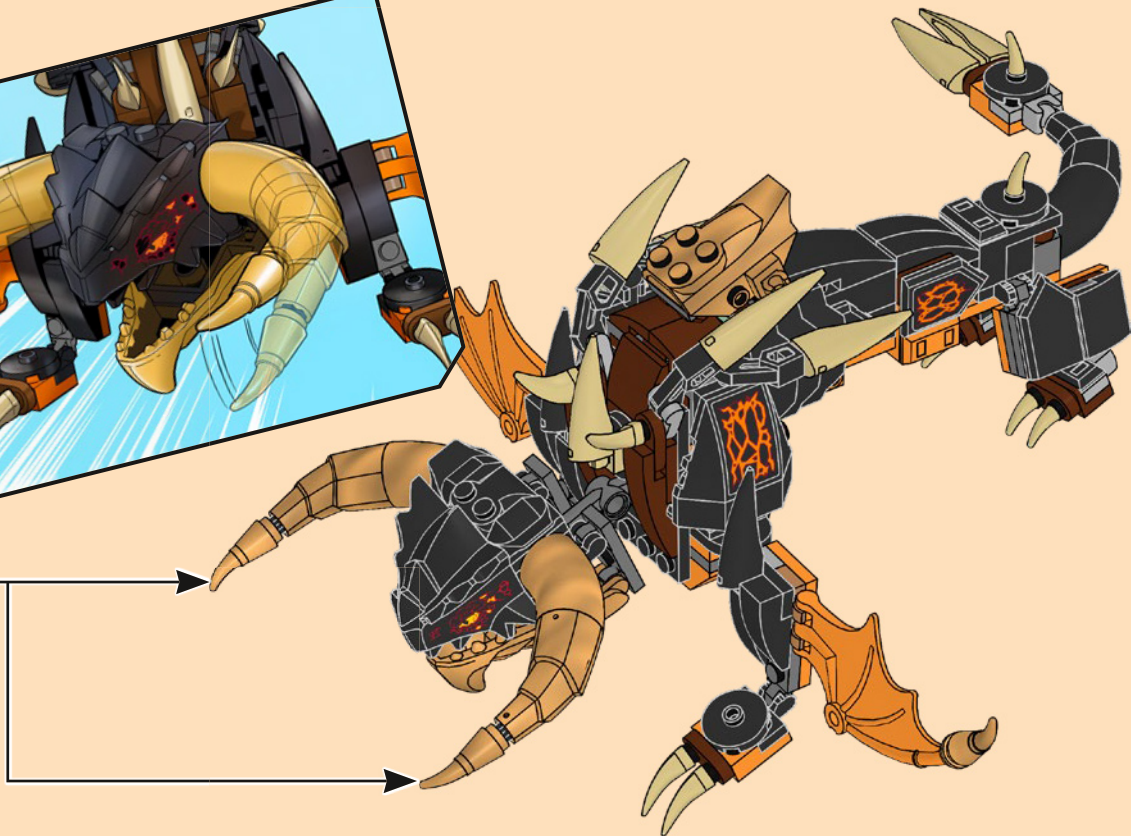
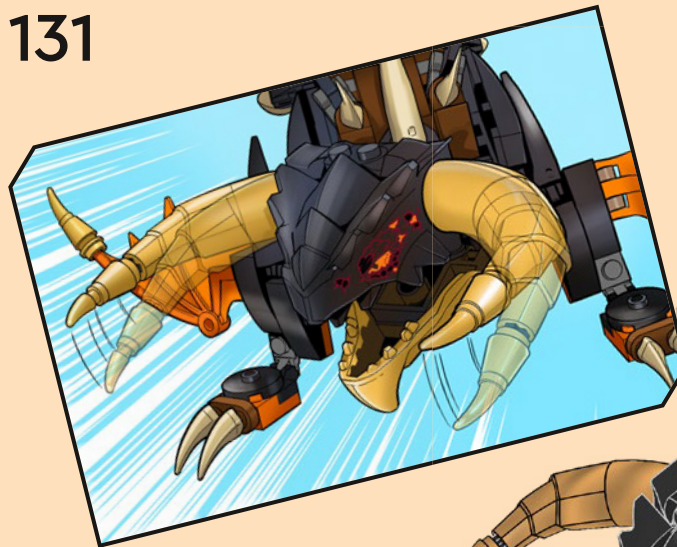





132

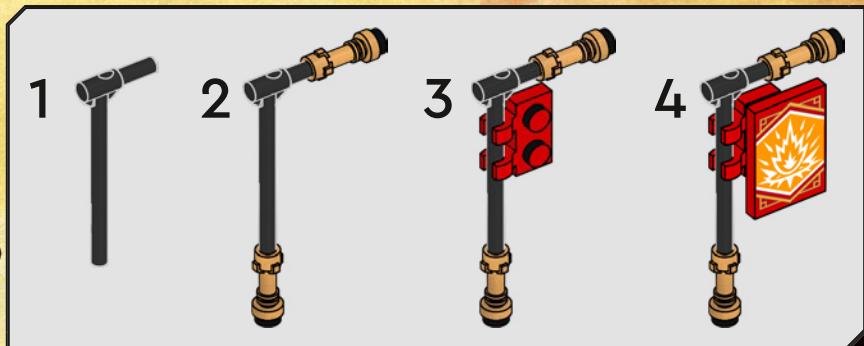





**LEGO**

# NINJAGO









 [LEGO.com/service](https://www.LEGO.com/service)



YOU COULD **WIN**



Scan this QR code or go to **LEGO.COM/PRODUCTFEEDBACK** and give us your short feedback about this LEGO® set for a chance to win a cool LEGO prize.

Terms and Conditions apply\*



**DE: Du könntest GEWINNEN.** Es gelten die Teilnahmebedingungen\* **FR: Tu pourrais GAGNER.** Des conditions s'appliquent\* **IT: Potresti VINCERE tu.** Termini e condizioni sono applicabili\* **ES: Puedes GANAR.** Aplican términos y condiciones\* **PT: Poderá GANHAR.** Aplicam-se termos e condições\* **JA: プレゼント付き! 利用規約が適用されます\*** **ZH: 轻松获奖. 条款和条件适用\*** **KO: 상품의 주인이 되어보세요. 소정의 약관이 적용됩니다\*** **RU: Вы можете ВЫИГРАТЬ.** Действуют положения и условия\* **PL: Szansa na WYGRANĄ.** Obowiązują warunki korzystania\* **CS: Máte šanci VYHRÁT.** Platí všeobecné smluvní podmínky\* **SK: Máte šancu VYHRAŤ.** Platia všeobecné zmluvné podmienky\* **HU: TE IS NYERHETSZ.** Felhasználási feltételek érvényesek\* **RO: Ai putea CÂȘTIGA.** Se aplică termenii și condiții\* **BG: Можете да СПЕЧЕЛИТЕ.** Има определени правила и условия\* **LV: Tu vari LAIMĒT.** Ir spēkā noteikumi un nosacījumi.\* **ET: Sul on võimalus VÕITA.** Kehtivad tingimused\* **LT: Jūs galite LAIMĖTI.** Taikomos sąlygos\*  
\*LEGO.com/productfeedback-terms

LEGO, the LEGO logo, NINJAGO and the NINJAGO logo are trademarks of the/son des marques de commerce du/son marcas registradas de LEGO Group. ©2023 The LEGO Group.

6449664