

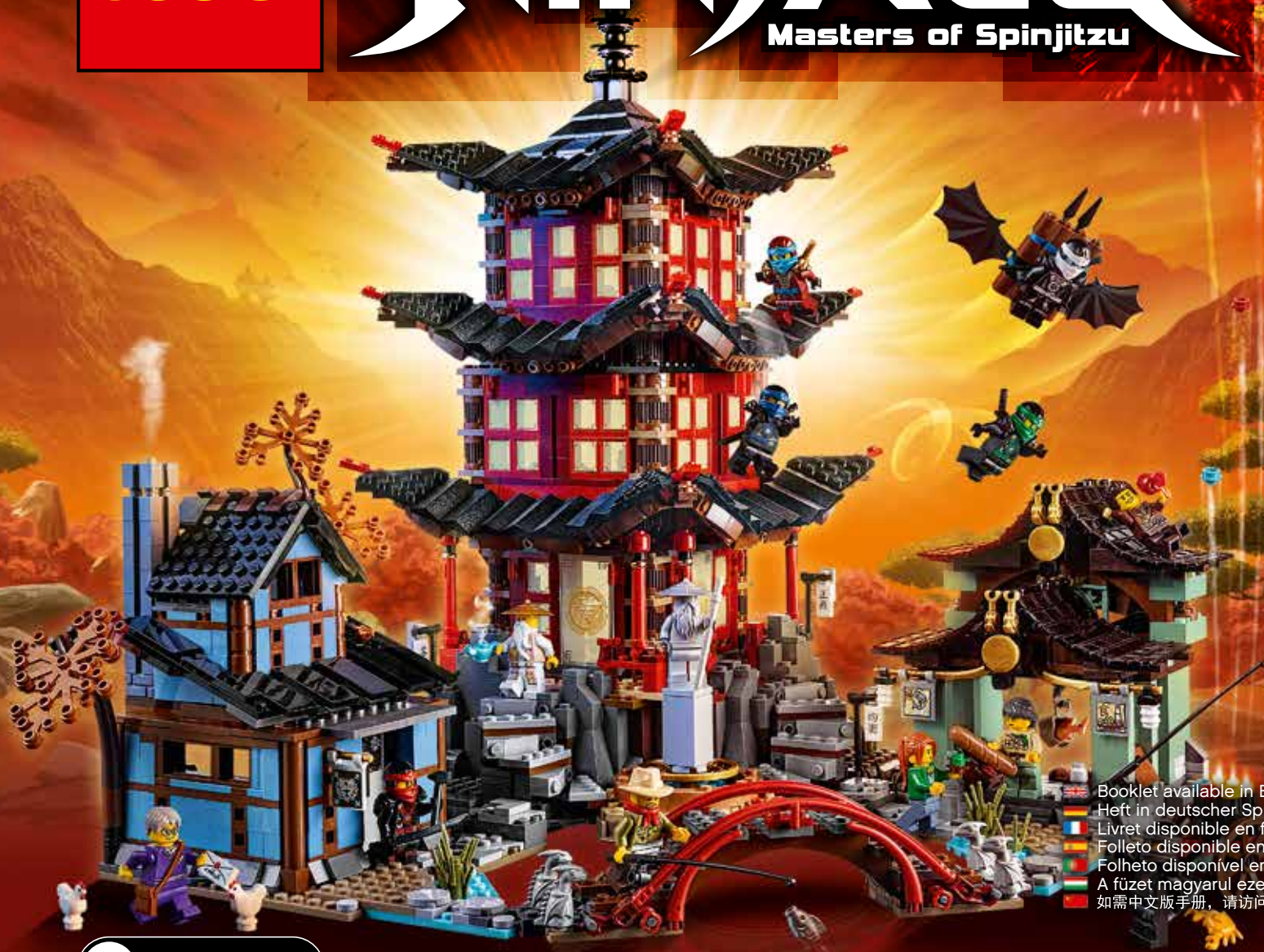

NINJAGO™

Masters of Spinjitzu



Booklet available in English on:
Heft in deutscher Sprache erhältlich auf:
Livret disponible en français sur :
Folleto disponible en español en:
Folheto disponível em português em:
A füzet magyarul ezen a honlapon olvasható:
如需中文版手册, 请访问 LEGO.com/ninjago



70751

TEMPLE OF AIRJITZU

This is the place where Sensei Yang invented the lost art of Airjitzu. Sensei Yang trained for most of his life to master this airborne style of fighting, but by the time he finally did, he had become a very old man. He decided to pass on his legacy and started accepting students. In the beginning, he was a respected and admired master, and students even raised a statue in front of the temple in his honor. But knowing that his time was coming to an end, he became impatient and was very hard on students who failed to live up to his strict code of discipline and unusual training methods. A common practice was locking up his students in the attic to make sure they had time to reflect on why they failed to succeed in an Airjitzu training session.

Very little is known of what went on behind the temple walls, but the fact that none of his students ever left the temple has given rise to much speculation and many legends and rumors. Sensei Yang became known as “The Sensei without Students,” and people made sure to keep their distance from the temple.

It is now believed that the ghost of Sensei Yang haunts the temple, and that anyone who enters and does not exit again before sunrise will themselves become a ghost. Over the years, the temple has fallen into disrepair and has become a popular tourist site.

That was a bit of the grim history of the Temple of Airjitzu... What will the future hold for it? You will just have to make up your own story or keep following the story of LEGO NINJAGO to find out. It would be a pretty cool headquarters for the ninja, wouldn't it?

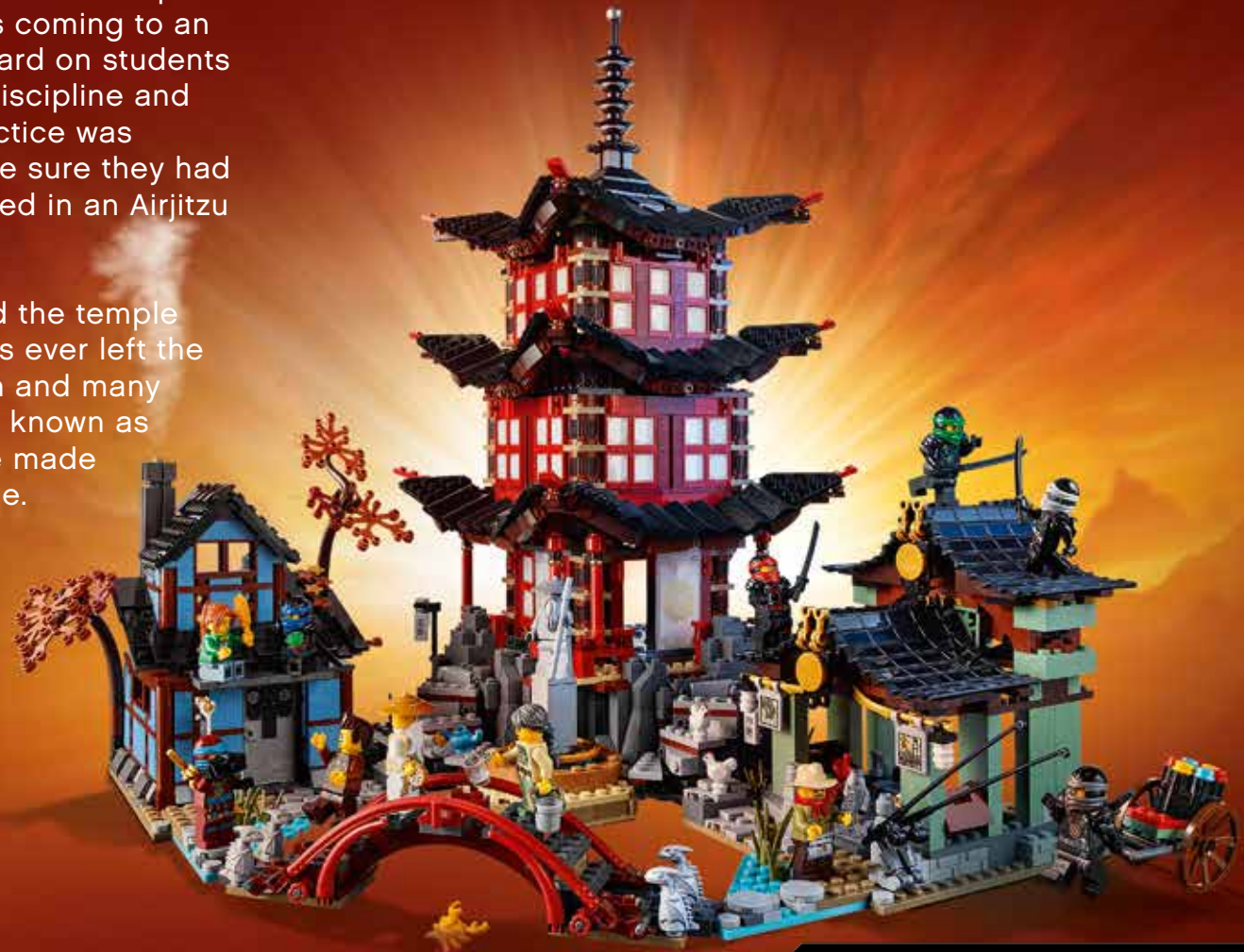

TEMPLE OF AIRJITZU

Little is known about the origin of this historic location. No one knows who built it or when, but it has been around since the EDO period. Many suspect that it is even older than that, and once was the dojo of the First Spinjitzu Master.

NINJAGO CITY

The biggest city in all of the NINJAGO world. The city has seen its share of action and was the main site of the attacks of the Great Devourer, the Overlord, the Stone Warriors, the evil Nindroids, and the Golden Master. But NINJAGO City has always prevailed, and although the city has seen much conflict, destruction, and transformation, the citizens are still honest and hard-working people.

THE WAILING ALPS

One of the highest and coldest peaks in the NINJAGO world. The chilling winds that rush this mountain range make a distinct and frightening sound. The Wailing Alps are the location of the Hypnobrai tomb, and a huge tornado that rages through the area, called the Blind Man's Eye, is said to be a passageway to another Realm.



AN INTERVIEW WITH THE DESIGNERS ADRIAN FLOREA AND THOMAS PARRY



Can you explain a little about the process of designing the Temple of Airjitzu model?

Sure! When I started working on the Temple of Airjitzu, I had already been working on all things LEGO NINJAGO for more than four years, so you could say that I was very familiar with the universe, the tone of voice, and of course our team of ninjas. We have been equipping our ninjas with state-of-the-art vehicles, glorious dragons, and frightening enemies year after year, but we felt that they've been missing something to provide context. A chance to build a large model came up, and my mind was set on the direction from the start. I could finally

use all the bits and builds that I have been keeping in boxes around my desk. In the end, the model still reflects a strong LEGO NINJAGO fantasy-inspired look, with some features that might not be based on reality.

How did you get the inspiration for this set?

It's difficult not to get inspired when digging up references on Asian architecture. The main idea for the model and the layout was to provide our main characters with an environment where they could take a break from saving the NINJAGO world. The centerpiece pagoda is luxurious and intricate, while the blacksmith's shop has a humble feel to it. The contrast is clear in the differences between the buildings such as the color, roof styles, windows, and the purpose they serve. Too much contrast can cause confusion, so I set up the base layout to be visually symmetrical with the fountain serving as the center.

What were some of the challenges you faced?

Knowing when to stop! The village had the potential to grow in so many different directions, but it was important to represent the essentials. The idea of the shadow theater came later in the process, which meant that it had

to be thought out efficiently and as quickly as possible. Determining how to cast the shadows on the foil screen was a complicated process. Some of the early versions had overlapping elements that created interesting shapes and even dragons with the light-brick turned on. One version involved more movement but turned out to be too finicky. Another challenge with the theater was building the mechanism that activates the turntable and light-brick simultaneously, since we can't allow the light to be triggered constantly, which would run down the battery. Challenges like these are fun at the end of the day when it all comes together and works as it should.

What's your favorite part of the model?

It's tricky to pinpoint one favorite part, but I am definitely happy with the visual effect of the shadow play, as it's the first feature of this kind to be added in a model. I have found myself staring at it as if it's telling an old folktale with its minimal language.

What was the toughest part of the model to design?

The Temple (pagoda) has proven to be the trickiest. The unique layout it has, being situated in the corner, came with unexpected surprises. Each level had to be different in width, because the first floor has a

passage on the outside, which means the walls had to be pushed in, and they would pop out by a stud on the next floor only to be narrowed down again on the last floor. The smooth curves of the roofs that have to fit with the rigid base shape of the building were a tough challenge from day one. The temple roof layout was built very differently at first, using tiny ball joints to get the angles just right. It looked nice, but was needlessly complex.

Tell us a little about how you came to work at The LEGO Group.

I graduated with a degree in Industrial Design, and have been putting LEGO bricks together since 2010. My very first models were designed for LEGO NINJAGO. I was happy to discover that the people who were interested in hiring me had known about my models that I had been building with LEGO bricks in my spare time as an AFOL [Adult Fan Of LEGO bricks].

What's your favorite LEGO NINJAGO set?

The Fire Temple still holds a special place in my heart, and a close second would be the second Destiny's Bounty. I tend to get drawn in by ridiculous features that seem to be the signature of so many LEGO NINJAGO sets.



DESIGN PROCESS

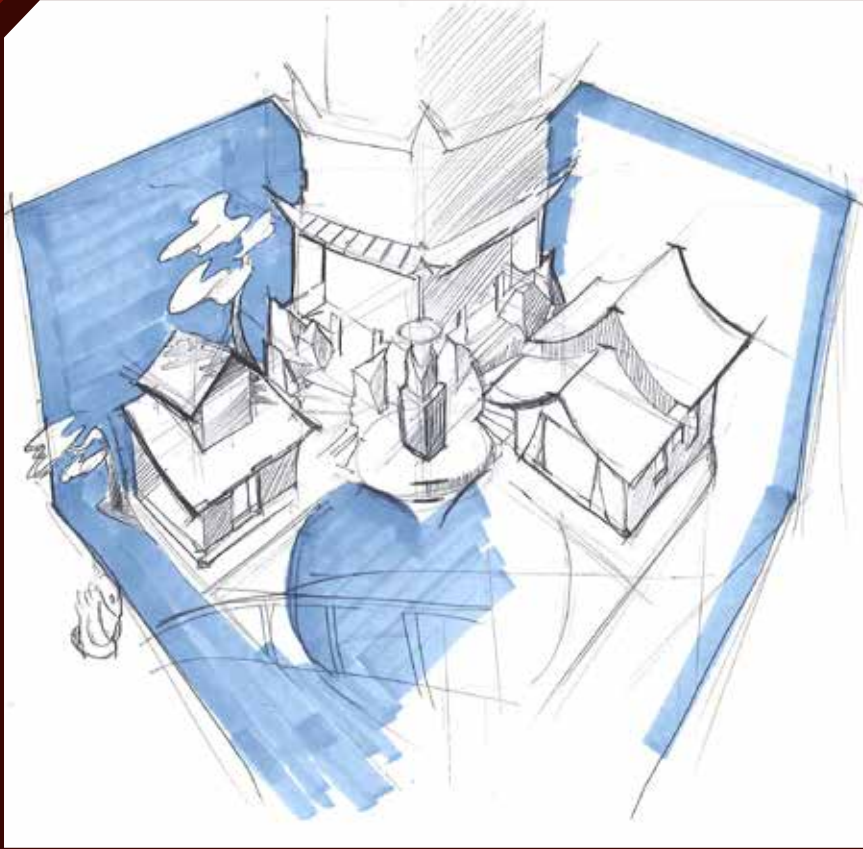

The model is close to its final version. The symmetrical layout has started to take shape, and the different heights of the buildings make for an interesting outline. You can tell that there is a focal point where the statue is in the middle of the fountain and the sides extend to fit the two extra buildings. I really get attached to small details such as the tree shade on the rooftop of the blacksmith's shop, so I ended up adding dried leaves to get a similar effect.

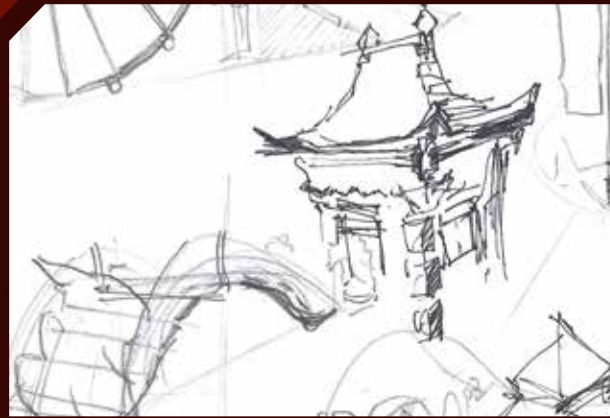

Rough quick sketches that helped me get comfortable with the difficult-to-build shapes that are common to Asian-style buildings.



The smuggler's market has stayed mostly untouched with its open structure. The difficult part was deciding on a roof. The garage door segments allowed me at least two options for soft shapes that would reflect the symbolic style. In the end, the more recognizable and intricate double roof was chosen. More details were added with time, such as the fishing rods, crates, and pathway. I am very fond of the two chickens that have taken up residence in the vicinity, probably lured in by the smell of baguettes.

DESIGN FACTS



A very modest-looking house, which in the early days of development set the tone of voice all the way to the final version. At this point, I knew I wanted to include at least one building that had an interesting wooden structure in its walls. This came to life in the blue blacksmith's shop.

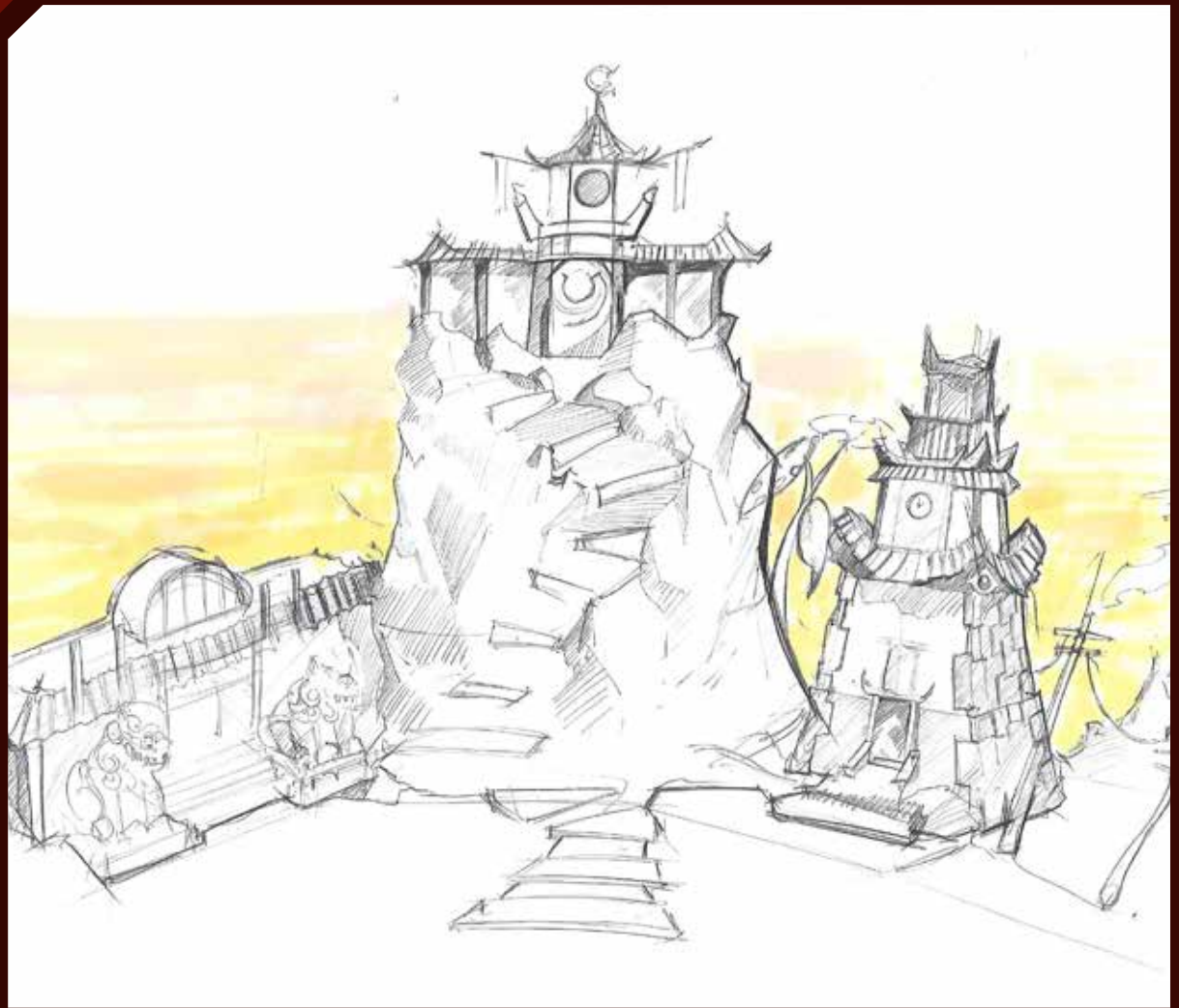

Early on in the process of designing, I was very inspired by the freedom that a model this size offers. Detailed cliffs and wild trees were something I've always wanted to build as part of a model. The cliff went down in size and was replaced by the pagoda-inspired structure. In this early sketch, the direction was different and I wanted to throw in some references to Darkley's Boarding School for Bad Boys and the NINJAGO City Museum, although it made little sense for them to stand side by side.

CHARACTER OVERVIEW

THE NINJA

Although any one ninja is powerful, as a team, they are almost unstoppable. The ninja help each other, support each other, and in battle, they are always watching each other's backs. While they have their share of arguments, each one will risk anything for his friends and the team.



KAI



JAY



ZANE



COLE



LLOYD



NYA



WU

THE POSTMAN

The hardest-working man on NINJAGO Island. A former post office worker, this postman decided as he reached retirement age that he needed to get more fresh air and exercise. He started delivering the mail (and packages with new ninja outfits) himself, but alas, he had not taken into account how dangerous the NINJAGO world could be. That's why he has developed a wide variety of strange vehicles that can help him get the mail out to even the most remote locations.



JESPER

Employed to make Yang's Haunted Temple into a pristine tourist attraction, he unfortunately hasn't been doing a very good job. It's difficult to take care of a haunted temple when you're afraid of ghosts. He is a very skilled landscaper and gardener, but his fear keeps him at a distance, so the grounds far from the temple are much better kept than the temple itself. If the temple is one day cleared of its ghoulish reputation, then he will undoubtedly do a great job. Until then, it's good that he has his daughter...



CLAIRE

The polar opposite of her father, she hangs around the Temple all the time, not afraid to do some repairs and whatever else her father is too frightened to do. In fact, she LOVES ghost stories, and in secret she spends as much time as she can investigating the Haunted Temple. She knows every nook and cranny, and has pretty much unraveled all of the mysteries and dark secrets of the temple...but she keeps it to herself because she doesn't want to scare anybody, especially her father.

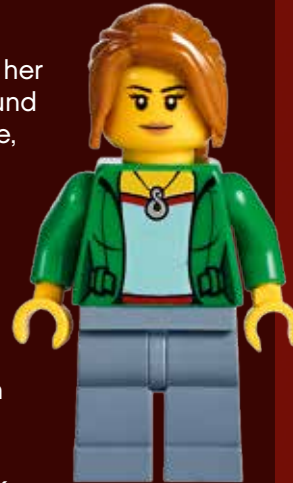

MISAKO

Misako is an archaeologist for the NINJAGO Museum of History and Lloyd's mother. Her commitment to her research, particularly in figuring out how to prevent the prophecy of the Green Ninja from coming true, kept her away from Lloyd throughout much of his life. Her knowledge and expertise become key to the ninja team's epic journey.



DARETH

Dareth is the owner of a small dojo called Grand Sensei Dareth's Mojo Dojo, where he teaches a small group of students. Dareth is a laid-back teacher, but a little full of himself. He often tries to prove that he's good enough to be one of the ninja, though he usually fails miserably. Nonetheless, Dareth remains a devoted friend and supporter of the team.



MOVIE THEATER

The shadow theater in the model tells a story that is simple enough to be interpreted in many different ways. The silhouettes might even be spirits trapped under the temple, forever reliving their moment of glory, learning how to master the secrets of Airjitzu in an epic fight. But was it their last fight?

The snake for me represents the Great Devourer, the ultimate baddie in the Year of the Snake, and one of the most impactful villains in the LEGO NINJAGO world. The mini Great Devourer could be sneaking in for a bite, and spinning in circles is the best way to defend against the venomous fiend. If you try moving the snake closer to the light-brick, the shadow will grow, and you can recreate a scene of Garmadon and his brother Wu fending off the powerful foe.



THEATER FACTS

It was through a coincidence that I came up with the theater. It just so happened that the Temple of Airjitzu was being designed at the same time that I stumbled upon this alternate use of the light brick, so I knew I had to add this fun new function to the model. The use of shadows can be very symbolic, and it seemed like a perfect fit in the context of the NINJAGO world. It's also an exciting new way of using the light brick, since its 2x3 size can make it a bit clumsy to fit into certain models.

In the days designing the theater and the mechanics behind it, I started playing around with different elements that had interesting effects, such as transparency or odd pieces that projected different kinds of shadows. Once I decided on using the tiny yet adorable trophy figure to represent the characters, the next step was adding movement. A fun challenge was linking the functions together, giving it this old-time kinoscope feel. You will also notice how the shadows of the characters grow and shrink in size depending on their distance from the light. If the stone steps are removed on the left side, you can also remove the light brick



easily by tapping the wall.

The shadow play has served as a simple yet captivating form of storytelling since ancient times, and has been a part of mythology and entertainment throughout history. Long before the invention of film, the original shadow theater came to be in ancient China, and quickly spread throughout Asia as a traditional art form. Groups of traveling artists would set up plays using myths and legends as subjects and music to accompany the story. I have also heard that it brings good luck!

I think it's a very fun and original function that I hope everyone will enjoy. You can add to it to create your own story, and there are no limits to its functionality. Some say it tells the story of two brothers fighting an unstoppable foe, but I like to think of it as open to interpretation.



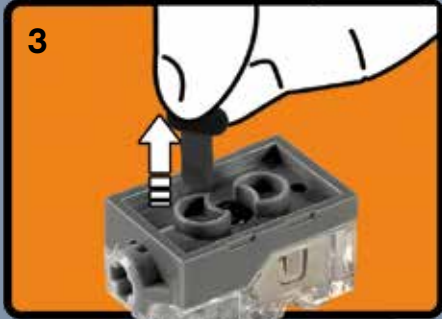

1:1
2X LR 41 1.5V

HR

Važne obavijesti o bateriji

Nikada nemoj koristiti različite vrste baterija zajedno, isto tako ni kombinaciju starih i novih baterija. Uvijek izvadite baterije ako dugo nećeš koristiti proizvod ili ako su one potrošene. Nikada nemoj koristiti oštećene baterije. Koristi samo preporučenu vrstu ili odgovarajuću vrstu baterija. Umetni baterije pazeci da dobro okreneš polove. Akumulatorske se baterije moraju puniti uz pomoć propisanog punjača i uz nadzor odrasle osobe. Baterije se ne smiju puniti dok su još u proizvodu i to nikada nemoj pokušavati. Nikada ne pokušavaj puniti baterije koje nisu predviđene za punjenje. Nikada ne izlazvaj kratki spoj u držaču baterija.

SR

Važne informacije o baterijama

Nikada ne koristite različite tipove baterija zajedno niti kombinaciju starih i novih baterija. Uvek izvadite baterije ukoliko proizvod nežete duže vreme koristiti ili ukoliko su baterije prazne. Nikada ne koristite oštećene baterije. Upotrebljavajte samo preporučeni tip baterija ili odgovarajuću zamenu. Stavite baterije tako da su polovi pravilno pozicionisani. Baterije na puñeње se moraju puniti odgovarajućim punjačem pod nadzorom odraslog liиa. Baterije ne smete da pуните нити да покушате пунити док су у производу. Nikada ne pokušavajte da pуните baterije koje ne mogu da се пуне. Nikada не преспјајте полове кућишта за батерије.

SL

Pomembne informacije o baterijah

Nikoli ne uporabljajte skupaj različnih baterij ali kombinacije starih in novih baterij. Vedno odstranite baterije, če izdelka dlje časa ne boste uporabljali ali če so iztrošene. Nikoli ne uporabljajte poškodovanih baterij. Uporabljajte le baterije priporočene ali ustrezneга tipa. Baterije vstavite tako, da so njihovi polji pravilno obrnjeni. Akumulatorske baterije je treba polniti s pravim polnilnikom pod nadzorom odrasle osebe. Akumulatorskih baterij ni mogoče polniti, dokler so še v izdelku. Tega tudi ne smete poskušati. Nikoli ne poskušajte polniti baterij, ki niso akumulatorske. Pazite, da ležišč za baterije ne boste spravili v kratak stik.

RO

Informații importante despre baterii

Nu folosiți niciodată împreună tipuri diferite de baterii, sau o combinație de baterii vechi și noi. Îndepărtați întotdeauna bateriile dacă produsul nu este folosit timp îndelungat sau dacă bateriile s-au epuizat. Nu folosiți niciodată baterii deteriorate. Folosiți numai baterii de tipul recomandat, sau un tip corespunzător. Introduceți bateriile astfel ca polii să fie poziționați corect. Bateriile reincărcabile trebuie reincărcate utilizând încărcătorul corect sub supravegherea unui adult. Nu puțeti reincărca bateriile în timp ce acestea sunt încă în produs, și niciodată nu trebuie să încercați să faceți acest lucru. Nu încercați niciodată să reincărcați baterii nereinărcabile. Nu scurcircuitați niciodată suportul bateriei.

BG

Важна информация за батериие

Не използвайте различни типове батерии едновременно или комбинация от стари и нови батерии. Винаги изваждайте батериите, ако izdelieto няма да се използва продължително време или ако батериите са се изтозили. Не използвайте повредени батерии. Използвайте само батерии от препоръчвания тип или съответстващ на него тип. Поставете батериите така, че полюсите да са разположени правилно. Аккумуляторните батерии трябва да се зареждат с подходящо зареждащо устройство под надзора на възрастни. Батериите не могат да се зареждат, докато са поставени в izdelieto, така че не трябва да се опитвате да правите това. Не се опитвайте да зареждате батерии, които не са акумулаторни. Не свързвайте в късо съединение контактите на отделението за батериите.

LV

Svarīga informācija par baterijām

Nekad vienlaikus nelietojiet dažādu tipu, kā arī vecas un jaunas baterijas. Vienmēr izņemiet baterijas, ja tās ir izlādējās vai ja produkts ilgāku laiku netiek lietots. Nekad nelietojiet bojātas baterijas. Lietojiet tikai ieteicamā tipa vai atbilstoša tipa baterijas. Ievietojiet baterijas, ievērojiet pareizu polaritāti. Uzlādējumu bateriju lādēšanai izmantojiet atbilstošu bateriju lādētāju; uzlāde jāveic pieaugušo uzraudzībā. Baterijas nevar uzlādēt un nekad nedrīkst mēģināt uzlādēt, kamēr tās ievietotas produktā. Nemēģiniet uzlādēt baterijas, kas nav uzlādējamas. Nepieļaujiet issavienojumu bateriju nodalījumā.

ET

Oluline teave patareide kohta

Ära kunagi kasuta koos erinevat tüüpi patareisid, samuti vanu ja uusi patareisid. Kui mänguasja ei kasutata pika aja jooksul, võta patarei sellest välja. Ära kunagi kasuta kahjustatud patareisid. Kasuta ainult ettenähtud tüüpi või neile samaväärseid patareisid. Pane patareid mänguasja sisse nii, et pluss- ja miinusklemmi asend oleks õige. Akusid tuleb laadida ainult neile ettenähtud akulaadija abil täiskasvanu järelevalve all. Akusid ei saa laadida sel ajal, kui need on mänguasja sees. Ära kunagi püüa nii teha. Ära kunagi proovi akulaadijaga laadida tavalisi patareisid. Patareipesa klemmide vahel ei tohi tekkida lühis.

LT

Svarbi informacija apie elementus

Vienu metu nenaudokite skirtingų elementų, taip pat su naujais elementais nenaudokite senų. Jei nenaudosite gaminio ilgesnį laiką arba jei elementai išseko, visuomet išimkite juos iš gaminio. Niekada nenaudokite pažeistų elementų. Naudokite tik rekomenduojamo arba atitinkamo tipo elementus. Elementus dėkite atsižvelgdami į jų poliškumą. Elementus galima įkrauti tik tinkamu krovikliu ir prižiūrint suaugusiesiems. Jokių būdu negalima, ir niekuomet nebandykite įkrauti elementų neišėjus jų iš gaminio. Niekada nebandykite įkrauti vienkartinį elementų. Saugokitės, kad elementų dėkle nesukeltumėte trumpojo jungimo.

TR

Piller hakkında önemli bilgiler

Hiçbir zaman değişik tipte pilleri ya da eski pillerle yeni pilleri bir arada kullanmayın. Ürün uzun süre pilli kullanılmayacaksa ya da piller bitmişse, pilleri çıkarın. Hiçbir zaman zedelemmiş piller kullanmayın. Sadece önerilen tipte piller ya da bunların dengi olan piller kullanın. Pilleri kutupları doğru konumda olacak şekilde yerleştirin. Bitince şarjlı pilleri doğru pil şarj aletini kullanarak, bir yetişkinin denetiminde şarj edin. Şarjlı pilleri, ürünün içindeyken şarj edemezsiniz ve hiçbir zaman bunu yapmaya çalışmayın. Hiçbir zaman, şarjlı olmayan pilleri şarj etmeye çalışmayın. Hiçbir zaman pil kutusuna kısa devre yaptırmayın.



EN Protect the environment by not disposing of this product with your household waste (2002/96/EC). Check with your local authority for recycling advice and facilities.

DE Schützen Sie die Umwelt und entsorgen Sie dieses Produkt nicht mit Ihrem Hausmüll (2002/96/EC). Informationen zu Recycling-Möglichkeiten erhalten Sie bei den örtlichen Behörden.

IT Proteggi l'ambiente! Non smaltire questo prodotto con i rifiuti domestici (2002/96/EC). Per consulenza sul riciclaggio dei rifiuti e le strutture di riciclaggio, rivolgersi alle proprie autorità locali.

NL Bescherm het milieu: gooi dit product niet samen met het andere huisvuil weg (2002/96/EC). Raadpleeg de plaatselijke instanties voor locaties van milieustations en advies over hergebruik.

ES Proteja el medio ambiente no deshaciéndose de este producto junto con sus residuos domésticos (2002/96/EC). Solicite a su autoridad local consejos e información sobre instalaciones de reciclado.

DA Beskyt miljøet! Smid ikke dette produkt ud sammen med husholdningsaffaldet (2002/96/EF). Få vejledning om genbrug og genbrugsstationer hos din kommune.

FI Tämä tuote on hävitettävä ympäristönsuojelun vuoksi asianmukaisesti talousjätteistä erillään (2002/96/EC). Tietoja kierrätyspisteiden sijainnista saa kunnan tai kaupungin teknisestä virastosta.

SV Skydda miljön genom att inte kasta denna produkt bland ditt hushållsavfall (2002/96/EC). Kontakta din kommun för frågor om återvinning och miljöstationer.

PT Proteja o ambiente não eliminando este produto com o seu lixo doméstico (2002/96/CE). Consulte as autoridades locais para informação sobre reciclagem e sistemas de recolha.

EL Προστατέψτε το περιβάλλον. Μην πετάτε αυτό το προϊόν μαζί με τα συνηθισμένα οικιακά απορρίμματα (2002/96/EC). Επικοινωνήστε με τις τοπικές αρχές σχετικά με συμβουλές και εγκαταστάσεις ανακύκλωσης.



PL Aby chronić środowisko naturalne, nie należy wyrzucać tego produktu wraz z odpadkami z gospodarstwa domowego (2002/96/WE). W celu uzyskania wskazówek dotyczących recyklingu oraz adresów zakładów należy skontaktować się z lokalnym urzędem.

CZ Nevyhazujte tento produkt do domácího odpadu, chrňte životní prostředí (2002/96/EC). Zjistěte si prosím u místních úřadů možnosti recyklace a dostupná zařízení.

SK Nevyhadzujte tento produkt do domáceho odpadu, chrňte životné prostredie (2002/96/EC). Zistite si prosím na miestnych úradoch možnosti recyklácie a dostupné zariadenia.

HU Környezetét óvja, ha ettől a terméktől nem a háztartási hulladékkal együtt válik meg (2002/96/EC). Érdeklődjék a lakóhelyéhez közel eső hatóságnál az újrahazsnosítás módjáról és lehetőségéről.

SL Zaščitite okolje! Okolje varujte tako, da tega izdelka ne zavržete skupaj z gospodinjiskimi odpadki (v skladu z direktivo 2002/96/ES). Pri krajevni upravi preverite, kakšne možnosti in kateri obrati za recikliranje obstajajo v vaši okolici.

LV Lai saudzētu vidi, neizmetiet šo izstrādājumu kopā ar sadzīves atkritumiem (2002/96/EC). Vērsieties vietējās varas iestādēs, lai noskaidrotu, kur un kā tas nododams pārstrādei.

ET Keskkonda saate kaitsta nii, et ei kõrvalda seda toodet koos olmejäätmetega (2002/96/EÜ). Nõuandeid toote taaskasutusse võtmise ja ümbertöötlemispunktide kohta saate asjaomase kohaliku asutuselt.

LT Saugokite aplinką – nemeskite šio produkto kartu su buitinėmis atliekomis (2002/96/EB). Atsižvelkite į savo vietos valdžios rekomendacijas dėl pakartotinio panaudojimo ir sąlygas.



LEGO.com/brickseparator

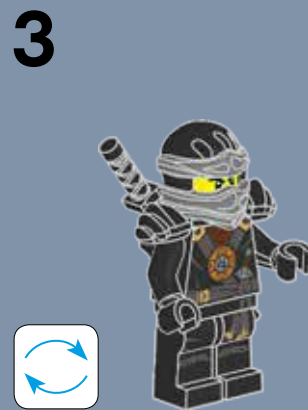
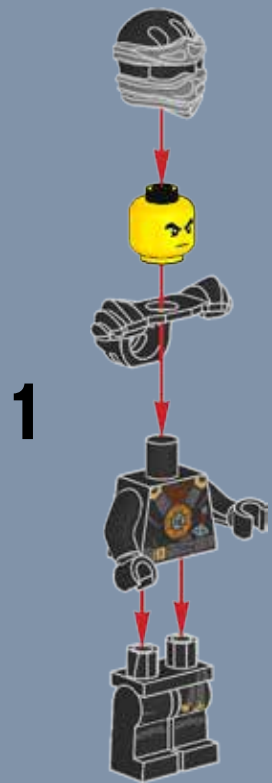
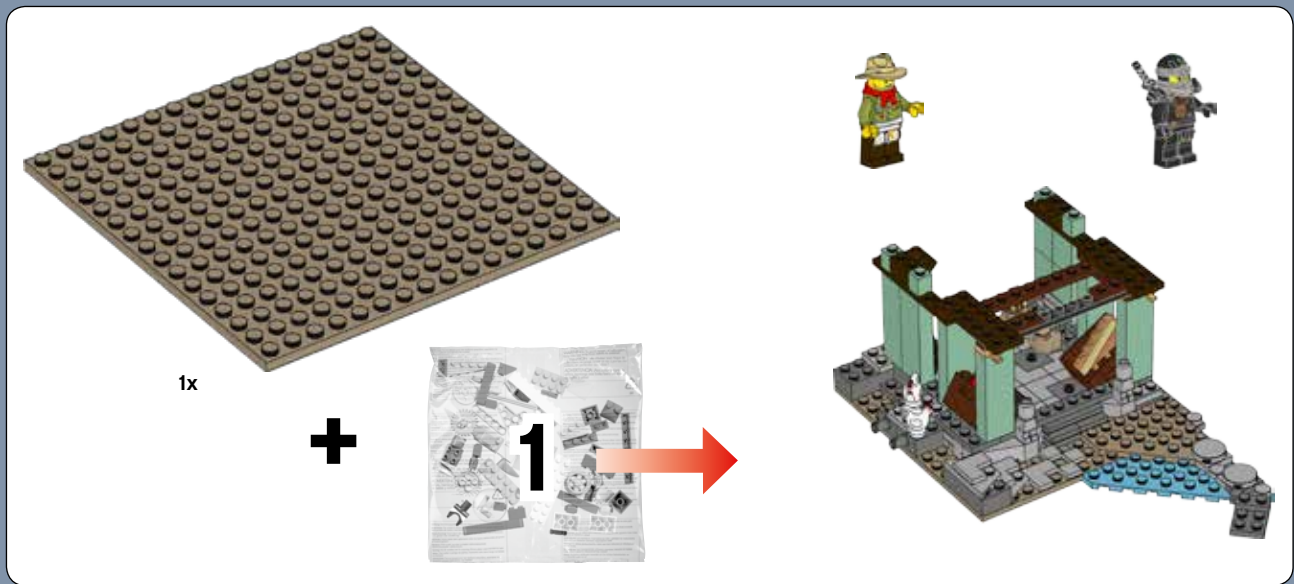

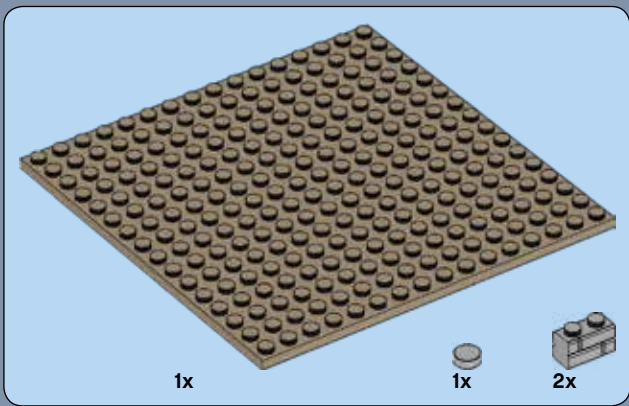

1



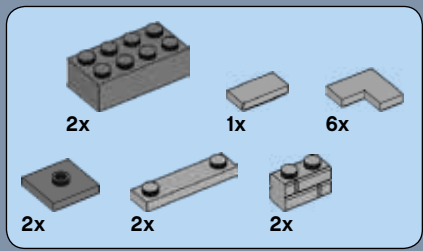

2

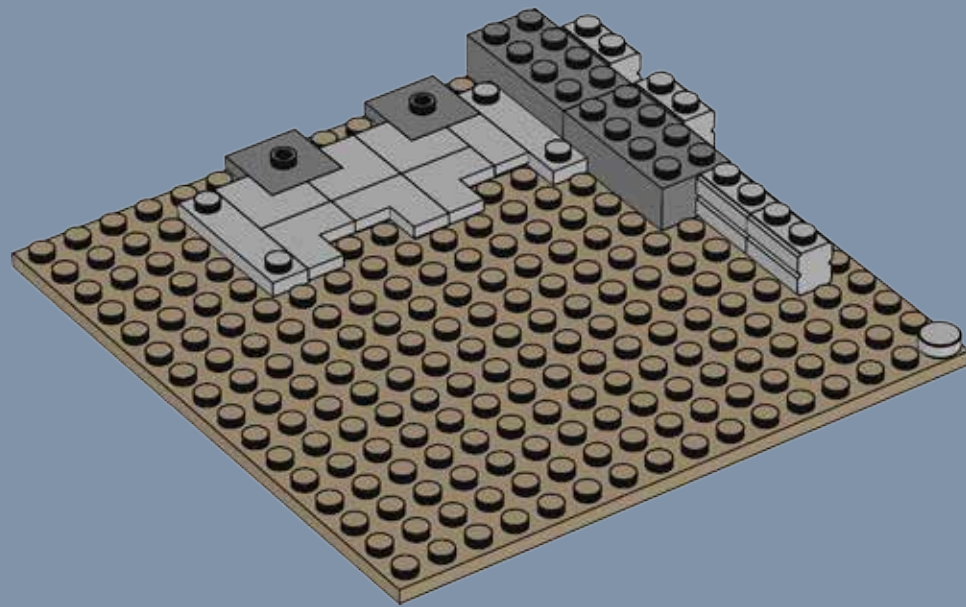

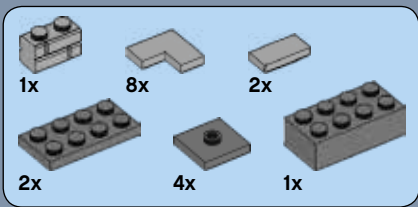

3

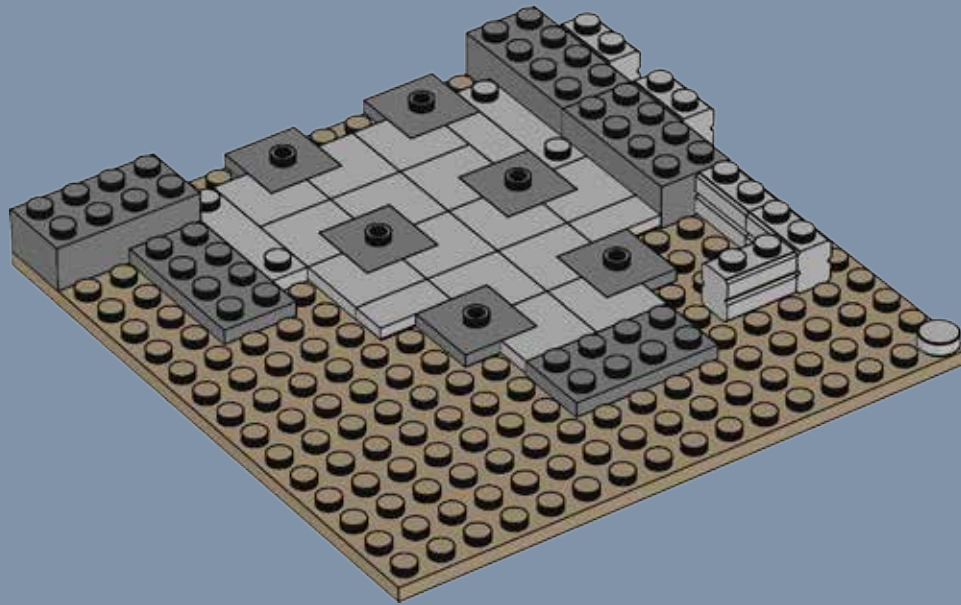



2x



2x



2x

4

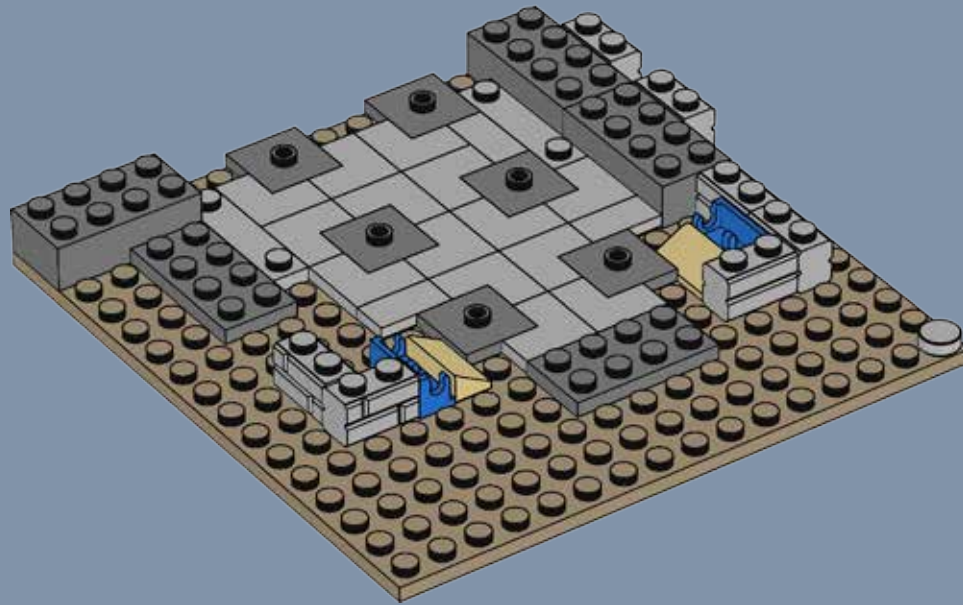

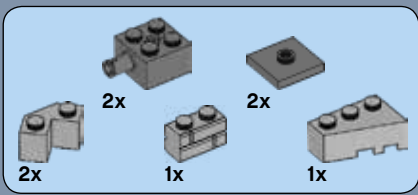

5



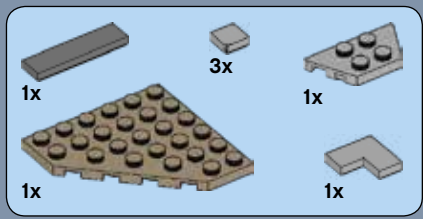

6

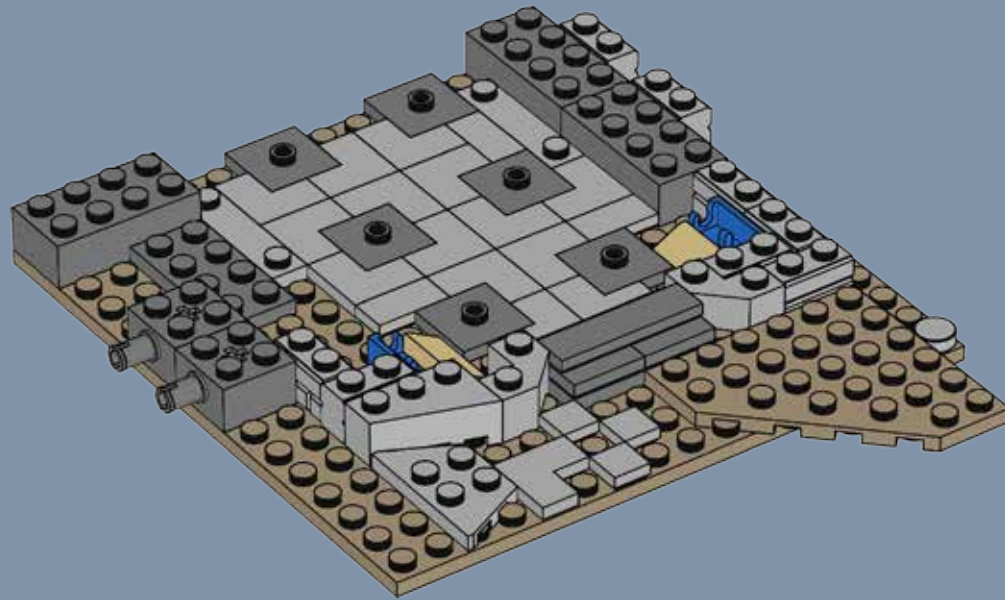

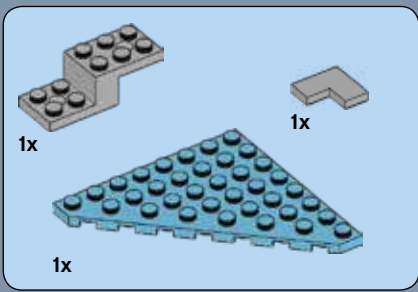

7

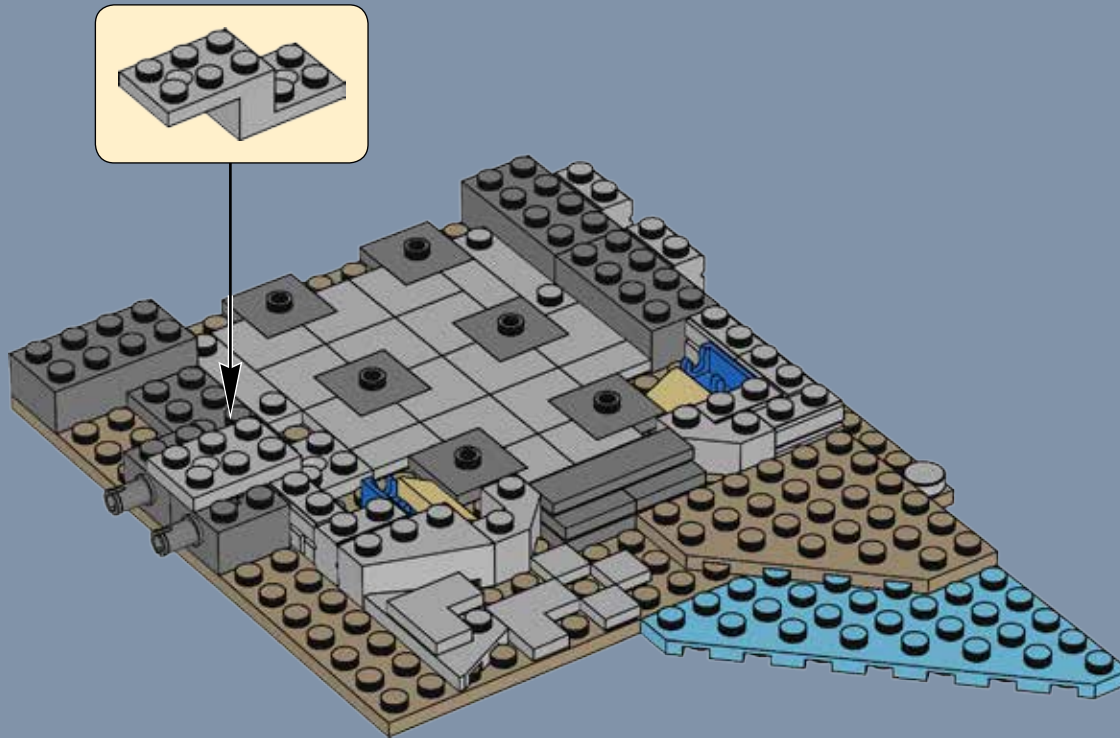

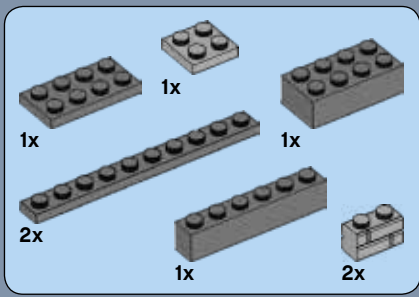

8

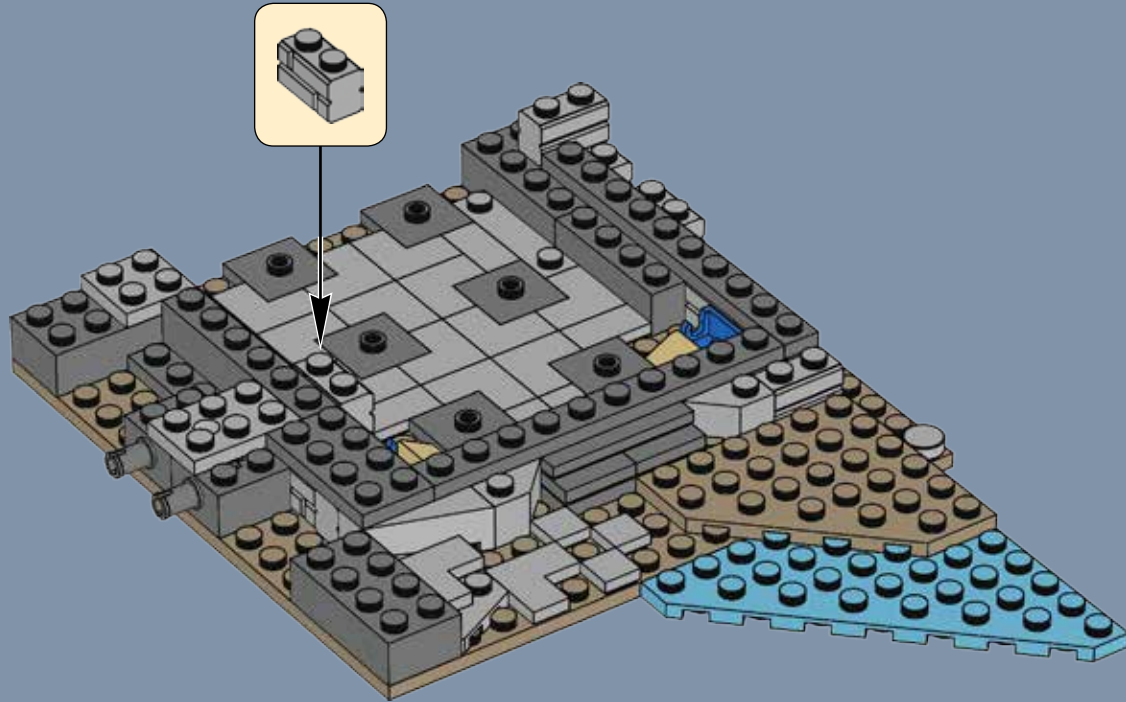

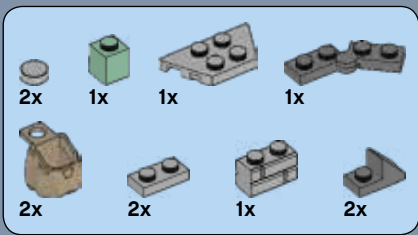

9

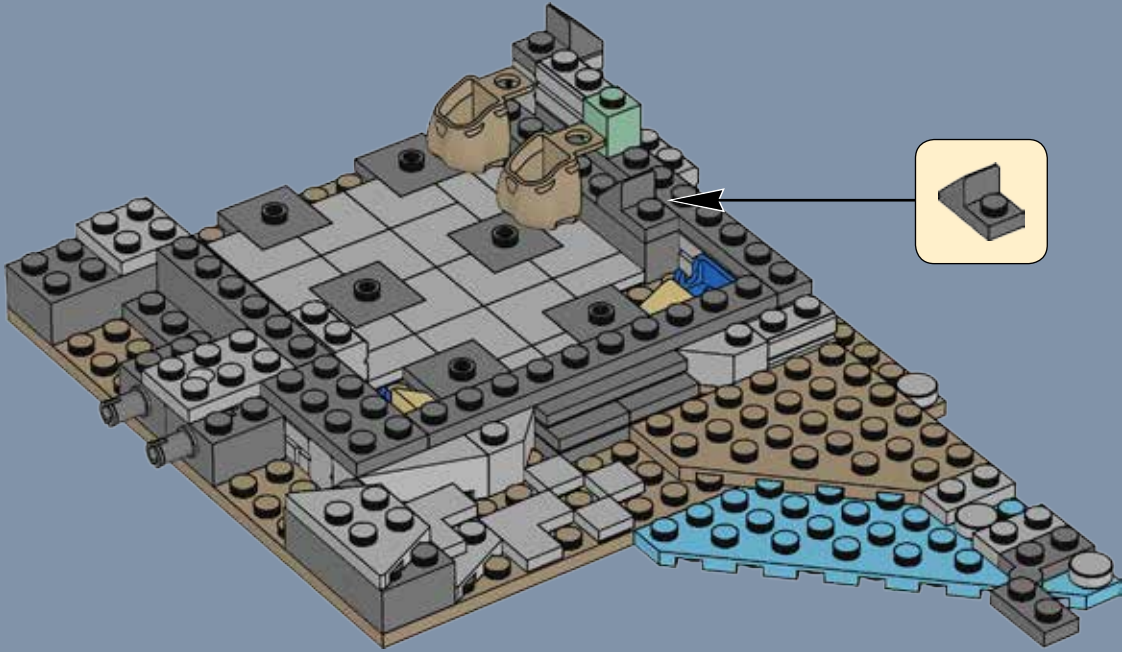



10

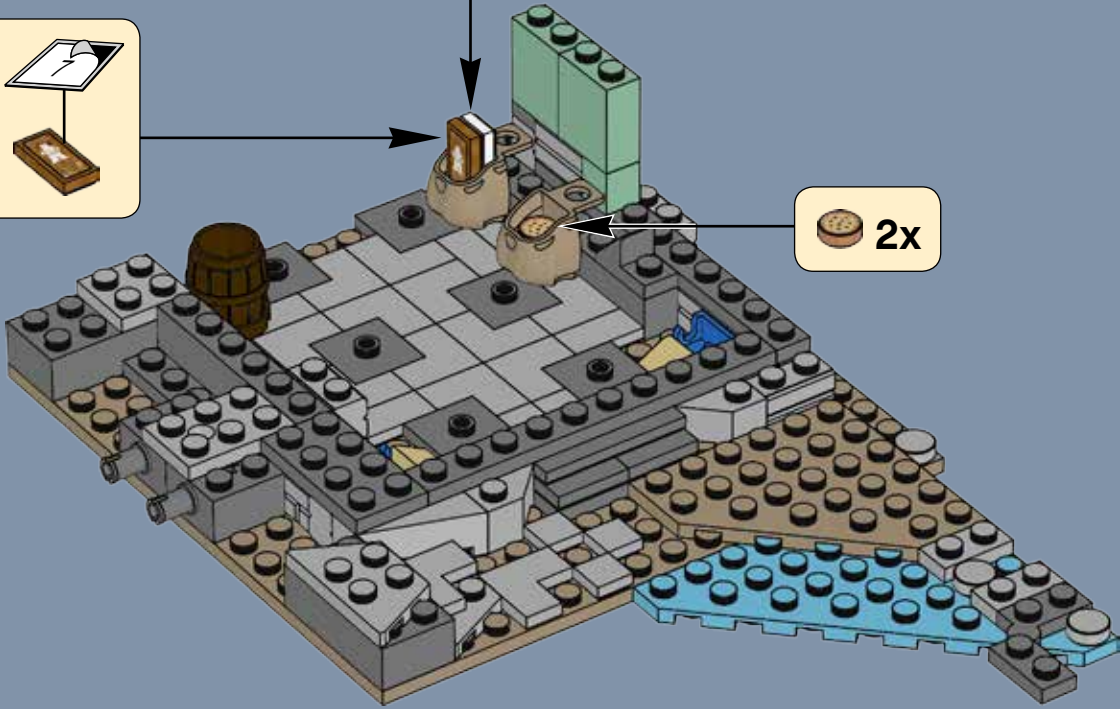
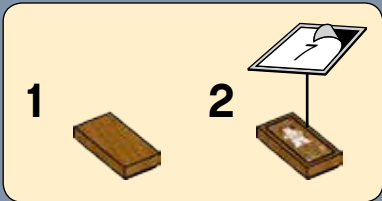
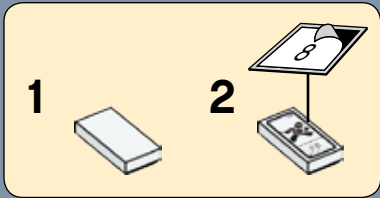

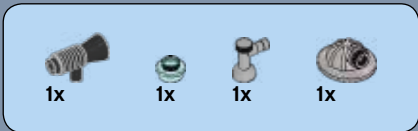

11

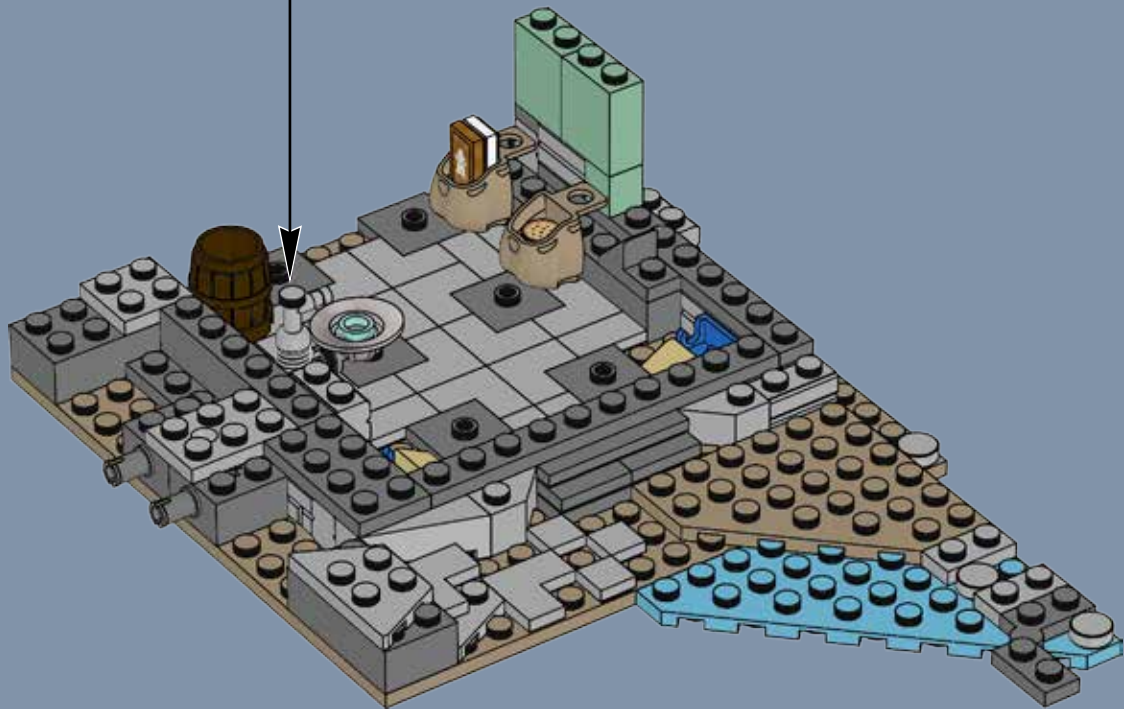

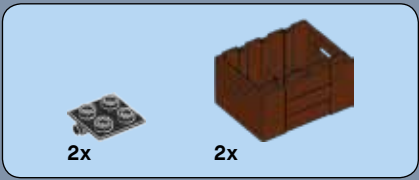

12

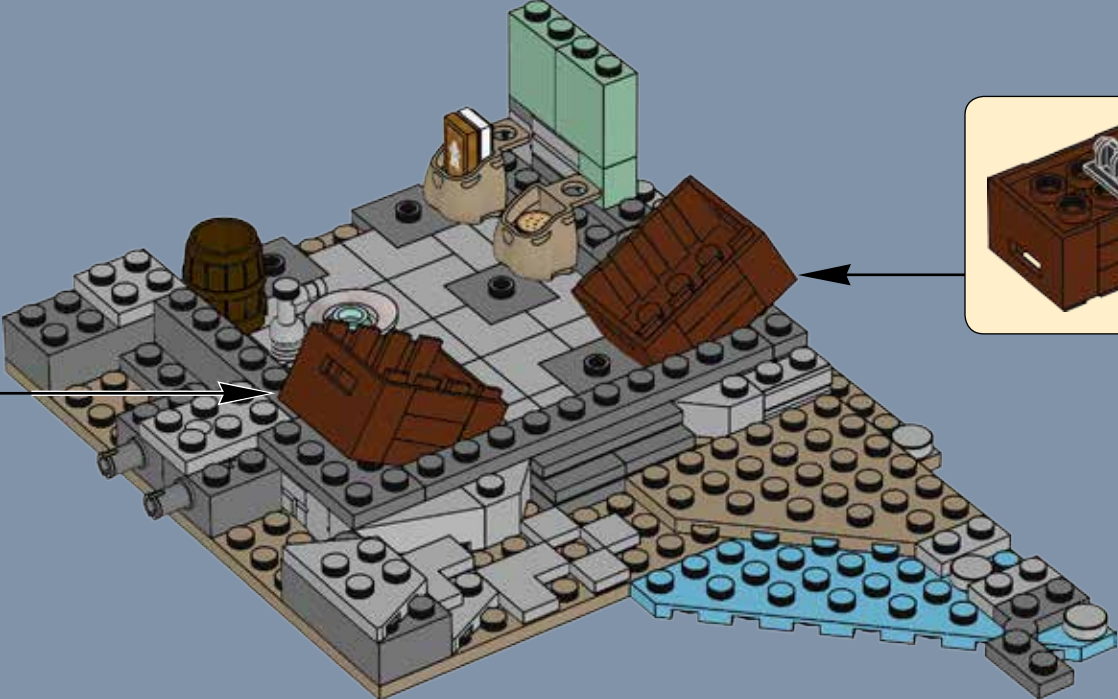

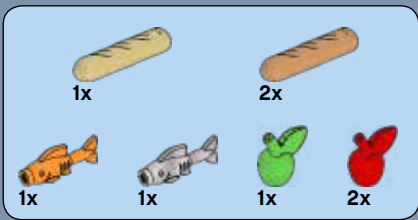

13

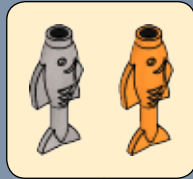
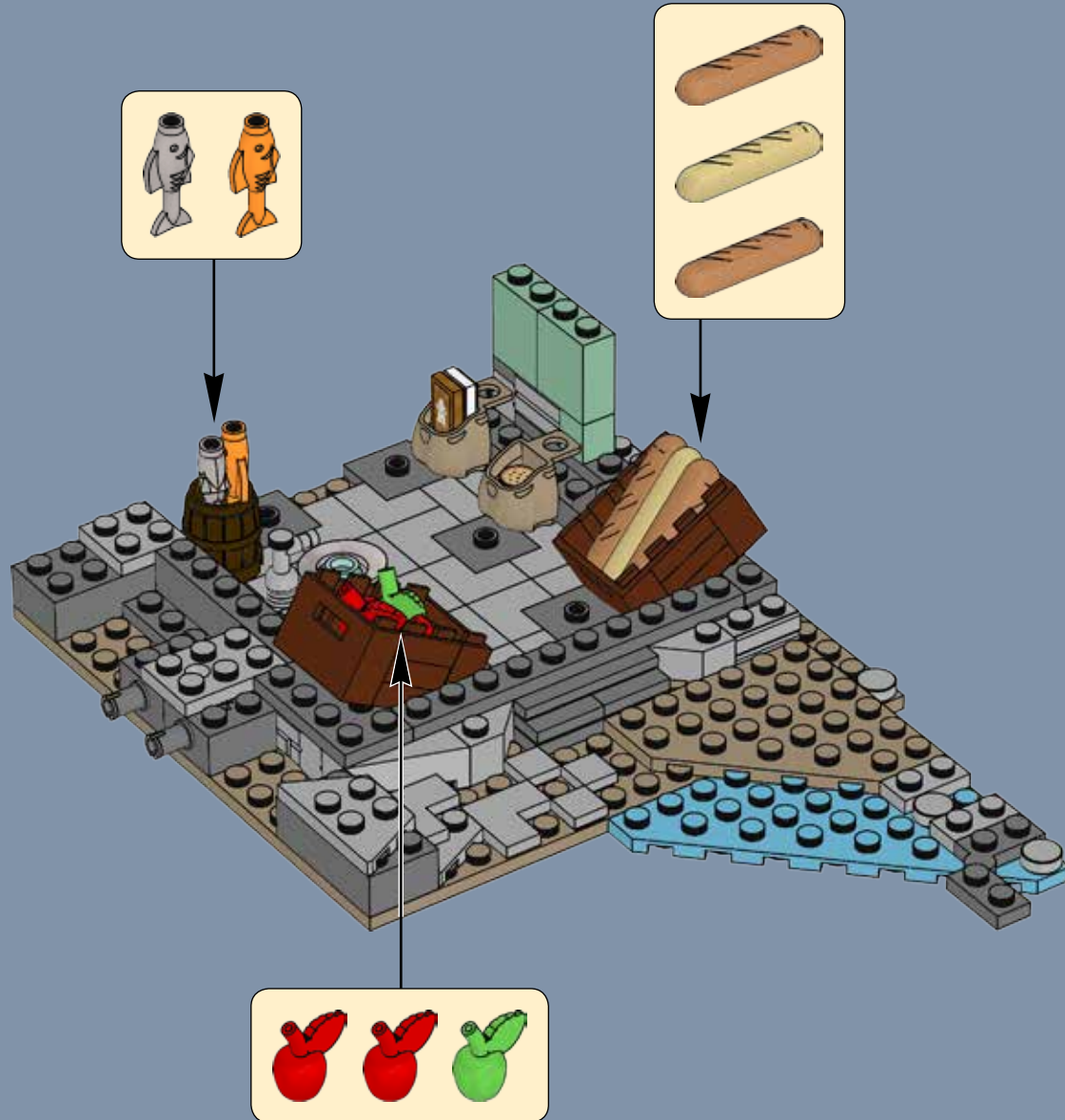

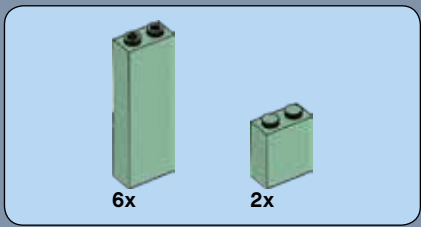

14

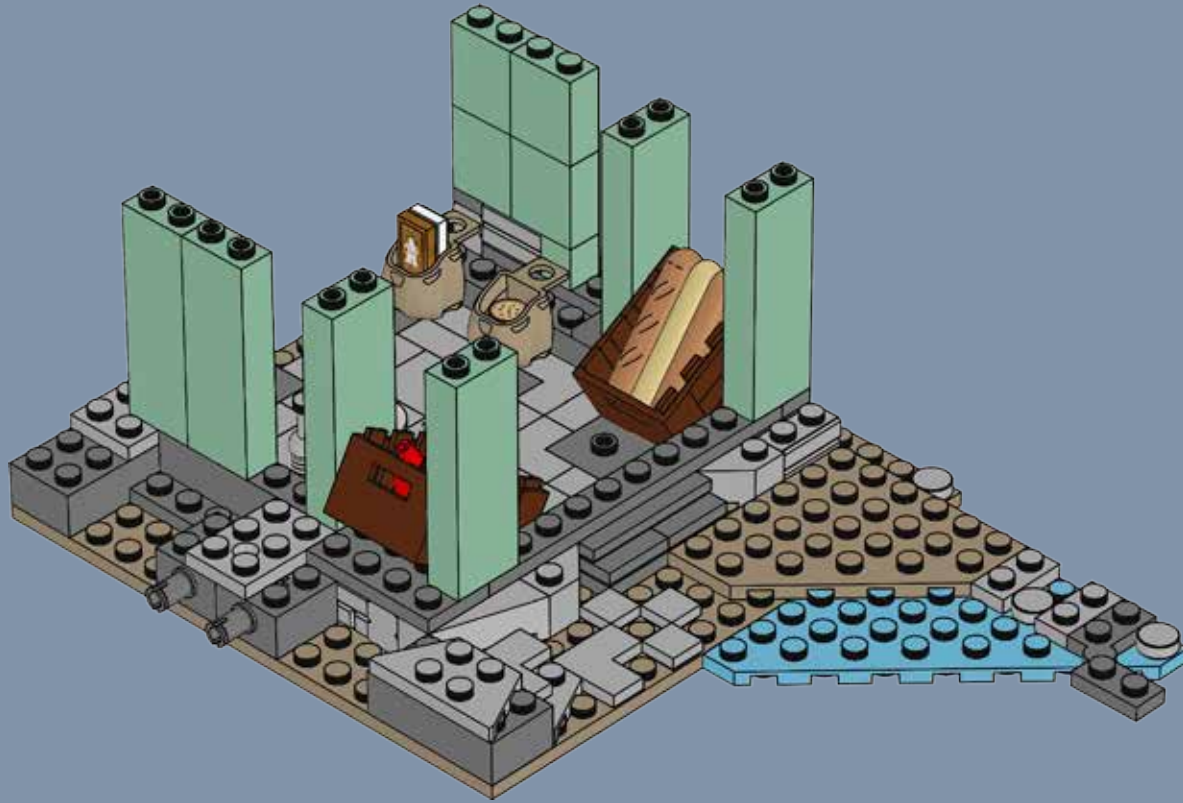



15

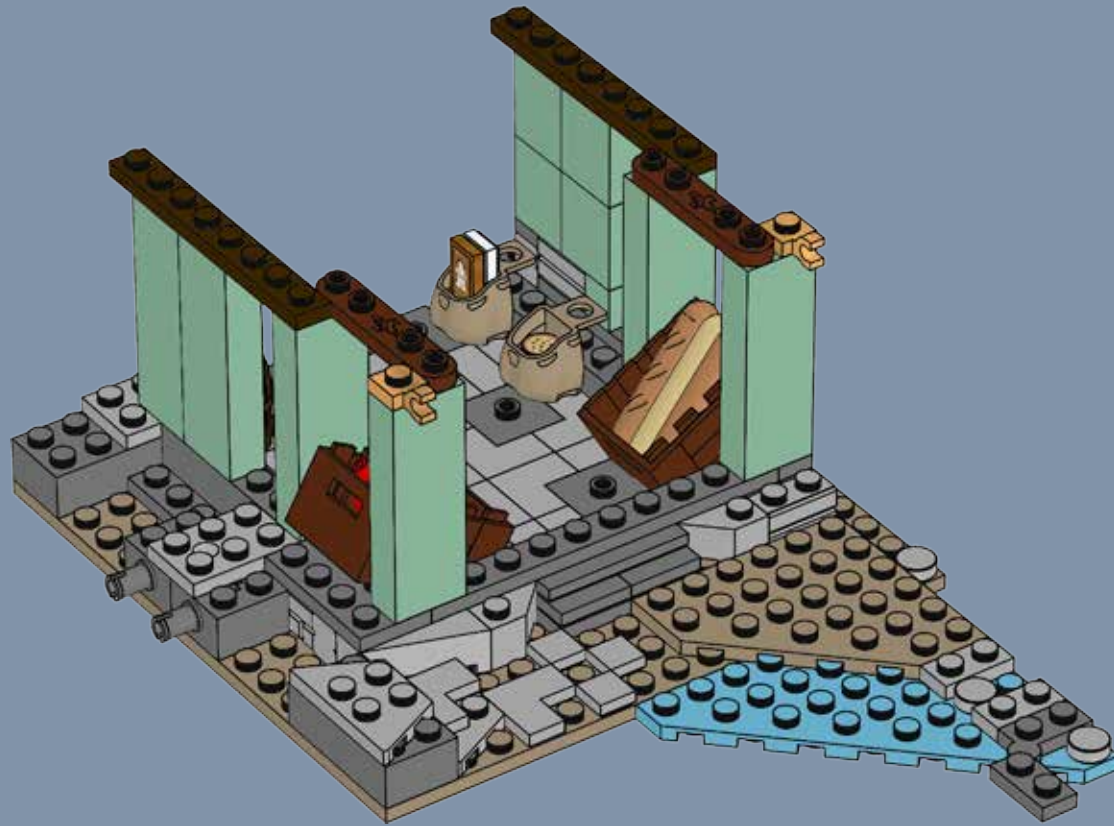

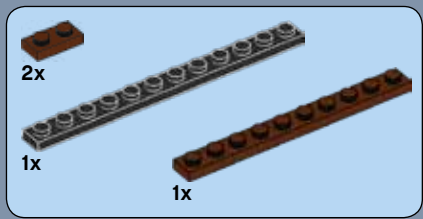

16

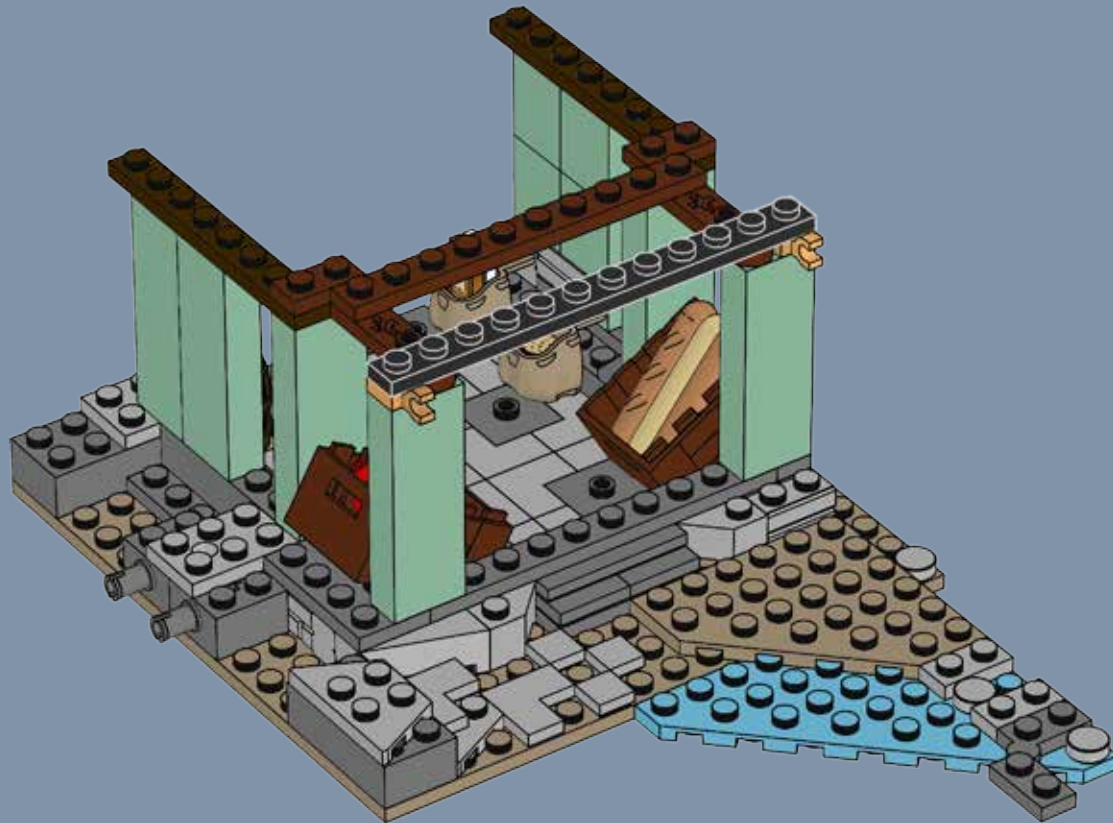

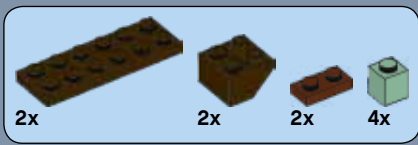

17

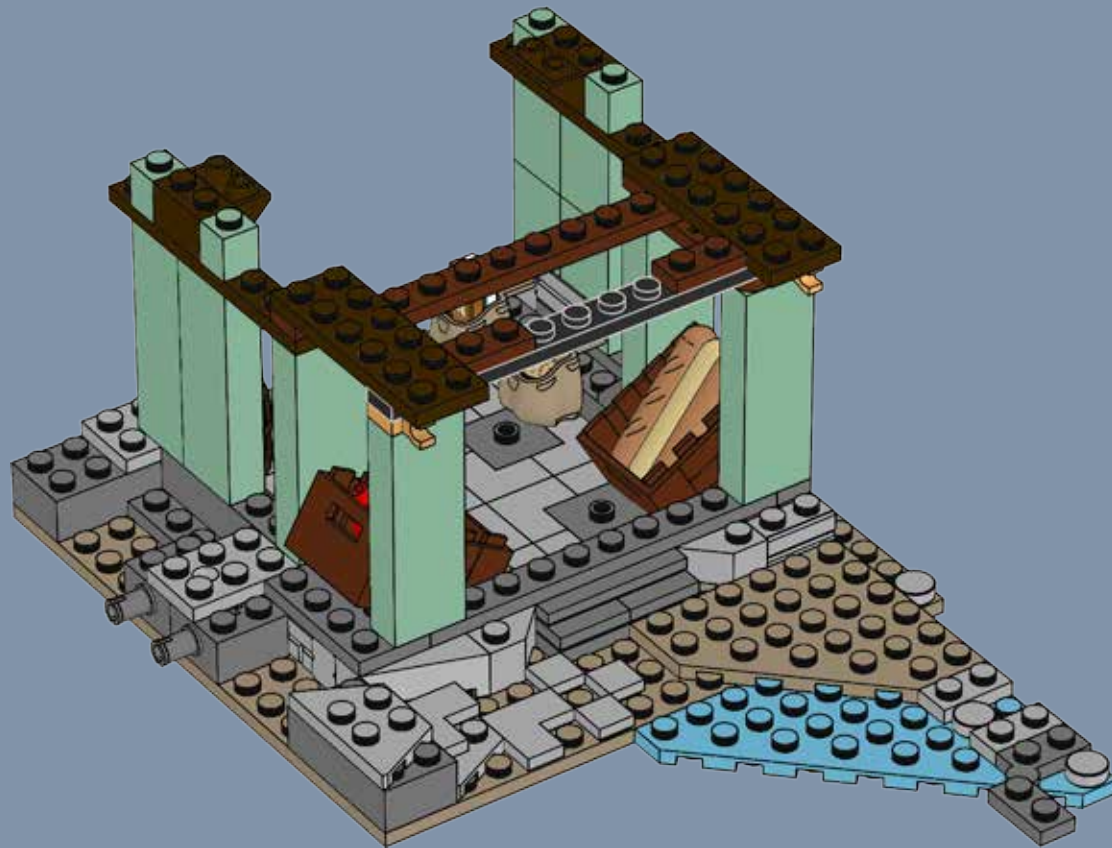

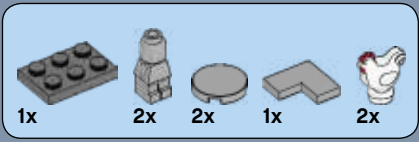

18

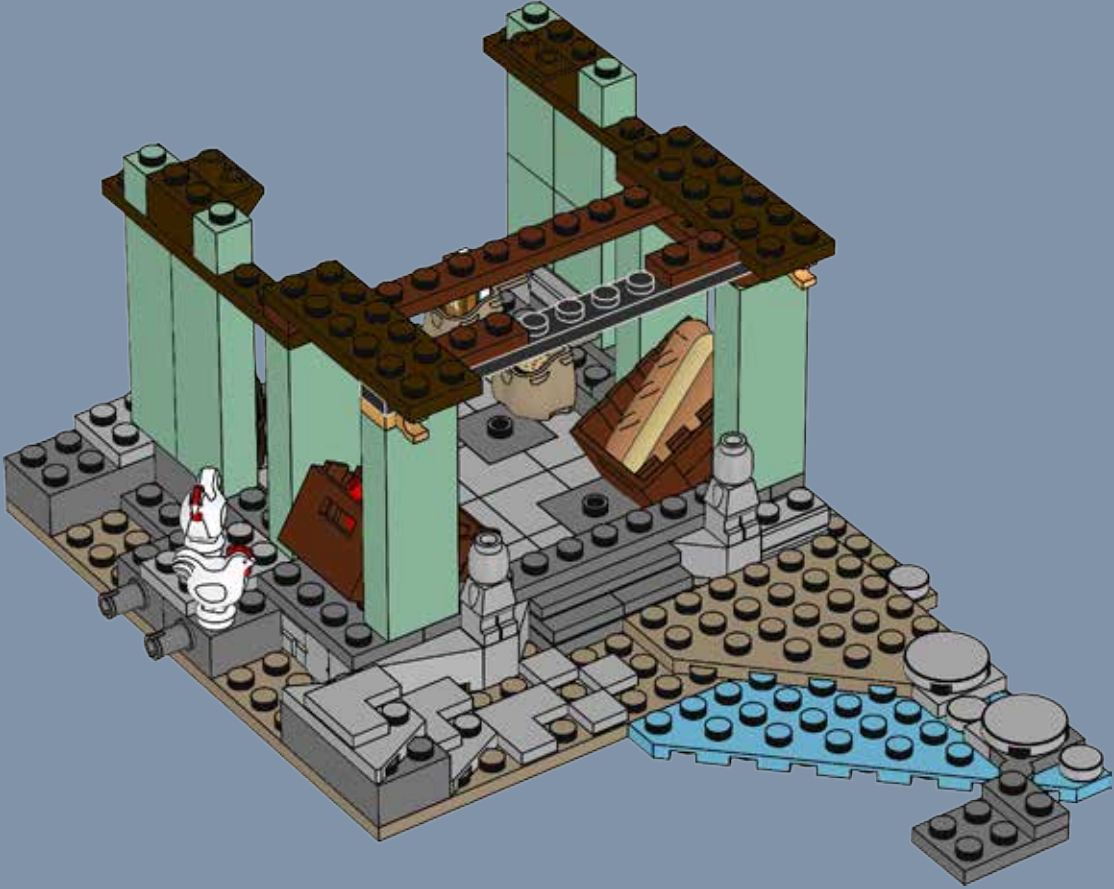

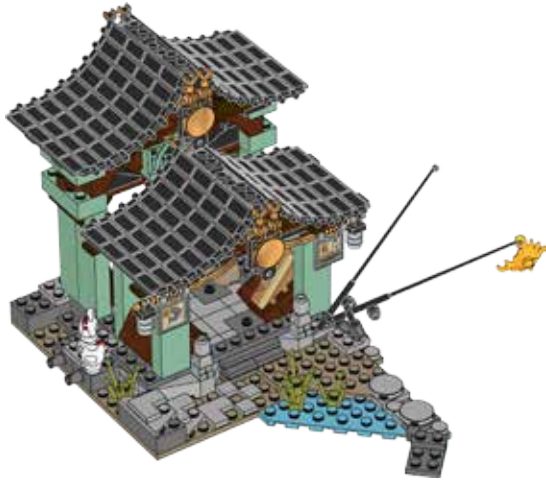
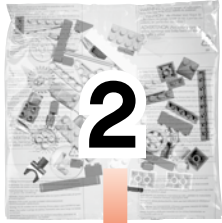

19

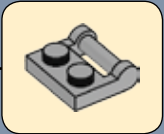
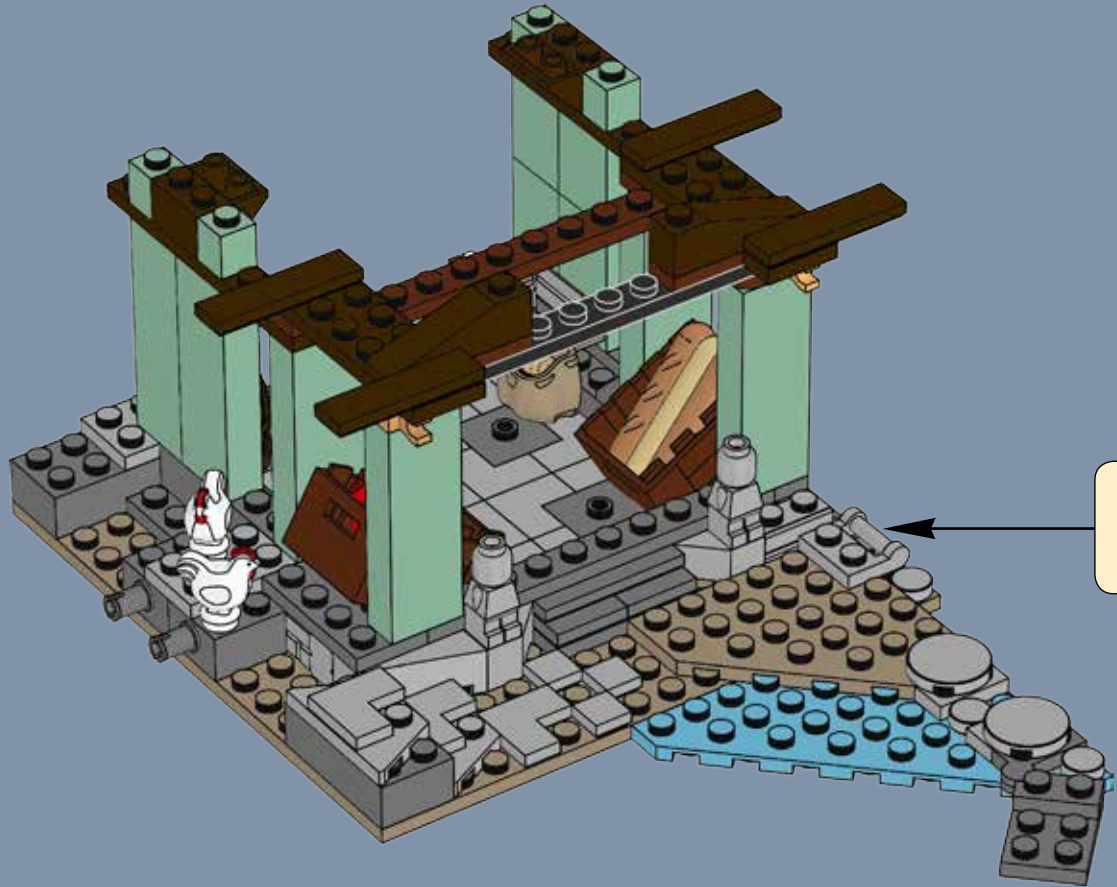

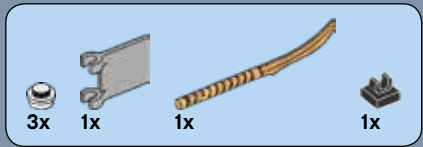

20

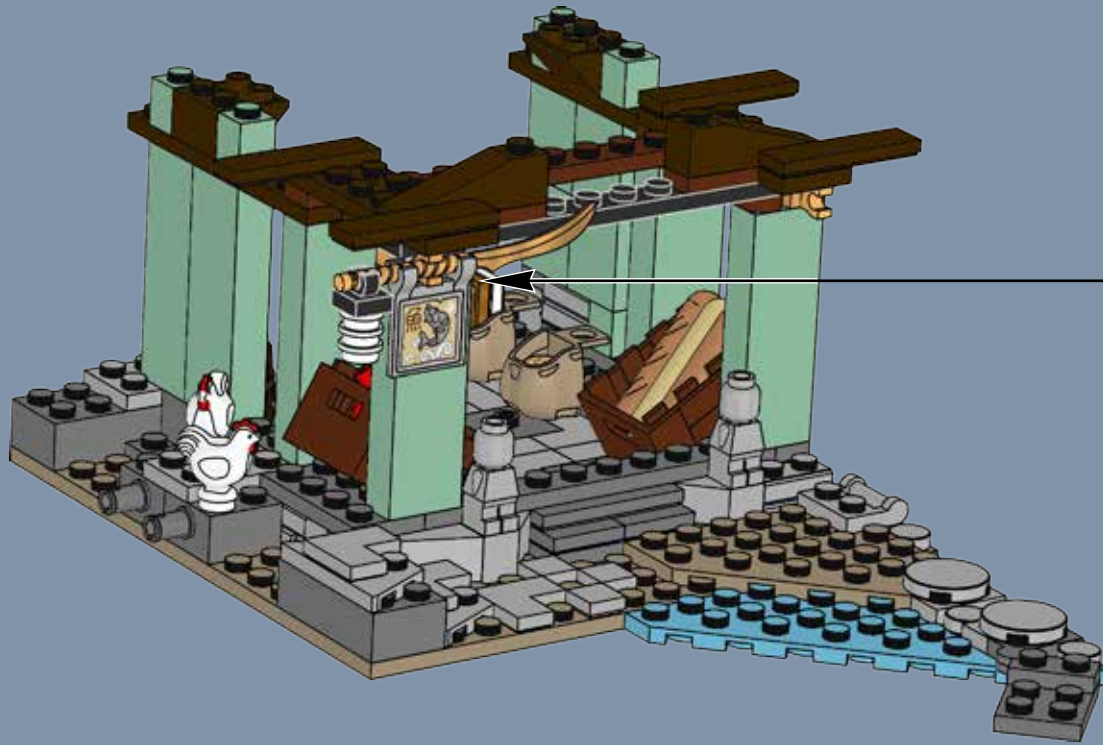
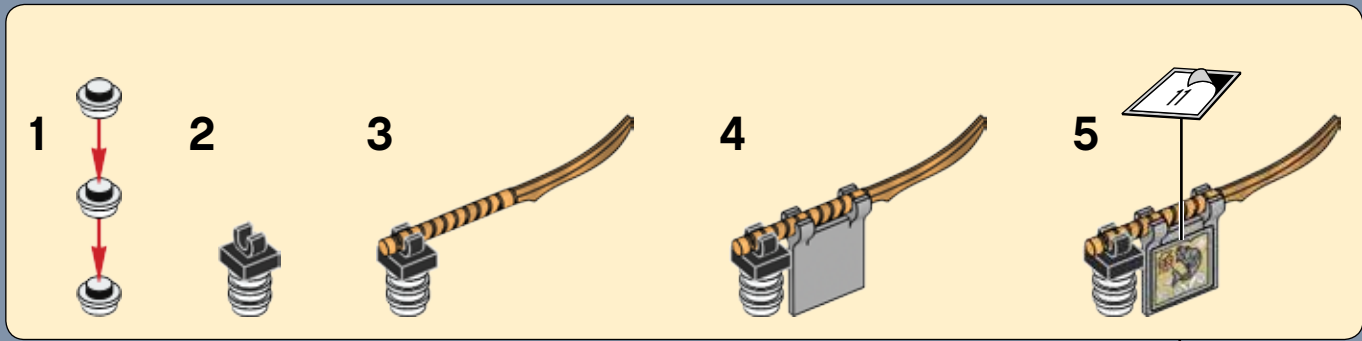

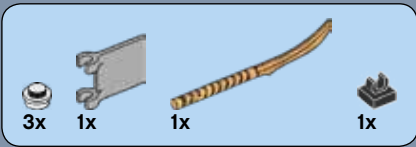

21

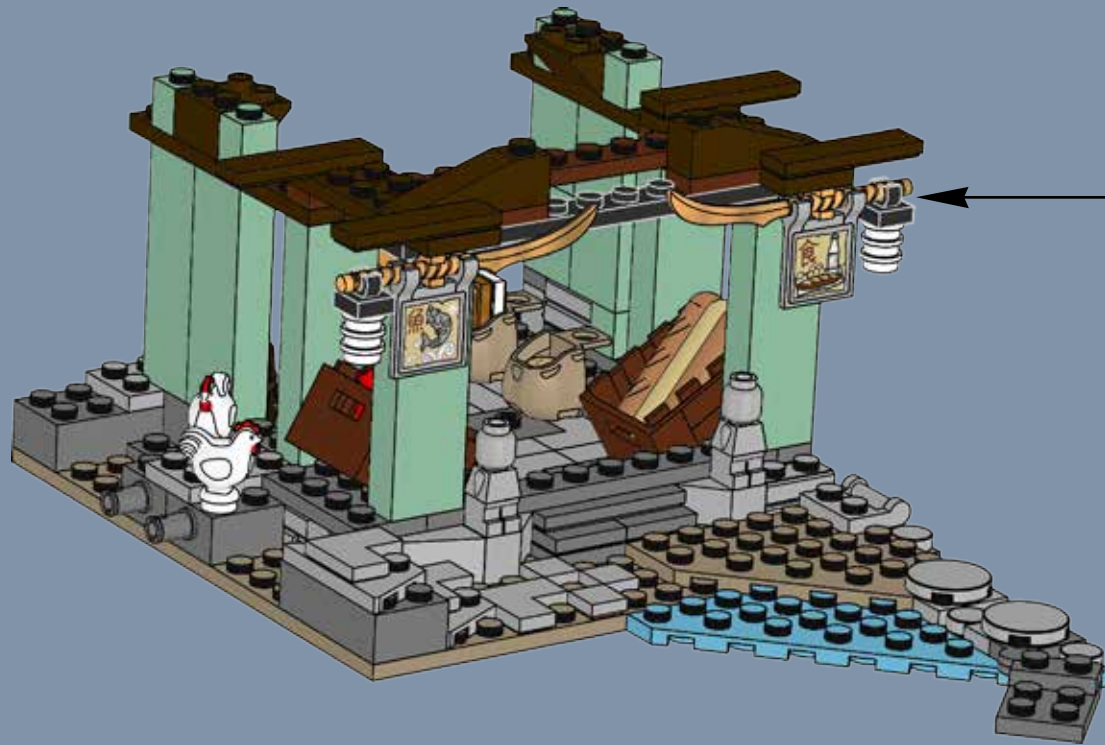

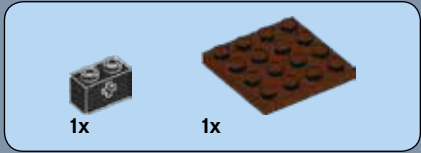
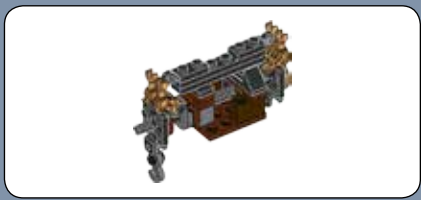

1

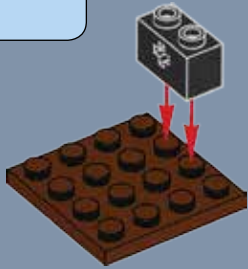

2



3



4

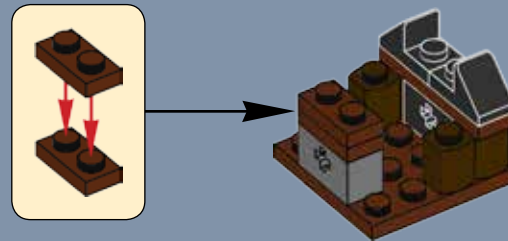

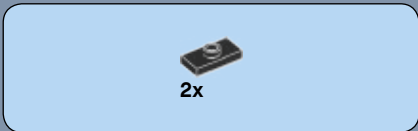

5

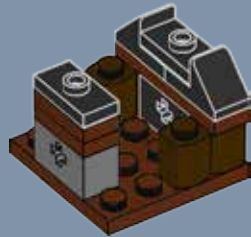

6

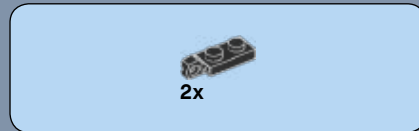
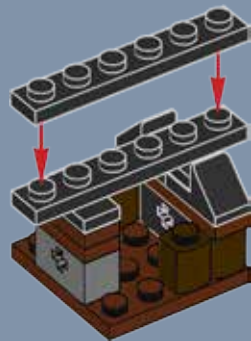

7

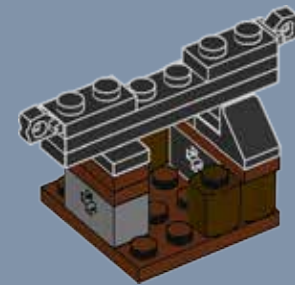

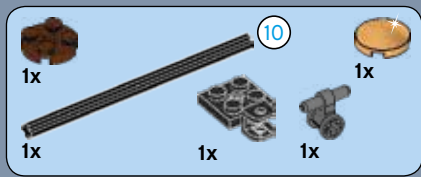

8

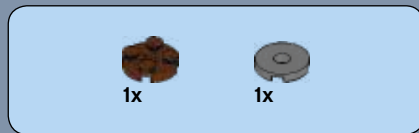
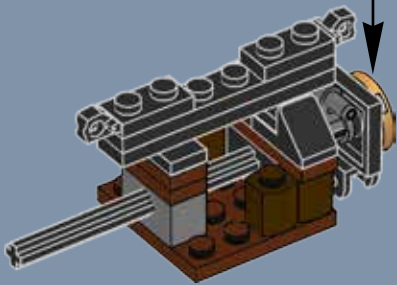
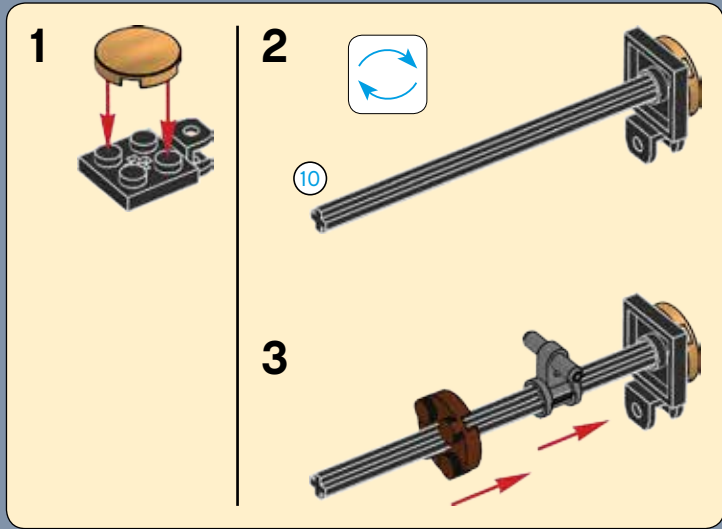

9

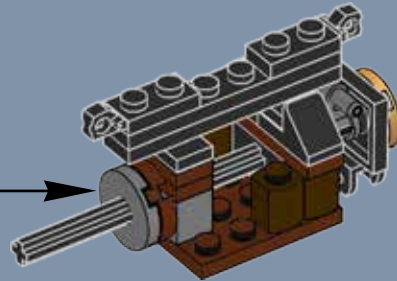

10

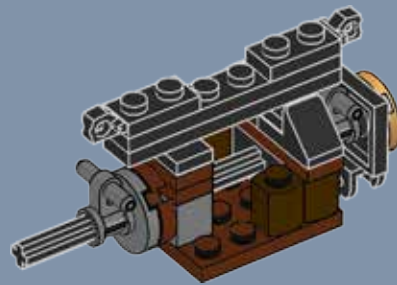



11

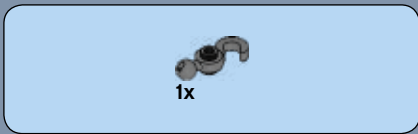
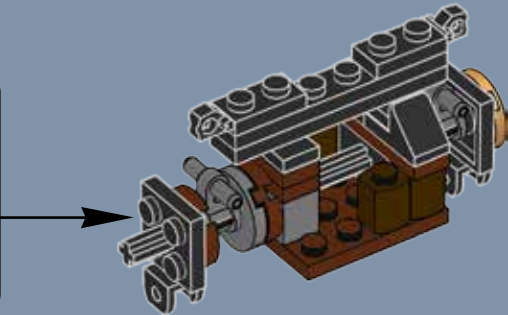

12

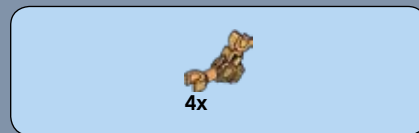
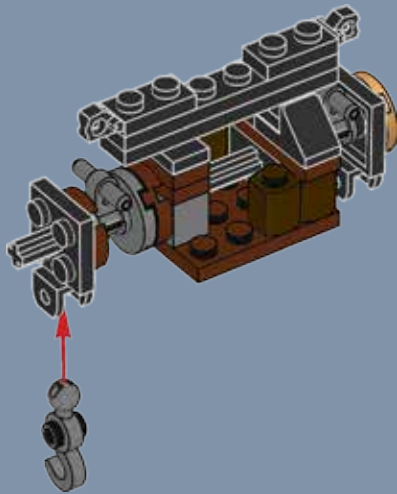

13

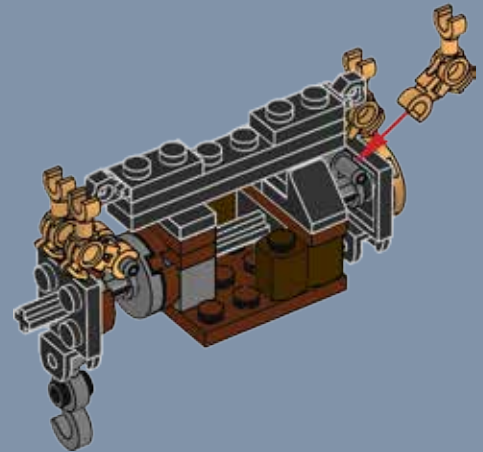

22

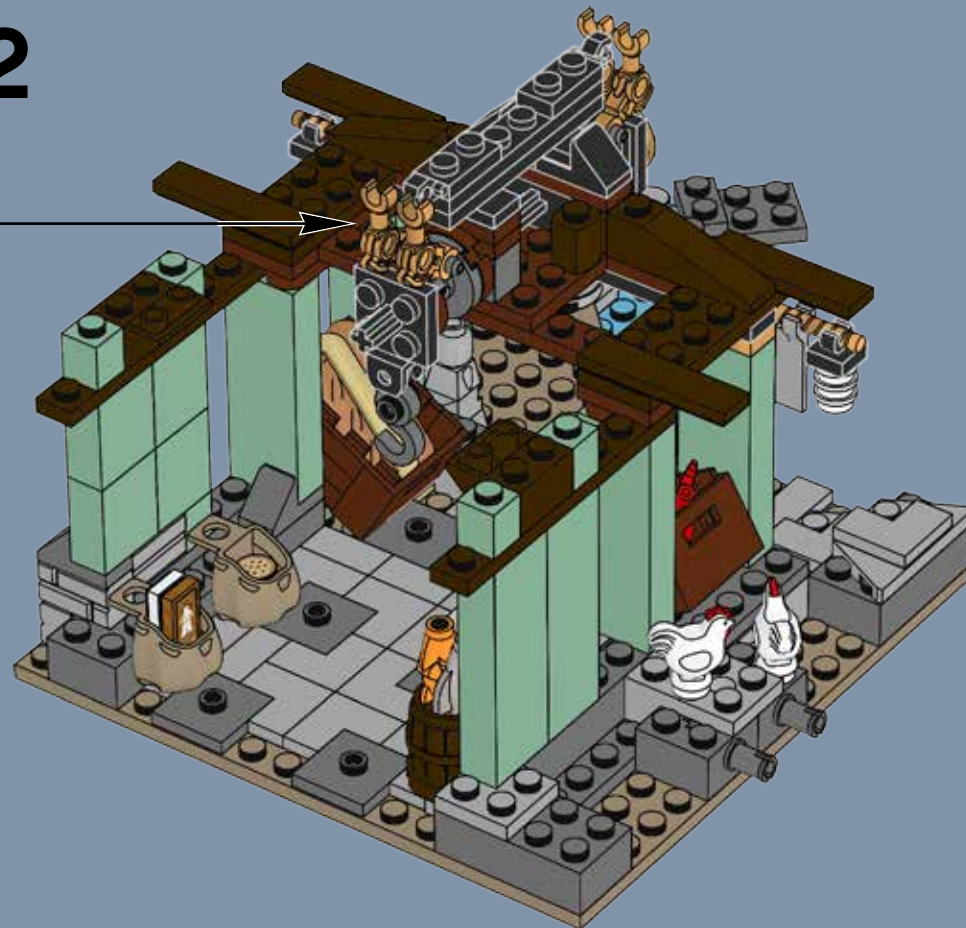



23

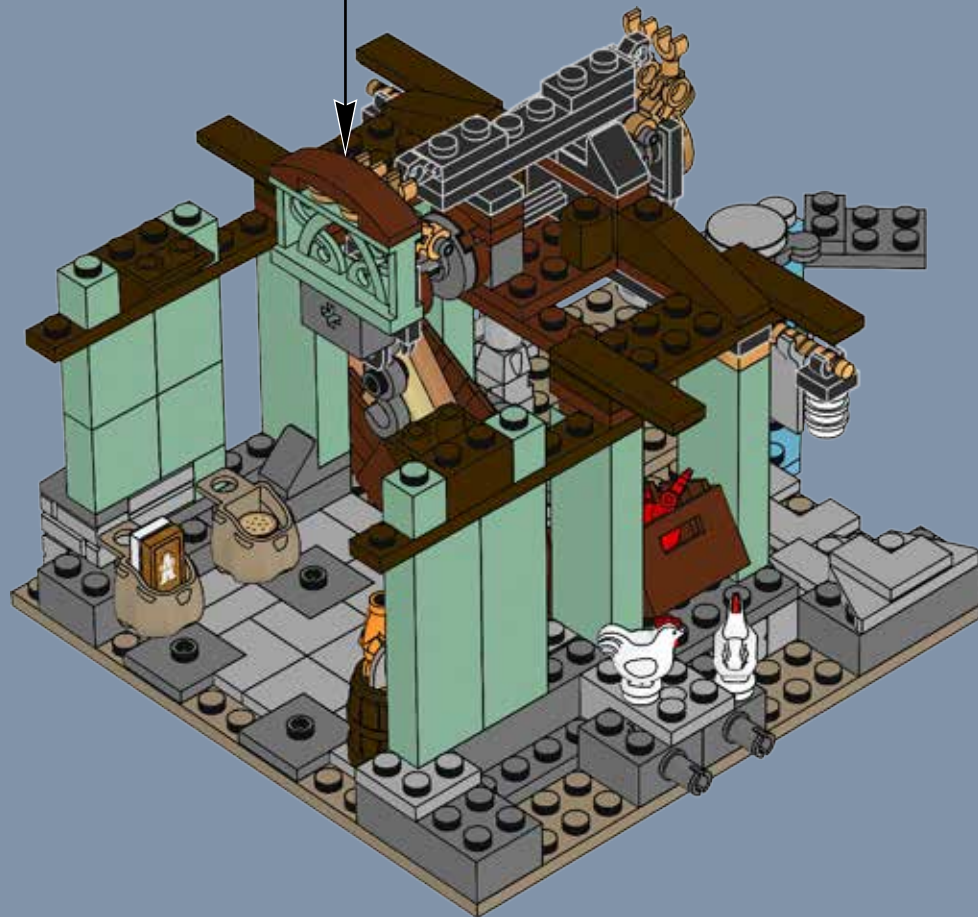
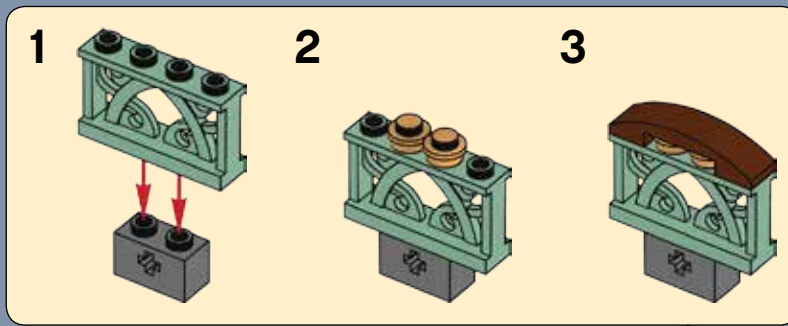

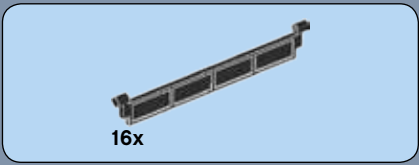

24

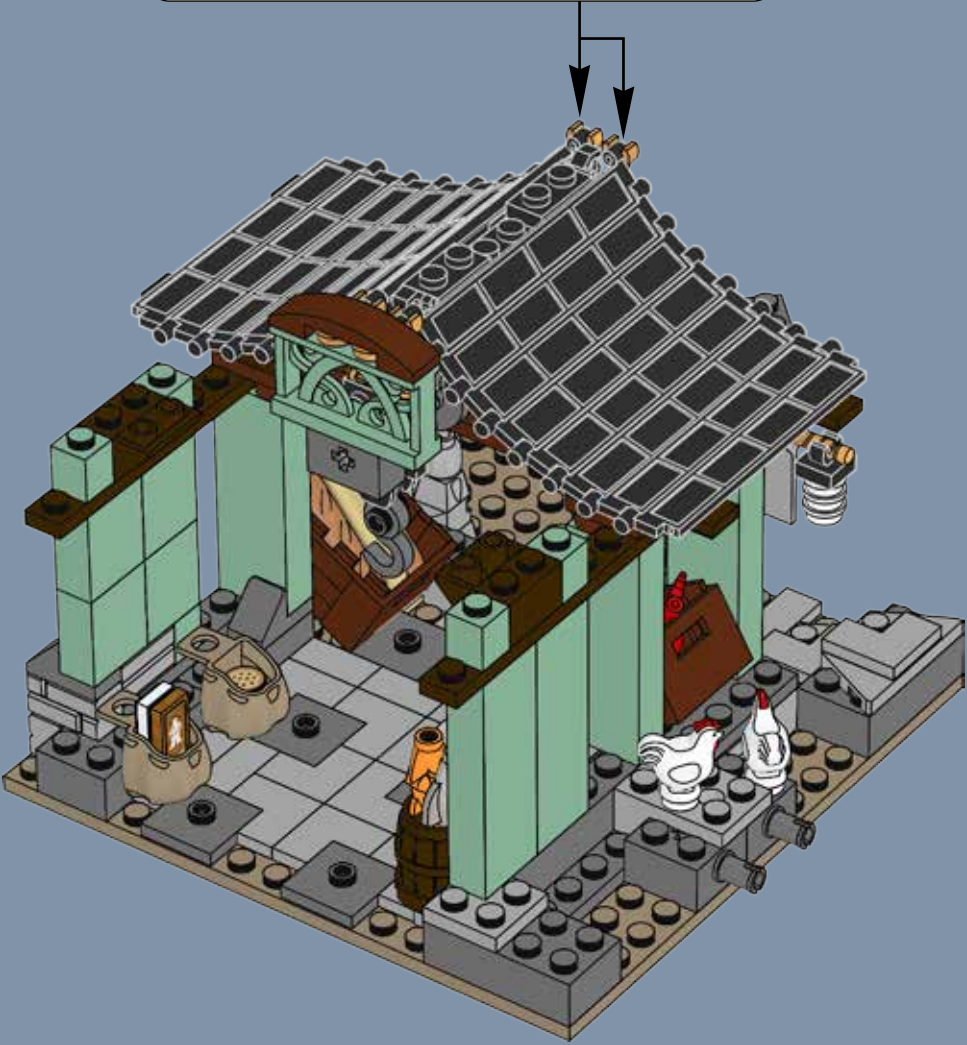
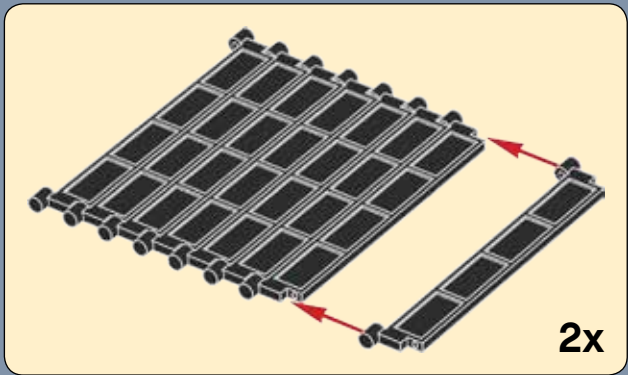

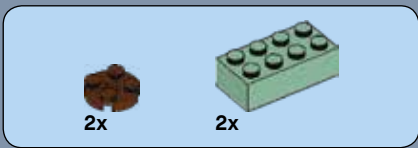

25

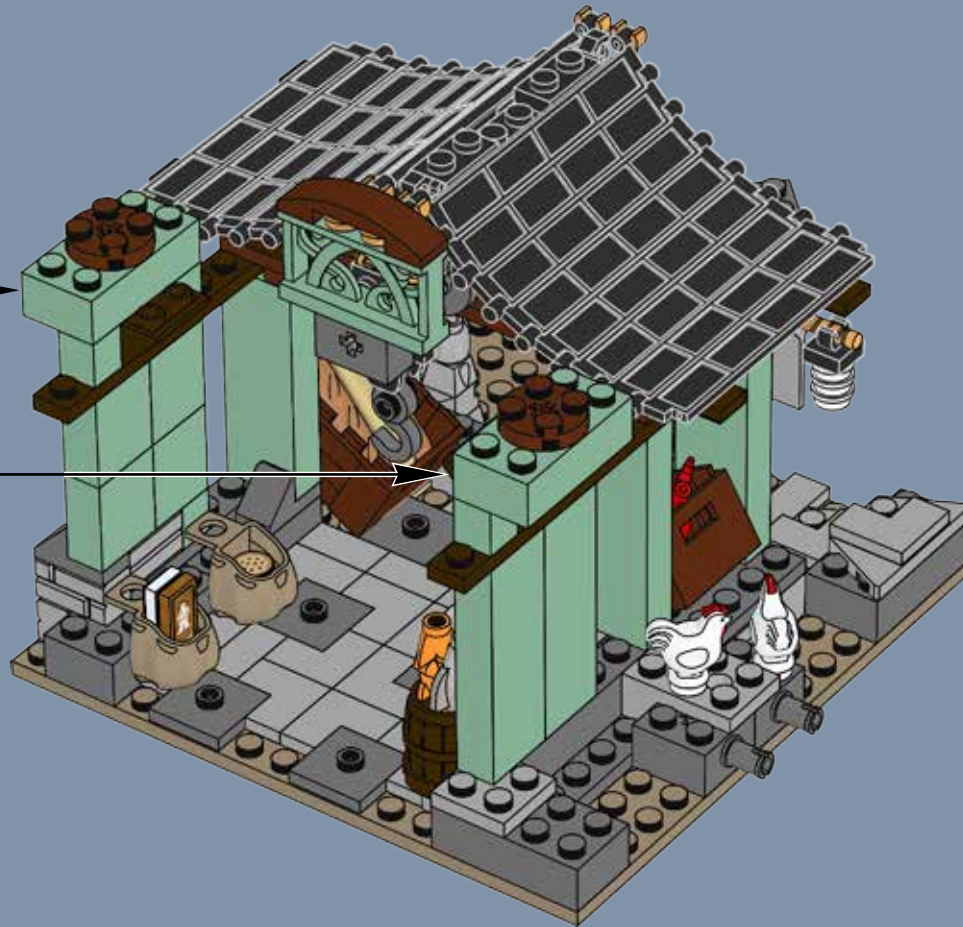
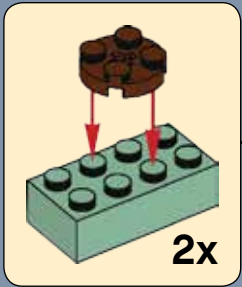

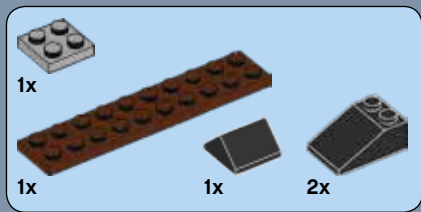

26

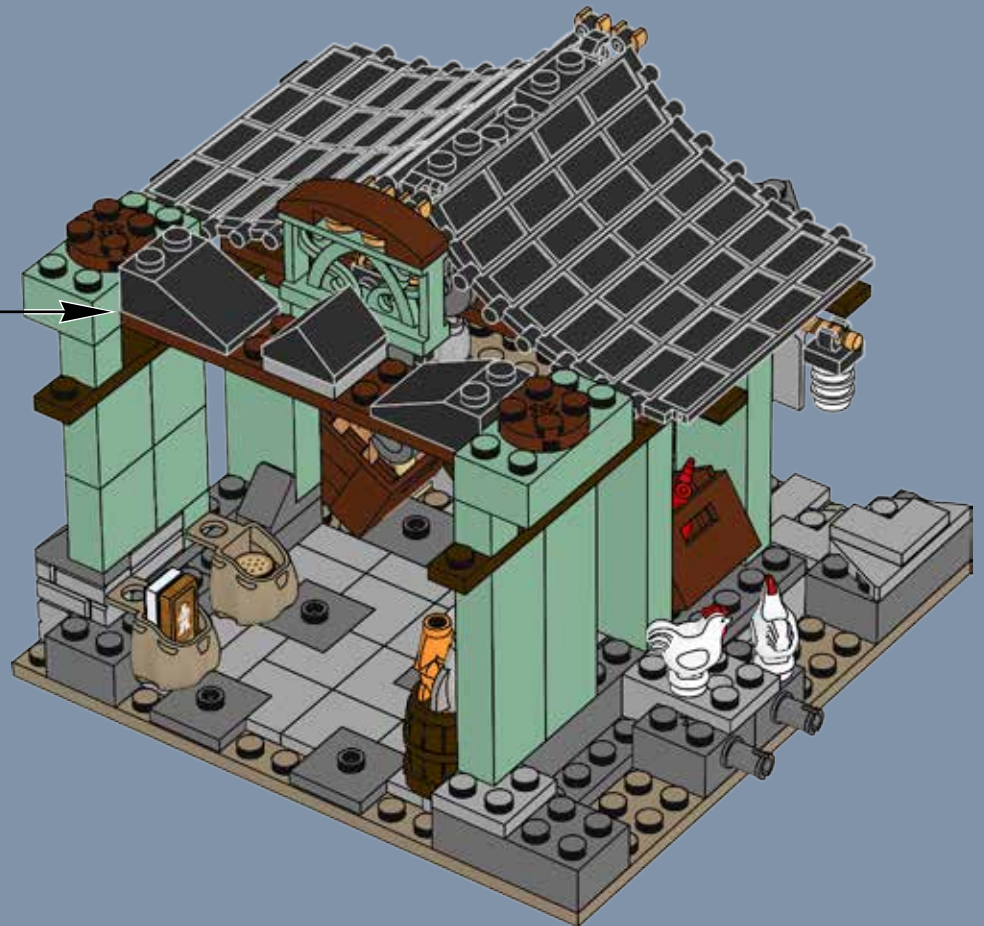
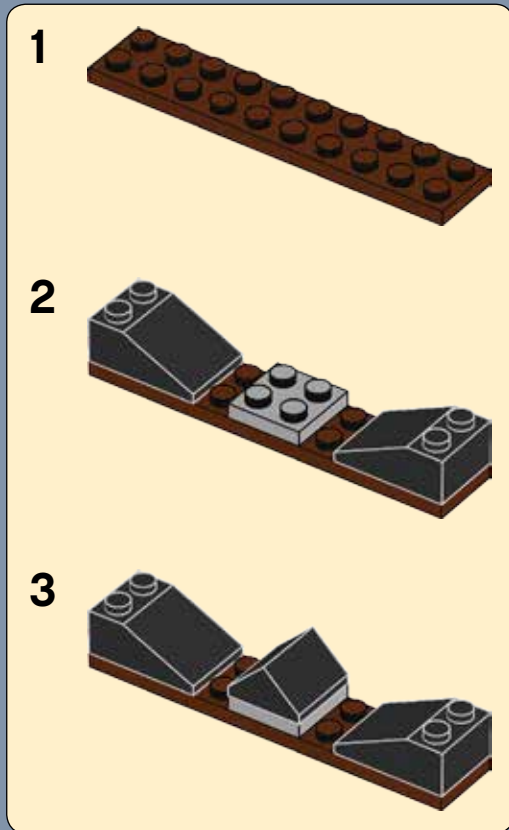



4x

27

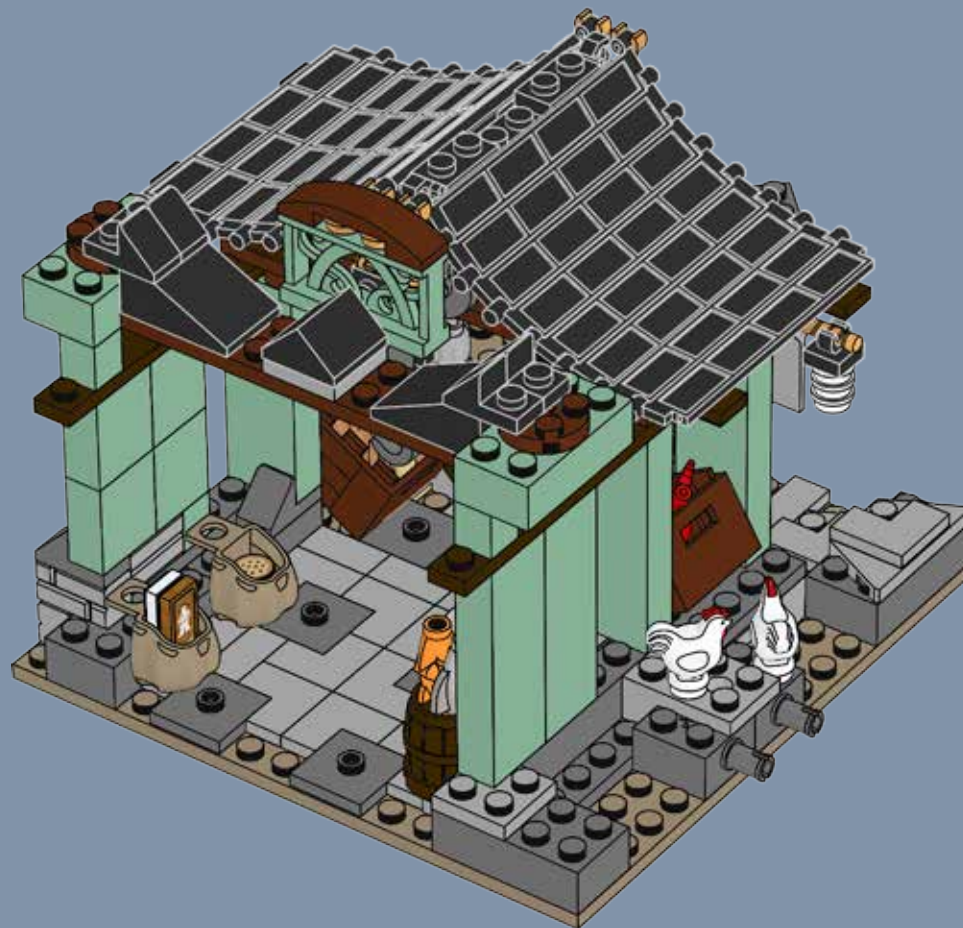

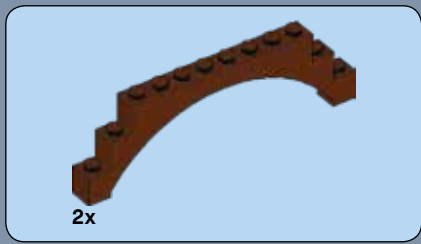

28

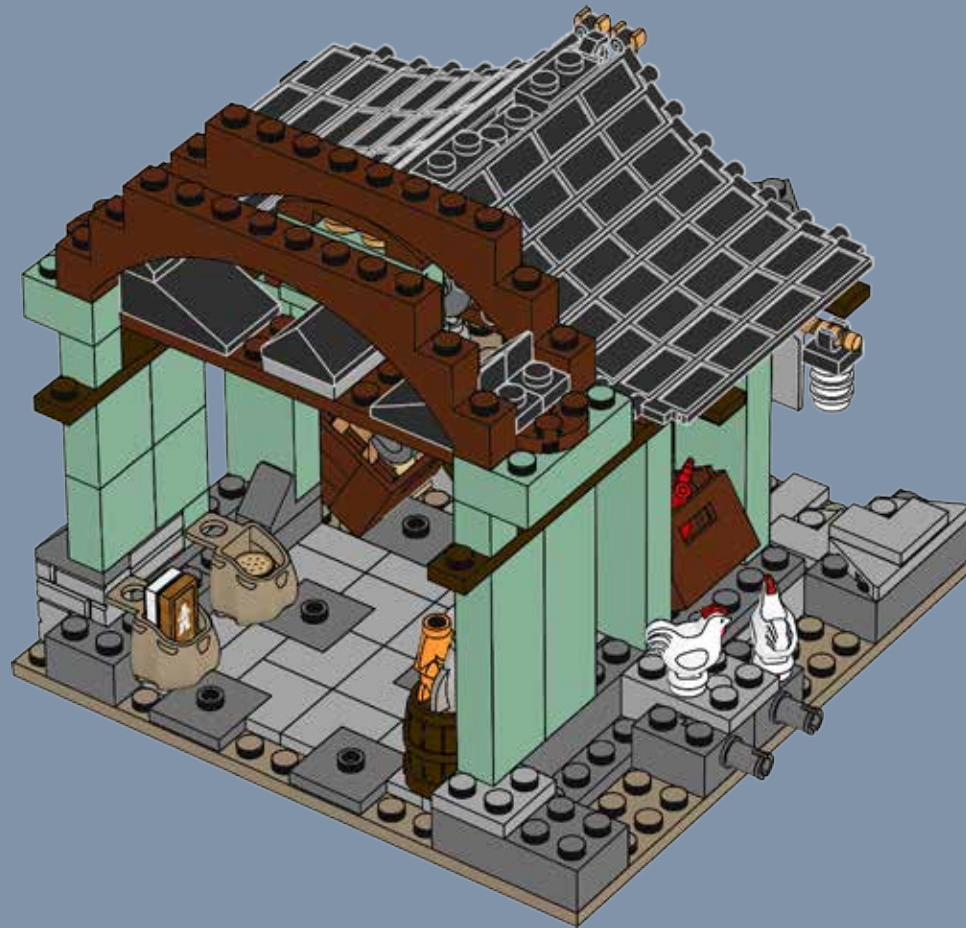

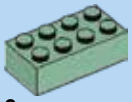

2x

29

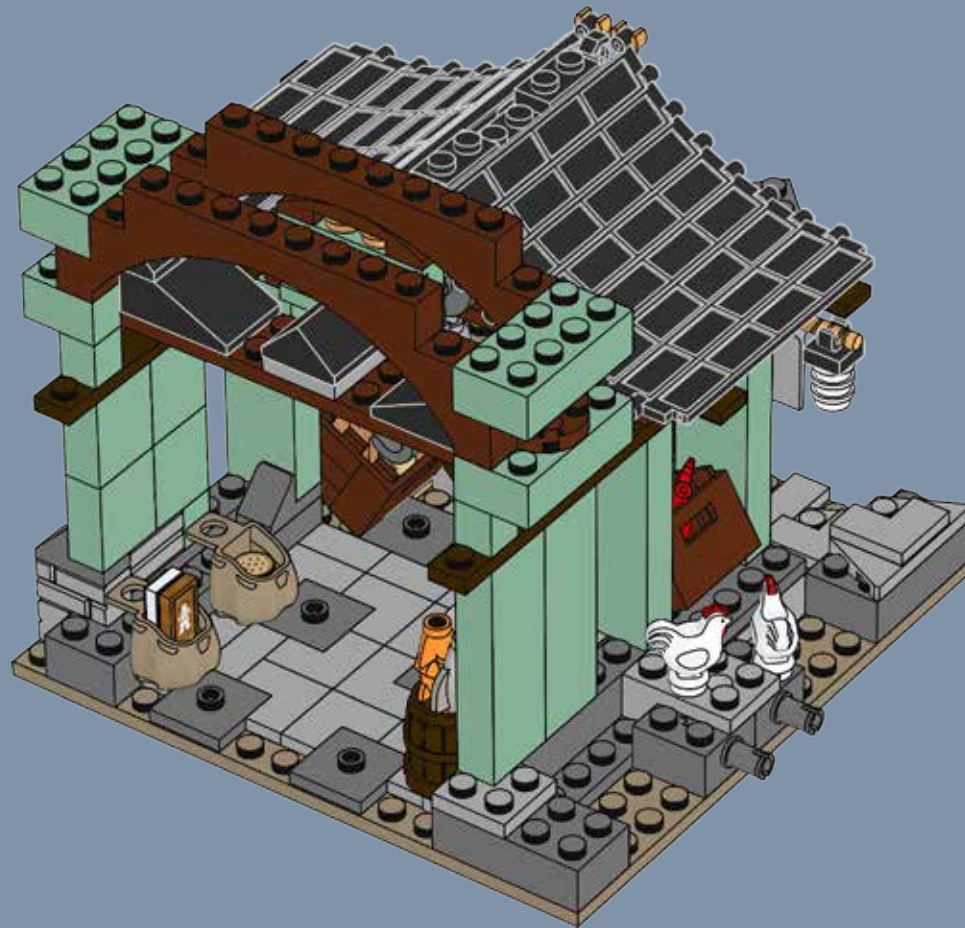



4x

30

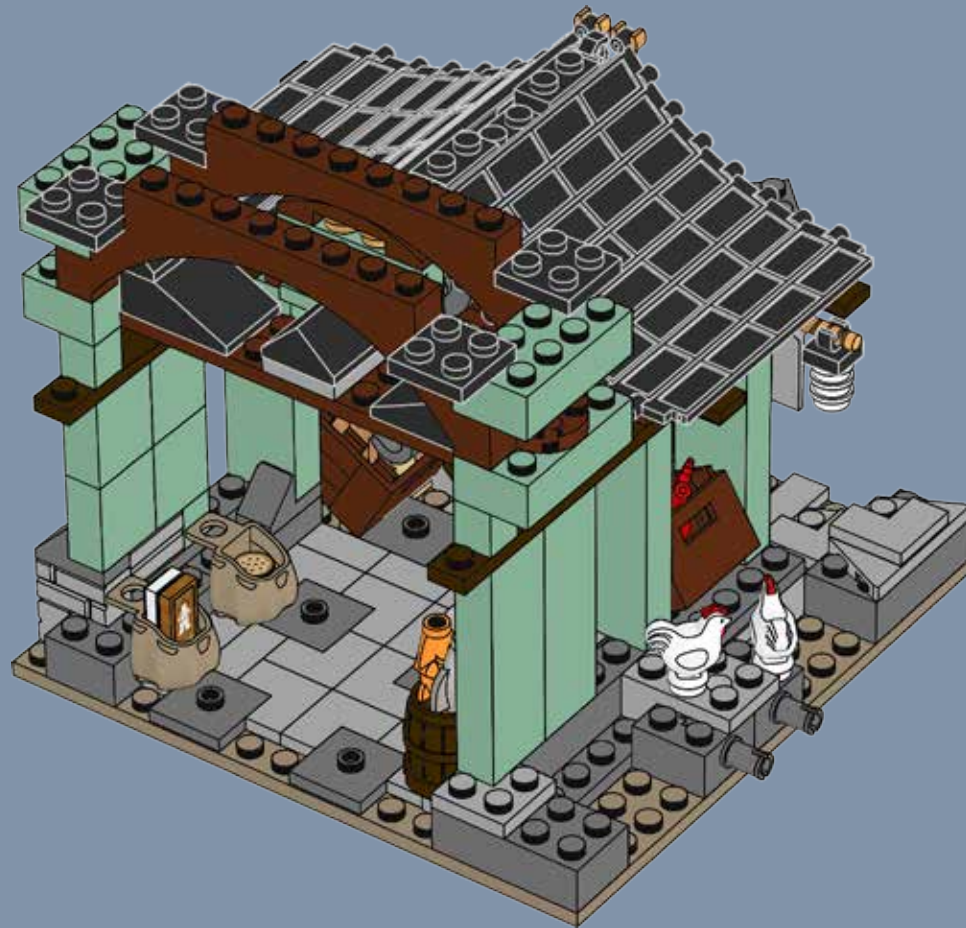



4x

31

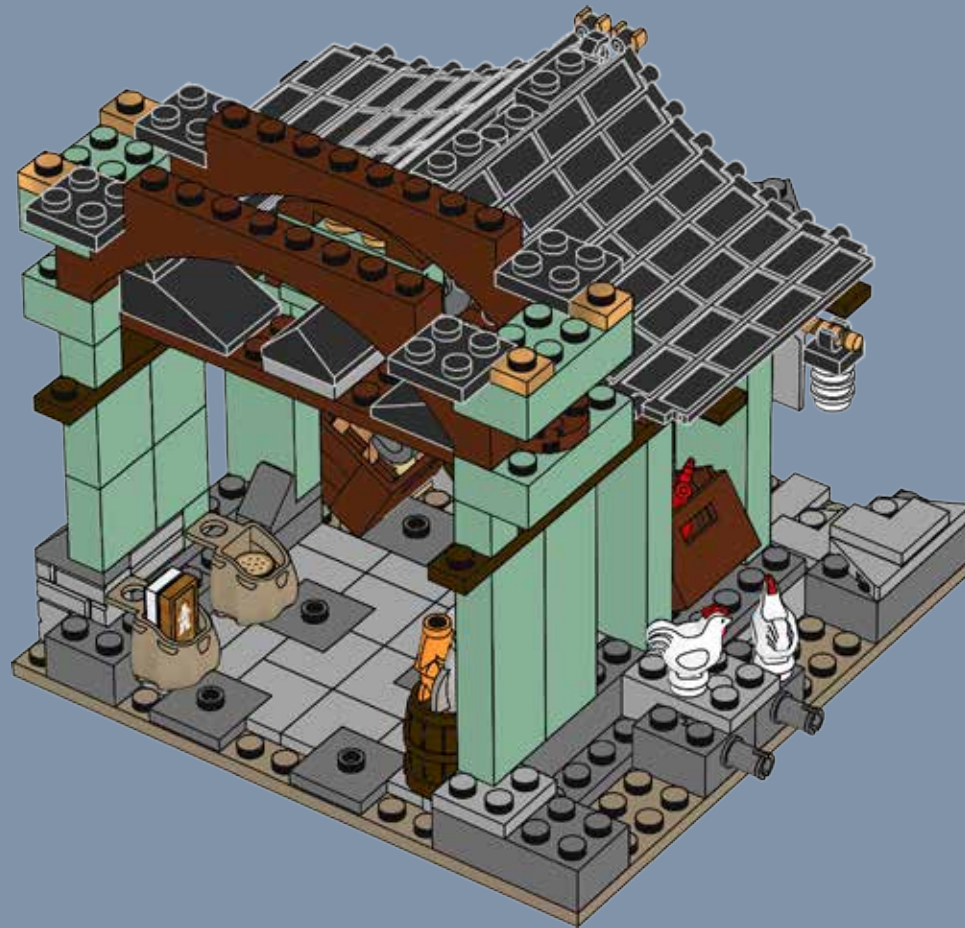



32

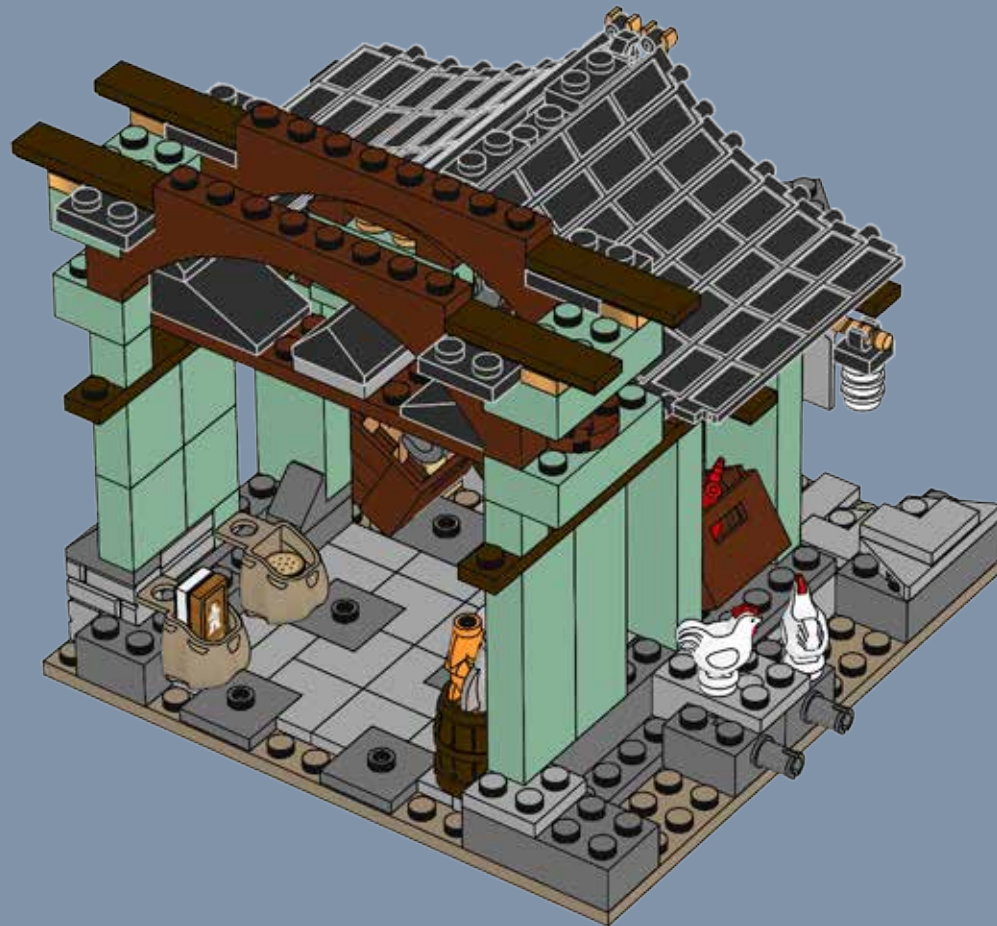



33

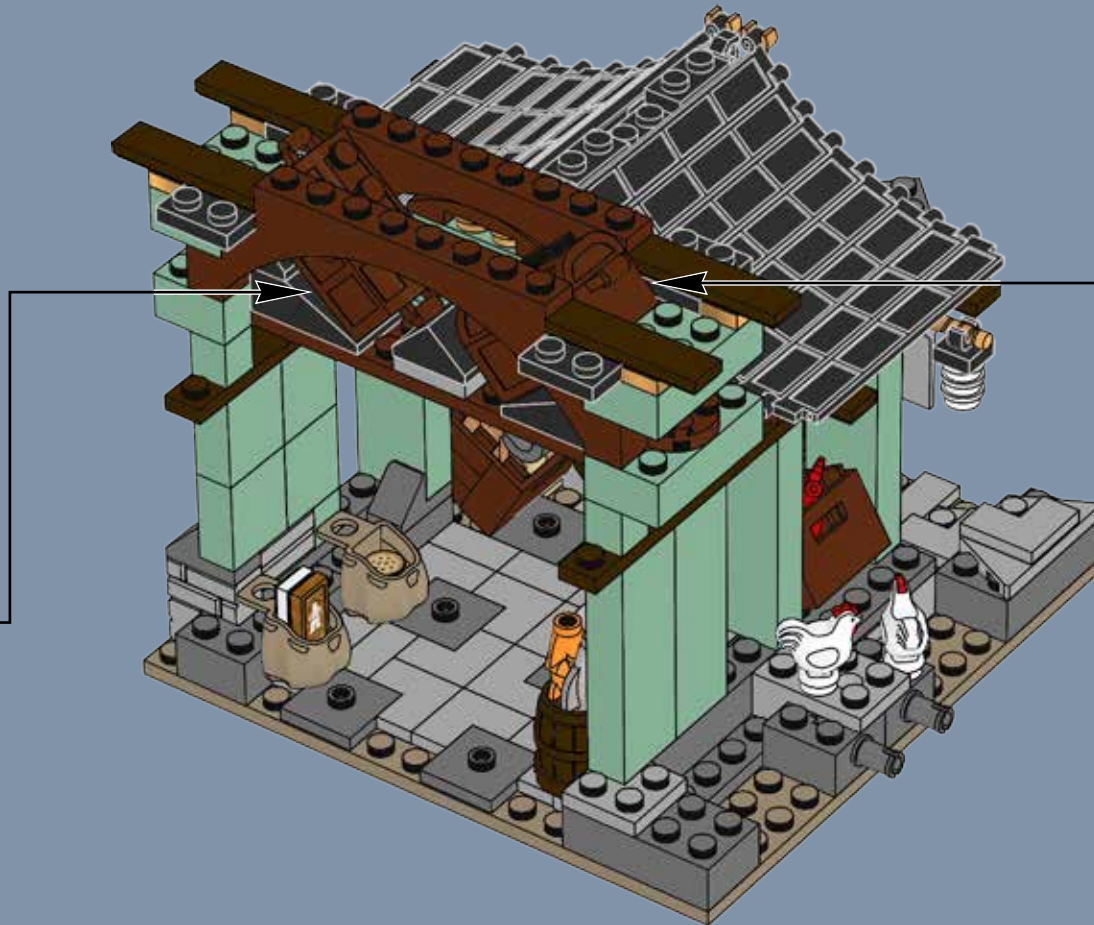
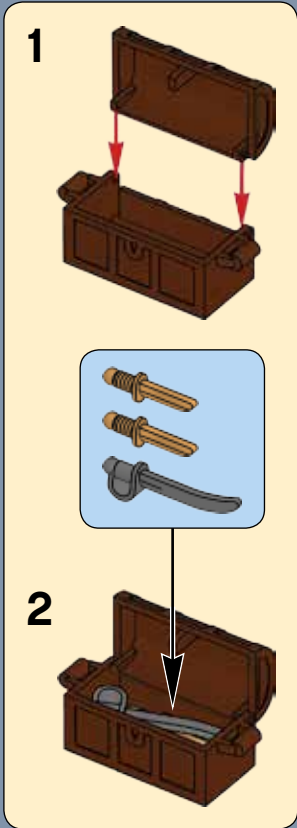



1

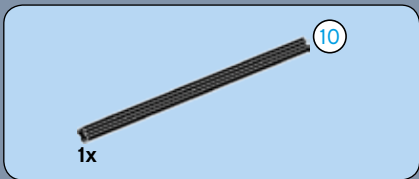
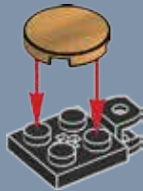

2

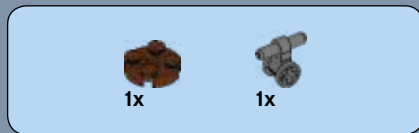
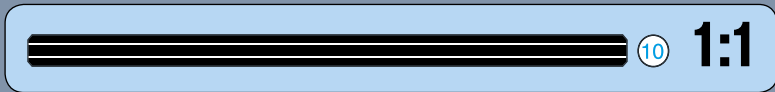
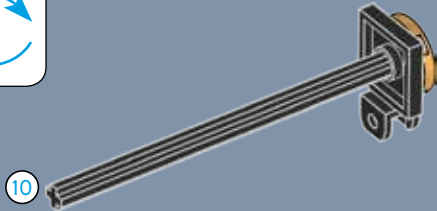

3

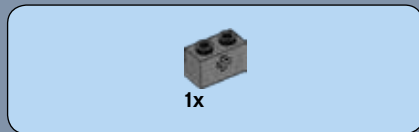
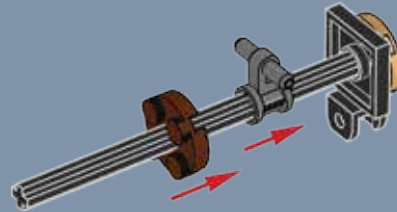

4

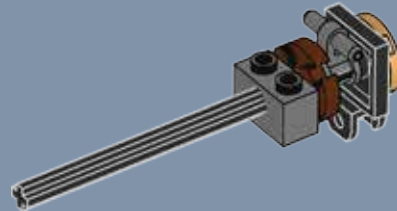

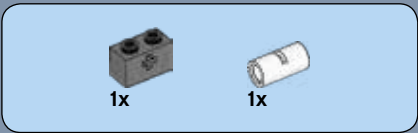

5

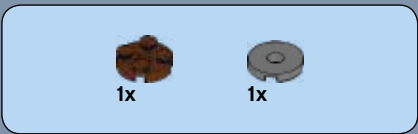
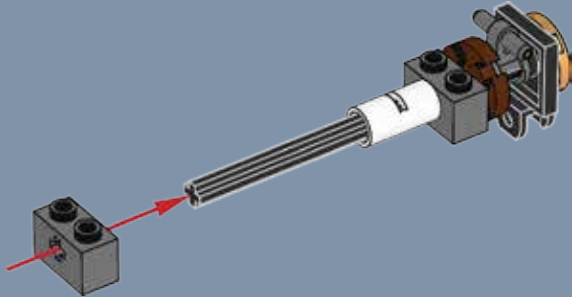

6

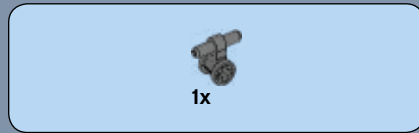
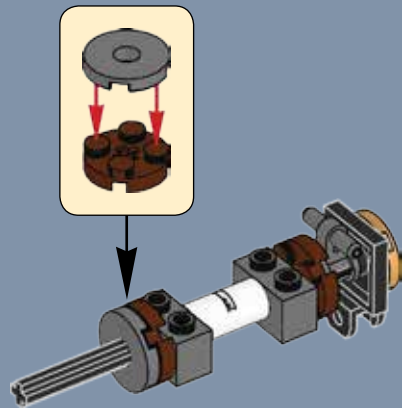

7

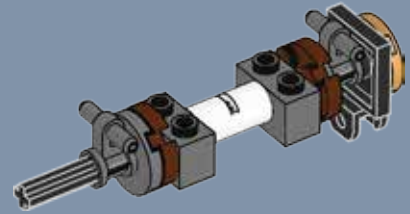

8

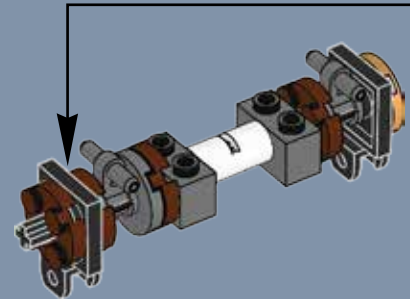
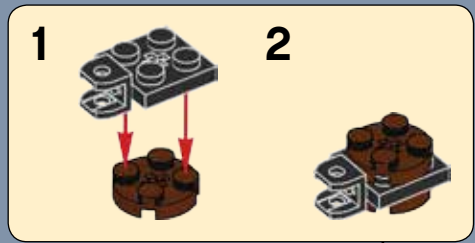

34

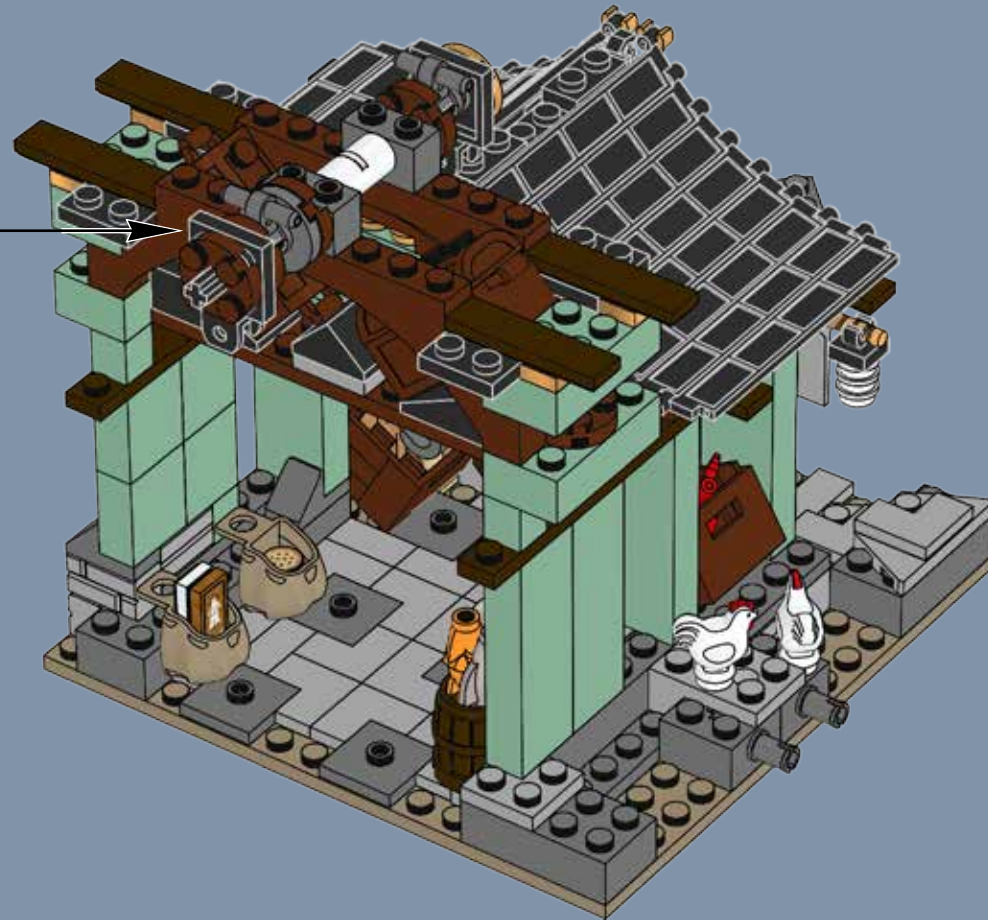



2x

35

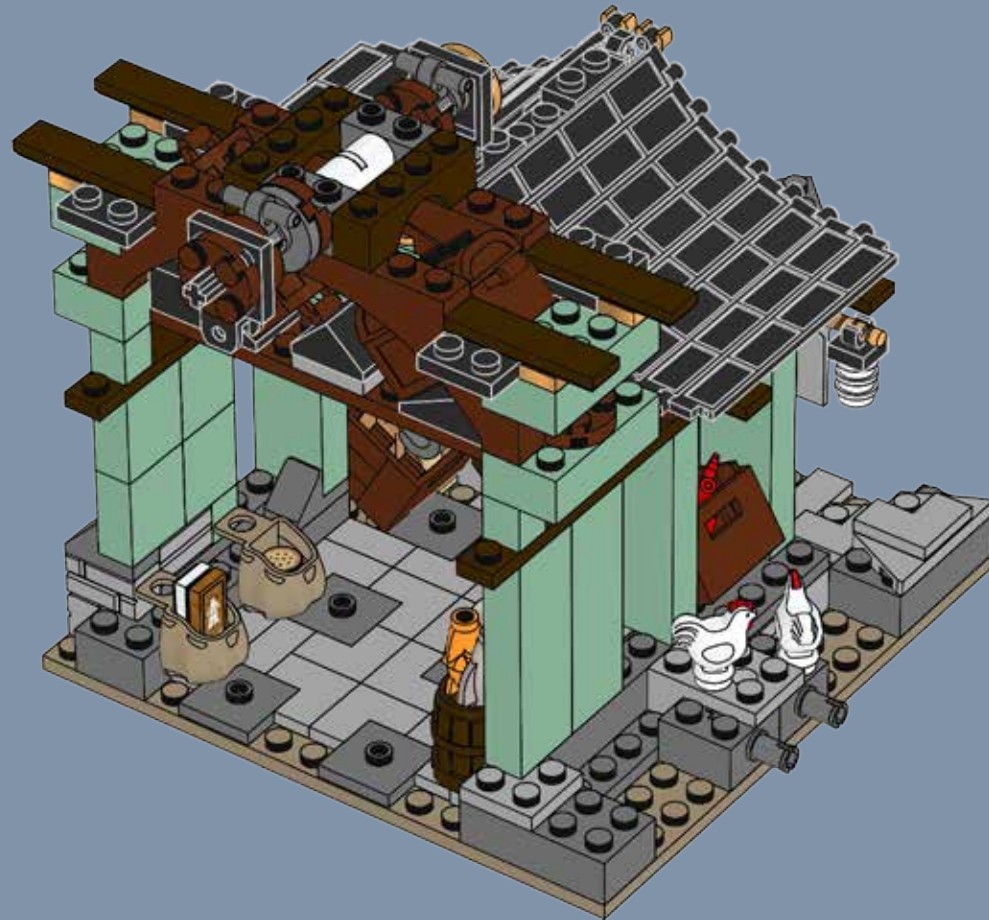



36

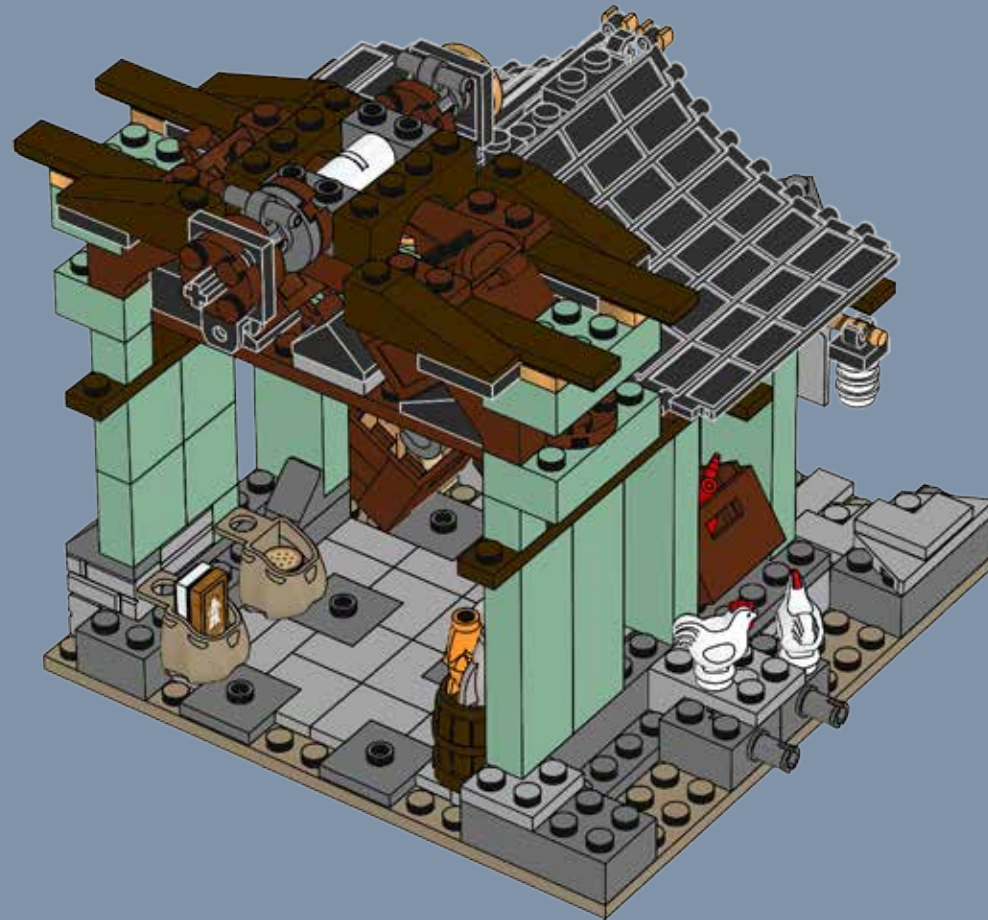



4x

37

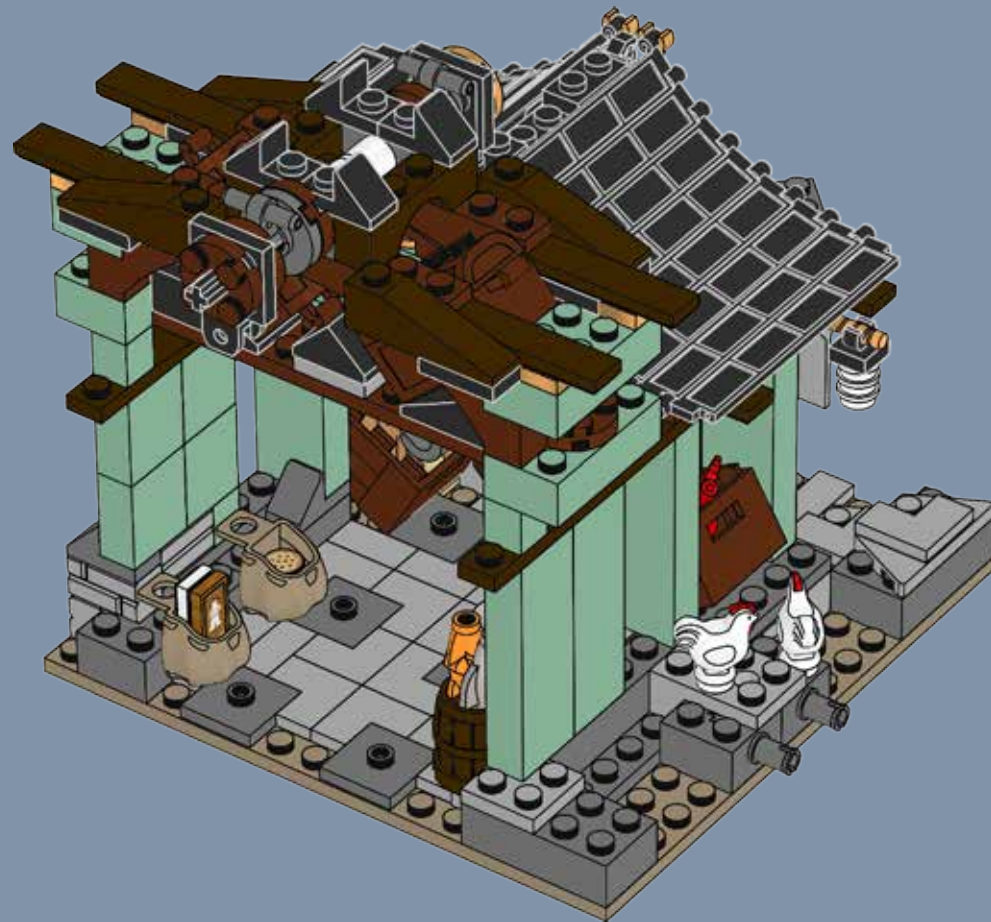



1x



2x

38

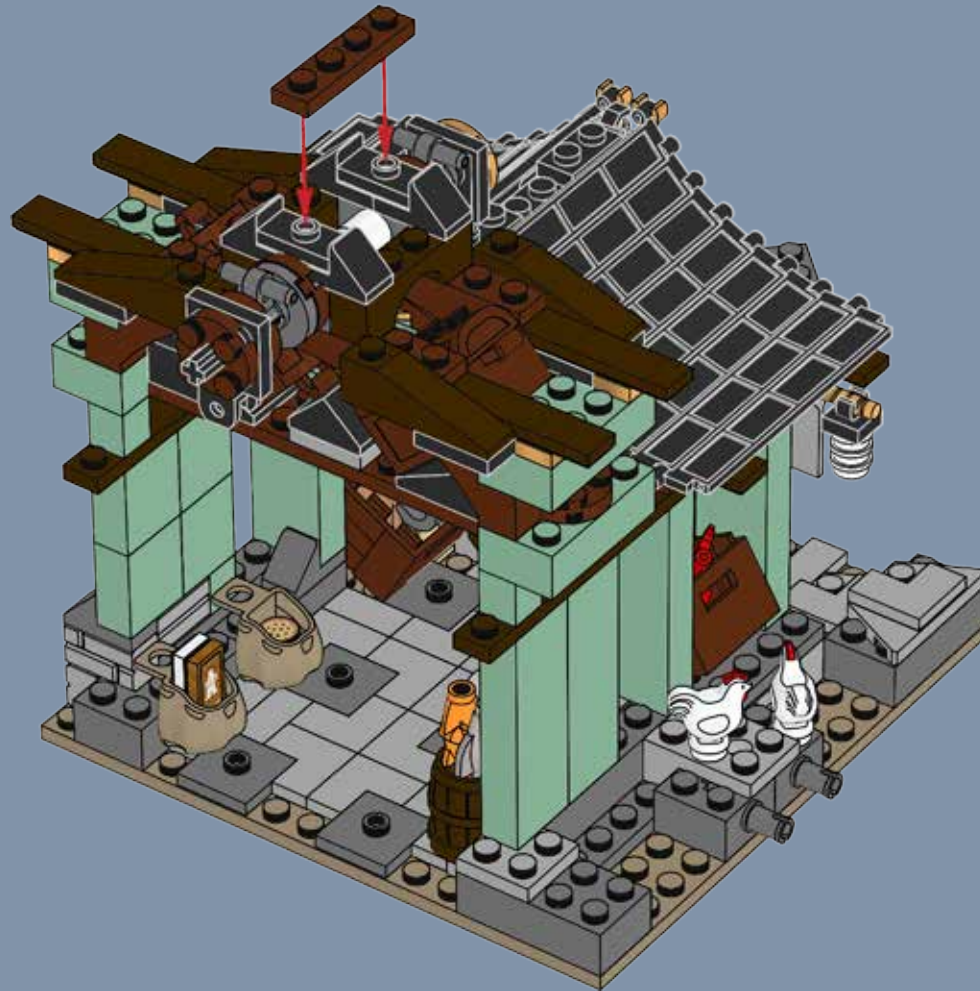



4x

39

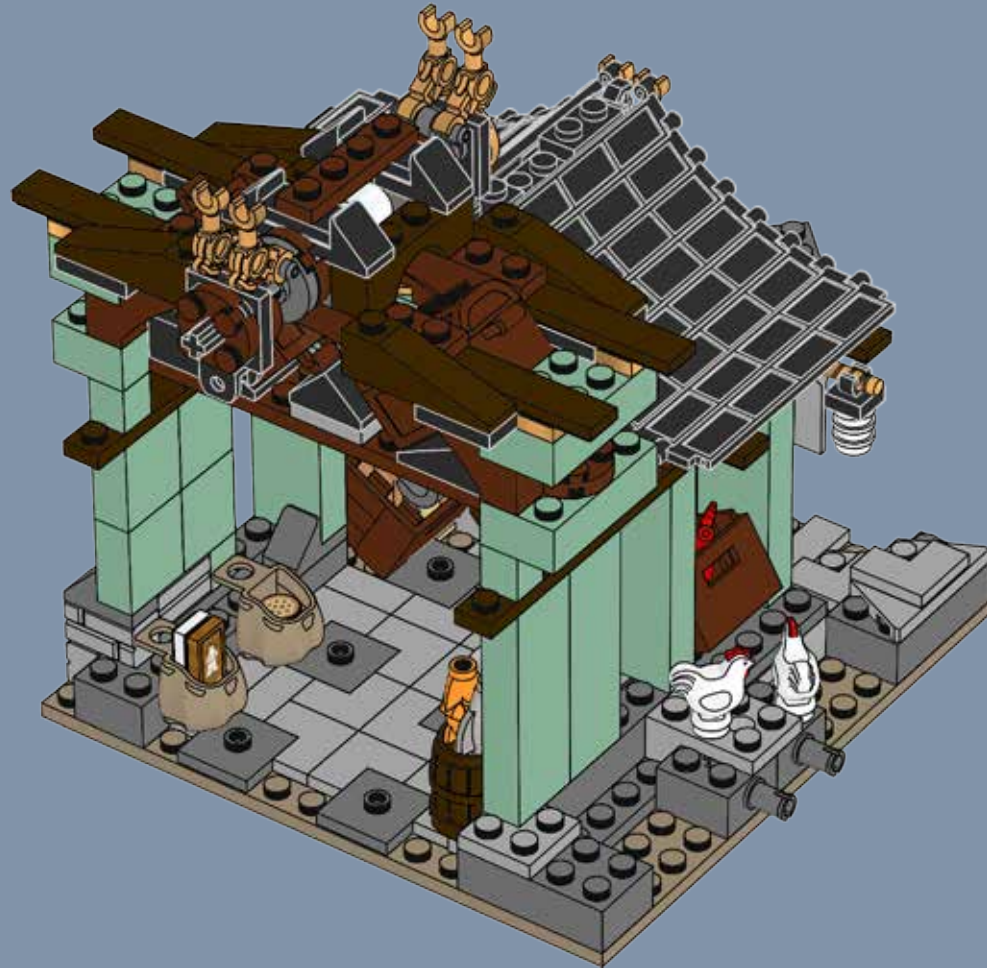



40

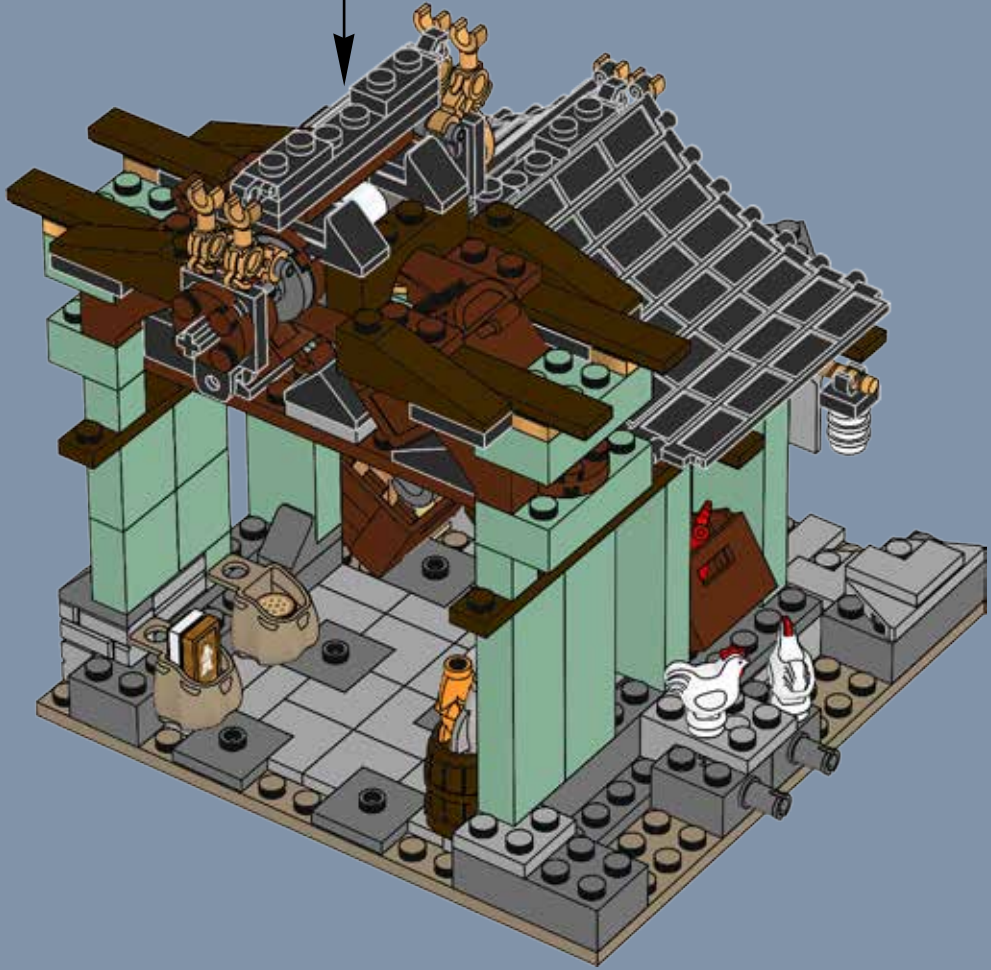
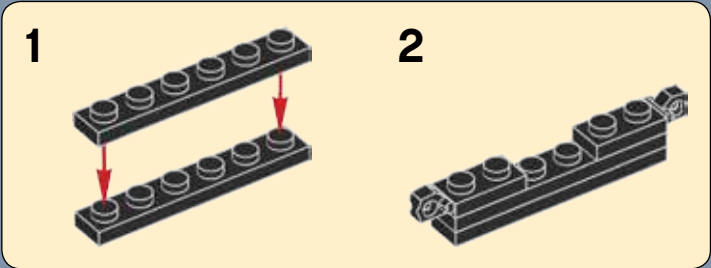

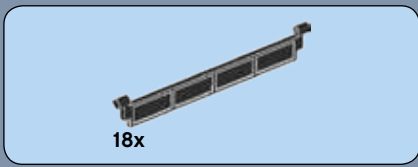

41

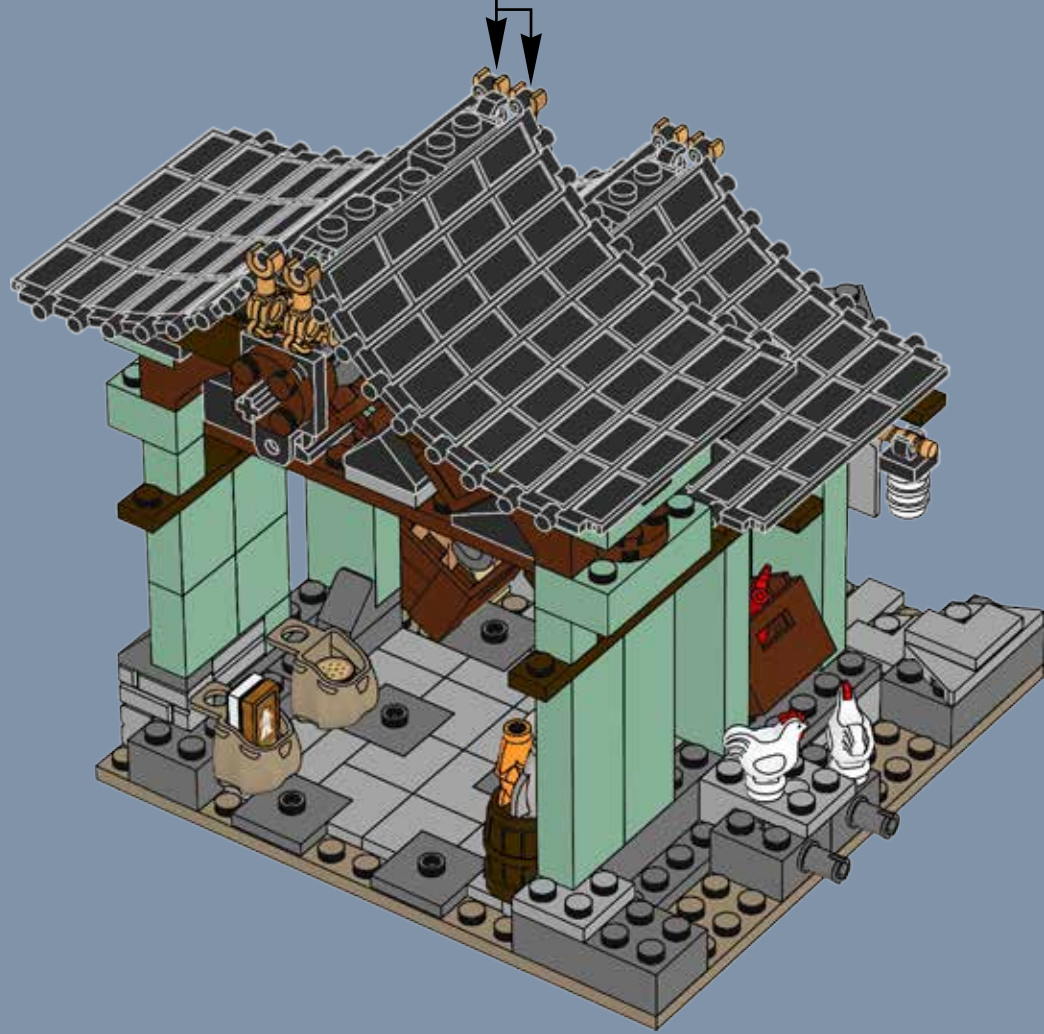
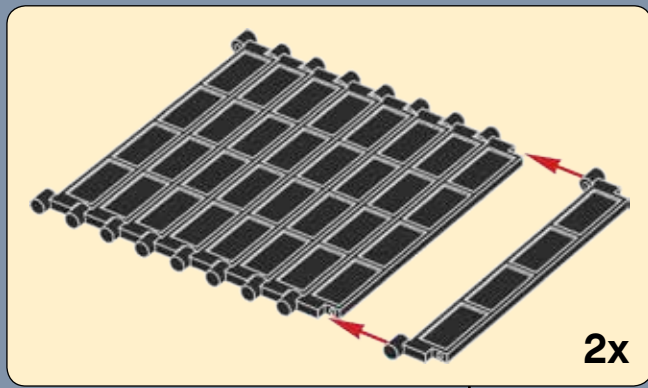

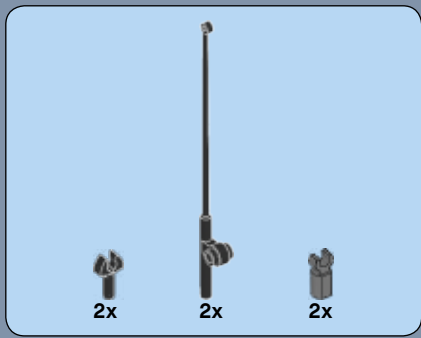

42

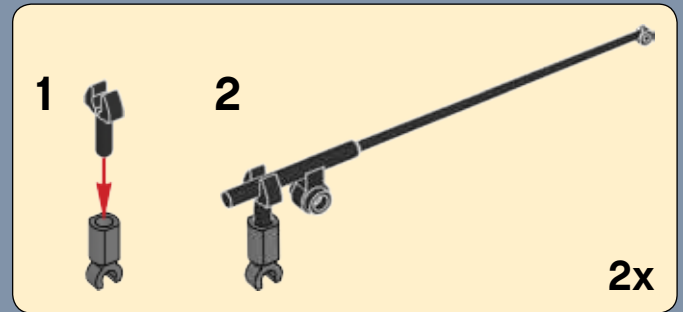
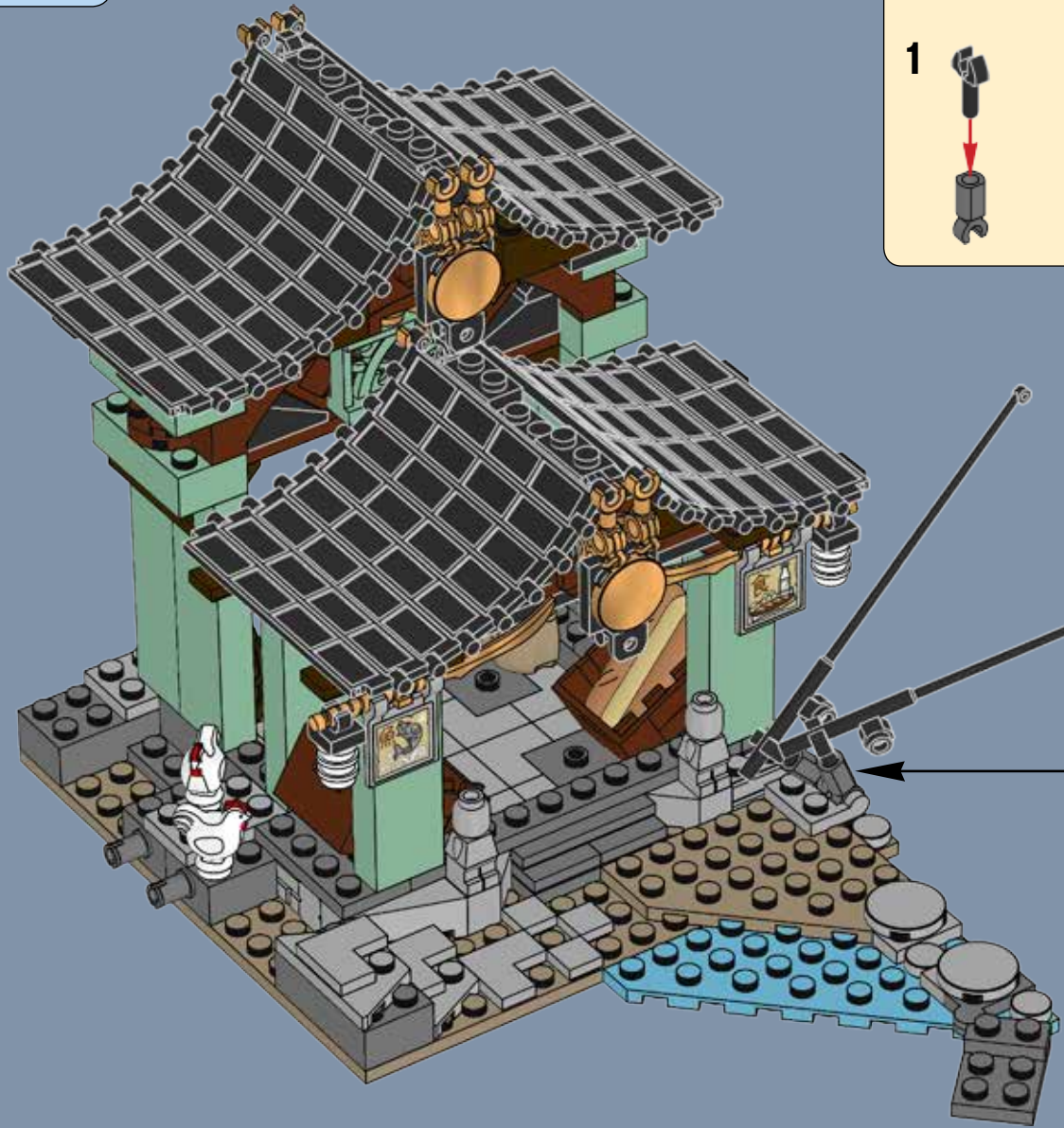



1x



6x

43

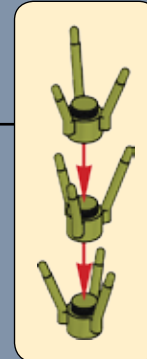
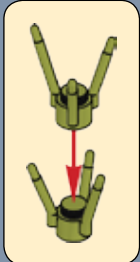
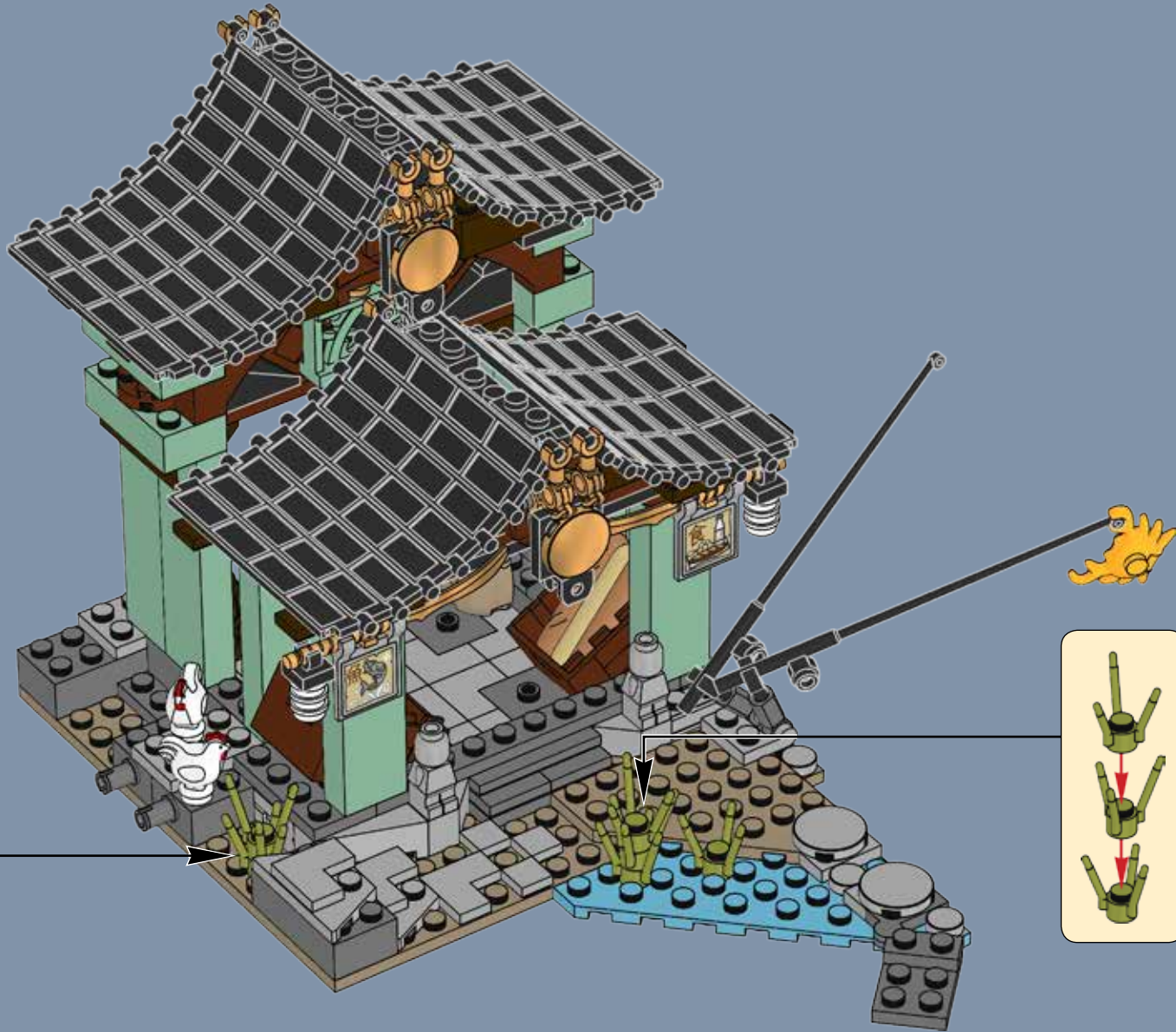

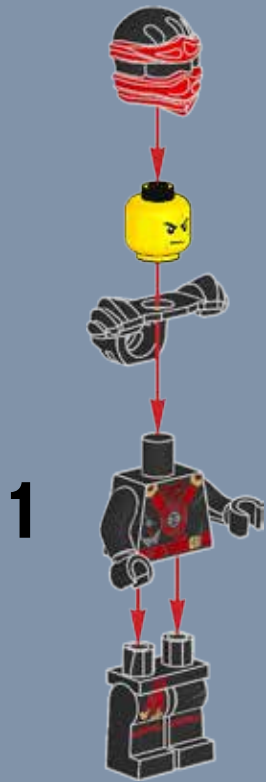
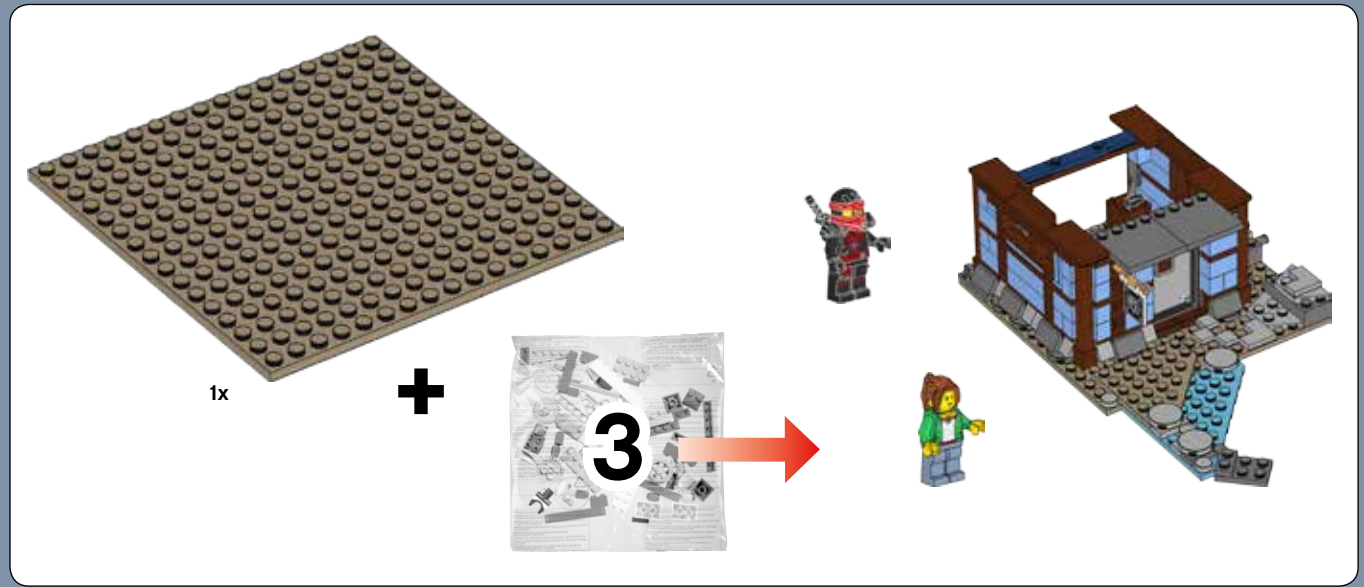

1

2



3

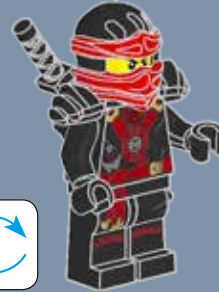

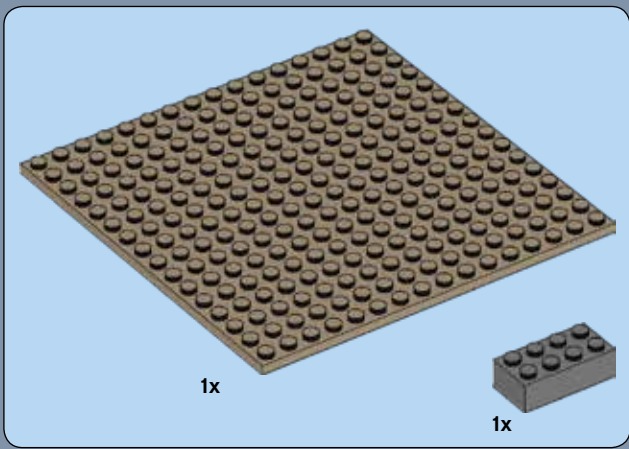

1

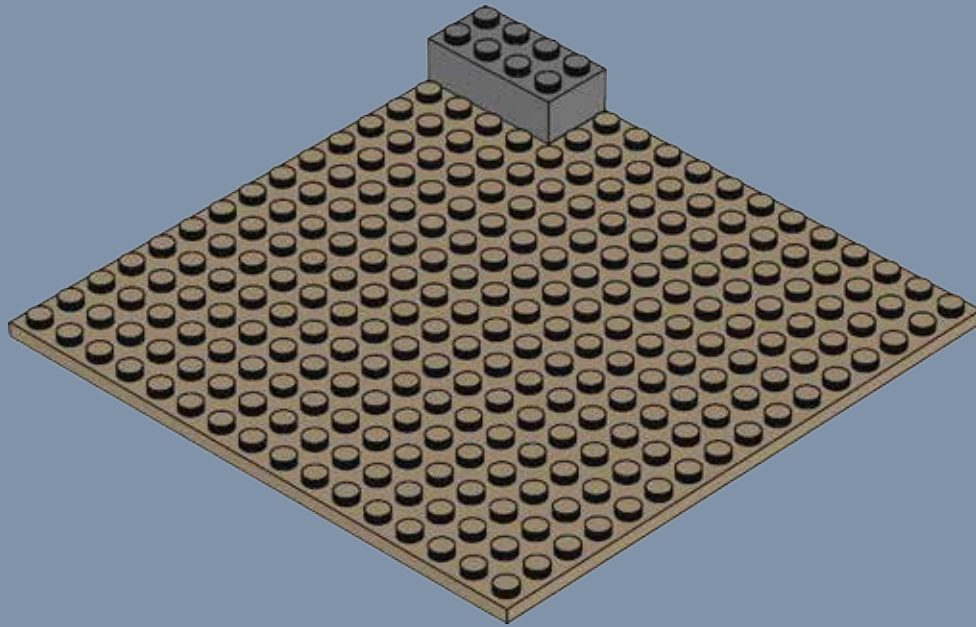

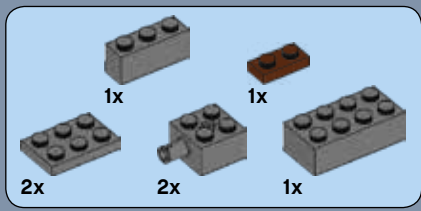

2



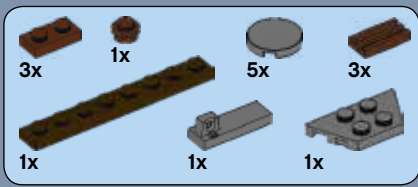

3

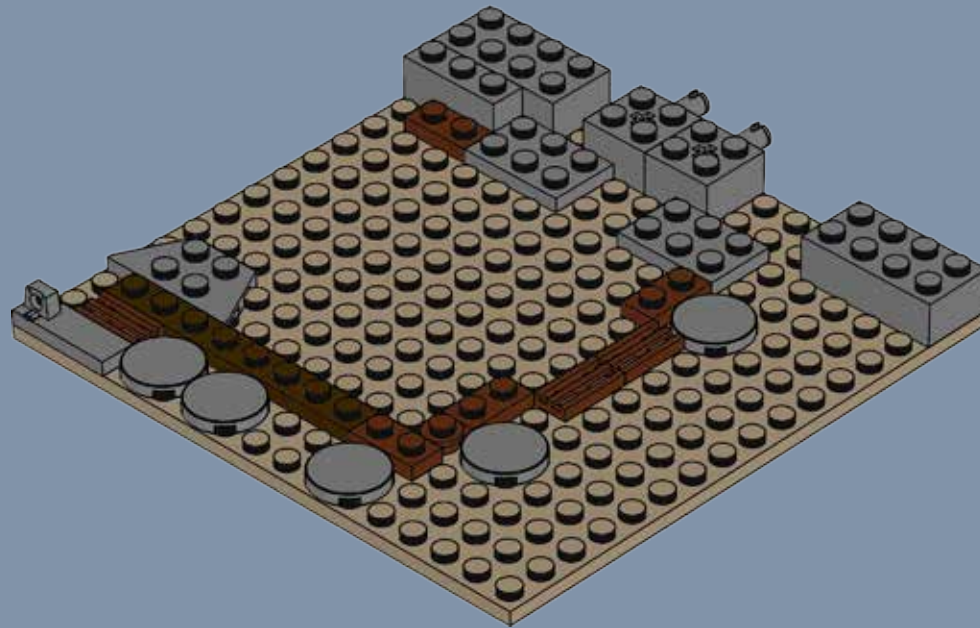

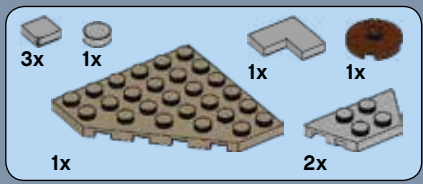

4

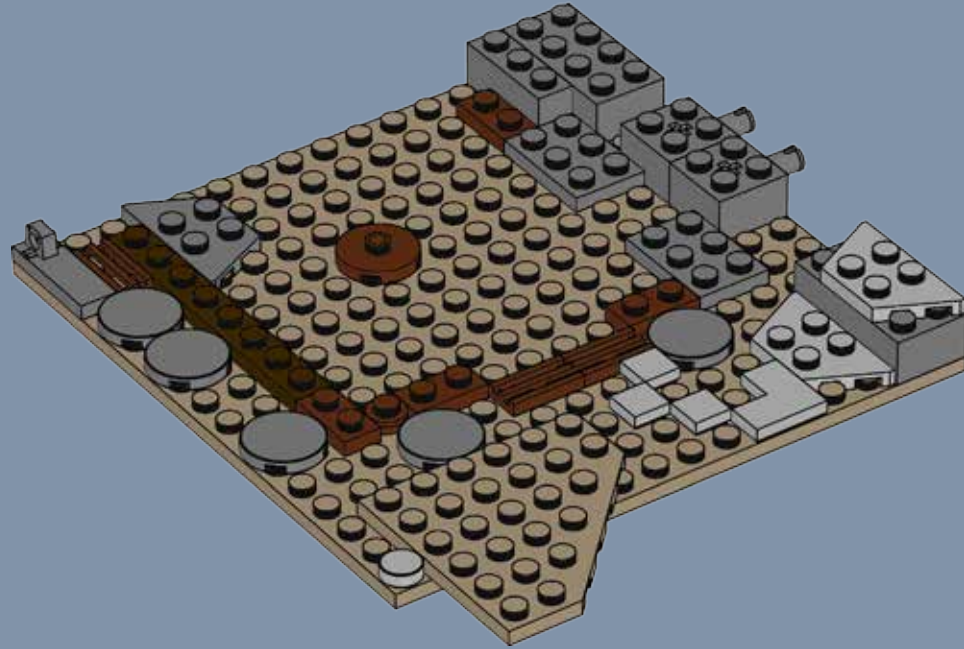

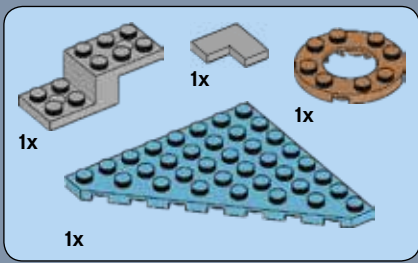

5

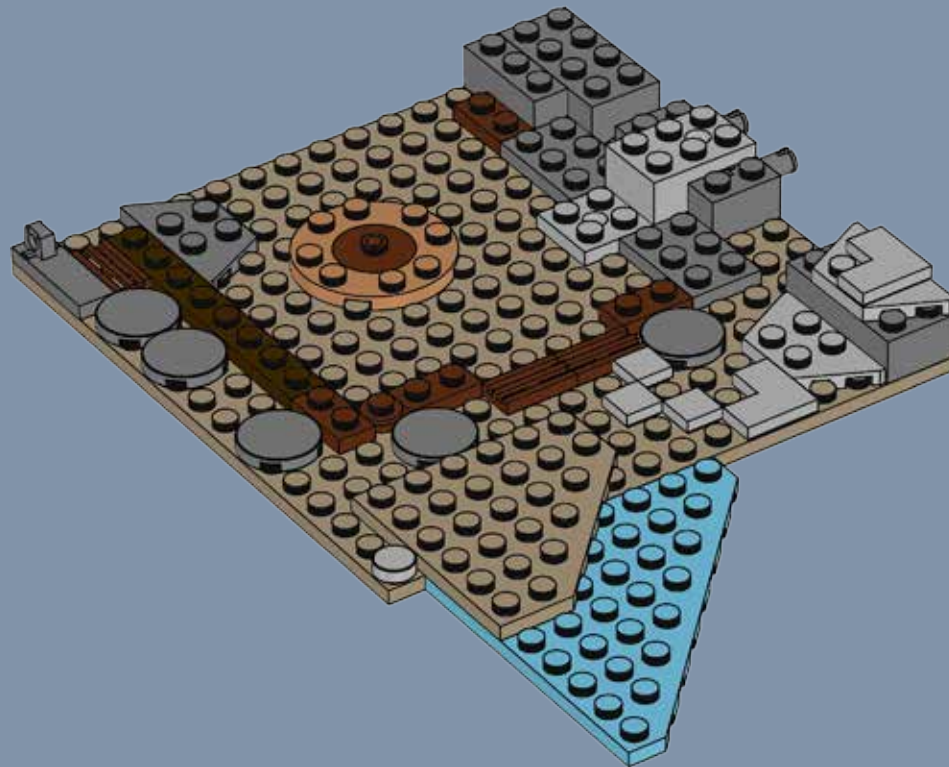

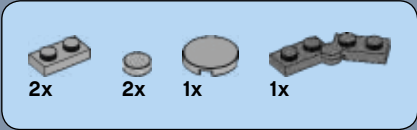

6

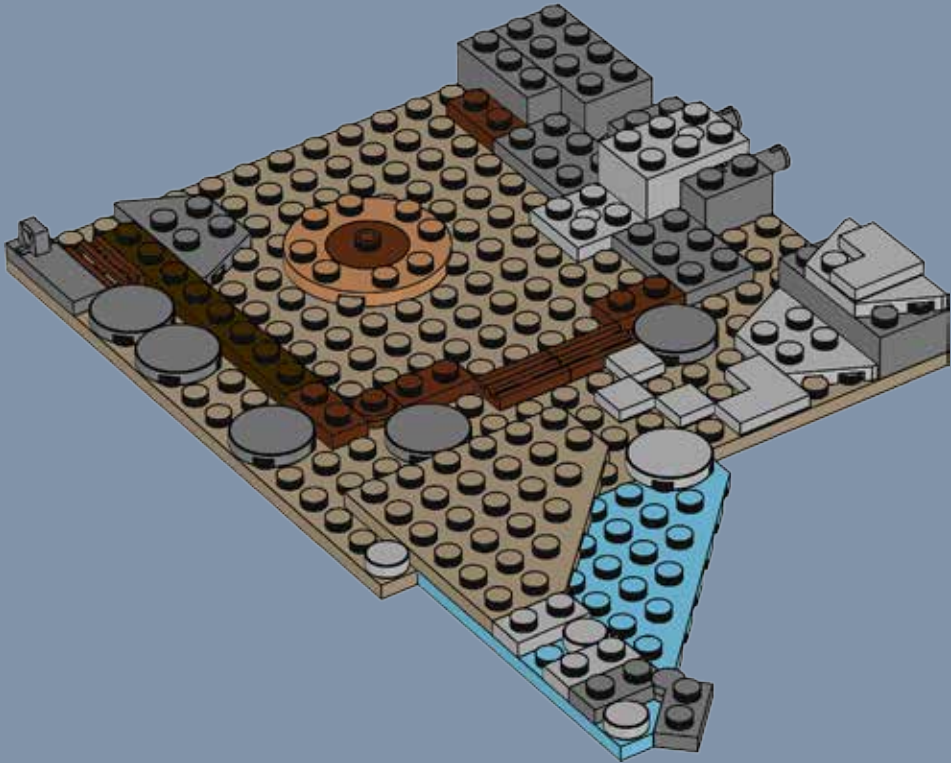



1x



2x

7

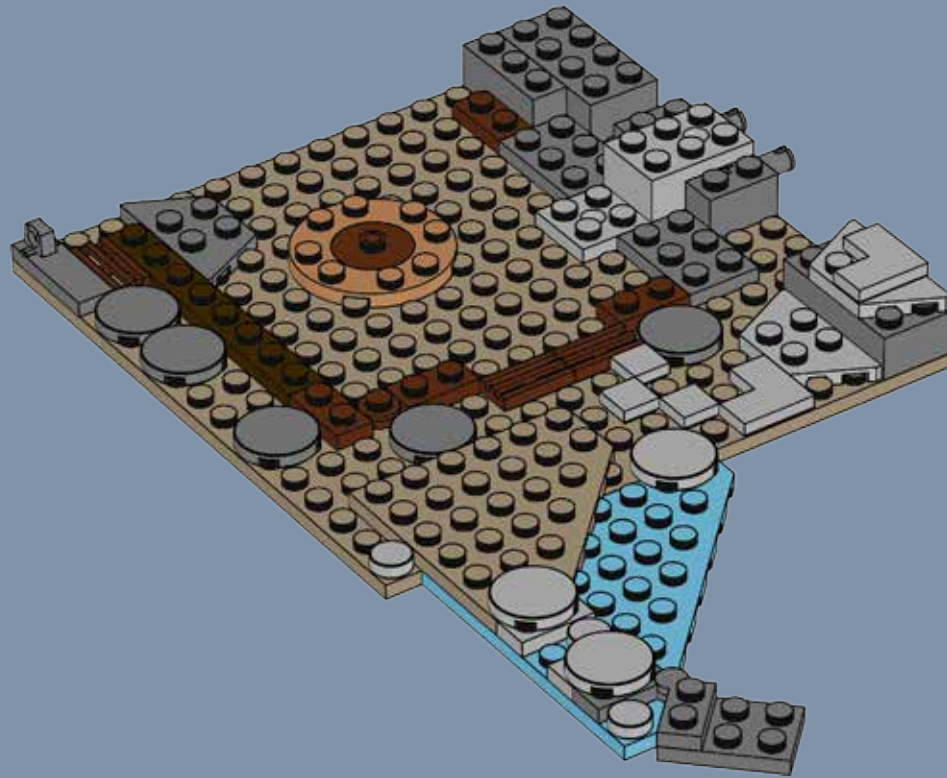

5x 1x

8

2x

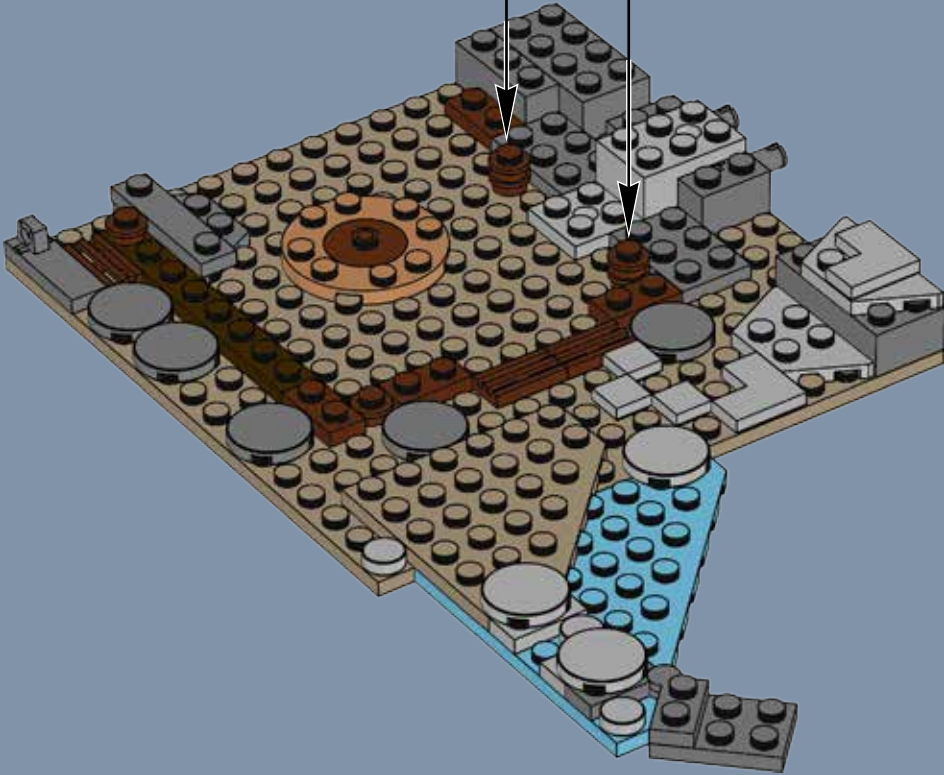



7x

9

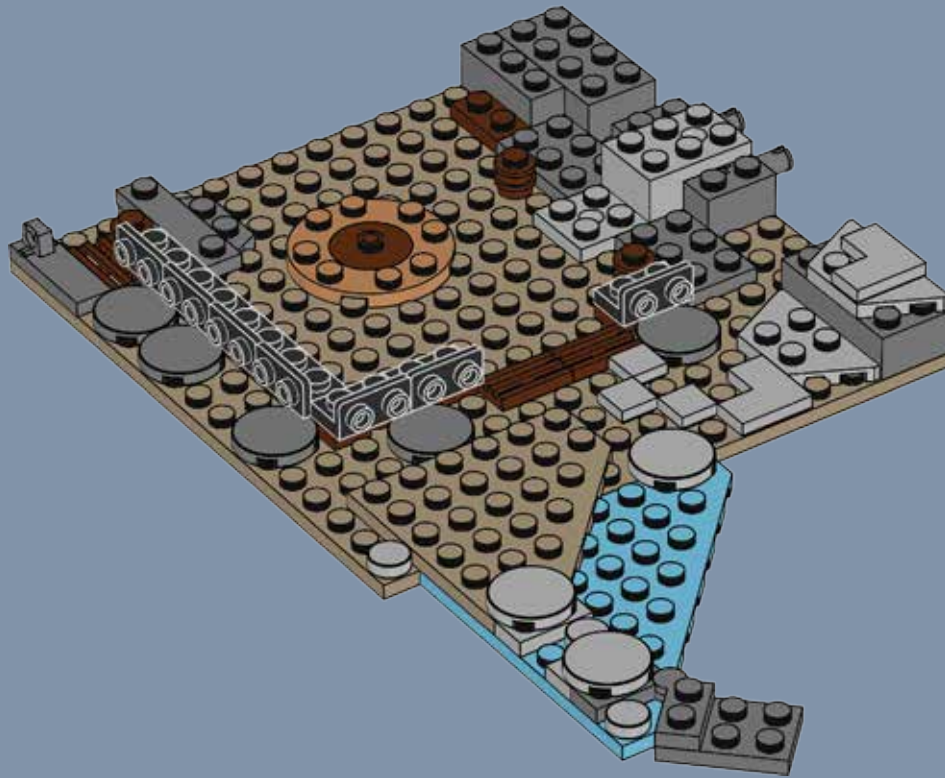

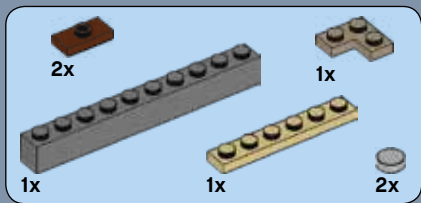

10

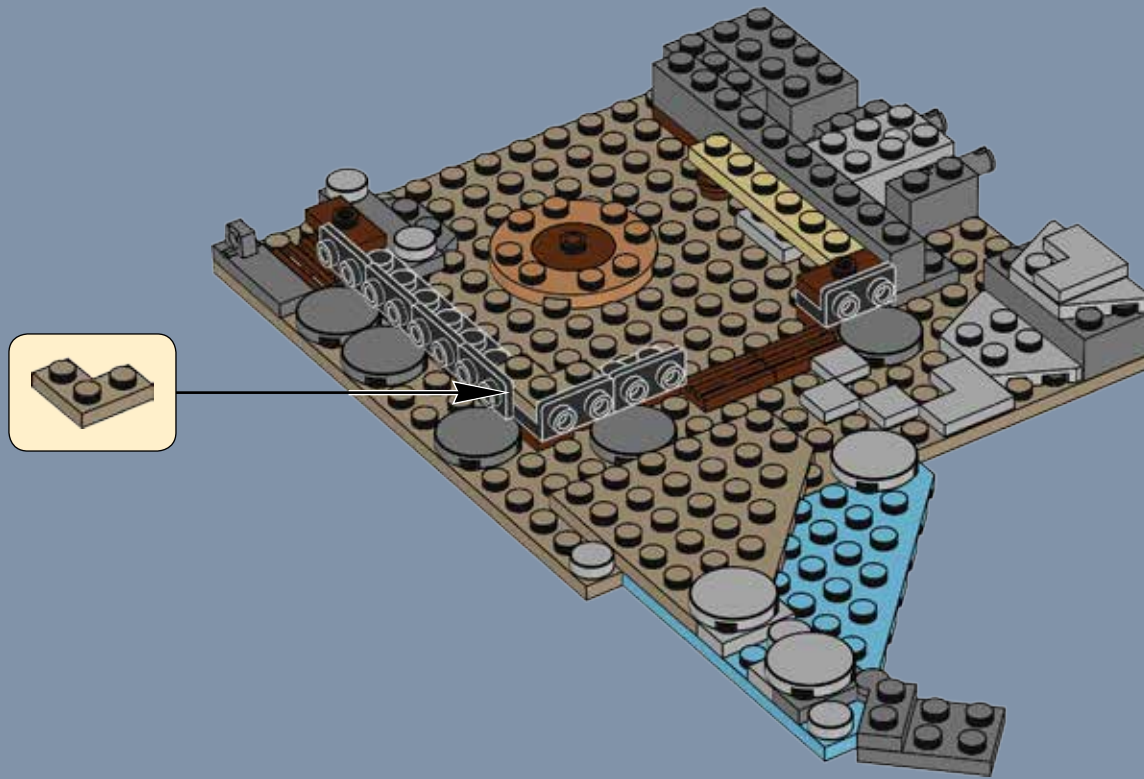

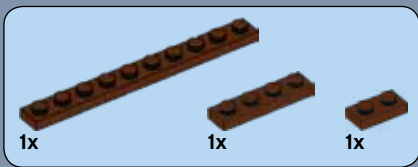

11

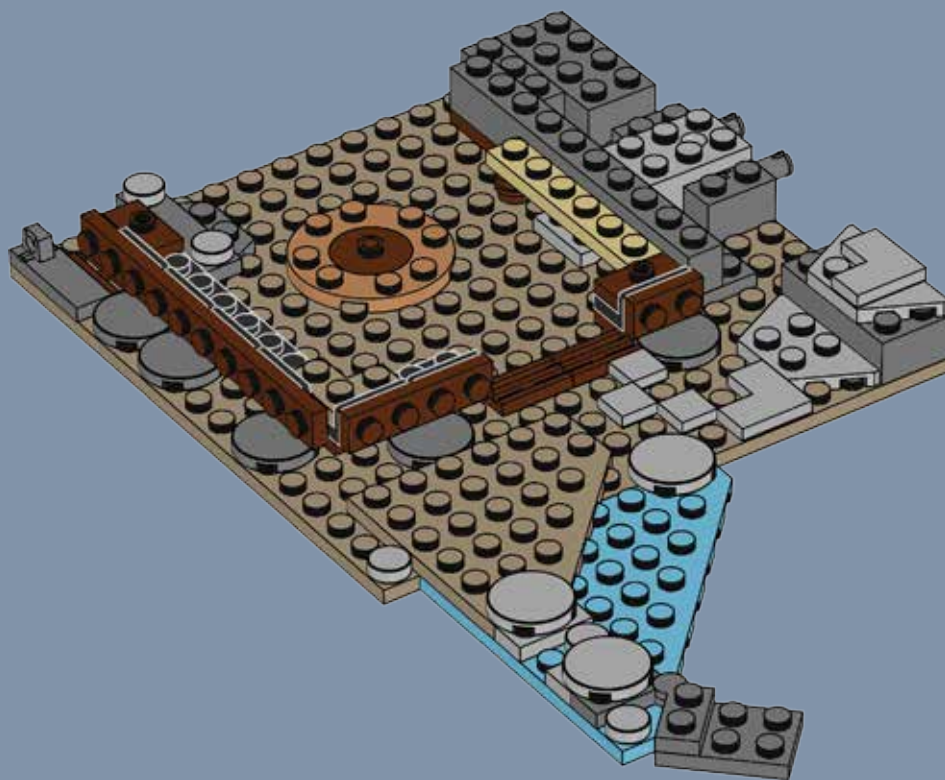



6x



2x

12

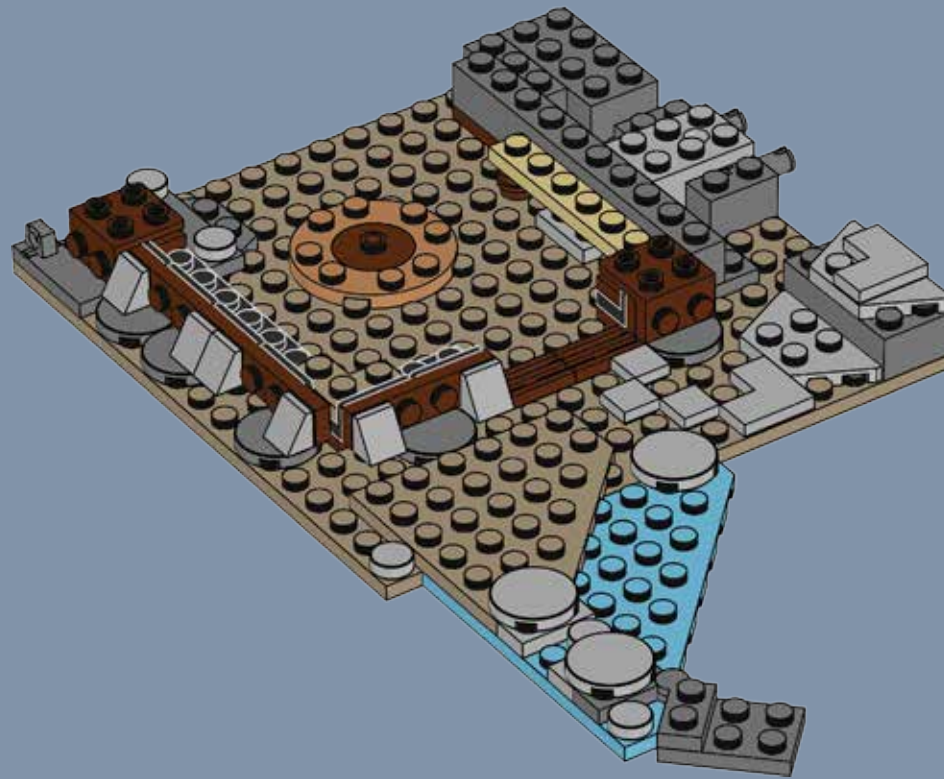



13

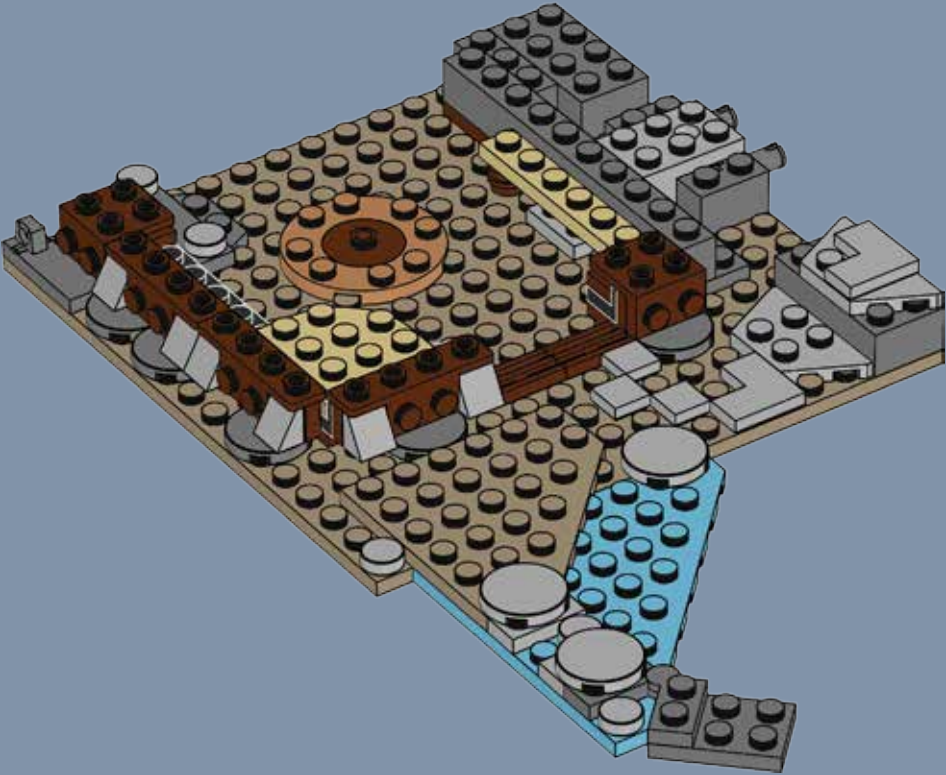

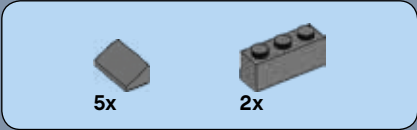

14

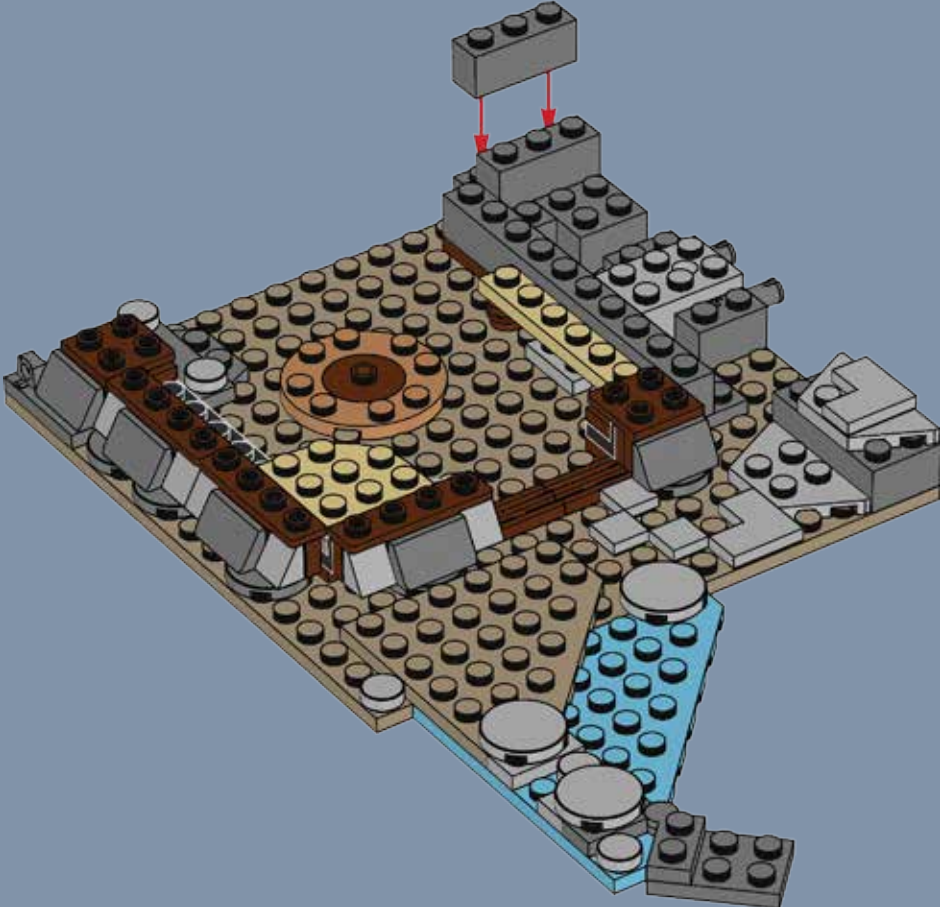



15





16

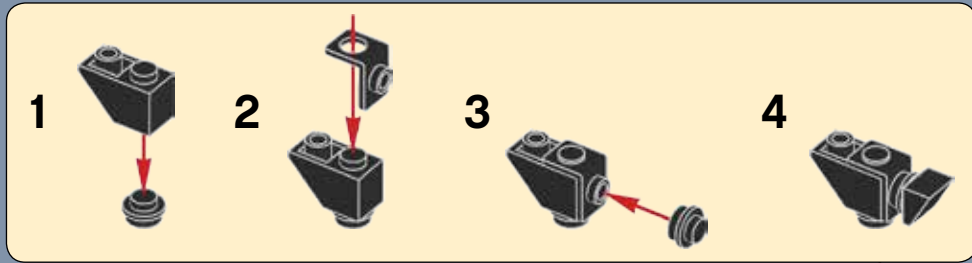



17

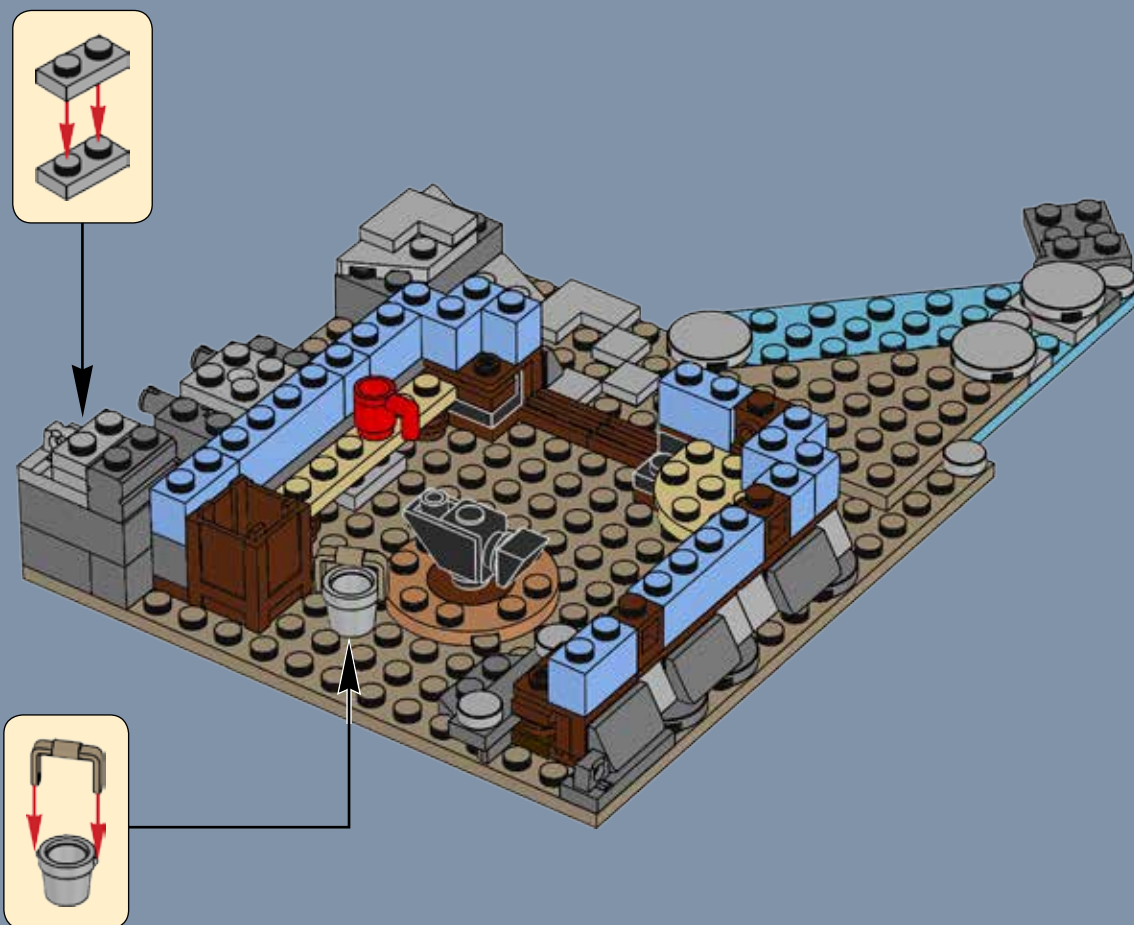

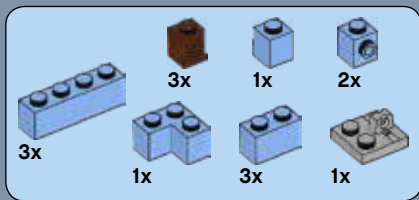

18

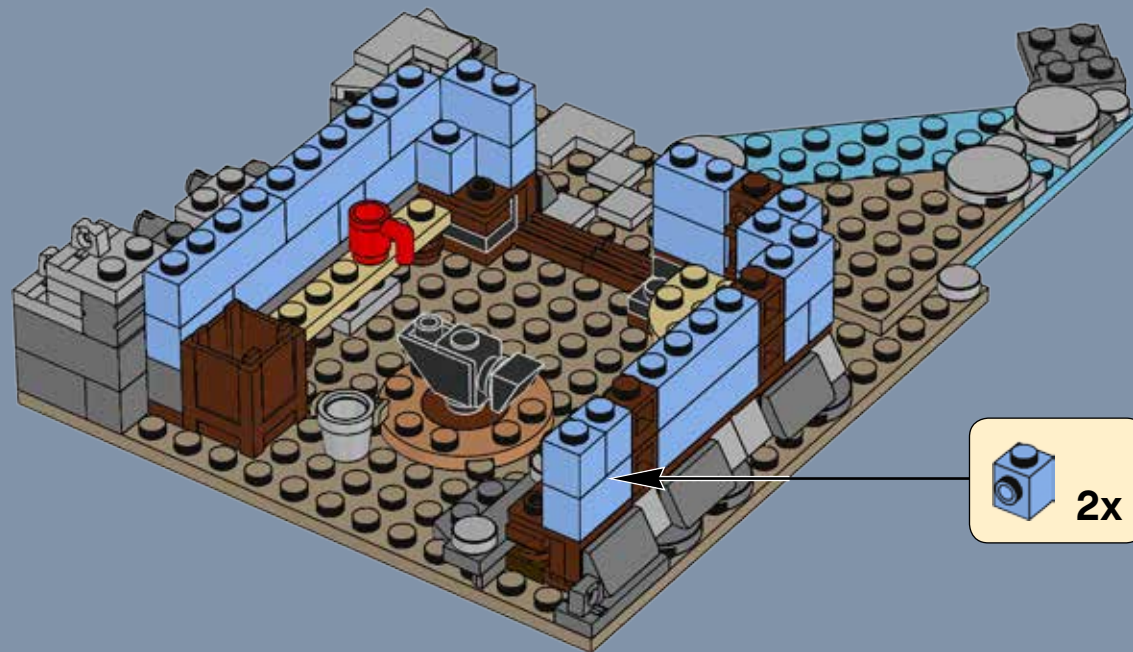

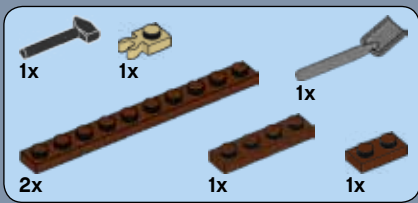

19



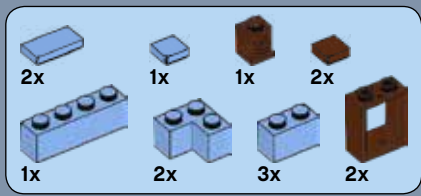

20



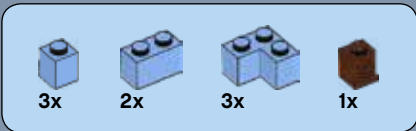

21



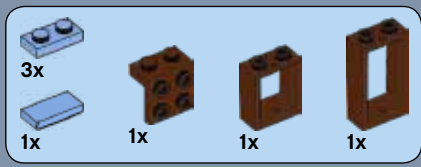

22

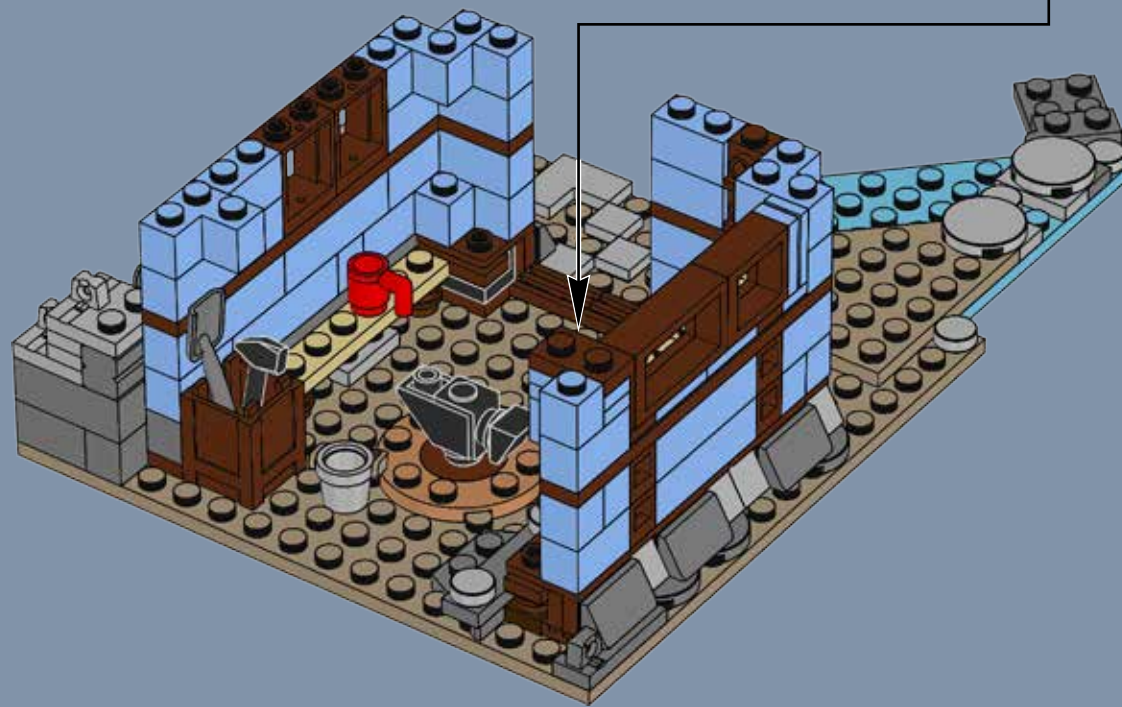
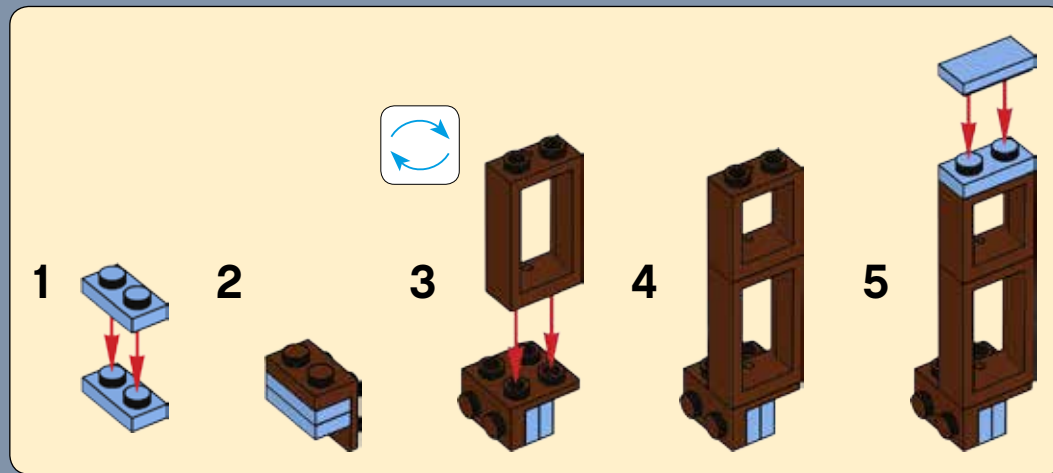



23



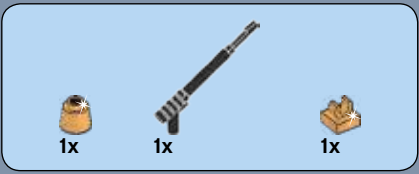

24

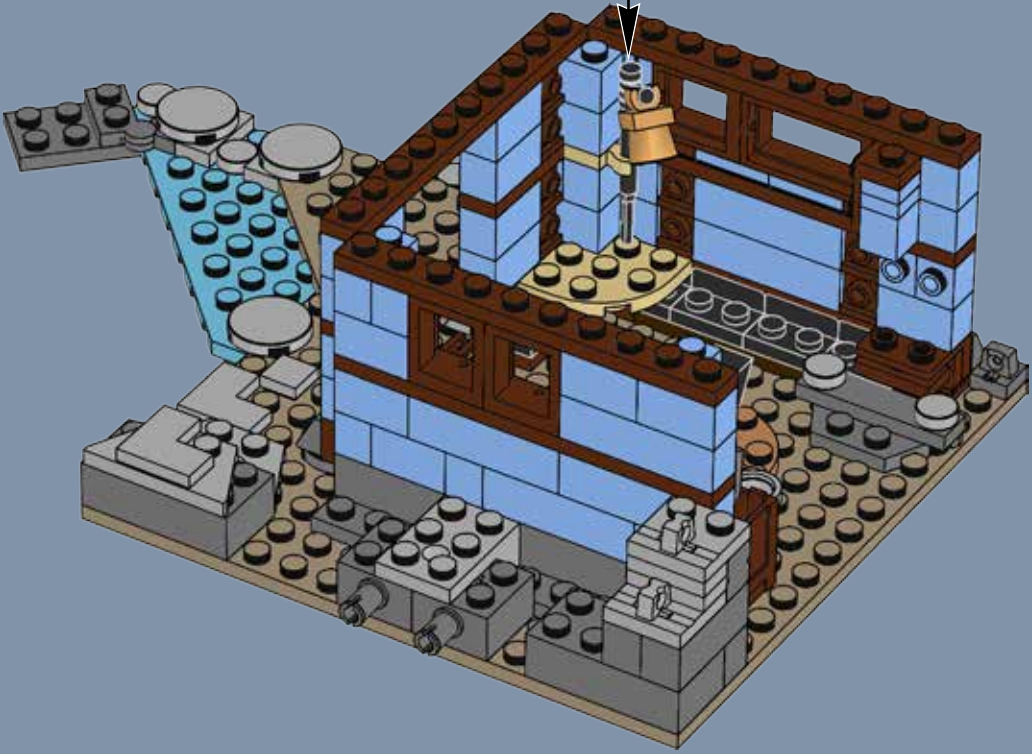
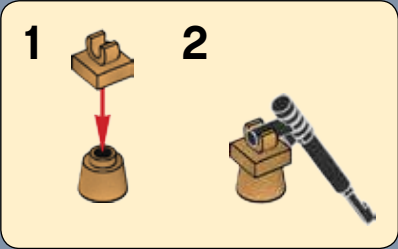

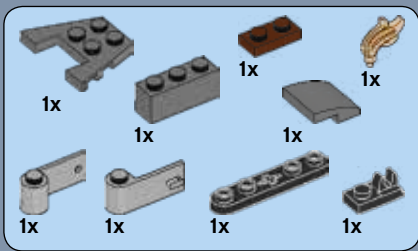

25

1

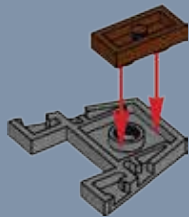

2

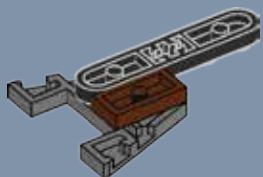

3

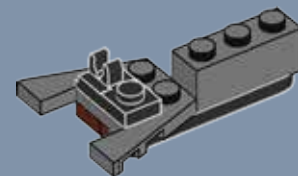
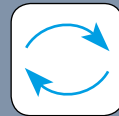

4

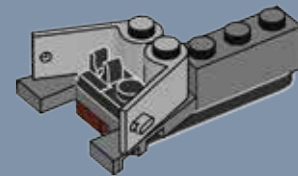

5

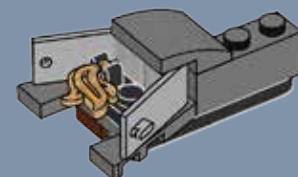



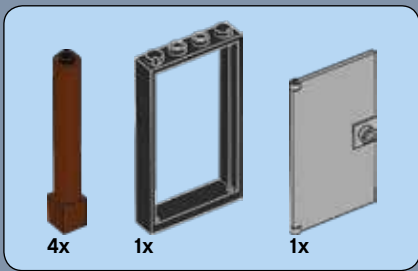

26

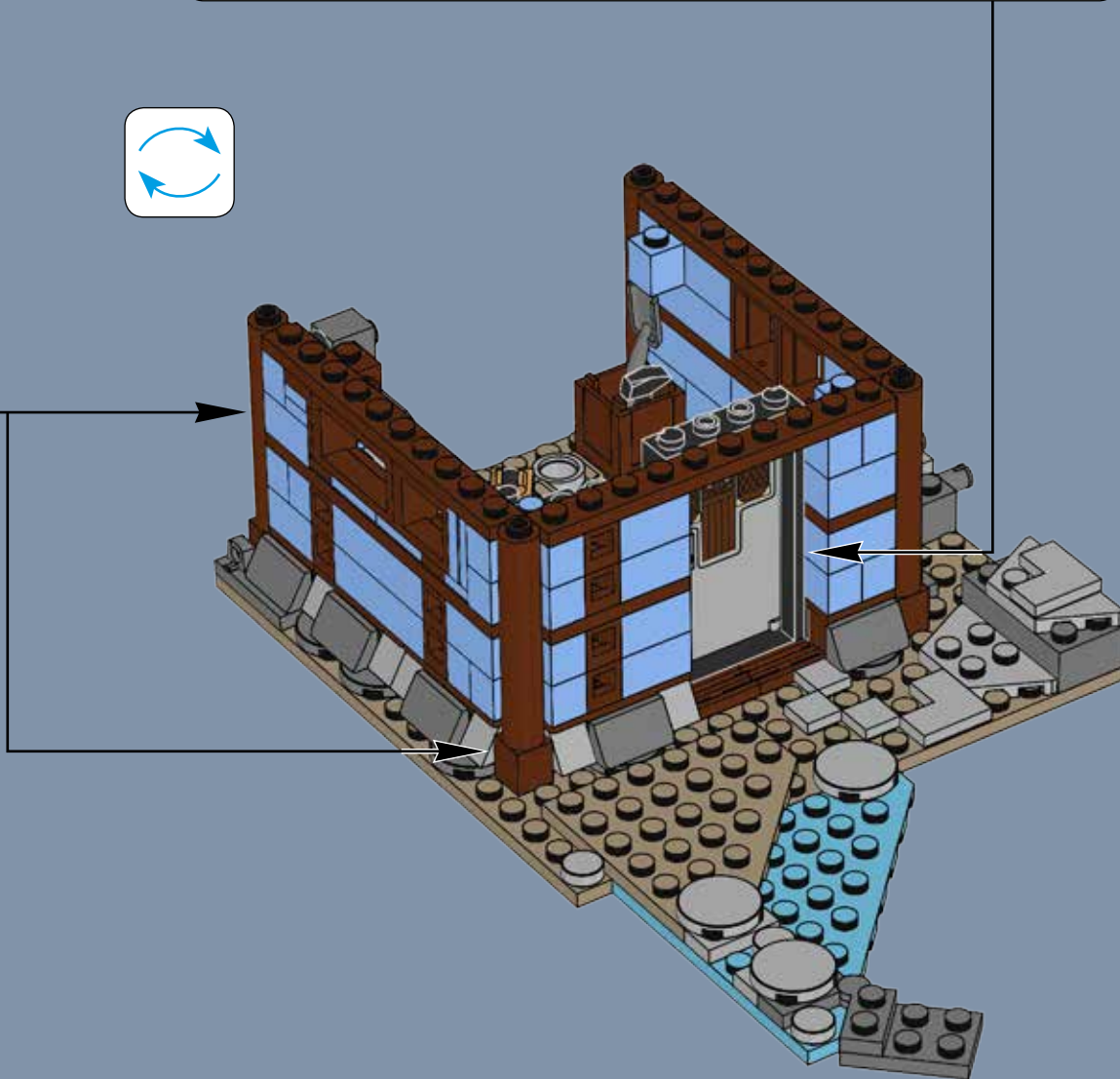
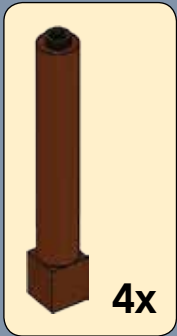
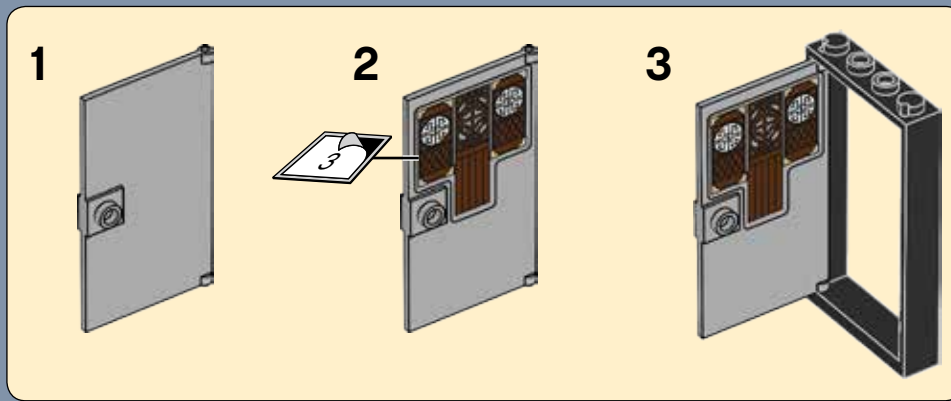

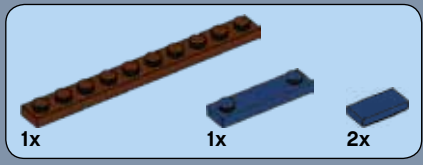

27

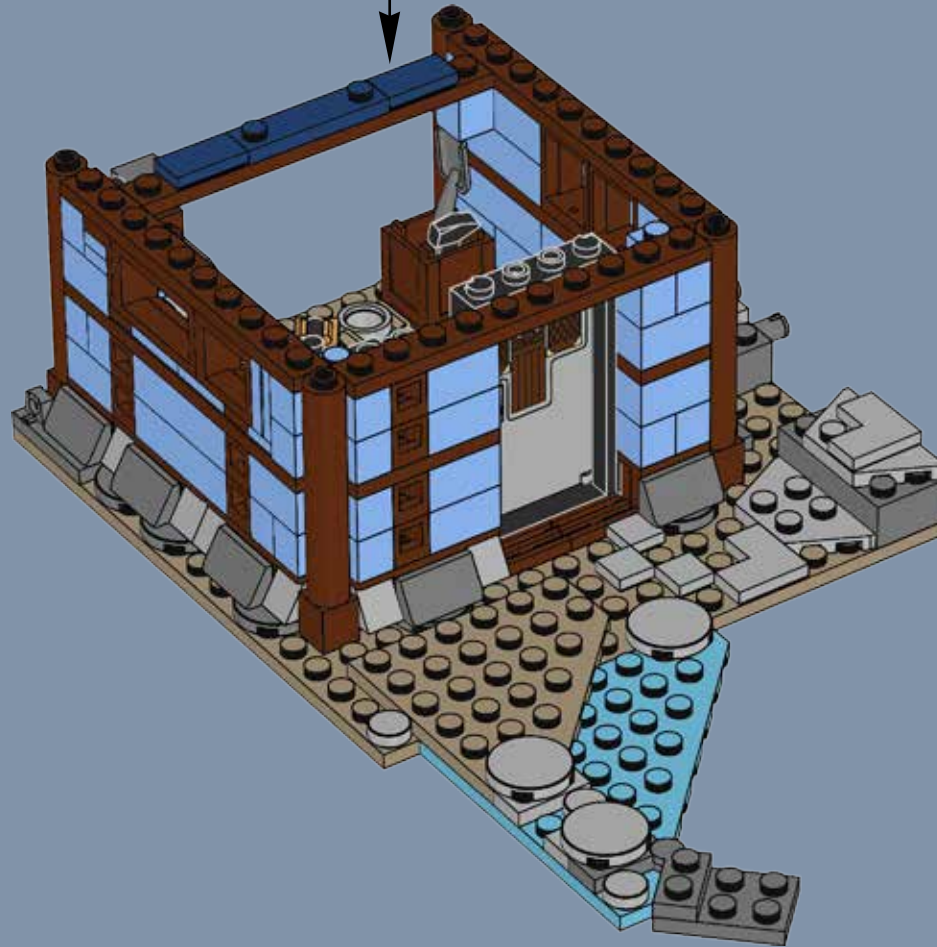
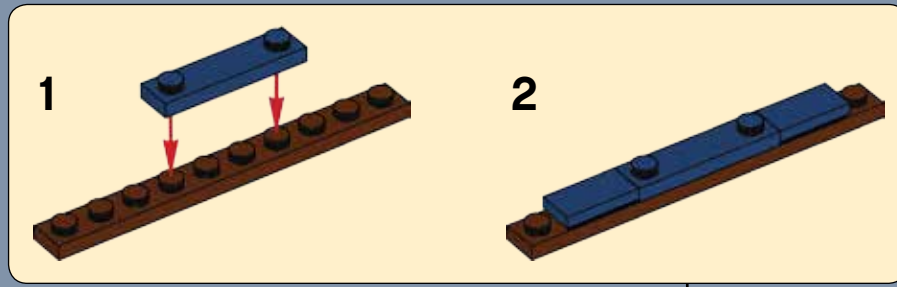



28

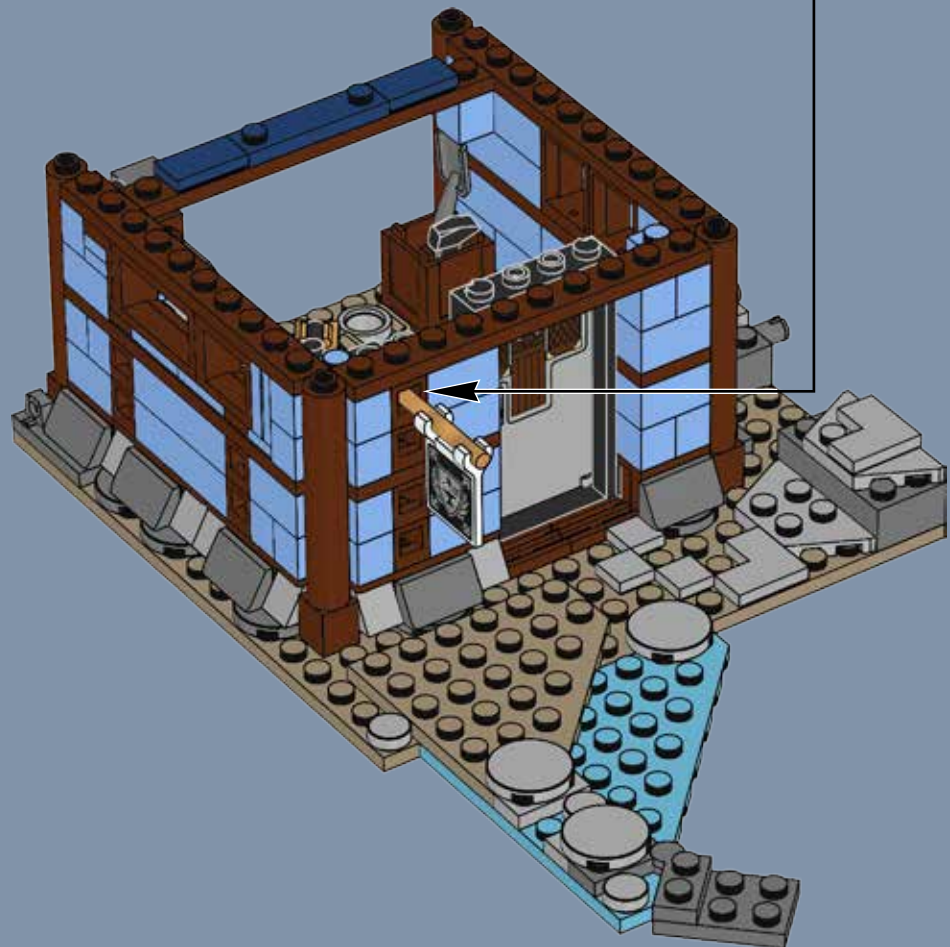
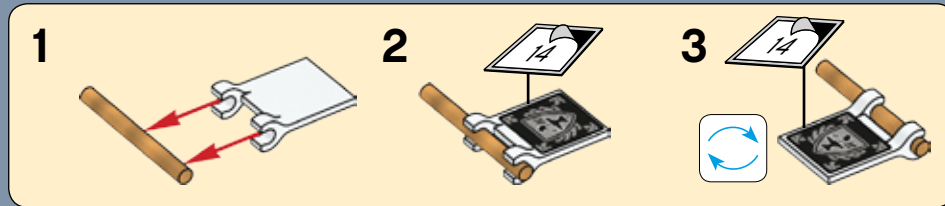

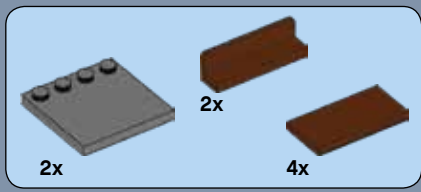

29



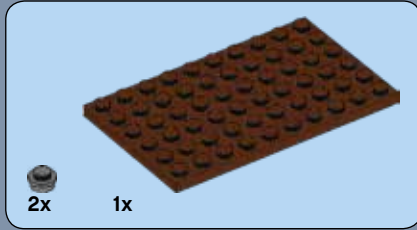
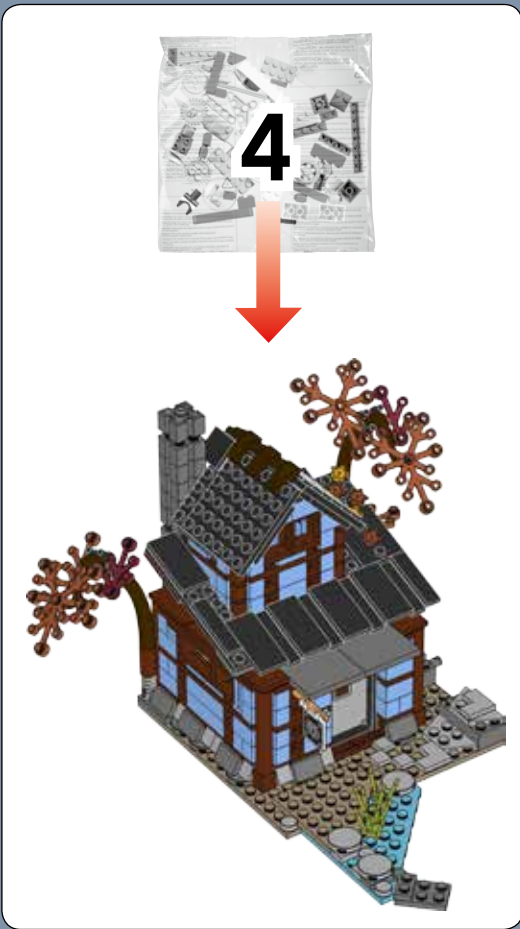

1

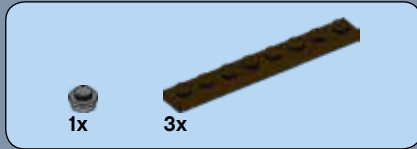
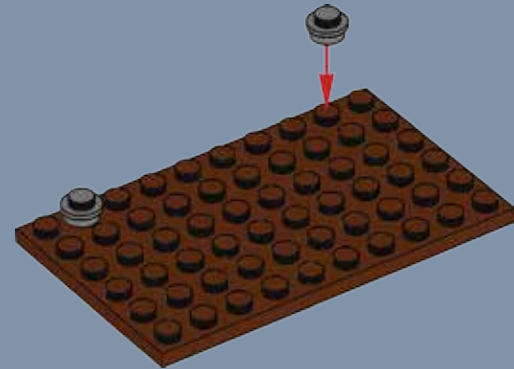

2





3

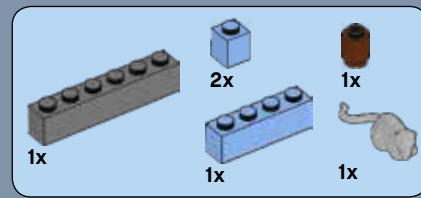
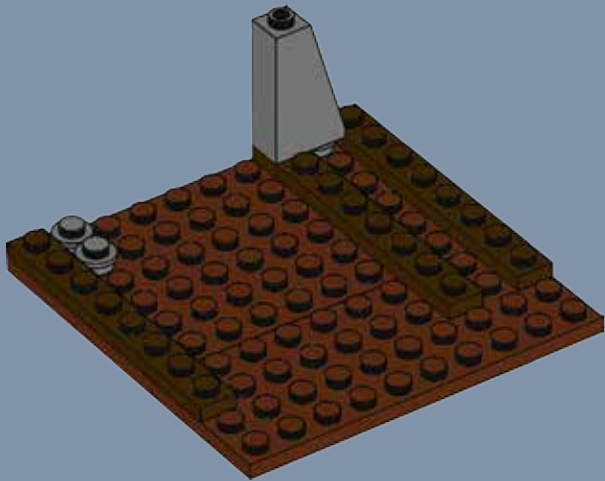

4

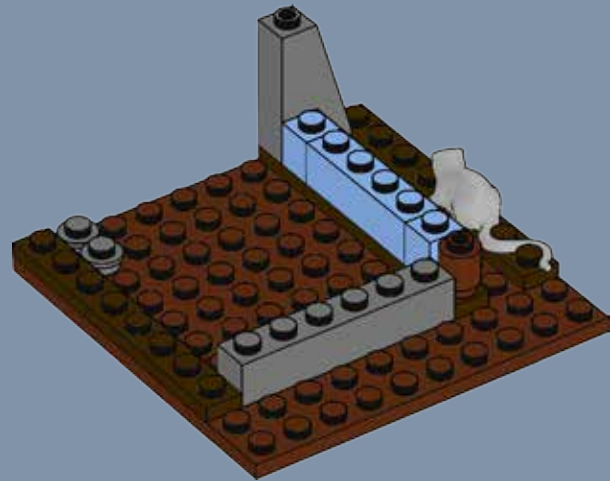

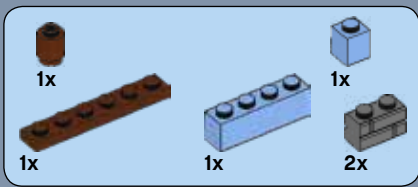

5

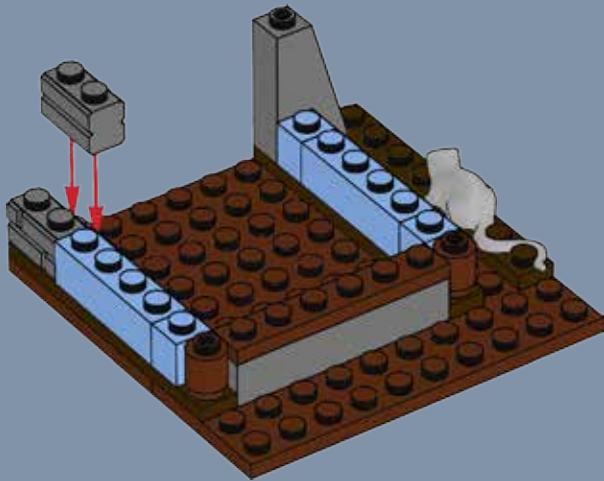

6

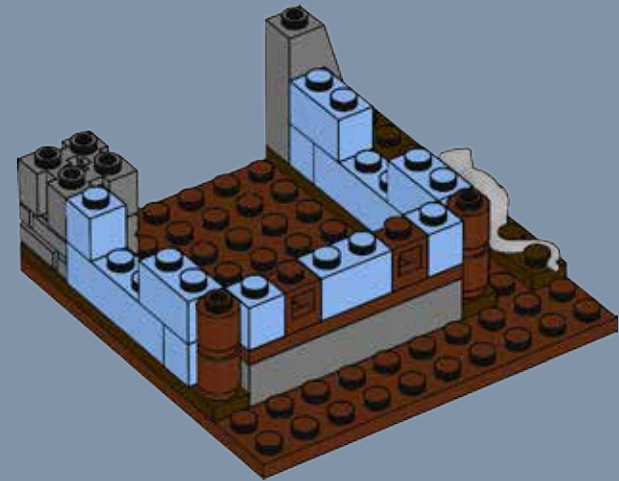

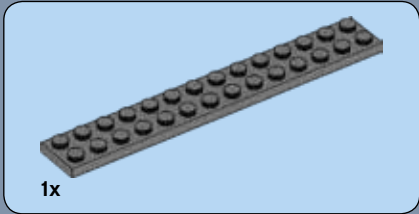
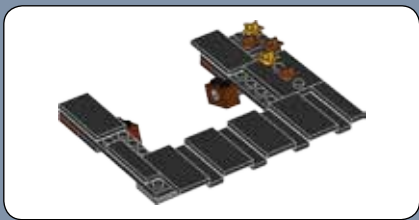

1

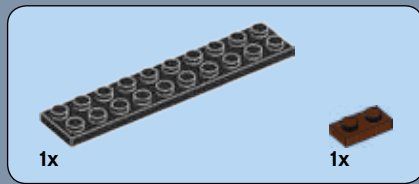
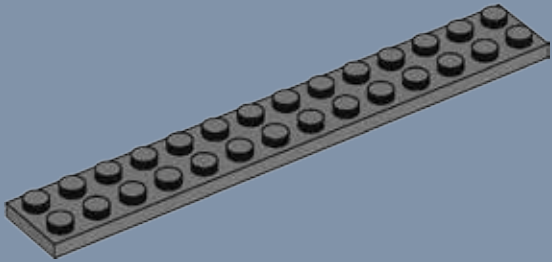

2

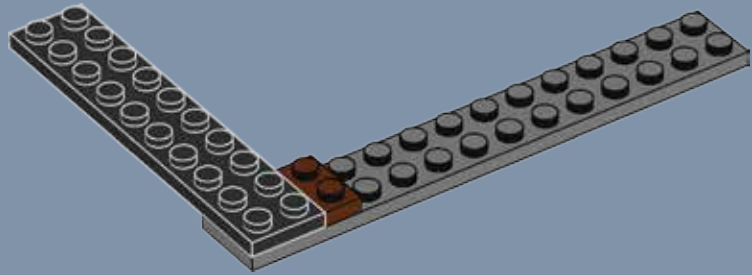

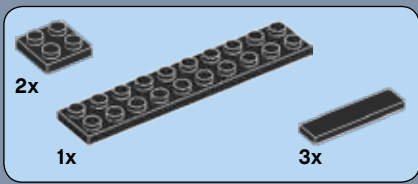

3

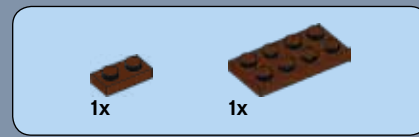
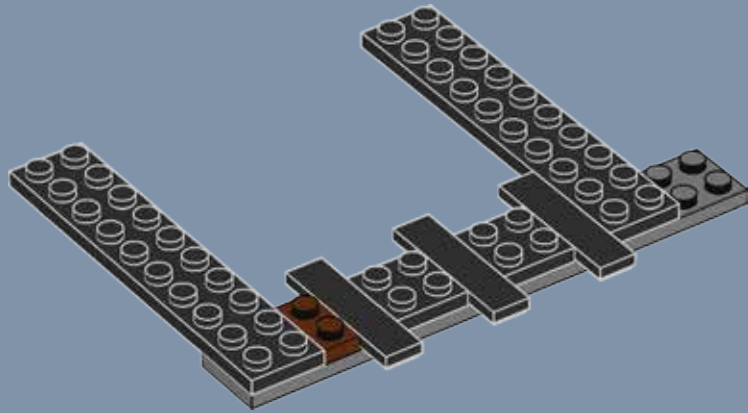

4

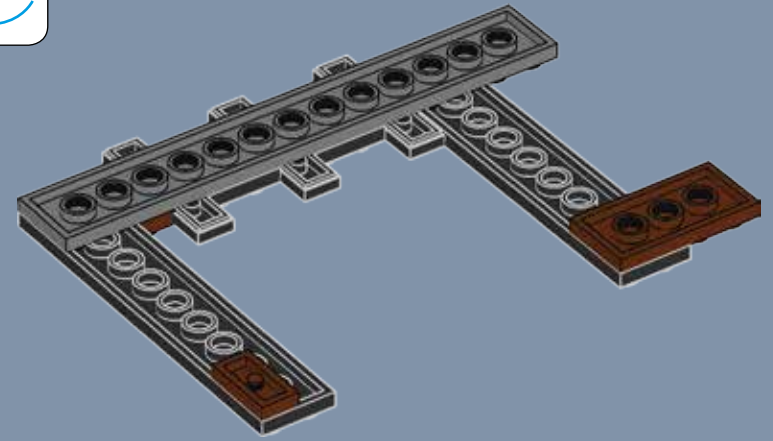

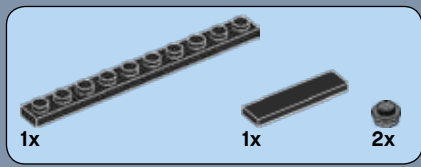

5

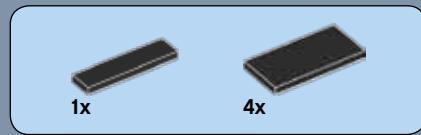
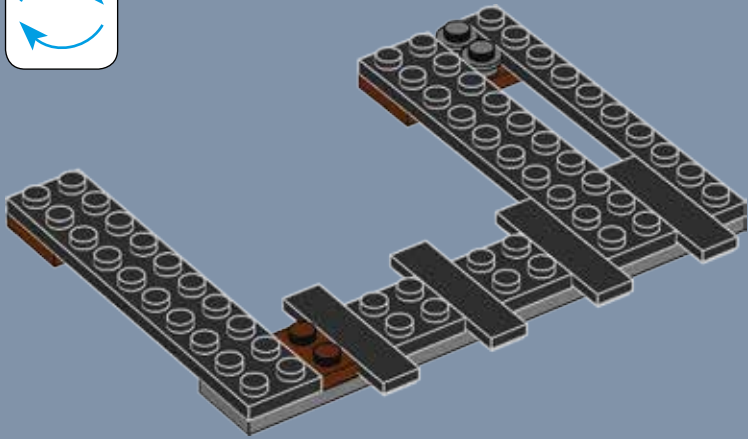

6

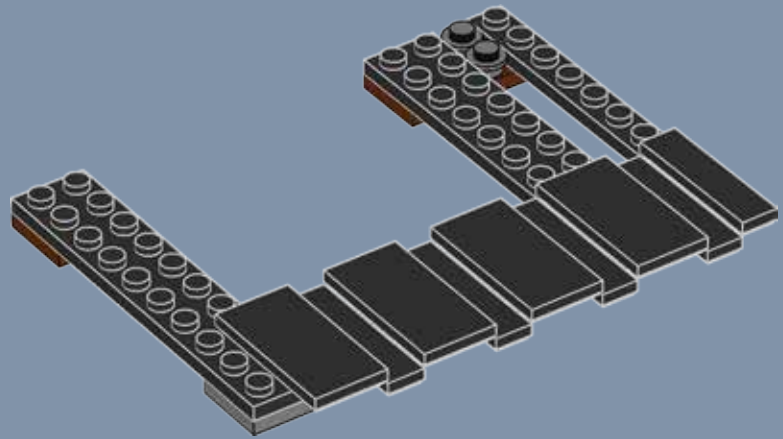

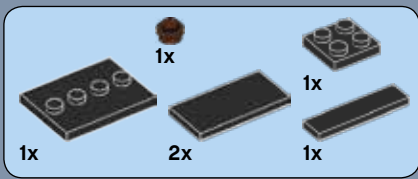

7

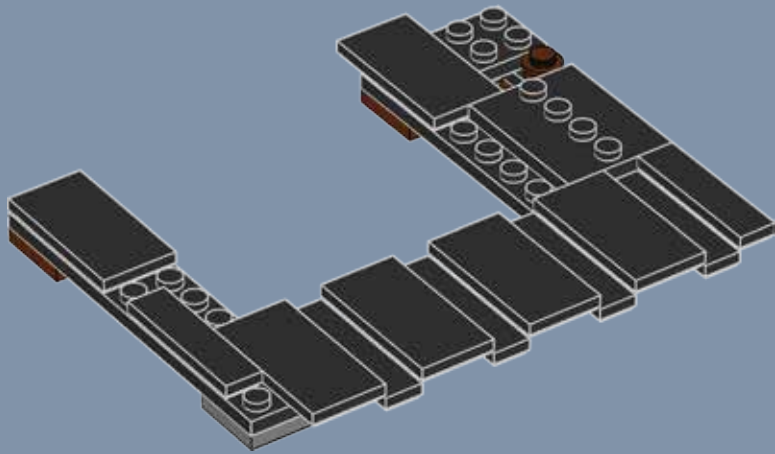

8

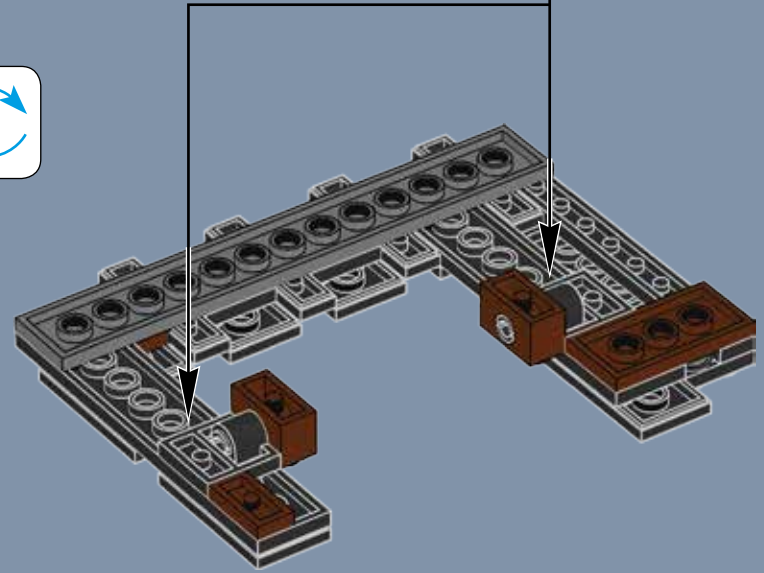
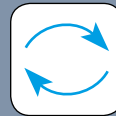
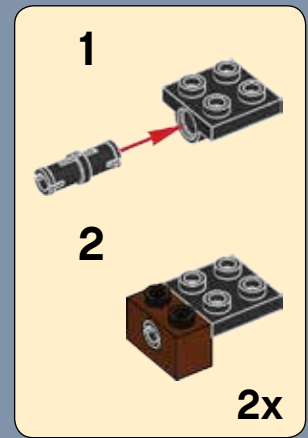

2x  3x 

9

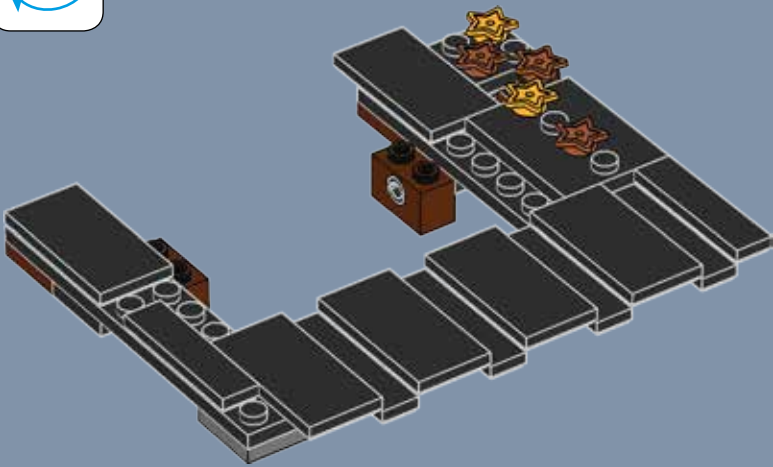

7

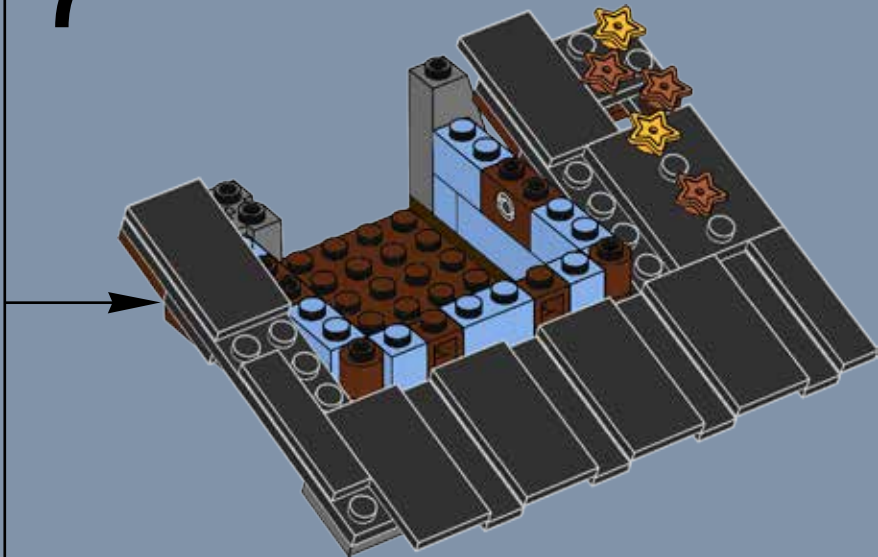

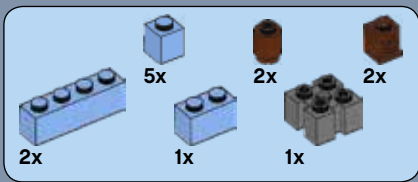

8

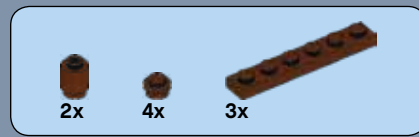
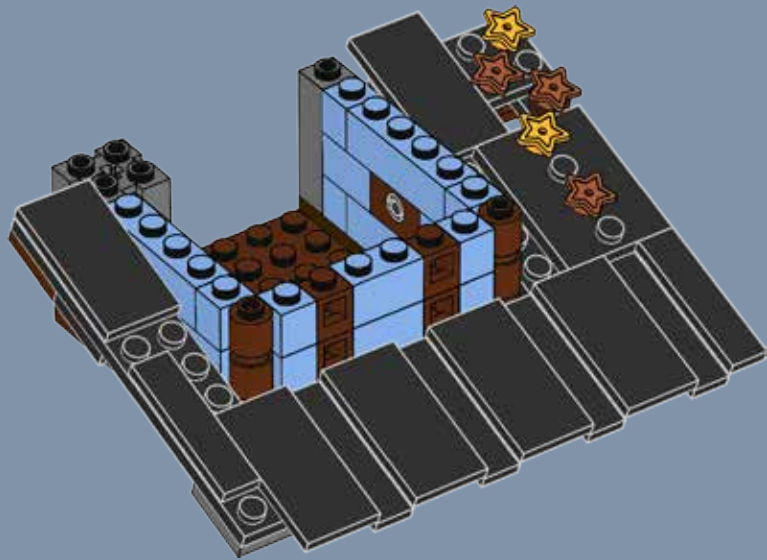

9

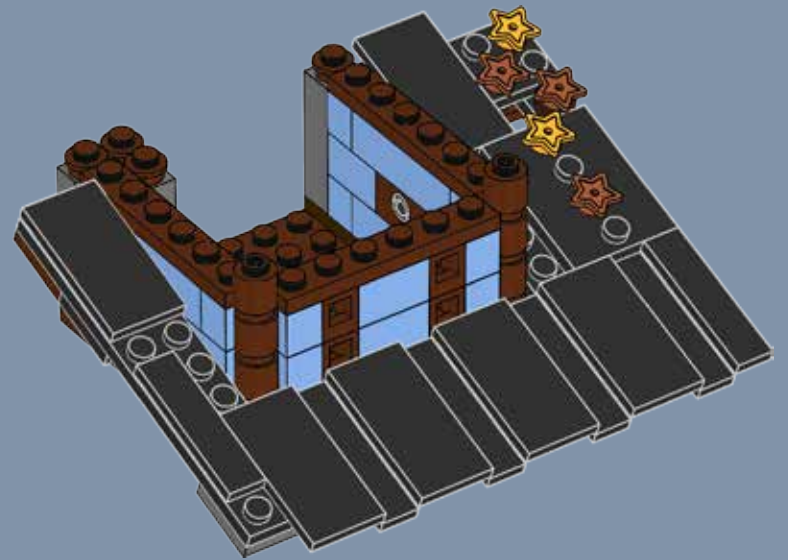



10

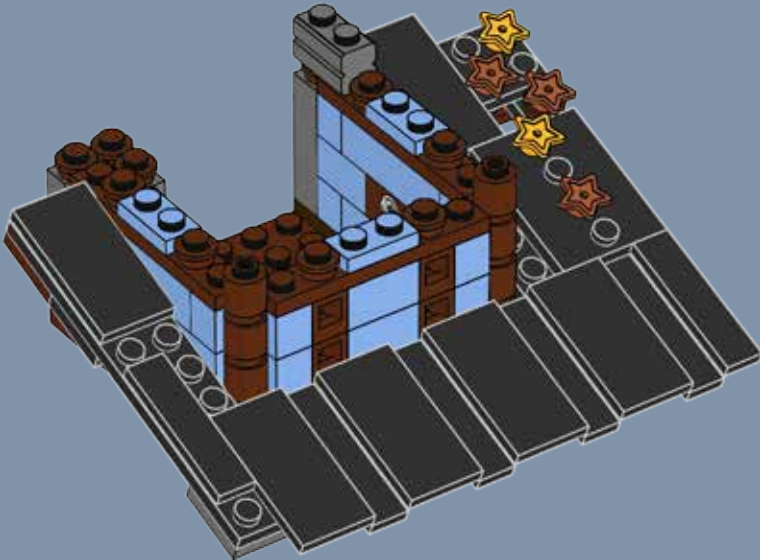

11

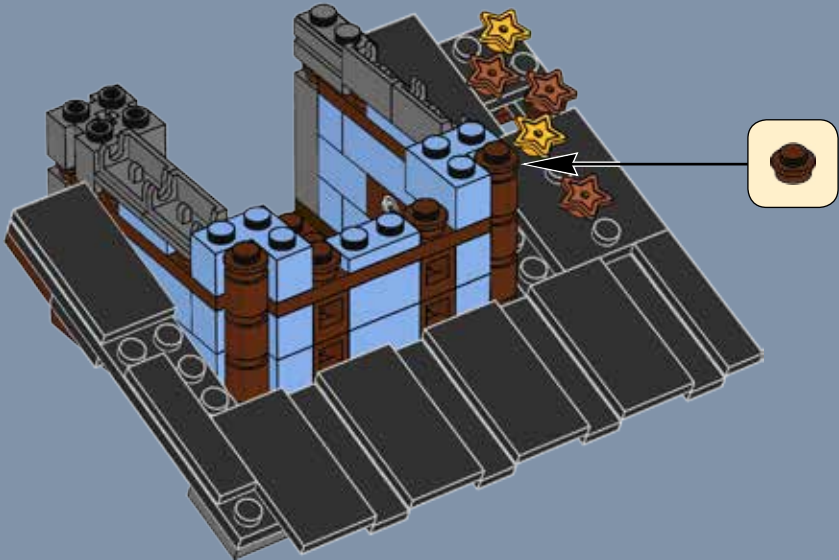



12

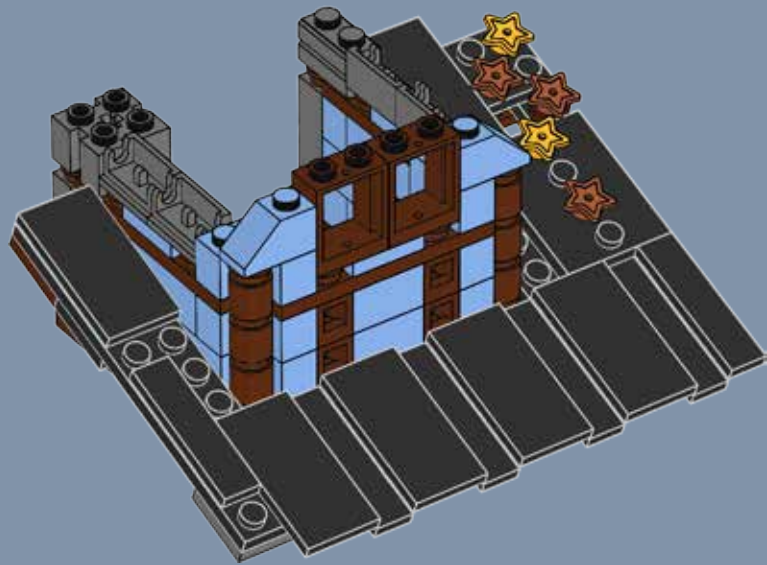

13

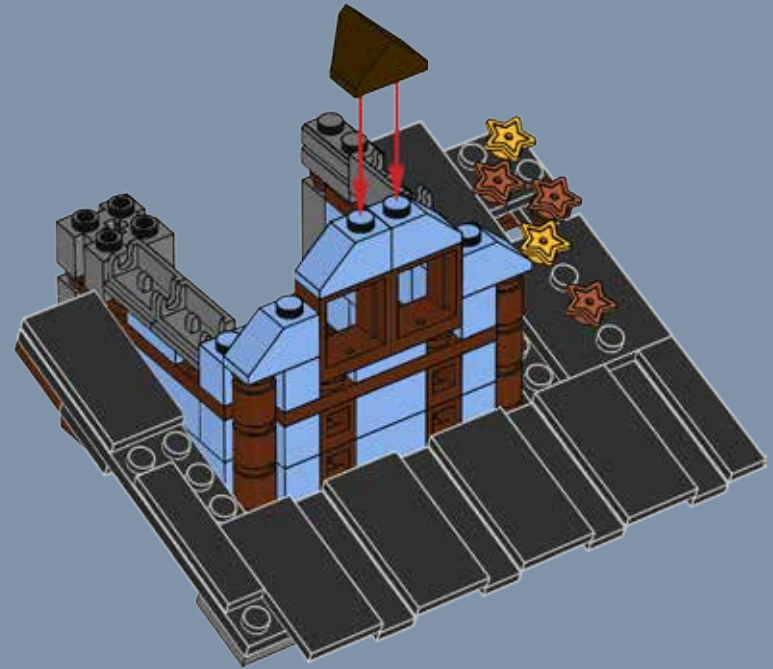

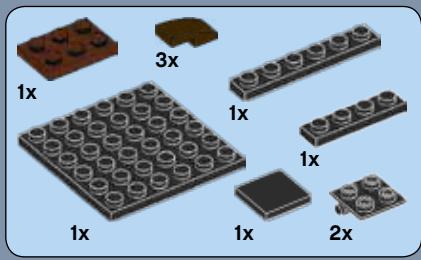

14

1

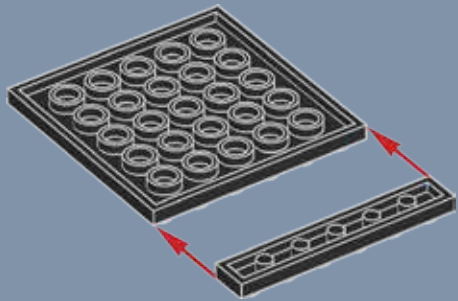

2

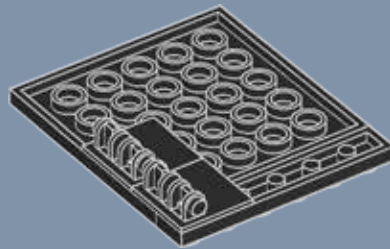

3

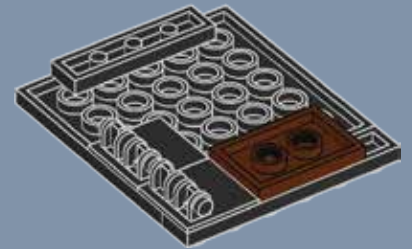

4

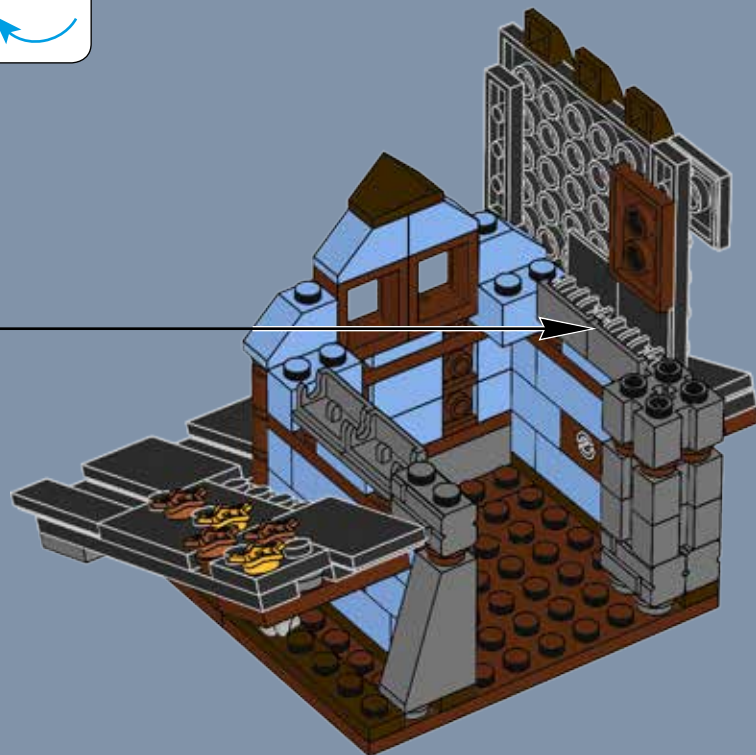
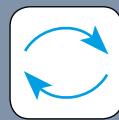
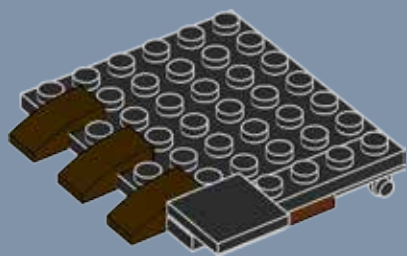

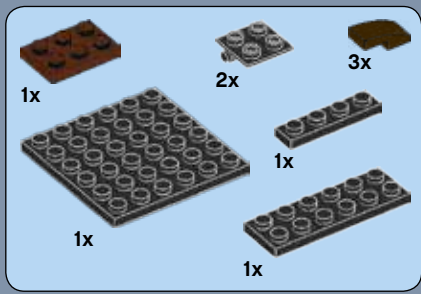

15

1

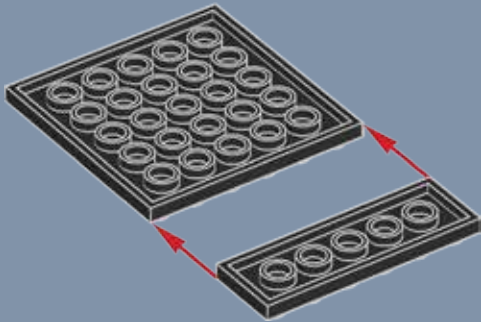

2

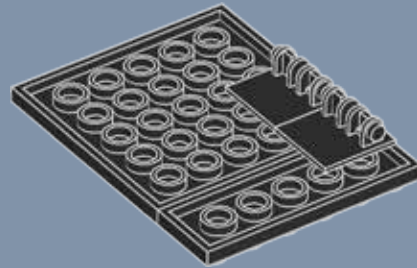

3

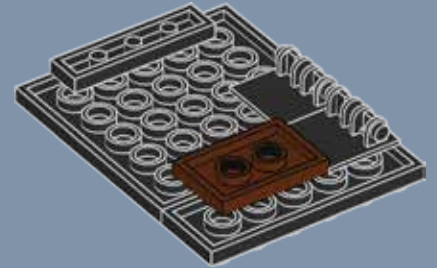

4

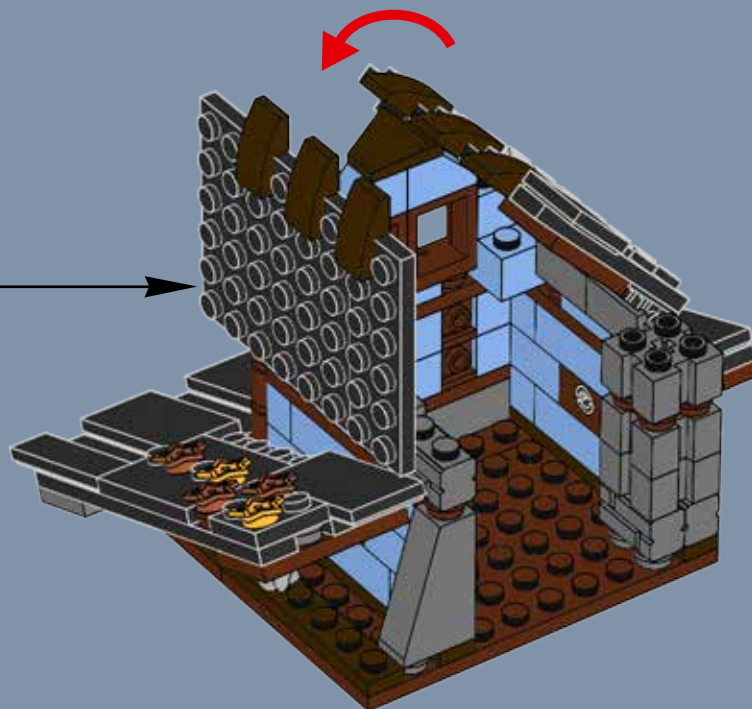
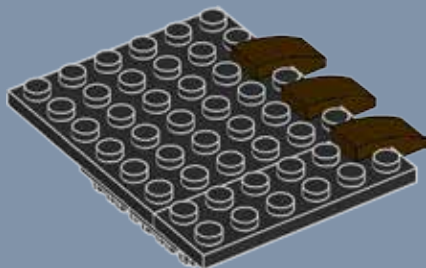



16

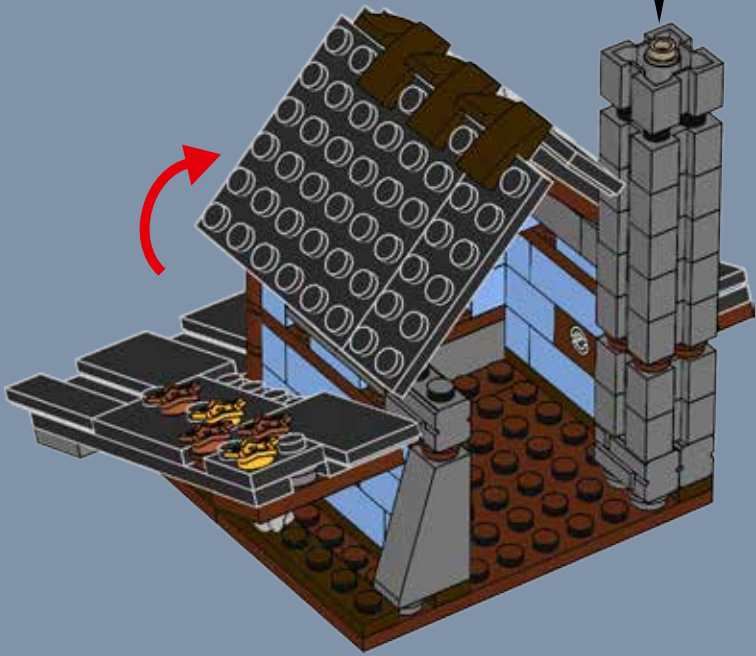
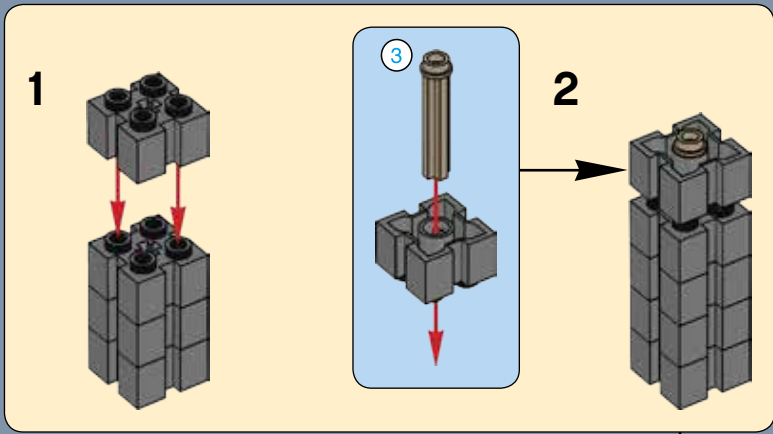

30





31

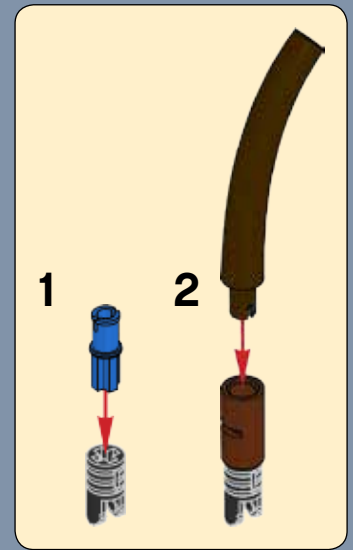
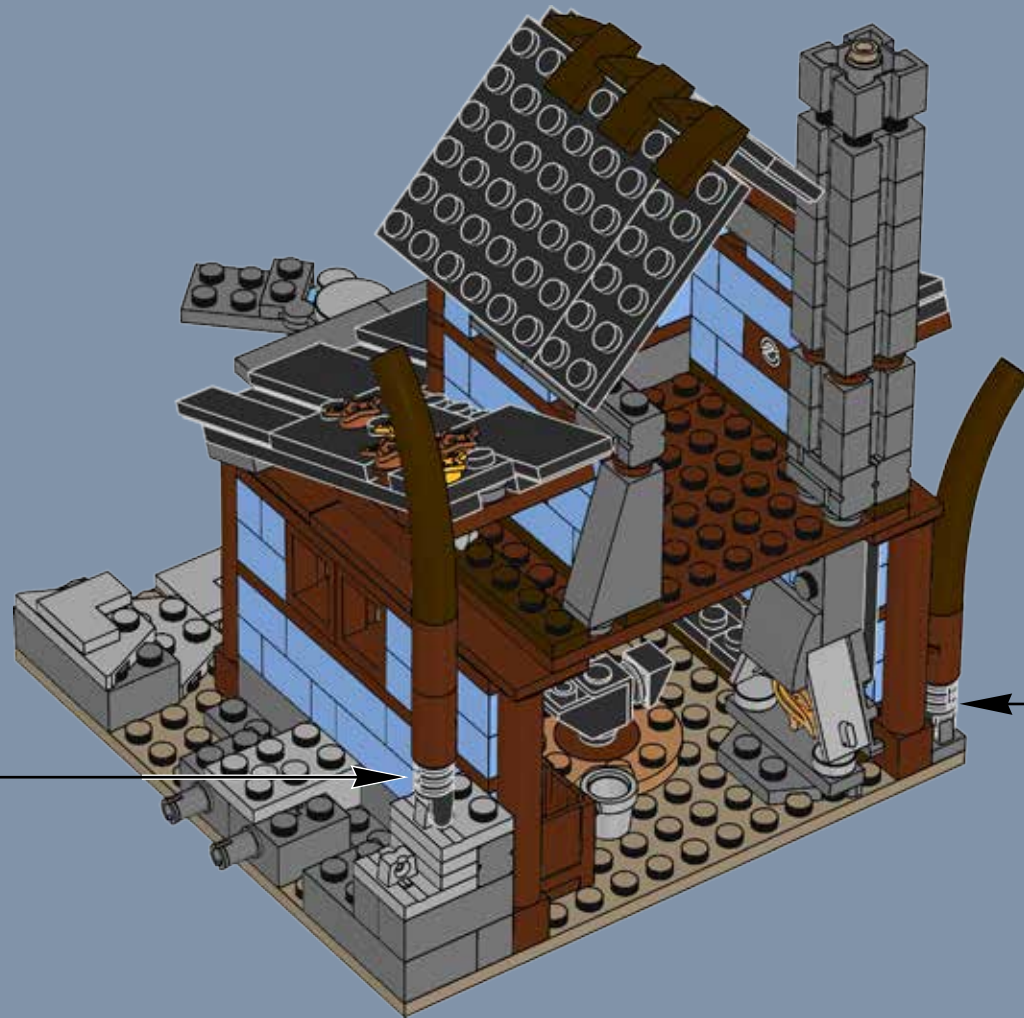
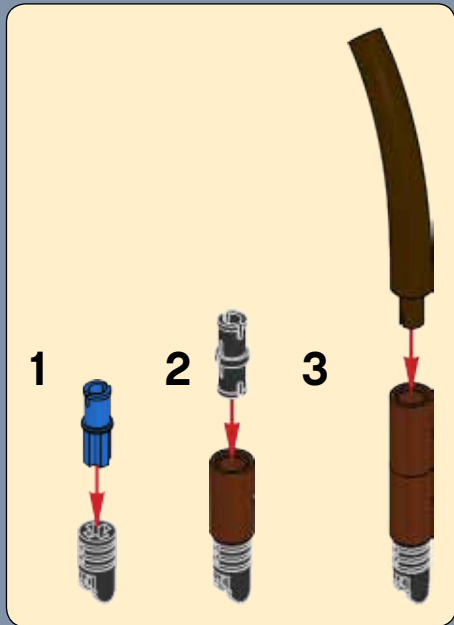

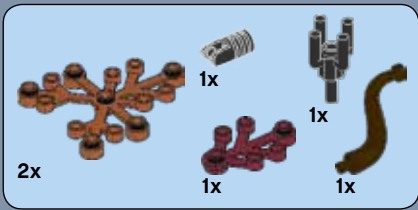

32

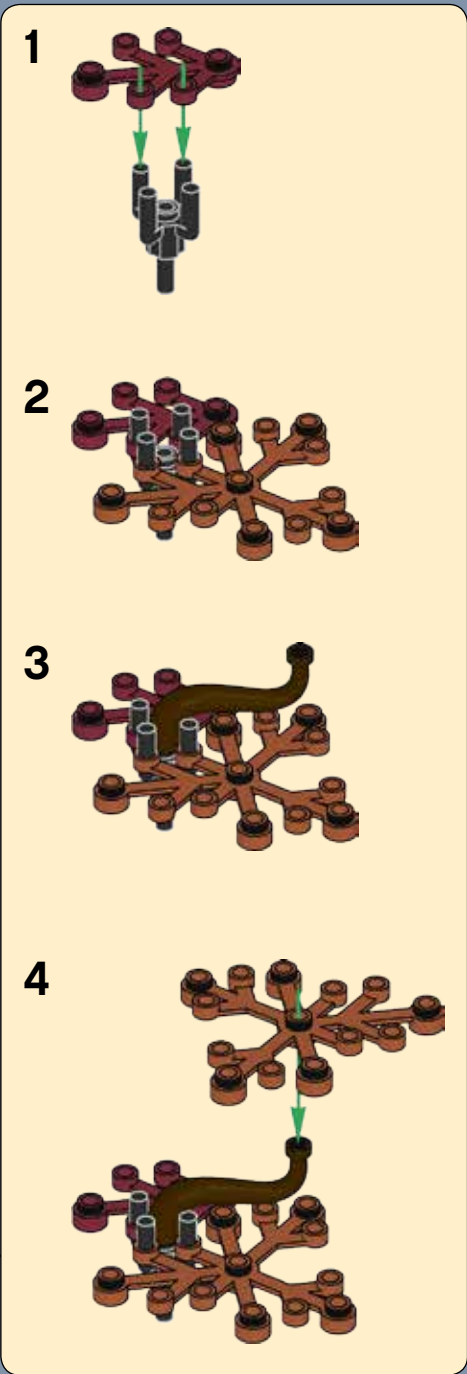
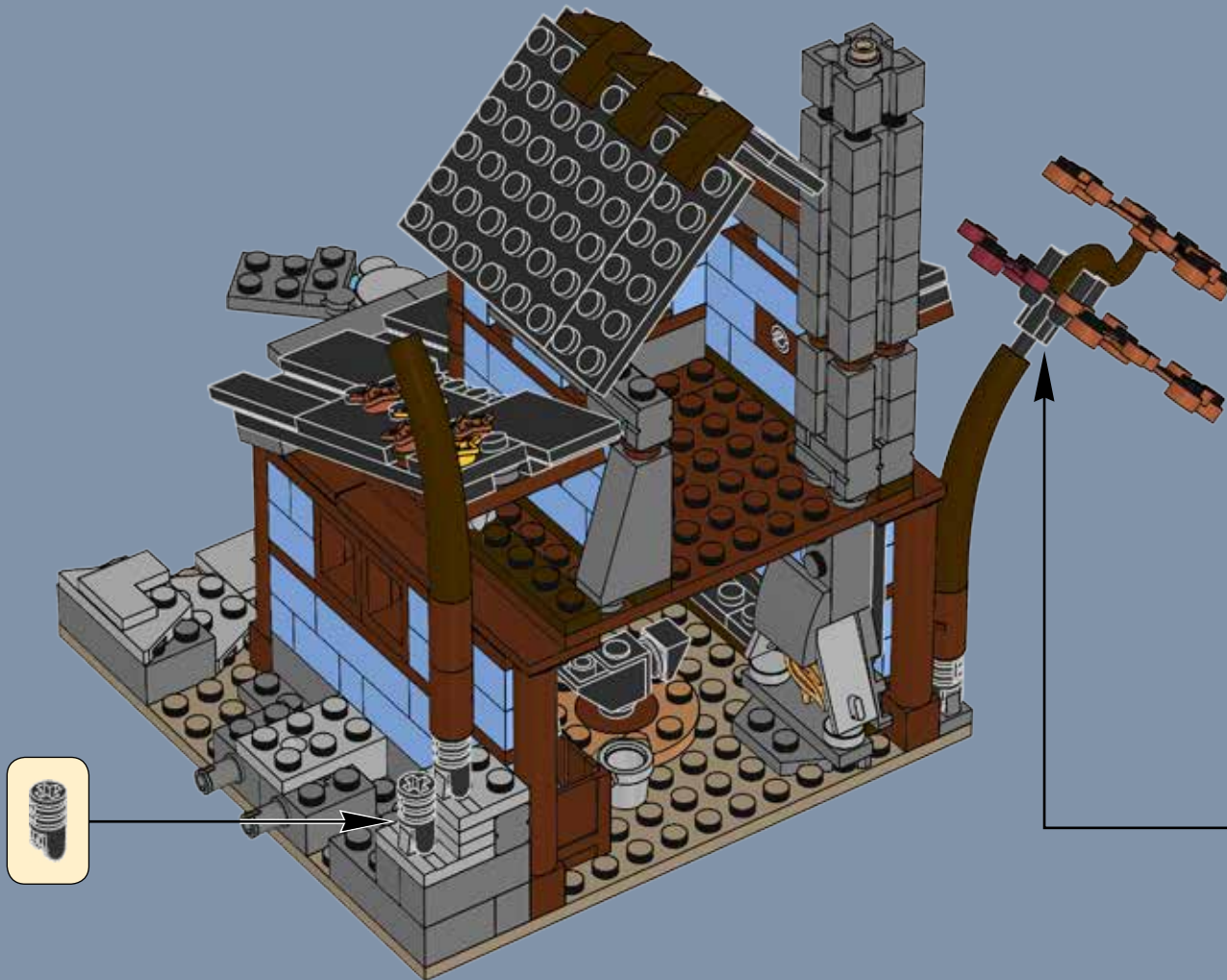

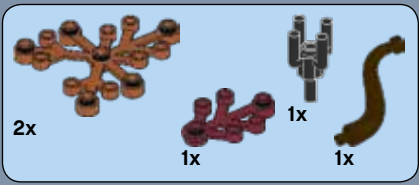

33

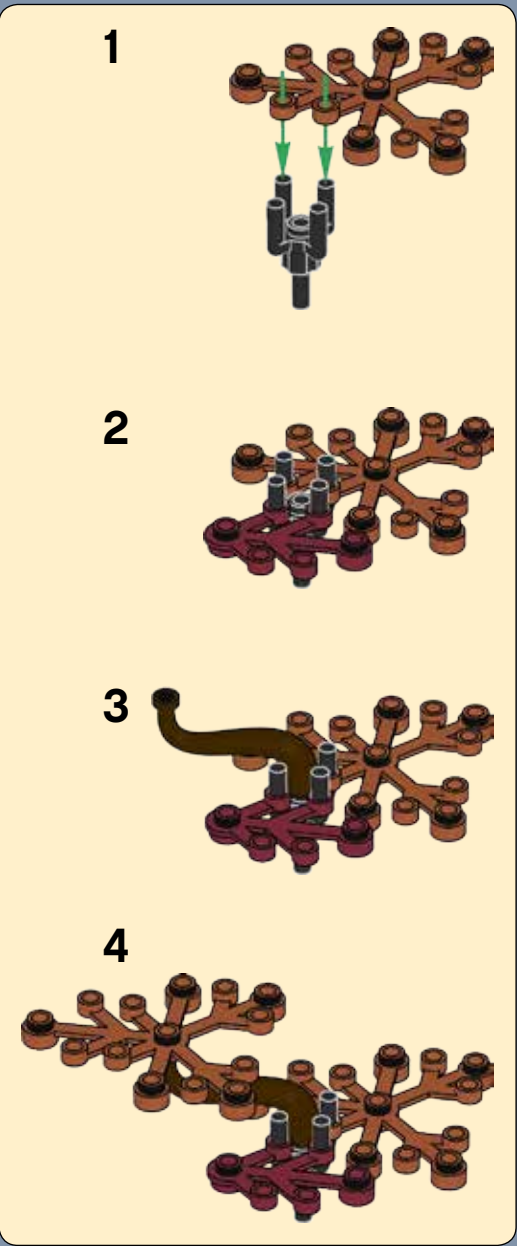

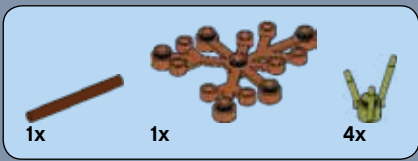

34

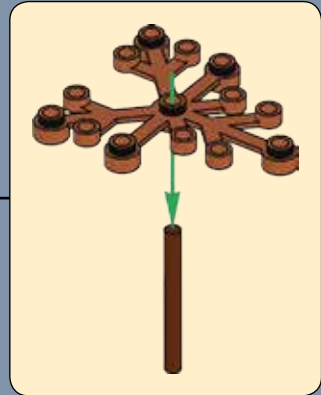
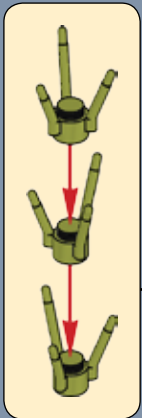

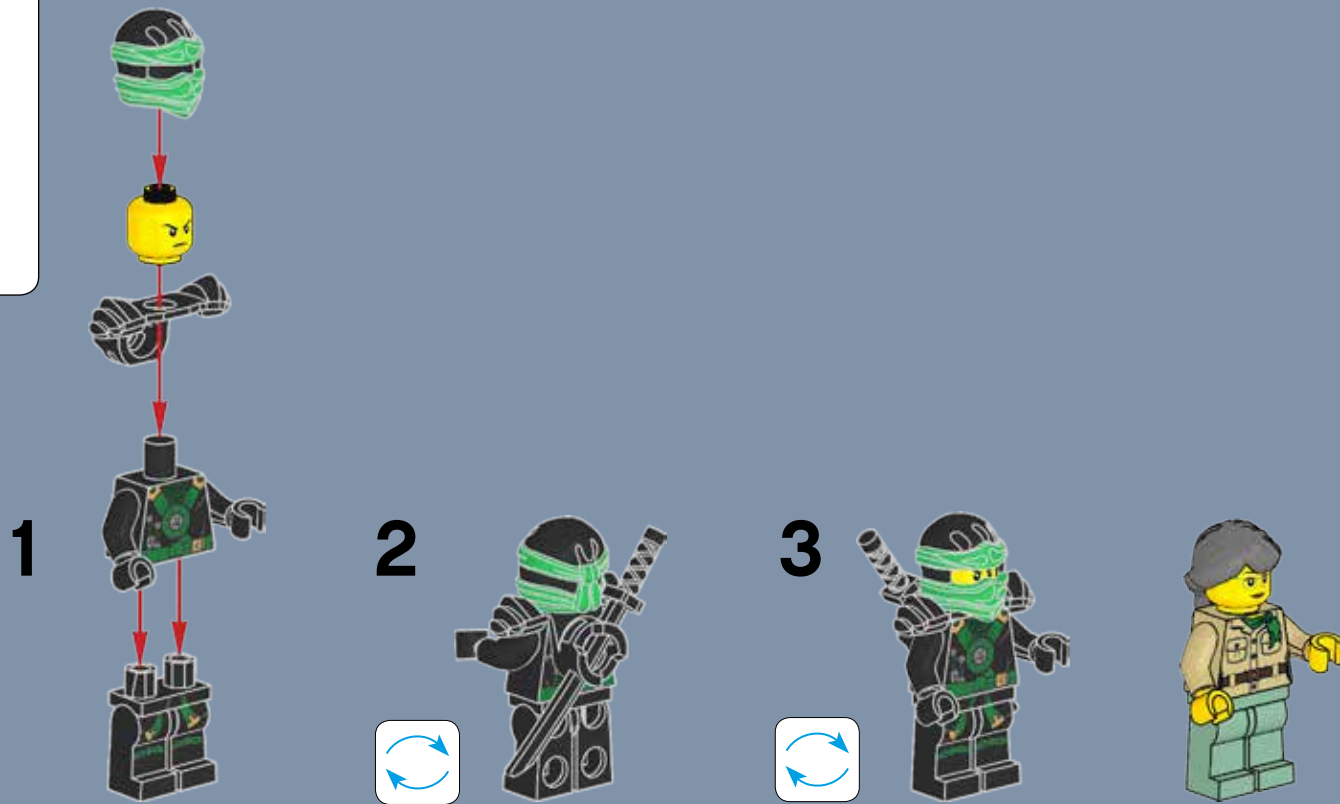
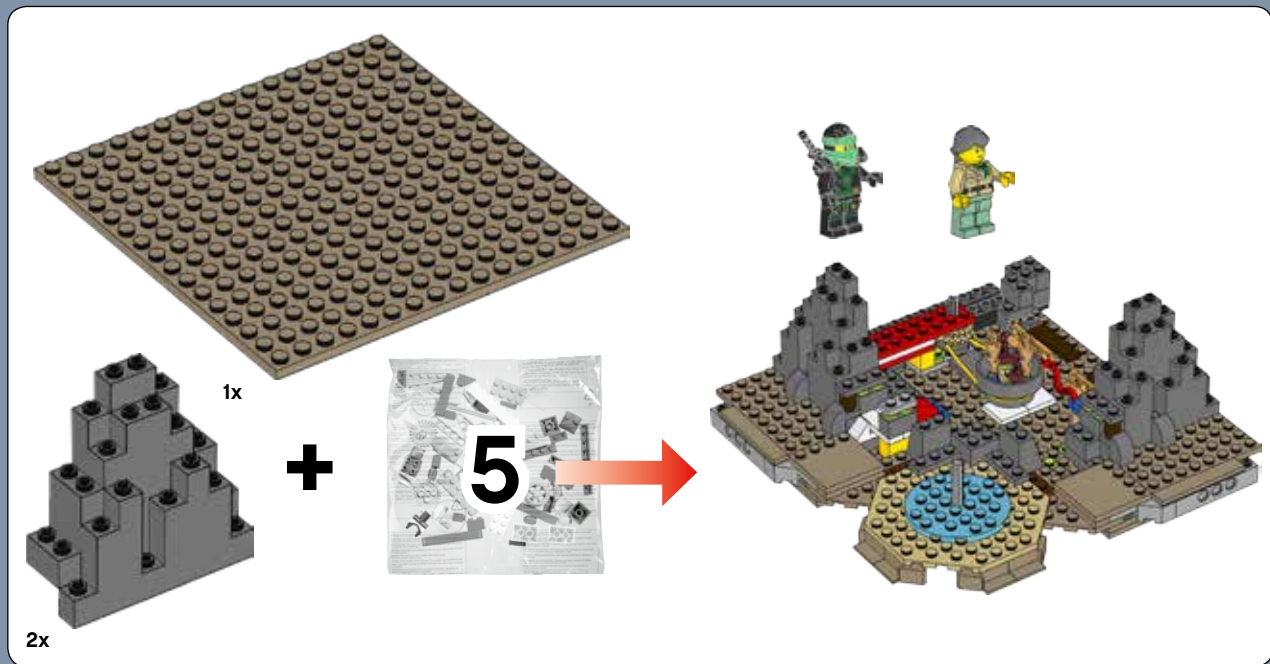
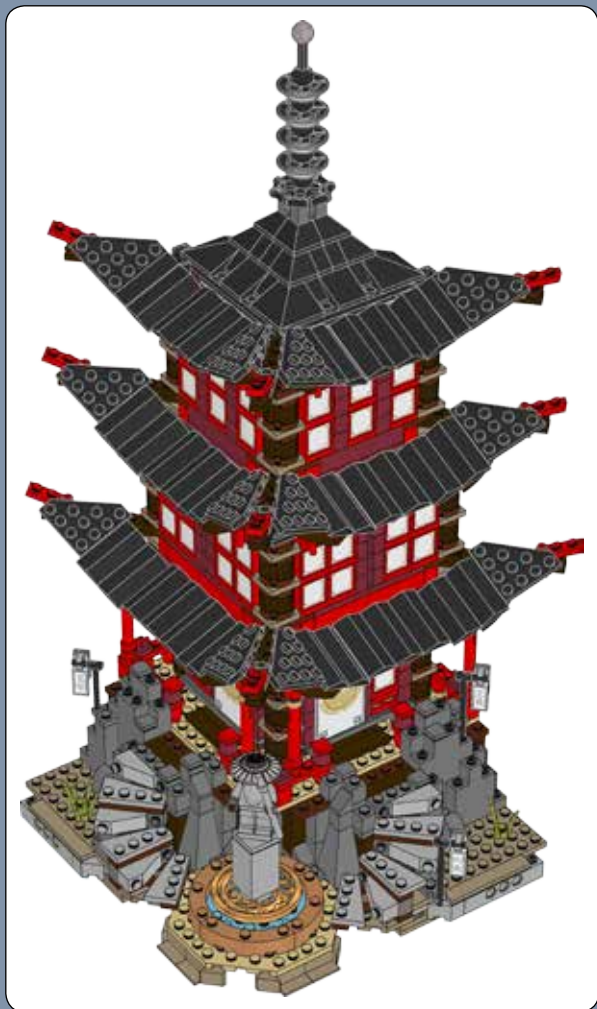

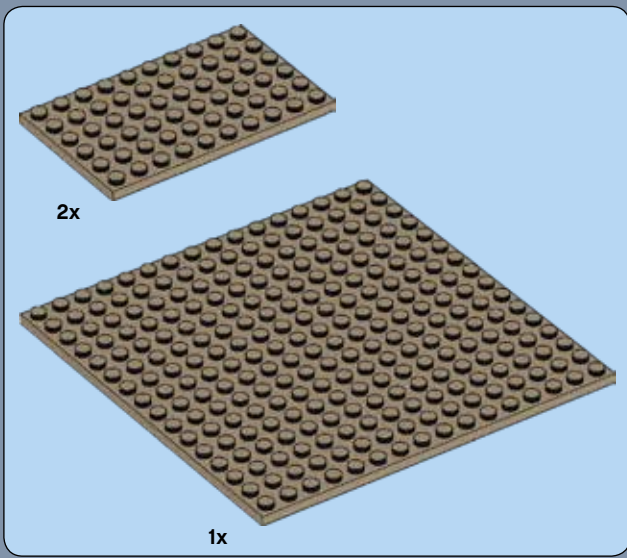

1

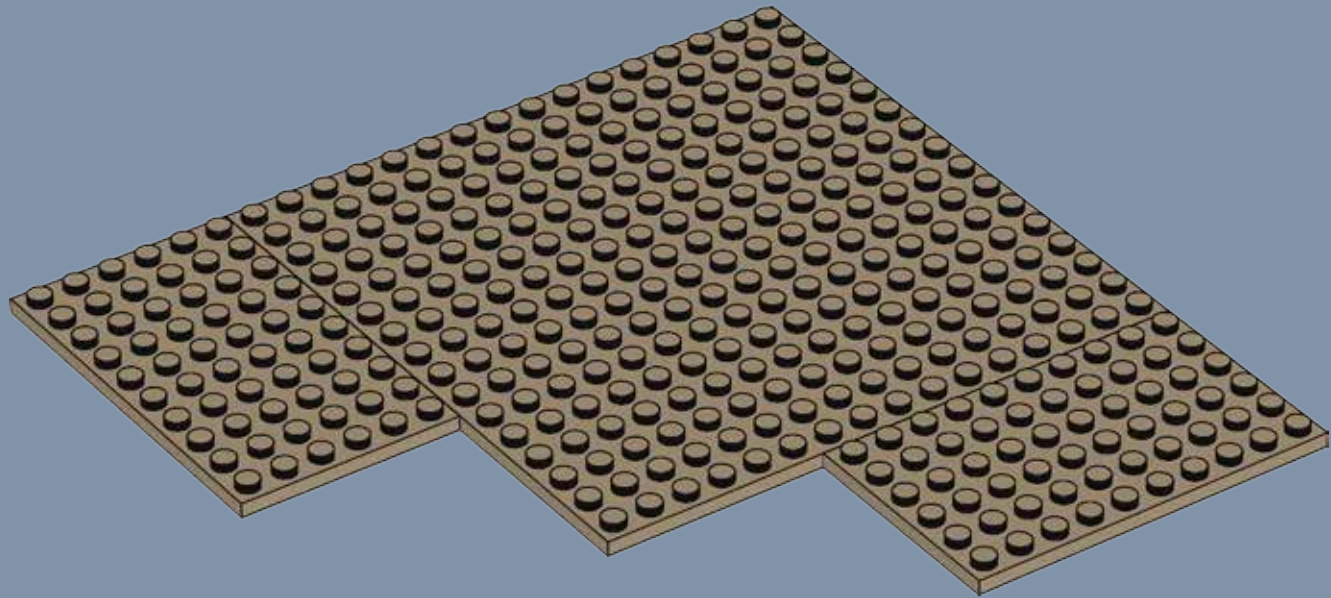

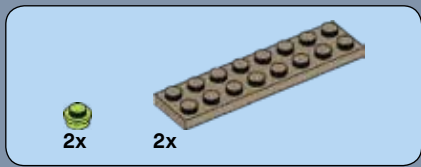

2

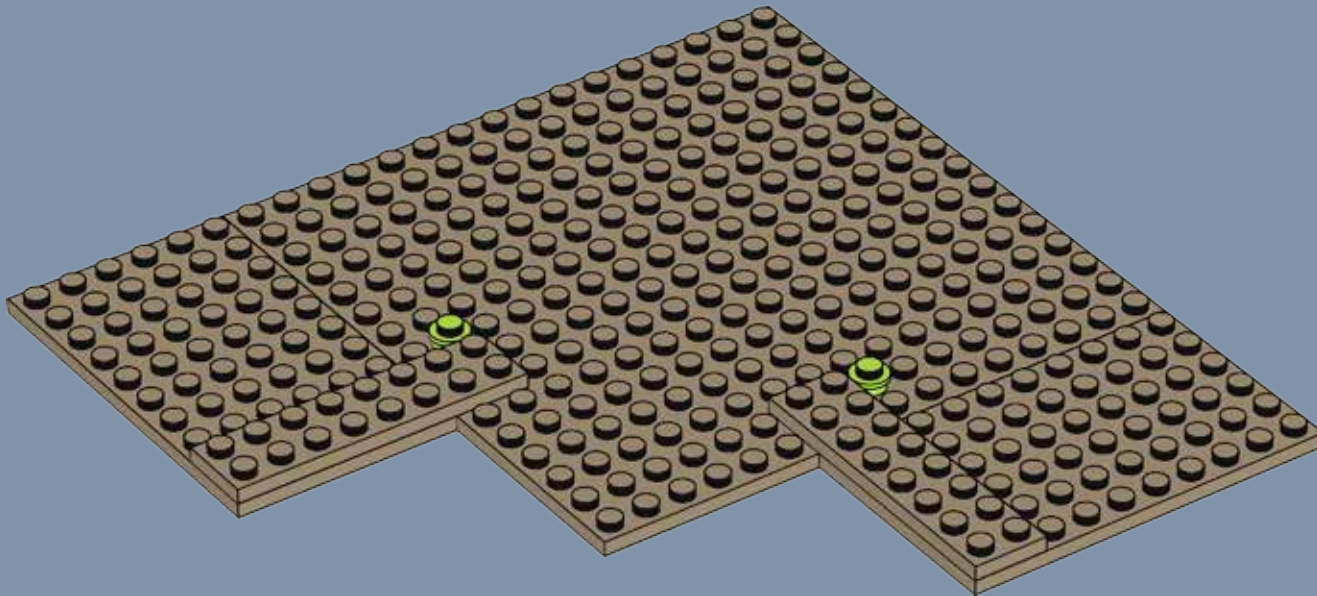

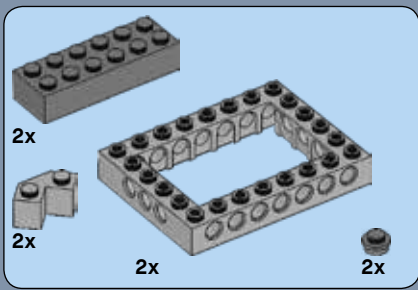

3

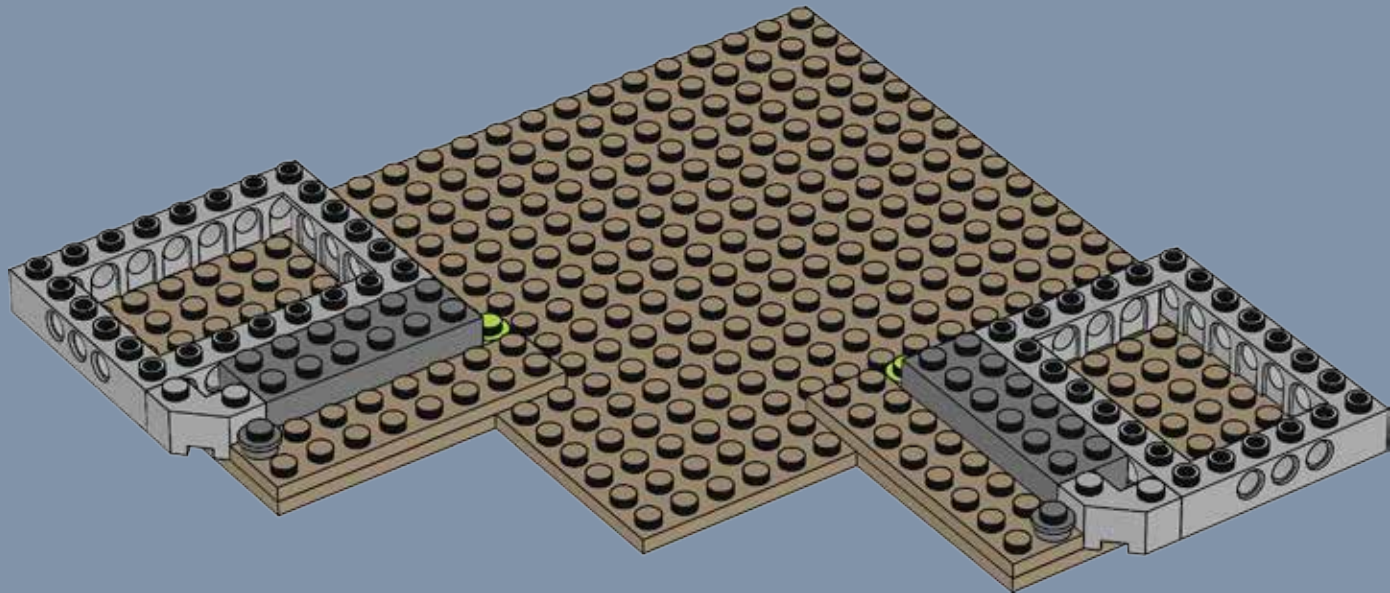



4

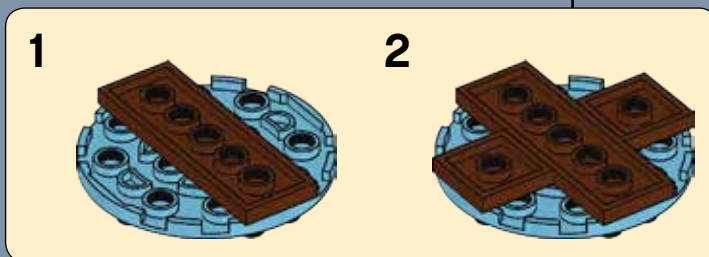
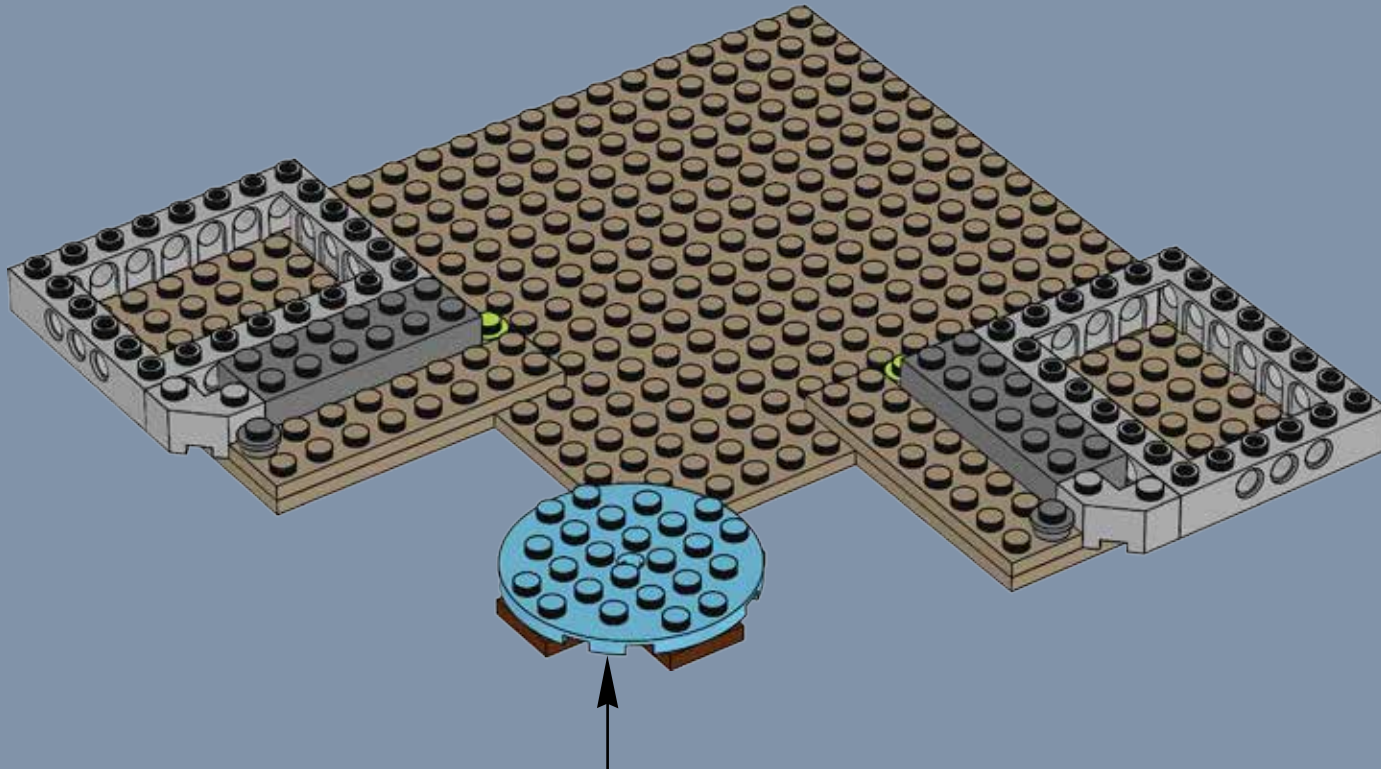

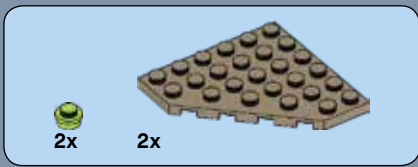

5

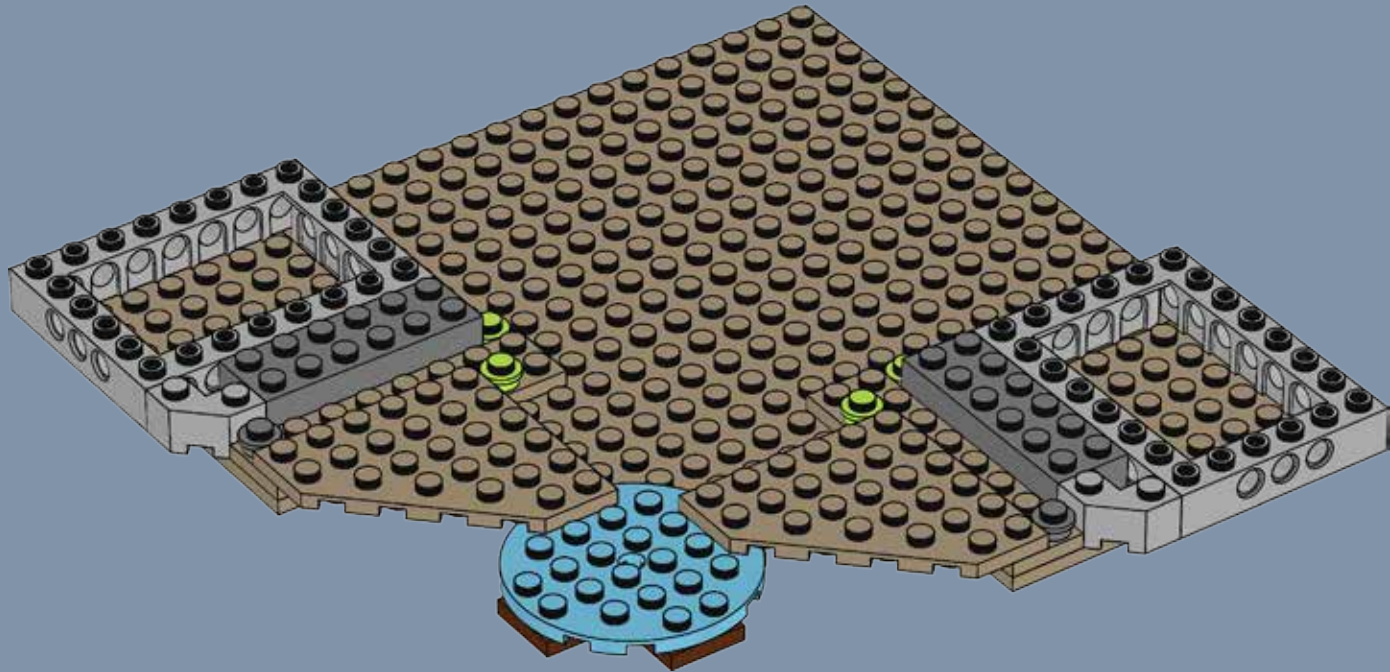

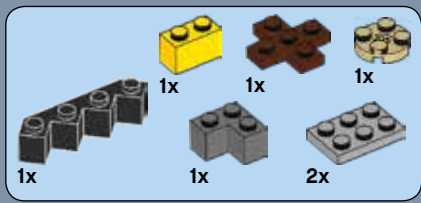

6



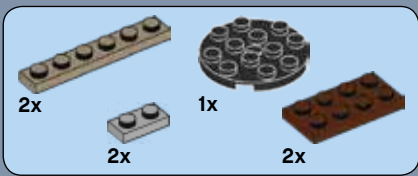

7

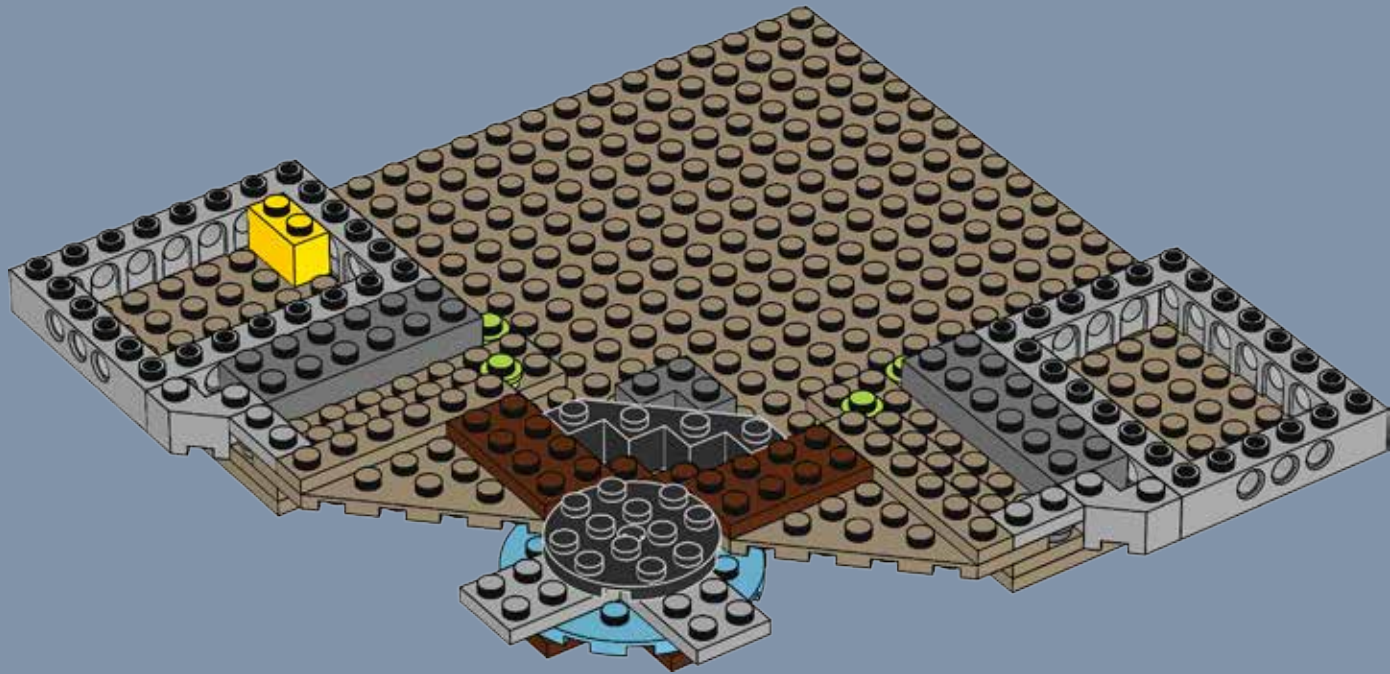



8

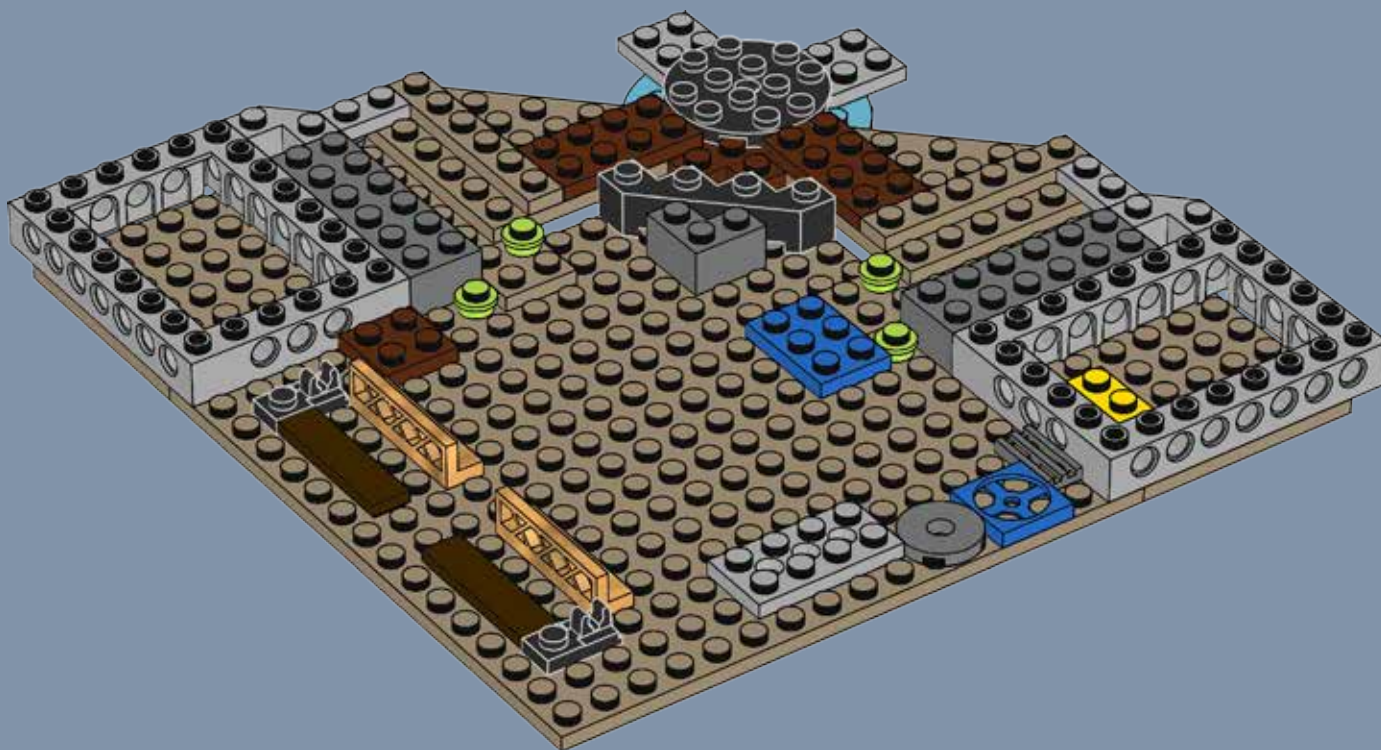
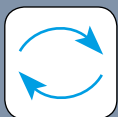



9



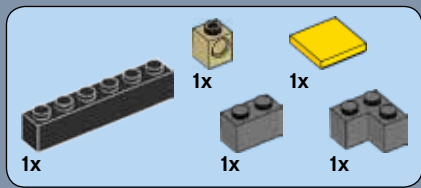

10





11

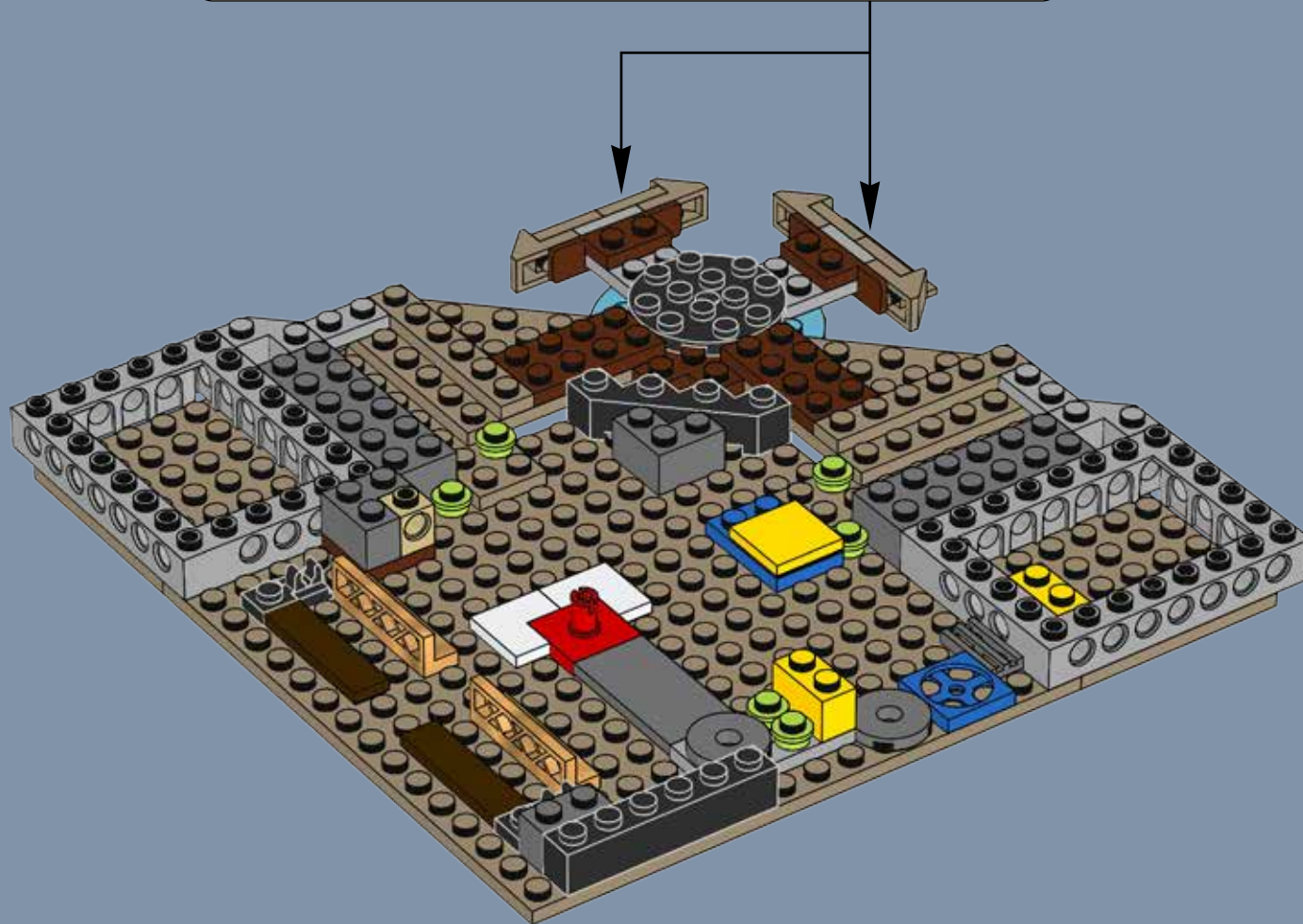
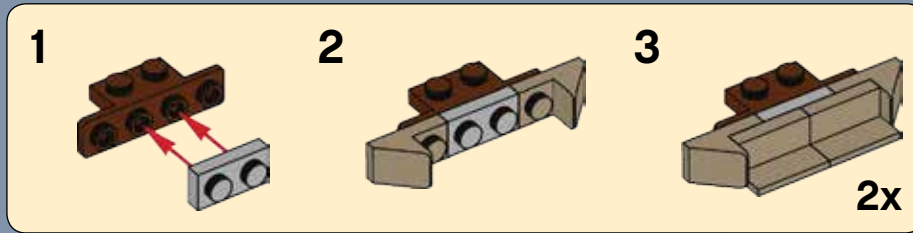

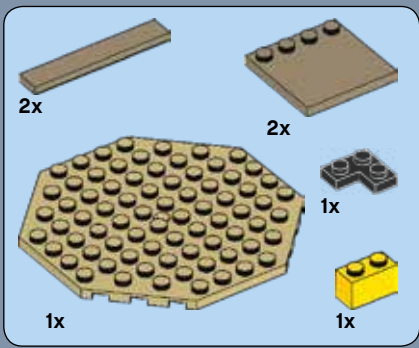

12



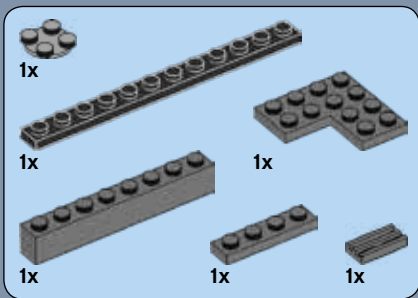

13

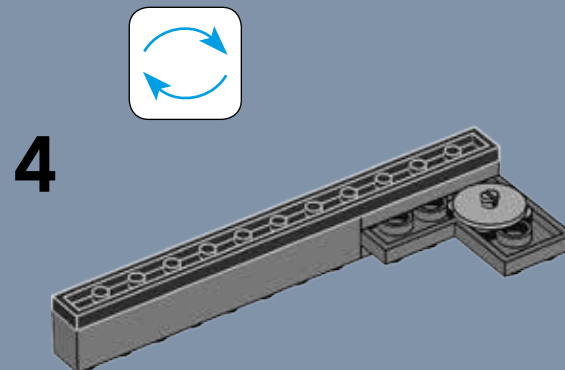
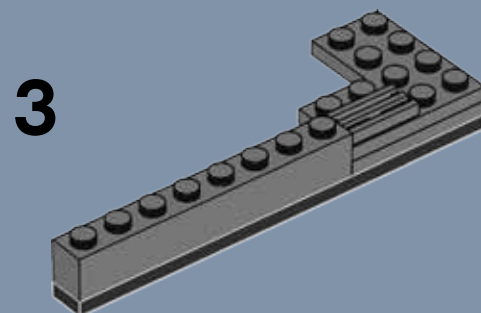
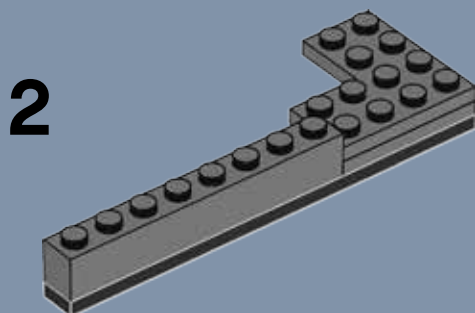
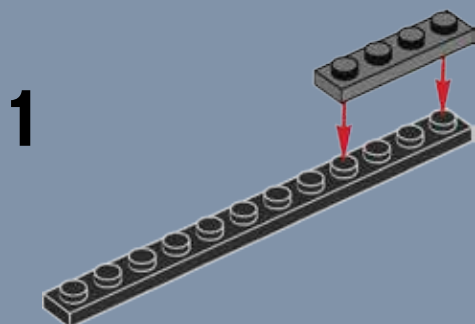

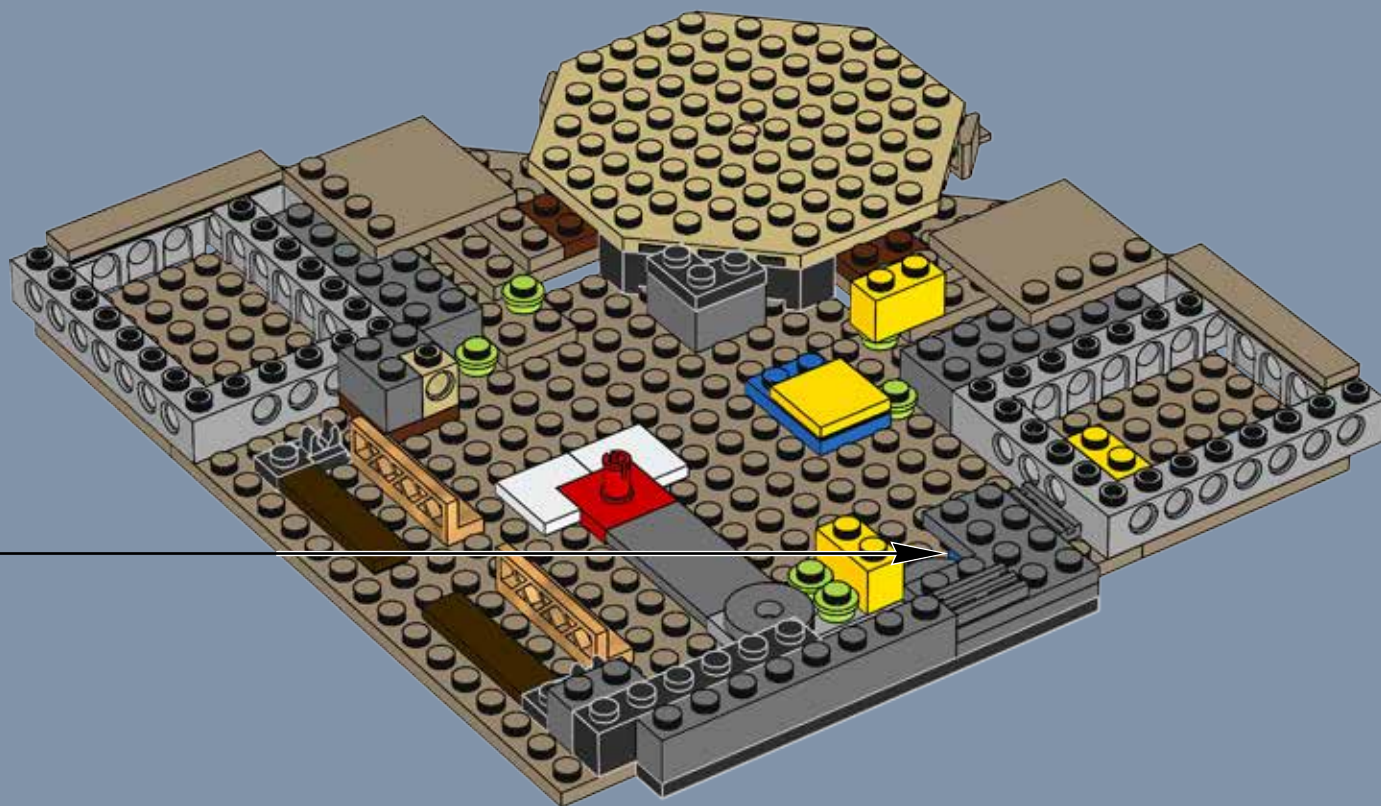

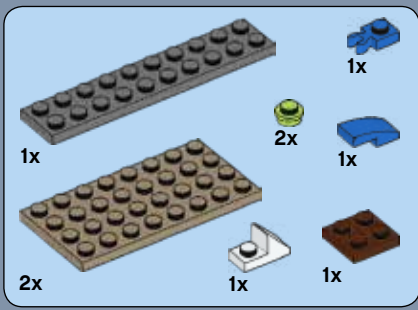

14

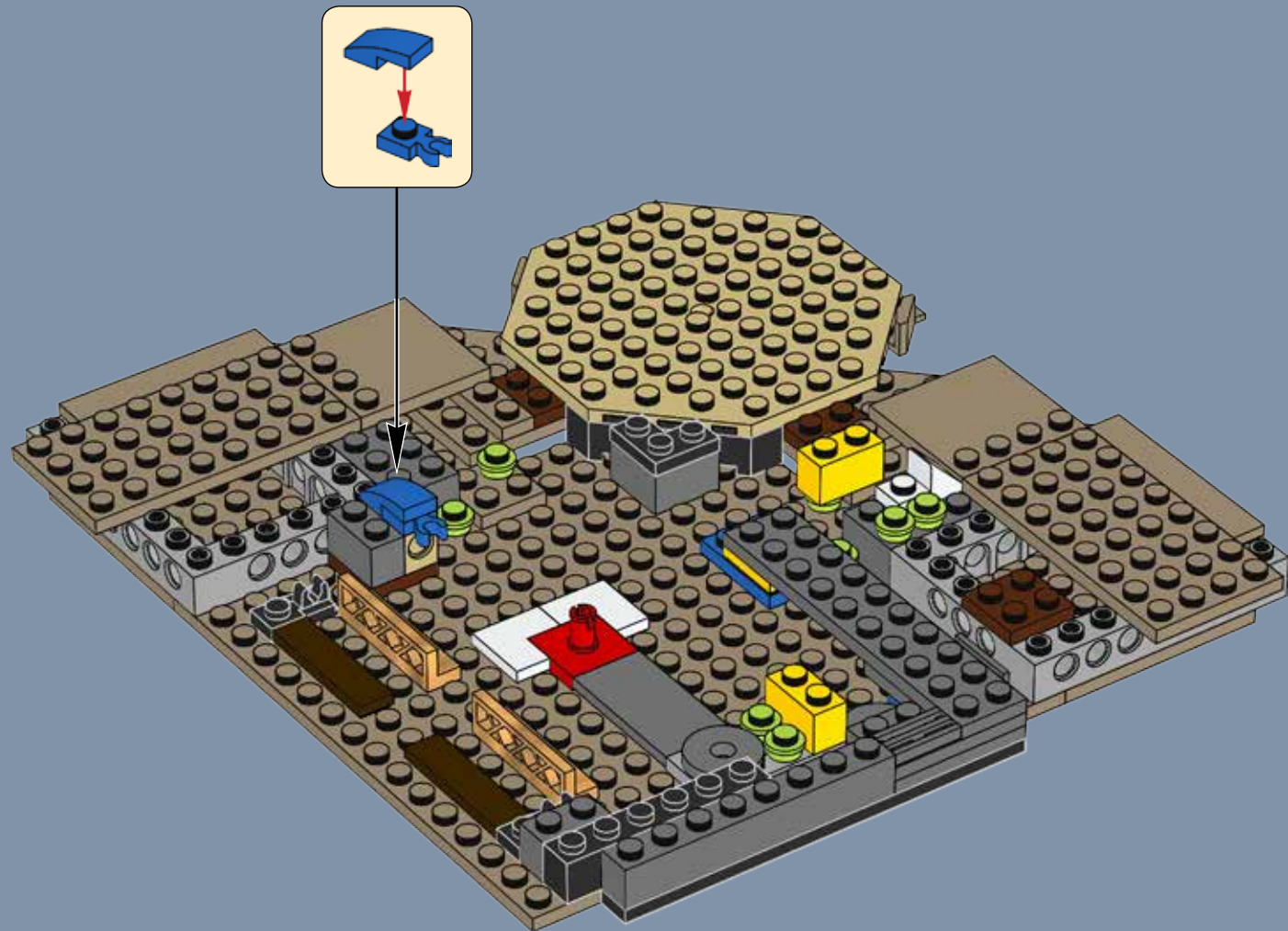

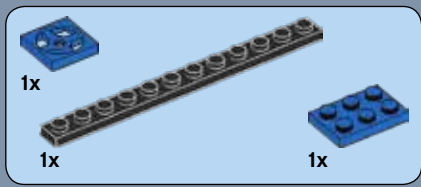

15



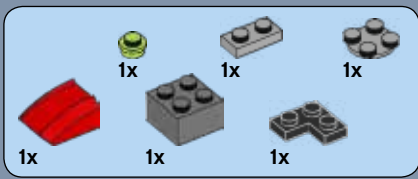

16

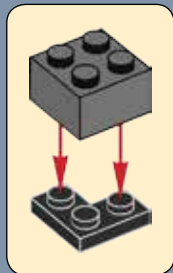
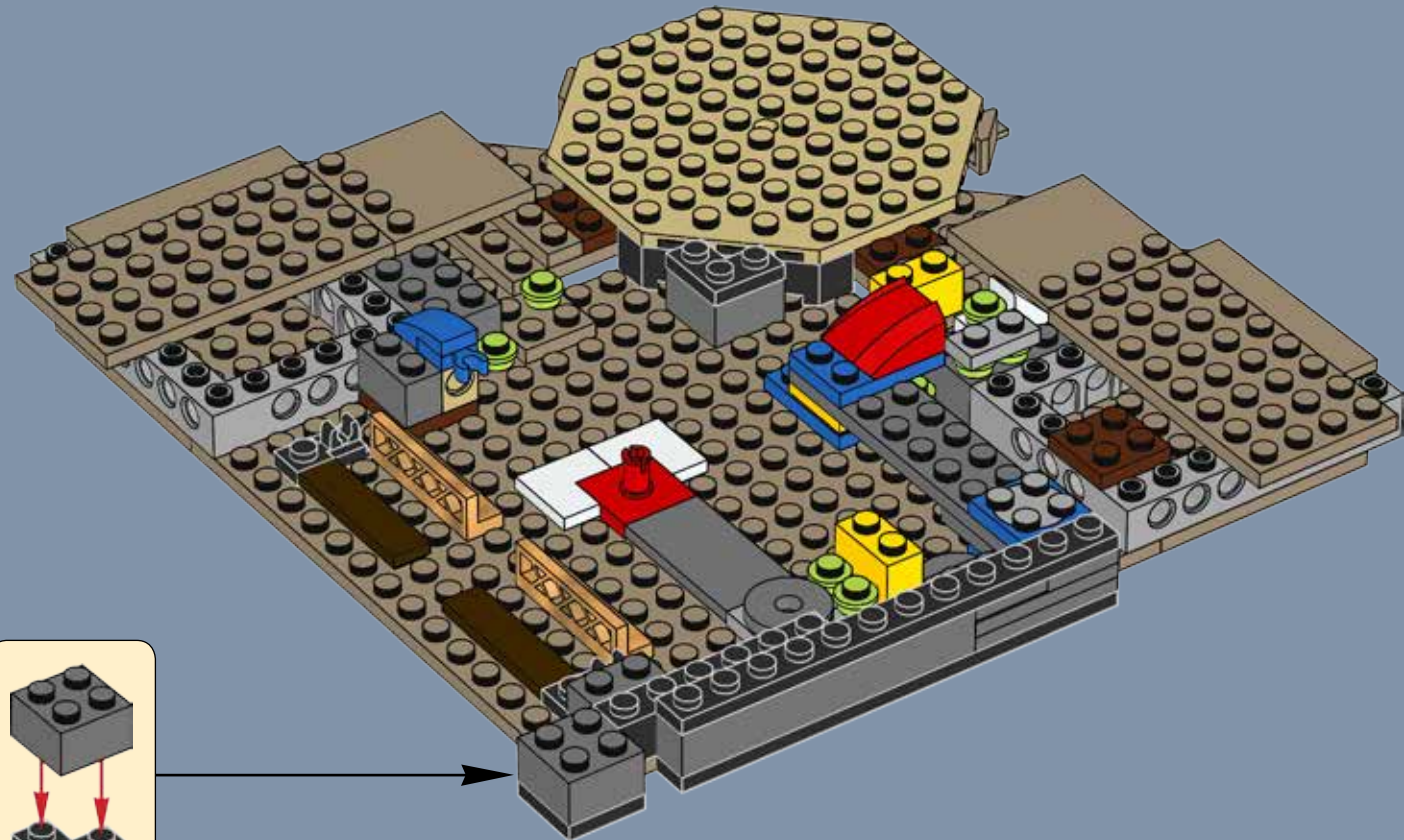

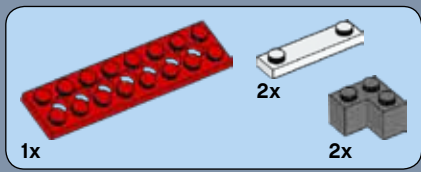

17

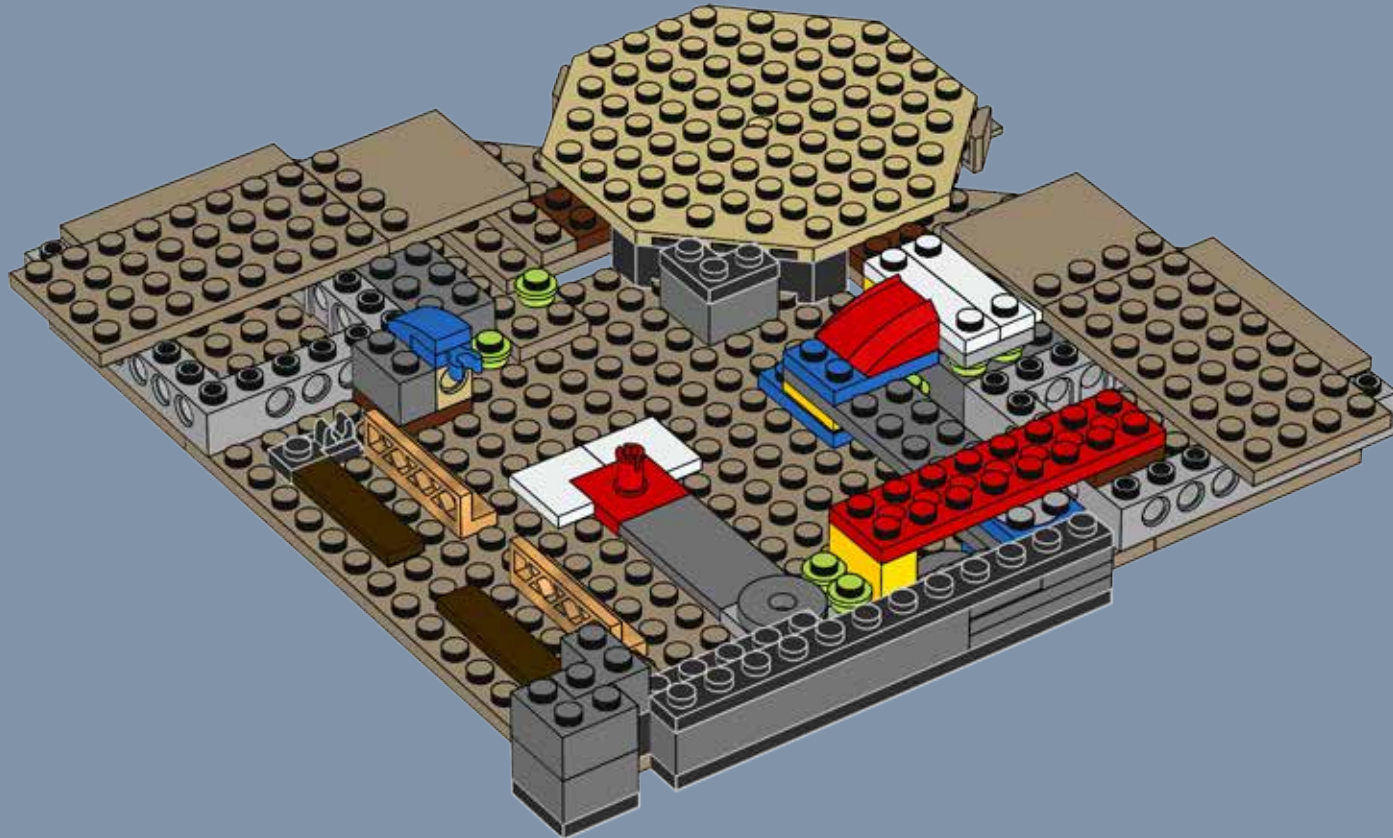



18

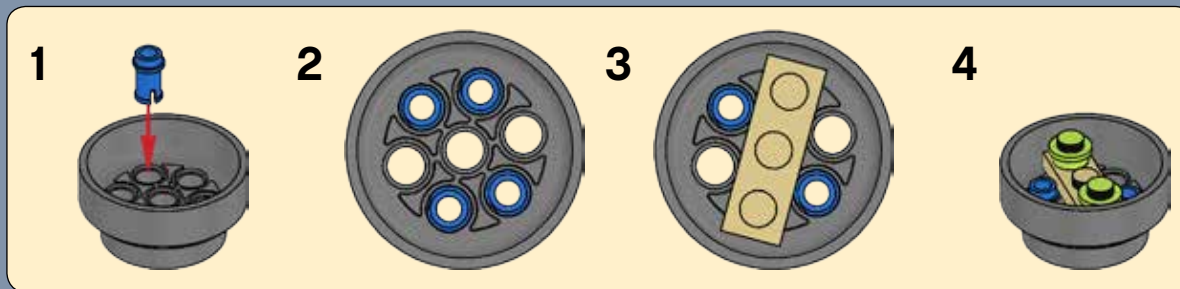

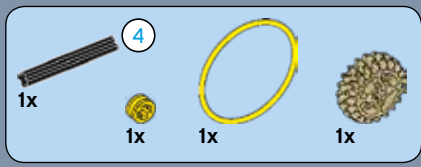

19

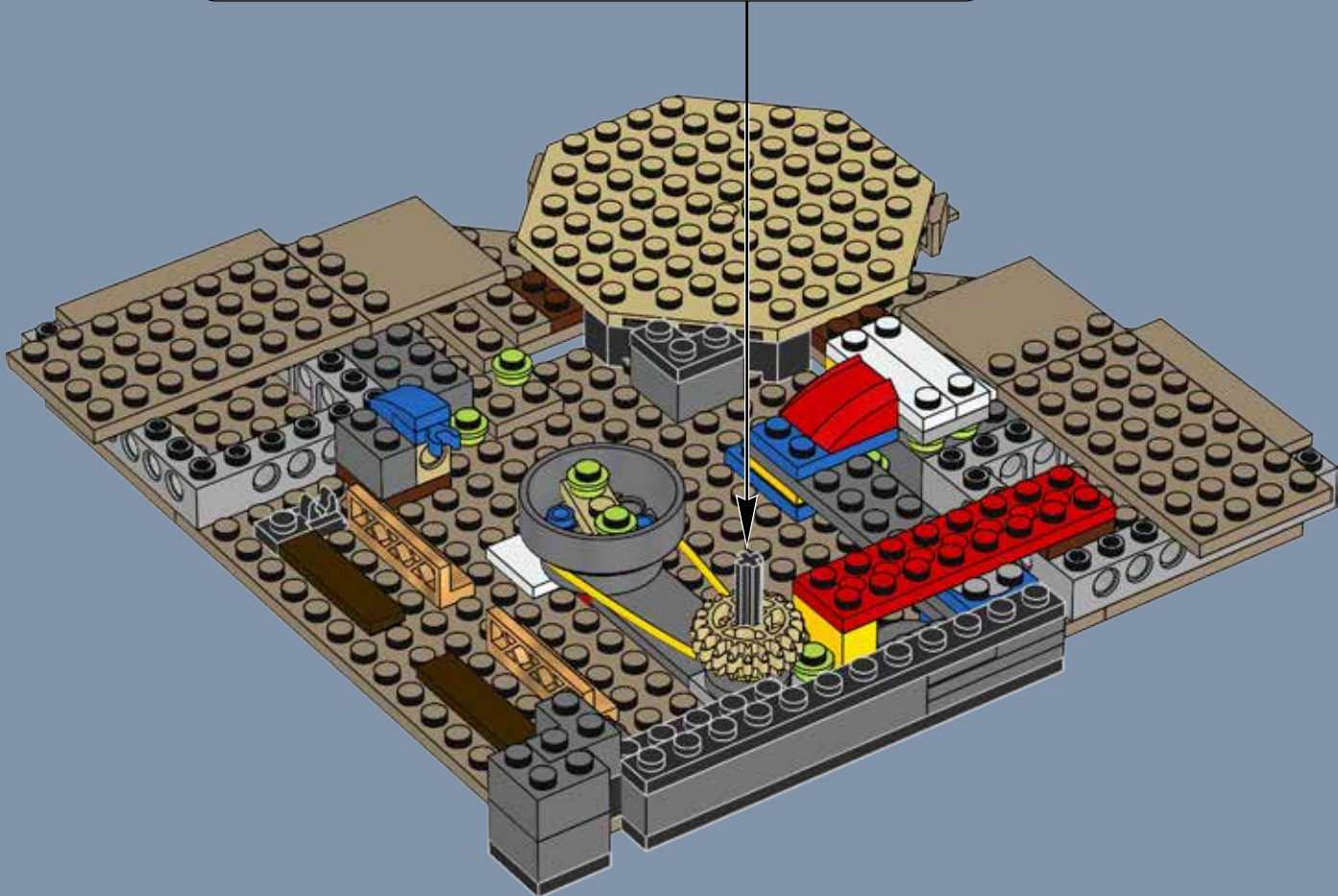
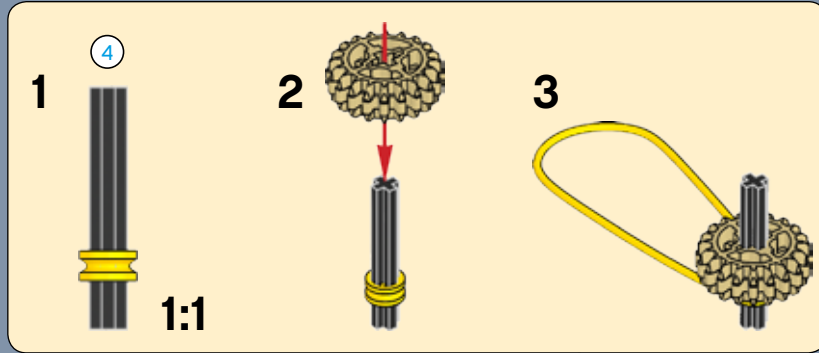

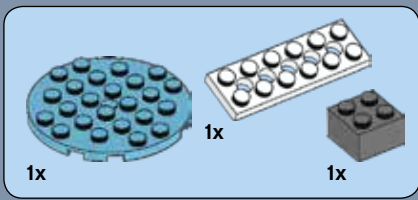

20

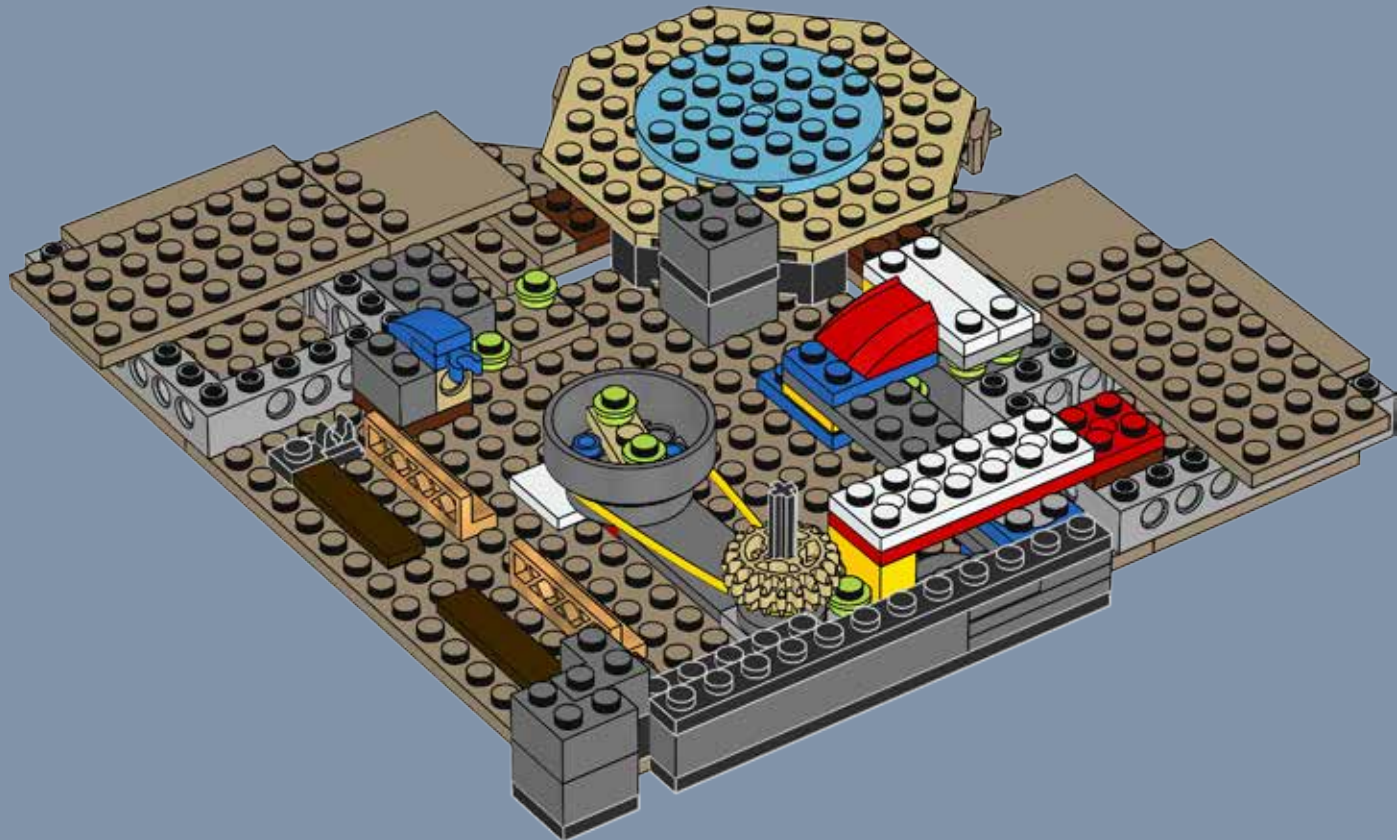

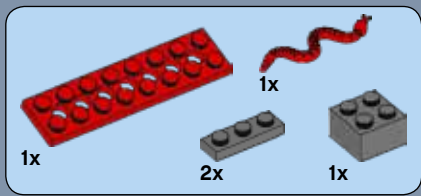

21

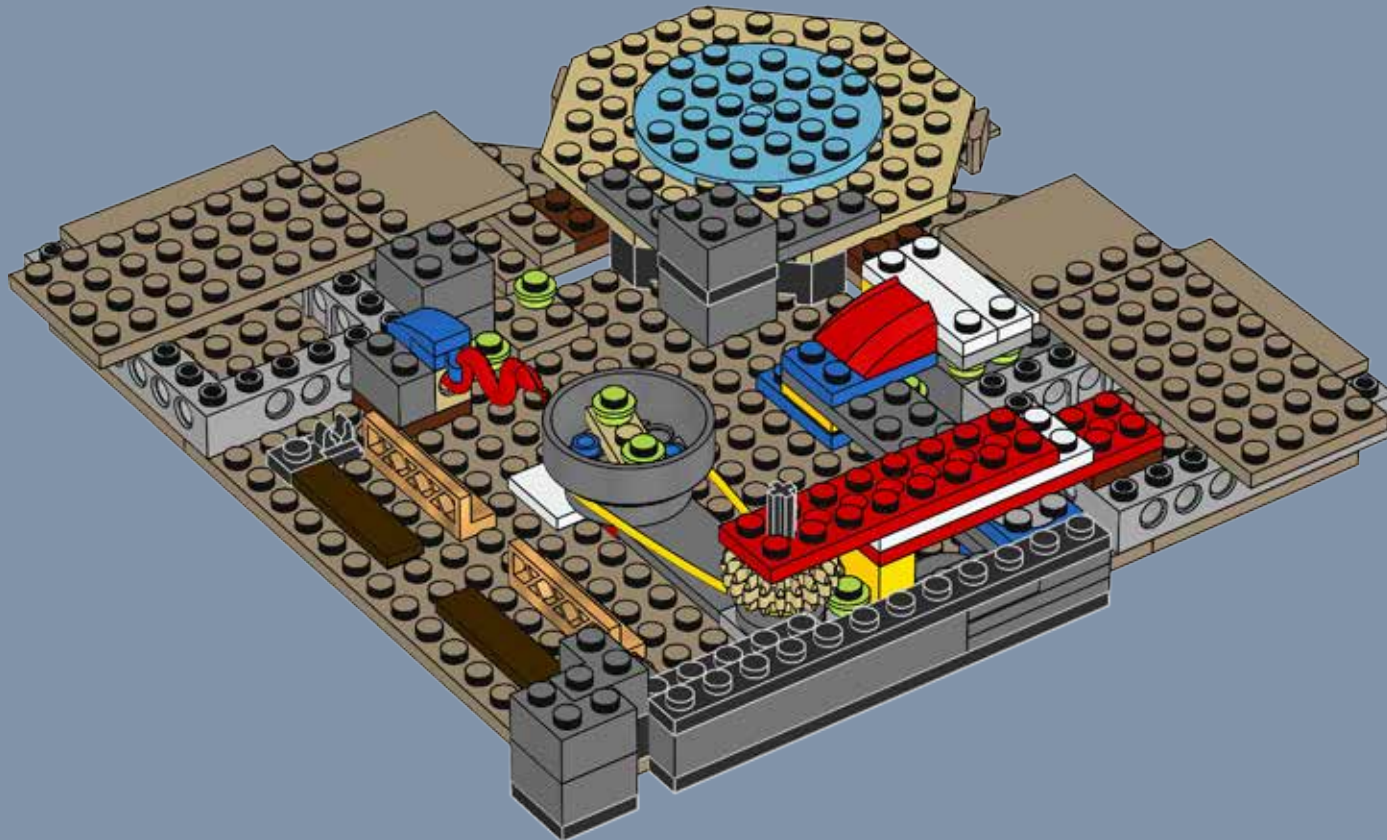

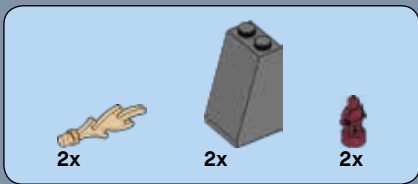

22

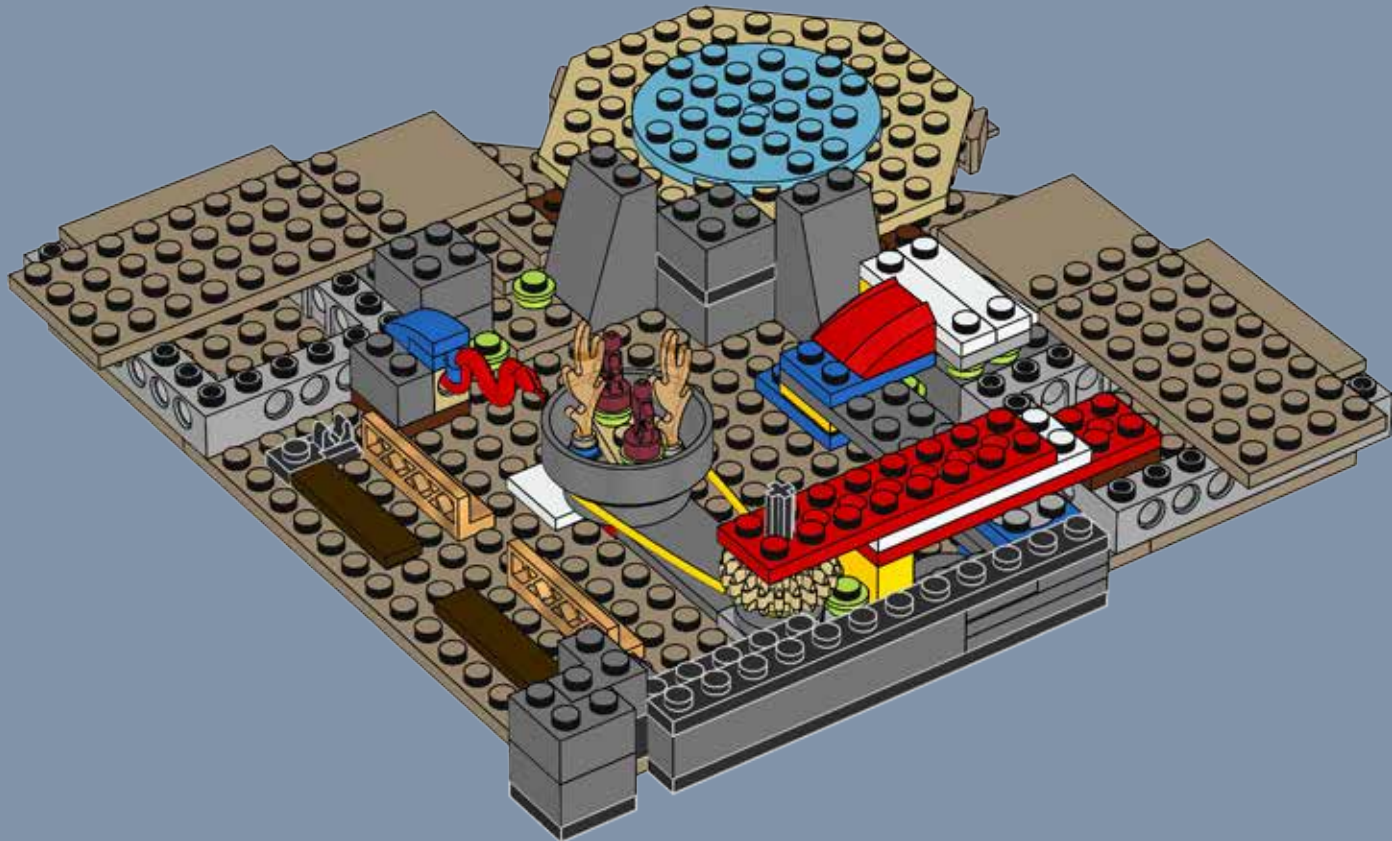

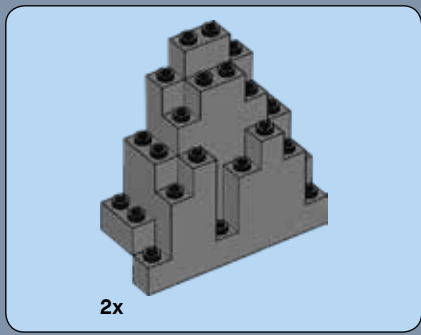

23

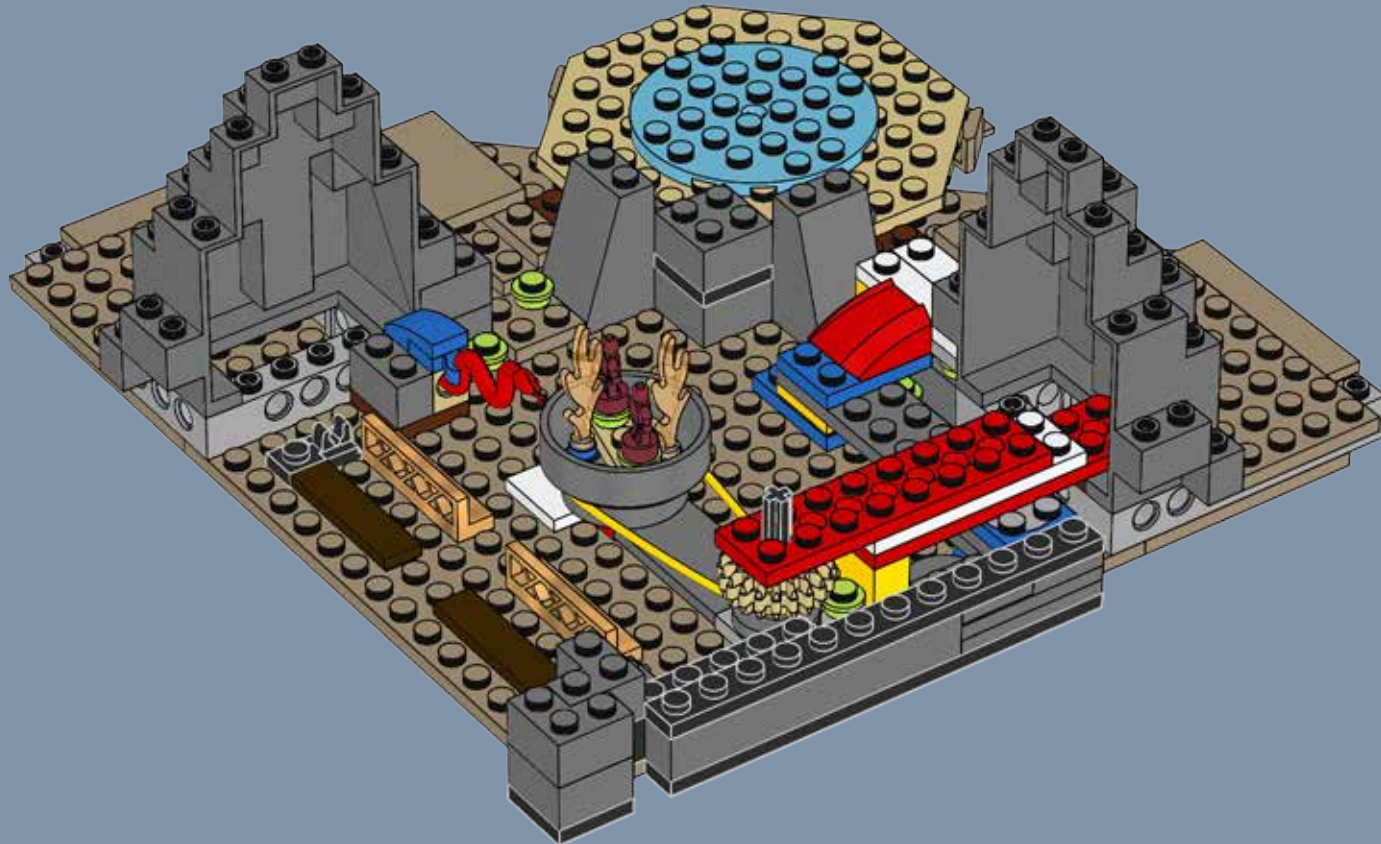



4x



1x

24

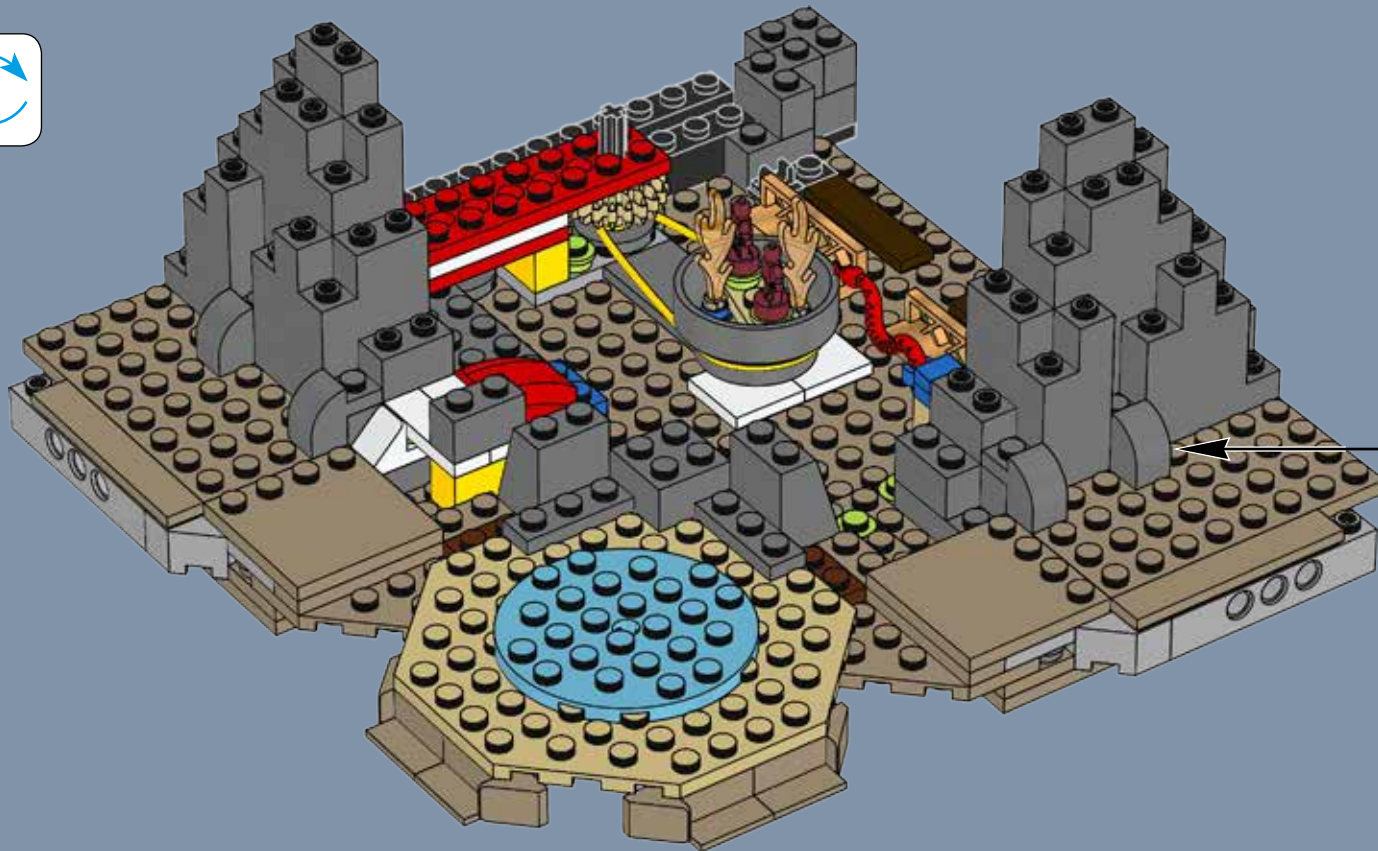



6x



2x

25



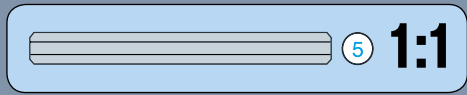
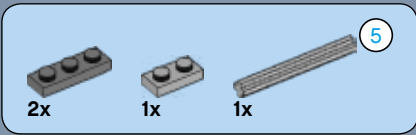

26



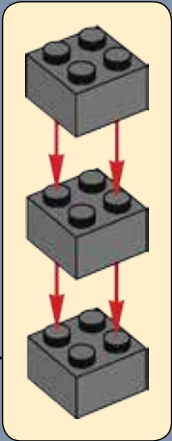
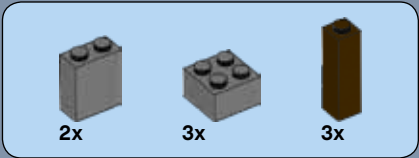
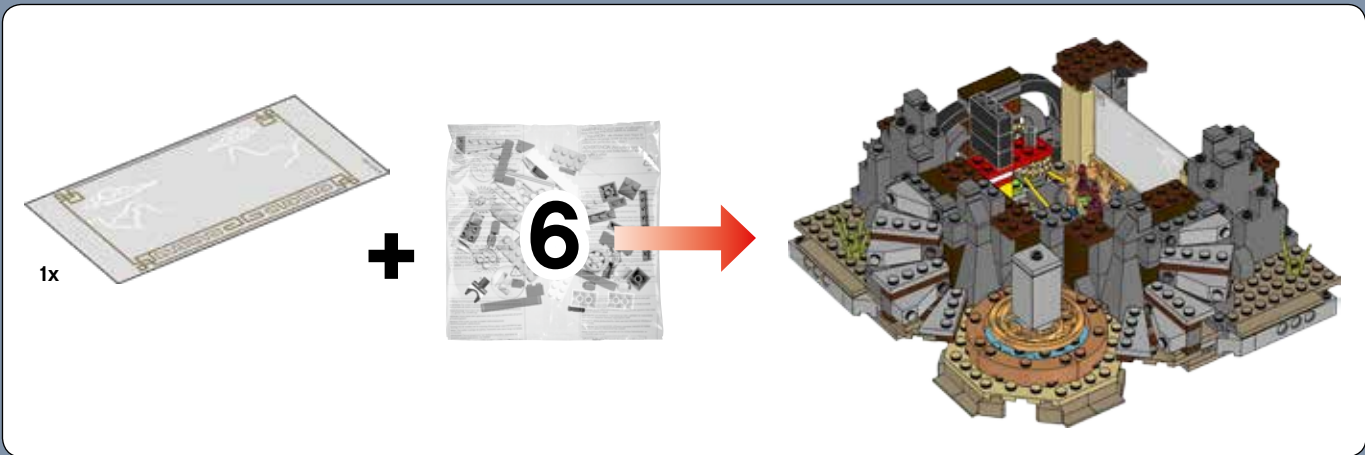

27

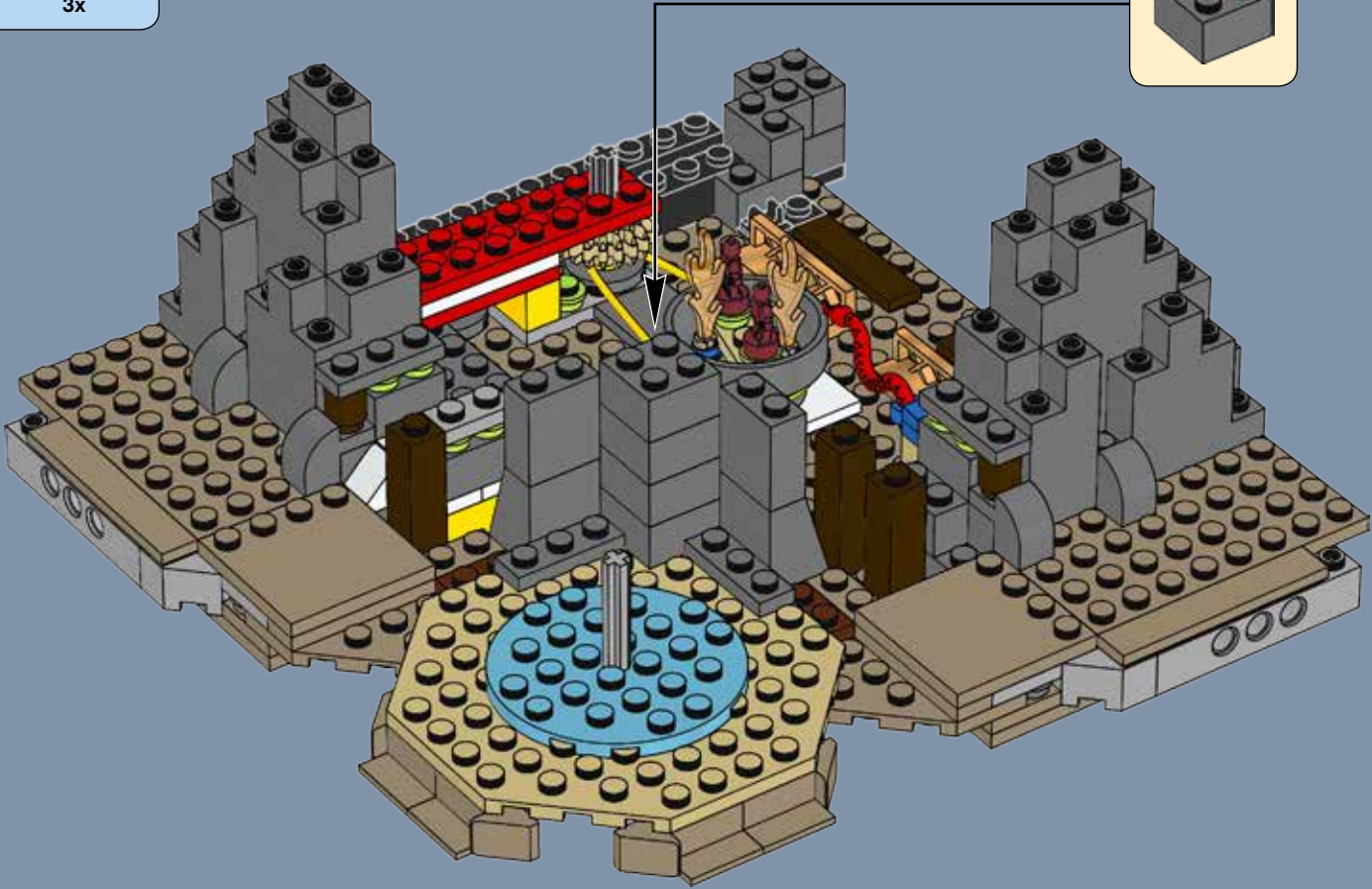



28

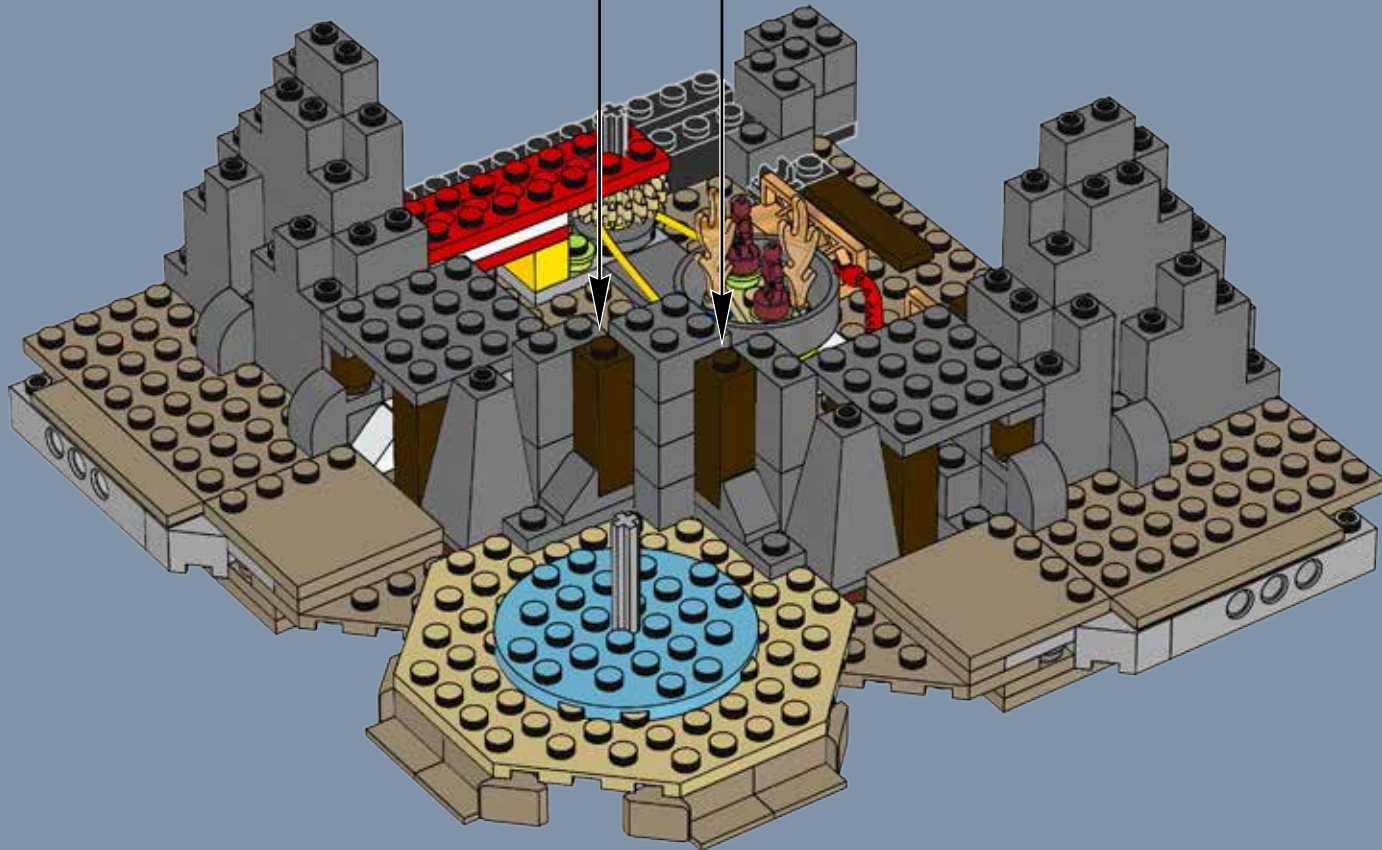
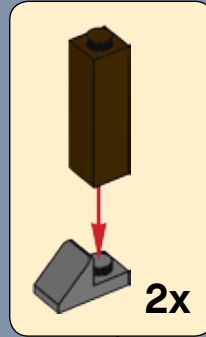

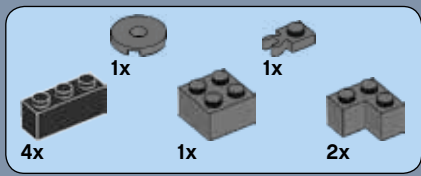

29

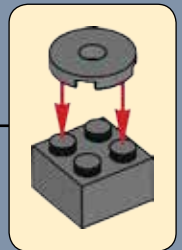
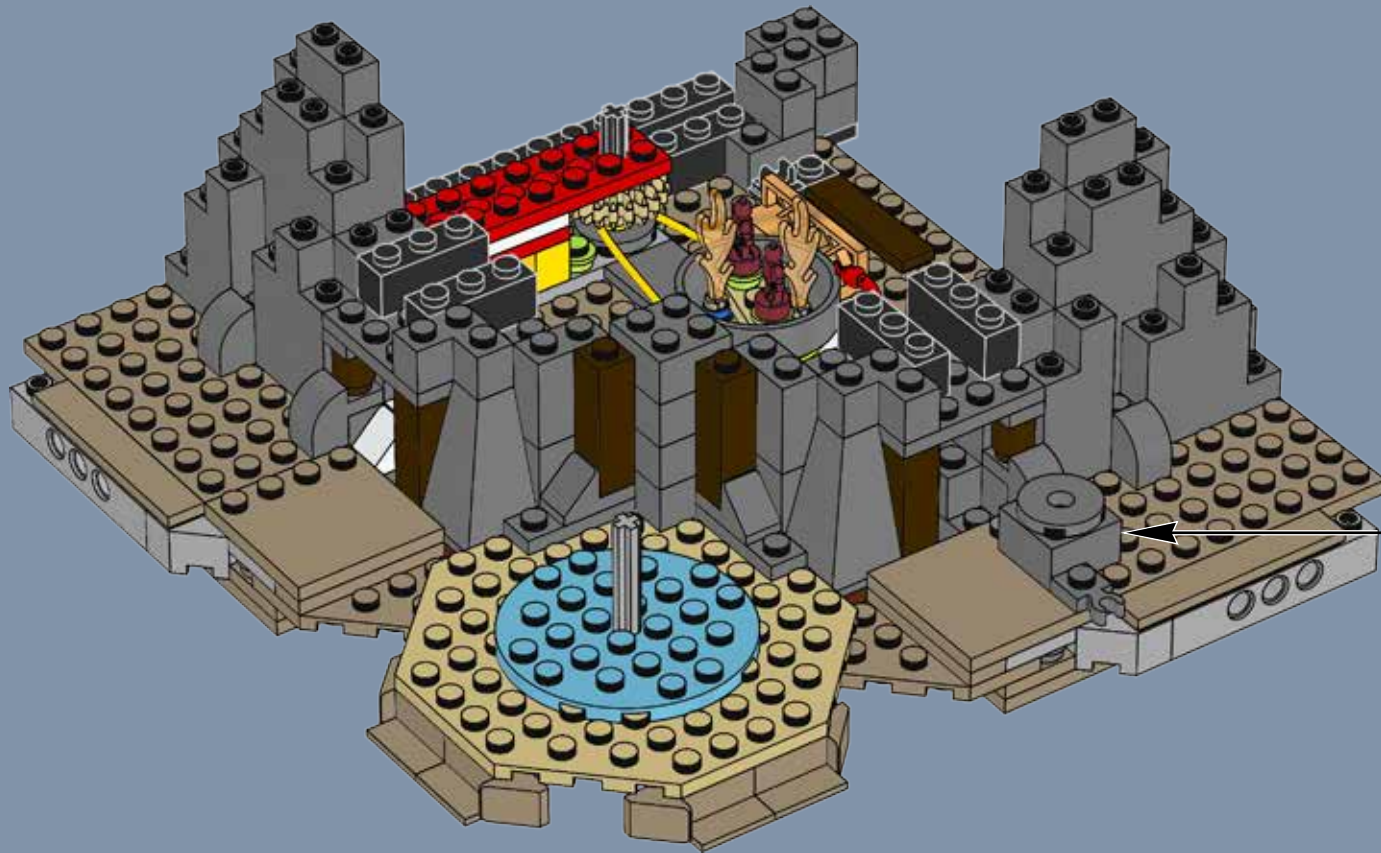

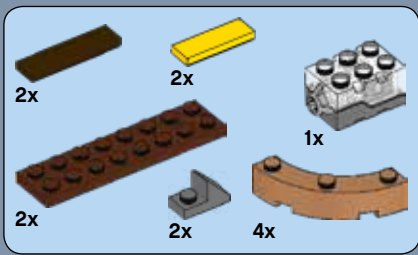

30

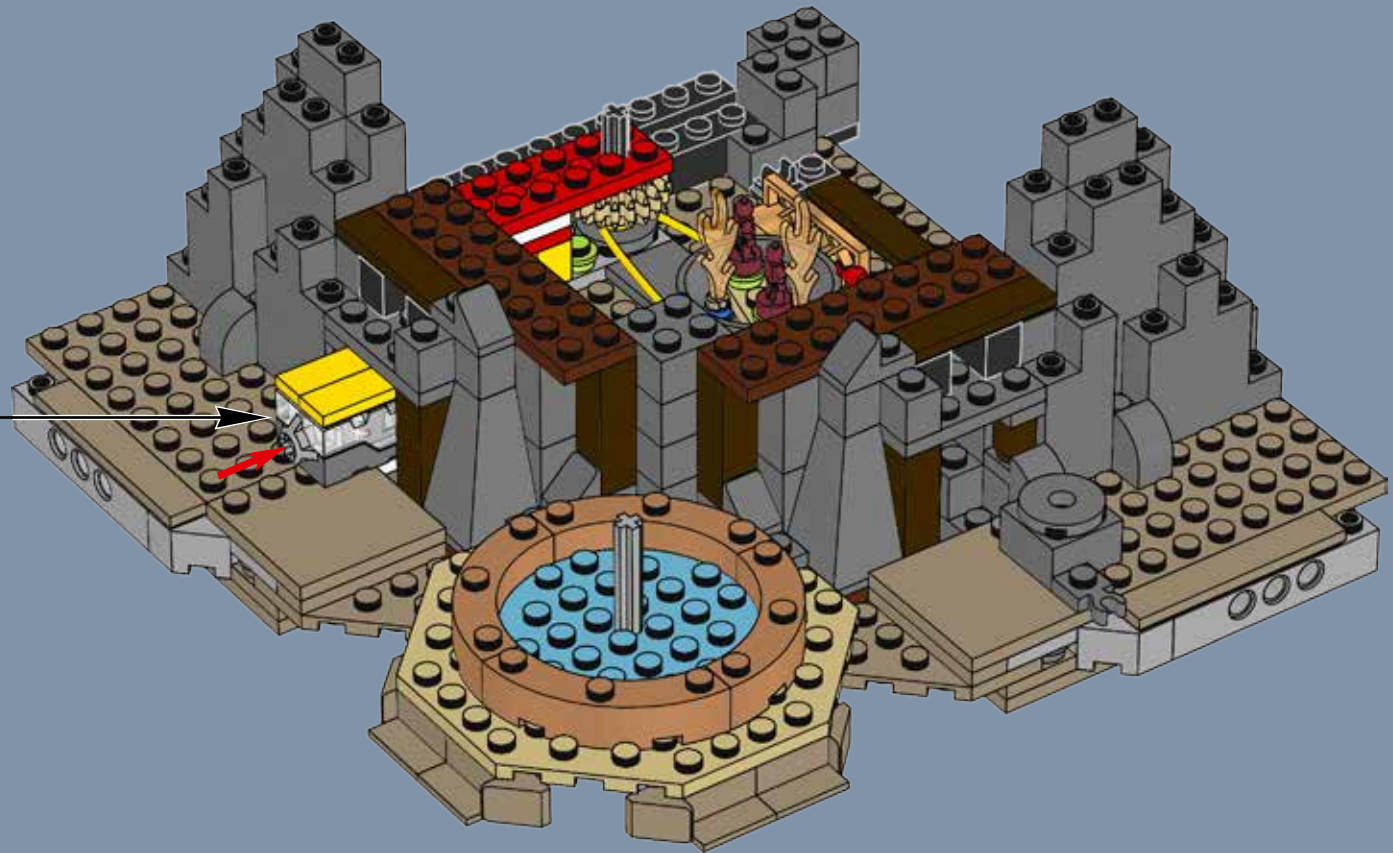

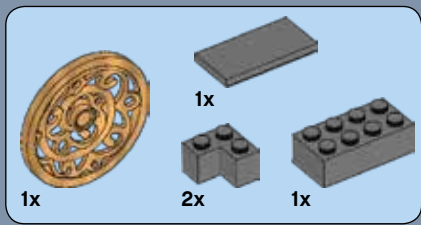

31

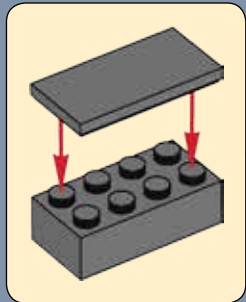
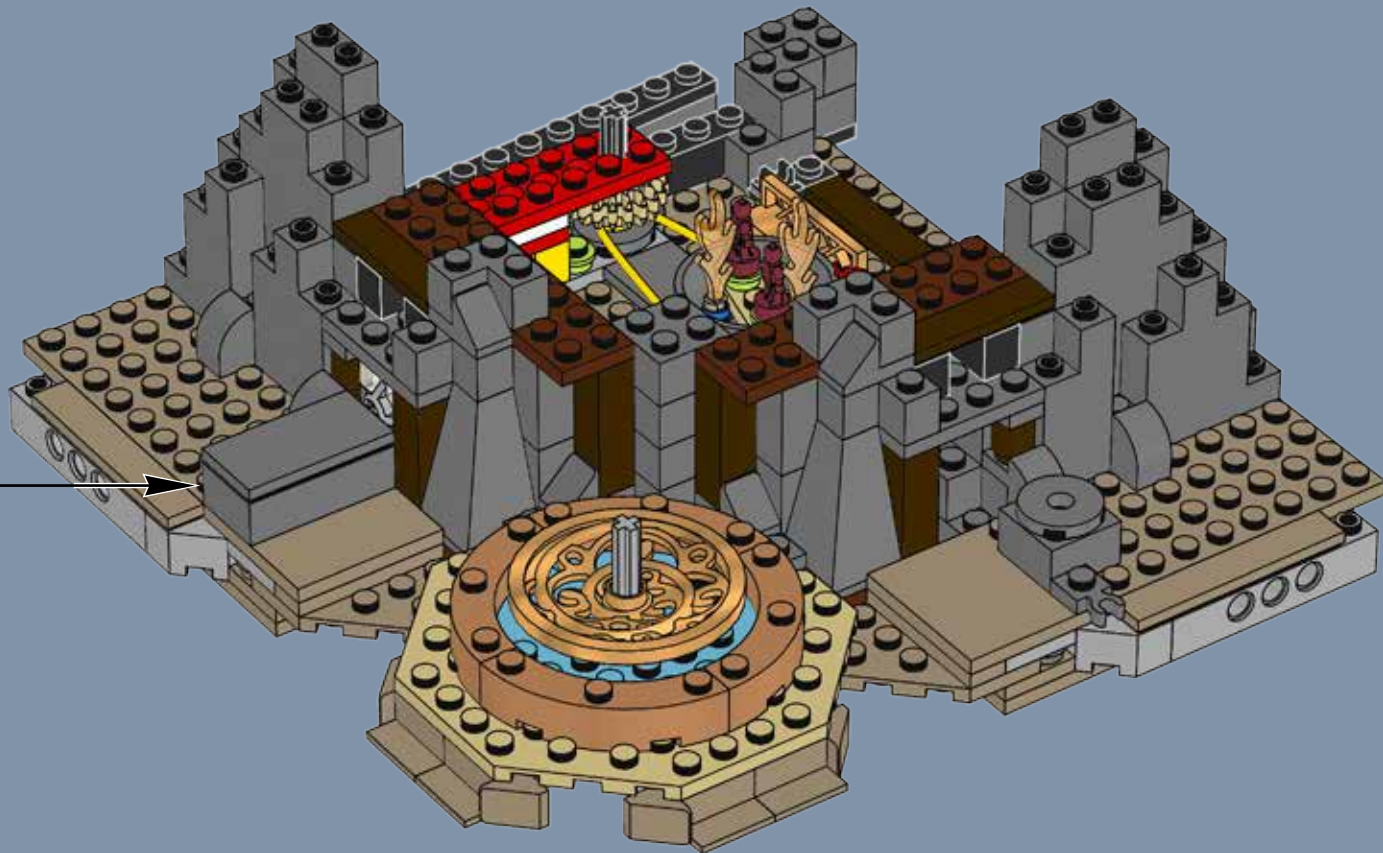

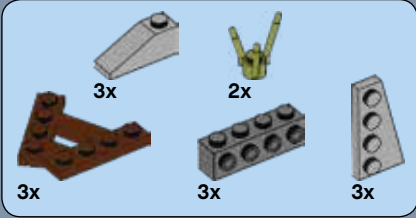

32

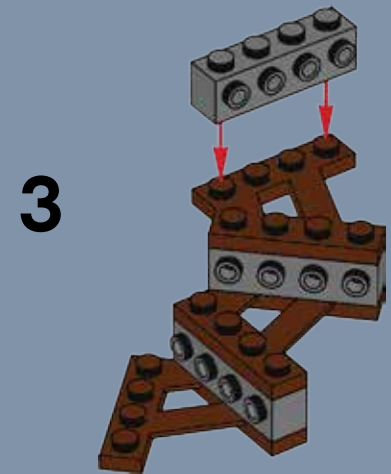
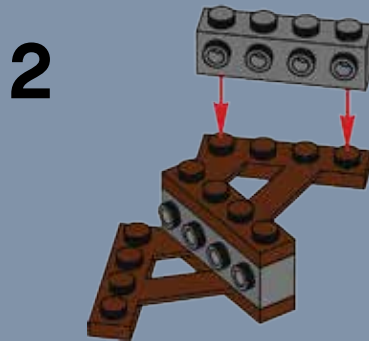
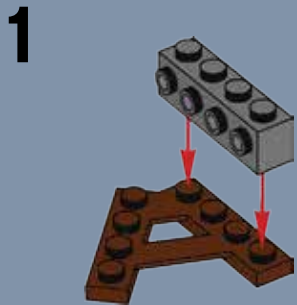

4

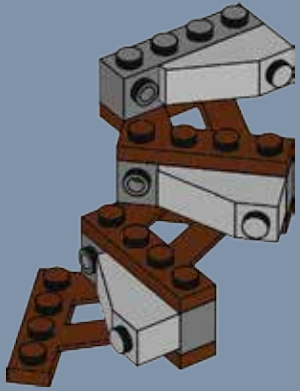

5

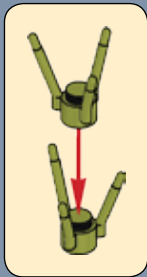
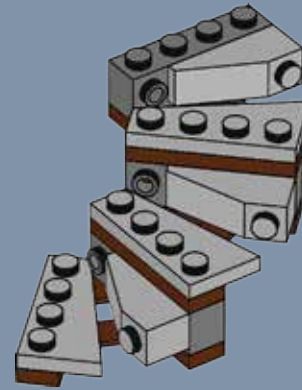

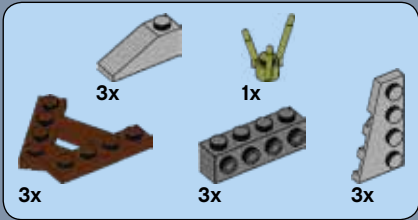

33

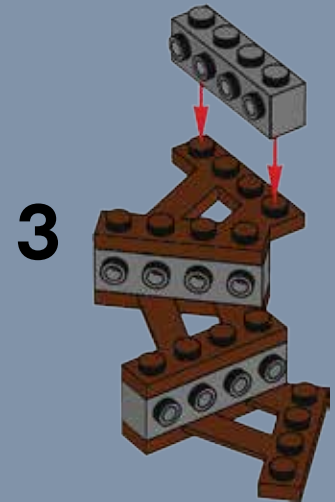
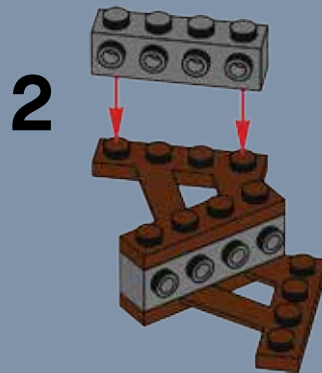
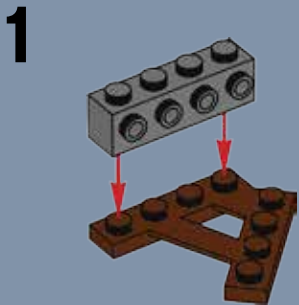

4

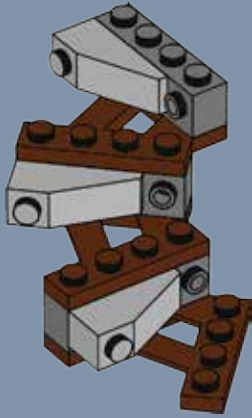

5

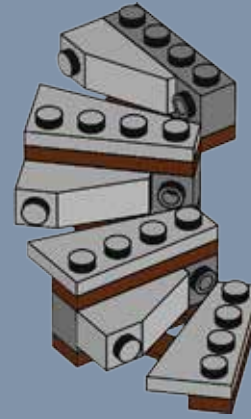

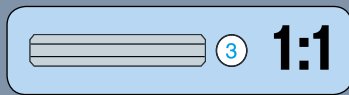

34

1

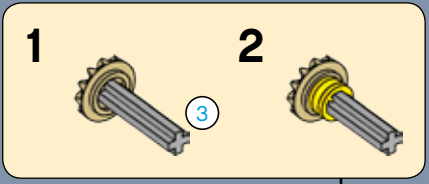
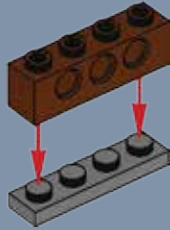

2

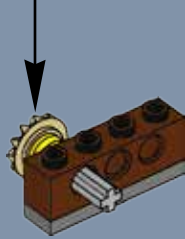

3



4



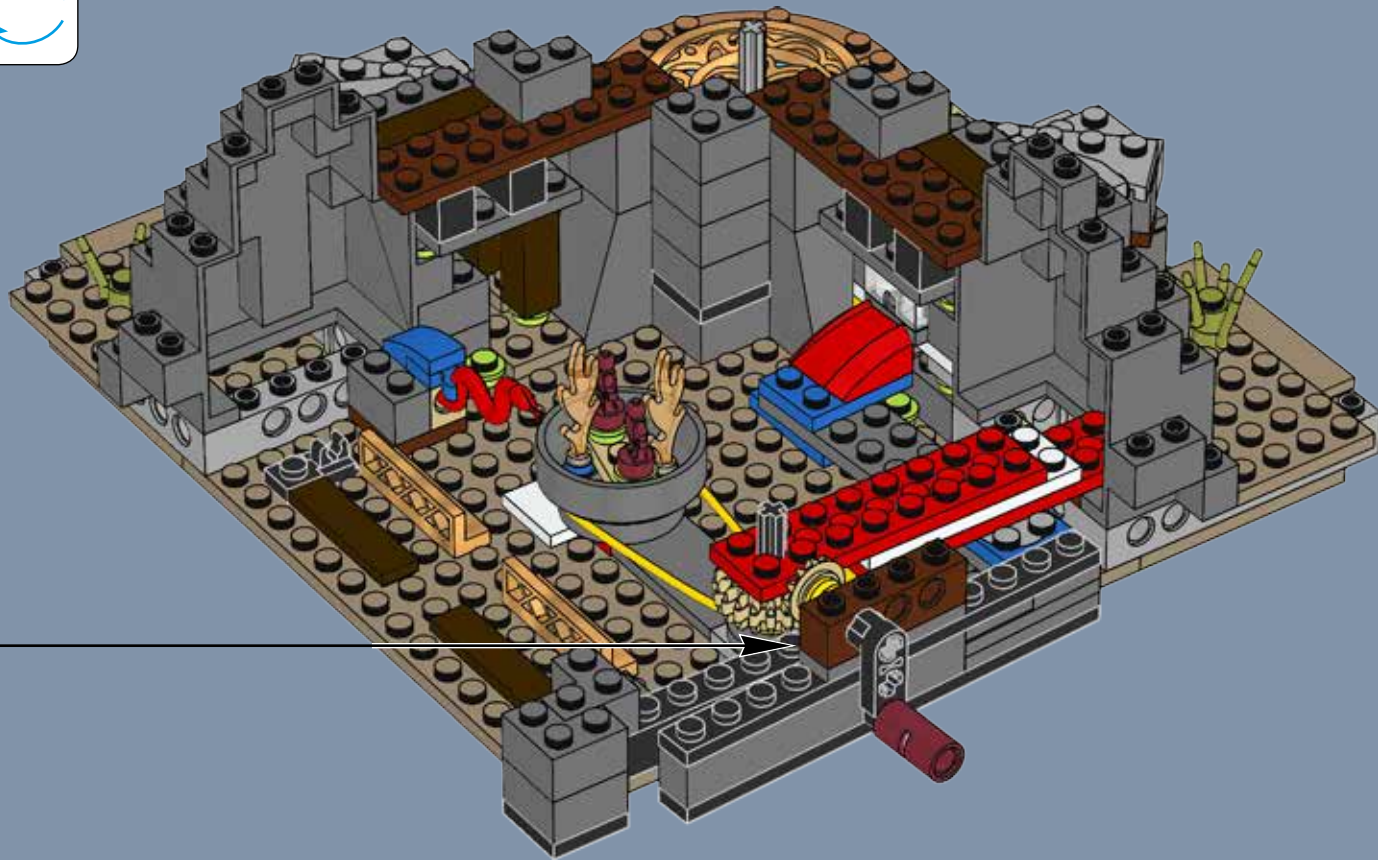

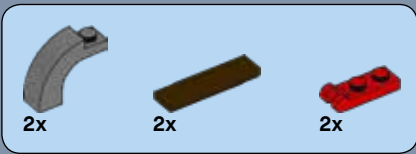

35

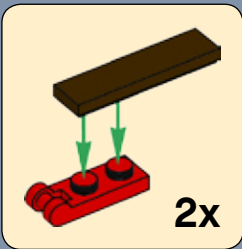
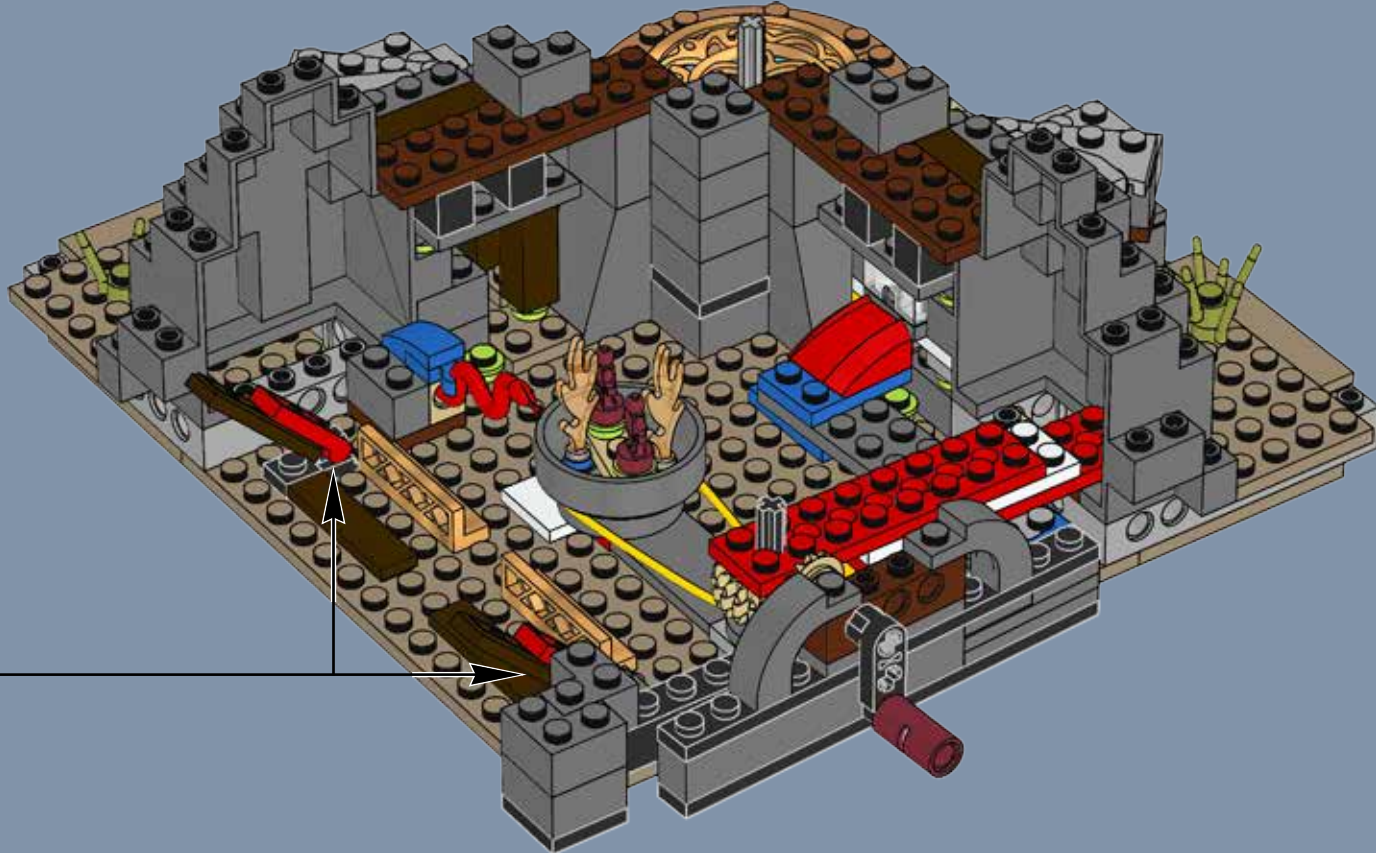

36

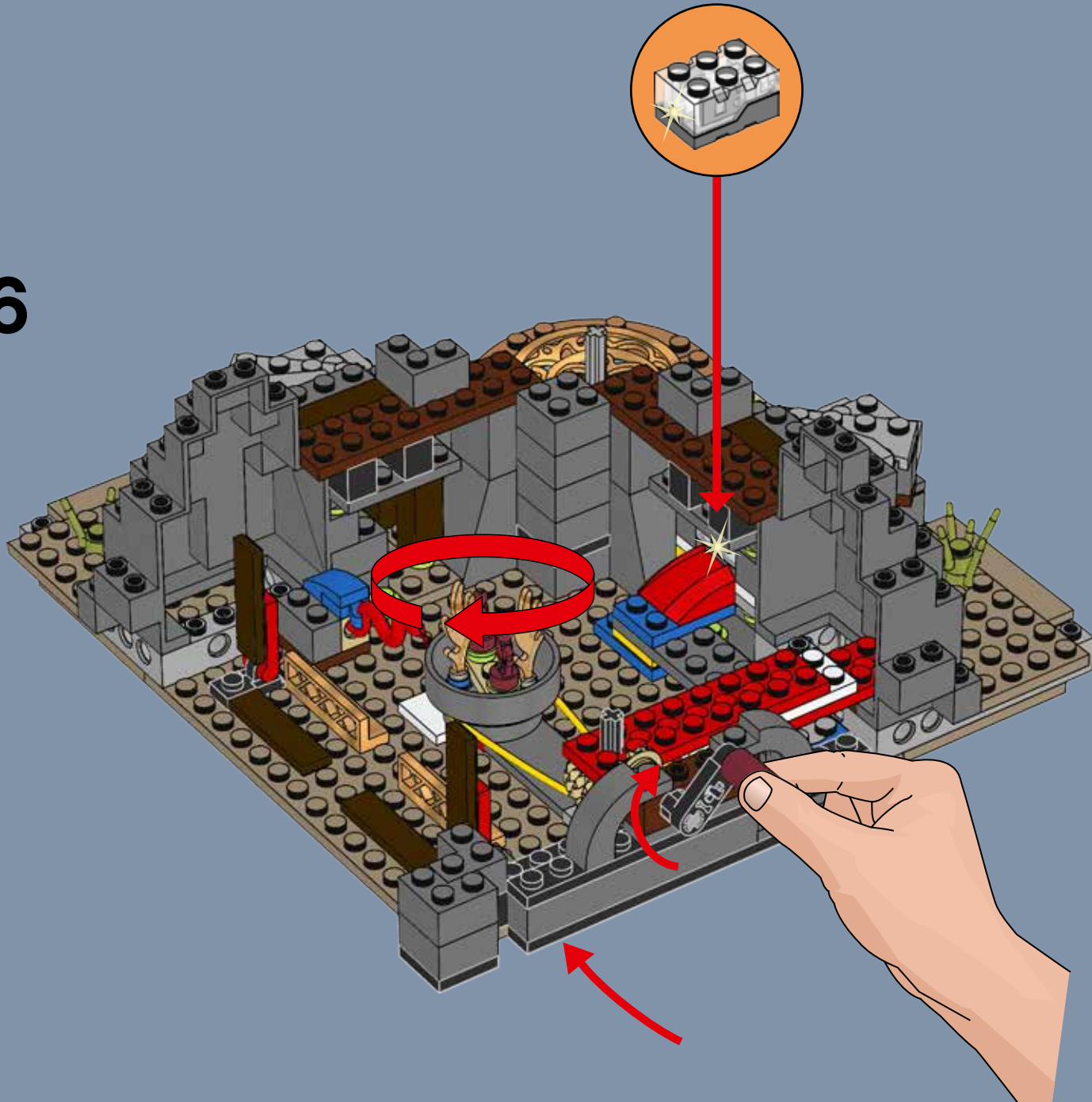

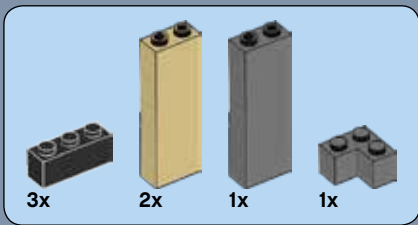

37

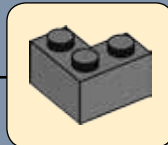
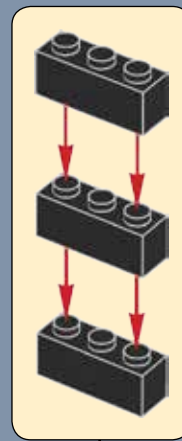

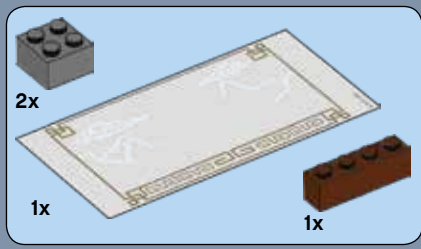

38



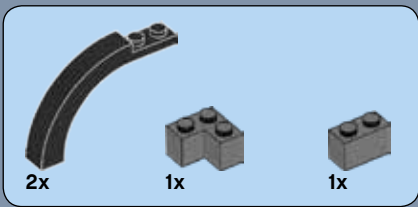

39

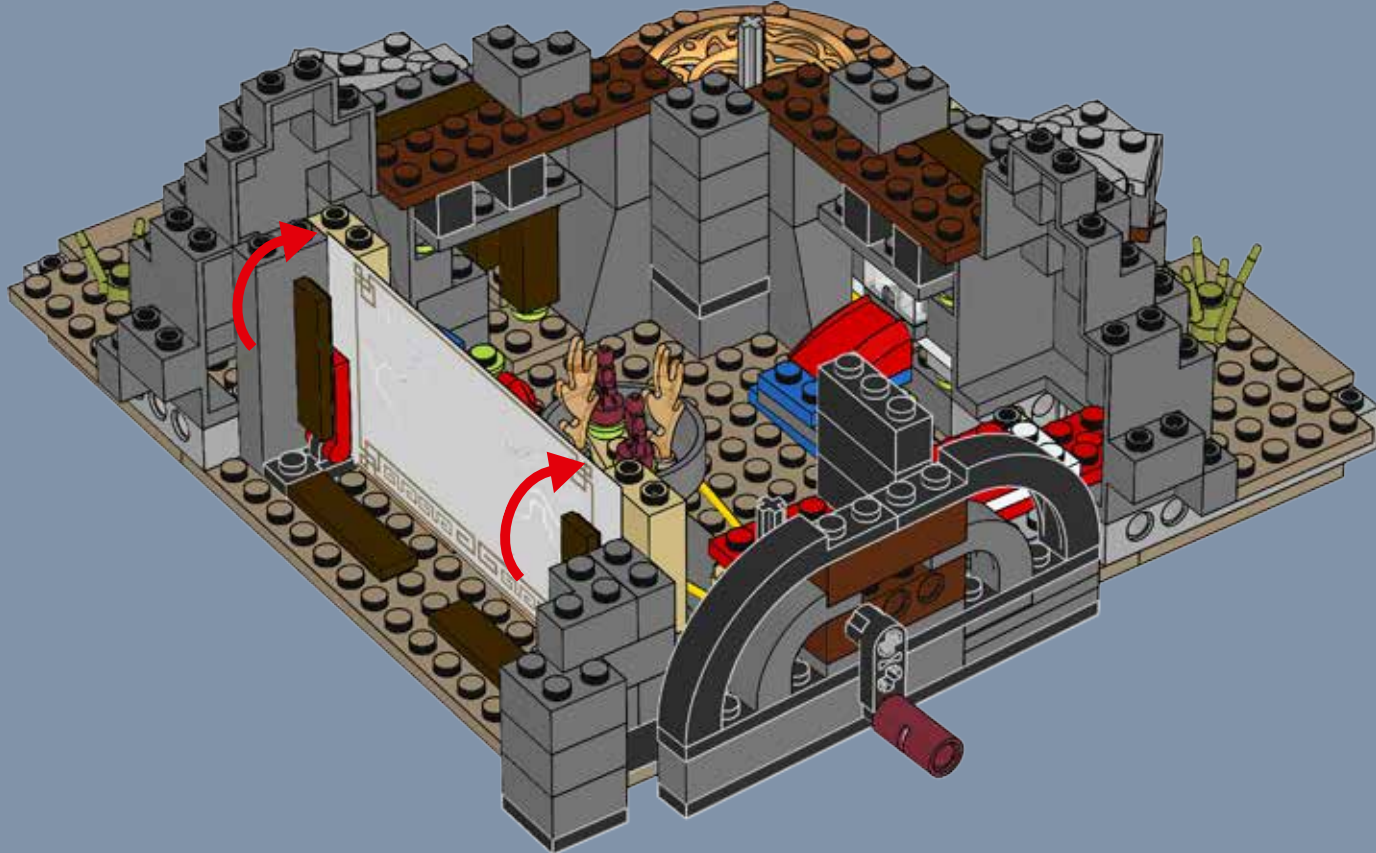

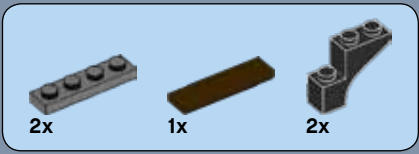

40

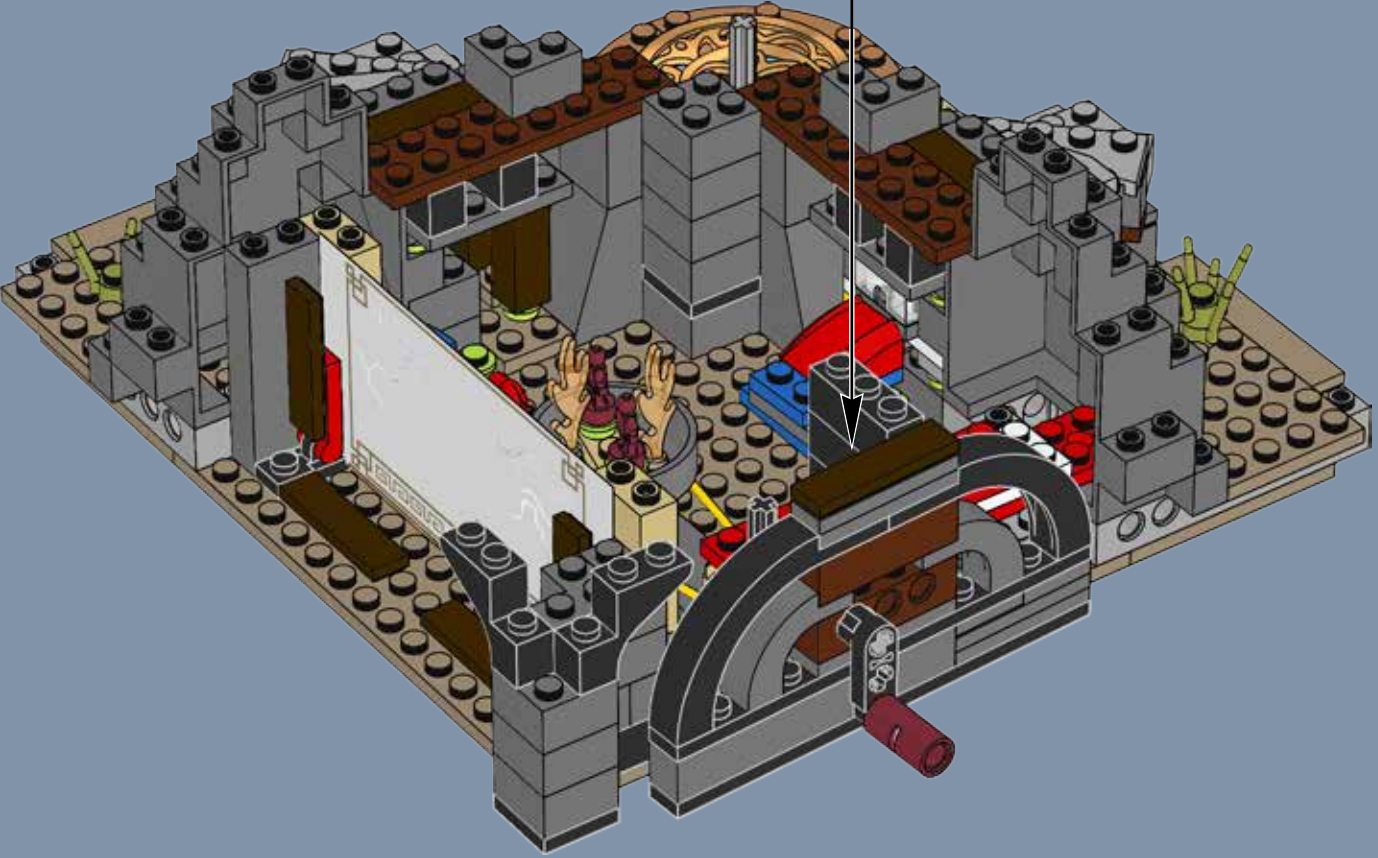
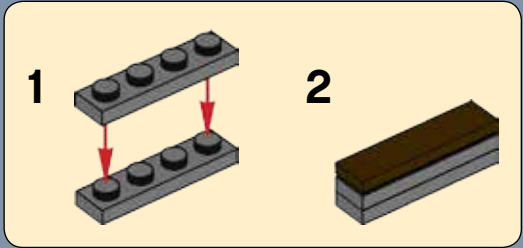



41

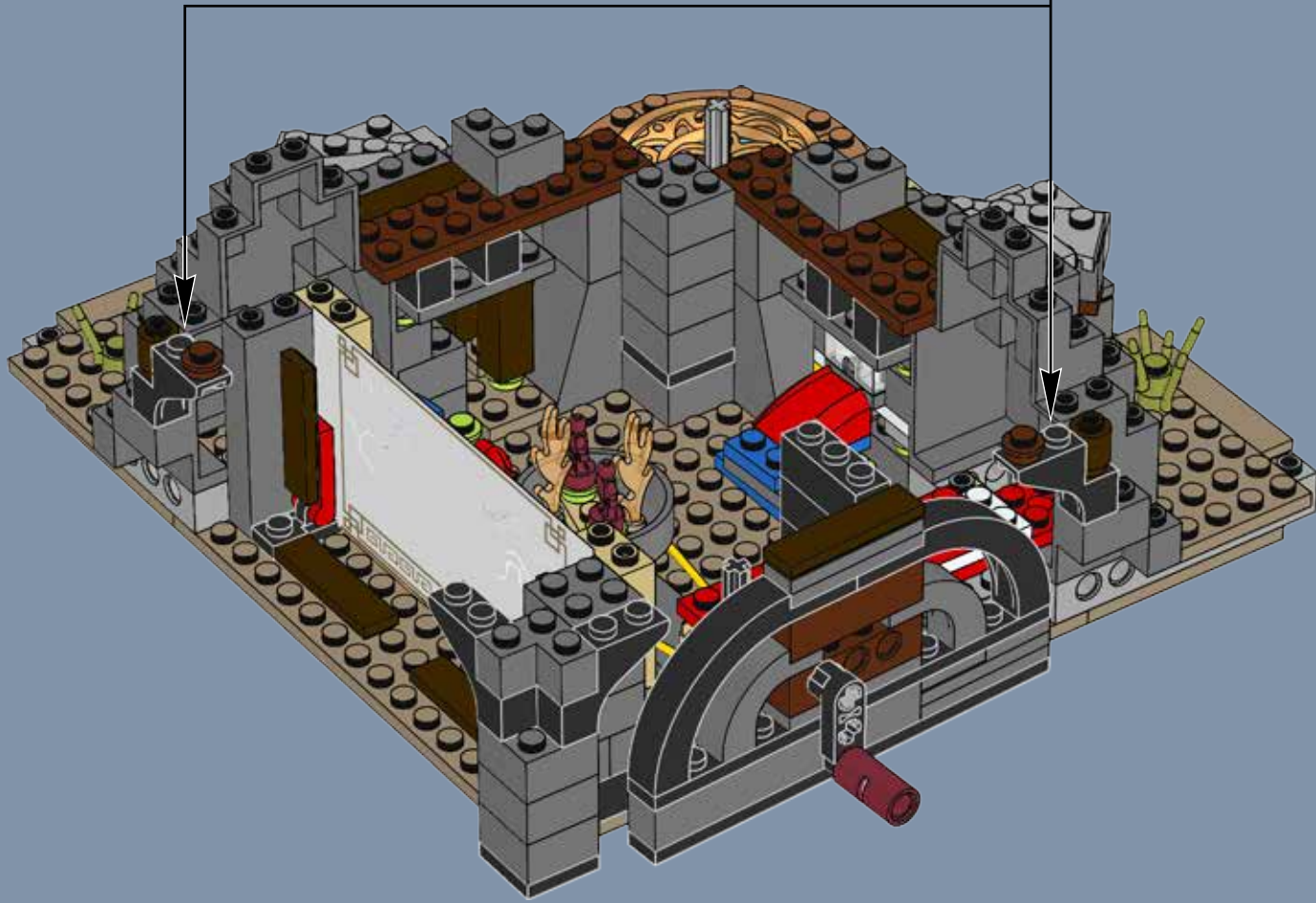
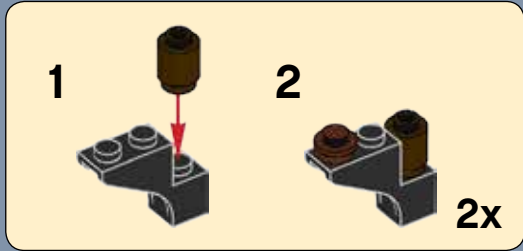



42



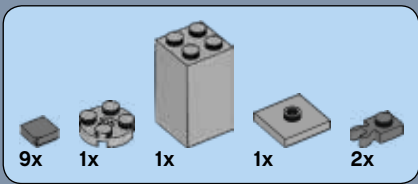

43

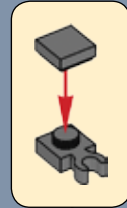
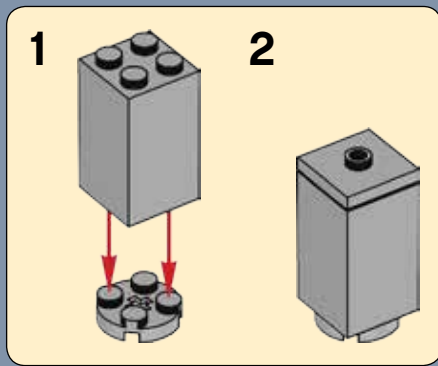

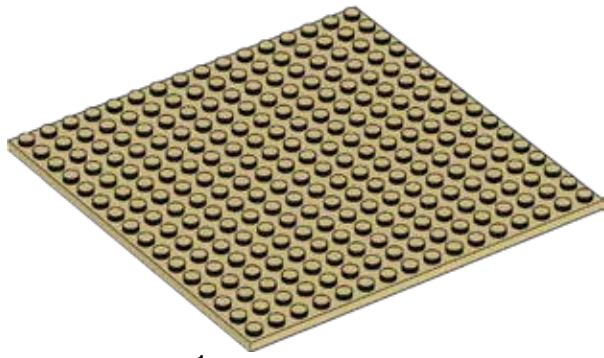

1x

+



7



2



3



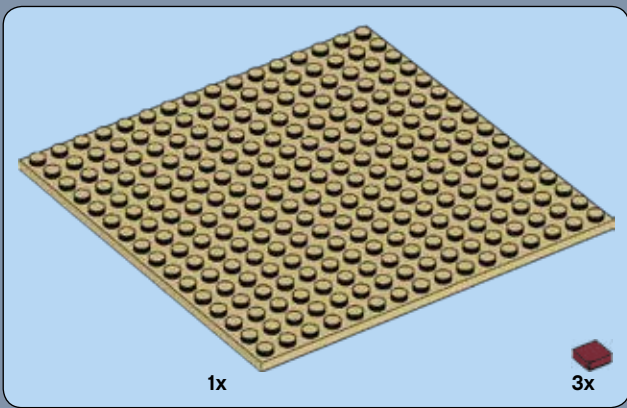

1

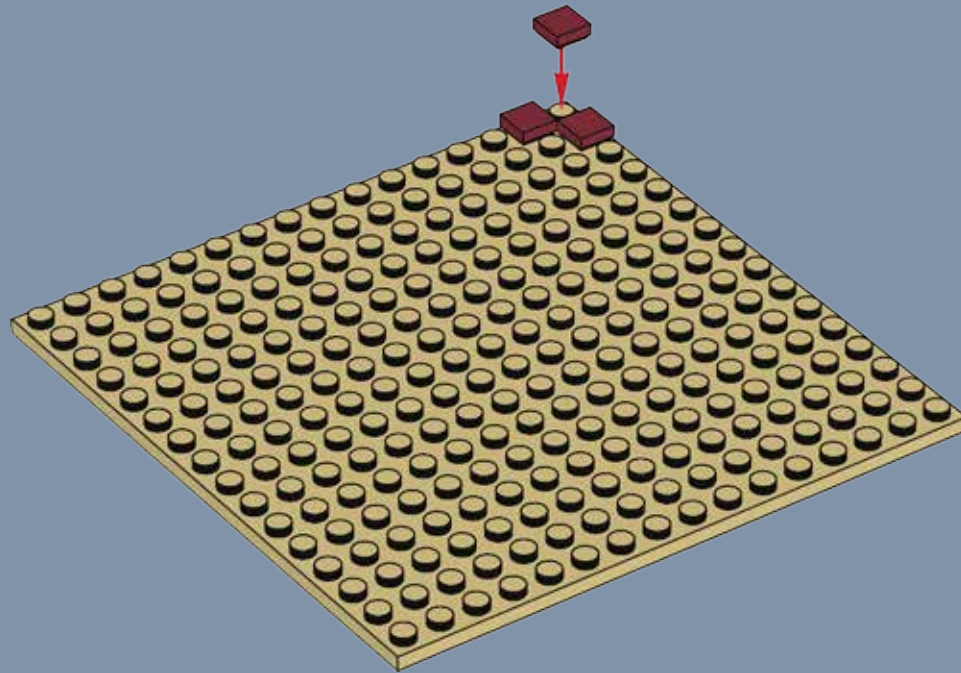

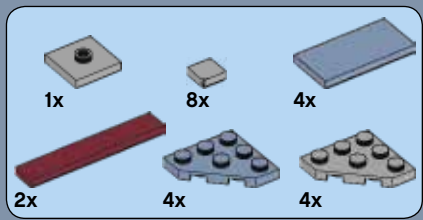

2

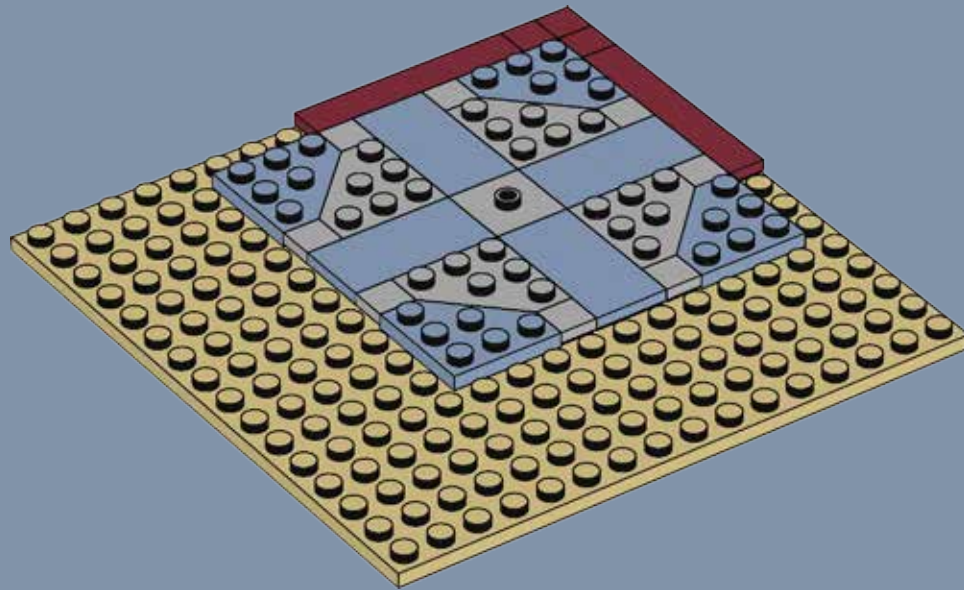



3

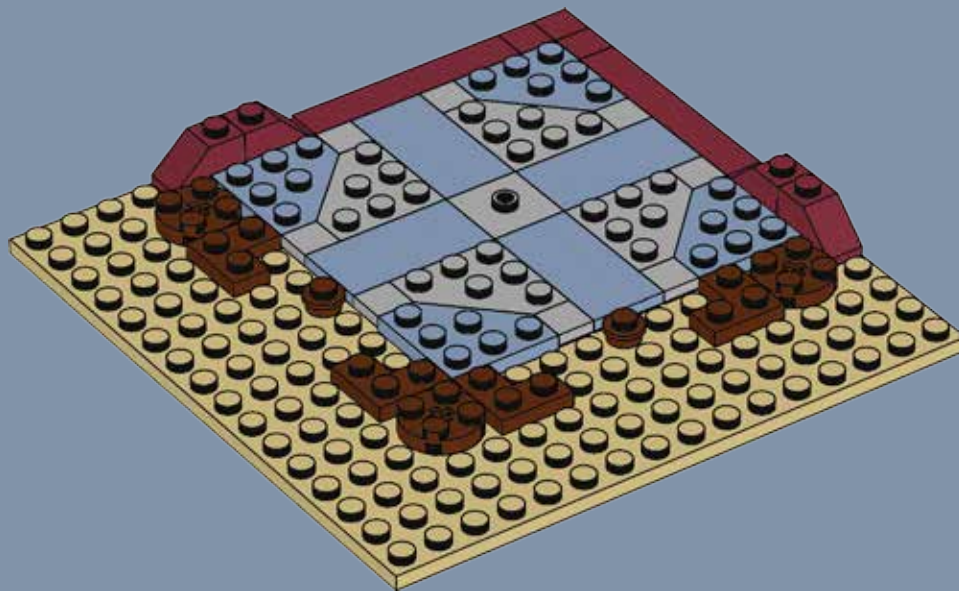



4

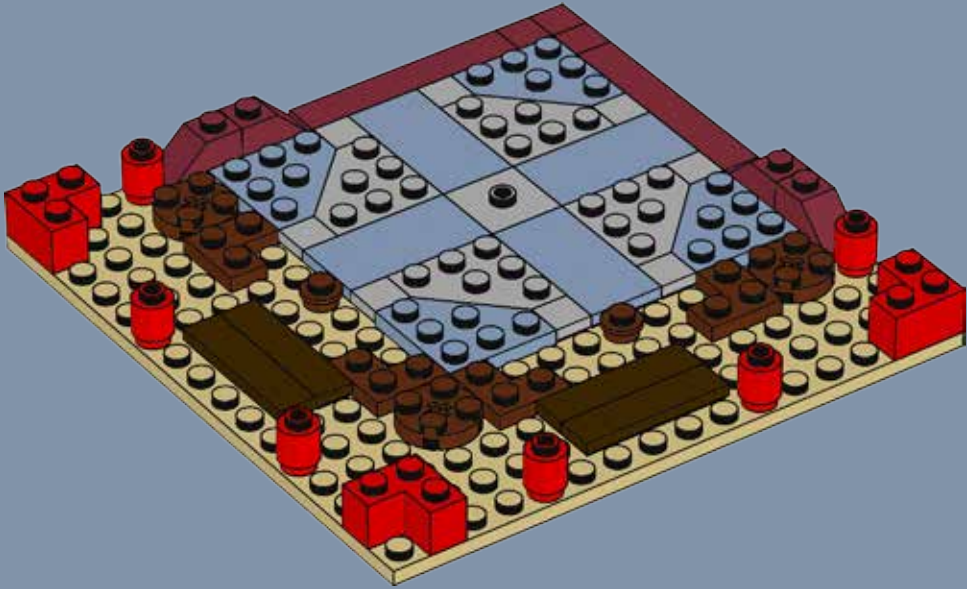

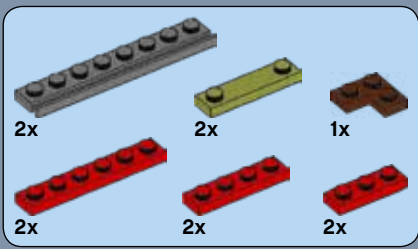

5





6

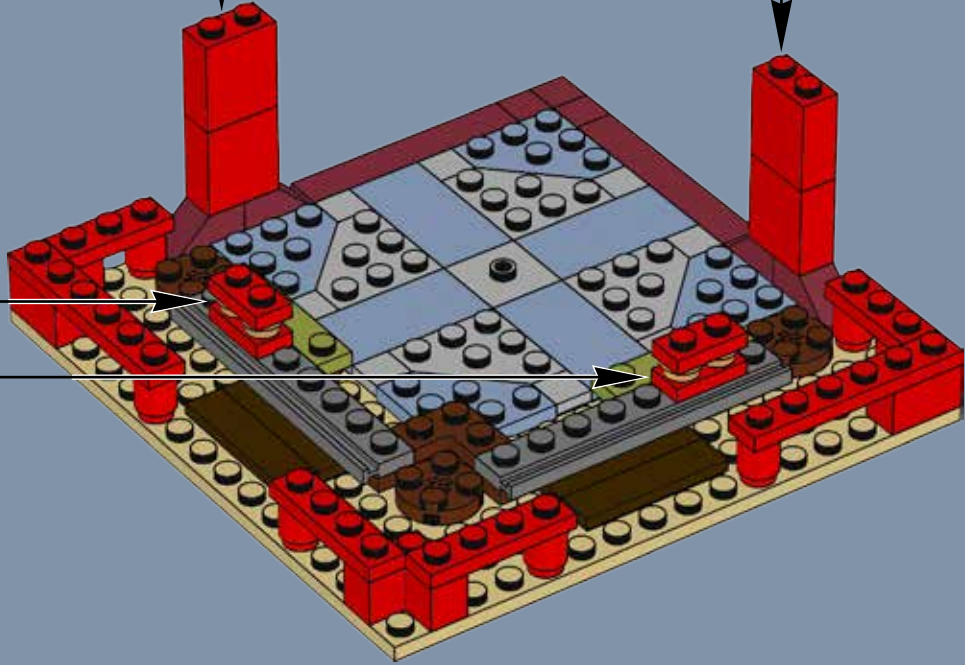
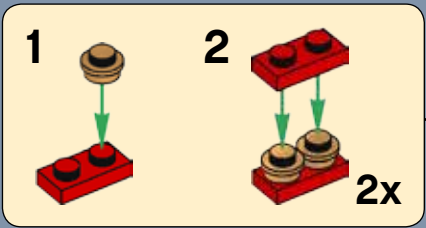
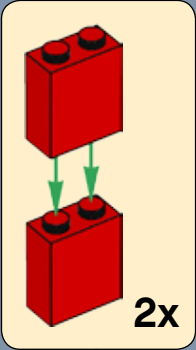

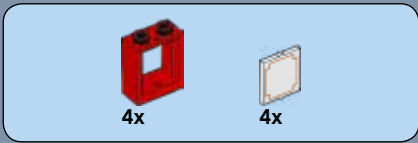

7

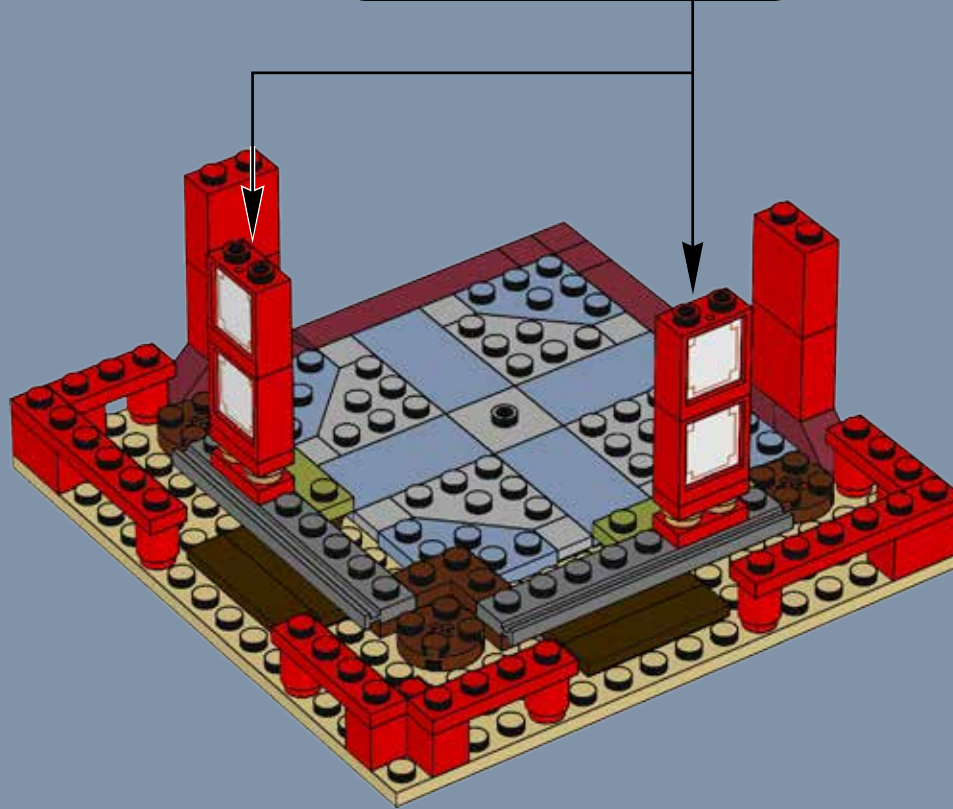
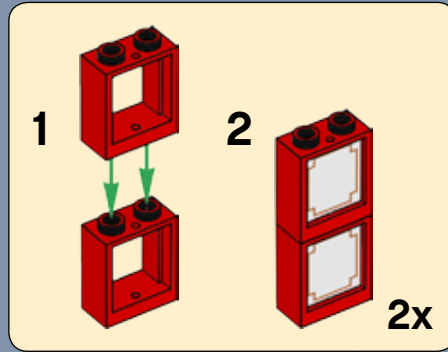



24x

8

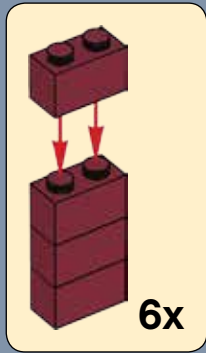

6x

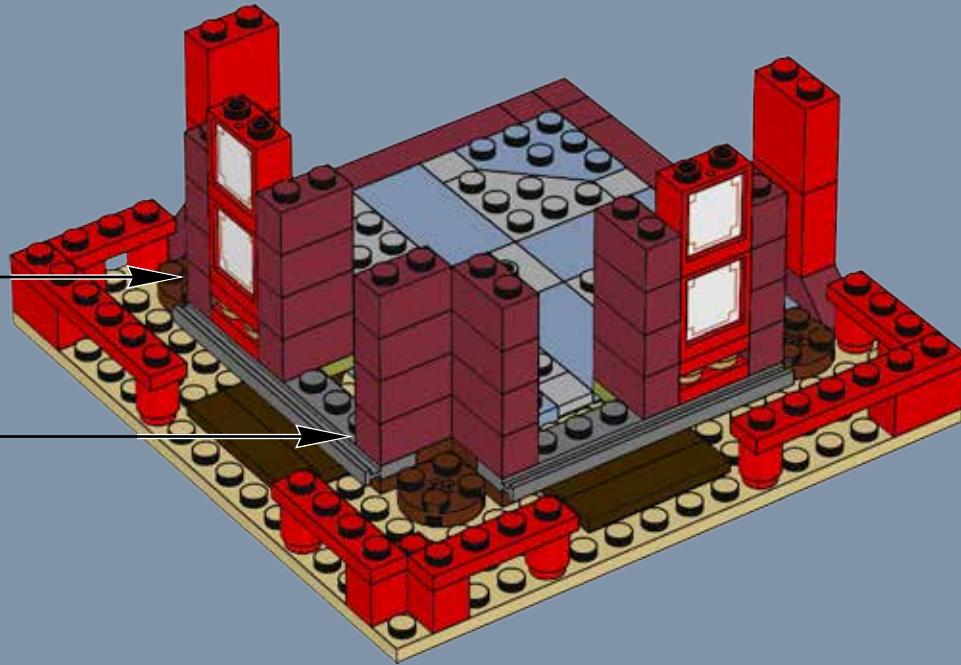



4x



2x

9

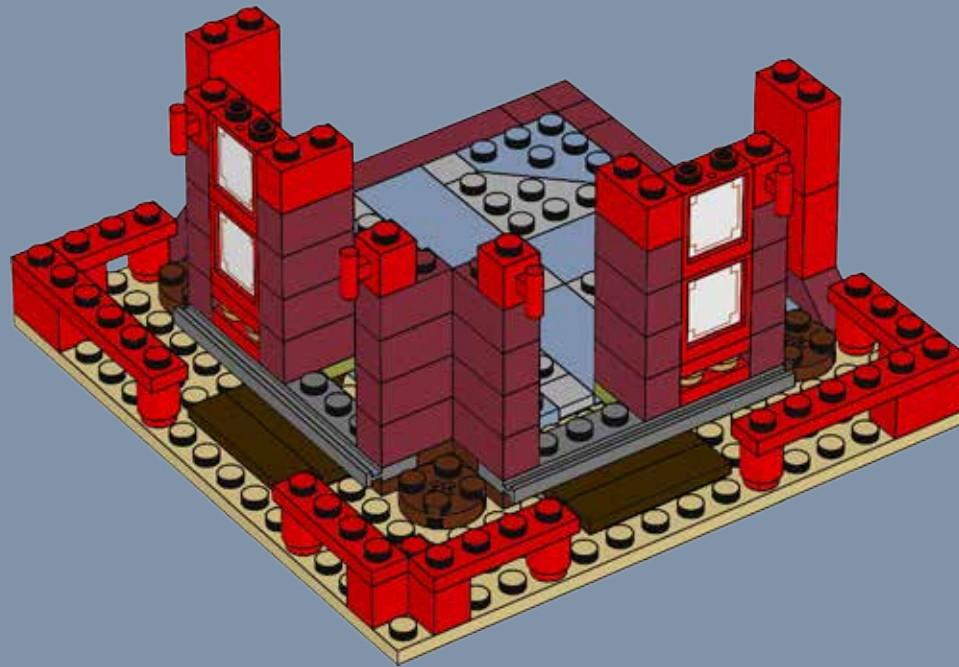

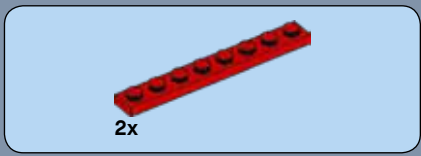

10





11

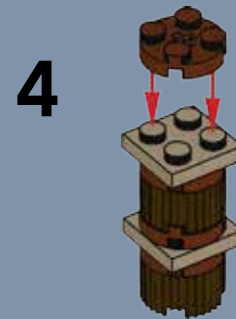

5



6



3x

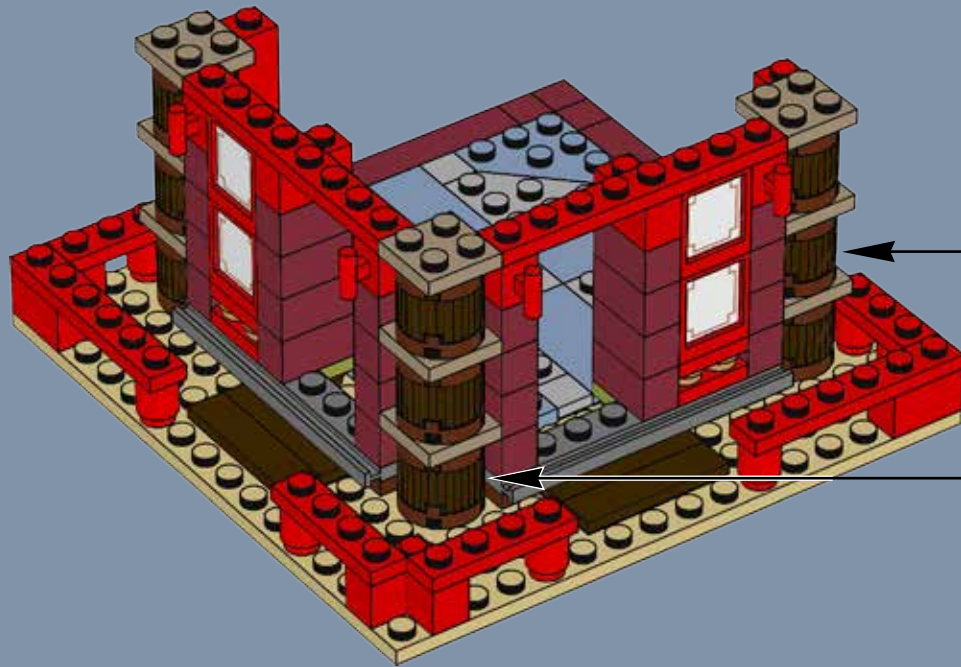



12

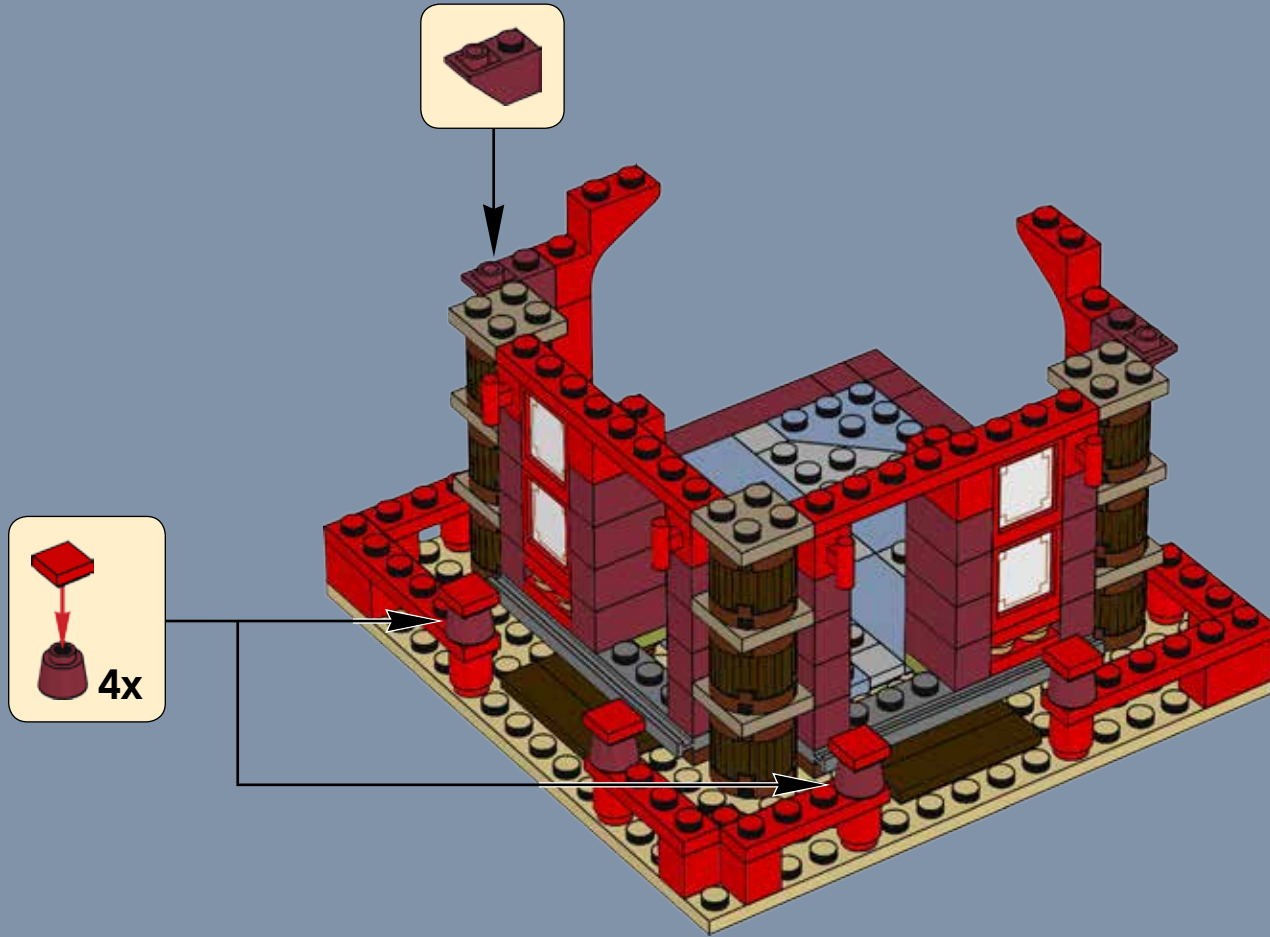



13

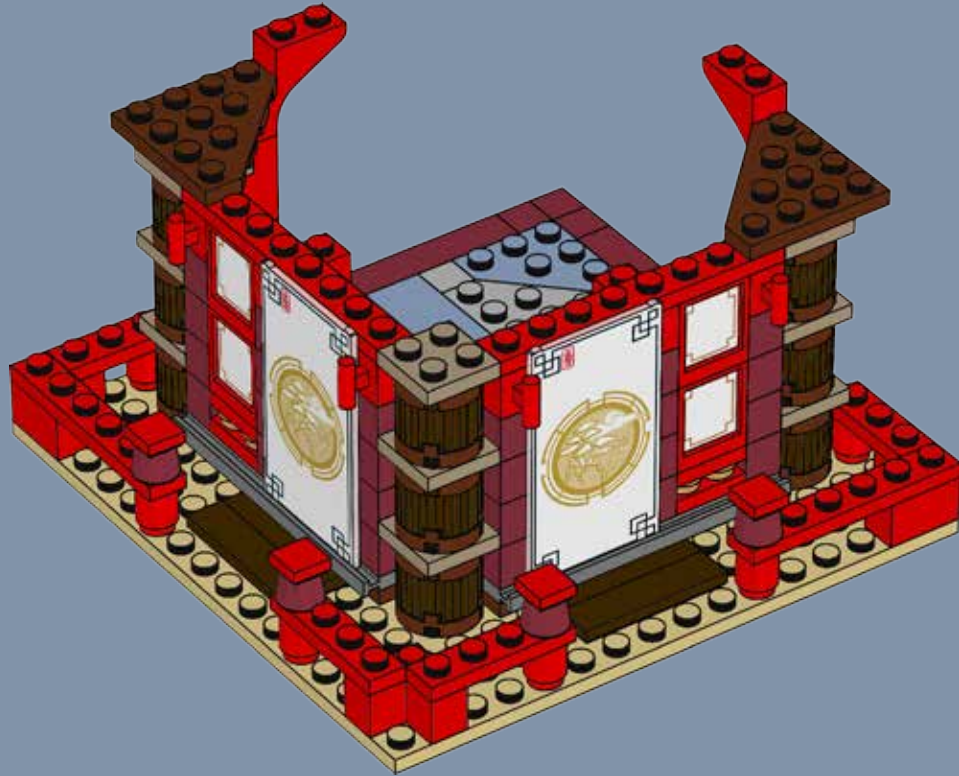

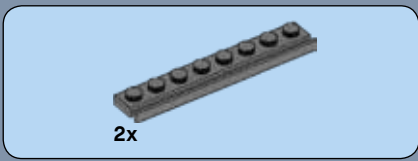

14



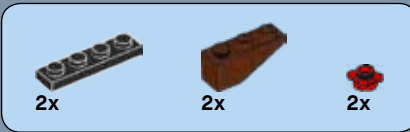
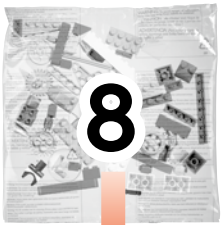

15





16



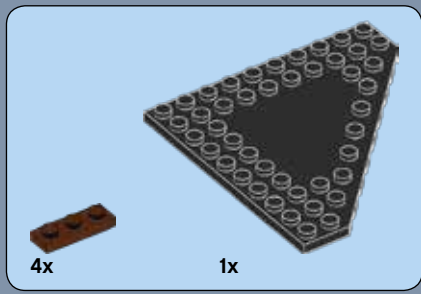

17





18



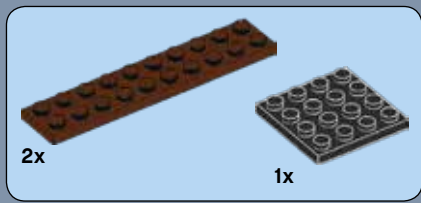

19



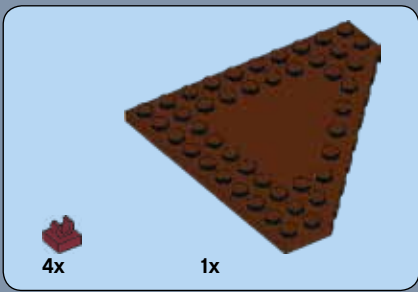

20



44





45

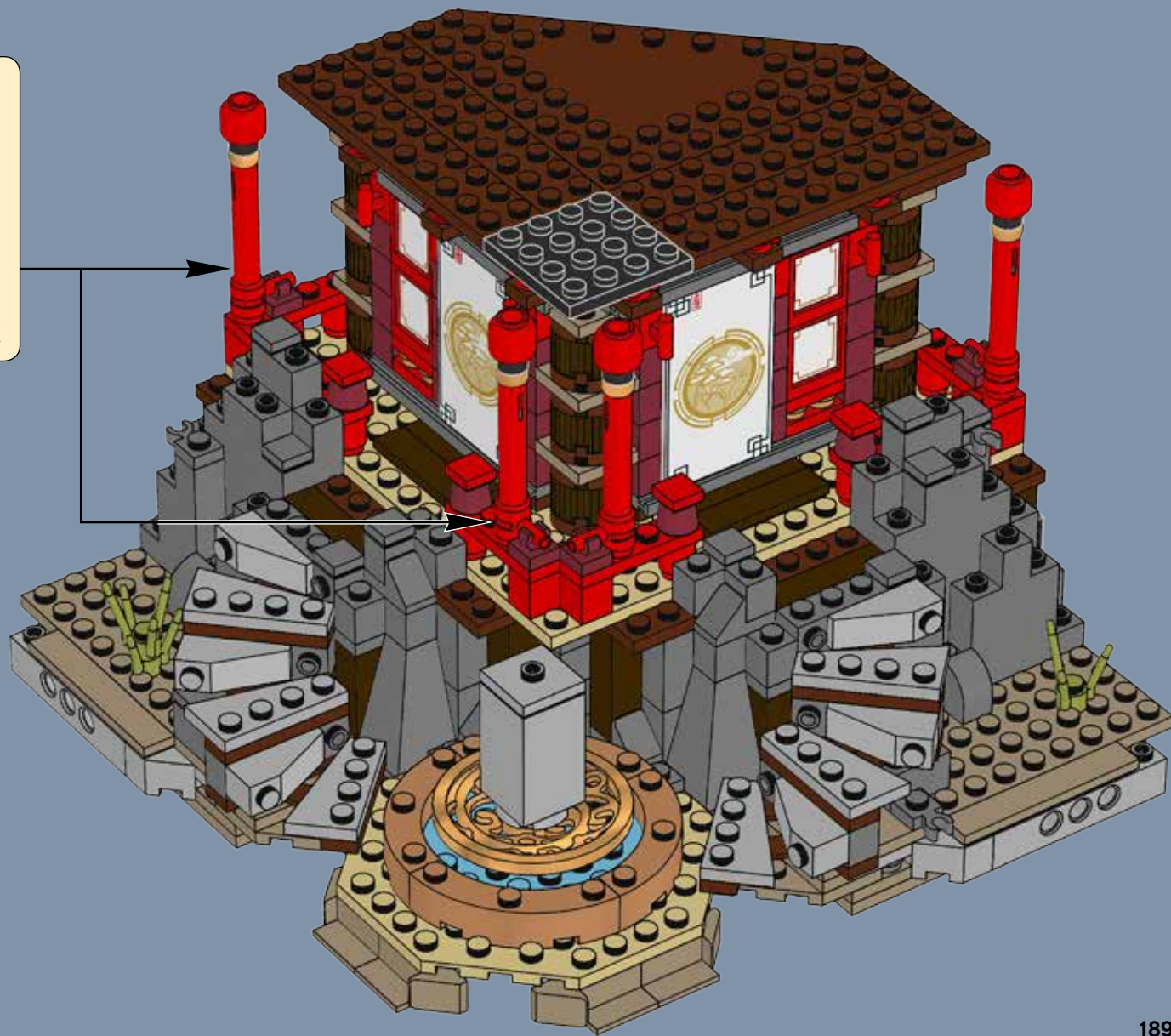
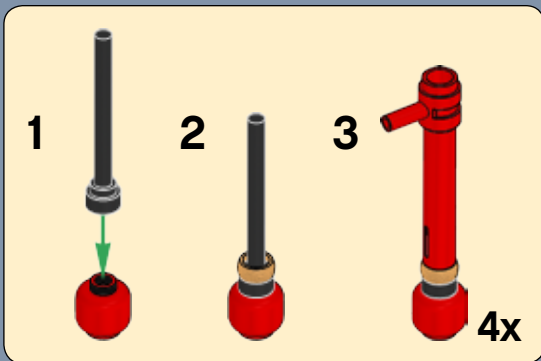

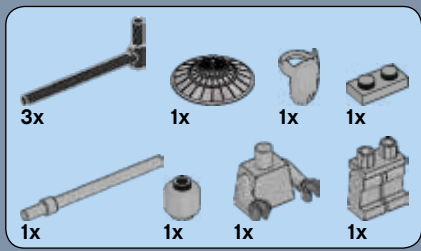

46

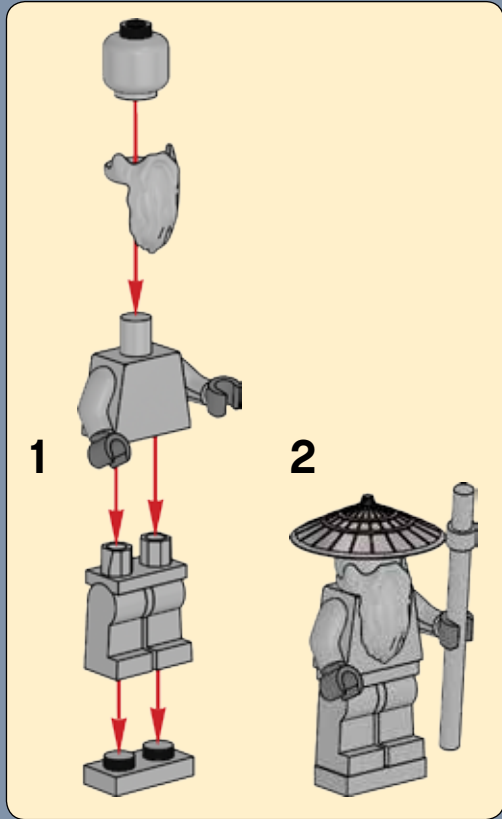



3x



3x

47

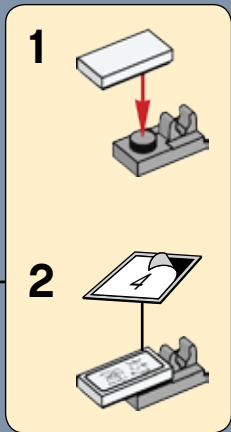
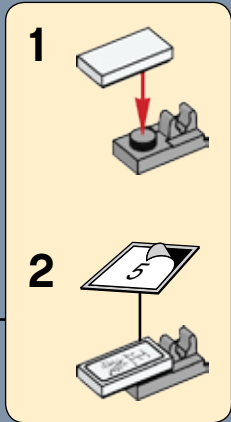
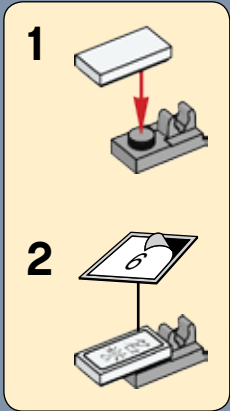

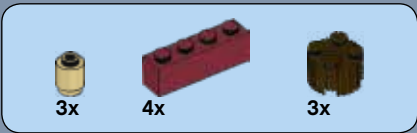

48





49

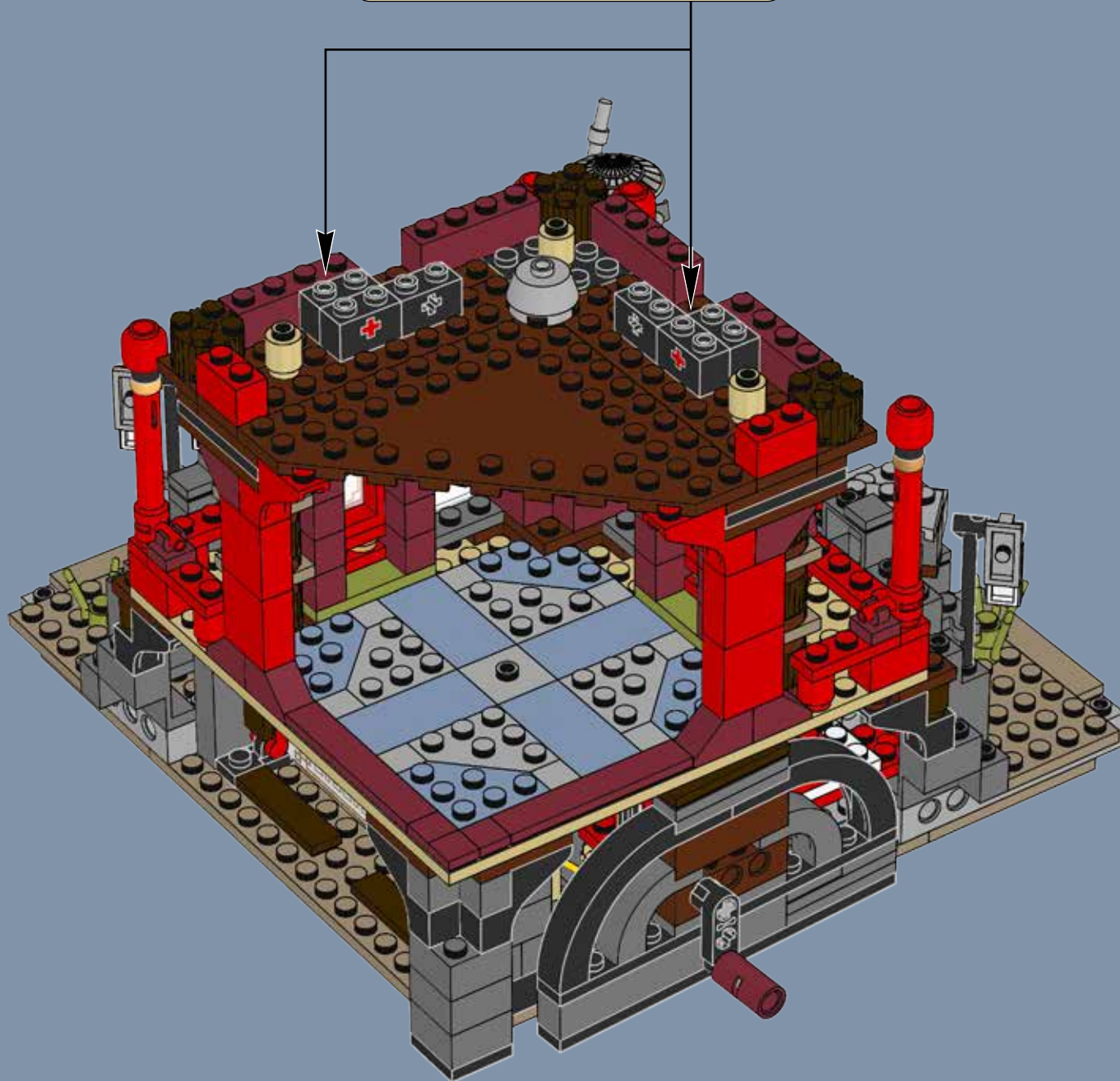
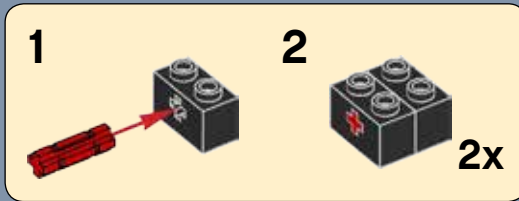

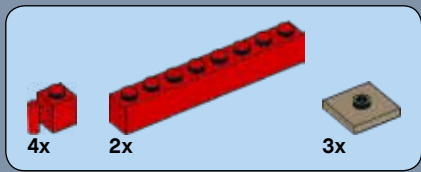

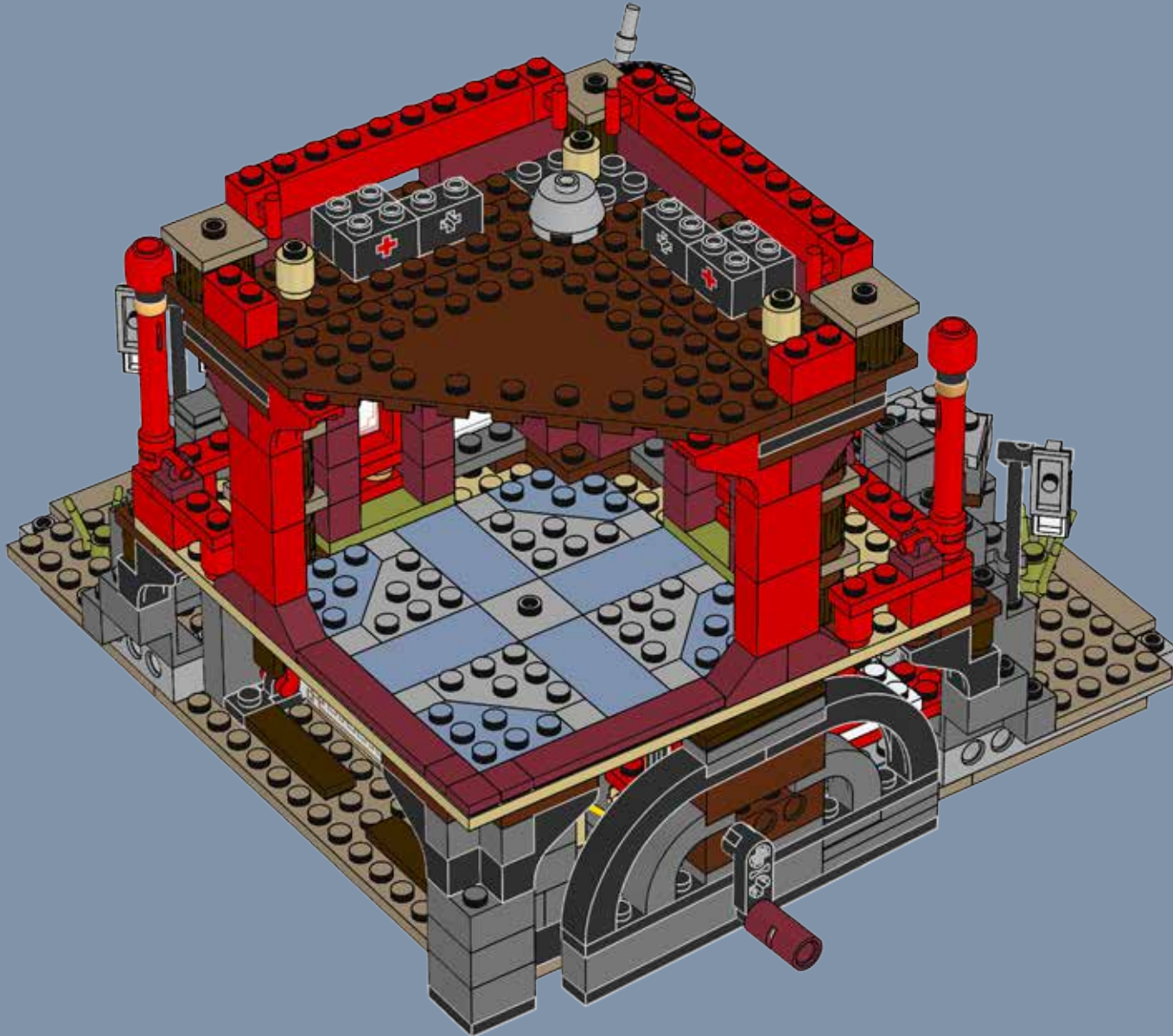

50

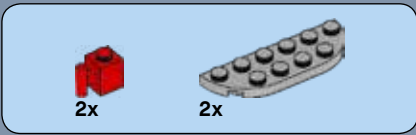

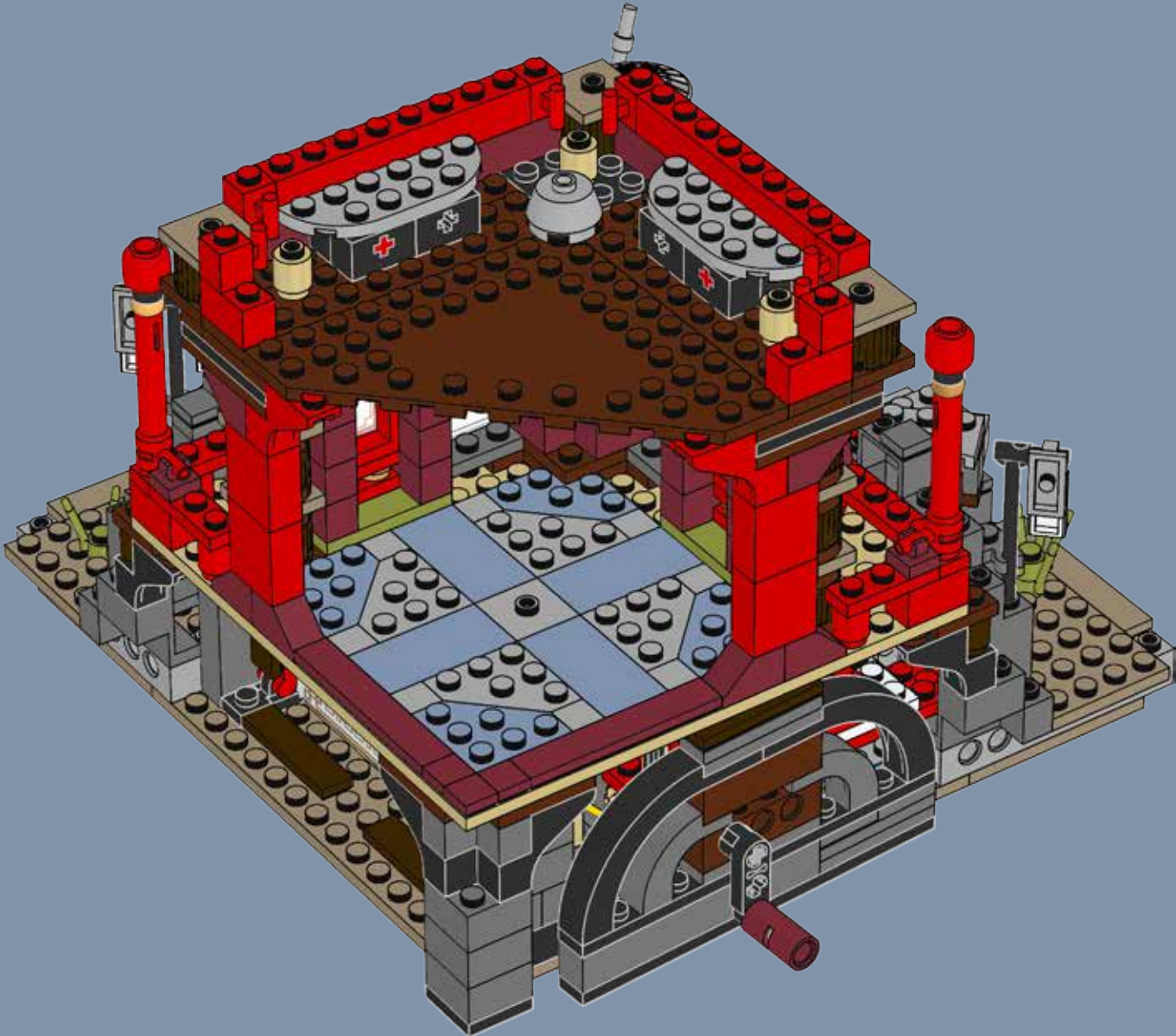

51



2x  3x  2x 

52





53

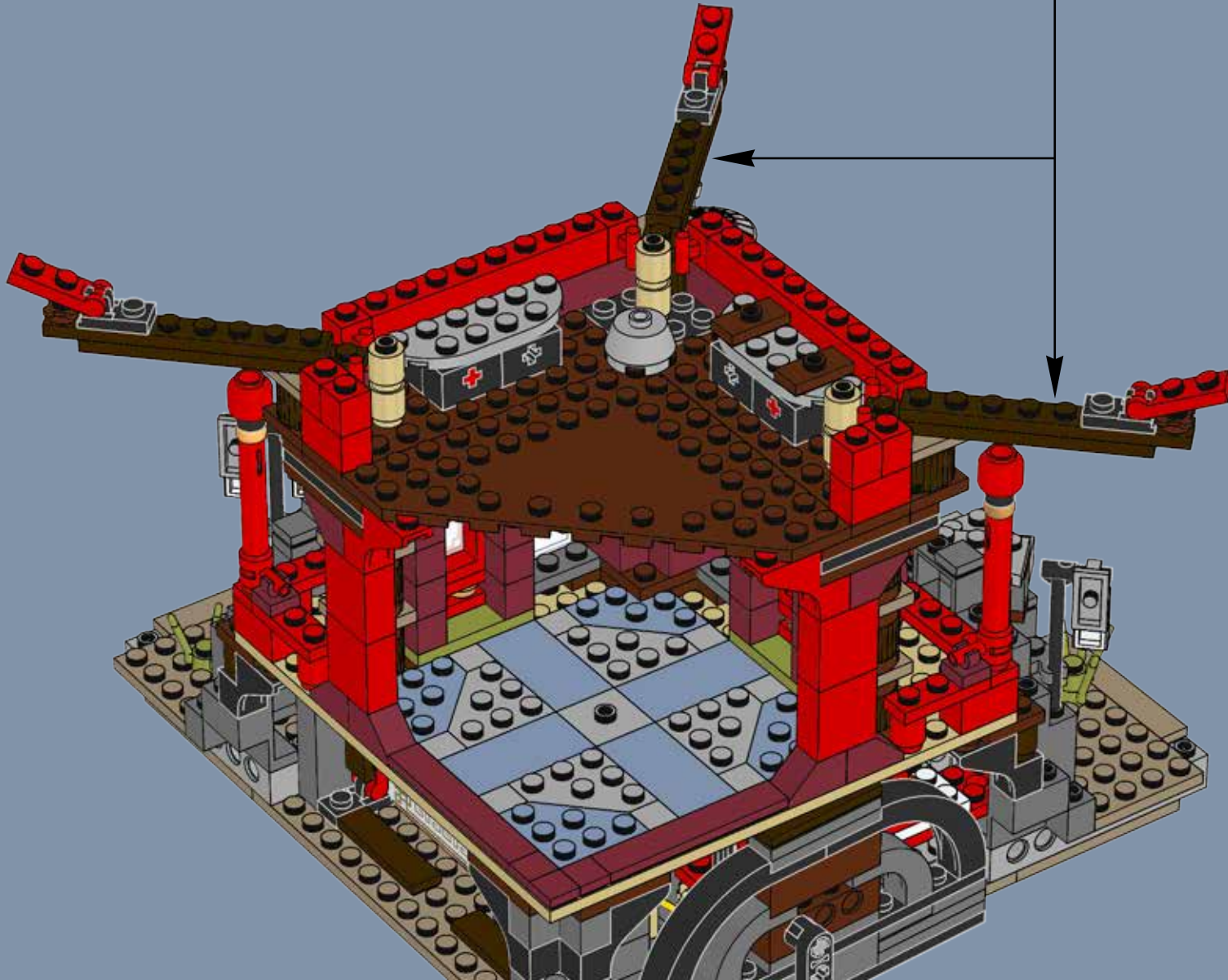
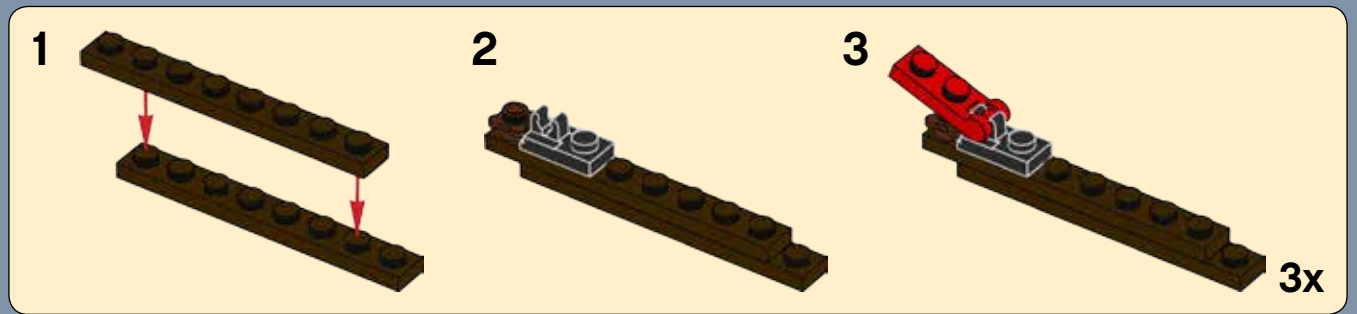

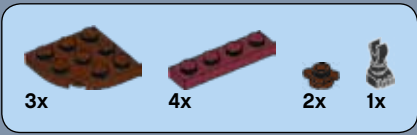

54





55

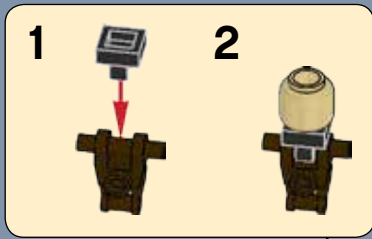

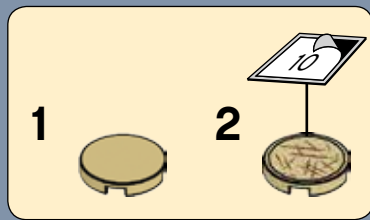
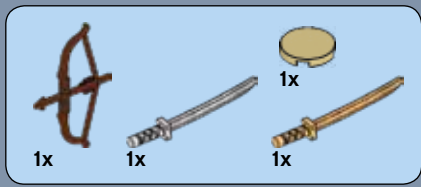

56



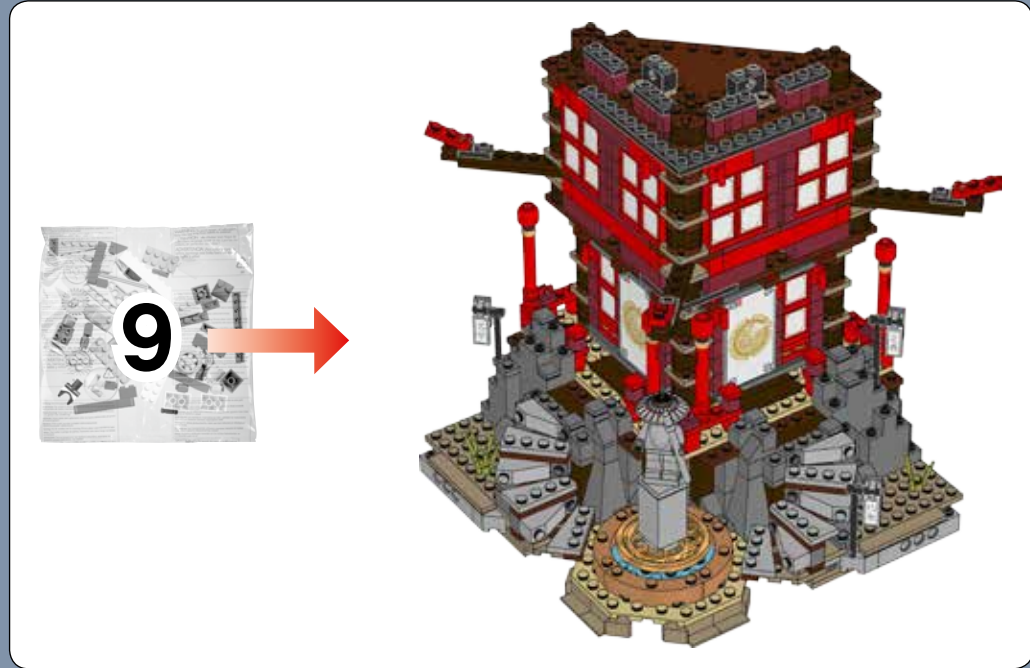



8x

57

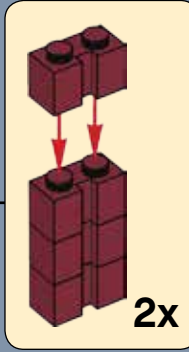



58

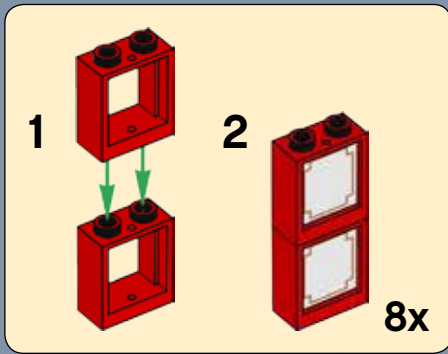



3x



12x



6x



6x

59

1



2



3



4



3x

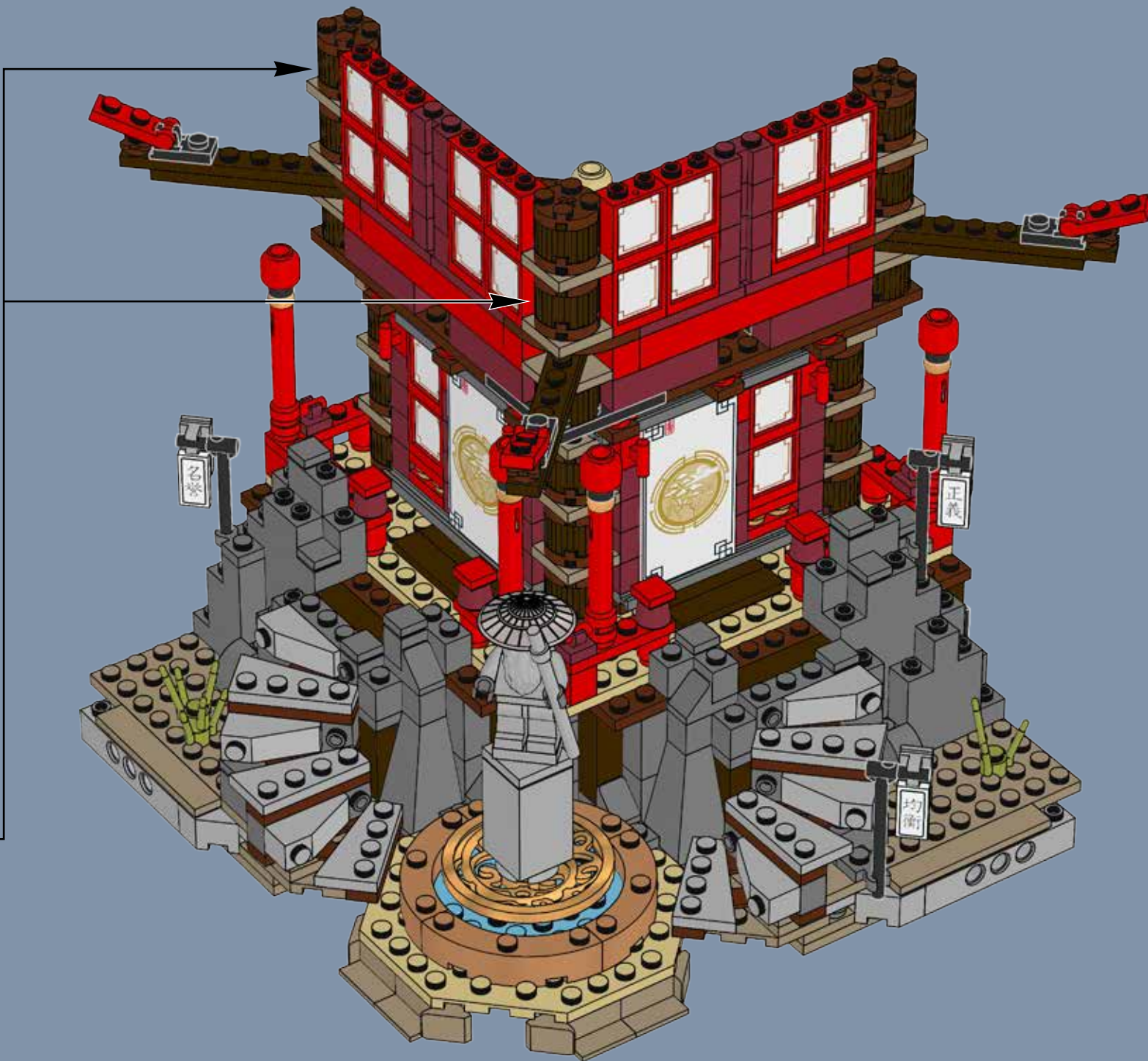



60

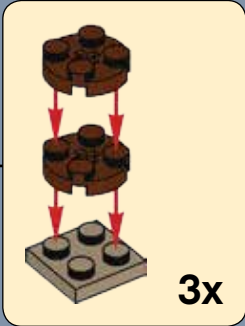

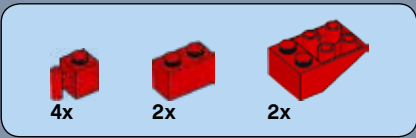

61



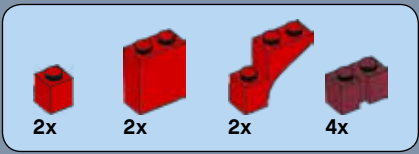

62

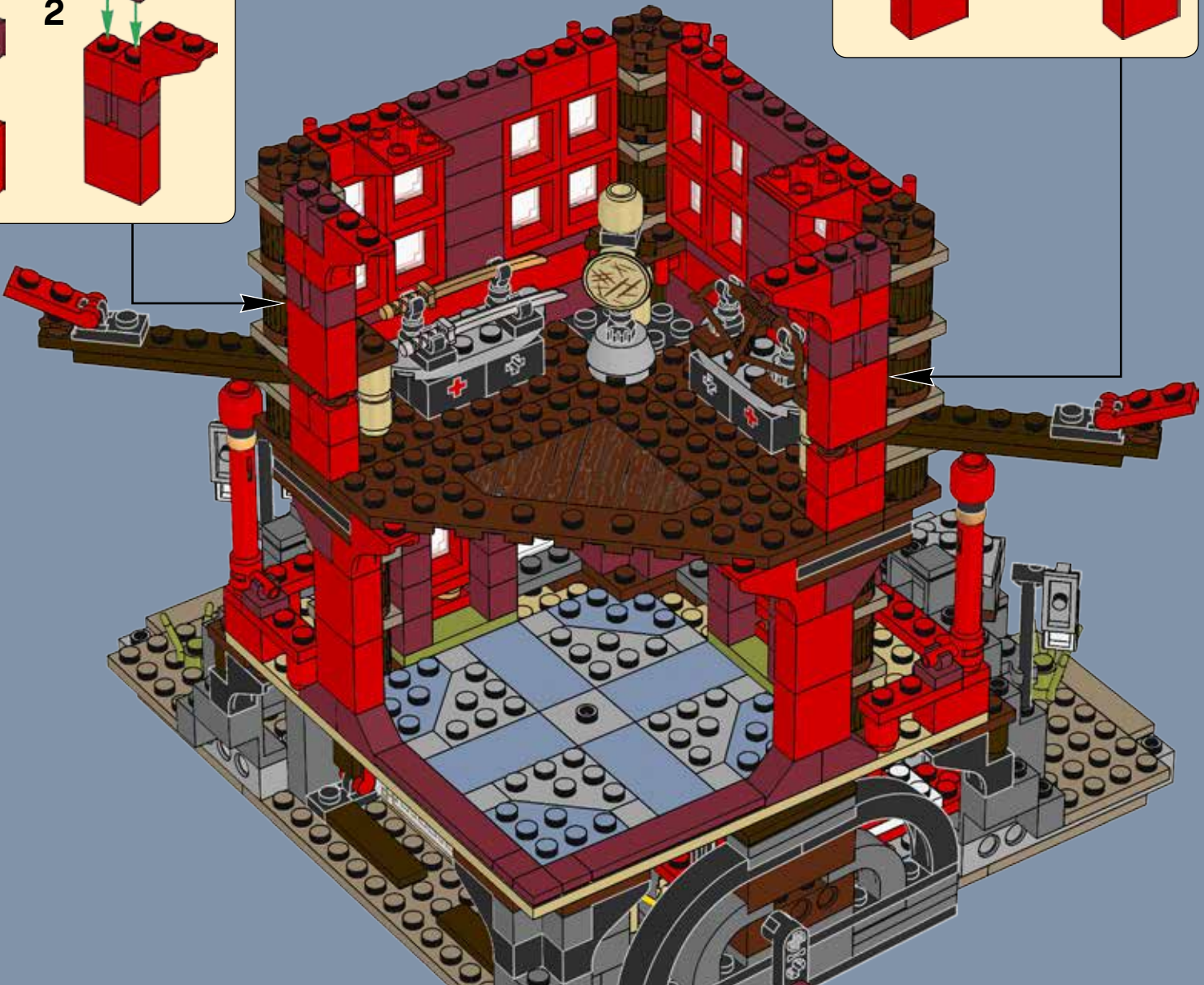
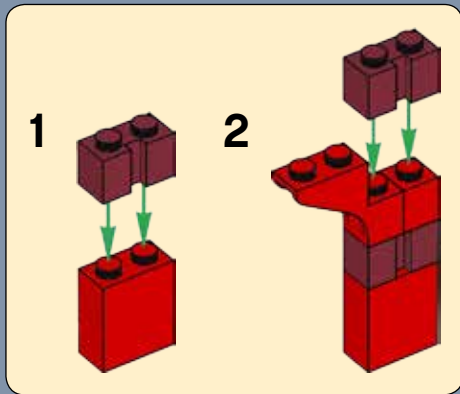
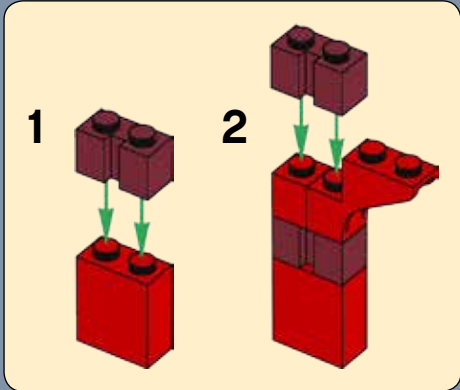

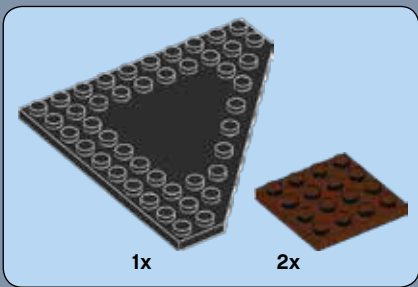

63



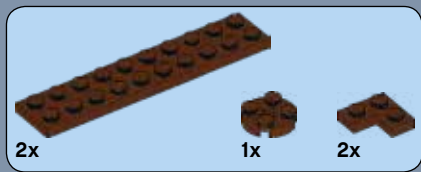

64



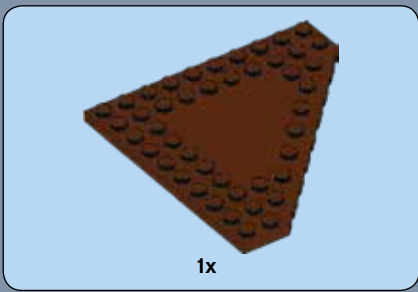

65

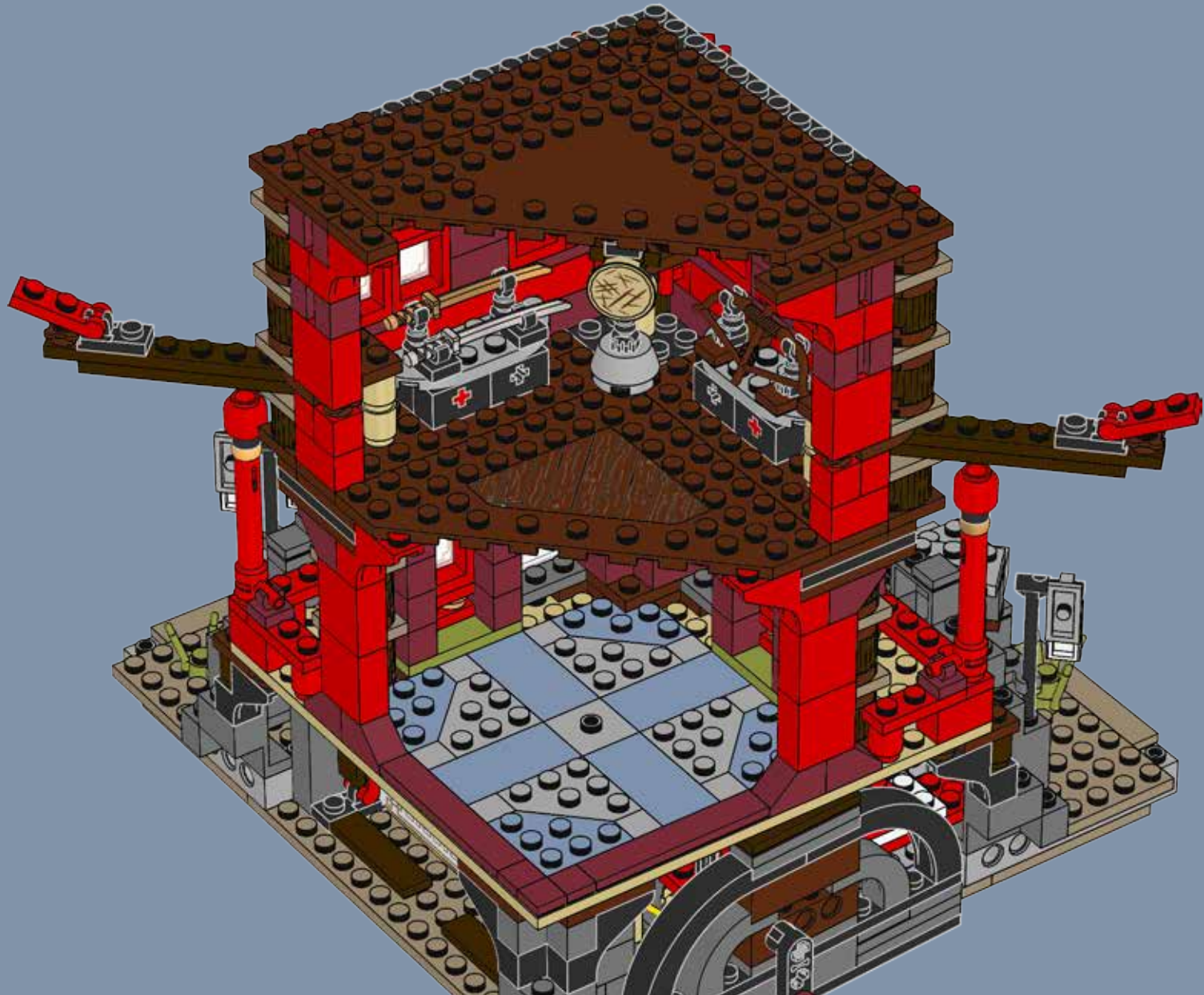



66





67



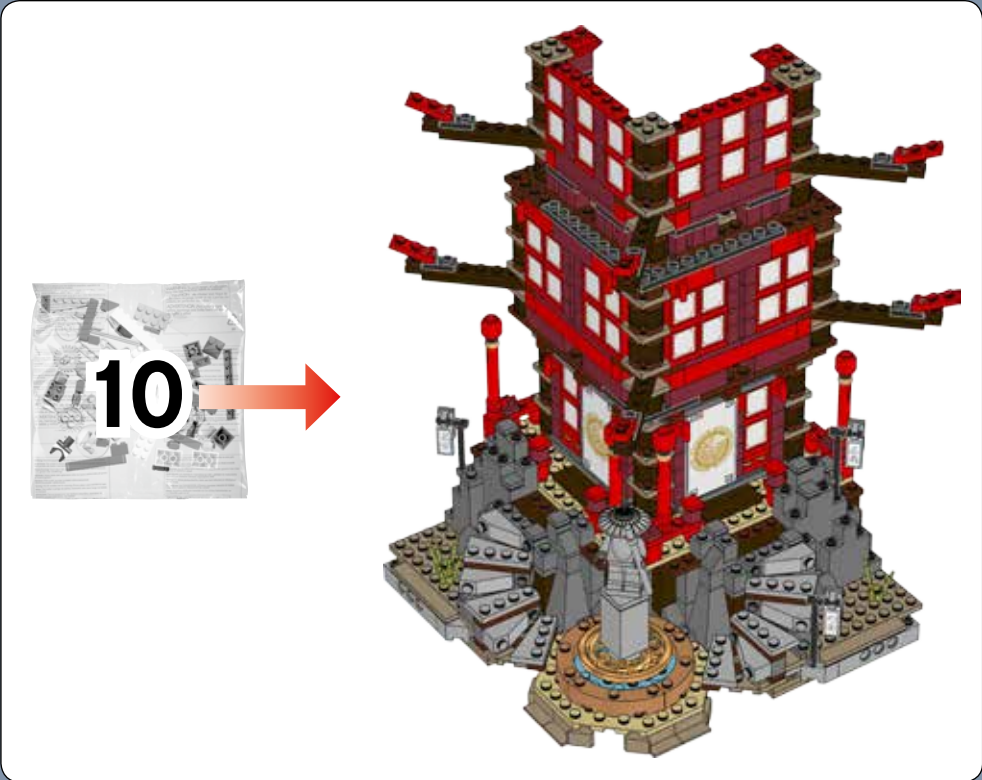



68



3x  4x  2x 

69



2x  3x 

70





71



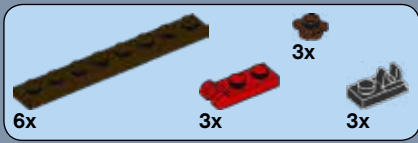

72

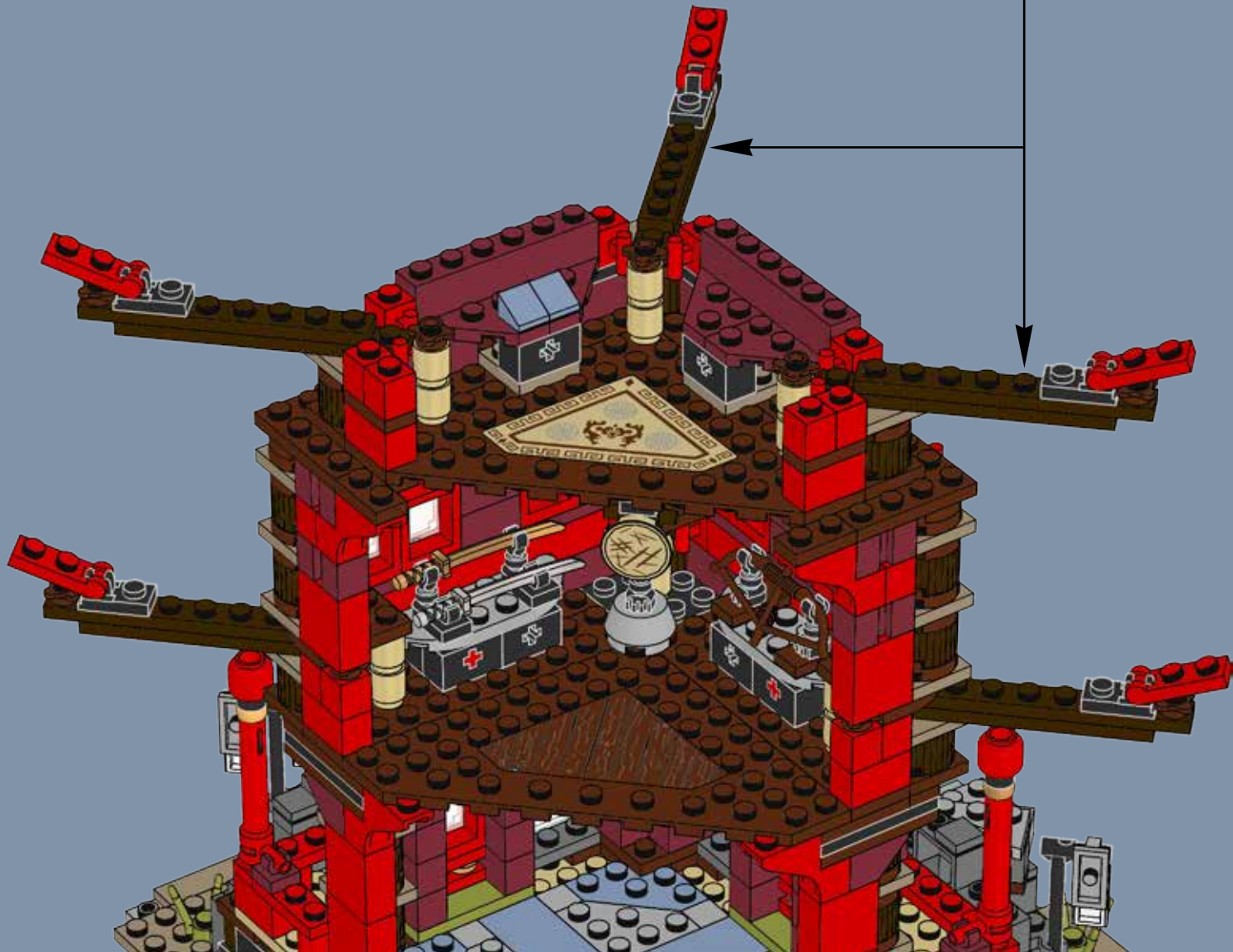
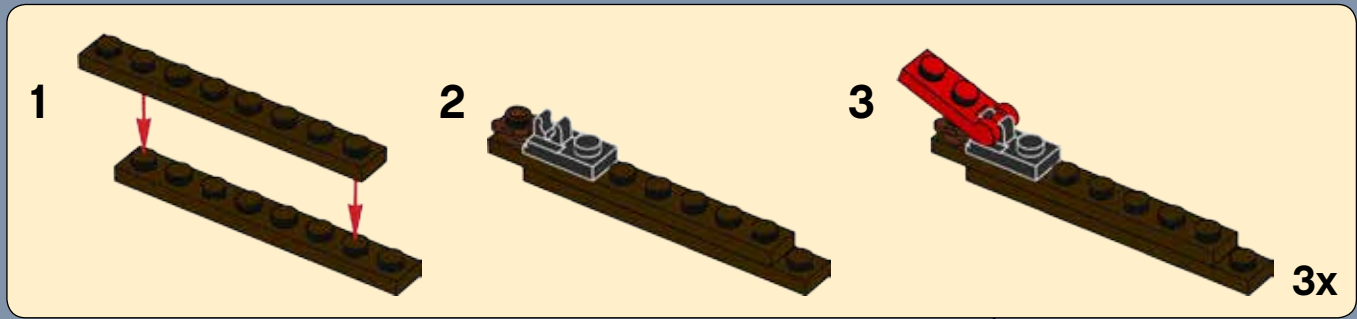



73

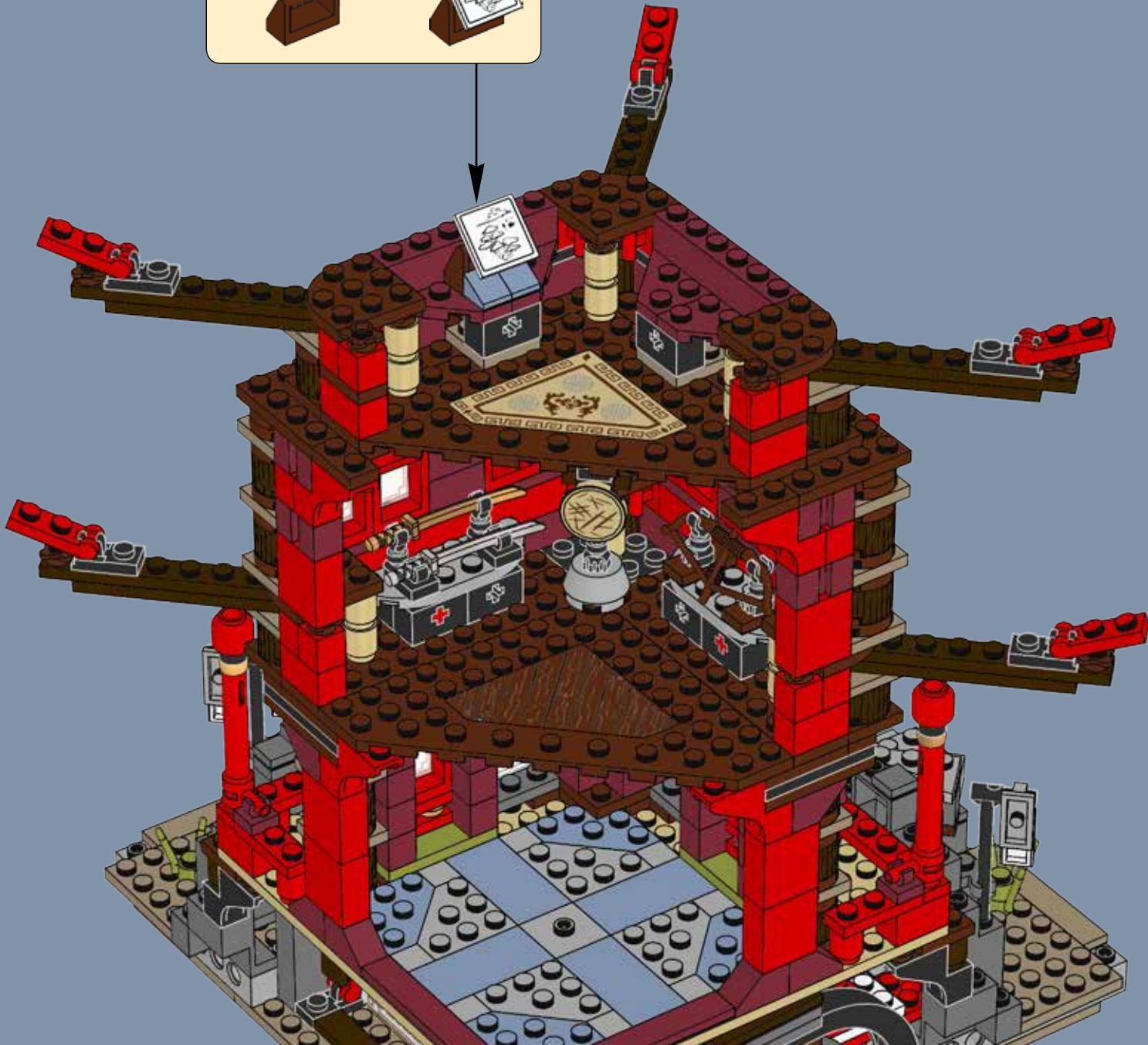
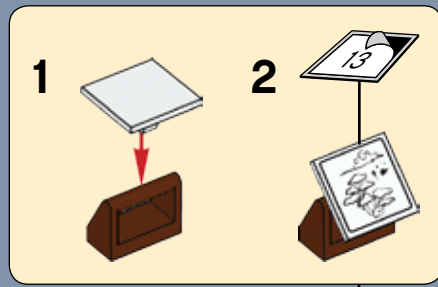

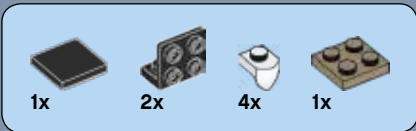

74

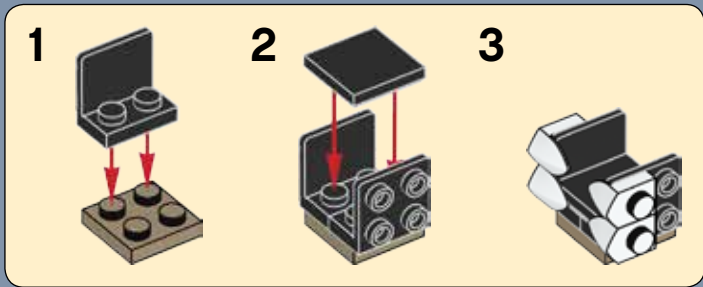



75

1

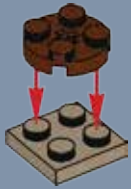

2



3



4



3x

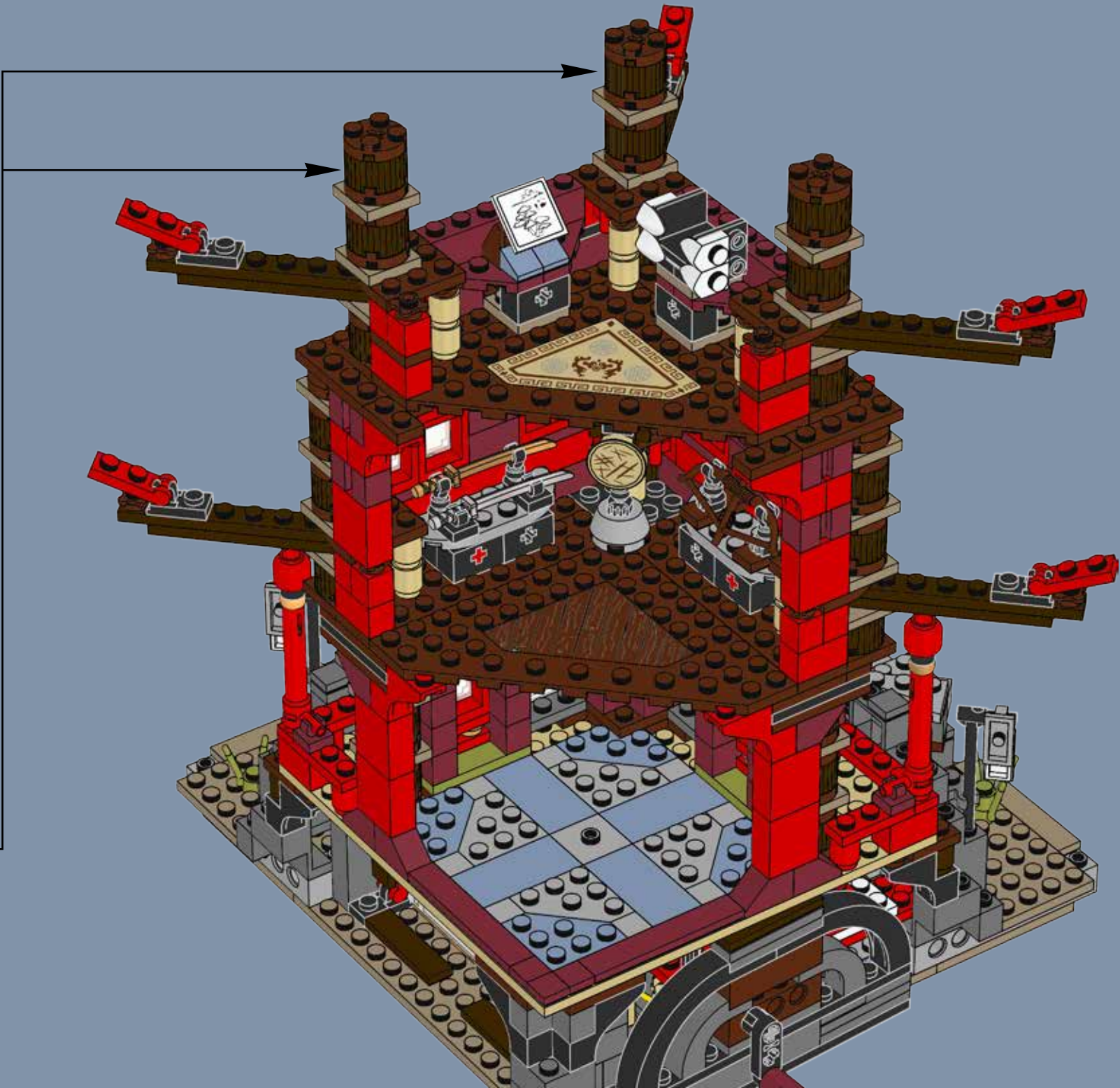



76

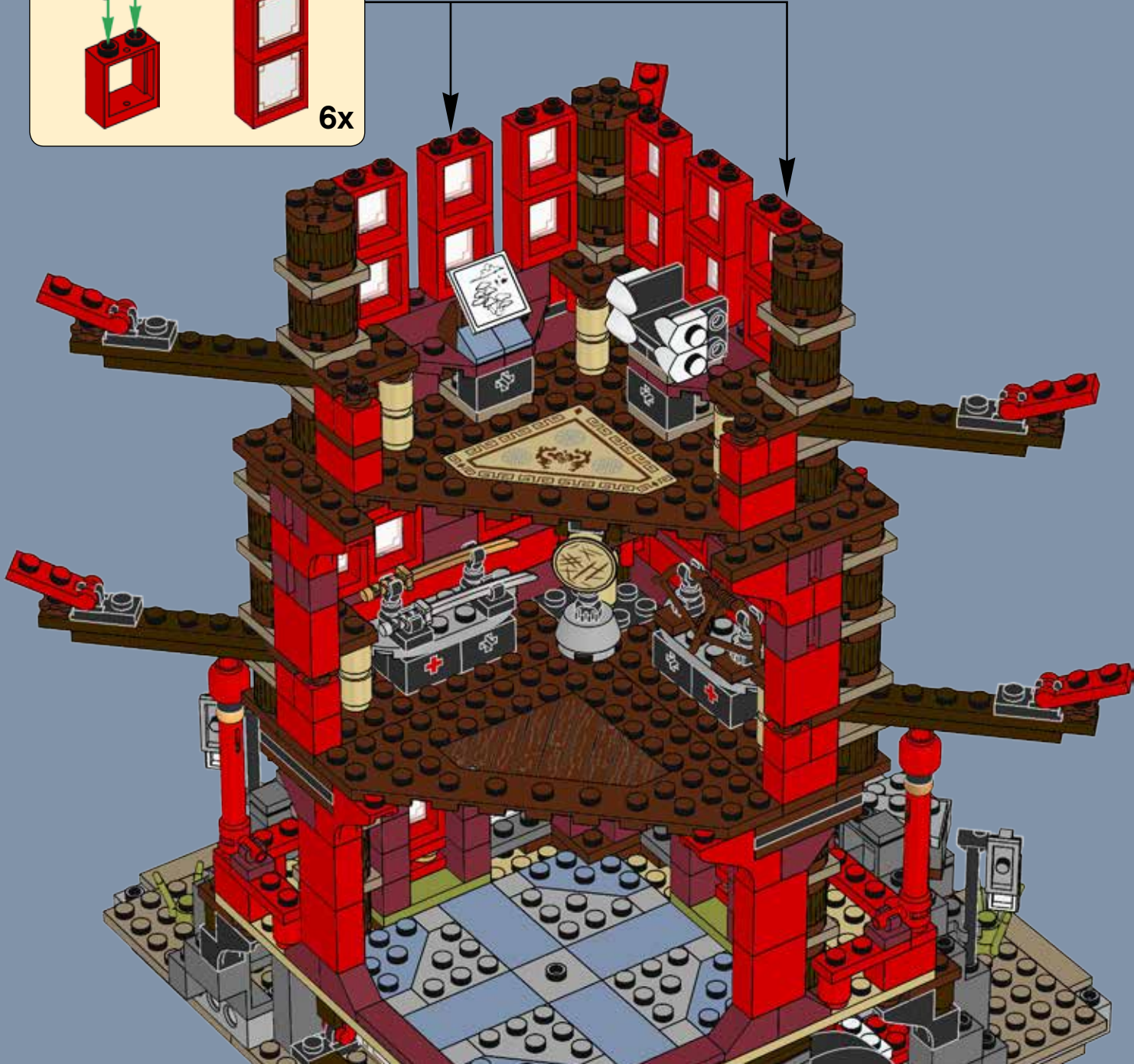
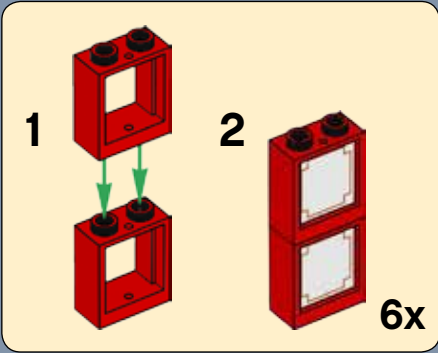

16x

4x

77

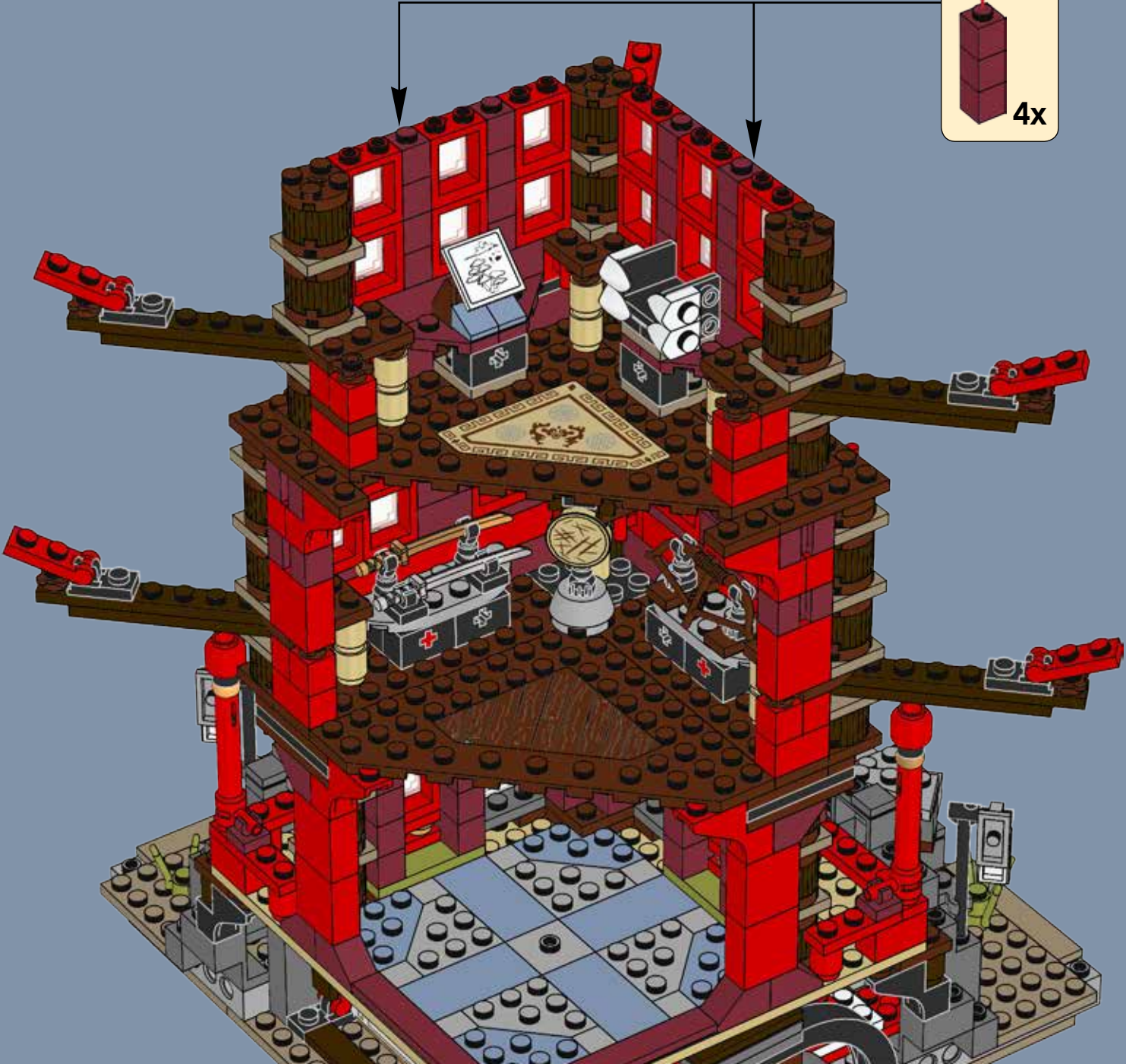



78

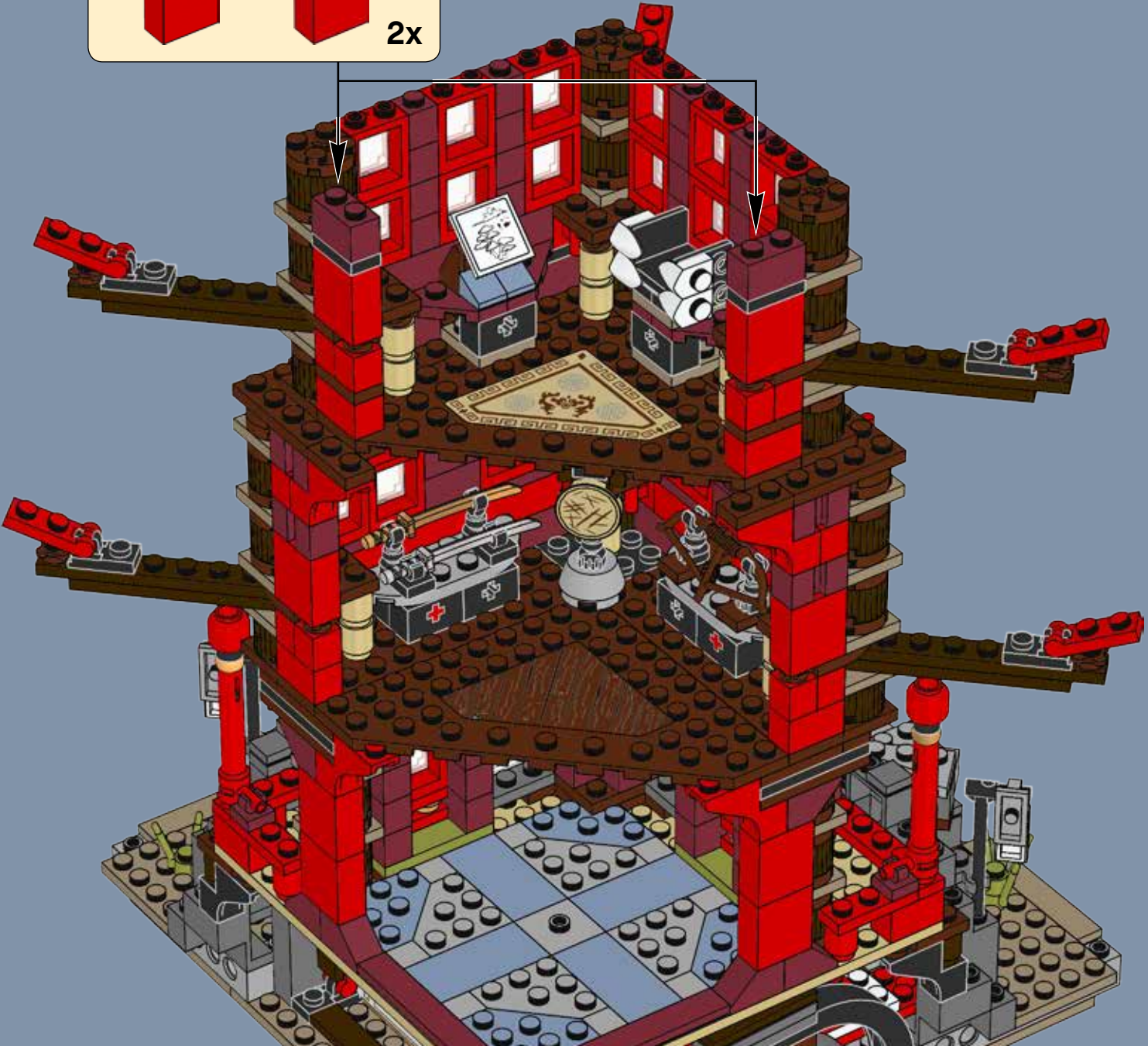
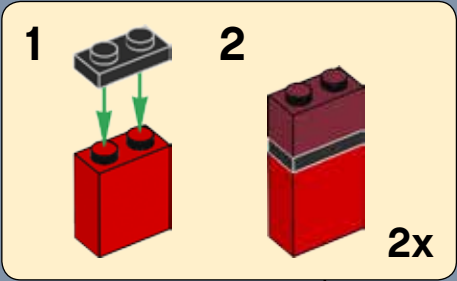

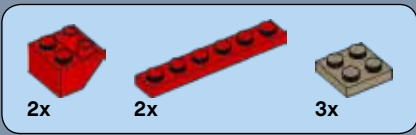

79

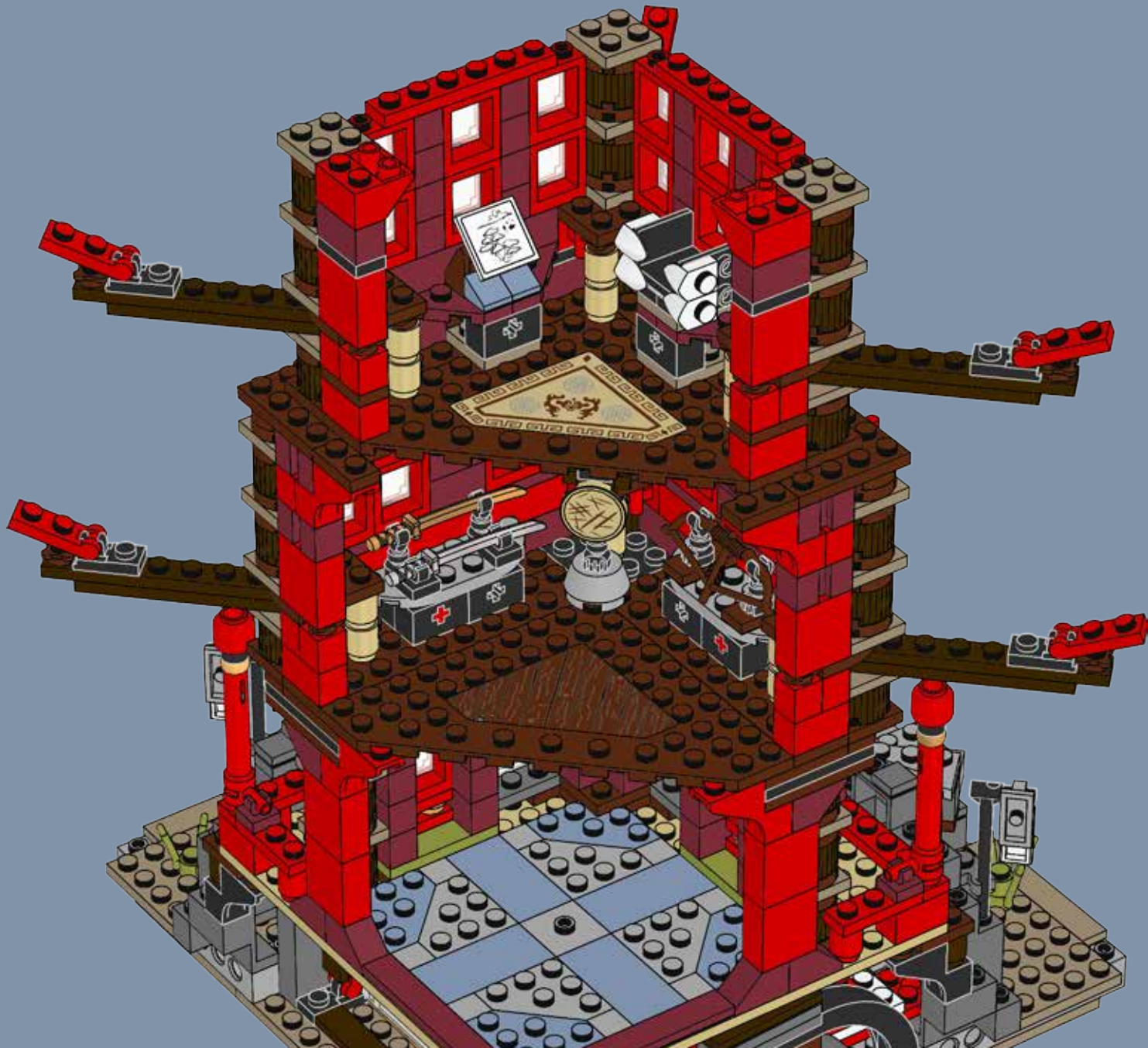





80



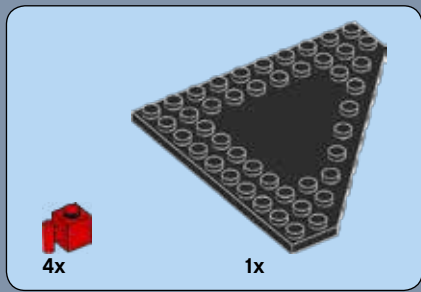

81



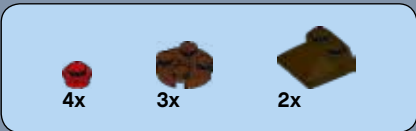

82





4x



3x



83





84



2x  4x 

85

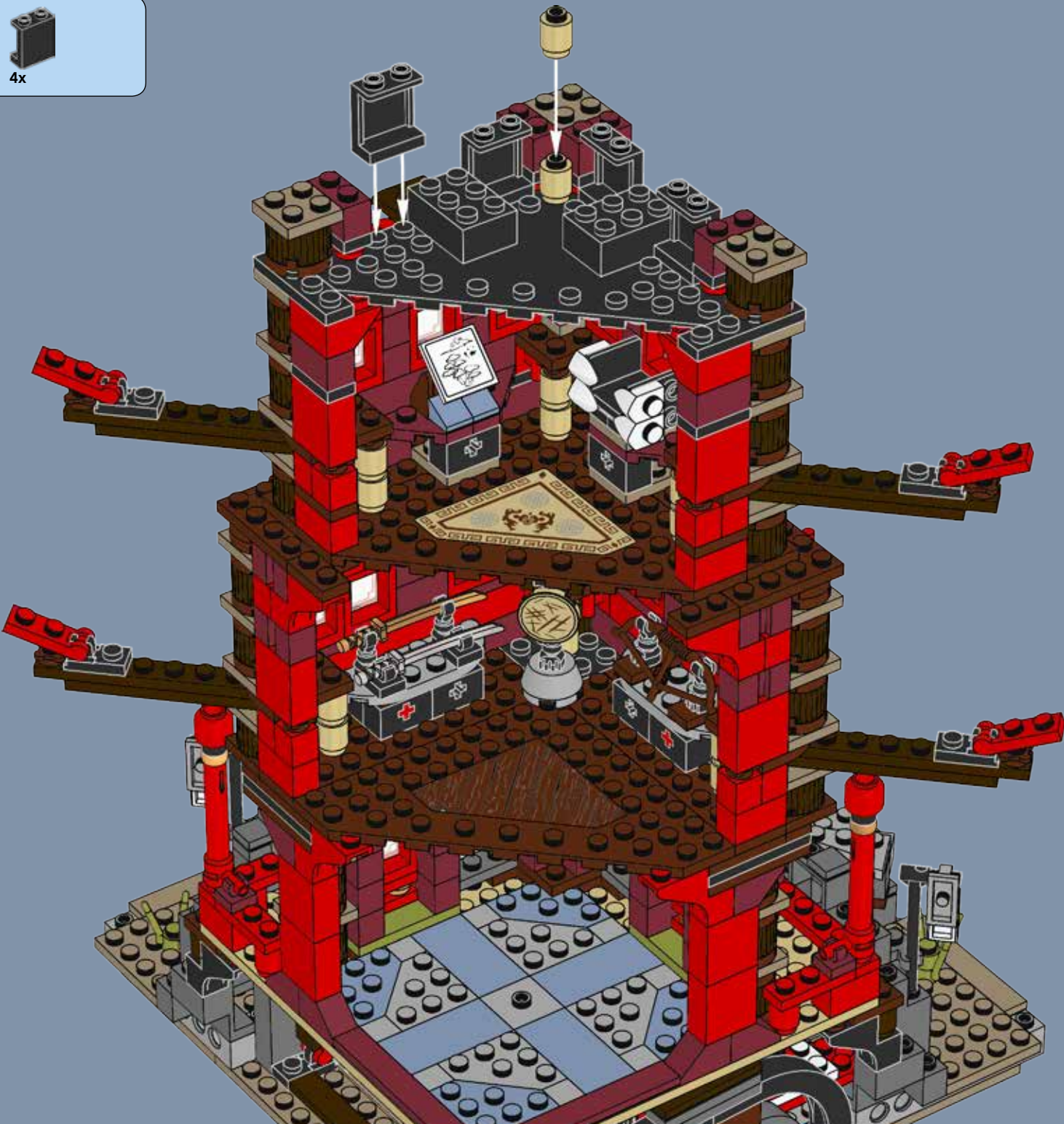



86

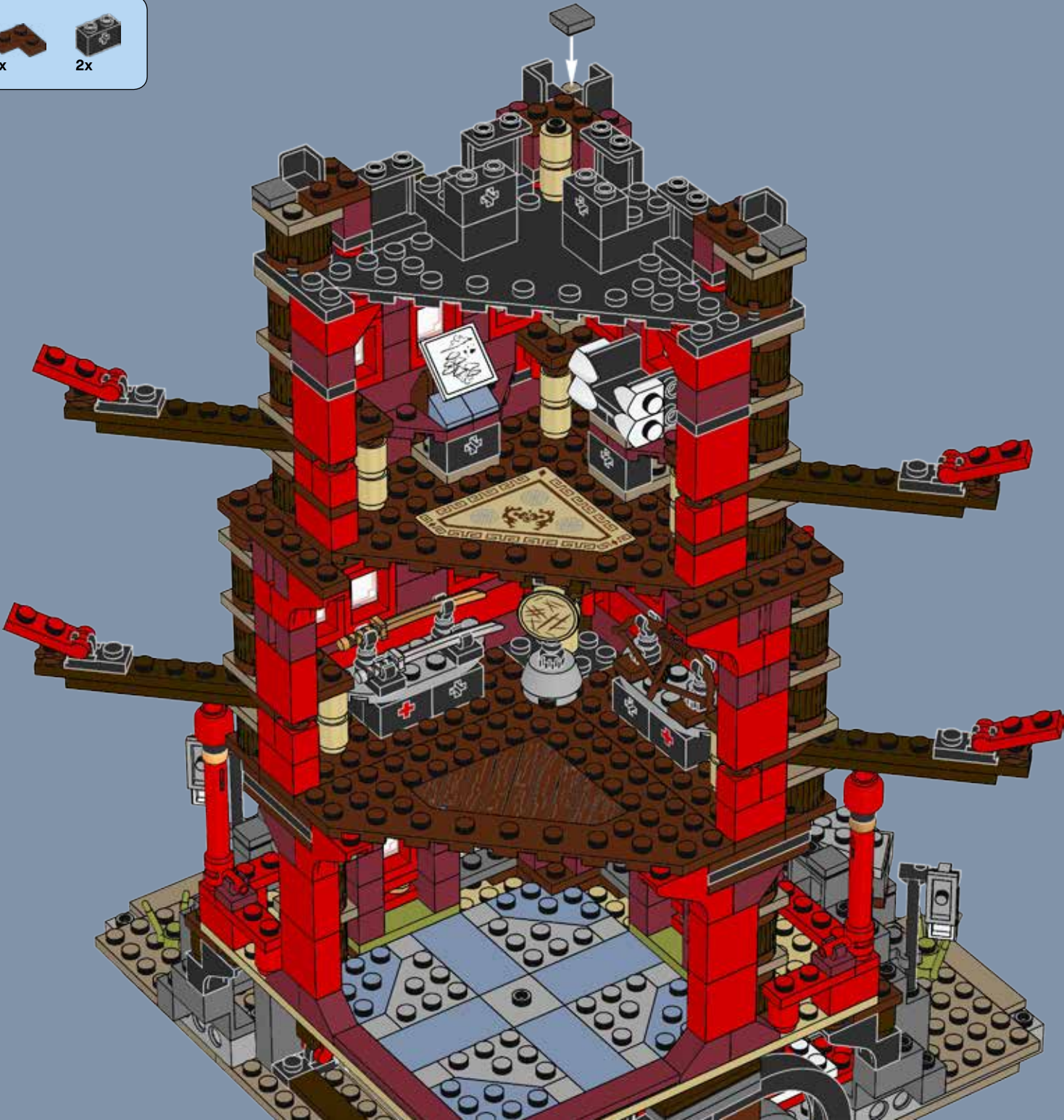

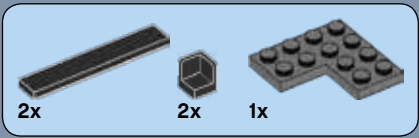

87



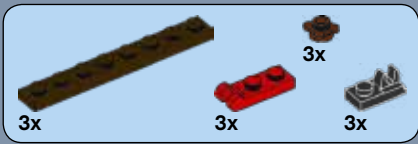

88

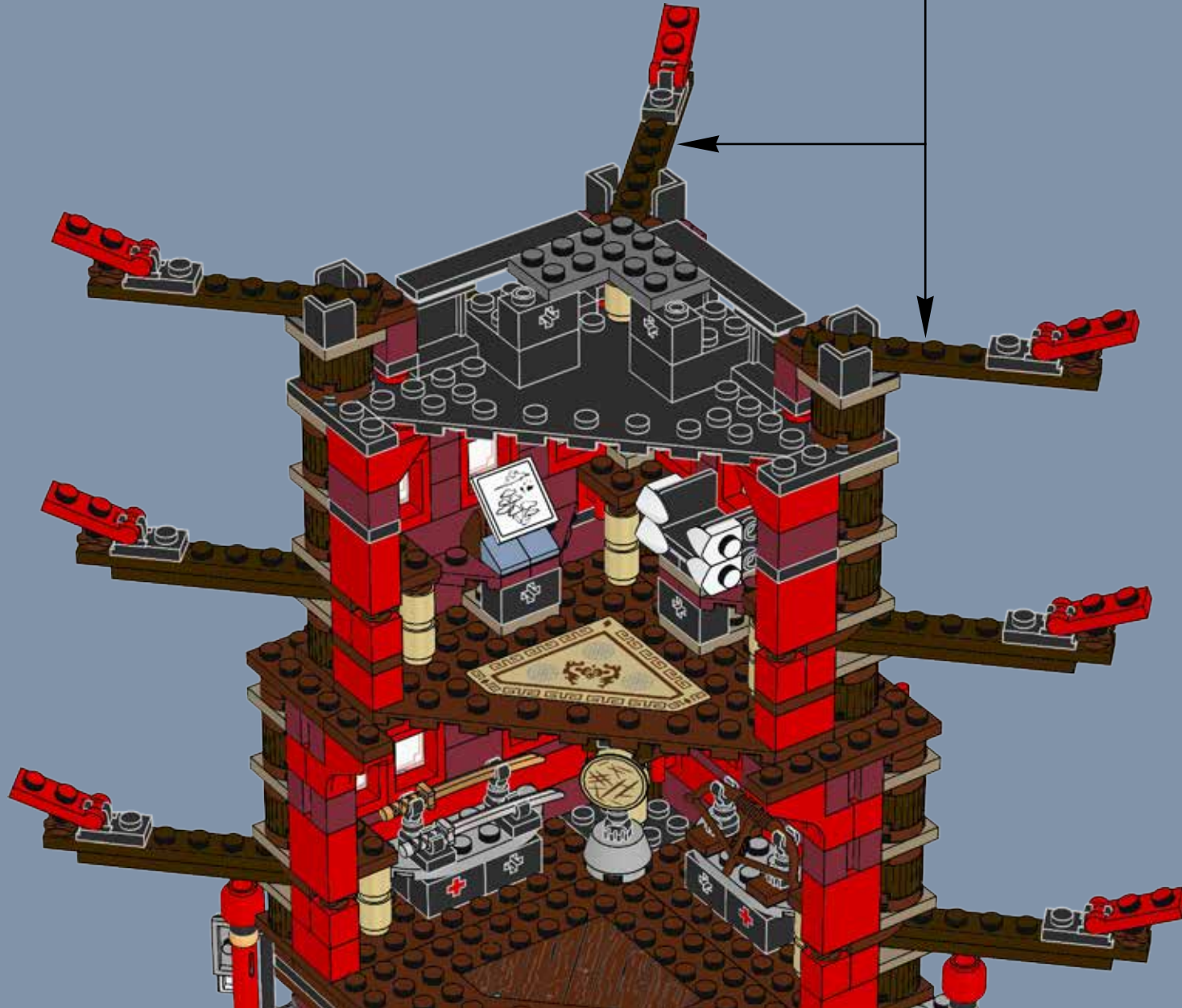
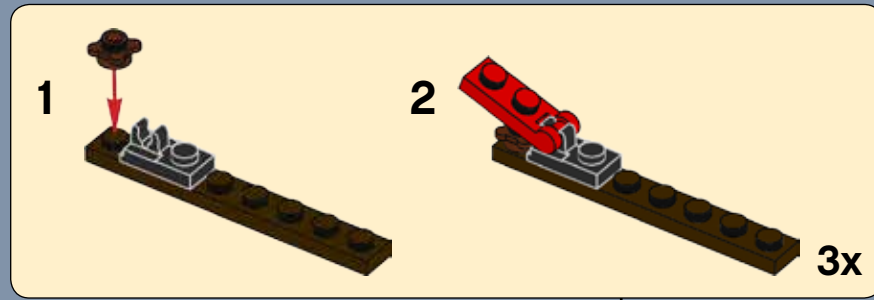



89

1



2

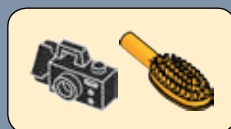

3

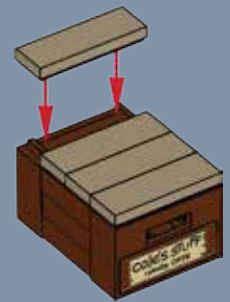

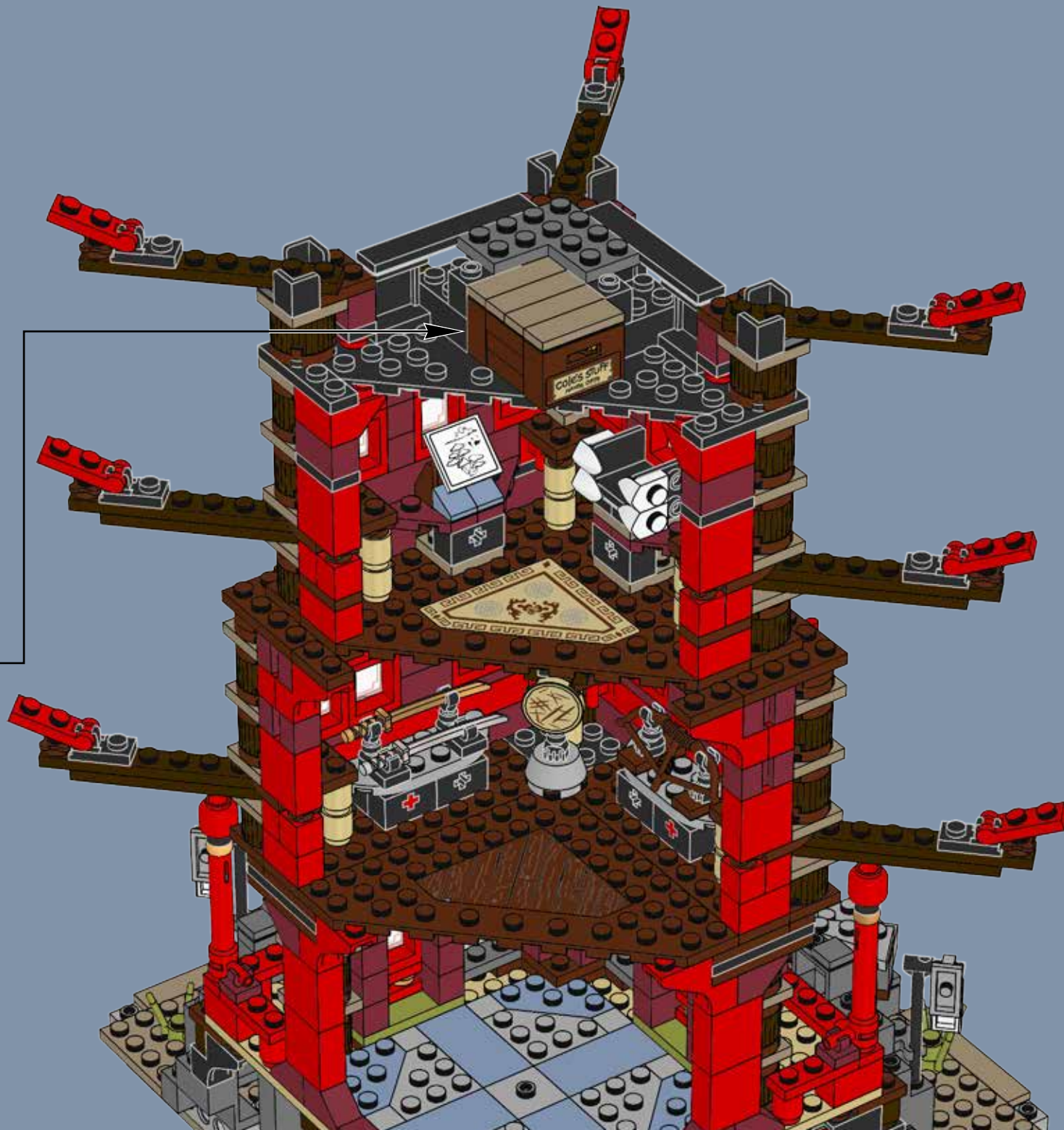

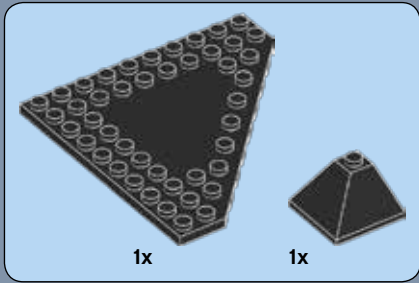
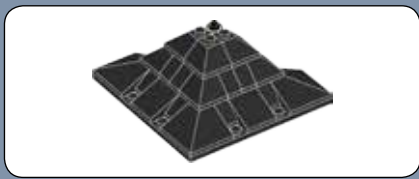

1

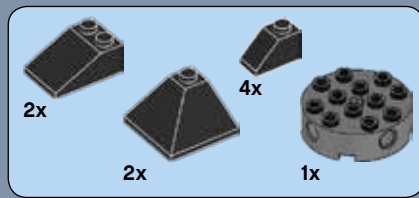
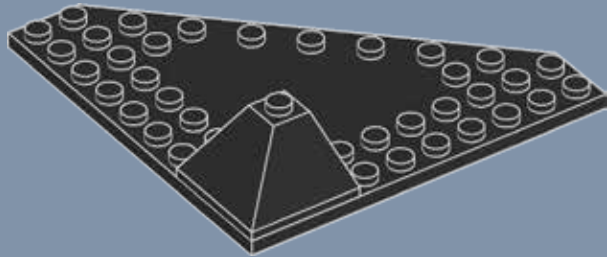

2

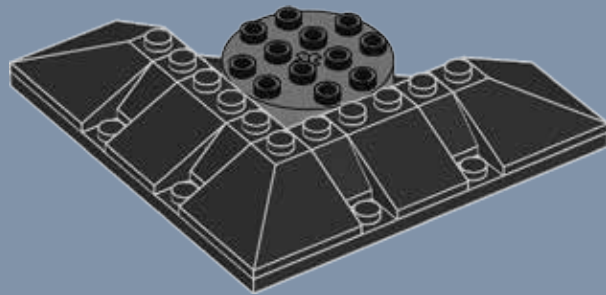



3

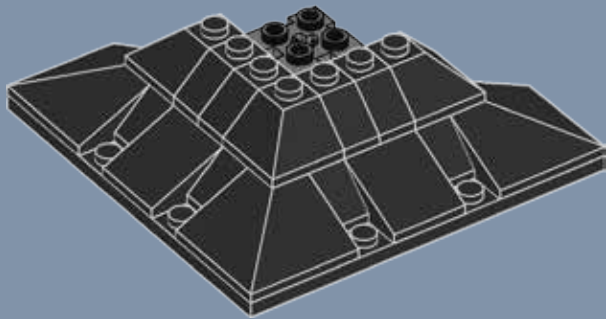

4

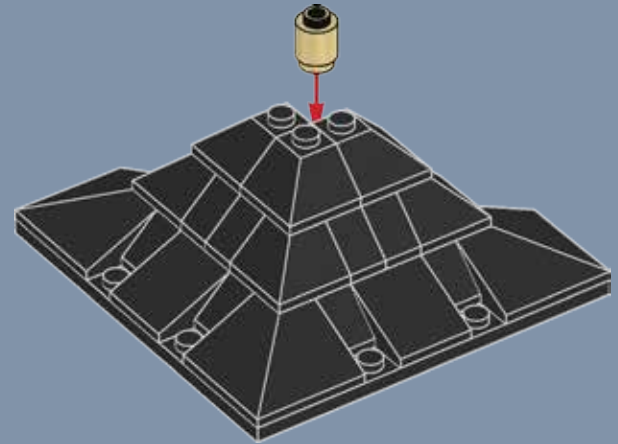

90



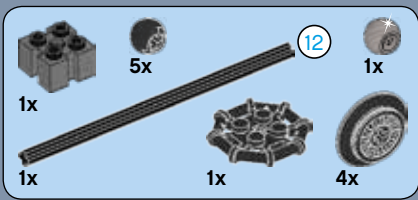

91

1

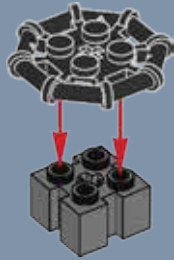

2

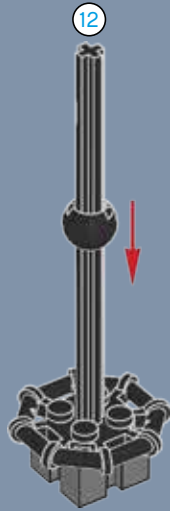

3

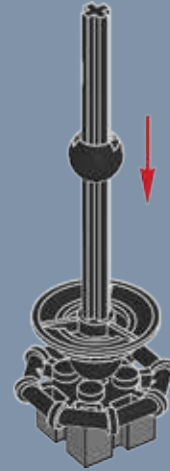

4







92



1x  1x  4x 

93



1  2 



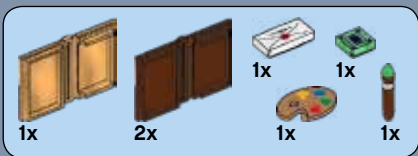

94

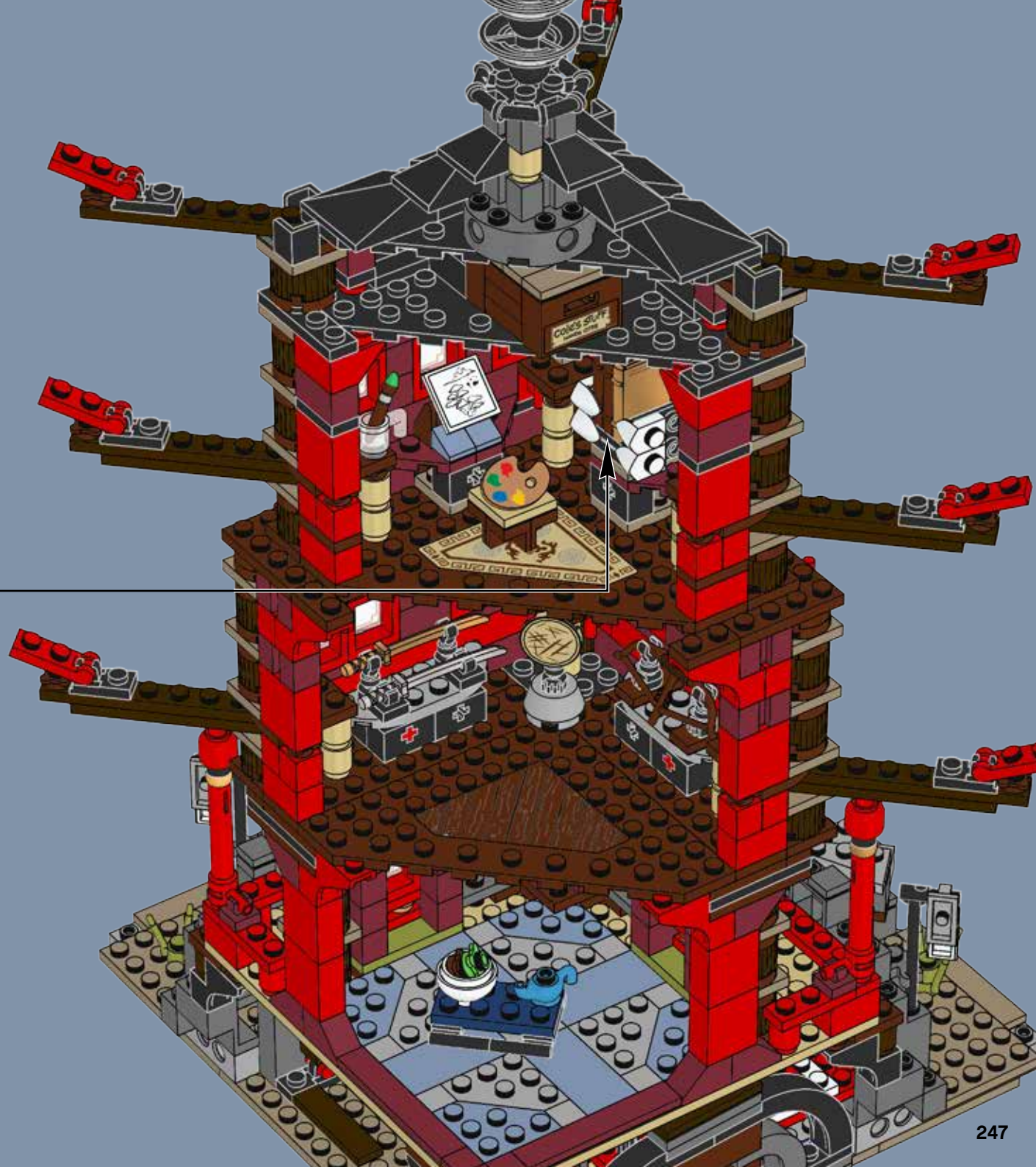
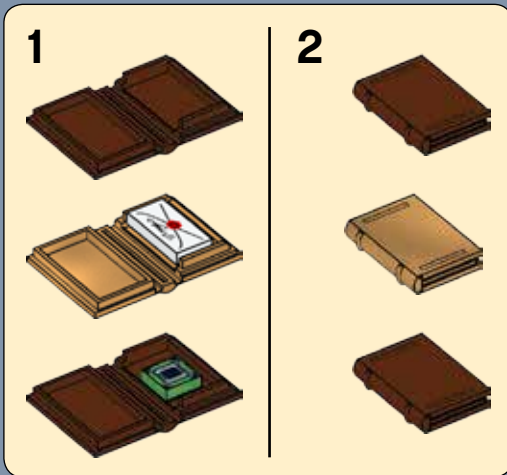

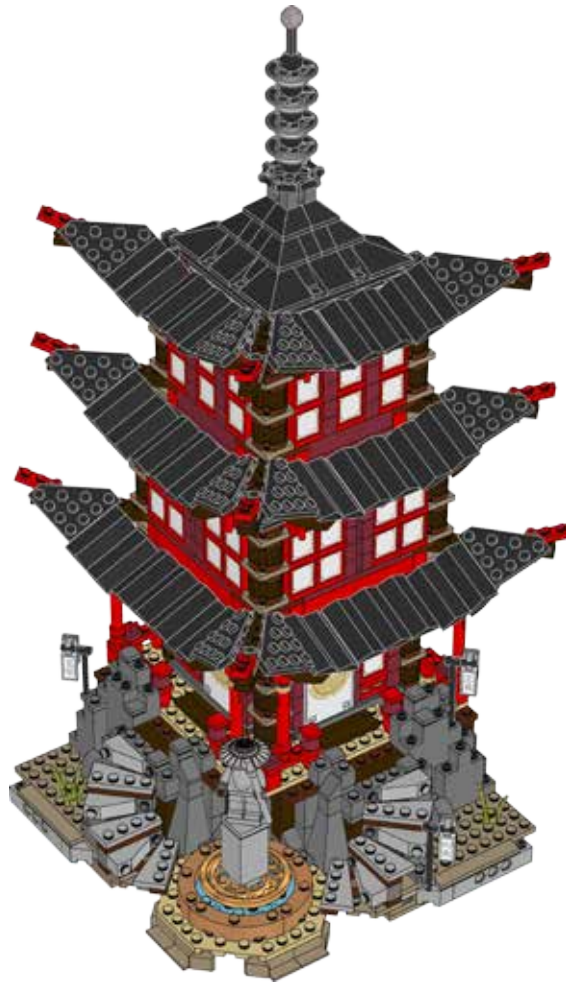

1



2

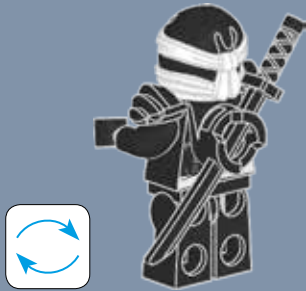

3

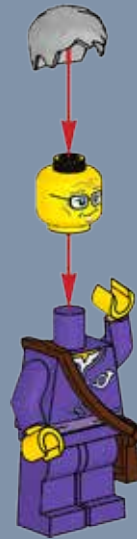

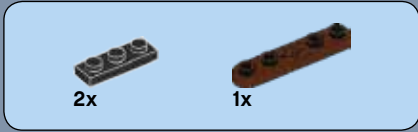
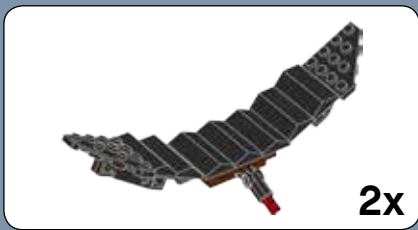

1

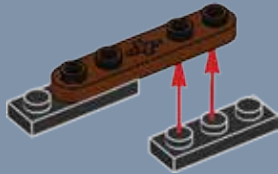

2



3

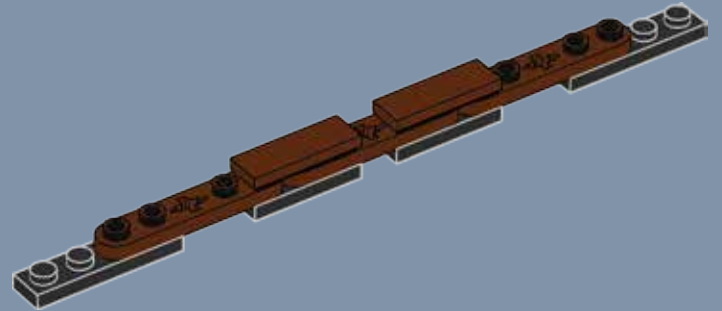

4

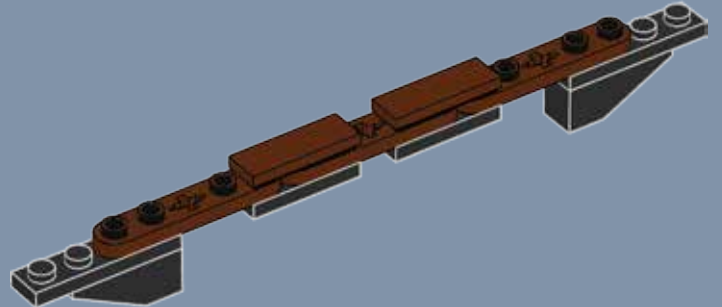



5

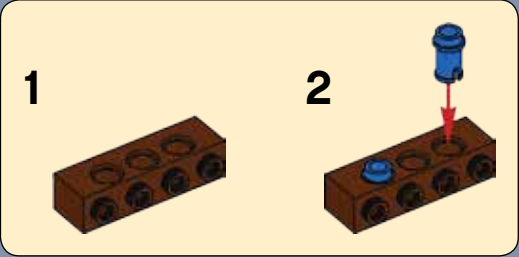
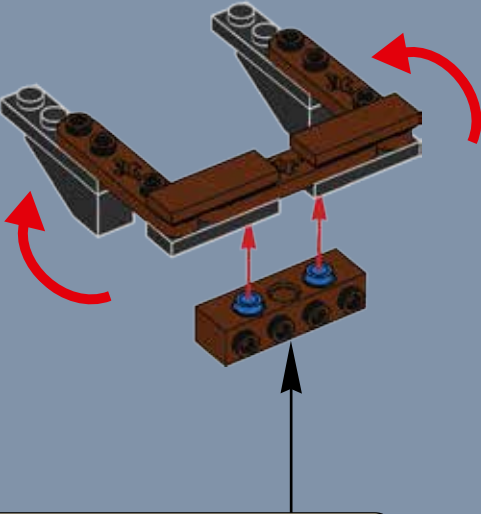

6

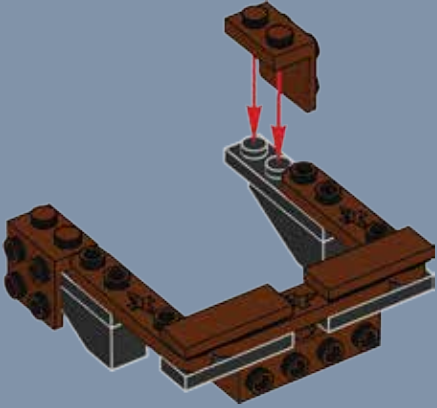

7

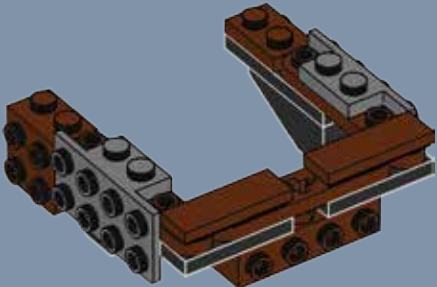



8

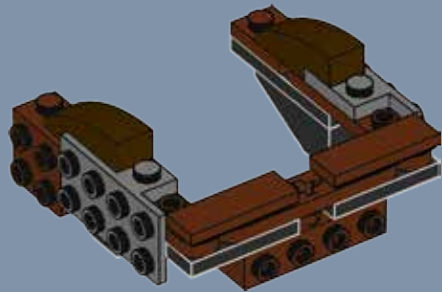

10

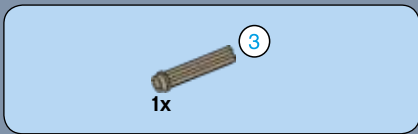
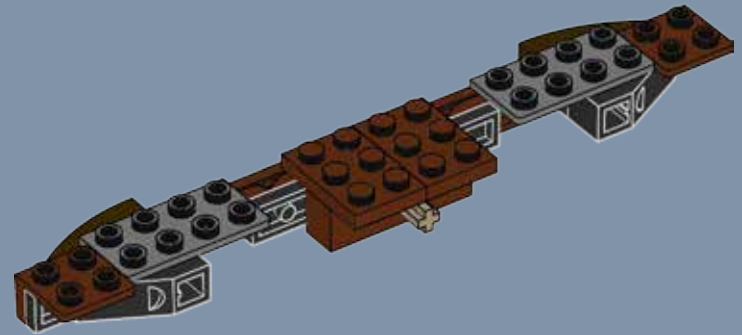

9

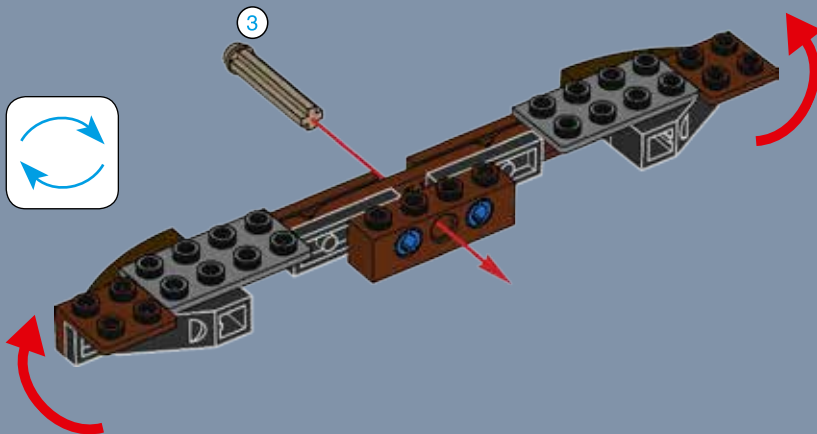
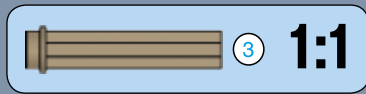

11

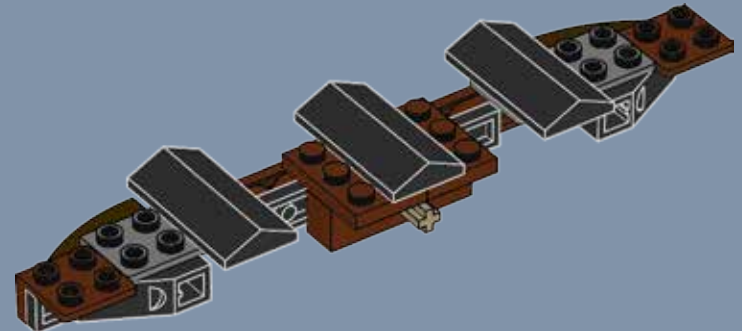



12

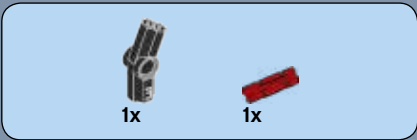
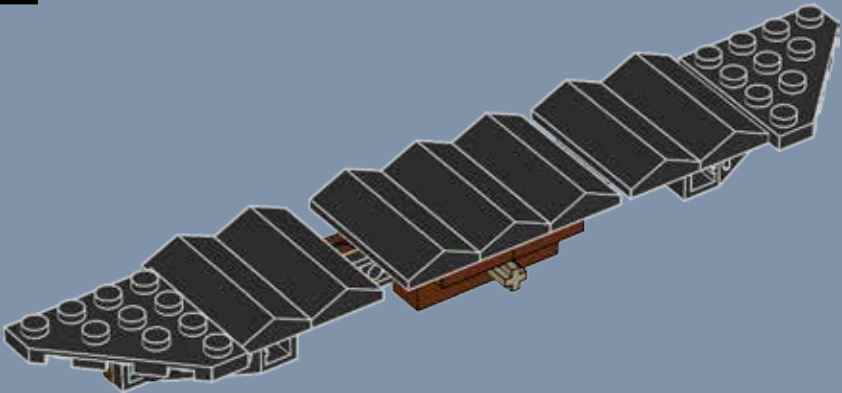

13

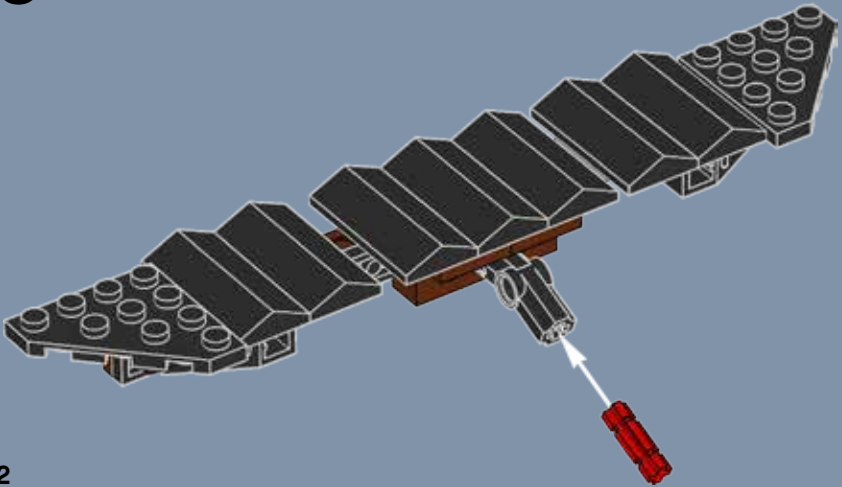

14

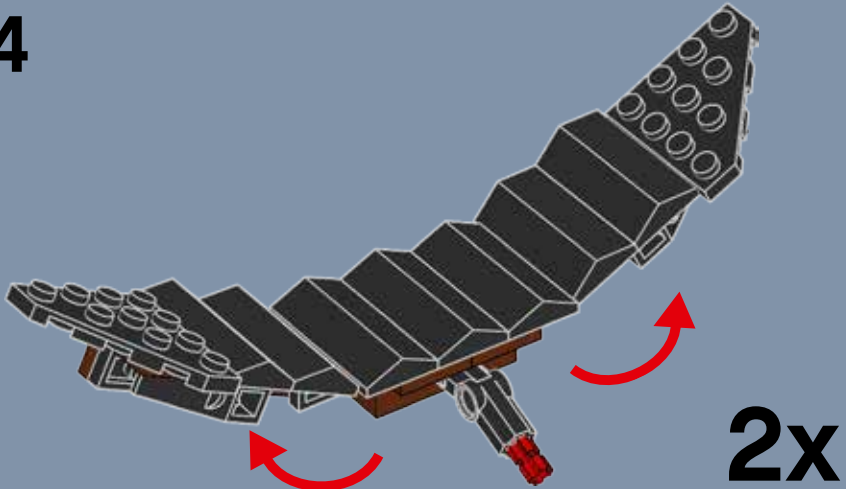

95

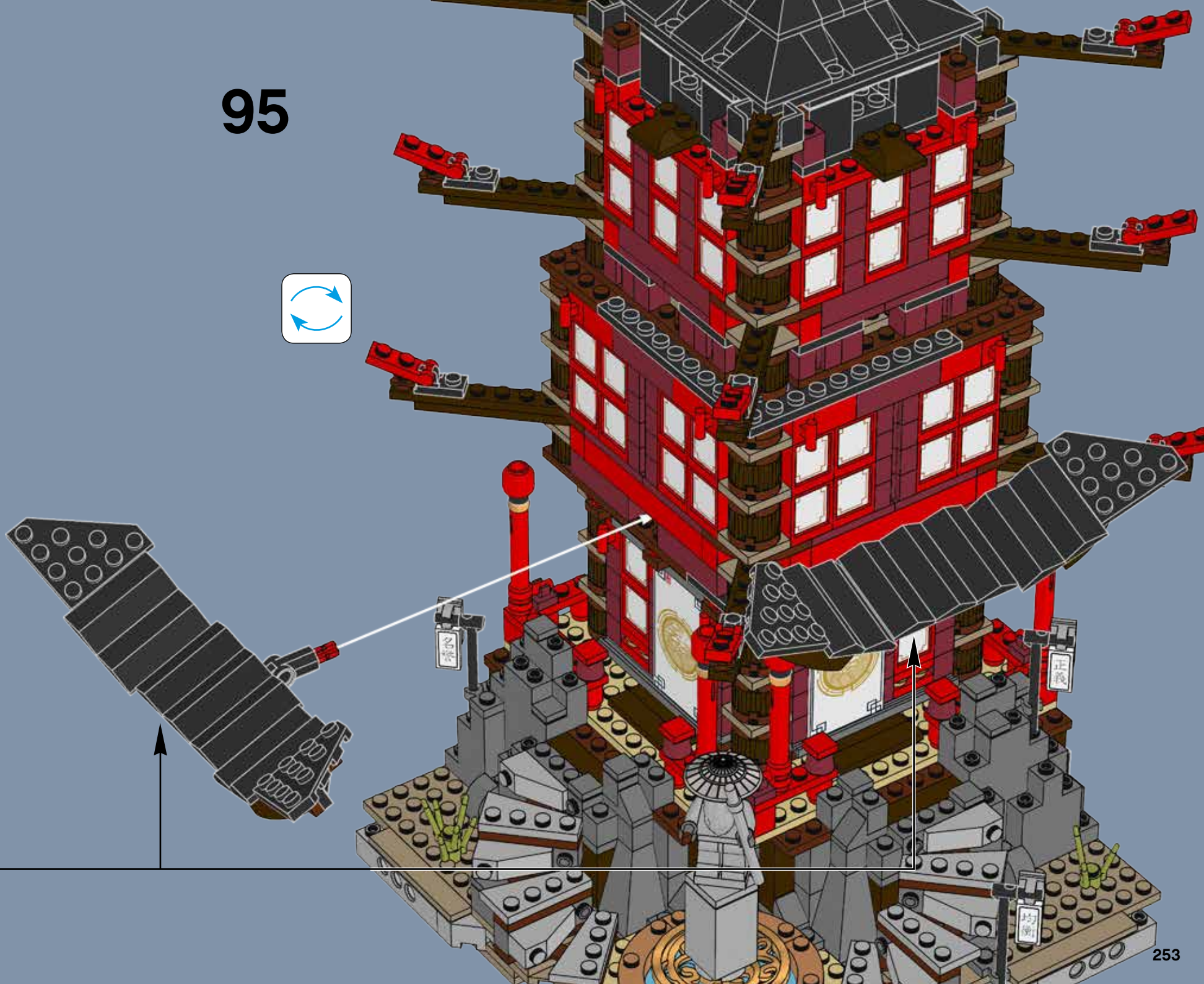

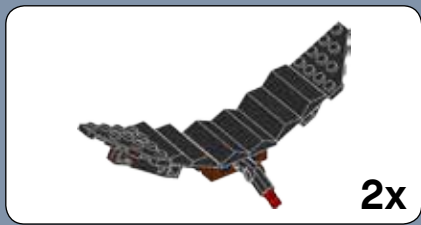

1



2

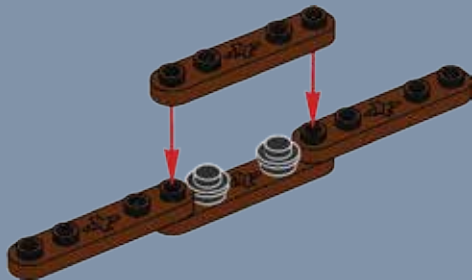

3



4





5

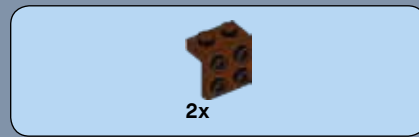
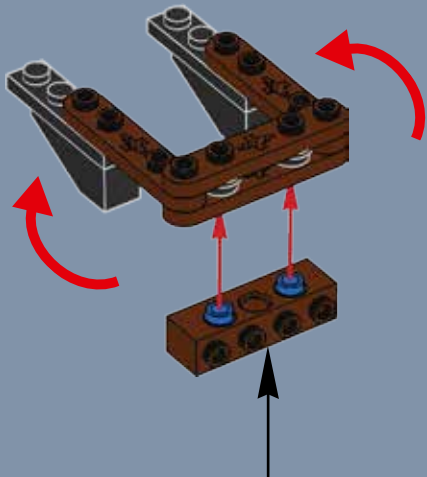

6

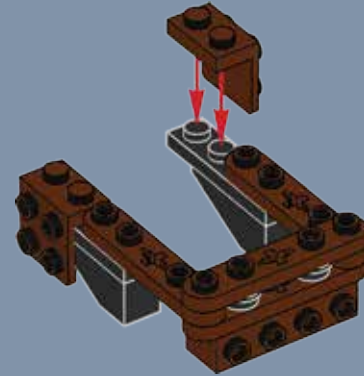

7

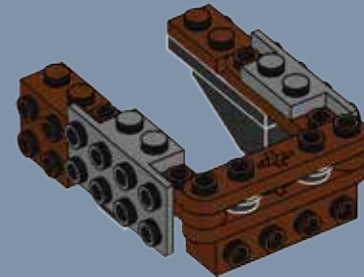



2x

8

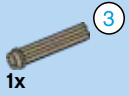
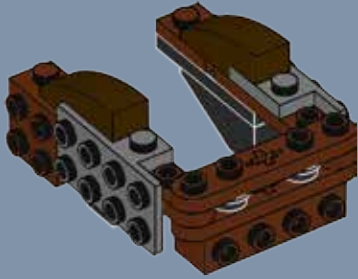

1x

3



3

1:1

9

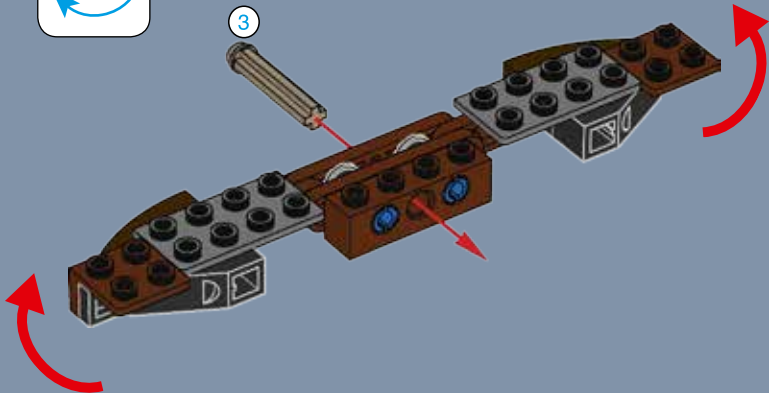

2x

10

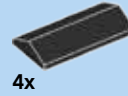

4x

11

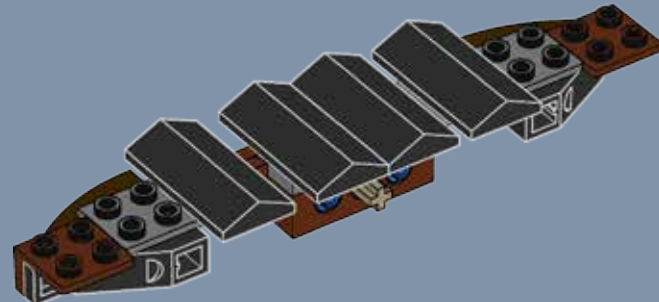



12

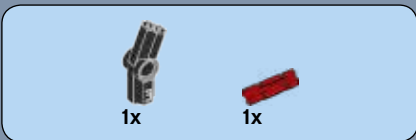
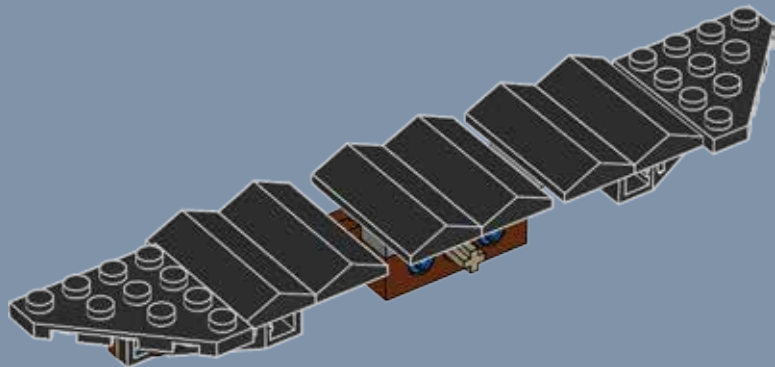

13

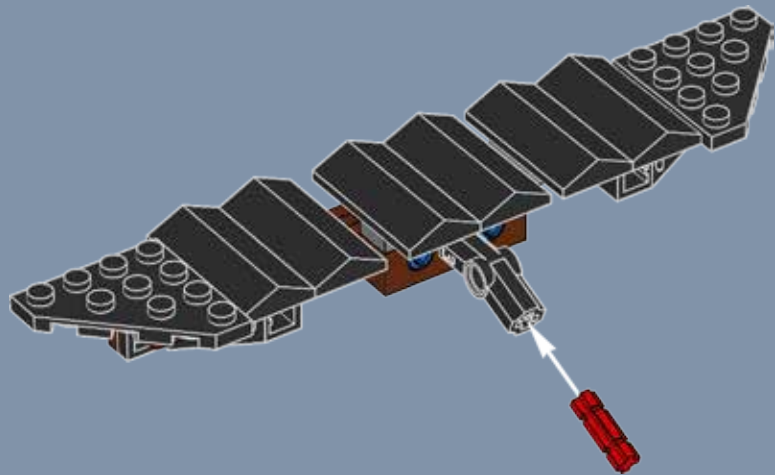

14

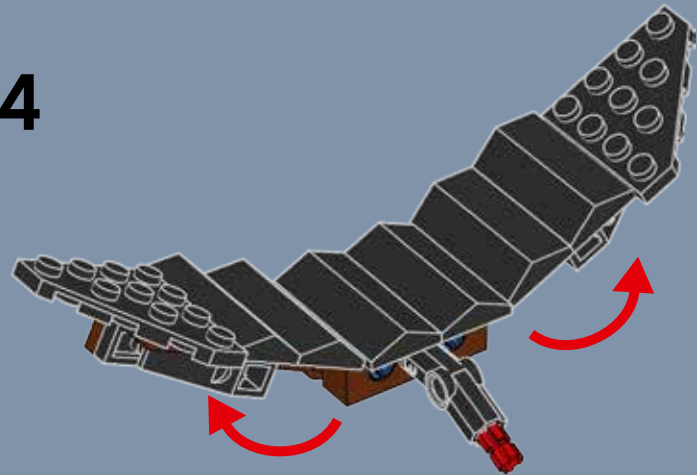

2x

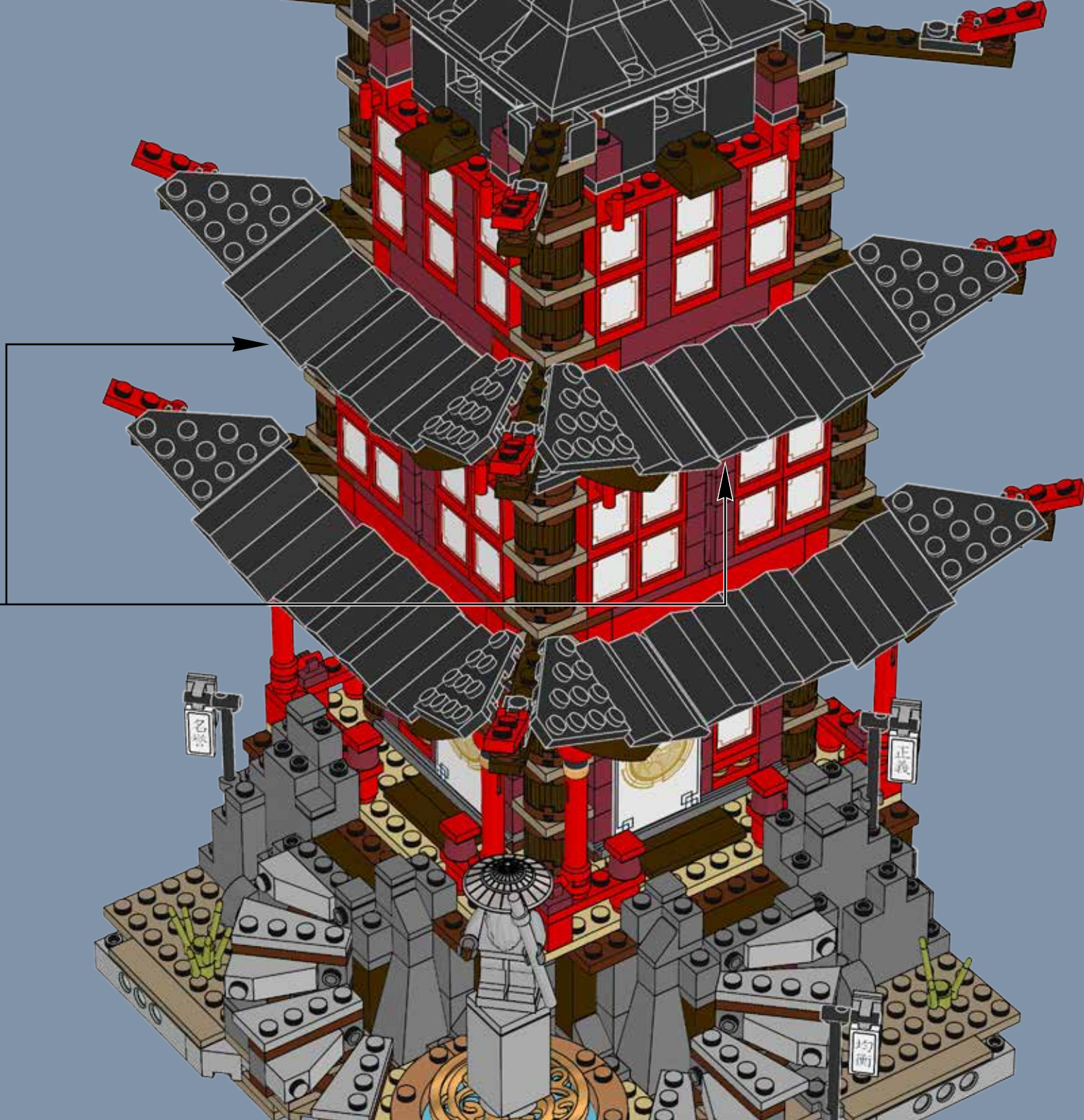

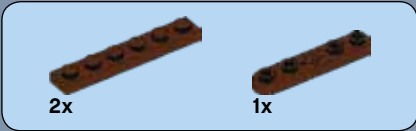

1

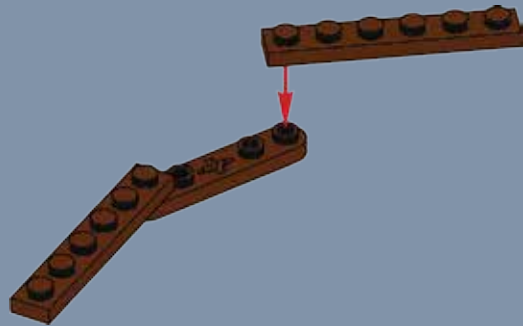

2



3

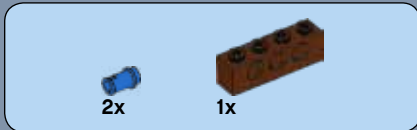

4

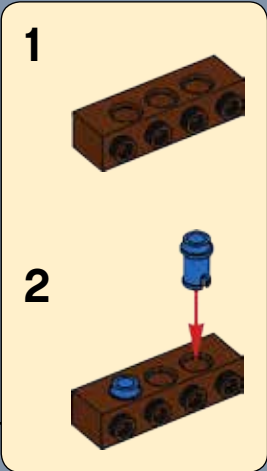
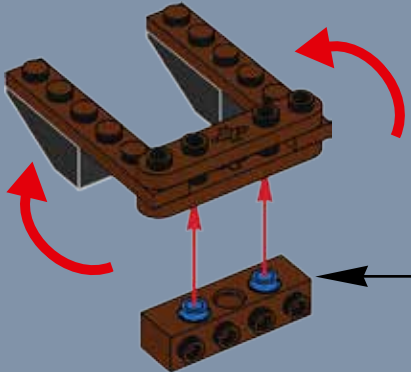



5

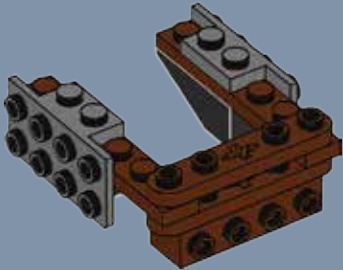

6

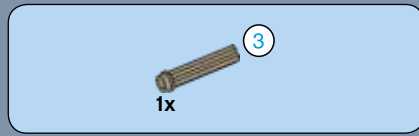
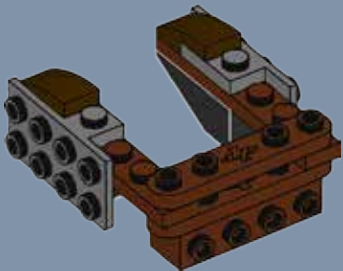

7

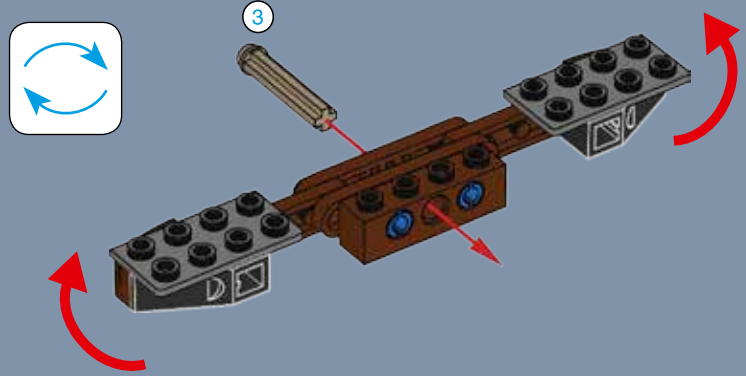

8

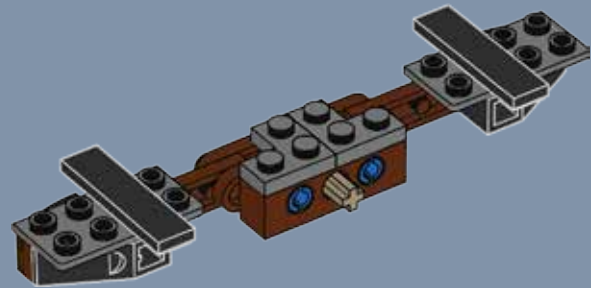



9

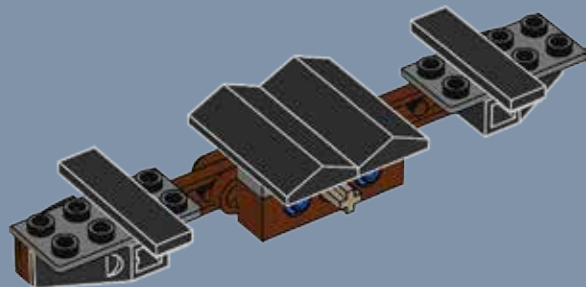

10

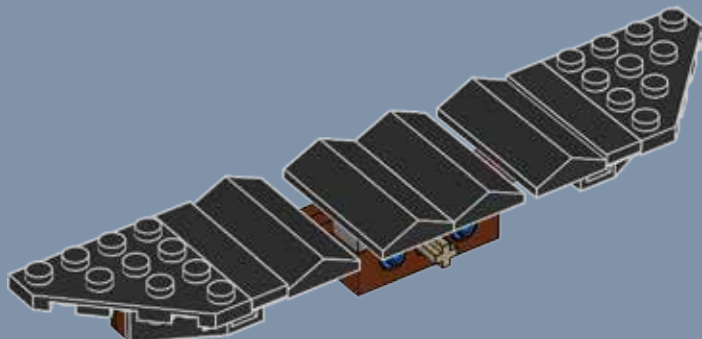

11

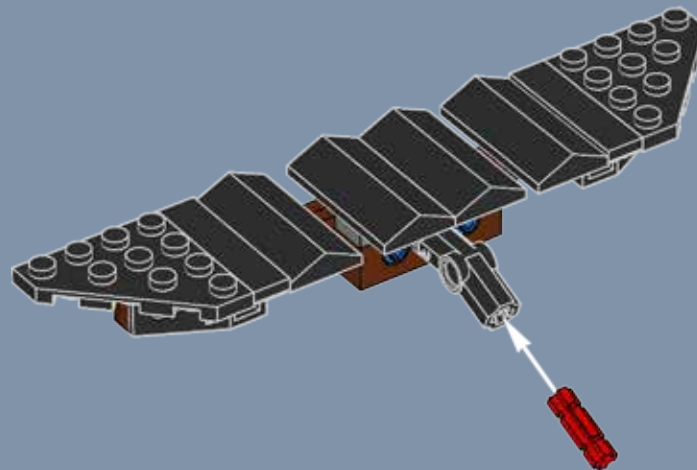

12

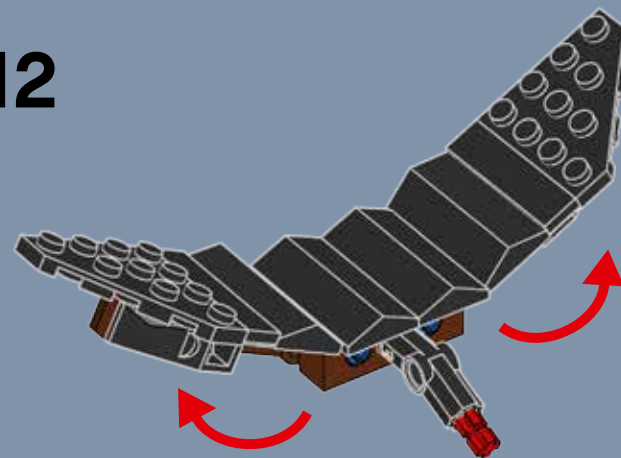

2x

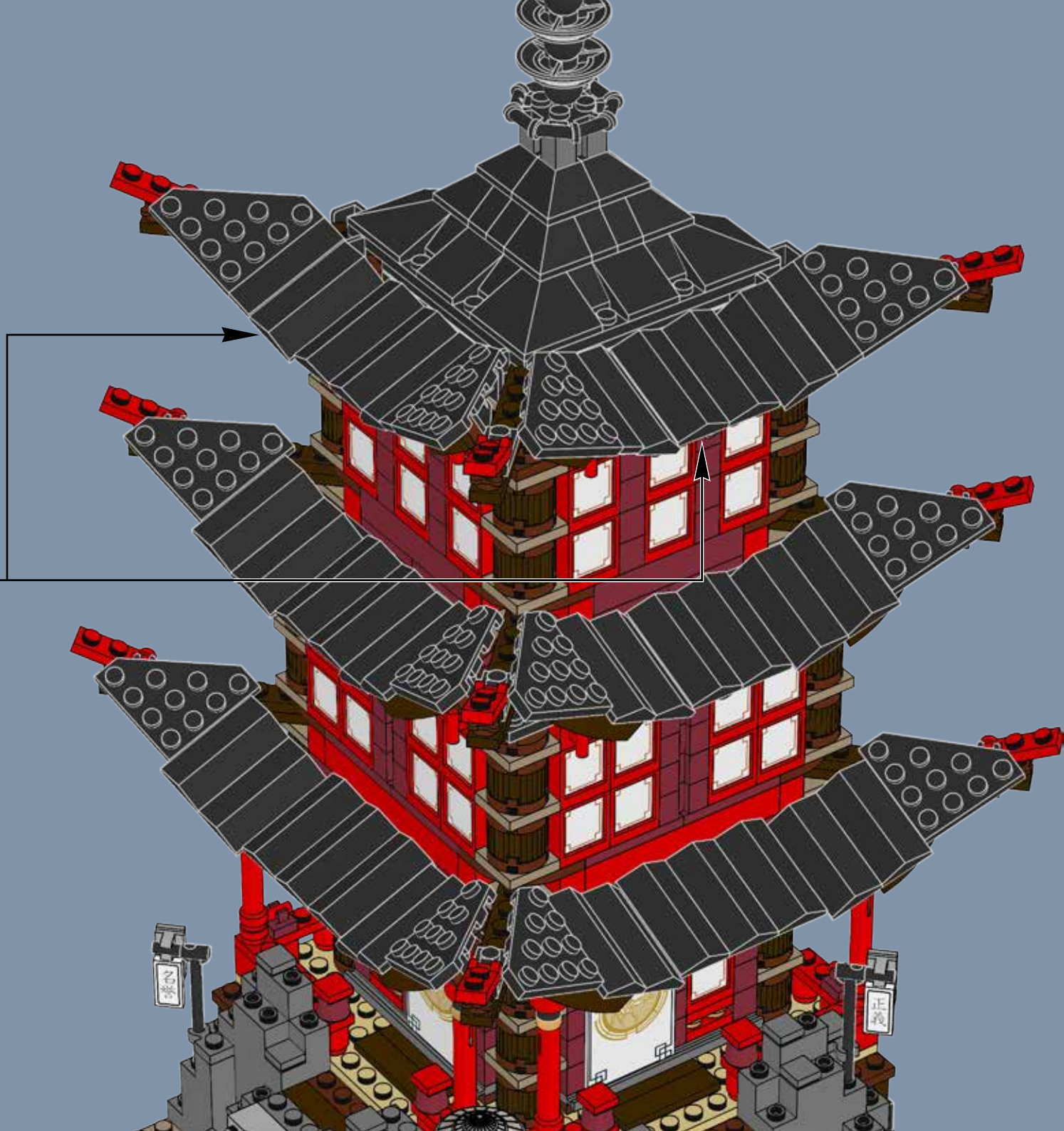

98

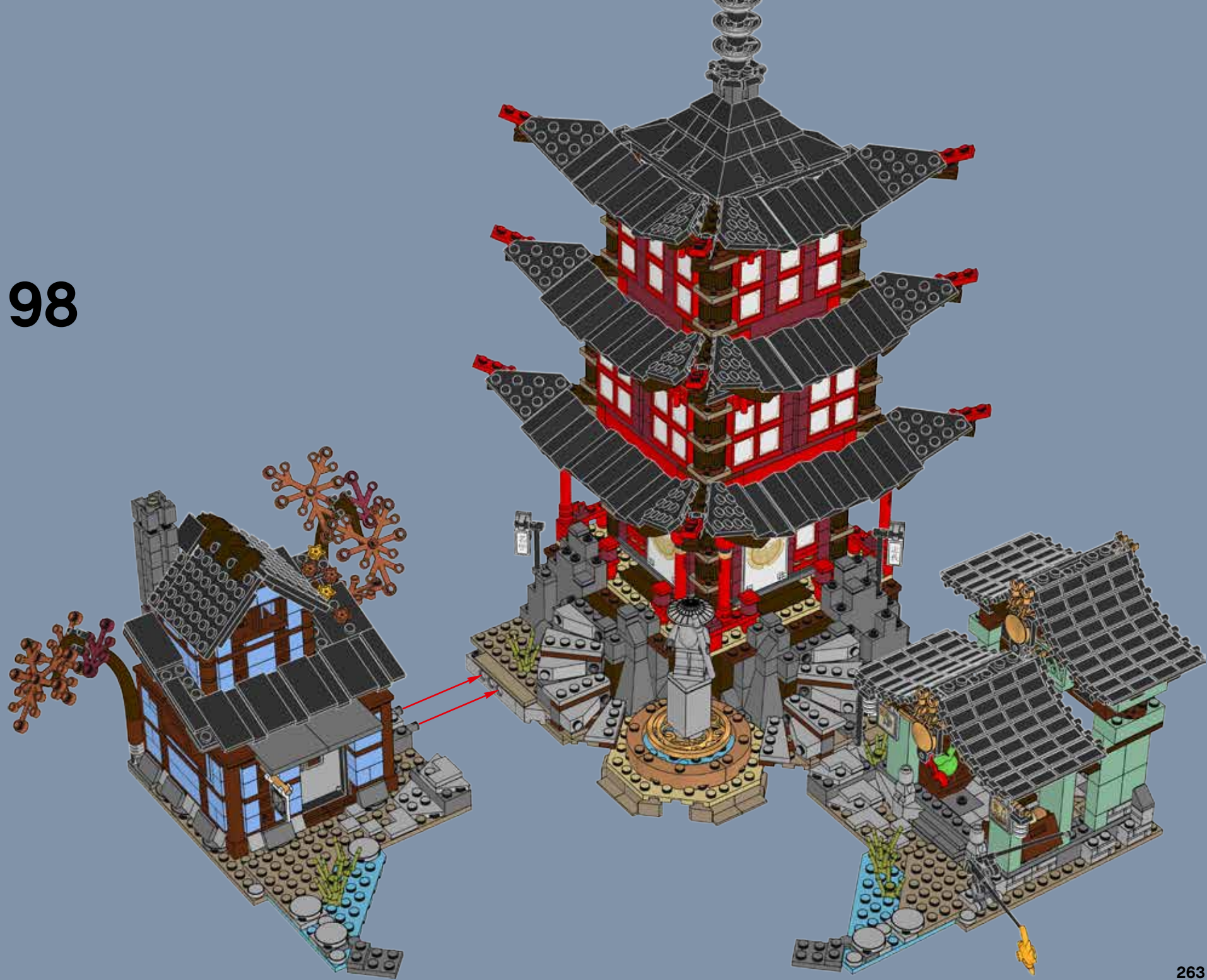



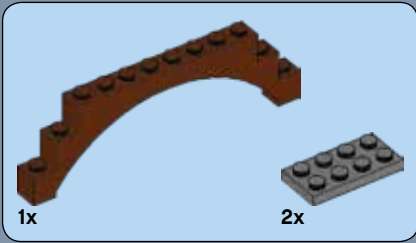

1

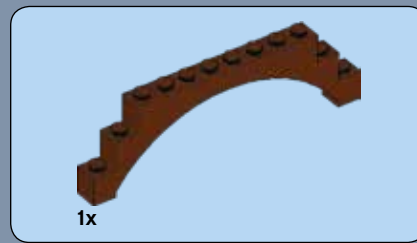
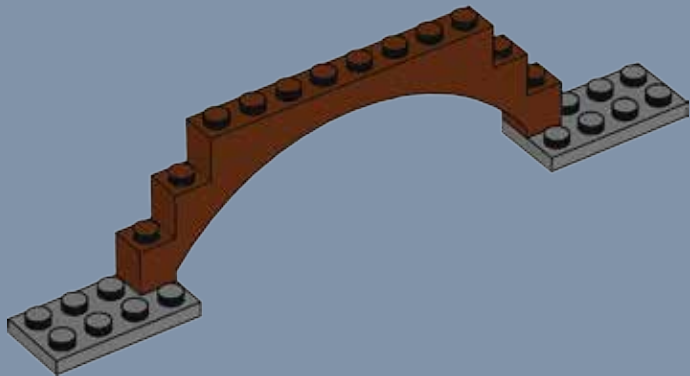

2

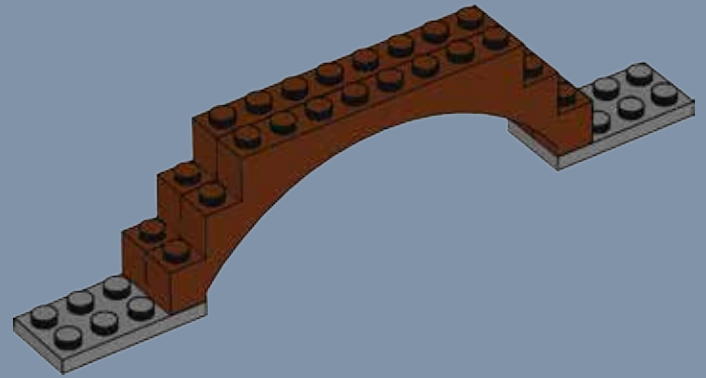

3

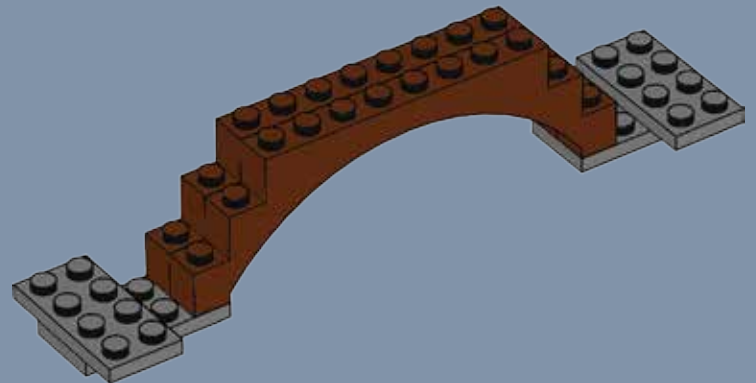

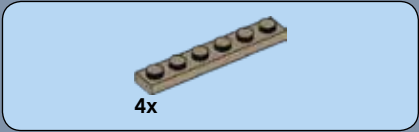

4

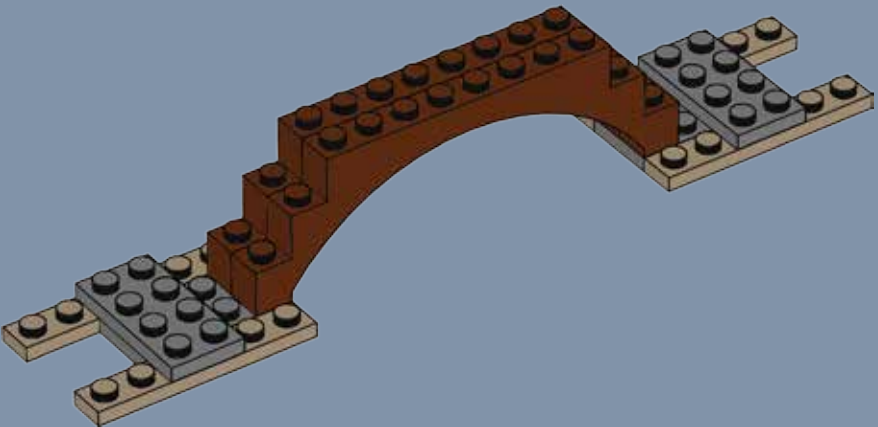

5

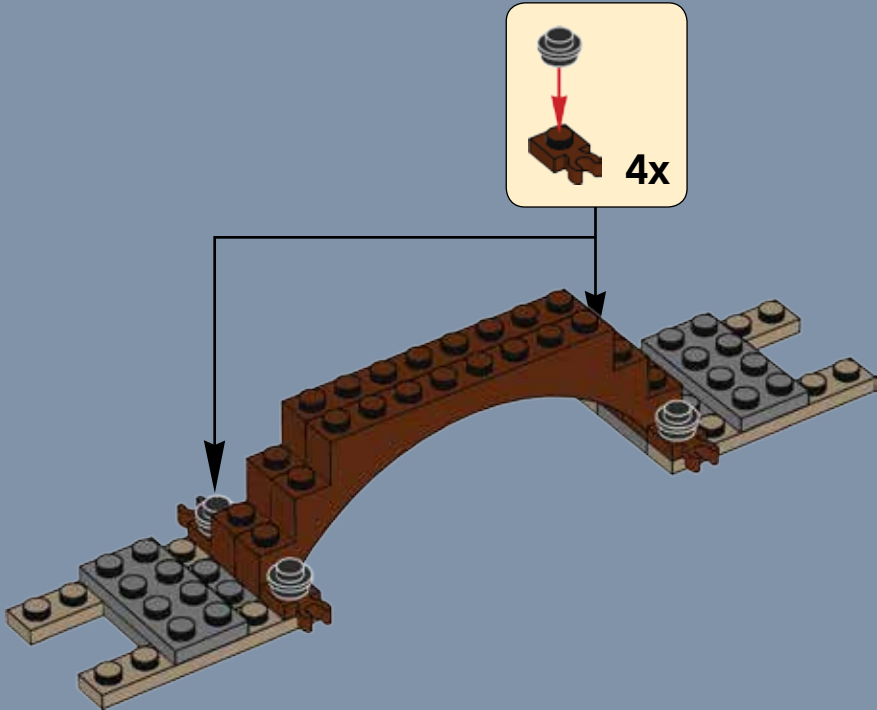



4x

6

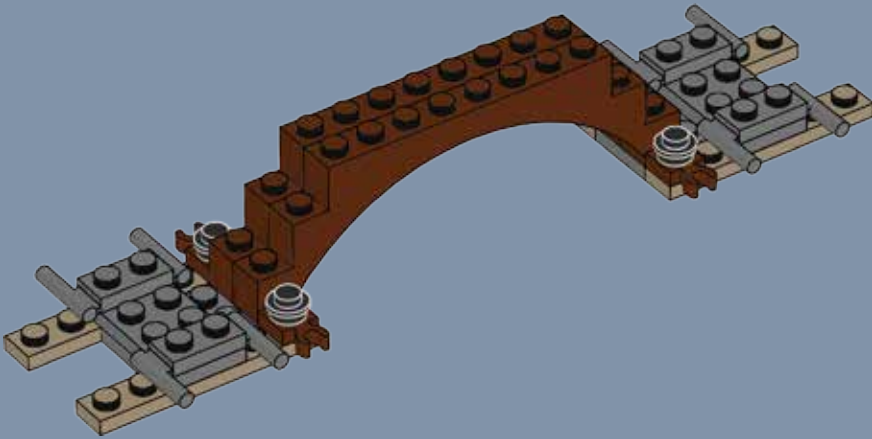

4x

7

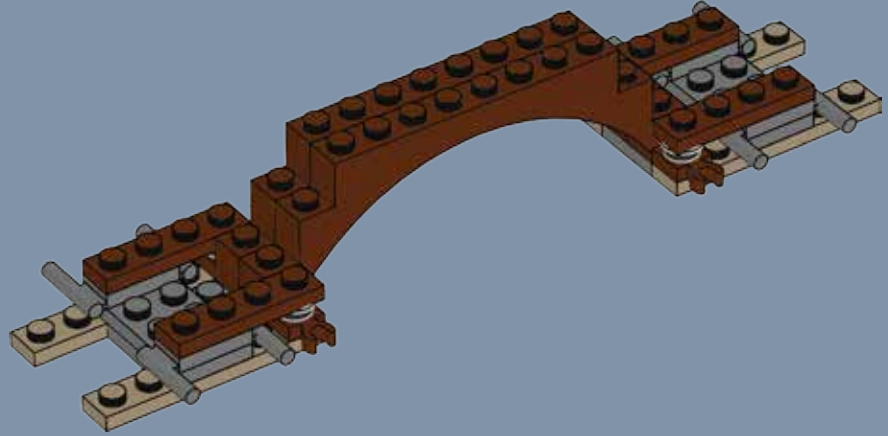

2x

8

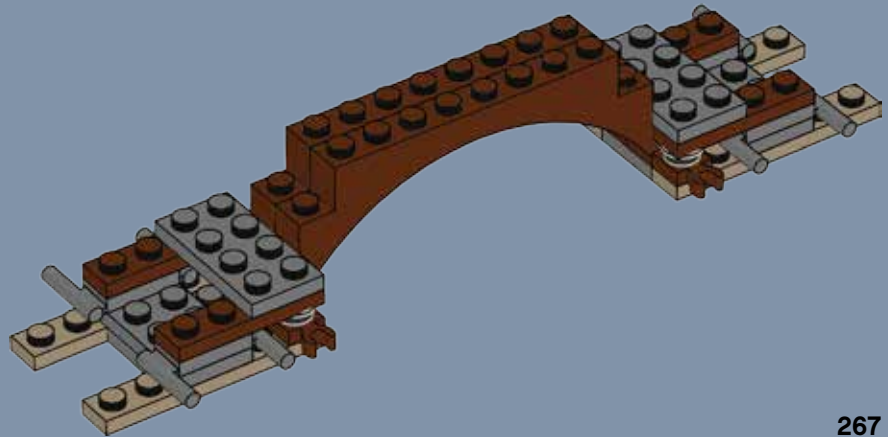



4x

9

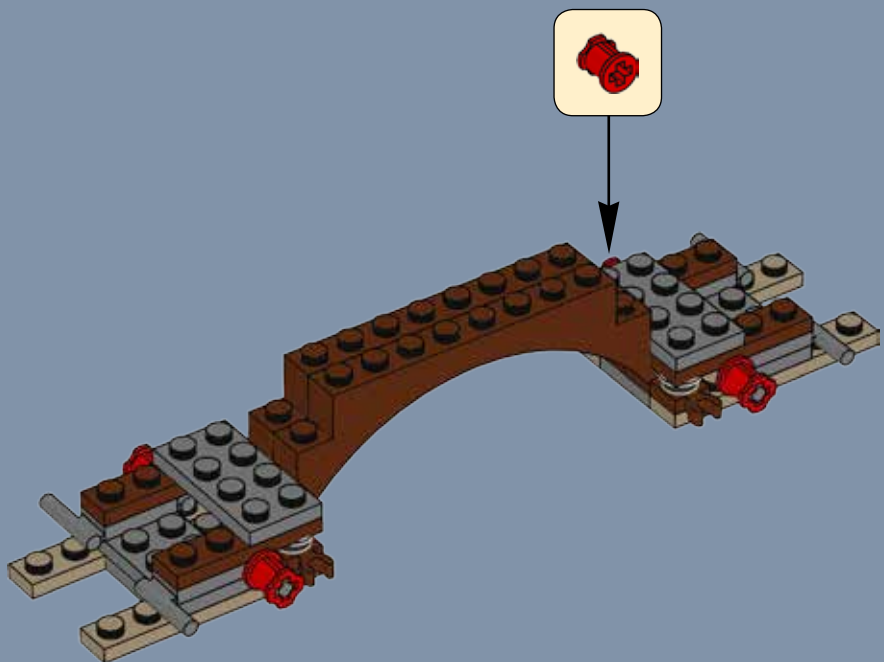

2x

10

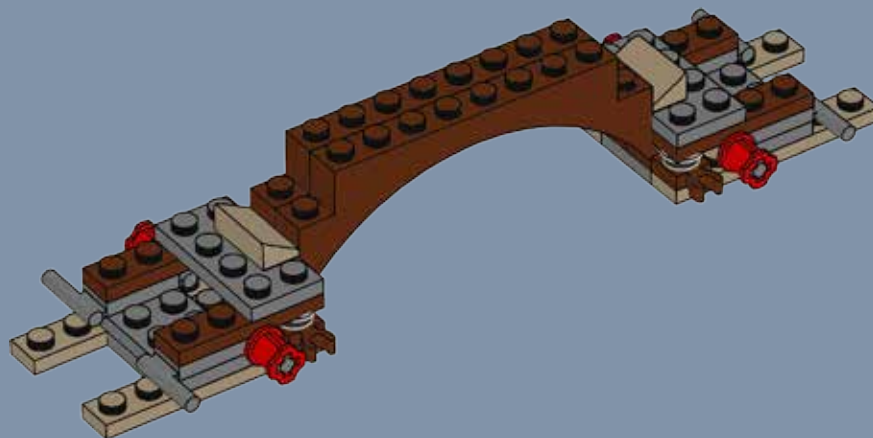



11

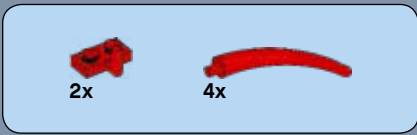
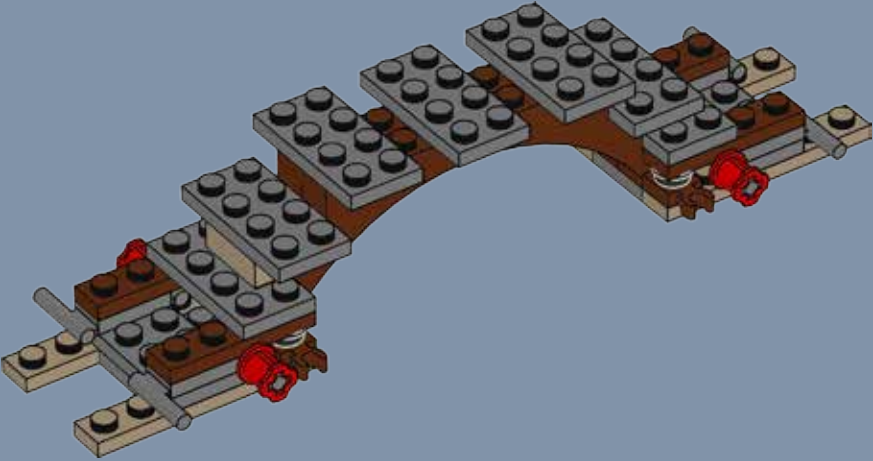

12

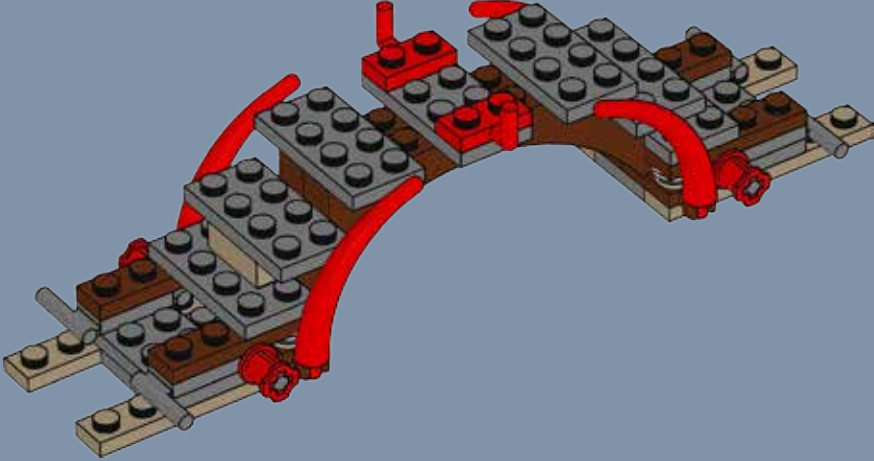

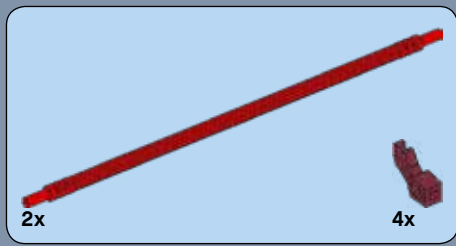

13

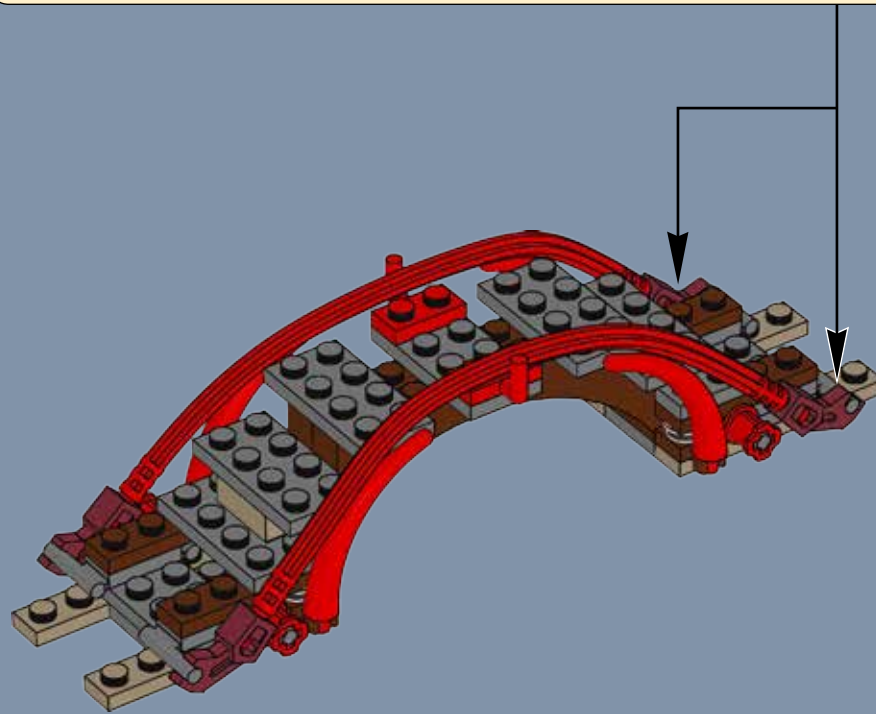
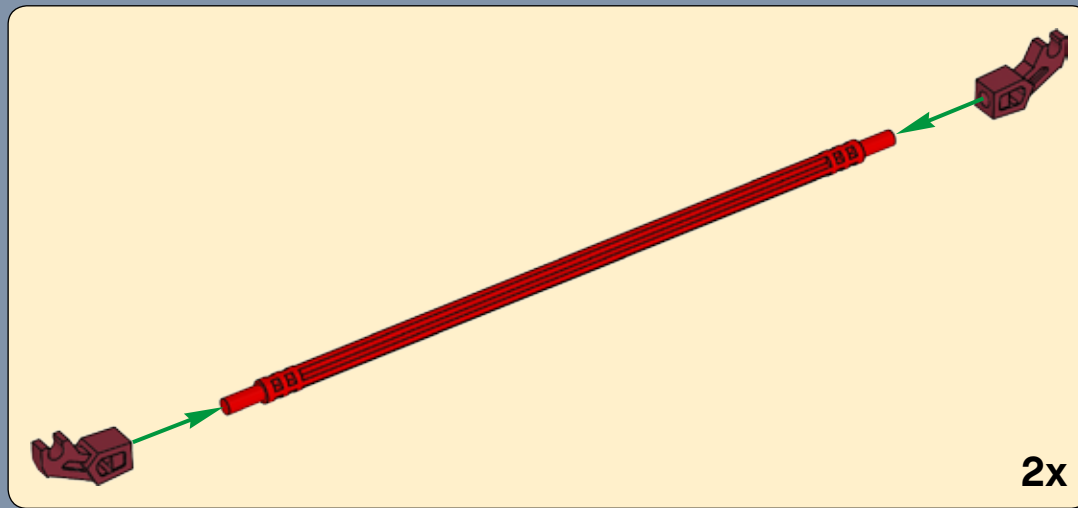



4x

14

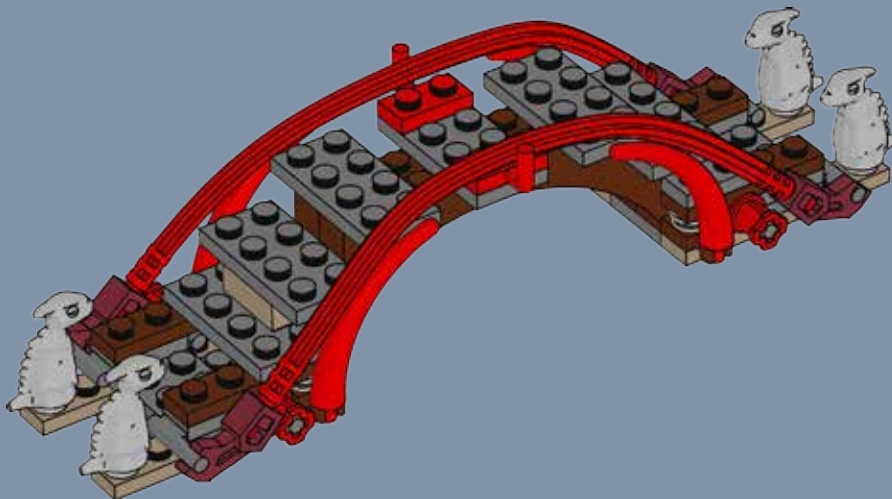

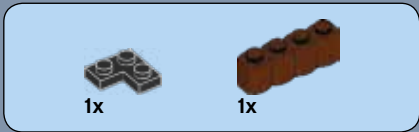

1

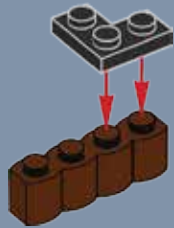

2



3

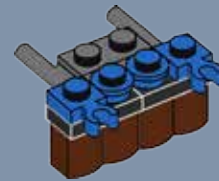

4

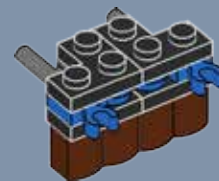



5



6

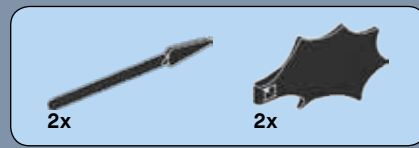
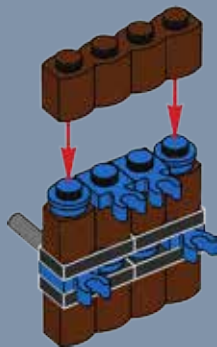

7



8

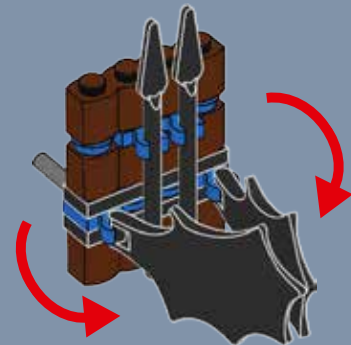



1



2

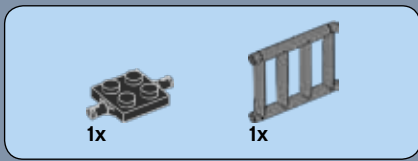
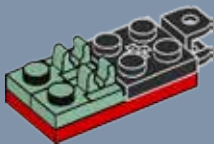

3

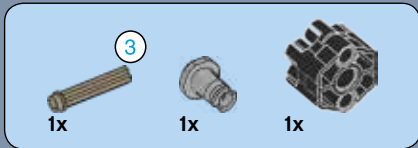
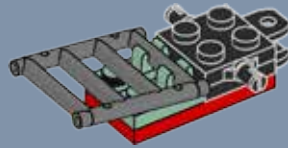

4

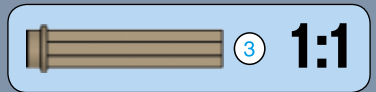
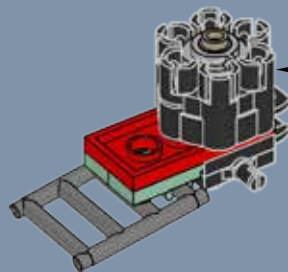
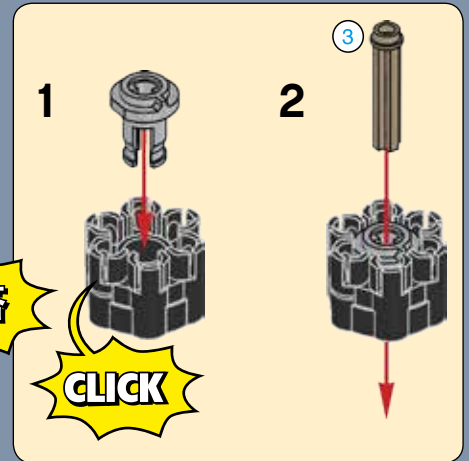

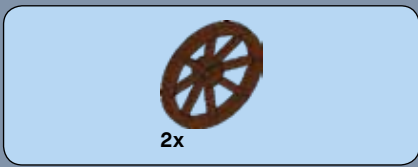

5

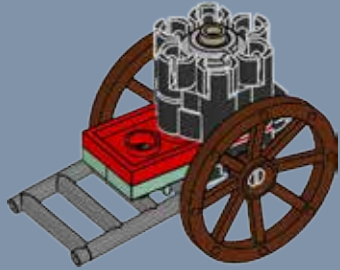

6

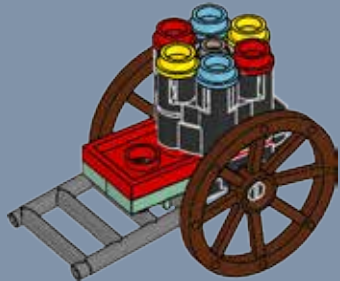

8

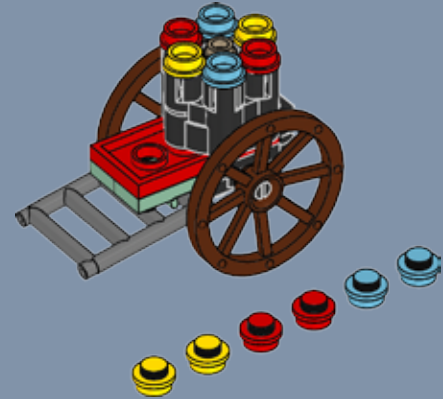

7

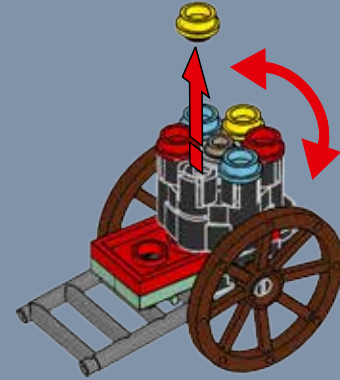

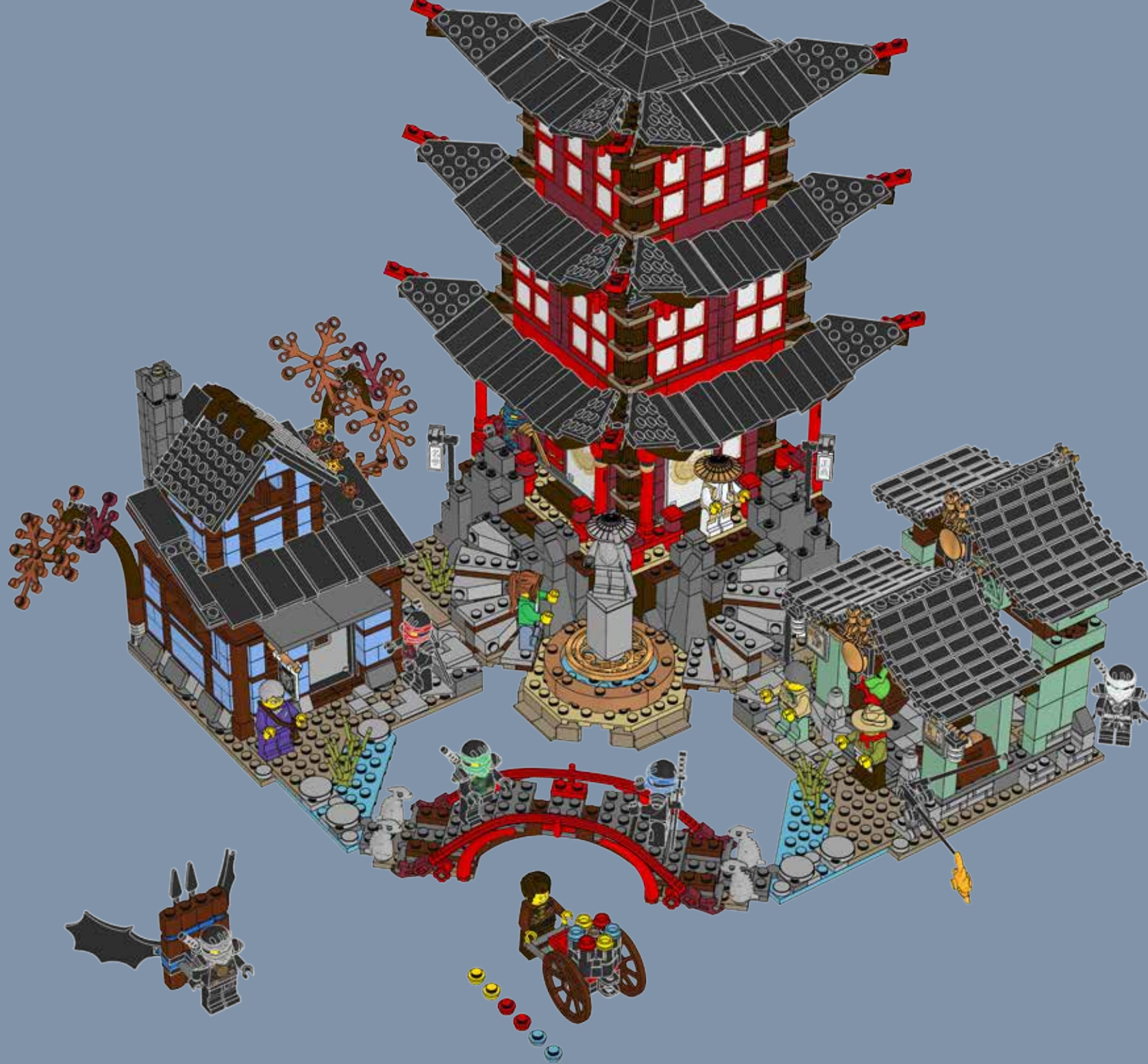







1x 6050914
1x 6069002
1x 4119410
4x 306901
2x 6058329
2x 4597131
1x 4527947
6x 614101
1x 6046383
1x 6011794
1x 6123750
1x 4609289
2x 6063275
4x 6046905
1x 4526981

2x 4114064
15x 4117070
1x 4179771
2x 4624086
1x 4121921
2x 4118790
1x 4124067
1x 6029889
1x 6013081
1x 4140562
1x 6066344
1x 6037610
1x 6037610
1x 4611414

1x 4543858
1x 6124267
1x 6123735
1x 4569547
1x 4540107
1x 4582437
1x 4565452
1x 6084724
1x 6055065
2x 302123
5x 4613257
4x 614123
2x 393723
2x 368023

16x 4143005
2x 4206482
2x 366021
2x 4500462
4x 6056816
4x 307021
4x 302321
2x 362321
2x 371021
4x 366621
2x 346021
2x 4611701
1x 246021
11x 4515365
1x 370921
2x 373821

8x 6035617
4x 4173441
1x 389921
2x 6054438
1x 4174747
1x 4114052
4x 6018583
1x 4144413
4x 4565432
4x 4227155
8x 4142865
24x 292121
32x 4521438
8x 614121
6x 306221
2x 300821
2x 4614802

6x 300521
8x 300421
8x 4543832
3x 300424
1x 306824
2x 4558172
4x 614124
1x 4611426
1x 6092676
1x 6057957
1x 6057958
1x 6124264
1x 6123977
1x 6100203
1x 6107469
1x 4651443
3x 235721

1x 6100249
1x 6057982
1x 4544151
2x 4239601
7x 362226
2x 300226
1x 300926
1x 6039347
11x 4233487
1x 4504382
10x 6069000
8x 4121966
1x 366526
1x 4163373
6x 4189064
12x 428726

4x 329826
3x 367526
34x 4529155
4x 4581280
2x 6056500
6x 302326
4x 6092585
2x 306826
7x 302226
6x 242026
8x 362326
14x 371026
10x 243126
6x 4560182
1x 6076678

5x
6066102

12x
4598528

2x
6000650

7x
6020193

4x
4183043

5x
366626

2x
663626

1x
4243819

1x
379526

2x
395826

1x
447726

2x
383226

3x
4514845

5x
4529064

2x
6061032

2x
383926

1x
6018805

1x
4114689

10x
614126

1x
4515350

12x
4160025

4x
4599461

6x
4106347

4x
4593678

1x
4535834

34x
4582536

4x
395726

3x
4623113

1x
6117412

1x
6117007

1x
6117002

1x
6117729

1x
6117277

1x
6117061

1x
6117066

1x
6117082

1x
6117084

1x
6117211

1x
6113986

1x
6113987

1x
6113991

1x
6113995

1x
6113079

5x
6038453

2x
4286122

1x
4106552

1x
434926

1x
452226

1x
6043130

5x
6116592

2x
449726

1x
6020192

5x
6116639

2x
4277967

1x
460026

4x
4621116

2x
4289538

2x
4532220

3x
4143372

6x
4124096

5x
4286267

1x
4563044

6x
4107082

3x
4121715

1x
370526

2x
373726

1x
370826

1x
6100104

1x
6100844

1x
4619599

1x
4107050

5x
6039193

1x
4614107

3x
6035618

32x
6120263

2x
6101944

1x
626440

4x
4626883

1x
4527526

6x
4179825

3x
4168345

18x
4179830

17x
4179833

10x
6000880

10x
4163696

2x
4649756

4x
6015452

6x
6015424

2x
4507047

2x
4616574

2x
4246957

4x
6030845

2x
6006524

2x
6096215

1x
6118917

1x
4613196

2x
4613196

3x
4613196

4x
6015449

4x
6093064

6x
4578032

33x
6047415

1x
4550168

4x
6005897

1x
4626884

1x
4623481

1x
4654448

17x
4183133

2x
6062686

4x
6124349

4x
6051596

1x
4267425

2x
6015449

4x
6093064

6x
4578032

33x
6047415

1x
4550168

4x
6005897

1x
4626884

1x
4623481

1x
4654448

17x
4183133

2x
6062686

4x
6124349

4x
6051596

1x
4267425

1x
4267425

4

8

12

- 2x 4598955
- 8x 6031821
- 2x 4528488
- 1x 6036240
- 1x 4667595
- 5x 4521948
- 4x 6075623
- 6x 6075621
- 4x 6075626
- 2x 4625236
- 1x 6097680
- 1x 4206504
- 20x 4541376
- 30x 4539102
- 6x 6052777
- 2x 4541528
- 16x 6070691
- 2x 4590811
- 4x 4541526
- 3x 4550169
- 4x 4539061
- 2x 4650865
- 4x 6071222
- 4x 4539064
- 2x 6024916
- 1x 6116780
- 1x 6117079
- 4x 4549992
- 1x 6113999
- 4x 6006738
- 2x 6107894
- 1x 4539091
- 1x 4649066
- 2x 4261397
- 1x 4243668
- 2x 6017001
- 1x 6005772
- 3x 4211181
- 1x 4211225
- 12x 4225469
- 8x 4211183
- 4x 4520612
- 2x 4211252
- 7x 4267994
- 2x 4211195
- 1x 4658005
- 4x 6066142
- 1x 4211219
- 2x 4211288
- 3x 4224243
- 4x 6092590
- 17x 4211150
- 17x 4211257
- 6x 4216695
- 1x 6050918
- 4x 6100769
- 7x 4211152
- 6x 4211189
- 8x 4211190
- 4x 4579690
- 4x 4211186
- 8x 4221590
- 4x 6096379
- 3x 4243838
- 1x 4211247
- 2x 4211211
- 8x 4223683
- 7x 4211214
- 1x 4225715
- 1x 6058247
- 11x 6117976
- 5x 6123759
- 20x 6035580
- 25x 4216581
- 64x 4211159
- 1x 6102360
- 6x 4283660
- 6x 6084573
- 2x 4224732
- 2x 6107938
- 4x 4645400
- 1x 6058084
- 5x 4595814
- 2x 6092659
- 19x 4623429
- 1x 4520638
- 2x 4211163
- 2x 4533101
- 3x 4211185
- 1x 6116613
- 1x 6123948
- 1x 6047551
- 1x 4610041
- 1x 6121728
- 2x 4211279
- 2x 4598334
- 3x 6055781
- 11x 6000066
- 1x 4211650
- 2x 6028811
- 1x 6028324
- 4x 4651063
- 1x 4527767
- 2x 4211848
- 6x 4521921
- 6x 4211488
- 14x 4211415
- 13x 4211398
- 3x 4211414
- 2x 4565393
- 2x 4211397
- 19x 6065824
- 2x 4211396
- 2x 4599498
- 3x 4598526
- 1x 4244627
- 2x 4666449
- 1x 4211444
- 8x 4650260
- 3x 4211735
- 3x 4211732
- 5x 6052200
- 1x 4211475
- 4x 4507056
- 4x 4211361
- 2x 6105964
- 1x 6065151
- 1x 6078211
- 1x 6078212
- 1x 6078212
- 1x 4211503
- 2x 6011817
- 1x 6081975
- 2x 4558465
- 1x 4227657
- 1x 4292298
- 1x 4211585
- 1x 6075237
- 1x 6057487
- 1x 6002762
- 4x 6109356
- 1x 4512743
- 2x 4540203
- 1x 4211815
- 1x 4211639
- 1x 6121787
- 1x 6097090

3

5

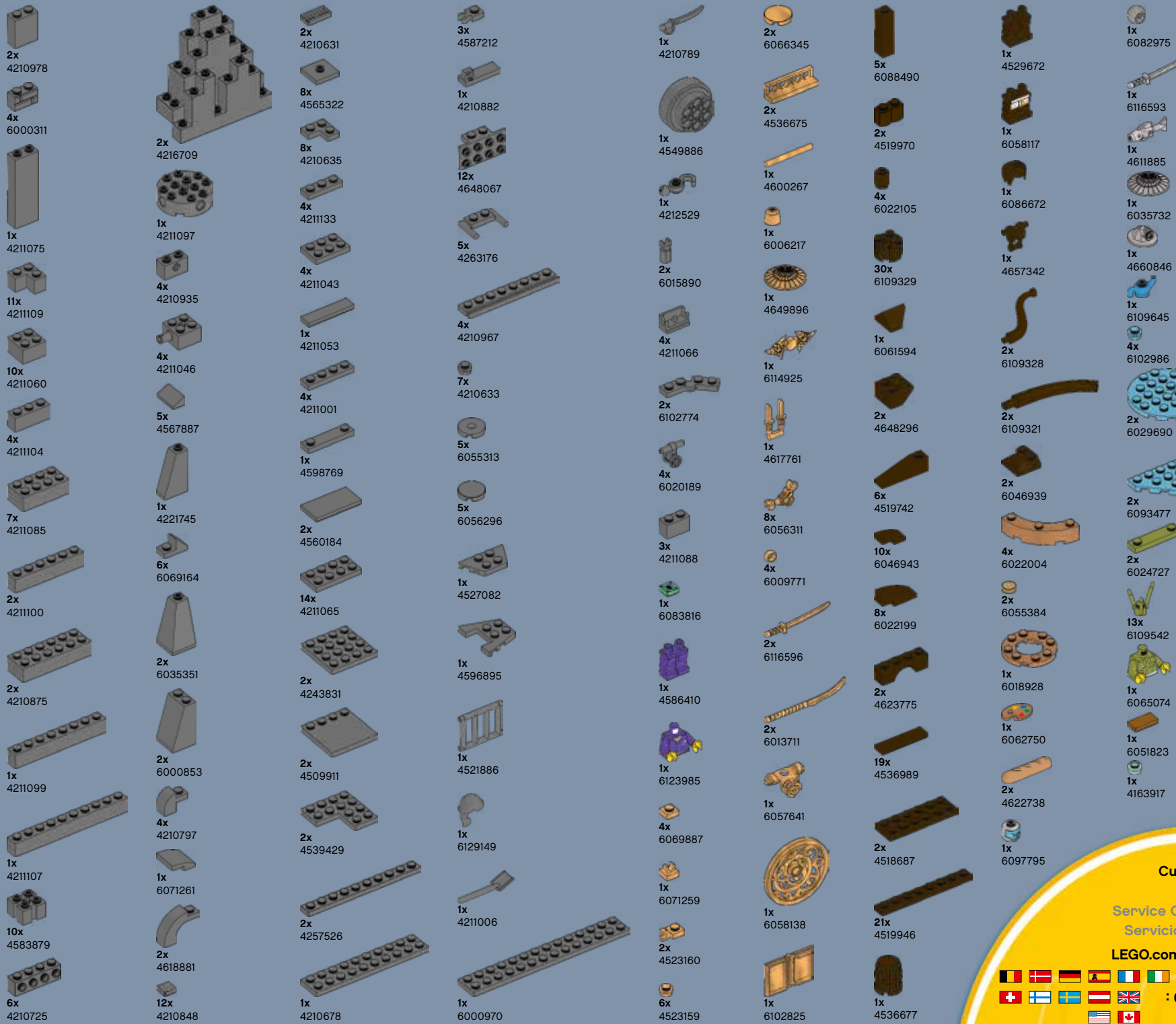

Customer Service
 Kundenservice
 Service Consommateurs
 Servicio Al Consumidor
LEGO.com/service or dial

 : 00800 5346 5555
 : 1-800-422-5346

WIN

GO TO WWW.LEGO.COM/PRODUCTFEEDBACK AND GIVE US YOUR SHORT **FEEDBACK** ABOUT THIS LEGO® SET FOR A CHANCE TO WIN A COOL LEGO PRIZE.



LEGO.com/productfeedback

GEWINNE

Erzähle uns auf www.LEGO.com/productfeedback

etwas über die Erfahrungen, die du mit diesem LEGO® Set gemacht hast, und sichere dir die Chance auf einen coolen LEGO Preis!

GAGNE

Rends-toi sur www.LEGO.com/productfeedback

et donne-nous quelques commentaires sur ce produit LEGO® pour avoir une chance de gagner un prix LEGO !

GANAN

Visita www.LEGO.com/productfeedback

y envíanos tu opinión acerca de este set LEGO®. ¡Participarás en el sorteo de un premio LEGO!

获取奖品

登录 www.LEGO.com/productfeedback

给出关于此乐高®套装的简短反馈，就有机会获得炫酷乐高奖品

경품 당첨 기회

www.LEGO.com/productfeedback

페이지로 이동하여 이 레고® 세트에 대한 간략한 피드백을 보내 주시고 멋진 레고 경품을 탈 수 있는 기회도 잡으십시오

ЗАПОЛНИ АНКЕТУ И ПОЛУЧИ ПРИЗ

Перейди по ссылке www.LEGO.com/productfeedback

ответь всего на несколько вопросов об этом наборе LEGO®, и у тебя появится шанс выиграть замечательный приз от компании LEGO.