



# NINJAGO™

Masters of Spinjitzu



70751

# TEMPLE OF AIRJITZU

This is the place where Sensei Yang invented the lost art of Airjitzu. Sensei Yang trained for most of his life to master this airborne style of fighting, but by the time he finally did, he had become a very old man. He decided to pass on his legacy and started accepting students. In the beginning, he was a respected and admired master, and students even raised a statue in front of the temple in his honor. But knowing that his time was coming to an end, he became impatient and was very hard on students who failed to live up to his strict code of discipline and unusual training methods. A common practice was locking up his students in the attic to make sure they had time to reflect on why they failed to succeed in an Airjitzu training session.

Very little is known of what went on behind the temple walls, but the fact that none of his students ever left the temple has given rise to much speculation and many legends and rumors. Sensei Yang became known as “The Sensei without Students,” and people made sure to keep their distance from the temple.

It is now believed that the ghost of Sensei Yang haunts the temple, and that anyone who enters and does not exit again before sunrise will themselves become a ghost. Over the years, the temple has fallen into disrepair and has become a popular tourist site.

That was a bit of the grim history of the Temple of Airjitzu... What will the future hold for it? You will just have to make up your own story or keep following the story of LEGO NINJAGO to find out. It would be a pretty cool headquarters for the ninja, wouldn't it?

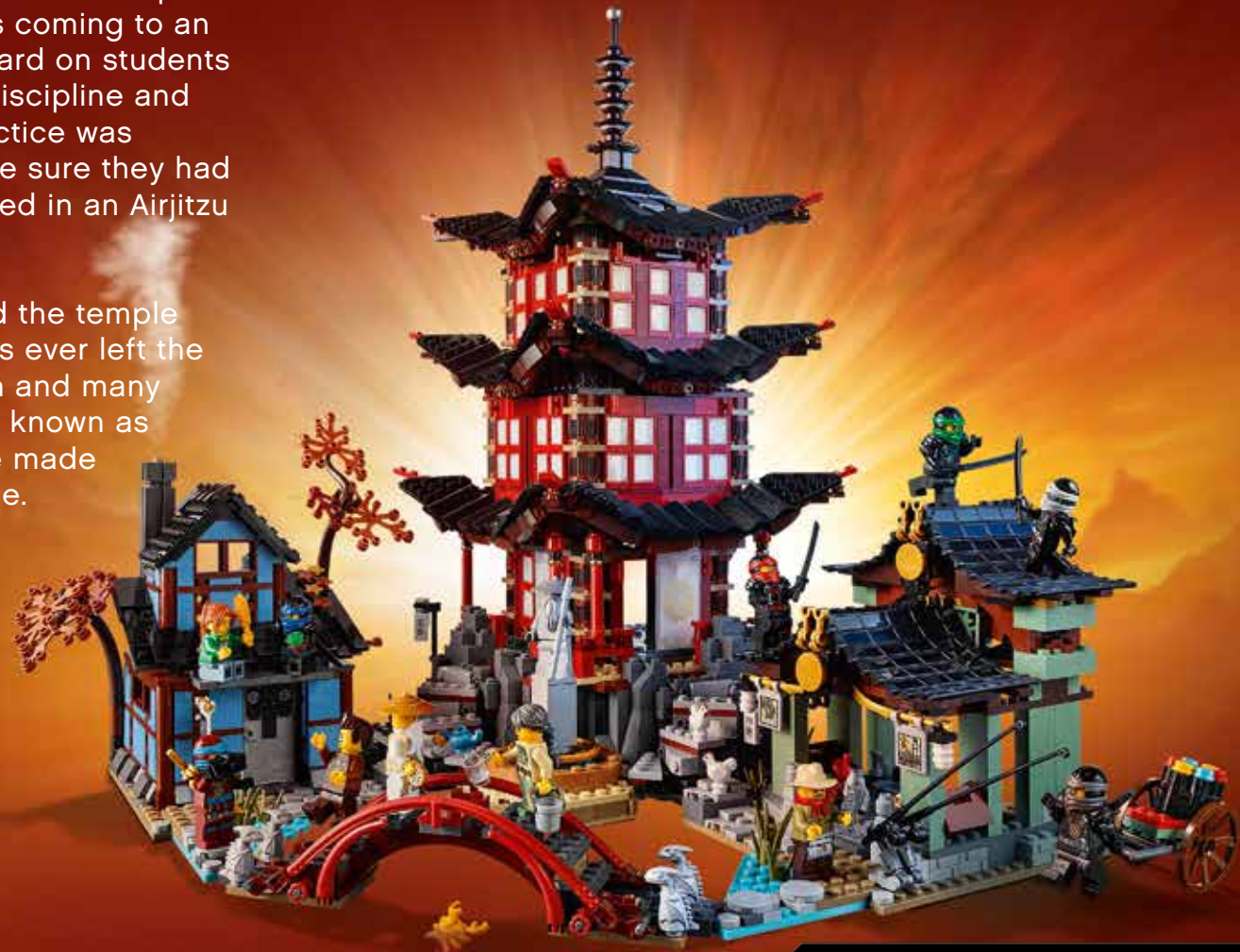

## TEMPLE OF AIRJITZU

Little is known about the origin of this historic location. No one knows who built it or when, but it has been around since the EDO period. Many suspect that it is even older than that, and once was the dojo of the First Spinjitzu Master.

## NINJAGO CITY

The biggest city in all of the NINJAGO world. The city has seen its share of action and was the main site of the attacks of the Great Devourer, the Overlord, the Stone Warriors, the evil Nindroids, and the Golden Master. But NINJAGO City has always prevailed, and although the city has seen much conflict, destruction, and transformation, the citizens are still honest and hard-working people.

## THE WAILING ALPS

One of the highest and coldest peaks in the NINJAGO world. The chilling winds that rush this mountain range make a distinct and frightening sound. The Wailing Alps are the location of the Hypnobrai tomb, and a huge tornado that rages through the area, called the Blind Man's Eye, is said to be a passageway to another Realm.

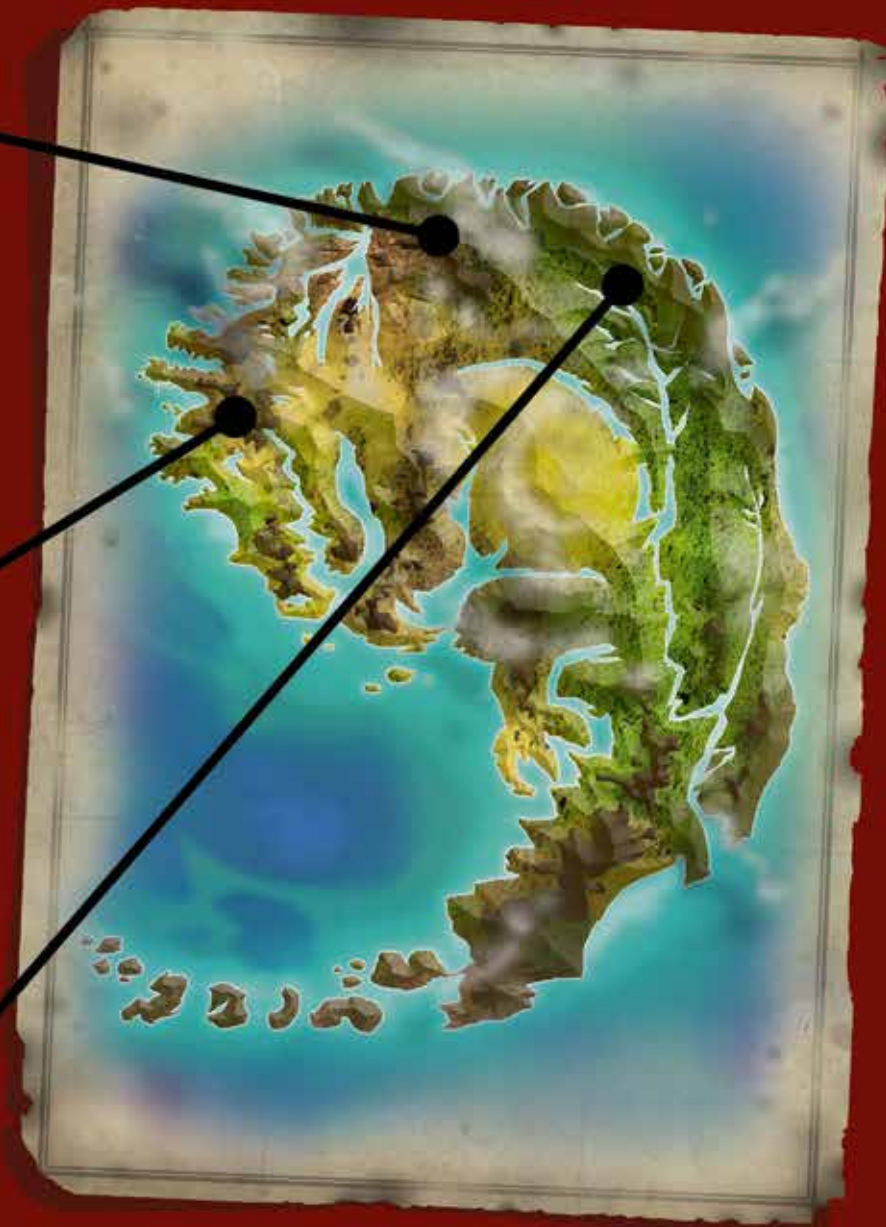

# AN INTERVIEW WITH THE DESIGNERS ADRIAN FLOREA AND THOMAS PARRY



## ***Can you explain a little about the process of designing the Temple of Airjitzu model?***

Sure! When I started working on the Temple of Airjitzu, I had already been working on all things LEGO NINJAGO for more than four years, so you could say that I was very familiar with the universe, the tone of voice, and of course our team of ninjas. We have been equipping our ninjas with state-of-the-art vehicles, glorious dragons, and frightening enemies year after year, but we felt that they've been missing something to provide context. A chance to build a large model came up, and my mind was set on the direction from the start. I could finally

use all the bits and builds that I have been keeping in boxes around my desk. In the end, the model still reflects a strong LEGO NINJAGO fantasy-inspired look, with some features that might not be based on reality.

## ***How did you get the inspiration for this set?***

It's difficult not to get inspired when digging up references on Asian architecture. The main idea for the model and the layout was to provide our main characters with an environment where they could take a break from saving the NINJAGO world. The centerpiece pagoda is luxurious and intricate, while the blacksmith's shop has a humble feel to it. The contrast is clear in the differences between the buildings such as the color, roof styles, windows, and the purpose they serve. Too much contrast can cause confusion, so I set up the base layout to be visually symmetrical with the fountain serving as the center.

## ***What were some of the challenges you faced?***

Knowing when to stop! The village had the potential to grow in so many different directions, but it was important to represent the essentials. The idea of the shadow theater came later in the process, which meant that it had

to be thought out efficiently and as quickly as possible. Determining how to cast the shadows on the foil screen was a complicated process. Some of the early versions had overlapping elements that created interesting shapes and even dragons with the light-brick turned on. One version involved more movement but turned out to be too finicky. Another challenge with the theater was building the mechanism that activates the turntable and light-brick simultaneously, since we can't allow the light to be triggered constantly, which would run down the battery. Challenges like these are fun at the end of the day when it all comes together and works as it should.

### ***What's your favorite part of the model?***

It's tricky to pinpoint one favorite part, but I am definitely happy with the visual effect of the shadow play, as it's the first feature of this kind to be added in a model. I have found myself staring at it as if it's telling an old folktale with its minimal language.

### ***What was the toughest part of the model to design?***

The Temple (pagoda) has proven to be the trickiest. The unique layout it has, being situated in the corner, came with unexpected surprises. Each level had to be different in width, because the first floor has a

passage on the outside, which means the walls had to be pushed in, and they would pop out by a stud on the next floor only to be narrowed down again on the last floor. The smooth curves of the roofs that have to fit with the rigid base shape of the building were a tough challenge from day one. The temple roof layout was built very differently at first, using tiny ball joints to get the angles just right. It looked nice, but was needlessly complex.

### ***Tell us a little about how you came to work at The LEGO Group.***

I graduated with a degree in Industrial Design, and have been putting LEGO bricks together since 2010. My very first models were designed for LEGO NINJAGO. I was happy to discover that the people who were interested in hiring me had known about my models that I had been building with LEGO bricks in my spare time as an AFOL [Adult Fan Of LEGO bricks].

### ***What's your favorite LEGO NINJAGO set?***

The Fire Temple still holds a special place in my heart, and a close second would be the second Destiny's Bounty. I tend to get drawn in by ridiculous features that seem to be the signature of so many LEGO NINJAGO sets.



# DESIGN PROCESS

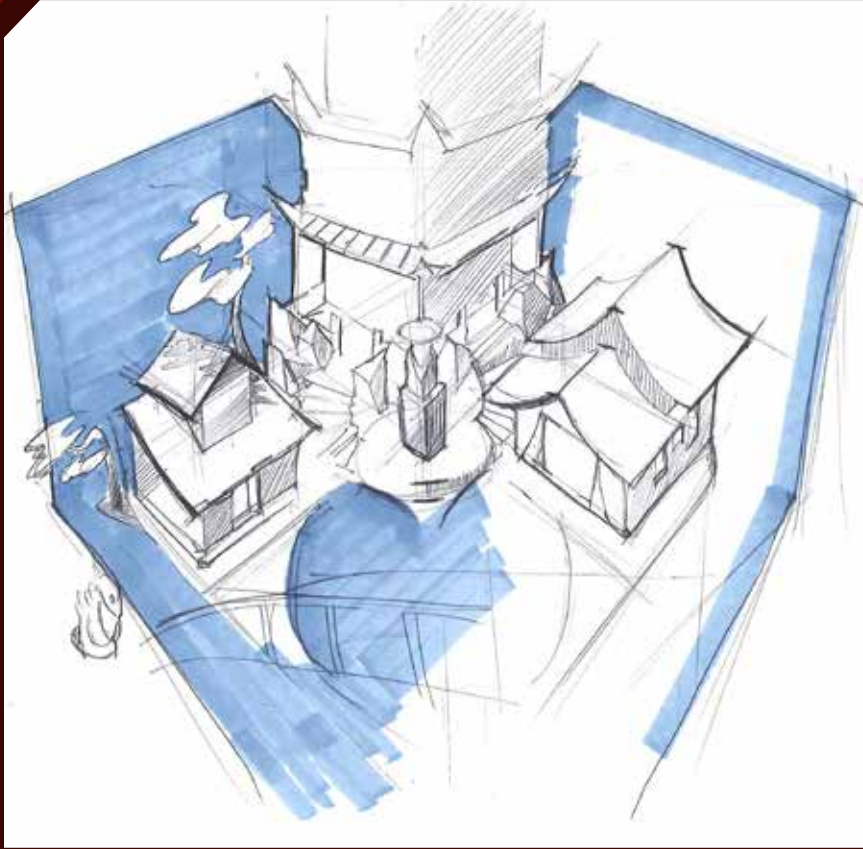

The model is close to its final version. The symmetrical layout has started to take shape, and the different heights of the buildings make for an interesting outline. You can tell that there is a focal point where the statue is in the middle of the fountain and the sides extend to fit the two extra buildings. I really get attached to small details such as the tree shade on the rooftop of the blacksmith's shop, so I ended up adding dried leaves to get a similar effect.



Rough quick sketches that helped me get comfortable with the difficult-to-build shapes that are common to Asian-style buildings.



The smuggler's market has stayed mostly untouched with its open structure. The difficult part was deciding on a roof. The garage door segments allowed me at least two options for soft shapes that would reflect the symbolic style. In the end, the more recognizable and intricate double roof was chosen. More details were added with time, such as the fishing rods, crates, and pathway. I am very fond of the two chickens that have taken up residence in the vicinity, probably lured in by the smell of baguettes.

## DESIGN FACTS



A very modest-looking house, which in the early days of development set the tone of voice all the way to the final version. At this point, I knew I wanted to include at least one building that had an interesting wooden structure in its walls. This came to life in the blue blacksmith's shop.



Early on in the process of designing, I was very inspired by the freedom that a model this size offers. Detailed cliffs and wild trees were something I've always wanted to build as part of a model. The cliff went down in size and was replaced by the pagoda-inspired structure. In this early sketch, the direction was different and I wanted to throw in some references to Darkley's Boarding School for Bad Boys and the NINJAGO City Museum, although it made little sense for them to stand side by side.

# CHARACTER OVERVIEW

## THE NINJA

Although any one ninja is powerful, as a team, they are almost unstoppable. The ninja help each other, support each other, and in battle, they are always watching each other's backs. While they have their share of arguments, each one will risk anything for his friends and the team.



**KAI**



**JAY**



**ZANE**



**COLE**



**LLOYD**



**NYA**



**WU**



## THE POSTMAN

The hardest-working man on NINJAGO Island. A former post office worker, this postman decided as he reached retirement age that he needed to get more fresh air and exercise. He started delivering the mail (and packages with new ninja outfits) himself, but alas, he had not taken into account how dangerous the NINJAGO world could be. That's why he has developed a wide variety of strange vehicles that can help him get the mail out to even the most remote locations.



## JESPER

Employed to make Yang's Haunted Temple into a pristine tourist attraction, he unfortunately hasn't been doing a very good job. It's difficult to take care of a haunted temple when you're afraid of ghosts. He is a very skilled landscaper and gardener, but his fear keeps him at a distance, so the grounds far from the temple are much better kept than the temple itself. If the temple is one day cleared of its ghoulish reputation, then he will undoubtedly do a great job. Until then, it's good that he has his daughter...



## CLAIRE

The polar opposite of her father, she hangs around the Temple all the time, not afraid to do some repairs and whatever else her father is too frightened to do. In fact, she LOVES ghost stories, and in secret she spends as much time as she can investigating the Haunted Temple. She knows every nook and cranny, and has pretty much unraveled all of the mysteries and dark secrets of the temple...but she keeps it to herself because she doesn't want to scare anybody, especially her father.

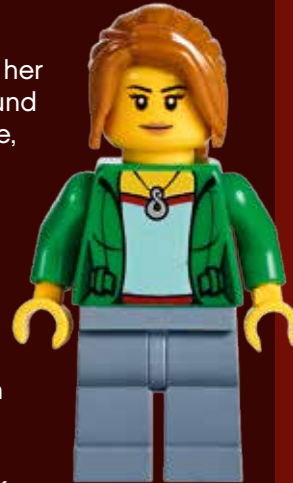

## MISAKO

Misako is an archaeologist for the NINJAGO Museum of History and Lloyd's mother. Her commitment to her research, particularly in figuring out how to prevent the prophecy of the Green Ninja from coming true, kept her away from Lloyd throughout much of his life. Her knowledge and expertise become key to the ninja team's epic journey.



## DARETH

Dareth is the owner of a small dojo called Grand Sensei Dareth's Mojo Dojo, where he teaches a small group of students. Dareth is a laid-back teacher, but a little full of himself. He often tries to prove that he's good enough to be one of the ninja, though he usually fails miserably. Nonetheless, Dareth remains a devoted friend and supporter of the team.



# MOVIE THEATER

The shadow theater in the model tells a story that is simple enough to be interpreted in many different ways. The silhouettes might even be spirits trapped under the temple, forever reliving their moment of glory, learning how to master the secrets of Airjitzu in an epic fight. But was it their last fight?

The snake for me represents the Great Devourer, the ultimate baddie in the Year of the Snake, and one of the most impactful villains in the LEGO NINJAGO world. The mini Great Devourer could be sneaking in for a bite, and spinning in circles is the best way to defend against the venomous fiend. If you try moving the snake closer to the light-brick, the shadow will grow, and you can recreate a scene of Garmadon and his brother Wu fending off the powerful foe.



# THEATER FACTS

It was through a coincidence that I came up with the theater. It just so happened that the Temple of Airjitzu was being designed at the same time that I stumbled upon this alternate use of the light brick, so I knew I had to add this fun new function to the model. The use of shadows can be very symbolic, and it seemed like a perfect fit in the context of the NINJAGO world. It's also an exciting new way of using the light brick, since its 2x3 size can make it a bit clumsy to fit into certain models.

In the days designing the theater and the mechanics behind it, I started playing around with different elements that had interesting effects, such as transparency or odd pieces that projected different kinds of shadows. Once I decided on using the tiny yet adorable trophy figure to represent the characters, the next step was adding movement. A fun challenge was linking the functions together, giving it this old-time kinoscope feel. You will also notice how the shadows of the characters grow and shrink in size depending on their distance from the light. If the stone steps are removed on the left side, you can also remove the light brick



easily by tapping the wall.

The shadow play has served as a simple yet captivating form of storytelling since ancient times, and has been a part of mythology and entertainment throughout history. Long before the invention of film, the original shadow theater came to be in ancient China, and quickly spread throughout Asia as a traditional art form. Groups of traveling artists would set up plays using myths and legends as subjects and music to accompany the story. I have also heard that it brings good luck!

I think it's a very fun and original function that I hope everyone will enjoy. You can add to it to create your own story, and there are no limits to its functionality. Some say it tells the story of two brothers fighting an unstoppable foe, but I like to think of it as open to interpretation.



# LE TEMPLE D'AIRJITZU

Ce temple est le lieu où Sensei Yang a inventé l'art disparu de l'Airjitzu. Sensei Yang s'est entraîné pendant la plus grande partie de sa vie pour maîtriser ce style de combat volant, mais quand il y est enfin parvenu, il était devenu un vieillard. Il décida de transmettre ses connaissances et commença à accepter des élèves. Il fut au début un maître respecté et admiré, et les élèves érigèrent même une statue en son honneur devant le temple. Mais sentant que sa fin était proche, il devint impatient et très dur envers les élèves qui ne respectaient pas son code de discipline strict et ses méthodes de formation inhabituelles. Il enfermait souvent ses élèves dans le grenier pour leur donner le temps de réfléchir sur la raison pour laquelle ils avaient échoué dans une séance d'entraînement Airjitzu.

On sait très peu de choses sur ce qui s'est passé derrière les murs du temple, mais le fait qu'aucun des élèves ne soit ressorti du temple a donné naissance à de nombreuses spéculations, légendes et rumeurs. Sensei Yang fut surnommé le « Sensei sans élèves » et les gens s'assuraient de ne pas s'approcher du temple.

On pense maintenant que le fantôme de Sensei Yang hante le temple et que celui qui entre et ne ressort pas avant le lever du soleil deviendra aussi un fantôme. Au fil du temps, le temple s'est dégradé et est devenu un site touristique populaire.

Telle est la sombre histoire du Temple d'Airjitzu... Mais que lui réserve le futur ? Tu devras inventer ta propre histoire ou continuer à suivre l'histoire de LEGO NINJAGO pour le savoir. Ce serait un QG plutôt génial pour les Ninjas, non ?



## LE TEMPLE D'AIRJITZU

On sait peu de choses sur l'origine de ce lieu historique. Personne ne sait qui l'a construit, ni quand, mais il existe depuis la période EDO. Beaucoup pensent qu'il est encore plus ancien que ça, et qu'il fut jadis le dojo du premier Maître Spinjitzu.

## NINJAGO CITY

La plus grande ville du monde de NINJAGO. Elle a connu pas mal d'action et était le site principal des attaques du Grand dévoreur, d'Overlord, des guerriers de pierre, des maléfiques Nindroïdes et du Maître d'or. Mais NINJAGO City a toujours eu le dessus et même si elle a connu beaucoup de conflits, de destruction et de transformation, les citoyens sont restés des gens honnêtes et travailleurs.

## LE MONT HURLANT

Les pics les plus élevés et les plus froids du monde de NINJAGO. Les vents glacés qui soufflent sur cette chaîne de montagnes font un bruit différent et effrayant. Le mont Hurlant est le lieu du tombeau des Hypnobrai et une énorme tornade appelée l'Œil de l'aveugle, qui fait rage sur la région, serait un passage vers un autre Royaume.



# ENTREVUE AVEC LES DESIGNERS ADRIAN FLOREA ET THOMAS PARRY



## **Pouvez-vous nous expliquer un peu le processus de création du modèle Le Temple d'Airjitzu ?**

Bien sûr ! Quand j'ai commencé à travailler sur le Temple d'Airjitzu, j'avais déjà travaillé sur tous les modèles LEGO NINJAGO depuis plus de quatre ans, je connaissais donc très bien cet univers, son style et bien sûr notre équipe de Ninjas. Nous avons doté nos Ninjas de véhicules ultra modernes, de dragons glorieux et d'ennemis effrayants année après année, mais nous avons l'impression qu'il manquait quelque chose pour leur donner un contexte. L'occasion de construire un grand modèle est arrivée et j'avais dès le début une idée de ce que je voulais faire. J'allais

finalement pouvoir utiliser toutes les petites pièces et constructions que je gardais dans des boîtes autour de mon bureau. Finalement, le modèle reflète toujours une importante inspiration LEGO NINJAGO fantastique, avec des caractéristiques qui peuvent ne pas être basées sur la réalité.

## **Comment avez-vous trouvé l'inspiration pour cet ensemble ?**

Il est difficile de ne pas être inspiré en cherchant des références sur l'architecture asiatique. L'idée principale pour le modèle et la maquette était de fournir à nos principaux personnages un environnement où ils pourraient se reposer pendant leur lutte pour sauver le monde de NINJAGO. La pagode centrale est luxueuse et sophistiquée tandis que l'atelier du forgeron a un style très humble. Le contraste est clair dans les différences entre les bâtiments, notamment dans la couleur, les styles de toits, les fenêtres et leur fonction. Trop de contraste peut causer une certaine confusion, j'ai donc créé la base pour qu'elle soit visuellement symétrique, la fontaine servant de centre.

## **Quels ont été certains des défis que vous avez dû affronter ?**

Savoir quand s'arrêter ! Le village avait le potentiel de grandir de nombreuses façons différentes, mais il était important de représenter l'essentiel. L'idée d'un théâtre d'ombres est arrivée plus tard dans le processus, ce qui signifie

qu'elle a dû être réalisée aussi efficacement et aussi rapidement que possible. Trouver comment projeter les ombres sur l'écran a été un processus compliqué. Certaines des premières versions avaient des éléments qui se chevauchaient, créant des formes intéressantes et même des dragons avec la brique lumineuse allumée. Une version offrait plus de mouvement, mais elle s'est révélée trop délicate. Un autre défi avec le théâtre a été de construire le mécanisme qui active la table tournante et la brique lumineuse simultanément, car la lumière ne peut pas s'allumer en permanence sinon la pile s'userait trop vite. Des défis comme ceux-là sont finalement amusants lorsque tout finit par s'assembler et bien fonctionner.

### **Quelle est votre partie préférée dans le modèle ?**

Il est difficile de choisir une partie préférée, mais je suis vraiment heureux de l'effet visuel du théâtre d'ombres, car c'est la première caractéristique de ce type ajoutée dans un modèle. Je me suis surpris à le regarder comme s'il racontait une légende ancienne avec son langage minimal.

### **Quelle a été la partie la plus compliquée à créer dans ce modèle ?**

Le Temple (la pagode) a été la partie la plus compliquée. Sa disposition unique, étant située dans

un coin, a causé des surprises inattendues. Chaque niveau devait avoir une largeur différente car le premier étage avait un passage à l'extérieur, ce qui signifie que les murs devaient être repoussés vers l'intérieur. À l'étage supérieur, ils avaient un tenon de plus avant de se rétrécir à nouveau au dernier étage. Les jolies courbes des toits qui doivent s'intégrer avec la base rigide du bâtiment ont constitué un défi redoutable dès le premier jour. La disposition du toit du temple était construite très différemment au début, en utilisant de tout petits joints en boule pour obtenir les angles adéquats. C'était joli, mais inutilement complexe.

### **Racontez-nous un peu comment vous en êtes venus à travailler pour le Groupe LEGO.**

J'ai obtenu un diplôme de design industriel et j'assemble des briques LEGO depuis 2010. Mes tout premiers modèles étaient conçus pour LEGO NINJAGO. J'ai été heureux de découvrir que les gens qui voulaient m'engager connaissaient les modèles que je construisais avec des briques LEGO pendant mes loisirs comme fan adulte de la construction LEGO.

### **Quel est votre ensemble LEGO NINJAGO préféré ?**

Le Temple de feu tient toujours une place spéciale dans mon cœur, et juste après, le QG des Ninjas. J'ai tendance à être attiré par les fonctions amusantes qui sont la marque de beaucoup d'ensembles LEGO NINJAGO.



# PROCESSUS DE CONCEPTION

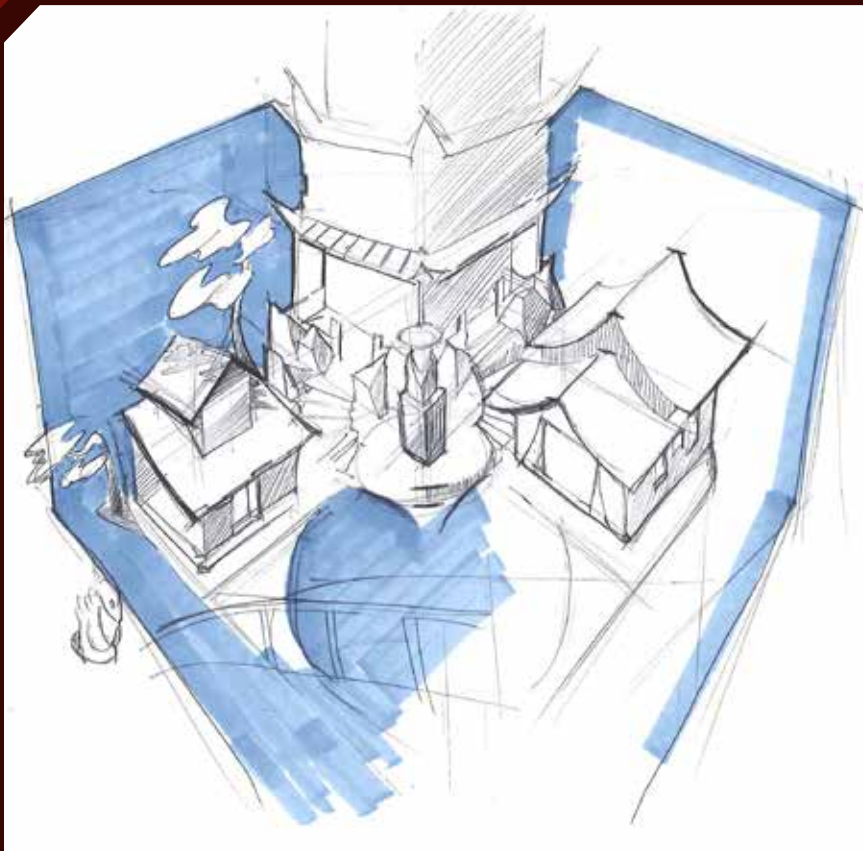

Ce modèle est proche de la version finale. La disposition symétrique commence à prendre forme et les bâtiments de différentes hauteurs composent un paysage intéressant. On voit un point central où se trouve la statue au milieu de la fontaine et les côtés s'étendent pour s'adapter aux deux bâtiments supplémentaires. J'attache beaucoup d'importance aux petits détails, par exemple l'ombre de l'arbre sur le toit de l'atelier du forgeron, j'ai donc fini par ajouter des feuilles séchées pour obtenir un effet similaire.



Des esquisses rapides m'ont aidé à maîtriser les formes difficiles à construire, caractéristiques des bâtiments de style asiatique.



Le marché des contrebandiers est resté pratiquement intact avec sa structure ouverte. La partie difficile a été de choisir un toit. Les segments de porte de garage m'ont donné au moins deux options de formes douces pour refléter le style symbolique. Le double toit, plus reconnaissable et élaboré, a finalement été choisi. D'autres détails ont été ajoutés avec le temps, par exemple les cannes à pêche, les caisses et un chemin. J'aime beaucoup les deux poules qui se sont installées à proximité, sans doute attirées par l'odeur des baguettes.



# INFORMATIONS SUR LE DESIGN



C'est une maison d'aspect très modeste qui, aux premiers jours du développement, fixa le style jusqu'à la version finale. À ce stade, je savais que je voulais inclure au moins un bâtiment qui avait une structure en bois intéressante dans ses murs. Ceci est devenu réalité avec l'atelier bleu du forgeron.



Dès le début du processus de conception, j'ai été inspiré par la liberté qu'un modèle de cette taille offrait. J'avais toujours voulu inclure des falaises détaillées et des arbres sauvages dans un modèle. La falaise fut réduite et remplacée par la structure inspirée d'une pagode. Dans cette esquisse initiale, l'idée était différente et je voulais ajouter des références au pensionnat de Darkley pour mauvais garçons et au musée de NINJAGO City, même si les avoir côte à côte n'avait pas beaucoup de sens.

# DESCRIPTION DES PERSONNAGES

## LES NINJAS

Un Ninja seul est déjà puissant, mais en équipe ils sont presque invincibles. Les Ninjas s'entraident, se soutiennent, et dans le combat, ils se protègent toujours les uns les autres. Il leur arrive de se disputer, mais chacun est prêt à tout risquer pour ses amis et l'équipe.



**KAI**



**JAY**



**ZANE**



**COLE**



**LLOYD**



**NYA**



**WU**

## LE FACTEUR

L'homme le plus travailleur de l'île de NINJAGO. Travaillant auparavant au bureau de poste, ce facteur a décidé que comme il approchait l'âge de la retraite, il avait besoin de plus d'air frais et d'exercice. Il a ainsi commencé à distribuer le courrier lui-même (et des colis avec de nouvelles tenues ninjas), mais hélas il n'avait pas réalisé à quel point le monde de NINJAGO pouvait être dangereux. Il a donc conçu divers véhicules étranges pour l'aider à distribuer le courrier jusqu'aux endroits les plus lointains.



## CLAIRE

À l'opposé exact de son père, elle passe son temps autour du temple, sans crainte de faire quelques réparations et tout ce que son père a trop peur de faire. En fait, elle ADORE les histoires de fantômes, et en secret, elle passe autant de temps qu'elle peut à explorer le temple hanté. Elle en connaît tous les recoins, et a découvert presque tous les mystères et les sombres secrets du temple... Mais elle les garde pour elle, car elle ne veut effrayer personne, surtout pas son père.

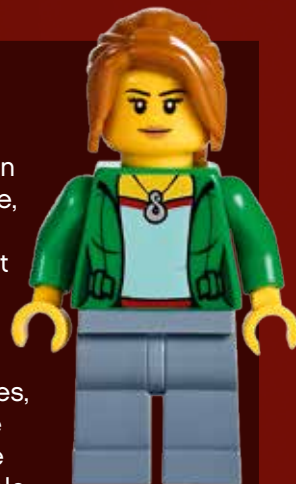

## MISAKO

Misako, la mère de Lloyd, est archéologue pour le Musée d'histoire de NINJAGO. Sa passion pour ses recherches, en particulier pour trouver comment empêcher la prophétie du Ninja vert de se réaliser, l'a tenue éloignée de Lloyd pendant une grande partie de sa vie. Ses connaissances et son expertise deviennent clés pour le parcours épique des Ninjas.

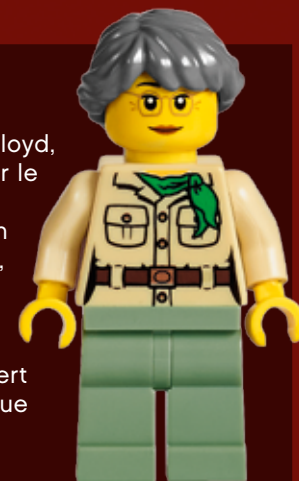

## JESPER

Employé pour faire du Temple hanté de Yang une splendide attraction touristique, il n'a malheureusement pas fait un très bon travail. Il est difficile de s'occuper d'un temple hanté quand on a peur des fantômes. C'est un excellent jardinier paysagiste, mais sa peur le tient à distance, et les terrains situés loin du temple sont beaucoup plus soignés que le temple lui-même. Si le temple perd un jour sa réputation terrifiante, il fera certainement un excellent travail. En attendant, heureusement qu'il a sa fille...



## DARETH

Dareth est le propriétaire d'un petit dojo appelé Mojo Dojo du Grand Sensei Dareth, où il donne des cours à un petit groupe d'élèves. Dareth est un professeur décontracté, mais un peu prétentieux. Il essaie souvent de prouver qu'il est assez bon pour faire partie des Ninjas, mais il échoue misérablement. Dareth reste néanmoins un ami fidèle qui appuie l'équipe avec dévouement.



# LE THÉÂTRE

Le théâtre d'ombres du modèle raconte une histoire qui est assez simple pour être interprétée de nombreuses façons différentes. Les silhouettes peuvent même être des esprits enfermés sous le temple, revivant pour toujours leur heure de gloire, en apprenant comment maîtriser les secrets de l'Airjitzu dans un combat épique. Mais était-ce leur dernier combat ?

Le serpent, pour moi, représente le Grand dévoreur, le méchant suprême dans l'année du Serpent, et l'un des méchants les plus percutants dans le monde de LEGO NINJAGO. Le mini Grand dévoreur pourrait essayer de venir manger un morceau, et tourner en cercles est la meilleure façon de se défendre contre cet ennemi venimeux. Si on rapproche le serpent de la brique lumineuse, l'ombre grandit et on peut recréer une scène où Garmadon et son frère, Wu, luttent contre leur puissant ennemi.



# INFORMATIONS SUR LE THÉÂTRE

C'est par une coïncidence que j'ai eu l'idée du théâtre d'ombres. Le Temple d'Airjitzu était conçu au moment où je suis tombé sur cette utilisation alternative de la brique lumineuse, et j'ai su que je devais ajouter cette nouvelle fonction au modèle. L'utilisation des ombres peut être très symbolique, et semblait parfaitement adaptée au contexte du monde de NINJAGO. C'est aussi une nouvelle façon passionnante d'utiliser la brique lumineuse, car sa dimension 2x3 peut la rendre un peu compliquée à placer dans certains modèles.

Lors des journées passées à créer le théâtre et son mécanisme, j'ai commencé à essayer différents éléments qui avaient des effets intéressants, par exemple la transparence, ou des pièces étranges qui projetaient différentes sortes d'ombres. Une fois que j'ai décidé d'utiliser la figurine trophée minuscule mais adorable pour représenter les personnages, l'étape suivante a été d'ajouter du mouvement. Un défi amusant a été de lier les fonctions ensemble, pour créer cette sensation de kinétoscope à l'ancienne. Tu remarqueras comment les ombres des personnages grandissent et diminuent selon leur distance avec la lumière. Si les marches en pierre sont enlevées sur le côté gauche, il est possible d'enlever facilement la brique lumineuse en tapant sur le mur.



Le théâtre d'ombres a servi de moyen simple mais captivant de raconter des histoires depuis les temps anciens, et a fait partie de la mythologie et des spectacles tout au long de l'histoire. Longtemps avant l'invention du film, le théâtre d'ombres original est né en Chine ancienne, et s'est rapidement étendu dans toute l'Asie comme forme artistique traditionnelle. Un groupe d'artistes voyageurs jouait des pièces en utilisant des mythes et des légendes comme sujets et de la musique pour accompagner l'histoire. J'ai aussi entendu dire que cela porte chance !

Je pense qu'il s'agit d'une fonction très amusante et originale et j'espère que tout le monde va l'aimer. Tu peux l'ajouter pour créer ta propre histoire, et sa fonctionnalité est sans limites. Certains disent qu'il raconte l'histoire de deux frères qui luttent contre un ennemi invincible, mais j'aime penser qu'il y a plusieurs interprétations possibles.

# EL TEMPLO DE AIRJITZU

Este es el lugar en el que el Sensei Yang inventó el arte perdido del Airjitzu. El Sensei Yang pasó la mayor parte de su vida entrenando para dominar este estilo aéreo de lucha, pero, cuando finalmente lo consiguió, era ya un anciano. Decidió legar sus conocimientos y comenzó a aceptar estudiantes. Al principio fue un maestro respetado y admirado. Tanto, que sus alumnos construyeron una estatua a la entrada del templo en su honor. Sin embargo, conforme su tiempo se acababa, se hizo impaciente y muy duro con los estudiantes que no estaban a la altura de su estricto código de disciplina y sus insólitos métodos de entrenamiento. Encerrarlos en el desván para que reflexionasen sobre por qué habían fracasado durante una sesión de entrenamiento de Airjitzu se convirtió en algo frecuente.

No se sabe mucho de lo que sucedía tras las murallas del templo, pero el hecho de que ninguno de los estudiantes lo abandonara jamás ha dado lugar a numerosos rumores, leyendas y especulaciones. El Sensei Yang pasó a ser conocido como «el sensei sin alumnos» y la gente dejó de acercarse al templo.

Hoy se cree que el fantasma del Sensei Yang habita en el templo y que cualquiera que entre y no salga antes de la salida del sol se convertirá también en un fantasma. Con los años, el templo se fue deteriorando y en la actualidad es una popular atracción turística.

Esa es un poco la oscura historia del Templo de Airjitzu, pero... ¿qué le reserva el futuro? Tendrás que inventar tu propia historia o seguir la historia de LEGO NINJAGO para averiguarlo. Sería un fantástico cuartel general para los ninjas, ¿no?



## EL TEMPLO DE AIRJITZU

Poco se sabe sobre el origen de este monumento. Nadie sabe quién lo construyó ni cuándo, pero está ahí desde el período Edo. Muchos sospechan que es todavía más antiguo y que una vez fue el dojo del primer maestro del Spinjitzu.

## NINJAGO CITY

Es la ciudad más grande de todo el mundo de NINJAGO. Ha sufrido los ataques del Gran Devorador, el Señor Supremo, los guerreros de piedra, los malvados nindroides y el Maestro Dorado. Pero NINJAGO City siempre ha sobrevivido. Y aunque ha sido testigo de grandes conflictos, destrucciones y transformaciones, sus ciudadanos siguen siendo gente honesta y trabajadora.

## LOS ALPES DEL LAMENTO

Aquí se concentran los picos más altos y fríos del mundo de NINJAGO. Los gélidos vientos que recorren esta cadena montañosa hacen un ruido peculiar y aterrador. Es en los Alpes del Lamento donde se encuentra la tumba de los Hypnobrai y se dice que un gran tornado que arrasa la zona (conocido como «ojo del ciego») es una puerta a otro mundo.



# ENTREVISTA CON LOS DISEÑADORES ADRIAN FLOREA Y THOMAS PARRY



**¿Puedes explicar un poco cómo fue el proceso de diseño del Templo de Airjitzu?**

¡Claro! Cuando comencé a trabajar en el Templo de Airjitzu ya llevaba cuatro años trabajando en todo lo relacionado con LEGO NINJAGO, así que estaba muy familiarizado con el universo, el estilo y, por supuesto, el equipo de ninjas. Año tras año, hemos equipado a los ninjas con modernos vehículos, les hemos dado gloriosos dragones y los hemos enfrentado a terroríficos enemigos, pero creíamos que necesitaban un poco más de contexto. Surgió la oportunidad de crear un modelo de gran tamaño y me puse a

trabajar inmediatamente. Por fin podía usar todas las ideas y pequeñas construcciones que guardaba en las cajas que hay alrededor de mi escritorio. La versión final del modelo refleja una atmósfera de fantasía fuertemente vinculada a LEGO NINJAGO, con algunos detalles que quizá no estén basados en la realidad.

**¿Cómo se inspiraron para crear este set?**

Es difícil no inspirarse al investigar sobre la arquitectura asiática. La idea principal del modelo y el diseño era ofrecer a nuestros protagonistas un entorno en el que pudieran descansar de salvar el mundo de NINJAGO. La pagoda central, lujosa y elaborada, llama la atención junto a la humilde herrería. El contraste es evidente en las diferencias entre los edificios: el color, los tejados, las ventanas y los fines a los que sirven. Demasiado contraste puede generar confusión, así que lo distribuí todo de forma simétrica, con la fuente como centro.

**¿A qué desafíos tuvieron que enfrentarse?**

¡Saber dónde poner el límite! El poblado podía crecer en muchas direcciones, pero era importante representar sólo lo fundamental. La idea del teatro de sombras surgió durante las últimas etapas del proceso, lo cual nos obligó a pensarlo



con eficiencia e incorporarlo lo más rápido posible. Averiguar cómo crear las sombras en la pantalla fue bastante complicado. Las primeras versiones tenían elementos superpuestos que creaban formas interesantes, incluso dragones, al activar el brick luminoso. Una de las versiones incorporaba movimiento, pero resultó ser demasiado delicada. Otro de los desafíos que supuso el teatro fue la construcción del mecanismo que activa simultáneamente la base giratoria y el brick luminoso. El problema era que no podíamos mantener la luz activa constantemente porque gastaría la pila. Estos desafíos acaban siendo divertidos cuando por fin consigues que todo funcione como debería.

### **¿Cuál es tu parte favorita del modelo?**

No es fácil decidirse por una parte concreta, pero me gusta mucho el efecto visual del teatro de sombras, ya que es la primera función de este tipo que incorporamos a un modelo. Más de una vez me he quedado mirándolo, como si contase una antigua historia con su lenguaje minimalista.

### **¿Qué parte del modelo fue la más difícil de diseñar?**

El templo (la pagoda) resultó ser la parte más complicada. Su particular distribución, al estar situado en la esquina, dio lugar a sorpresas

imprevistas. Cada planta tenía que tener una anchura diferente. La primera planta posee un pasaje por fuera que nos obligó a estrechar las paredes. En la segunda planta, las paredes tenían que ser una espiga más anchas para, de nuevo, ser más estrechas en la planta superior. Las suaves curvas de los tejados tenían que combinar con la rígida forma de la base del edificio; trabajamos en esto desde el primer día. El tejado del templo se construía de forma muy distinta al principio: usábamos pequeñas uniones de rótula para conseguir el ángulo exacto. Era muy bonito, pero innecesariamente complejo.

### **¿Cómo llegaste a trabajar en The LEGO Group?**

Me gradué en Diseño Industrial y llevo construyendo con bricks LEGO desde 2010. Los primeros modelos que diseñé fueron para LEGO NINJAGO. Fue una gran sorpresa descubrir que quienes me contrataron conocían los modelos que construía en mi tiempo libre cuando era fan adulto de LEGO.

### **¿Cuál es tu set LEGO NINJAGO favorito?**

El Templo del fuego es el que más me gusta; en segundo lugar, muy cerca, estaría el segundo Navío del destino. Tiendo a concentrarme en funciones ridículas que acaban convirtiéndose en la firma de muchos sets LEGO NINJAGO.



# EL PROCESO DE DISEÑO

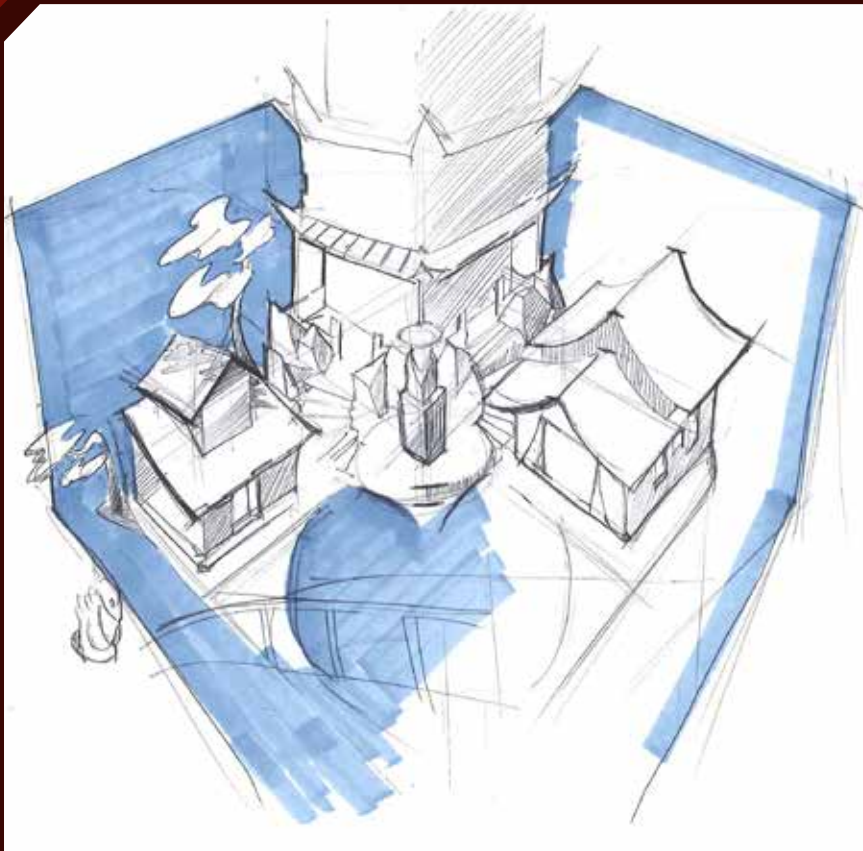

El modelo, casi en su versión final. El diseño simétrico comenzaba a tomar forma y los edificios de distintas alturas daban lugar a un perfil interesante. Se distingue un punto focal en el centro de la fuente, donde se encuentra la estatua, y los lados se despliegan para acoger a los otros dos edificios. Me encantan los pequeños detalles, como la sombra del árbol sobre el tejado de la herrería, así que terminé agregando hojas secas para obtener un efecto similar.



Bocetos rápidos que me ayudaron a familiarizarme con las complejas formas por las que se distinguen los edificios de estilo asiático.



El mercado de contrabando casi no ha sufrido cambios, con su estructura abierta. Lo más difícil fue decidirnos por un tipo de tejado. Los segmentos de puerta de garaje permitían crear, al menos, dos formas curvas para reflejar el emblemático estilo. Finalmente se eligió el tejado doble, más elaborado y reconocible. Con el tiempo se fueron agregando más detalles, como las cañas de pescar, las cajas y un sendero. Me encantan las dos gallinas que acabaron viviendo alrededor, seguramente atraídas por el aroma del pan.

## DATOS SOBRE EL DISEÑO



Una casa de aspecto muy modesto que ha representado el estilo general desde los primeros días de desarrollo. Cuando la dibujé supe que quería incluir, al menos, un edificio con una estructura de madera interesante en las paredes. Es lo que se convertiría en la herrería azul.



Al principio del proceso de diseño, usé como inspiración la libertad que proporciona un modelo de este tamaño. Los detallados acantilados y árboles salvajes son cosas que siempre quise incluir en un modelo. El acantilado fue perdiendo tamaño hasta convertirse en la estructura con forma de pagoda. En este boceto, uno de los primeros, la idea era otra y quise hacer referencia a la Escuela Superior Darkley para Villanos y el museo de NINJAGO City, aunque no tenía mucho sentido que estuvieran juntos.

# DESCRIPCIÓN DE LOS PERSONAJES

## LOS NINJAS

Sin duda, un solo ninja es poderoso... pero un equipo de ninjas es casi imparable. Los ninjas se ayudan entre sí, se apoyan y, cuando luchan, siempre vigilan la espalda de sus compañeros. Aunque a veces discuten, cualquiera de ellos lo arriesgaría todo por sus amigos y el equipo.



**KAI**



**JAY**



**ZANE**



**COLE**



**LLOYD**



**NYA**



**WU**

## EL CARTERO

Es quien más trabaja en toda la isla de NINJAGO. Antes trabajaba en la oficina de correos, pero el cartero decidió que necesitaba más aire fresco y ejercicio. Comenzó a entregar el correo (y los paquetes con los nuevos trajes de los ninjas) personalmente, pero, por desgracia, no tuvo en cuenta lo peligroso que puede llegar a ser el mundo de NINJAGO. Para protegerse, fabricó una gran variedad de vehículos extraños que lo ayudasen a repartir el correo en los lugares más remotos.



## CLAIRE

Es todo lo contrario a su padre. Siempre está paseando alrededor del templo y no le da miedo hacer todo lo que su padre es incapaz de hacer. De hecho, ADORA las historias de fantasmas y pasa tanto tiempo como puede investigando en secreto el templo encantado. Conoce todos los rincones y ha descubierto casi todos los misterios y oscuros secretos del templo... pero no se los ha contado a nadie para no asustar a los visitantes (y, en especial, a su padre).



## JESPER

Contratado para convertir el templo encantado de Yang en una impecable atracción turística, no puede decirse que esté haciendo un gran trabajo. Es difícil ocuparse de un templo encantado cuando te dan miedo los fantasmas. Como jardinero y paisajista es un experto, pero su miedo no le permite acercarse, así que cuida con mucho más esmero las tierras más alejadas del templo que el propio templo. Si el templo pierde algún día su fantasmagórica reputación, seguro que hace un gran trabajo. Hasta entonces, ¡suerte que tiene una hija!



## MISAKO

Misako es arqueóloga en el museo de historia de NINJAGO y la madre de Lloyd. Sus investigaciones y, en particular, sus intentos de impedir que se cumpliera la profecía del ninja verde, la mantuvieron alejada de Lloyd durante buena parte de su vida. Sin embargo, sus conocimientos resultan ser imprescindibles para el colosal viaje del equipo de ninjas.



## DARETH

Dareth es el propietario de un pequeño dojo llamado «Mojo dojo del gran Sensei Dareth», donde enseña a un reducido número de estudiantes. Como maestro, Dareth es bastante tranquilo y un poco prepotente. Cuando intenta demostrar que es lo suficientemente bueno como para ser uno de los ninjas, fracasa miserablemente. Aun así, Dareth sigue siendo un amigo querido y un buen apoyo para los ninjas.

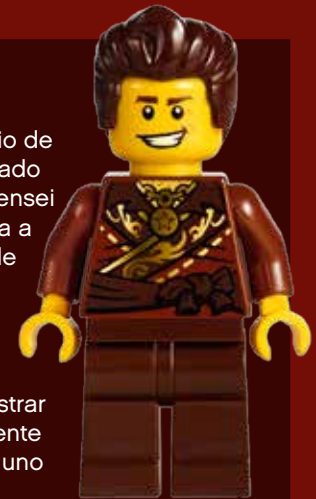

# TEATRO DE SOMBRAS

El teatro de sombras del modelo cuenta una historia que es lo suficientemente sencilla como para poder interpretarla de muchas formas distintas. Las siluetas podrían ser espíritus atrapados bajo el templo, reviviendo su momento de gloria por toda la eternidad... aprendiendo a dominar los secretos del Airjitzu durante un épico combate. Pero, ¿fue su último combate?

Para mí, la serpiente representa al Gran Devorador, el último villano del año de las serpientes y uno de los que más han afectado al universo LEGO NINJAGO. El pequeño Gran Devorador podría estar intentando dar un mordisco, y girar en círculos sería la mejor forma de defenderse de su veneno. Si acercas la serpiente al brick luminoso, la sombra crecerá y podrás recrear la escena en la que Garmadon y su hermano Wu se defienden del poderoso oponente.



# DATOS SOBRE EL TEATRO

Di con el teatro de sombras por casualidad. Descubrí este uso alternativo del brick luminoso mientras se diseñaba el Templo de Airjitzu. Sabía que tenía que incorporar esta nueva y divertida función al modelo. El uso de sombras puede ser muy simbólico y encajaba a la perfección en el contexto de NINJAGO. También es una forma nueva y apasionante de usar el brick luminoso, ya que su tamaño de 2x3 hace complicado incluirlo en algunos modelos.

Mientras diseñaba el teatro y la mecánica que hay tras él, comencé a jugar con diferentes elementos que poseían efectos interesantes, como transparencias o piezas poco comunes que proyectaban sombras de diferentes tipos. Cuando decidí usar la pequeña, aunque adorable, figura del trofeo para representar a los personajes, el siguiente paso era agregar dinamismo. Fue divertido enlazar las funciones; el resultado recuerda mucho a un antiguo quinetoscopio. También observarán que las sombras de los personajes crecen y se encogen dependiendo de la distancia que los separa de la luz. Quitando la escalera de piedra de la izquierda, es fácil desmontar el brick luminoso golpeando suavemente la pared.



El teatro de sombras es considerado una forma sencilla y cautivadora de contar historias desde la antigüedad y forma parte de la historia de la mitología y el entretenimiento. Los teatros de sombras llegaron a la antigua China mucho antes de que se inventara el cine, extendiéndose por toda Asia como forma de arte tradicional. Grupos de artistas ambulantes interpretaban sus obras usando como tema central mitos y leyendas que acompañaban con música. ¡También he oído que trae buena suerte!

Creo que es una función muy divertida y original que espero que todos disfruten. Pueden usarlo para contar sus propias historias; ¡el límite es su imaginación! Hay quien dice que cuenta la historia de dos hermanos que se enfrentan a un oponente invencible, pero prefiero dejar que cada cual interprete libremente su significado.



1:1  
2X LR 41 1.5V



## EN

### Important information about batteries

Never use different types of batteries together, or a combination of old and new batteries. Always remove the batteries if the product is not to be used for a long time or if the batteries have run down. Never use damaged batteries. Only use batteries of the type recommended, or a corresponding type. Insert the batteries so that the poles are correctly positioned. Rechargeable batteries must be recharged using the correct battery charger under the supervision of an adult. You cannot recharge batteries while they are still in the product, and you must never try to do so. Never attempt to recharge non-rechargeable batteries. Never short-circuit the battery holder.

Batteries

Batteries

Batteries

Batteries

Batteries

Batteries

## DE

### Wichtige Information zu Batterien

Benutzen Sie niemals unterschiedliche Arten von Batterien oder alte und neue gleichzeitig. Nehmen Sie stets die Batterien heraus, wenn mit dem Modell längere Zeit nicht gespielt wird oder wenn die Batterien leer sind. Verwenden Sie niemals beschädigte Batterien. Verwenden Sie ausschließlich empfohlene bzw. geeignete Batterien. Achten Sie beim Einsetzen der Batterien auf die richtige Polung. Wiederaufladbare Batterien sollten mit einem geeigneten Ladegerät aufgeladen werden – unter Aufsicht eines Erwachsenen. Wiederaufladbare Batterien können und sollten niemals aufgeladen werden, während sie sich im Modell befinden. Versuchen Sie unter keinen Umständen, „normale“ Batterien wieder aufzuladen. Schließen Sie das Batteriefach niemals kurz.

Batteries

Batteries

Batteries

Batteries

Batteries

Batteries

Batteries

Batteries

Batteries

Batteries

Batteries

Batteries

Batteries

Batteries

Batteries

Batteries

Batteries

Batteries

Batteries

Batteries

Batteries

Batteries

Batteries

Batteries

Batteries

Batteries

Batteries

Batteries

Batteries

Batteries

Batteries

Batteries

Batteries

Batteries

Batteries

Batteries

Batteries

Batteries

Batteries

Batteries

Batteries

Batteries

Batteries

Batteries

Batteries

Batteries

Batteries

Batteries

Batteries

Batteries

Batteries

Batteries

Batteries

## NL

### Belangrijke informatie over batterijen

Gebruik nooit verschillende soorten of een combinatie van oude en nieuwe batterijen tegelijkertijd. Verwijder de batterijen altijd als je het product lange tijd niet wilt gebruiken of als de batterijen leeg zijn. Gebruik nooit beschadigde batterijen. Gebruik uitsluitend batterijen van het aanbevolen type of een overeenkomstig type. Plaats de batterijen met de polen in de juiste richting. Oplaadbare batterijen moeten in een voor dit doel bestemde oplader en onder toezicht van een volwassene opnieuw worden opgeladen. Oplaadbare batterijen kunnen niet worden opgeladen terwijl ze zich nog in het product bevinden en dit mag ook nooit worden geprobeerd. Probeer nooit niet-oplaadbare batterijen opnieuw op te laden. Laat de batterijhouder nooit kortsluiten.

Batteries

Batteries

Batteries

Batteries

Batteries

Batteries

Batteries

Batteries

Batteries

Batteries

Batteries

Batteries

Batteries

Batteries

Batteries

Batteries

Batteries

Batteries

Batteries

Batteries

Batteries

Batteries

Batteries

Batteries

Batteries

Batteries

Batteries

Batteries

Batteries

Batteries

Batteries

Batteries

Batteries

Batteries

Batteries

Batteries

Batteries

Batteries

Batteries

Batteries

Batteries

Batteries

Batteries

Batteries

Batteries

Batteries

Batteries

Batteries

Batteries

Batteries

Batteries

Batteries

Batteries

Batteries

Batteries

Batteries

Batteries

Batteries

Batteries

Batteries

Batteries

Batteries

Batteries

Batteries

Batteries

Batteries

Batteries

Batteries

Batteries

Batteries

Batteries

Batteries

## SV

### Viktig information om batterier

Använd aldrig olika sorters batterier samtidigt, och inte heller en kombination av gamla och nya batterier. Ta alltid ur batterierna om produkten inte ska användas under en längre tid eller om batterierna är slut. Använd aldrig skadade batterier. Använd bara batterier av den typ som rekommenderas, eller av en motsvarande typ. Sätt i batterierna så att polerna hamnar i rätt läge. Laddningsbara batterier måste laddas med rätt slags batteriladdare och under en vuxens överinseende. Du kan inte ladda batterierna medan de fortfarande sitter i produkten, och du får heller aldrig försöka göra det. Försök aldrig ladda icke laddningsbara batterier. Kortslut aldrig batteriutrymmets kontaktytor.

Batteries

Batteries

Batteries

Batteries

Batteries

Batteries

Batteries

Batteries

Batteries

Batteries

Batteries

Batteries

Batteries

Batteries

Batteries

Batteries

Batteries

Batteries

Batteries

Batteries

Batteries

Batteries

Batteries

Batteries

Batteries

Batteries

Batteries

Batteries

Batteries

Batteries

Batteries

Batteries

Batteries

Batteries

Batteries

Batteries

Batteries

Batteries

Batteries

Batteries

Batteries

Batteries

Batteries

Batteries

Batteries

Batteries

Batteries

Batteries

Batteries

Batteries

Batteries

Batteries

Batteries

Batteries

Batteries

Batteries

Batteries

Batteries

Batteries

Batteries

Batteries

Batteries

Batteries

Batteries

Batteries

Batteries

Batteries

Batteries

Batteries

Batteries

Batteries

Batteries

Batteries

Batteries

## ZH

### 关于电池的重要信息

请勿同时使用不同类型的电池，或把新旧程度不同的电池混合使用。如果产品将有很长时间不会使用，或者电池已经没电，请注意取出电池。切勿使用已破损的电池。务必仅使用推荐类型或兼容类型的电池。装入电池时请注意正负极。如果使用充电电池，务必在成人监护下使用正确的电池充电器进行充电。电池仍在产品中时不可进行充电，请勿强行尝试充电，请勿尝试给非充电电池充电。切勿对电池仓进行短路连接。

Batteries

Batteries

Batteries

Batteries

Batteries

Batteries

Batteries

Batteries

Batteries

Batteries

Batteries

Batteries

Batteries

Batteries

Batteries

Batteries

Batteries

Batteries

Batteries

Batteries

Batteries

Batteries

Batteries

Batteries

Batteries

Batteries

Batteries

Batteries

Batteries

Batteries

Batteries

Batteries

Batteries

Batteries

Batteries

Batteries

Batteries

Batteries

Batteries

Batteries

Batteries

Batteries

Batteries

Batteries

Batteries

Batteries

Batteries

Batteries

Batteries

Batteries

Batteries

Batteries

Batteries

Batteries

Batteries

Batteries

Batteries

Batteries

Batteries

Batteries

Batteries

Batteries

Batteries

Batteries

Batteries

Batteries

Batteries

Batteries

Batteries

Batteries

Batteries

Batteries

## CZ

### Důležité informace o bateriích

Nikdy nepoužívejte najednou různé typy baterií ani kombinaci starých a nových baterií. Nebude-li se výrobek delší dobu používat nebo jsou-li se baterie vybité, vyjměte je z výrobku. Nikdy nepoužívejte poškozené baterie. Používejte pouze doporučené nebo odpovídající typy baterií. Baterie instalujte se správnou orientací pólu. Nabíjecí baterie musí být nabitý ve vhodné nabíječce pod dohledem dospělé osoby. Nabíjecí baterie nelze nabíjet, jsou-li umístěny ve výrobku, a nesmíte se o to ani pokoušet. Nikdy se nesnažte nabíjet baterie, které nejsou nabíjecími. Nikdy nezkratujte kontakty v prostoru pro baterie.

Batteries

Batteries

Batteries

Batteries

Batteries

Batteries

Batteries

Batteries

Batteries

Batteries

Batteries

Batteries

Batteries

Batteries

Batteries

Batteries

Batteries

Batteries

Batteries

Batteries

Batteries

Batteries

Batteries

Batteries

Batteries

Batteries

Batteries

Batteries

Batteries

Batteries

Batteries

Batteries

Batteries

Batteries

Batteries

Batteries

Batteries

Batteries

Batteries

Batteries

## HR

### Važne obavijesti o bateriji

Nikada nemoj koristiti različite vrste baterija zajedno, isto tako ni kombinaciju starih i novih baterija. Uvijek izvadi baterije ako dugo nećeš koristiti proizvod ili ako su one potrošene. Nikada nemoj koristiti oštećene baterije. Koristi samo preporučenu vrstu ili odgovarajuću vrstu baterija. Umetni baterije pazeci da dobro okreneš polove. Akumulatorske se baterije moraju puniti uz pomoć propisanog punjača i uz nadzor odrasle osobe. Baterije se ne smiju puniti dok su još u proizvodu i to nikada nemoj pokušavati. Nikada ne pokušavaj puniti baterije koje nisu predviđene za punjenje. Nikada ne izlazivaj kratki spoj u držaču baterija.

## SR

### Важне информације о батеријама

Никада не користите различите типове батерија заједно нити комбинацију старих и нових батерија. Увек извадите батерије уколико производ нећете дуже време користити или уколико су батерије празне. Никада не користите оштећене батерије. Употребљавајте само препоручени тип батерија или одговарајућу замену. Ставите батерије тако да су полови правилно позиционисани. Батерије на пуњење се морају пунити одговарајућим пуњачем под надзором одраслог лица. Батерије не смеете да пуните нити да покушате пунити док су у производу. Никада не покушавајте да пуните батерије које не могу да се пуне. Никада не преспajaјте полове кућишта за батерије.

## SL

### Pomembne informacije o baterijah

Nikoli ne uporabljajte skupaj različnih baterij ali kombinacije starih in novih baterij. Vedno odstranite baterije, če izdelka dlje časa ne boste uporabljali ali če so iztrošene. Nikoli ne uporabljajte poškodovanih baterij. Uporabljajte le baterije priporočenega ali ustreznega tipa. Baterije vstavite tako, da so njihovi poli pravilno obrnjeni. Akumulatorske baterije je treba polniti s pravim polnilnikom pod nadzorom odrasle osebe. Akumulatorskih baterij ni mogoče polniti, dokler so še v izdelku. Tega tudi ne smete poskušati. Nikoli ne poskušajte polniti baterij, ki niso akumulatorske. Pazite, da ležišč za baterije ne boste spravili v kratek stik.

## RO

### Informații importante despre baterii

Nu folosiți niciodată împreună tipuri diferite de baterii, sau o combinație de baterii vechi și noi. Îndepărtați întotdeauna bateriile dacă produsul nu este folosit timp îndelungat sau dacă bateriile s-au epuizat. Nu folosiți niciodată baterii deteriorate. Folosiți numai baterii de tipul recomandat, sau un tip corespunzător. Introduceți bateriile astfel ca polii să fie poziționați corect. Bateriile reincărcabile trebuie reincărcate utilizând încărcătorul corect sub supravegherea unui adult. Nu puteți reincărca bateriile în timp ce acestea sunt încă în produs, și niciodată nu trebuie să încercați să faceți acest lucru. Nu încercați niciodată să reincărcați baterii nereîncărcabile. Nu scurtcircuitați niciodată suportul bateriei.

## BG

### Важна информация за батериите

Не използвайте различни типове батерии едновременно или комбинация от стари и нови батерии. Винаги изваждайте батериите, ако izdelieto няма да се използва продължително време или ако батериите са се изтозили. Не използвайте повредени батерии. Използвайте само батерии от препоръчвания тип или съответстващ на него тип. Поставайте батериите така, че полюсите да са разположени правилно. Акумулаторните батерии трябва да се зареждат с подходящо зареждащо устройство под надзора на възрастни. Батериите не могат да се зареждат, докато са поставени в izdelieto, така че не трябва да се опитвате да правите това. Не се опитвайте да зареждате батерии, които не са акумулаторни. Не свързвайте в късо съединение контактите на отделението за батериите.

## LV

### Svarīga informācija par baterijām

Nekad vienlaikus nelietojiet dažādu tipu, kā arī vecas un jaunās baterijas. Vienmēr izņemiet baterijas, ja tās ir izlādējušās vai ja produkts ilgāku laiku netiek lietots. Nekad nelietojiet bojātas baterijas. Lietojiet tikai ieteicamā tipa vai atbilstoša tipa baterijas. Ievietojot baterijas, ievērojiet pareizu polaritāti. Uzlādējamu bateriju lādēšanai izmantojiet atbilstošu bateriju lādētāju; uzlāde jāveic pieaugušo uzraudzībā. Baterijas nevar uzlādēt un nekad nedrīkst mēģināt uzlādēt, kamēr tās ievietotas produktā. Nemēģiniet uzlādēt baterijas, kas nav uzlādējamas. Nepieļaujiet issavienojumu bateriju nodalījumā.

## ET

### Oluline teave patareide kohta

Ära kunagi kasuta koos erinevat tüüpi patareisid, samuti vanu ja uusi patareisid. Kui mänguasja ei kasutata pika aja jooksul, võta patarei sellest välja. Ära kunagi kasuta kahjustatud patareisid. Kasuta ainult ettenähtud tüüpi või neile samaväärseid patareisid. Pane patareid mänguasja sisse nii, et pluss- ja miinusklemmi asend oleks õige. Akusid tuleb laadida ainult neile ettenähtud akulaadija abil täiskasvanu järelevalve all. Akusid ei saa laadida sel ajal, kui need on mänguasja sees. Ära kunagi püüa nii teha. Ära kunagi proovi akulaadijaga laadida tavalisi patareisid. Patareipeesa klemmide vahel ei tohi tekkida lühis.

## LT

### Svarbi informacija apie elementus

Vienu metu nenaudokite skirtingu elementu, taip pat su naujais elementais nenaudokite senų. Jei nenaudosite gaminio ilgesnį laiką arba jei elementai išseko, visuomet išimkite juos iš gaminio. Niekada nenaudokite pažeistų elementu. Naudokite tik rekomenduojamo arba atitinkamo tipo elementus. Elementus dėkite atsizvelgdami į jų poliškumą. Elementus galima įkrauti tik tinkamu krovikliu ir prižiūrint suaugusiesiems. Jokiu būdu negalima, ir niekuomet nebandykite, įkrauti elementu neišėmus jų iš gaminio. Niekada nebandykite įkrauti vienkartinių elementų. Saugokitės, kad elementų įdėkle nesukeltumėte trumpojo jungimo.

## TR

### Piller hakkında önemli bilgiler

Hiçbir zaman değişik tipte pilleri ya da eski pillerle yeni pilleri bir arada kullanmayın. Ürün uzun süre pilli kullanılamayacaksa ya da piller bitmişse, pilleri çıkarın. Hiçbir zaman zedelenmiş piller kullanmayın. Sadece önerilen tipte piller ya da bunların dengi olan piller kullanın. Pilleri kutuları doğru konumda olacak şekilde yerleştirin. Bitince şarjlı pilleri doğru pil şarj aletini kullanarak, bir yetişkinin denetiminde şarj edin. Şarjlı pilleri, ürünün içindeyken şarj edemezsiniz ve hiçbir zaman bunu yapmaya çalışmayın. Hiçbir zaman, şarjlı olmayan pilleri şarj etmeye çalışmayın. Hiçbir zaman pil kutusuna kısa devre yaptırmayın.



[LEGO.com/brickseparator](https://LEGO.com/brickseparator)

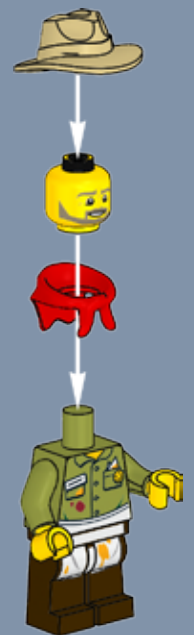
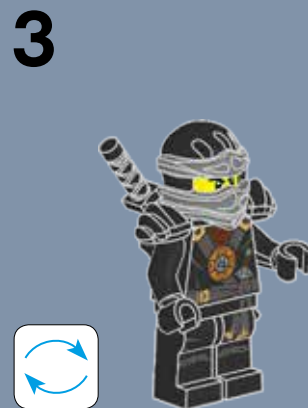
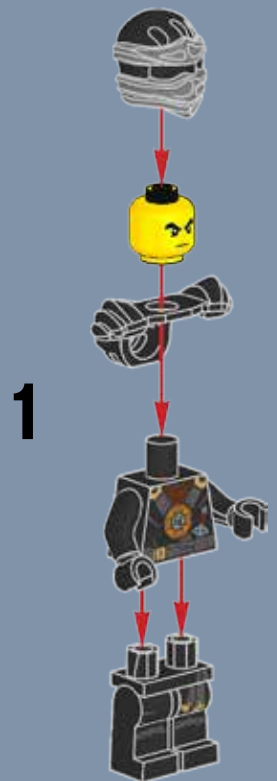
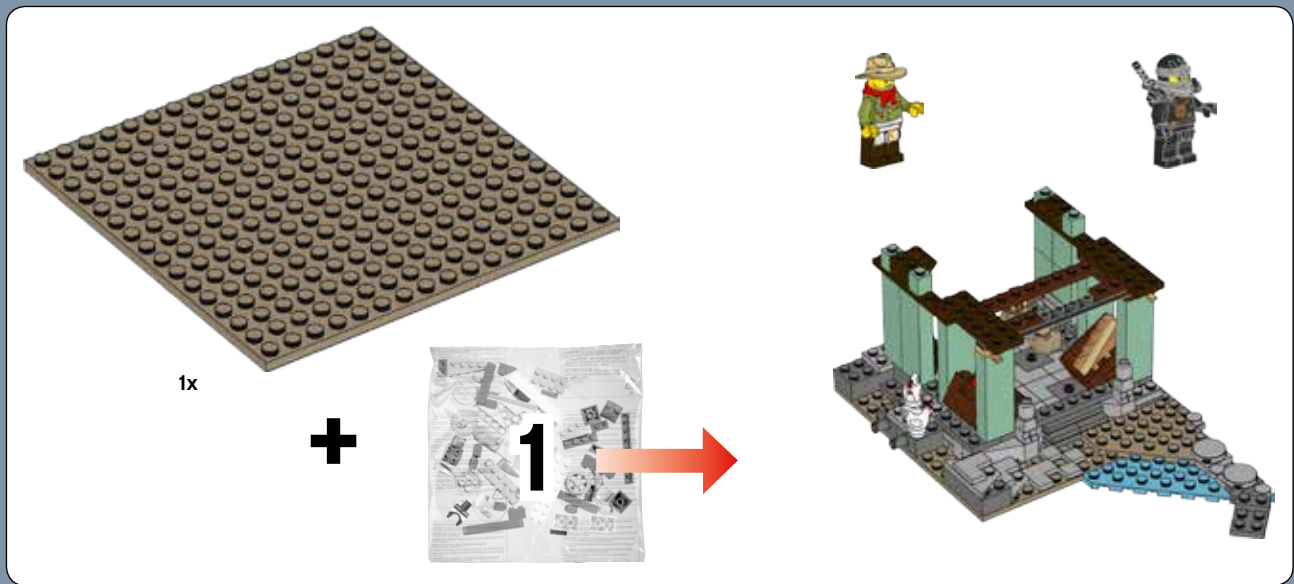

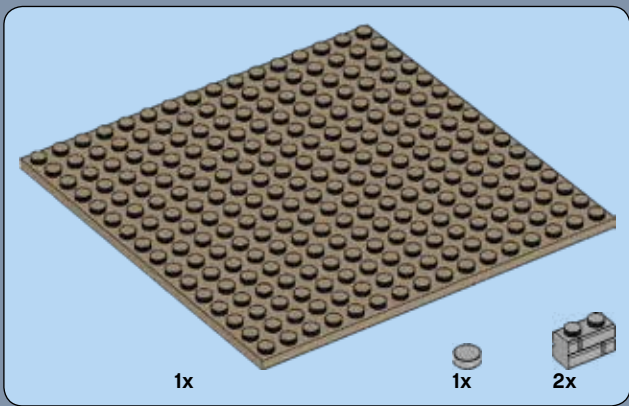

1





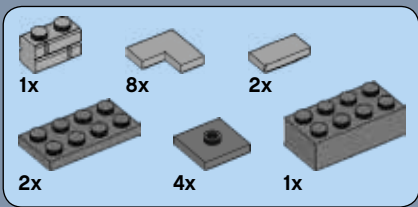

3

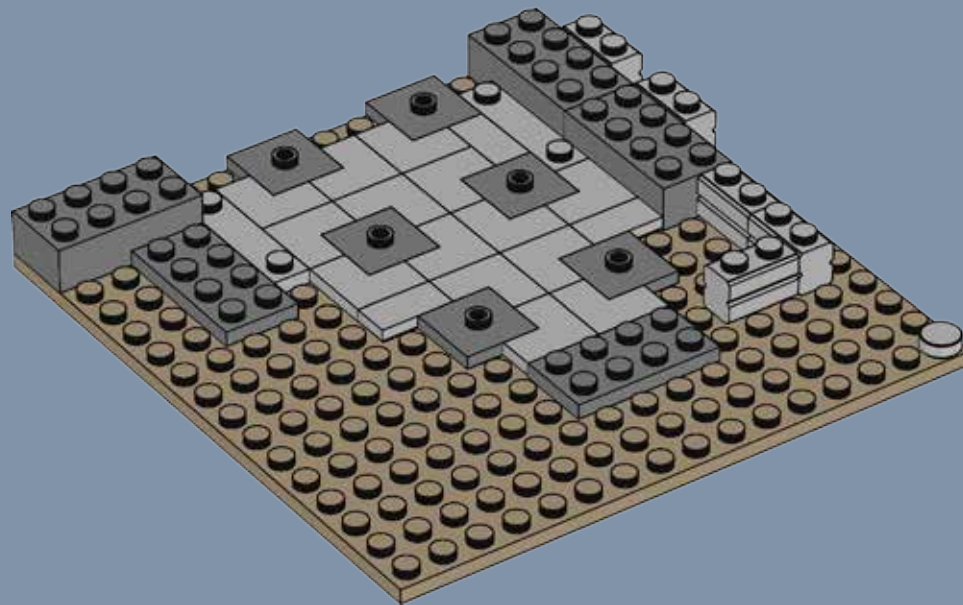



2x



2x



2x

# 4

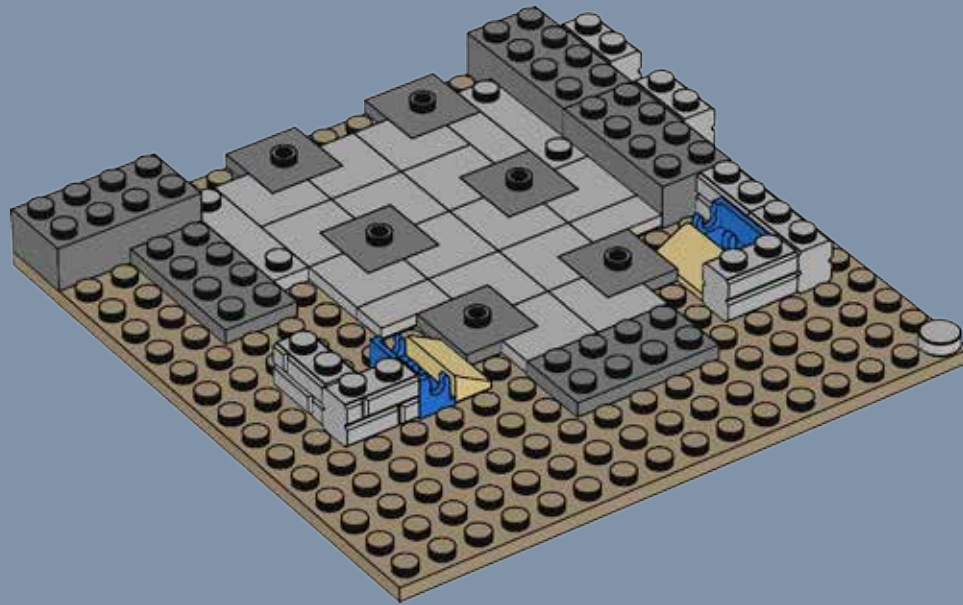



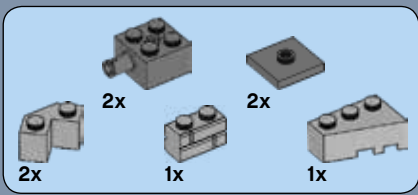

5



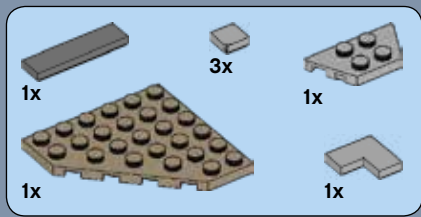

6

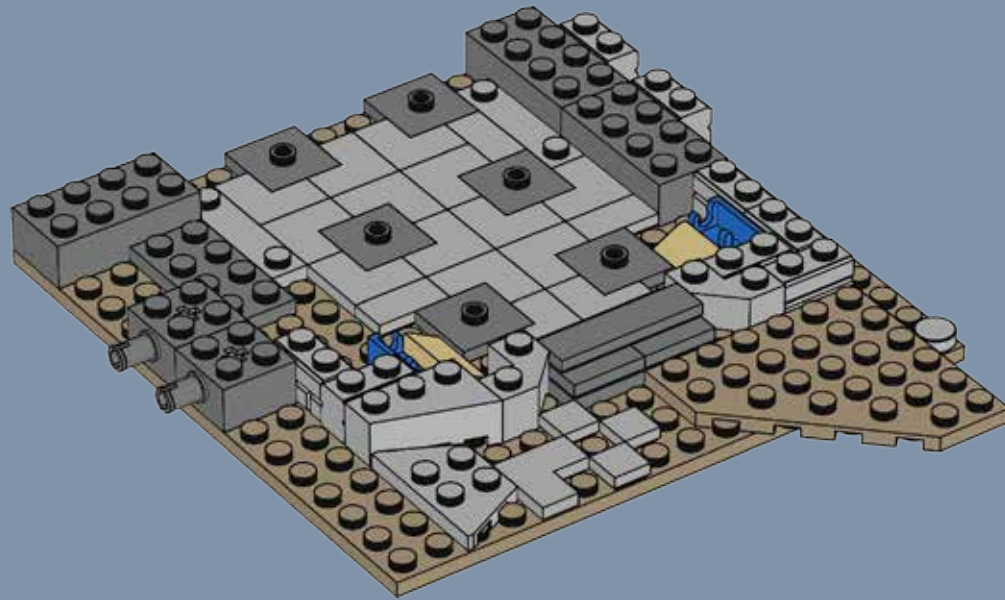

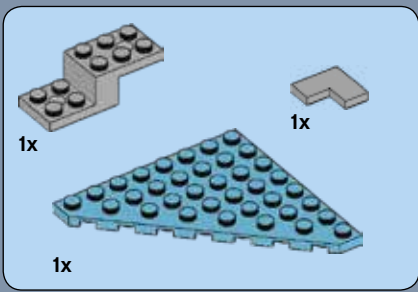

7

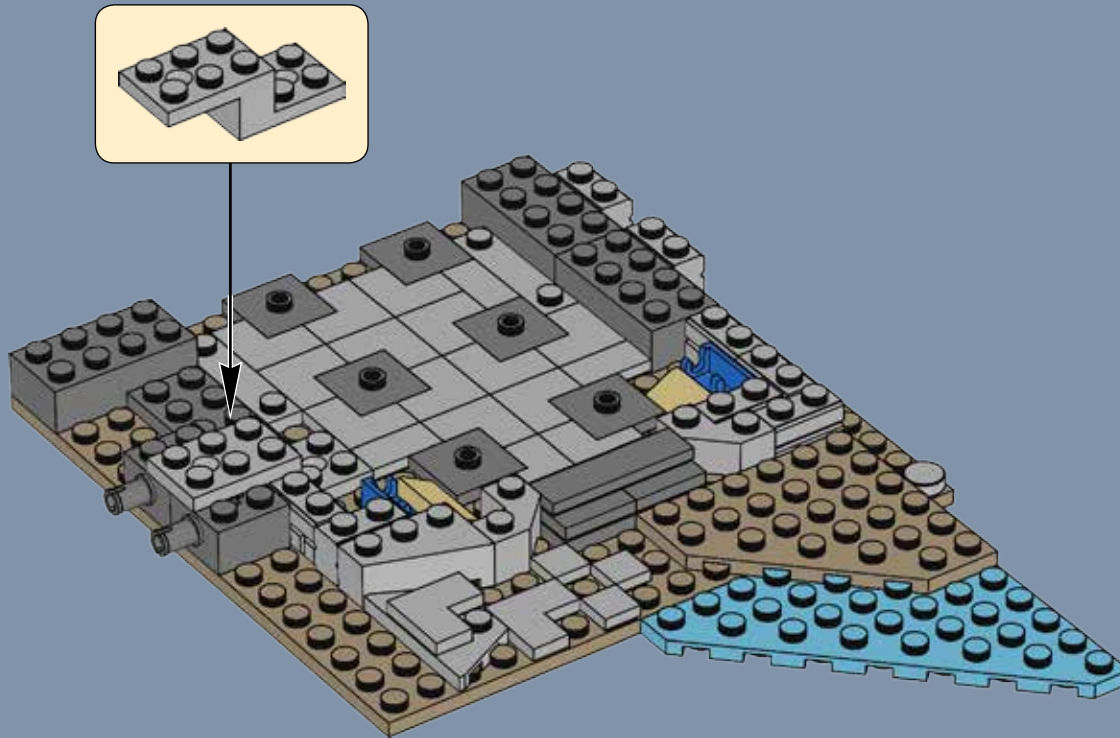

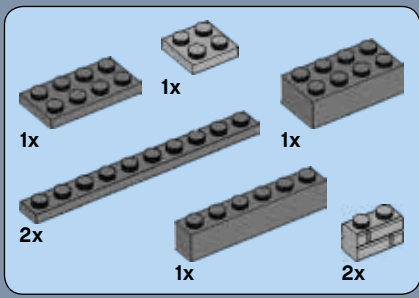

8

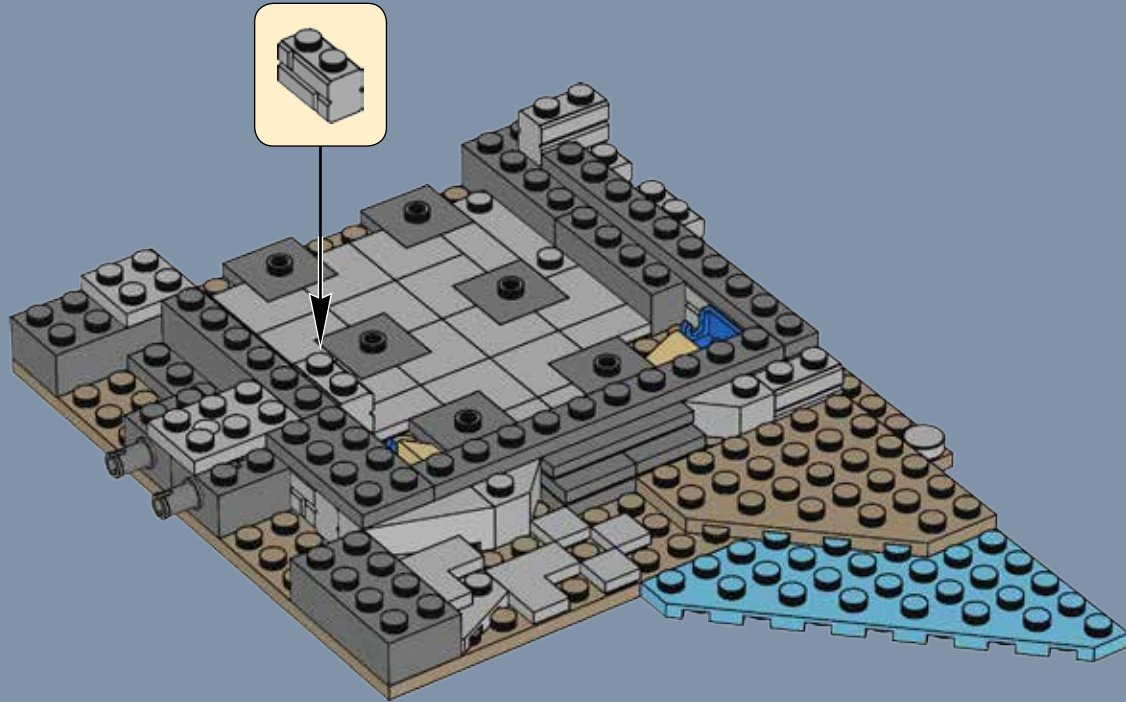

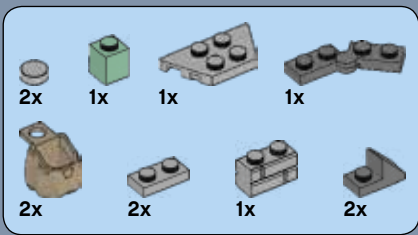

9

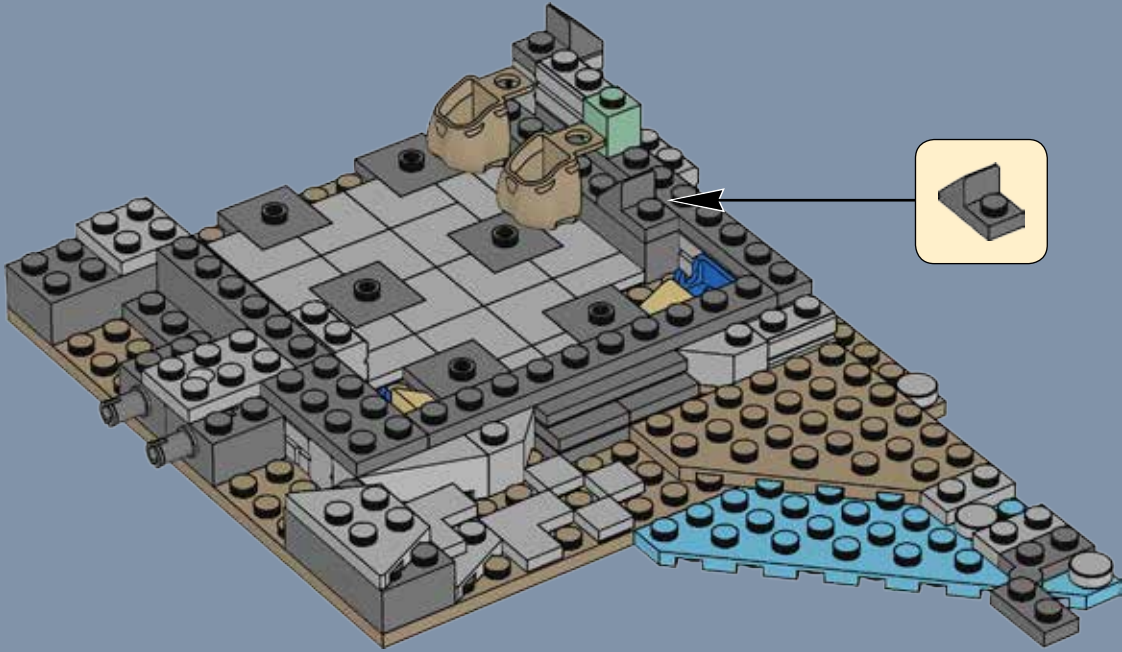



# 10

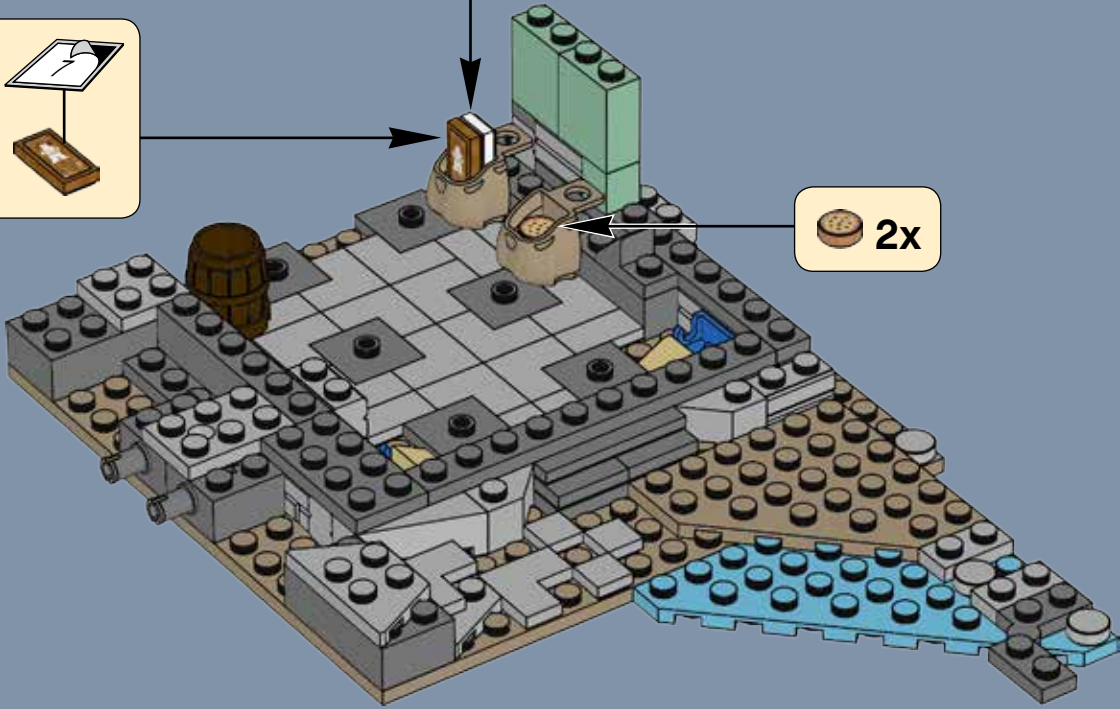
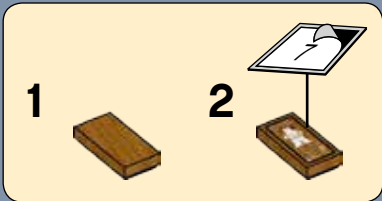
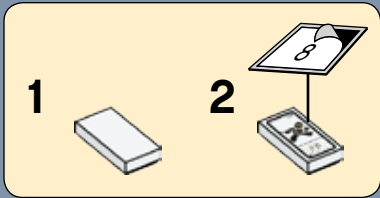

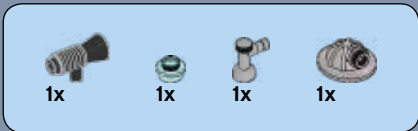

11

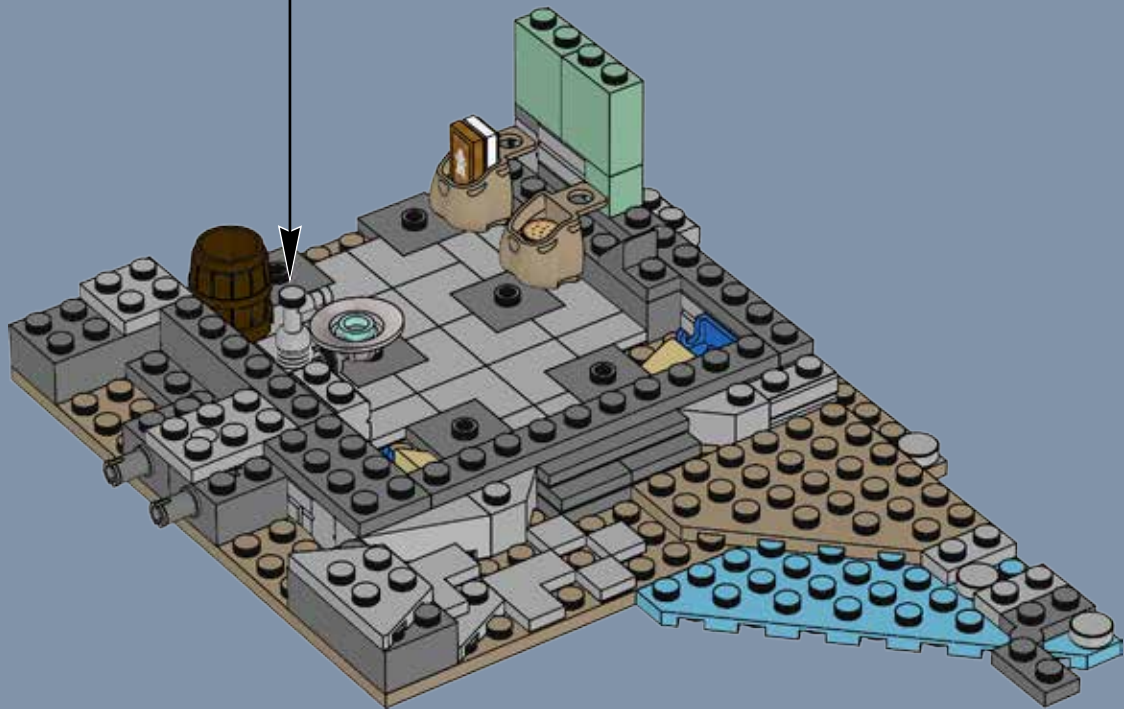

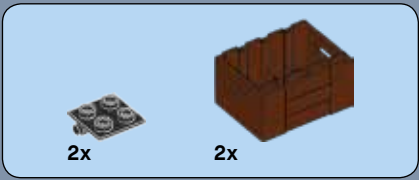

# 12

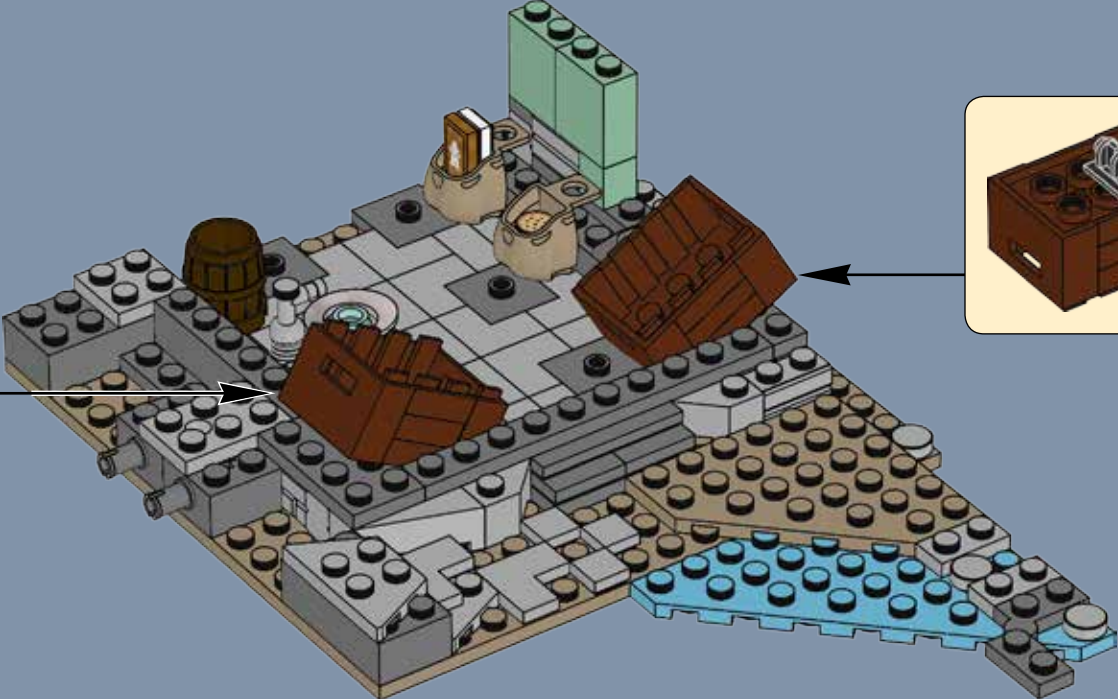



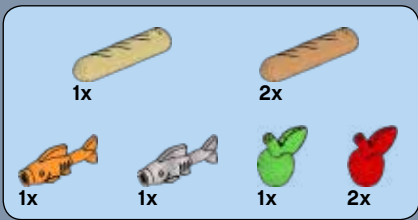

13

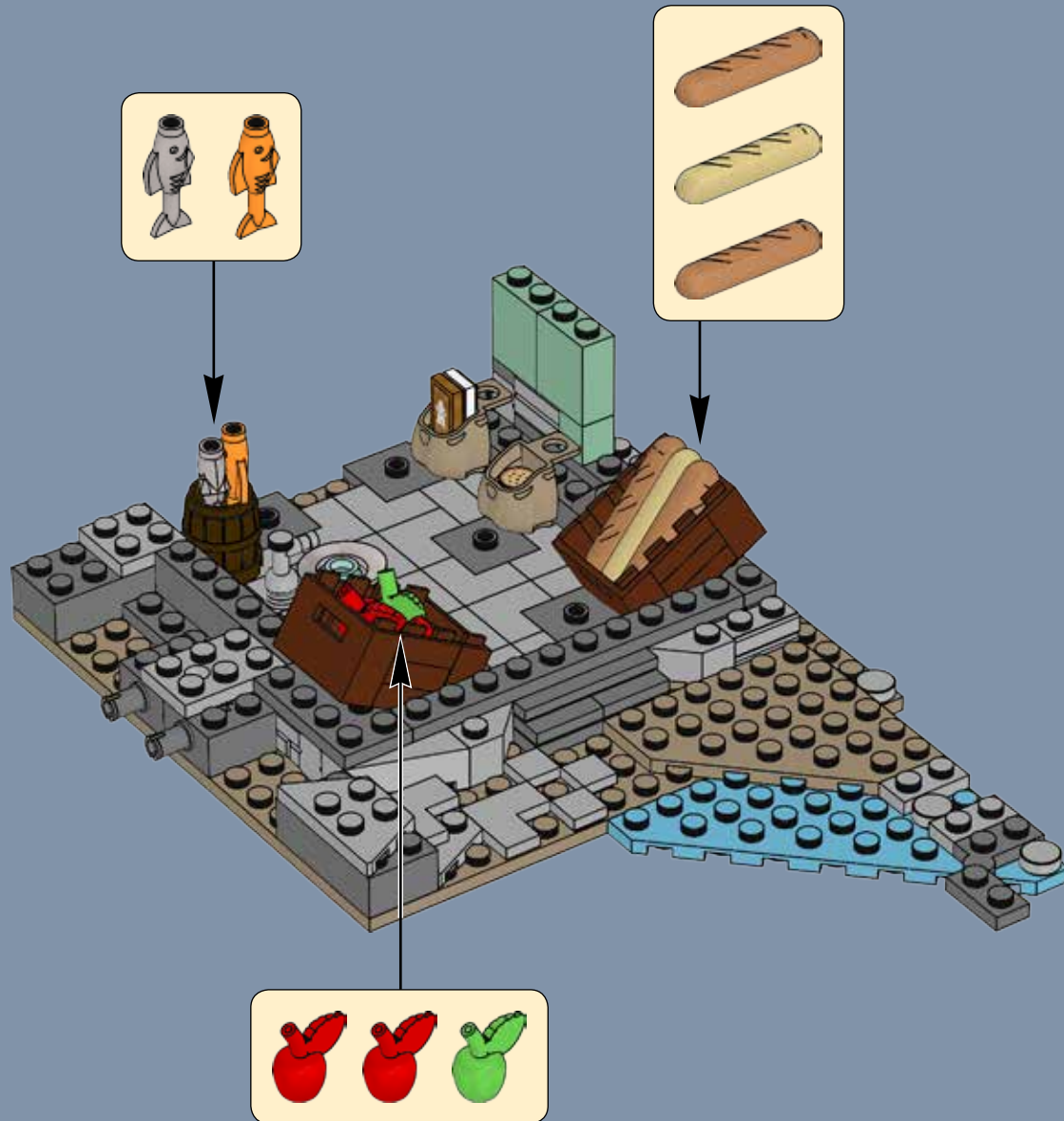

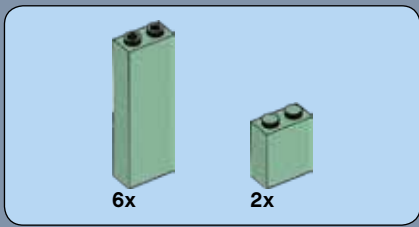

14





15

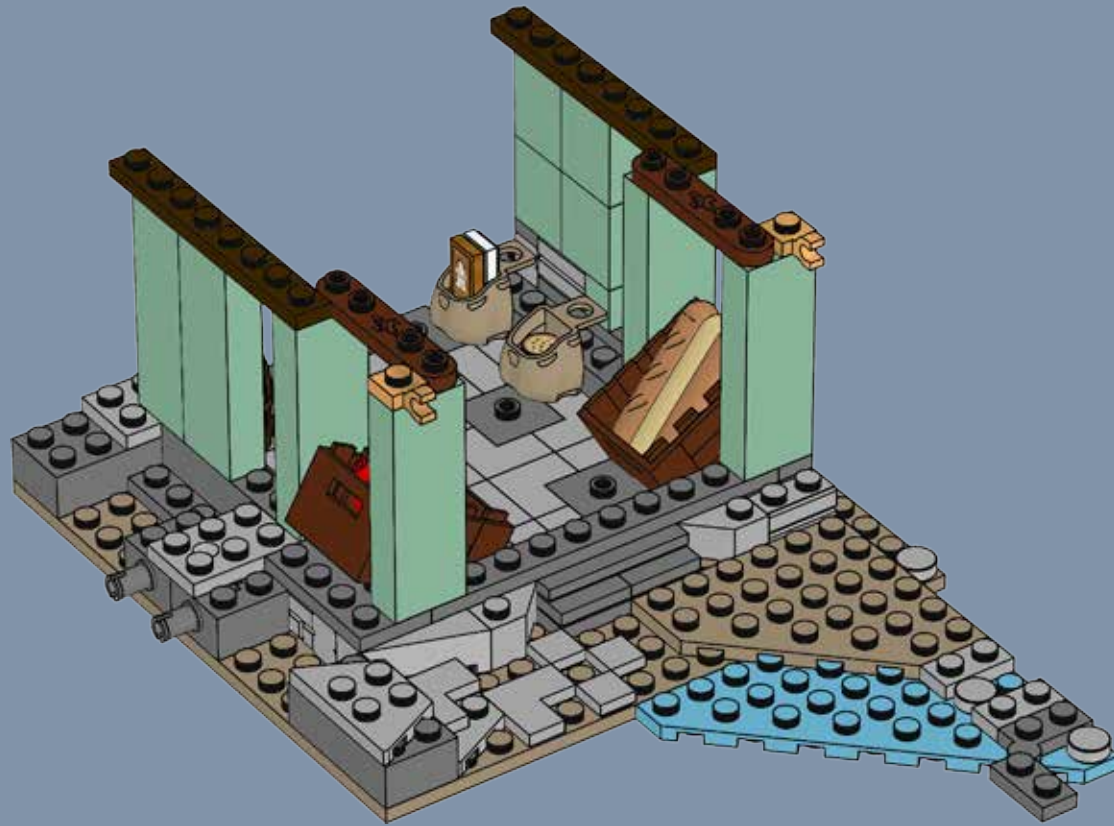

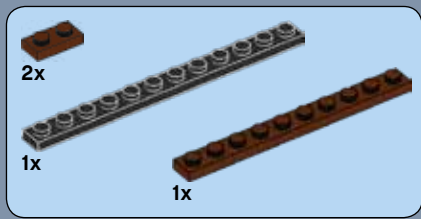

# 16

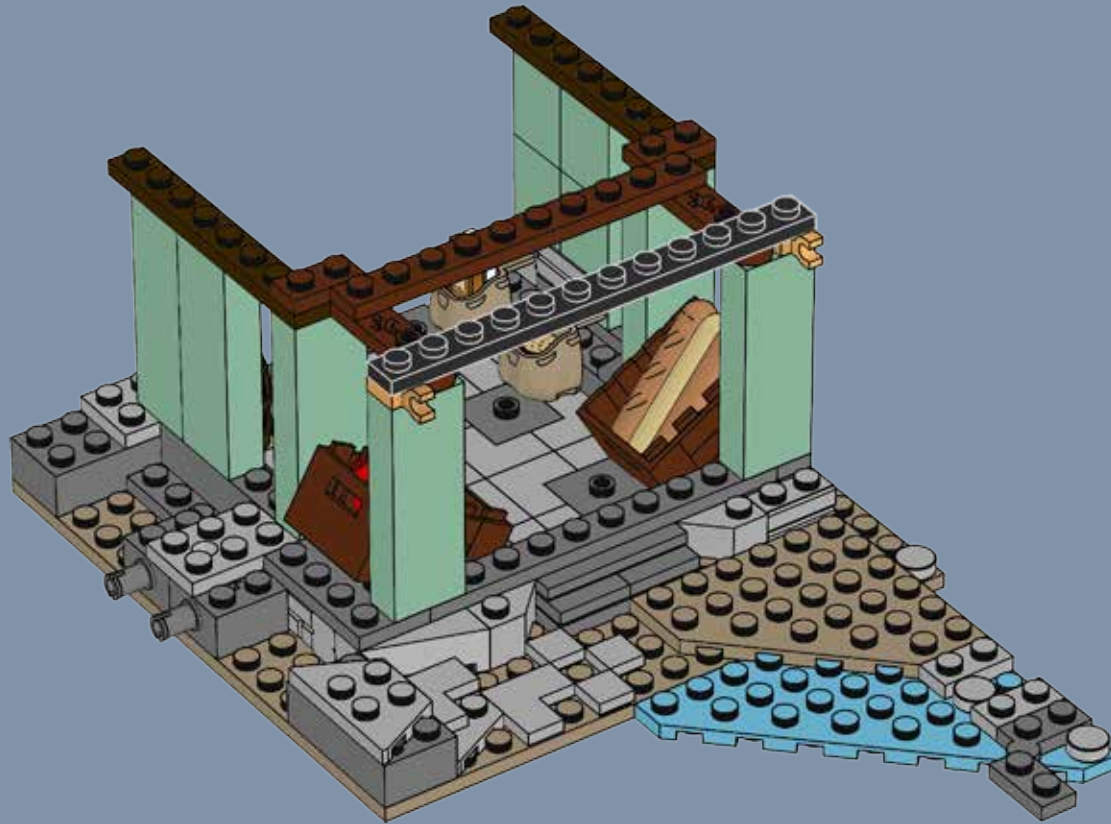

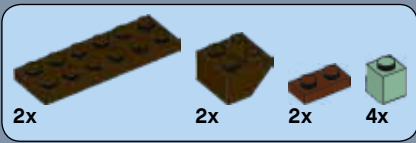

17

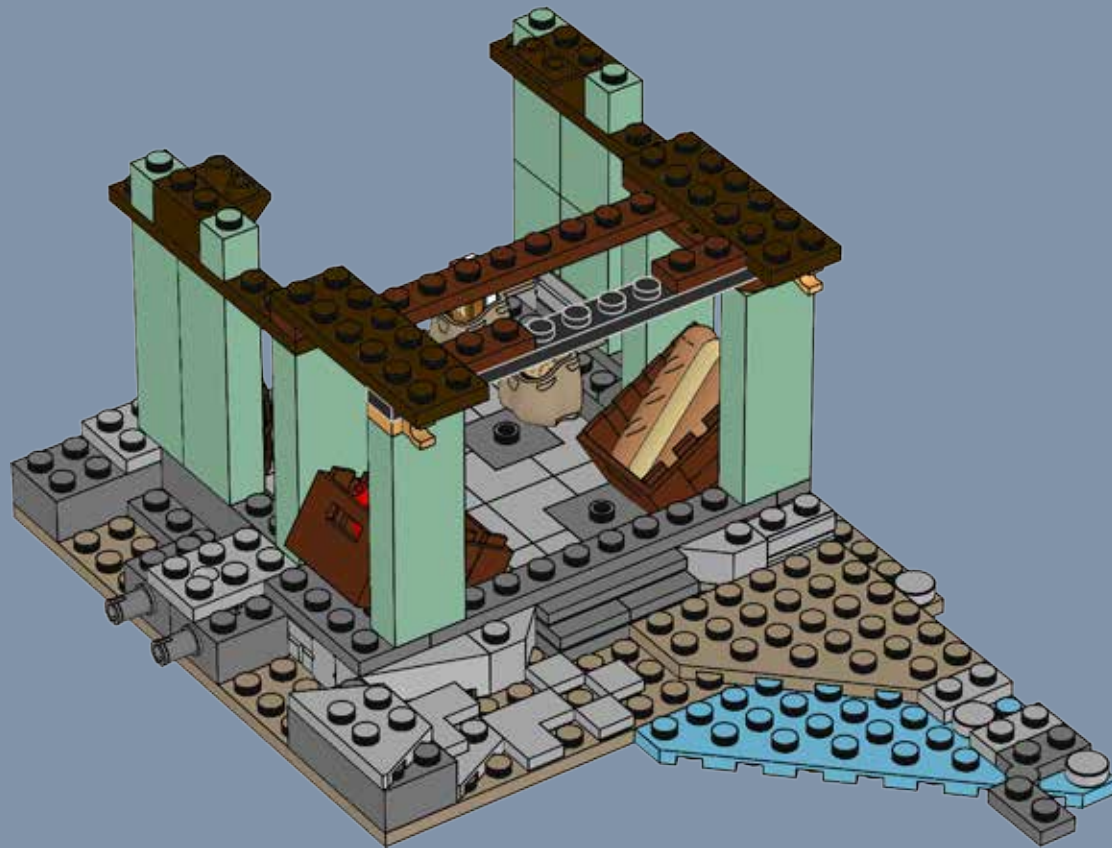

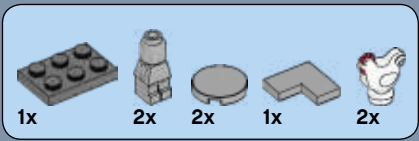

# 18

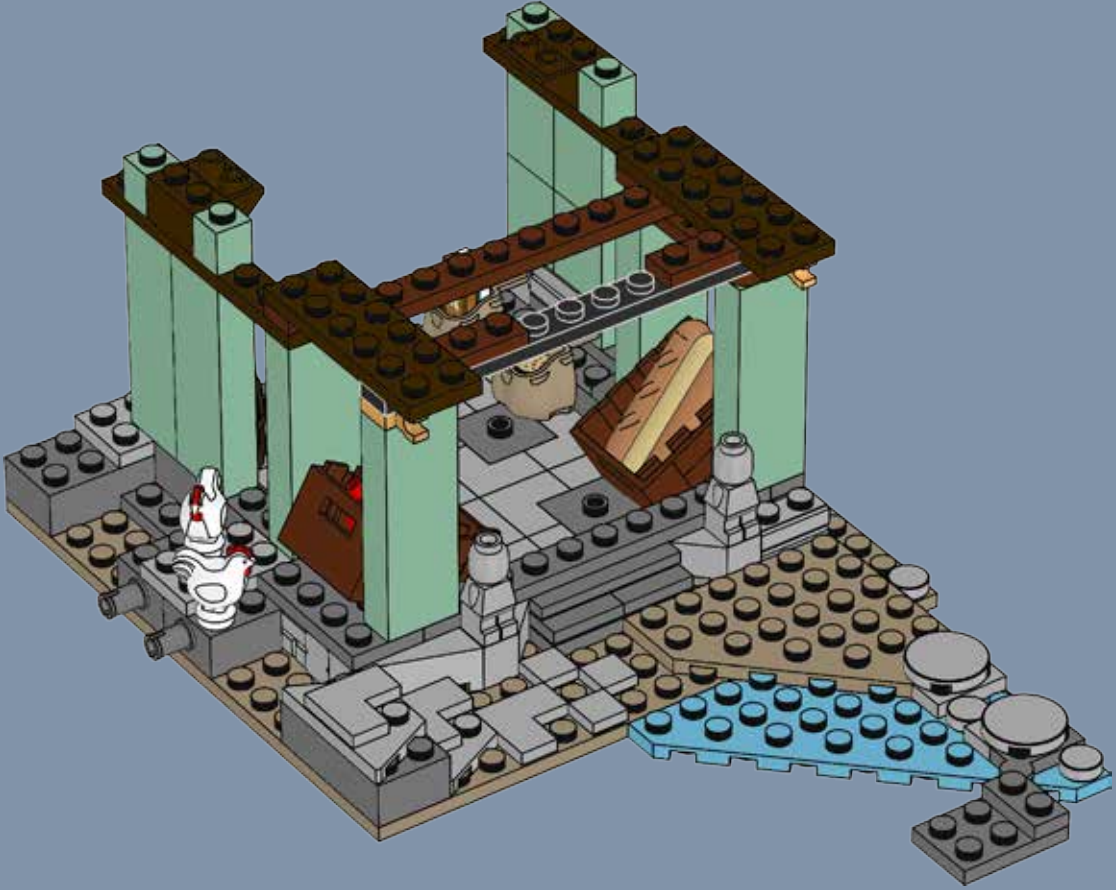

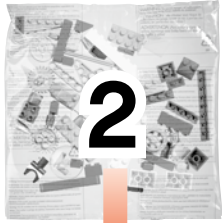

19

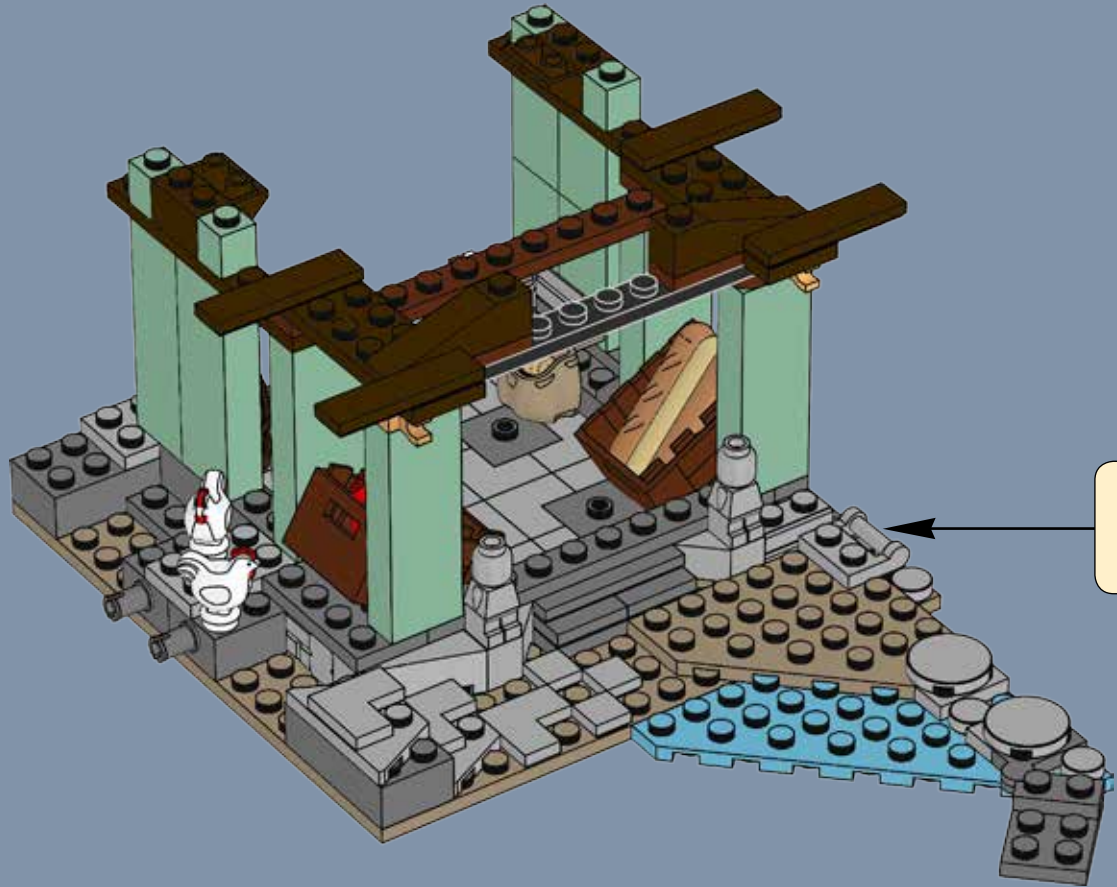

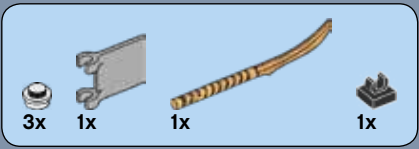

20

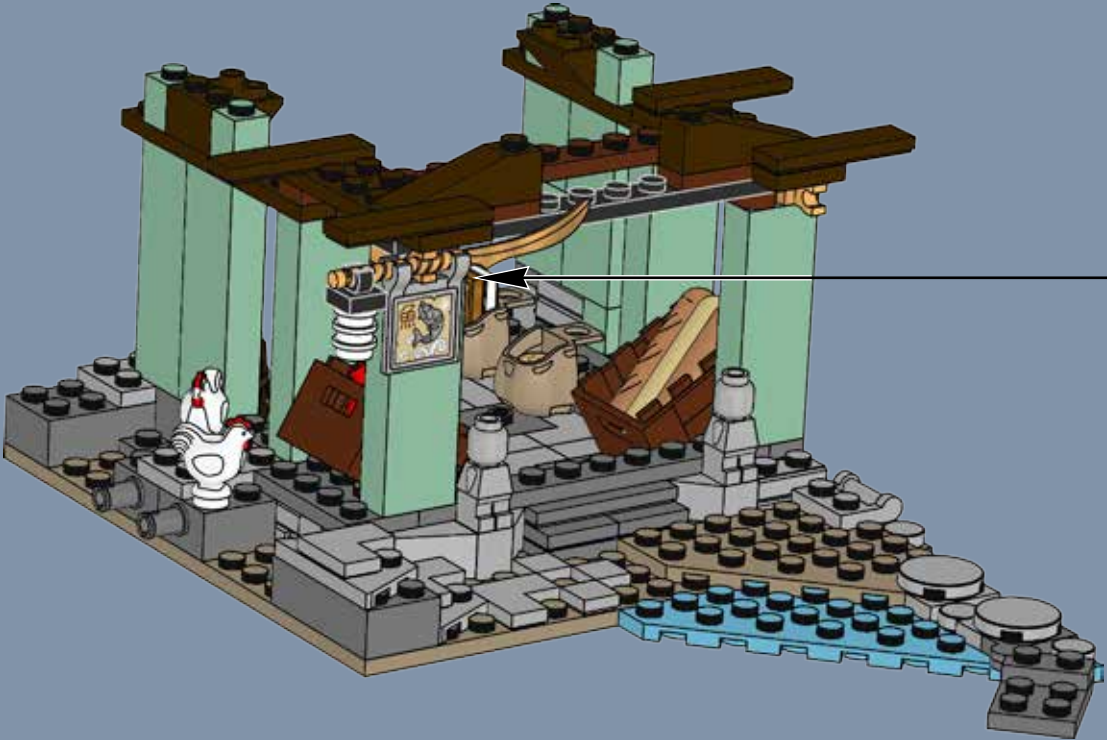
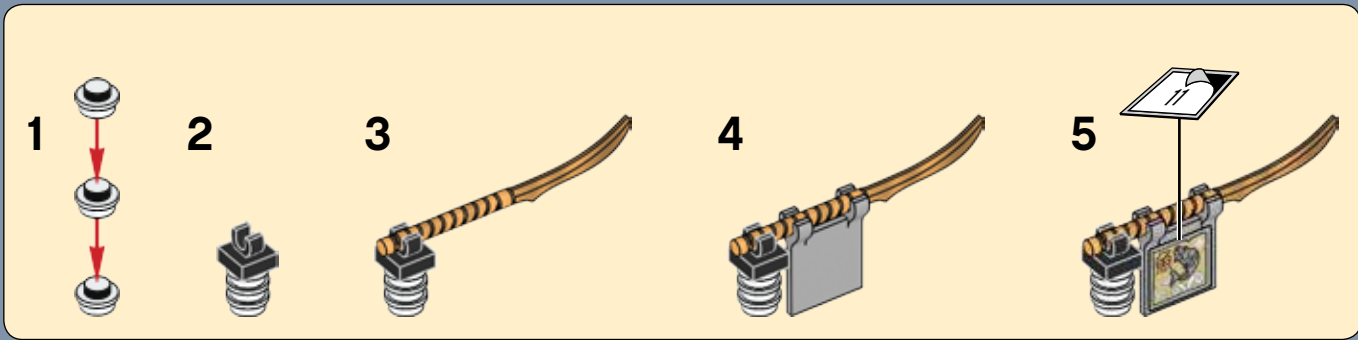



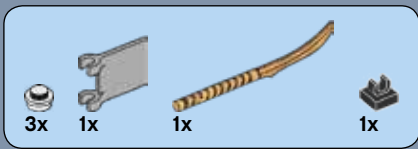

21

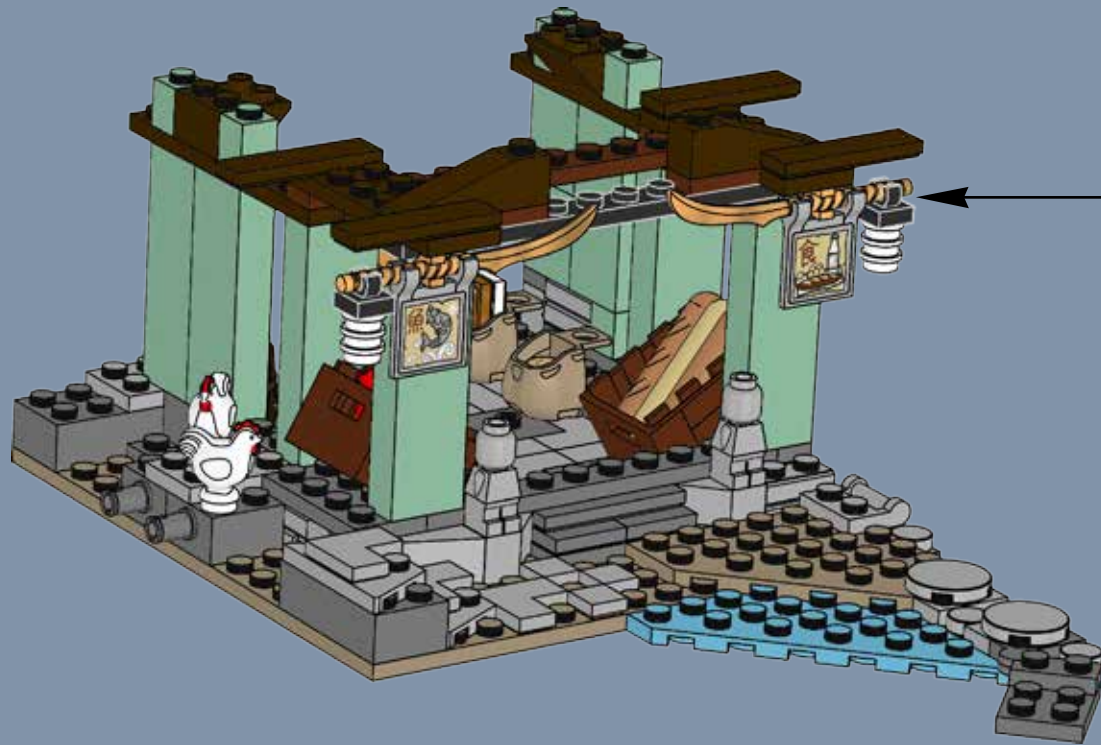

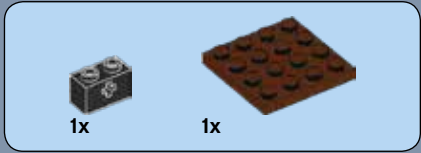
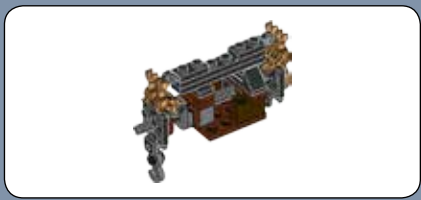

1

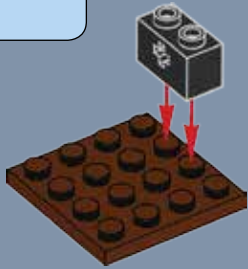

2



3



4

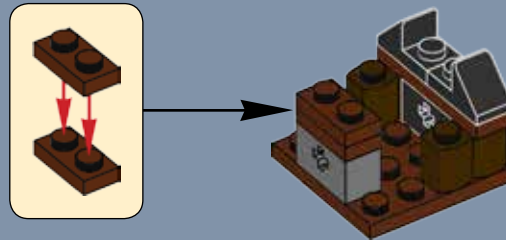

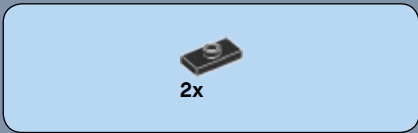

5

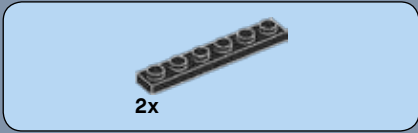

6

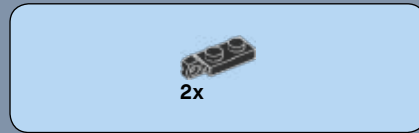
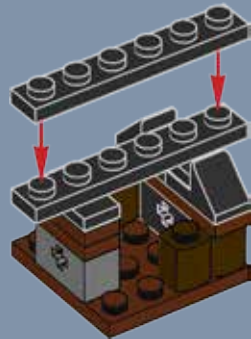

7

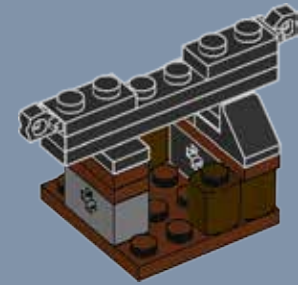

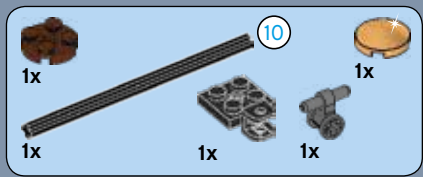

# 8

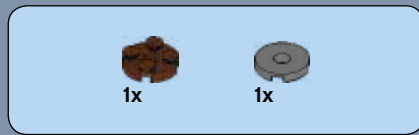
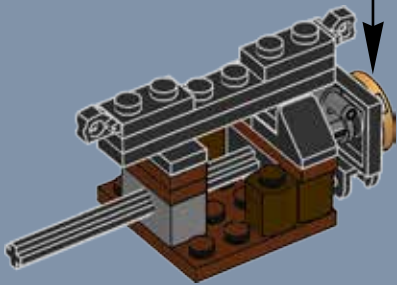
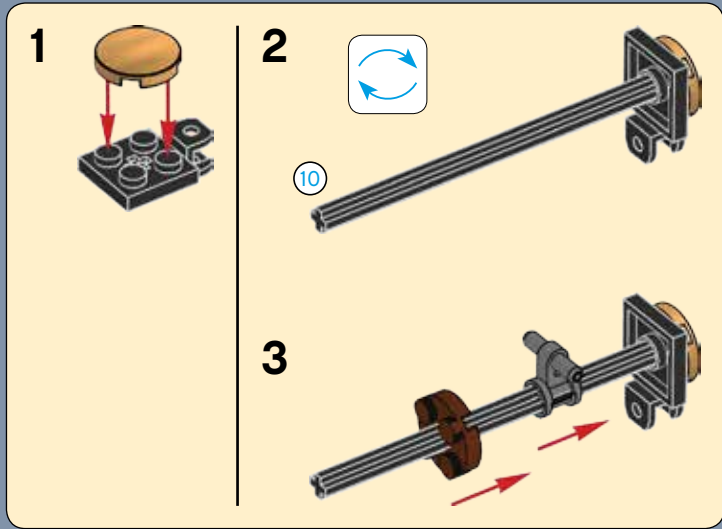

# 9

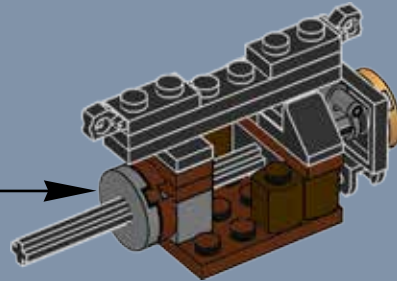
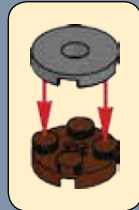

# 10

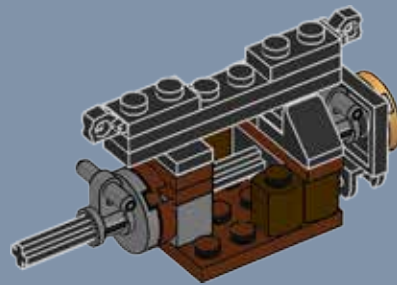



11

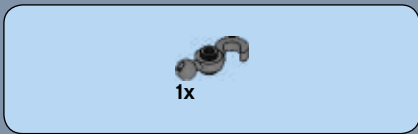
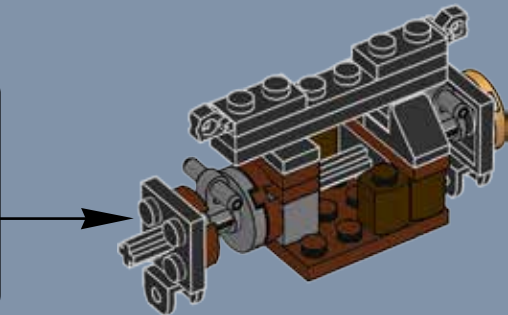

12

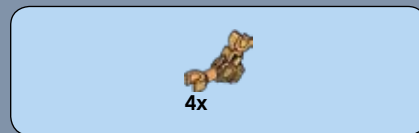
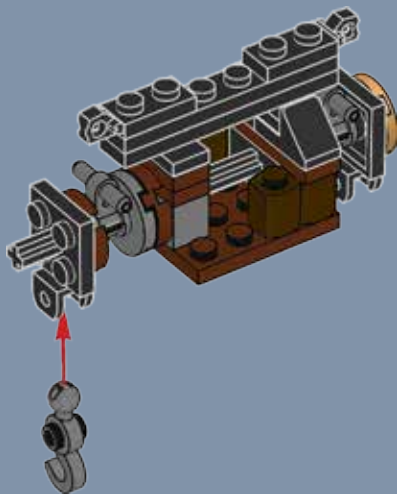

13

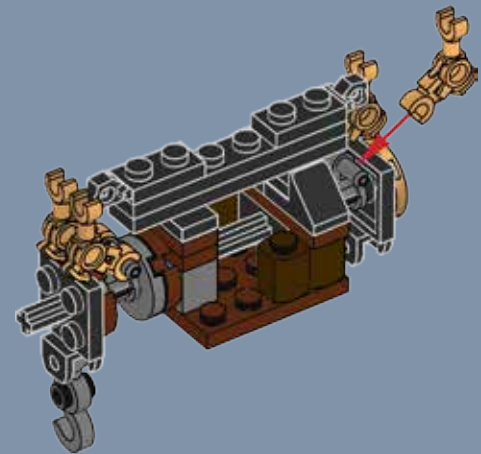

22

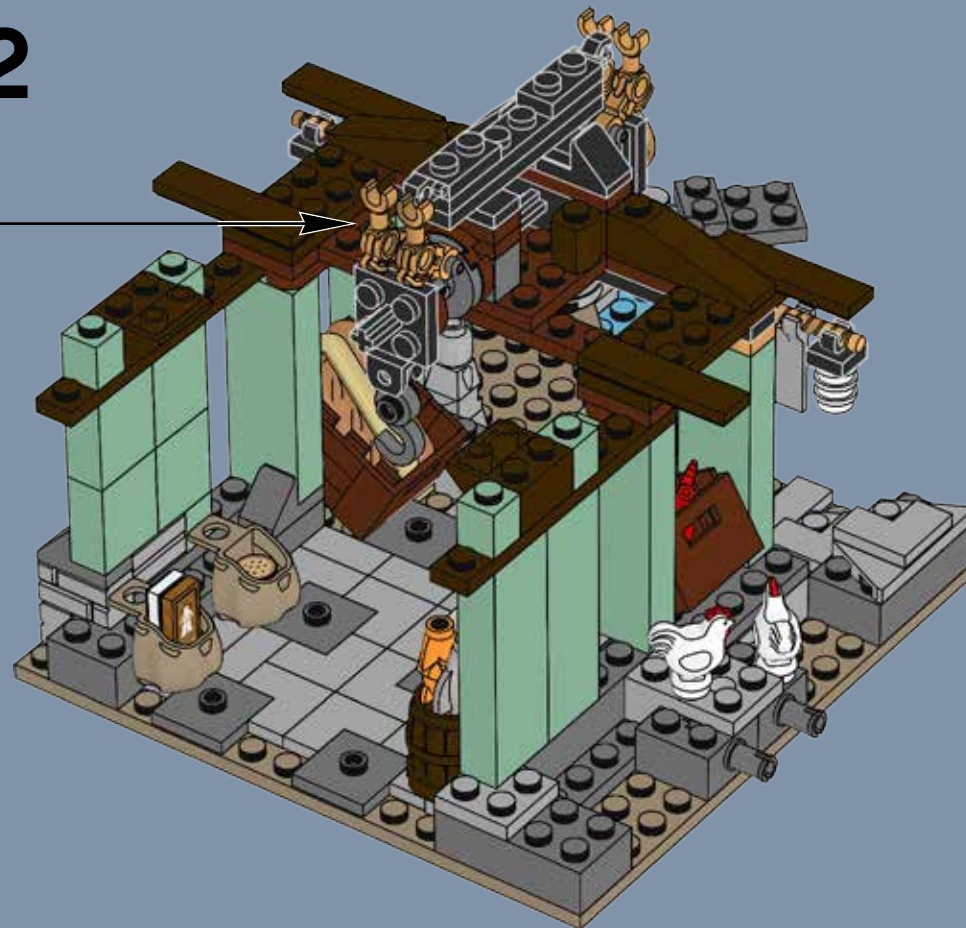



23

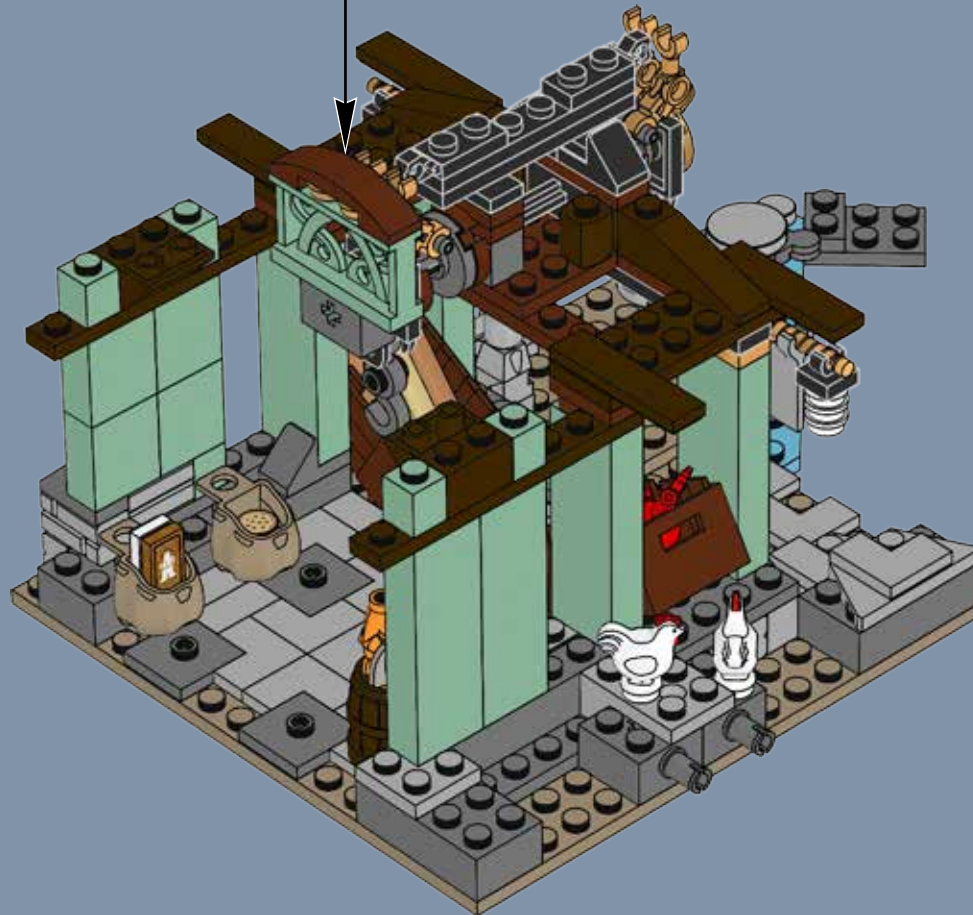
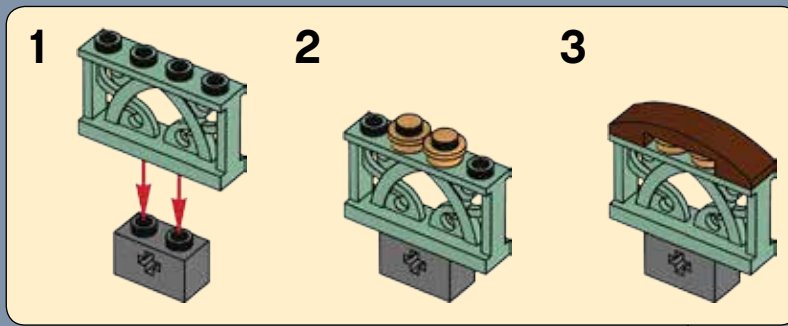

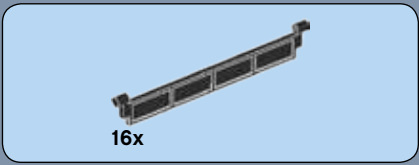

24

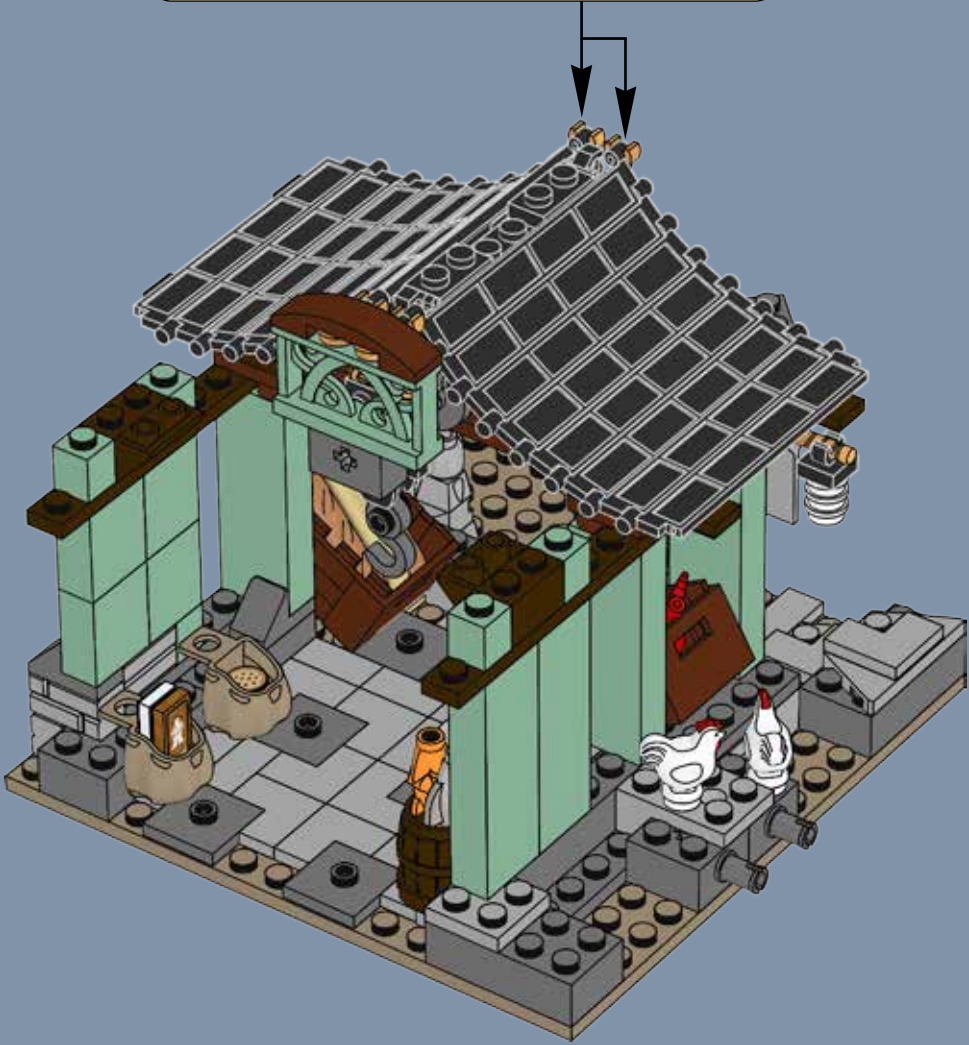
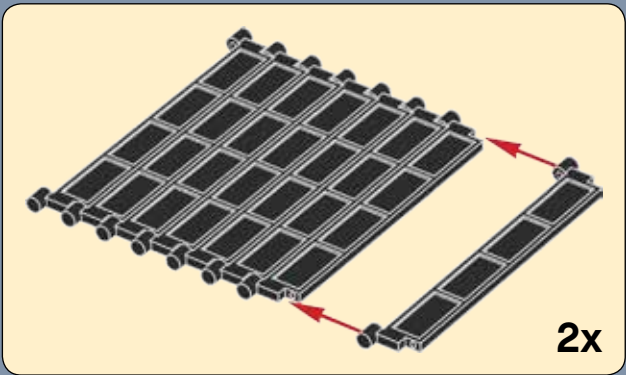



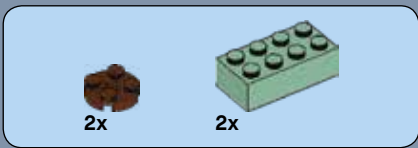

# 25

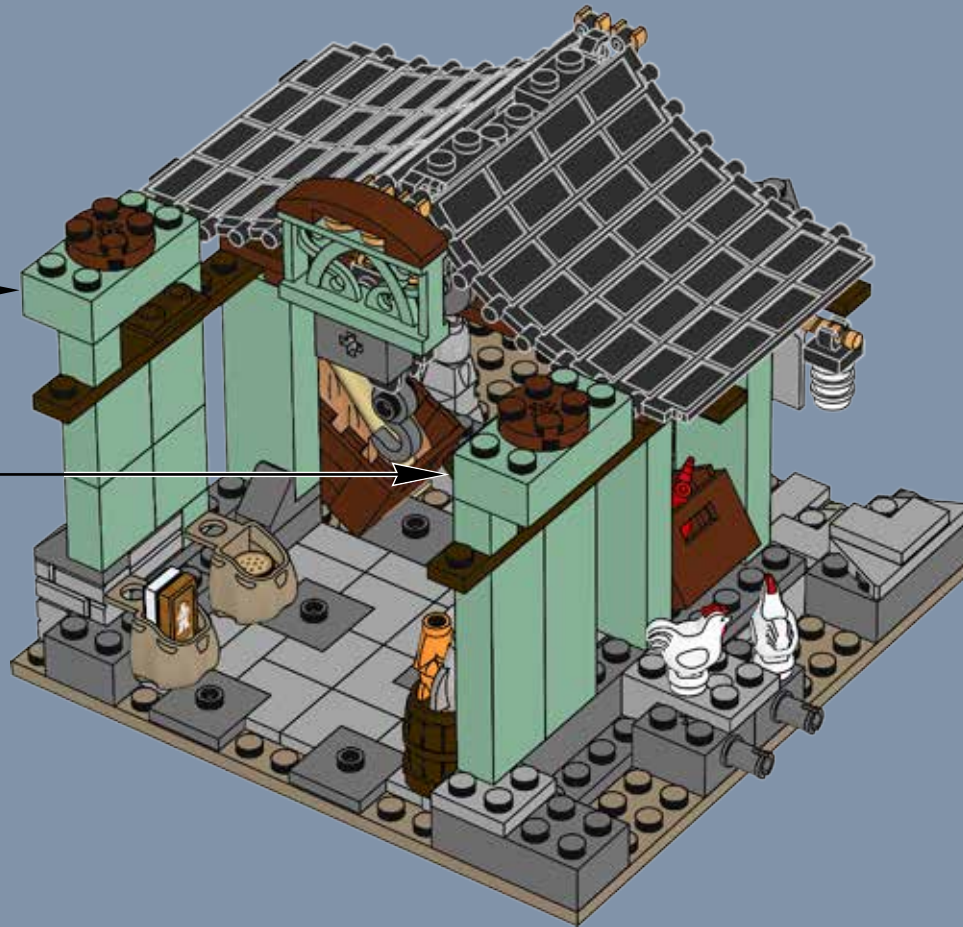
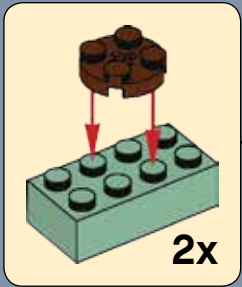

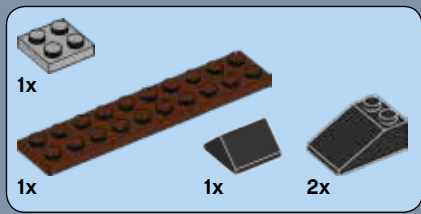

# 26

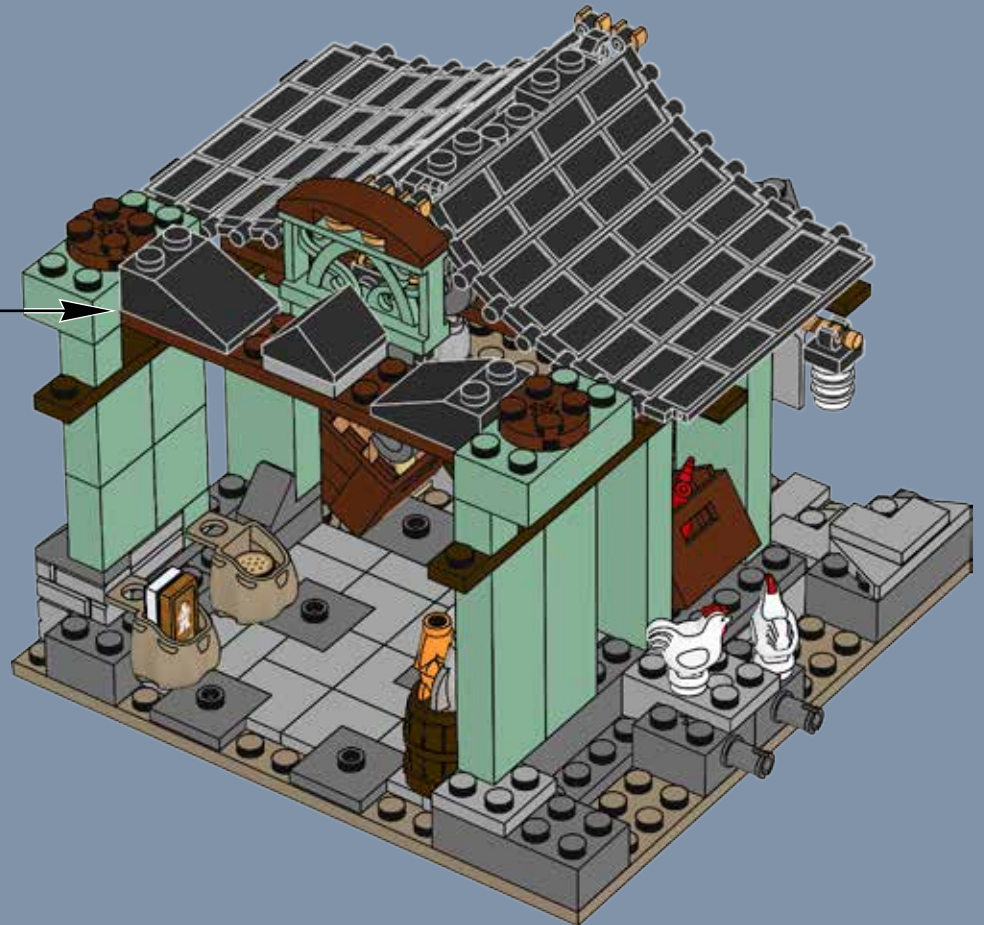
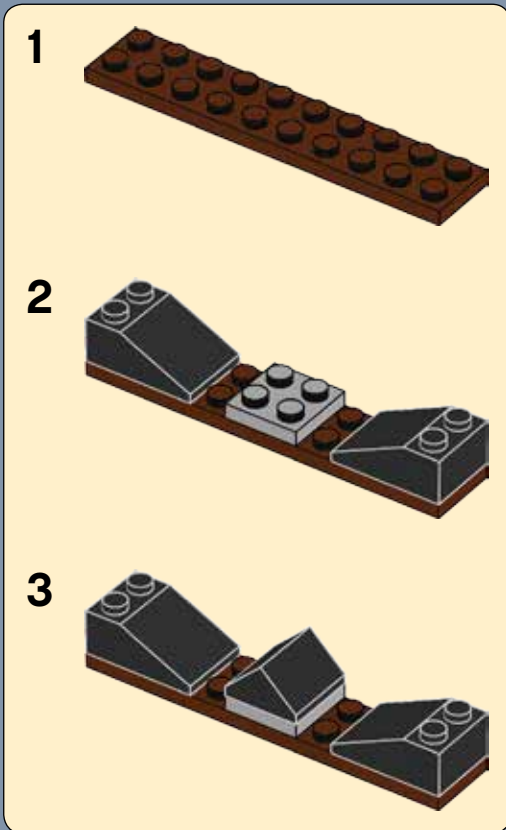



4x

# 27

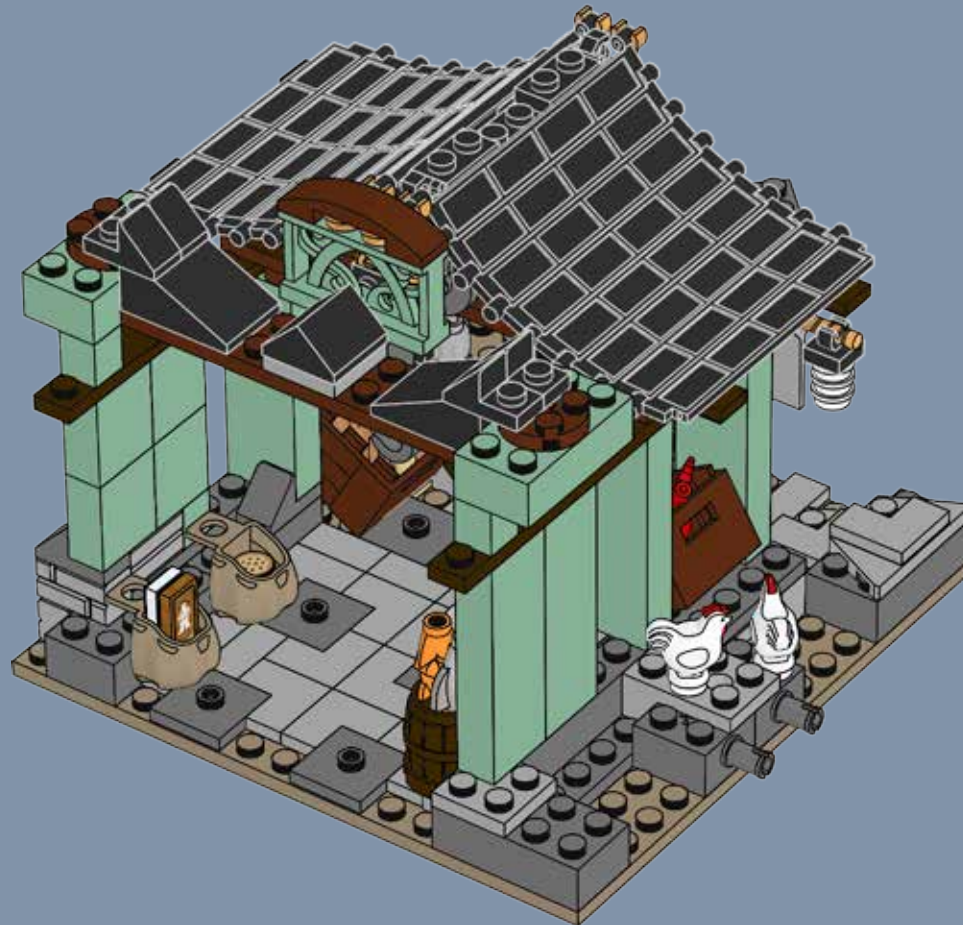

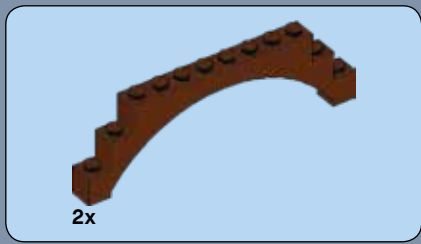

28

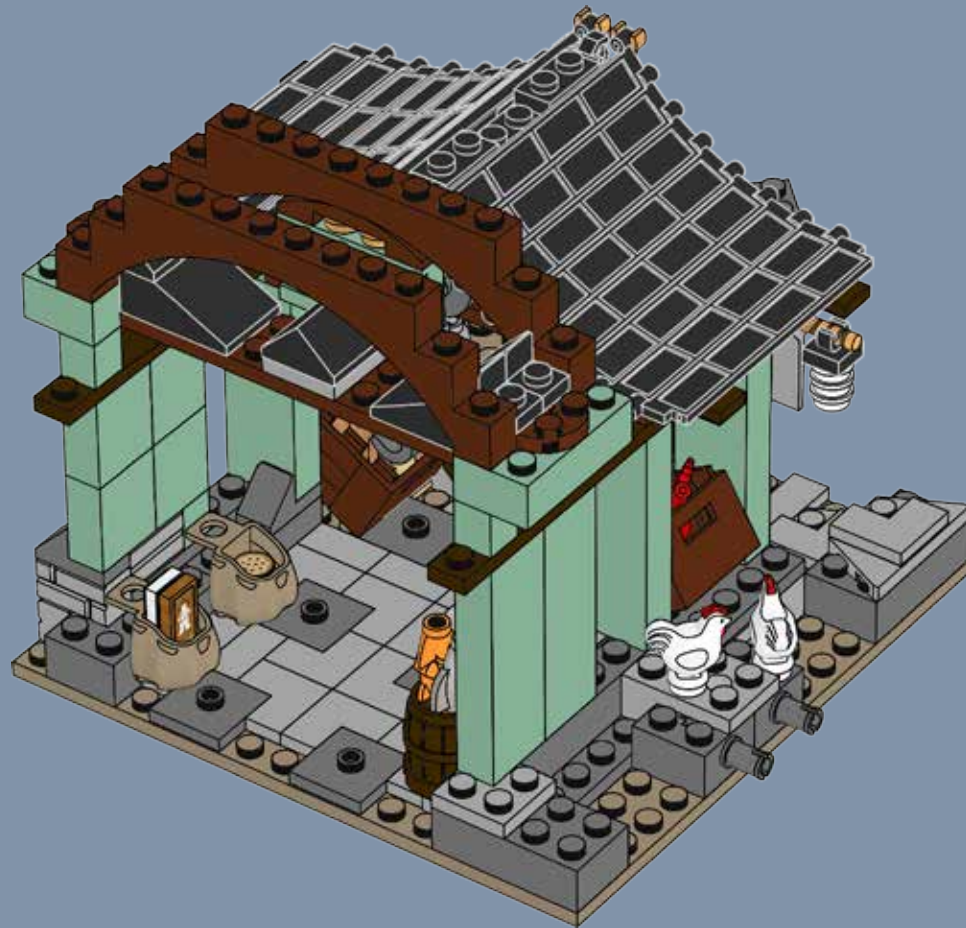

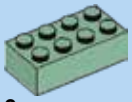

2x

# 29

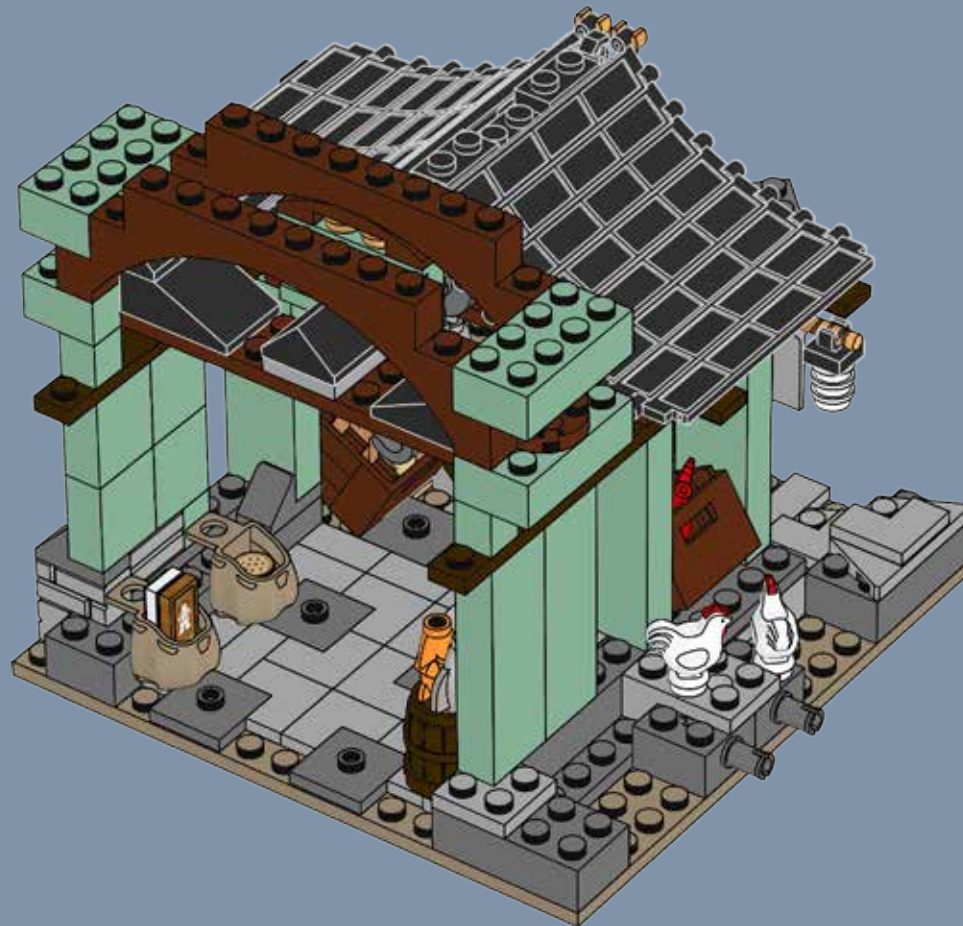



4x

# 30

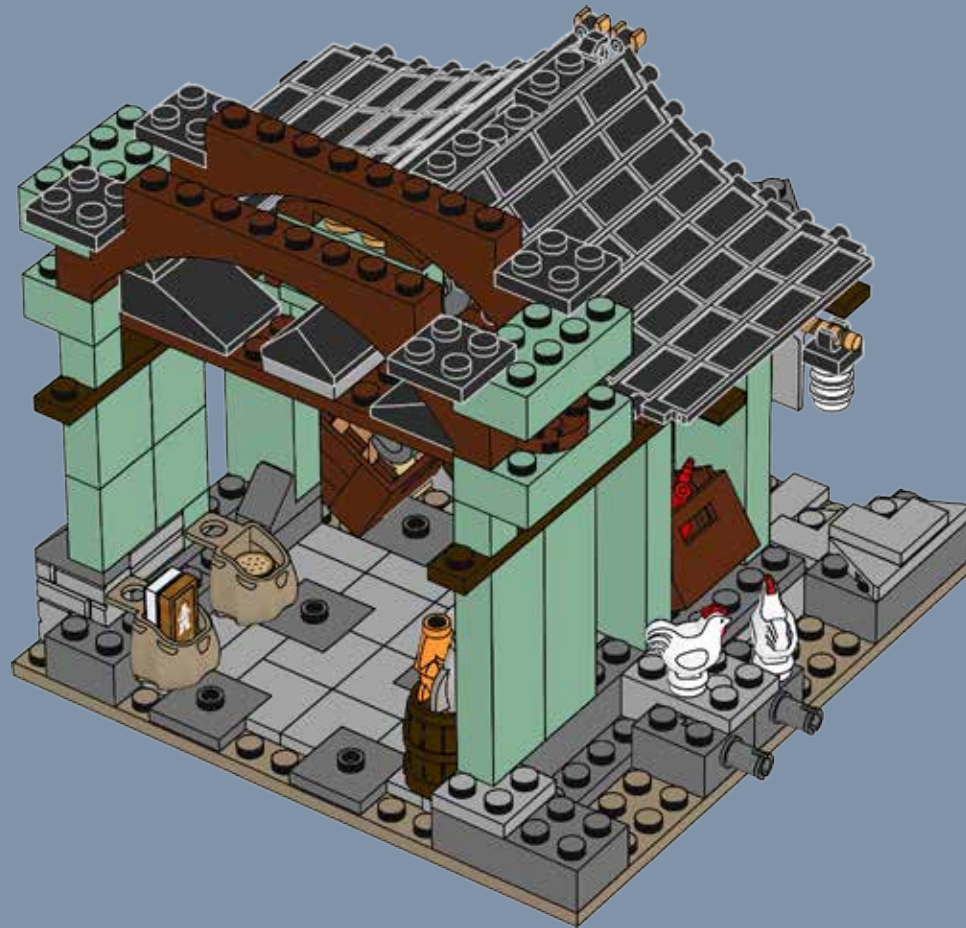



4x

# 31

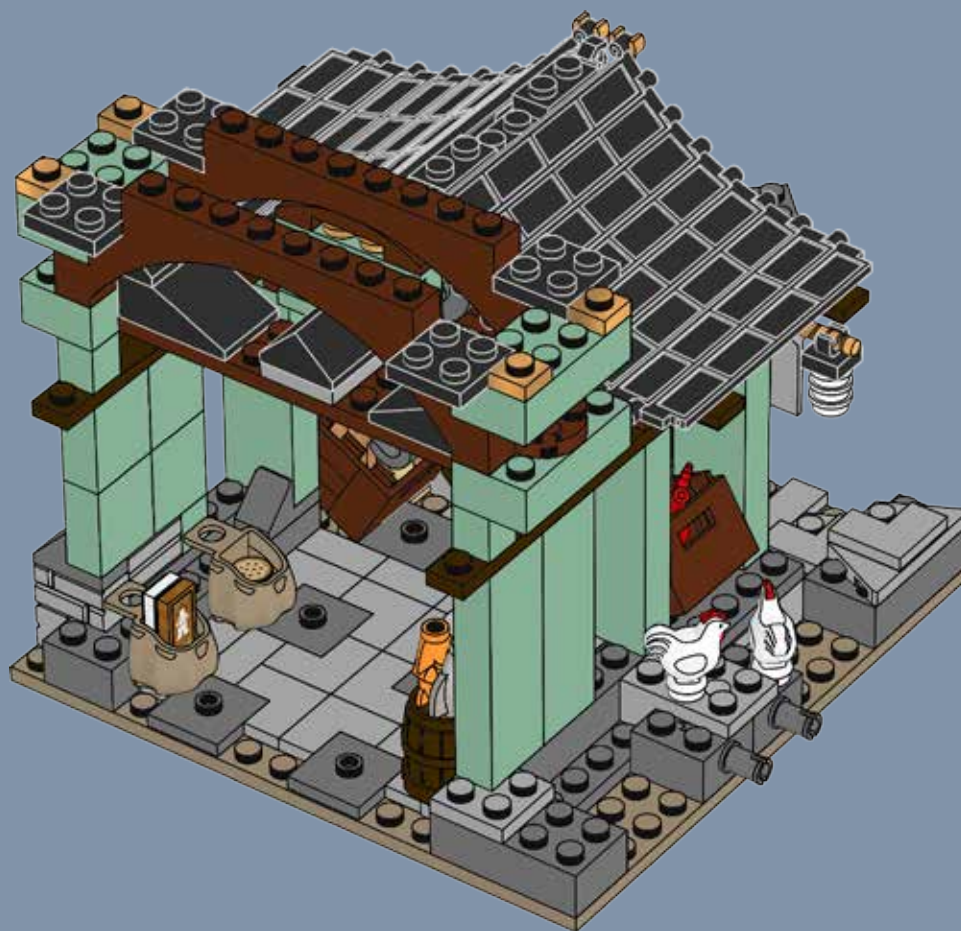



32

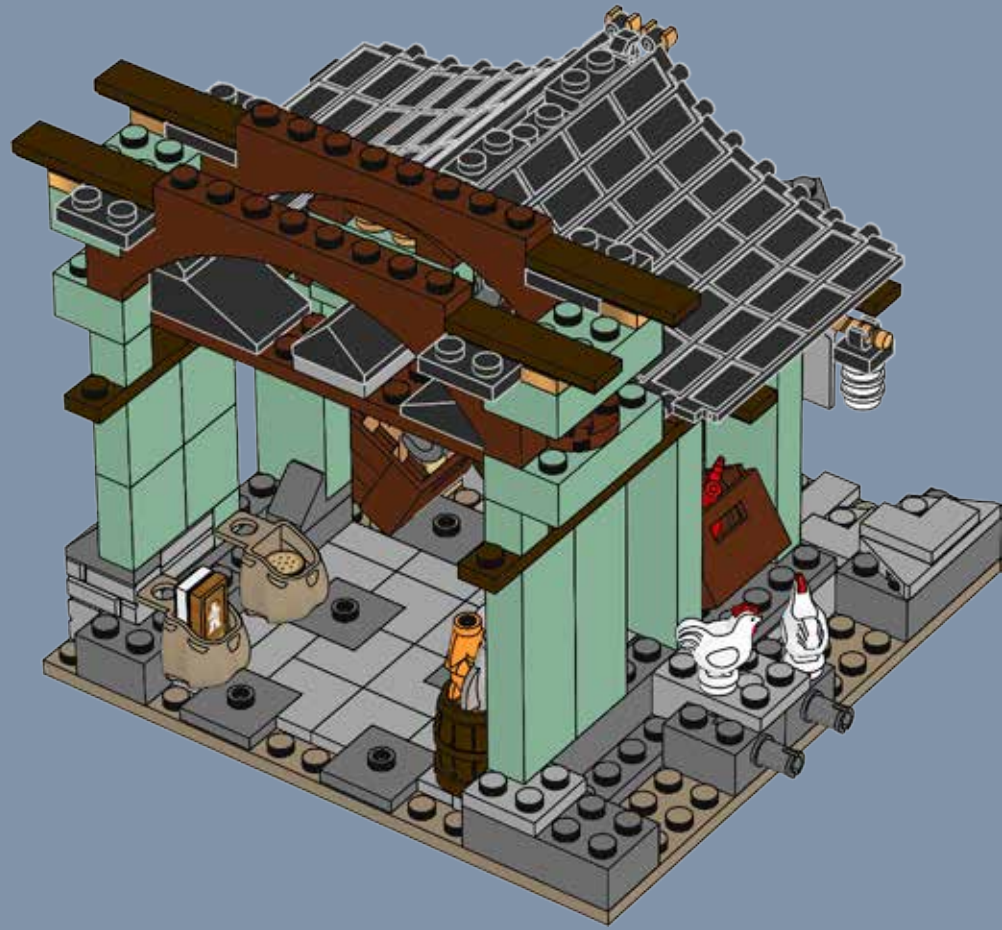





# 33

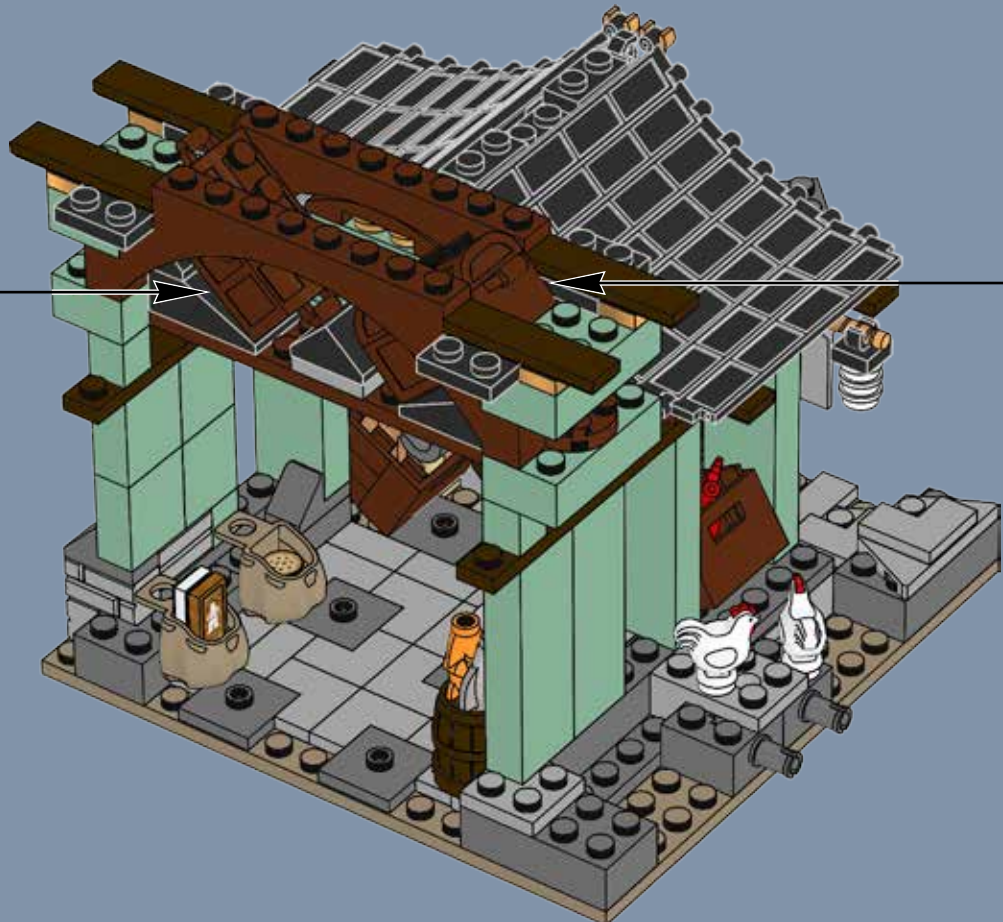
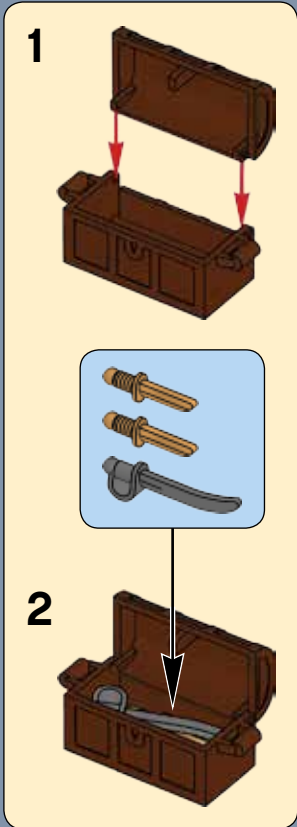



1

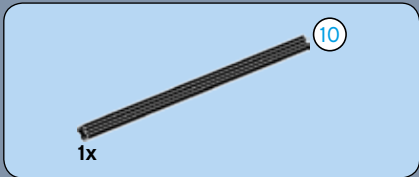
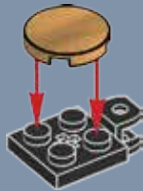

2

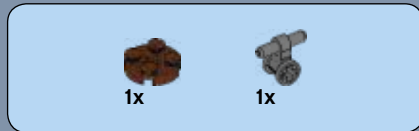
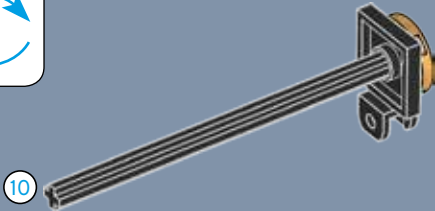

3

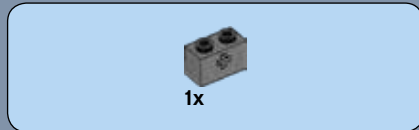
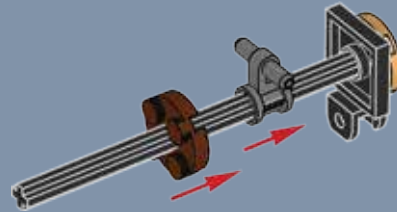

4

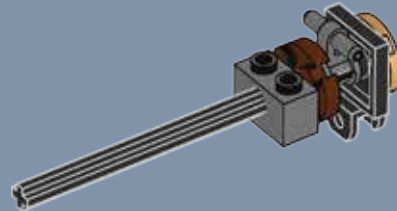

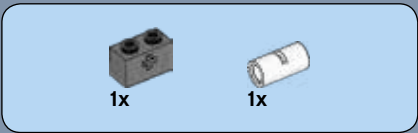

5

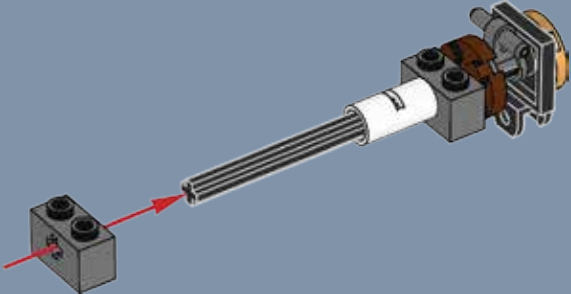

6

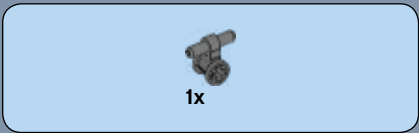
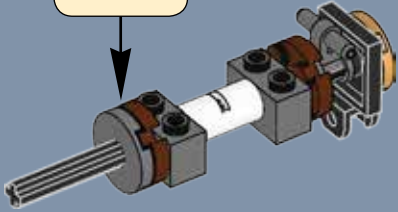

7

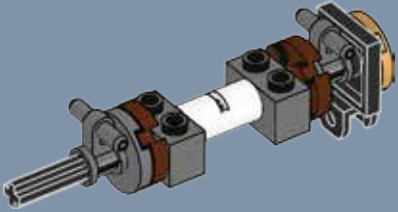

8

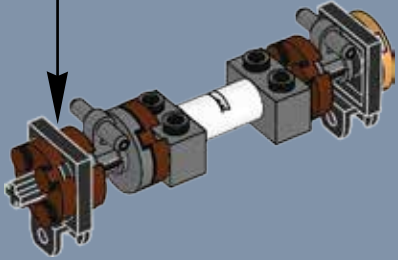
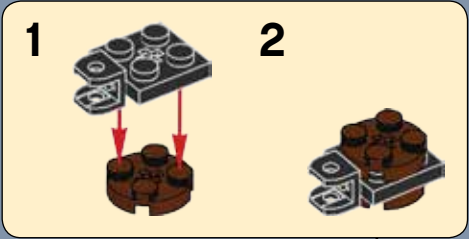

34

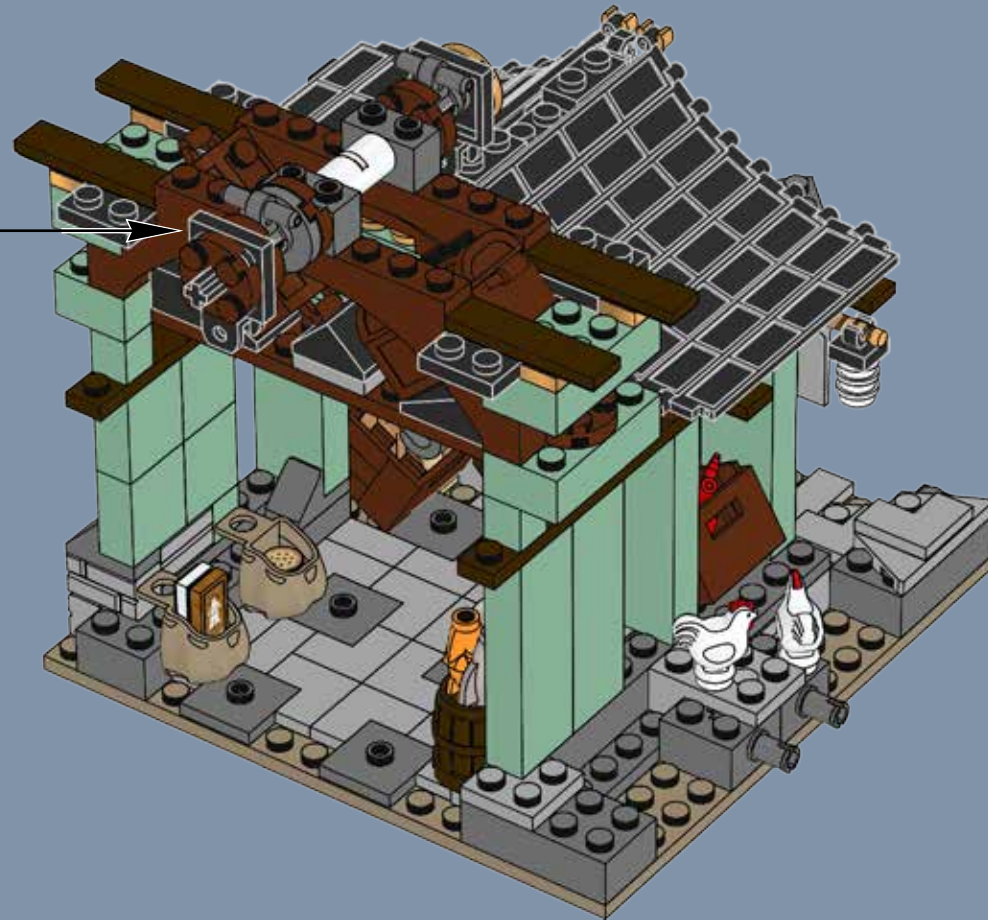



2x

# 35

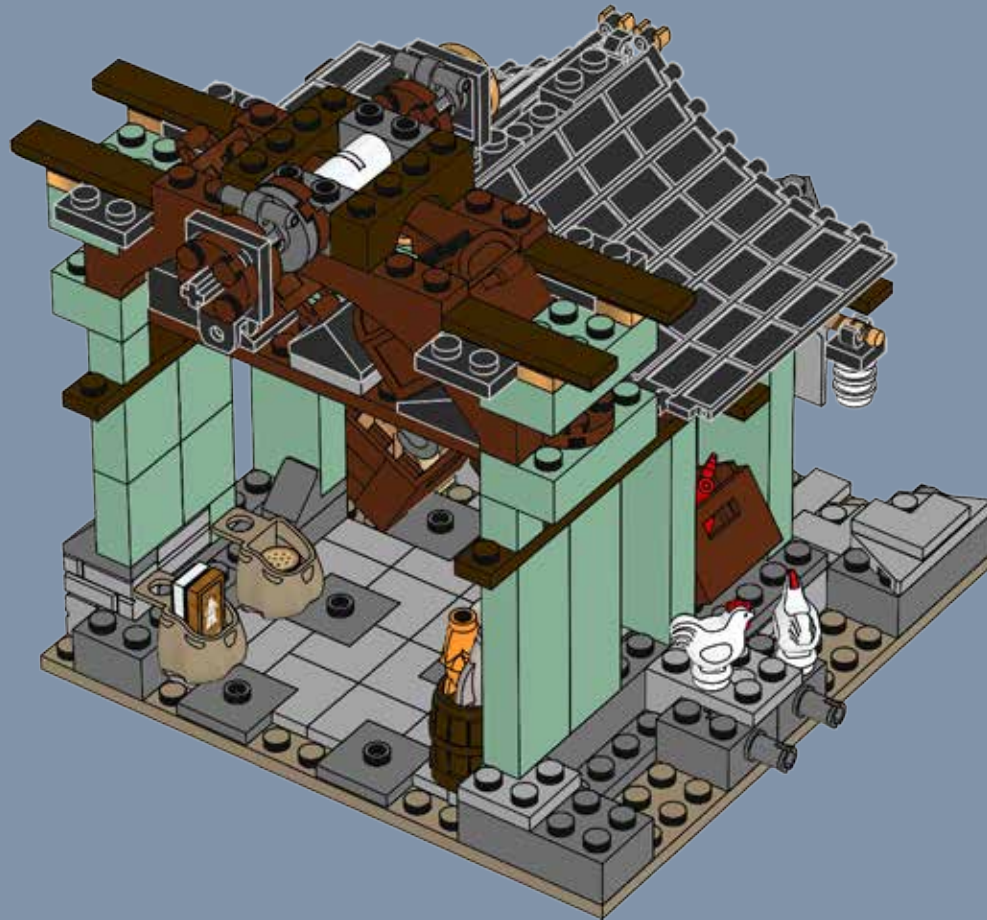



36

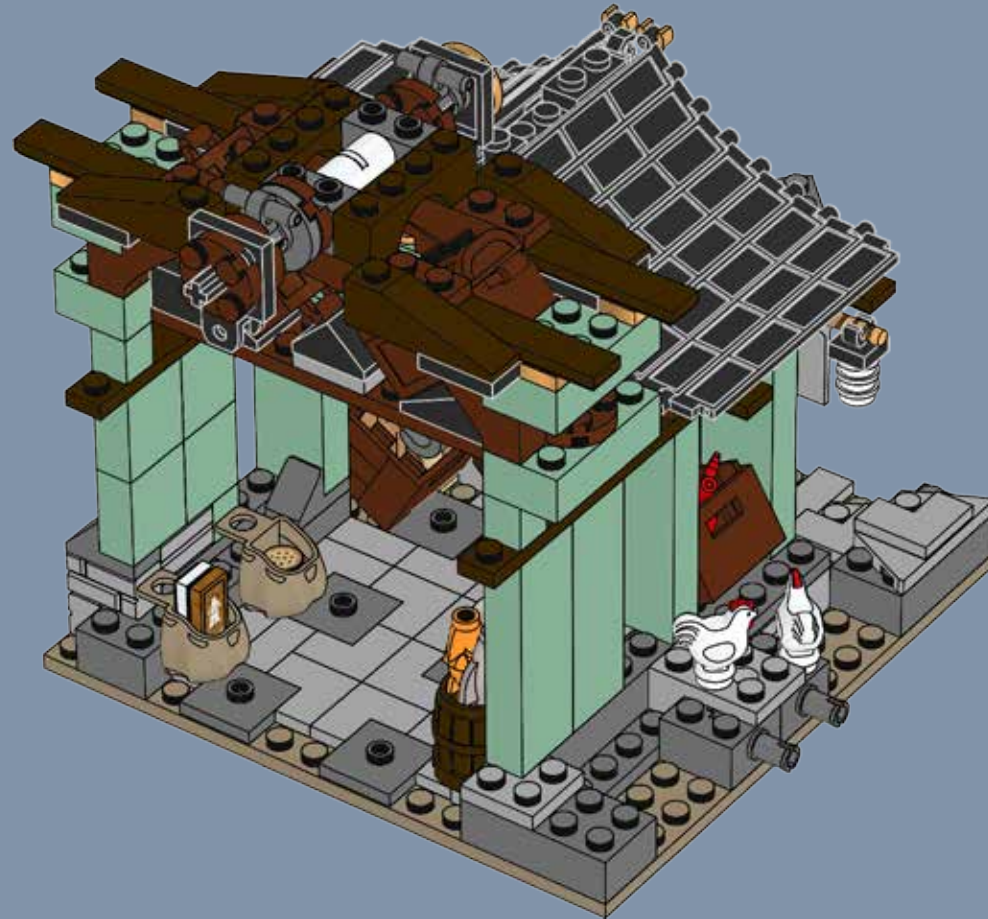



4x

# 37

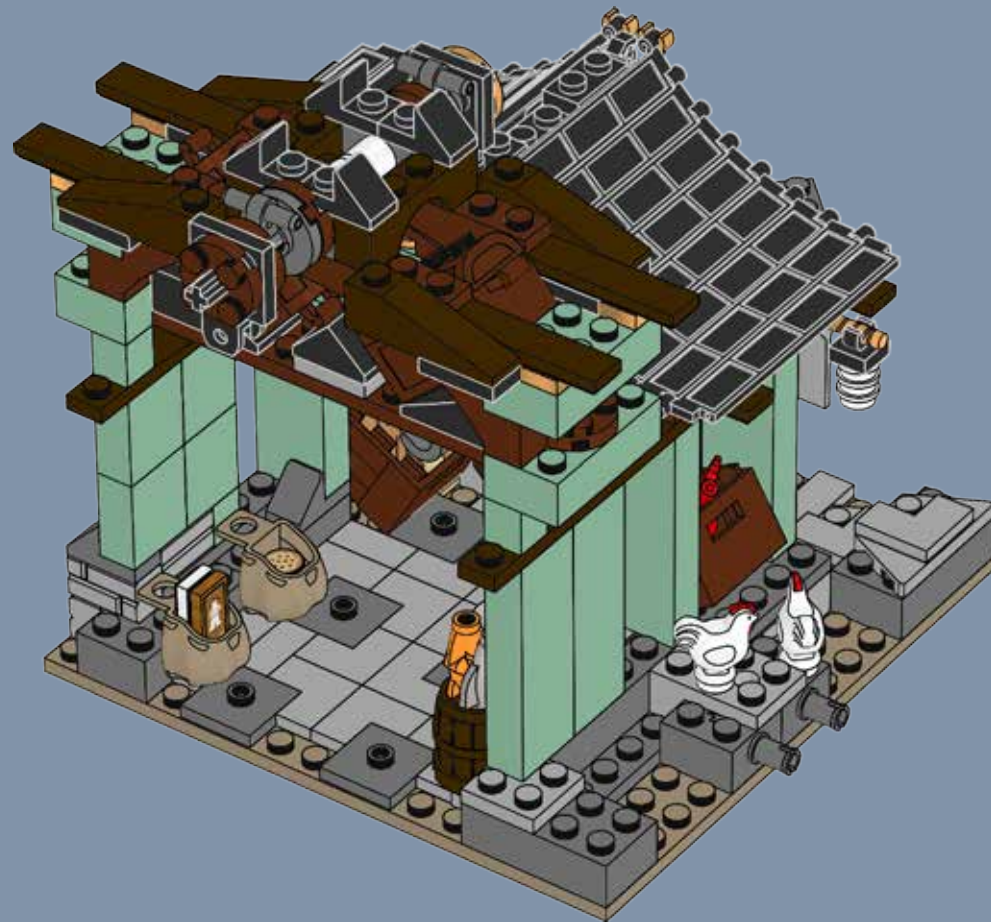



1x



2x

# 38

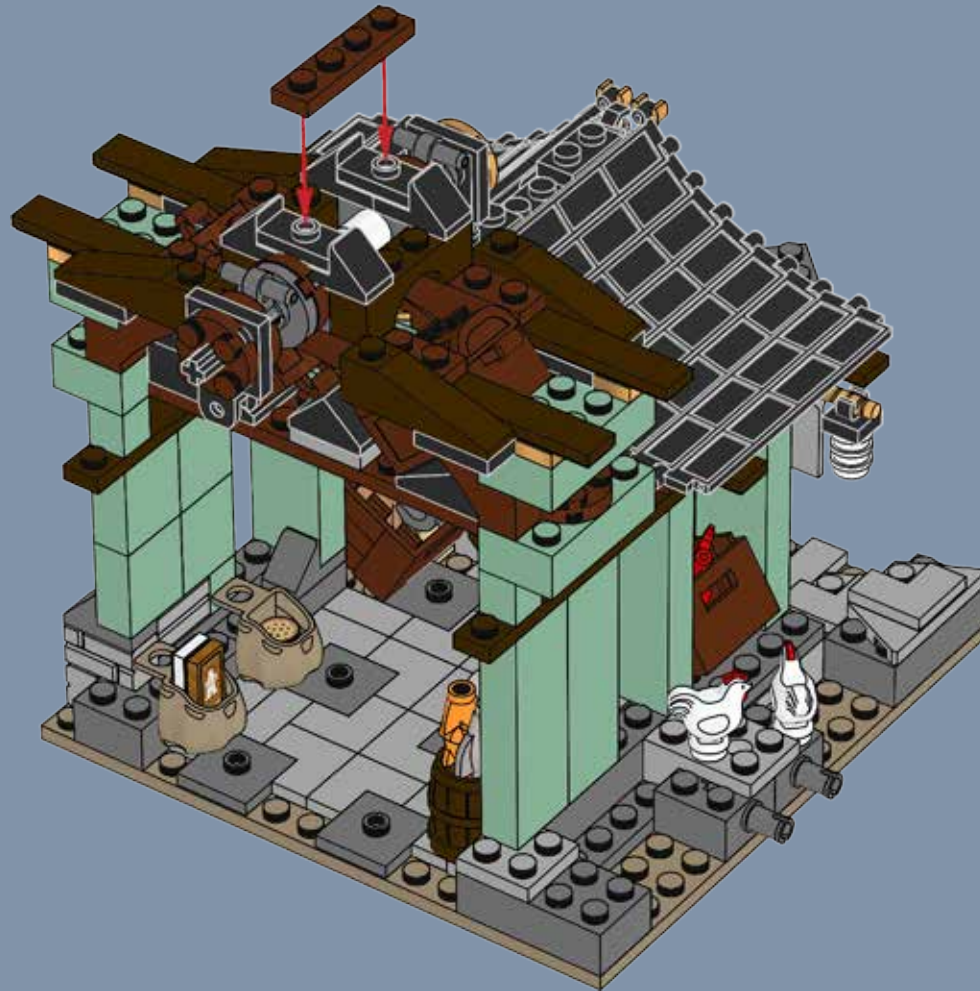





4x

# 39

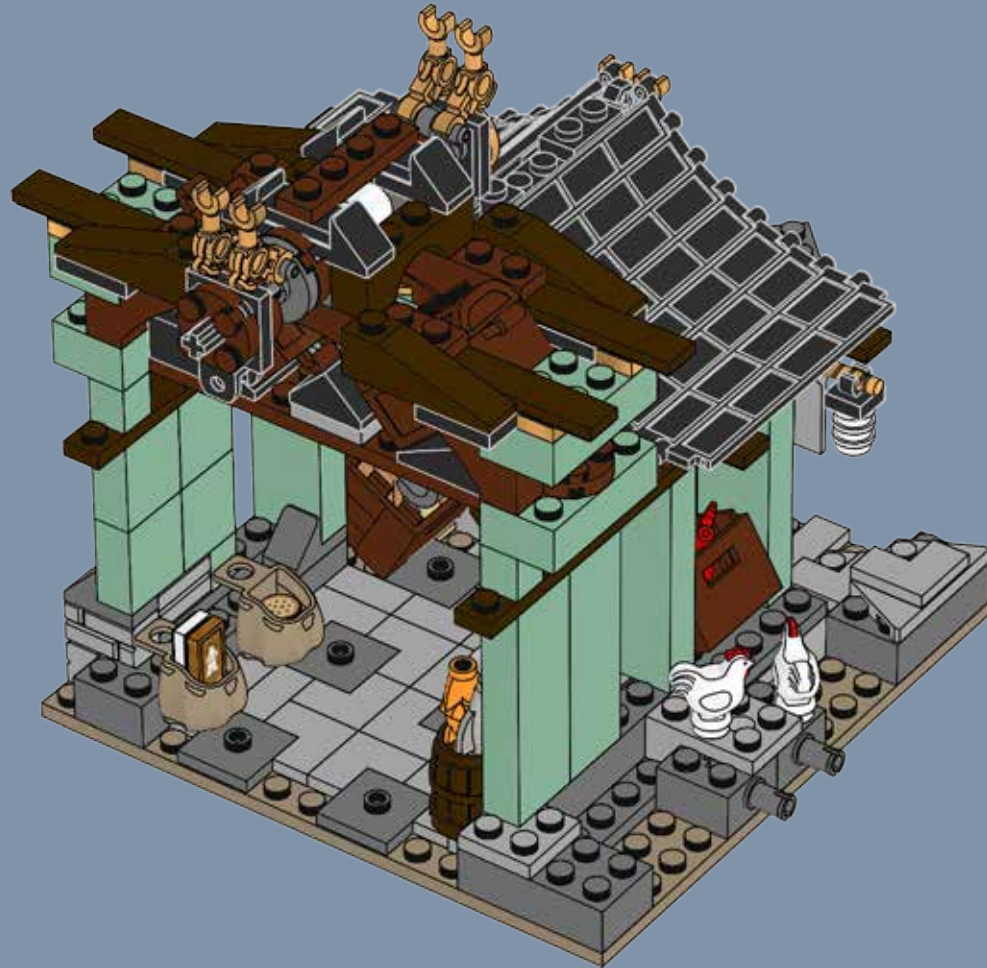



40

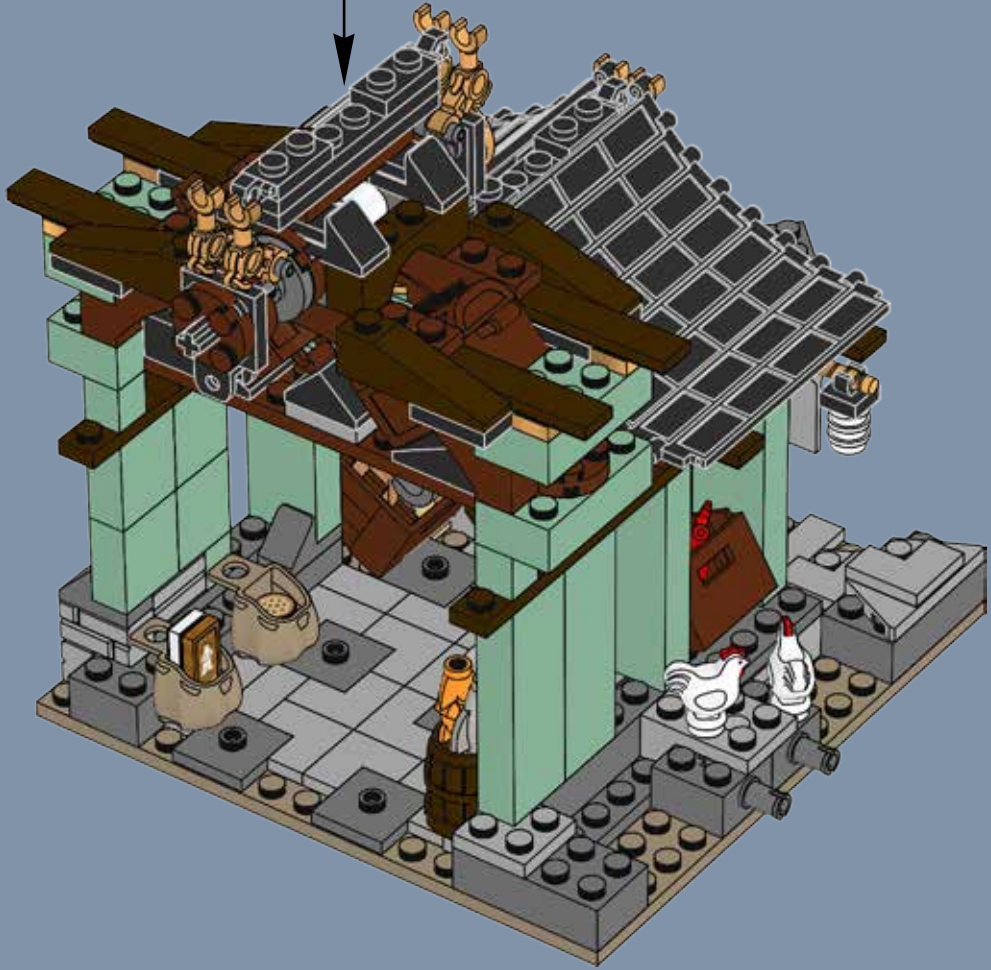
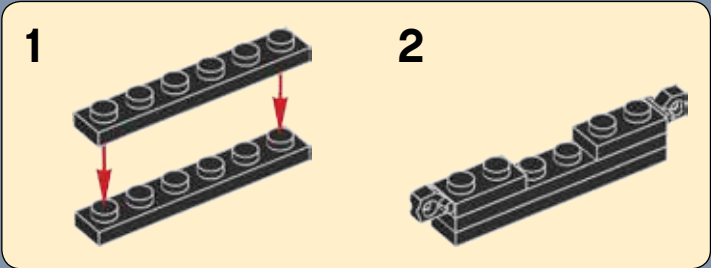

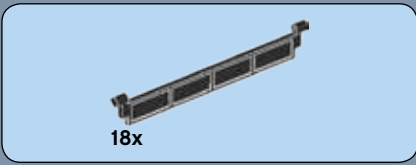

41

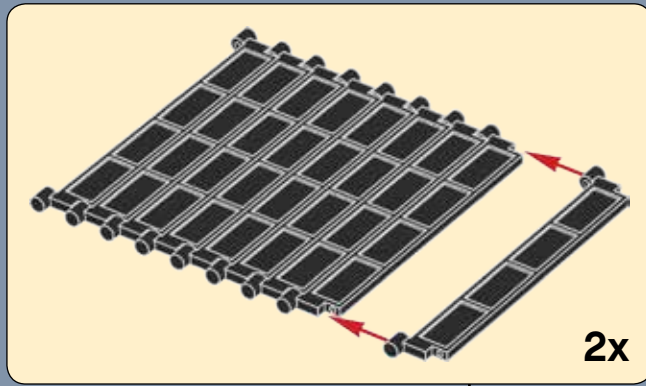

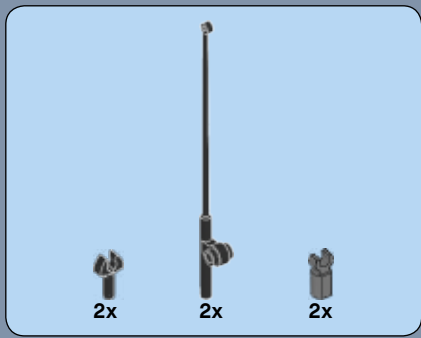

42

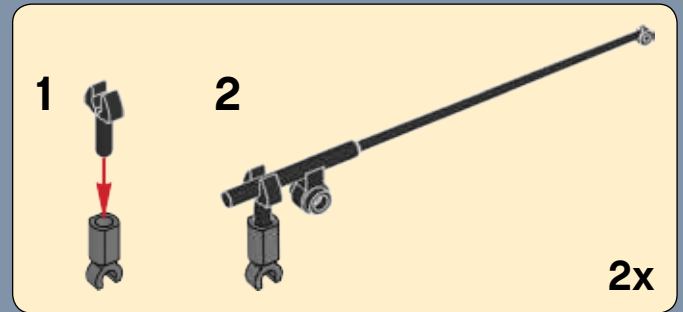
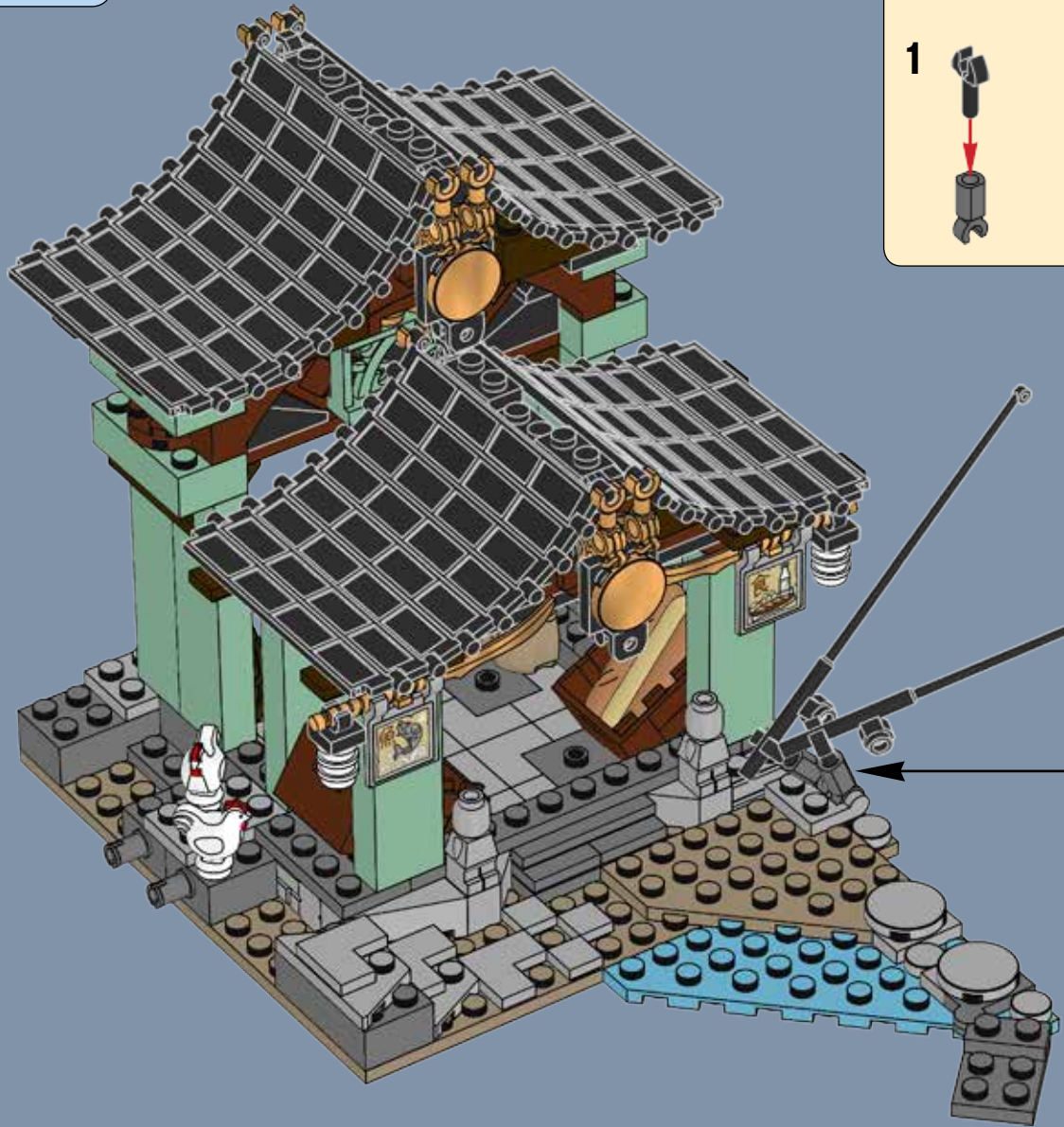



# 43

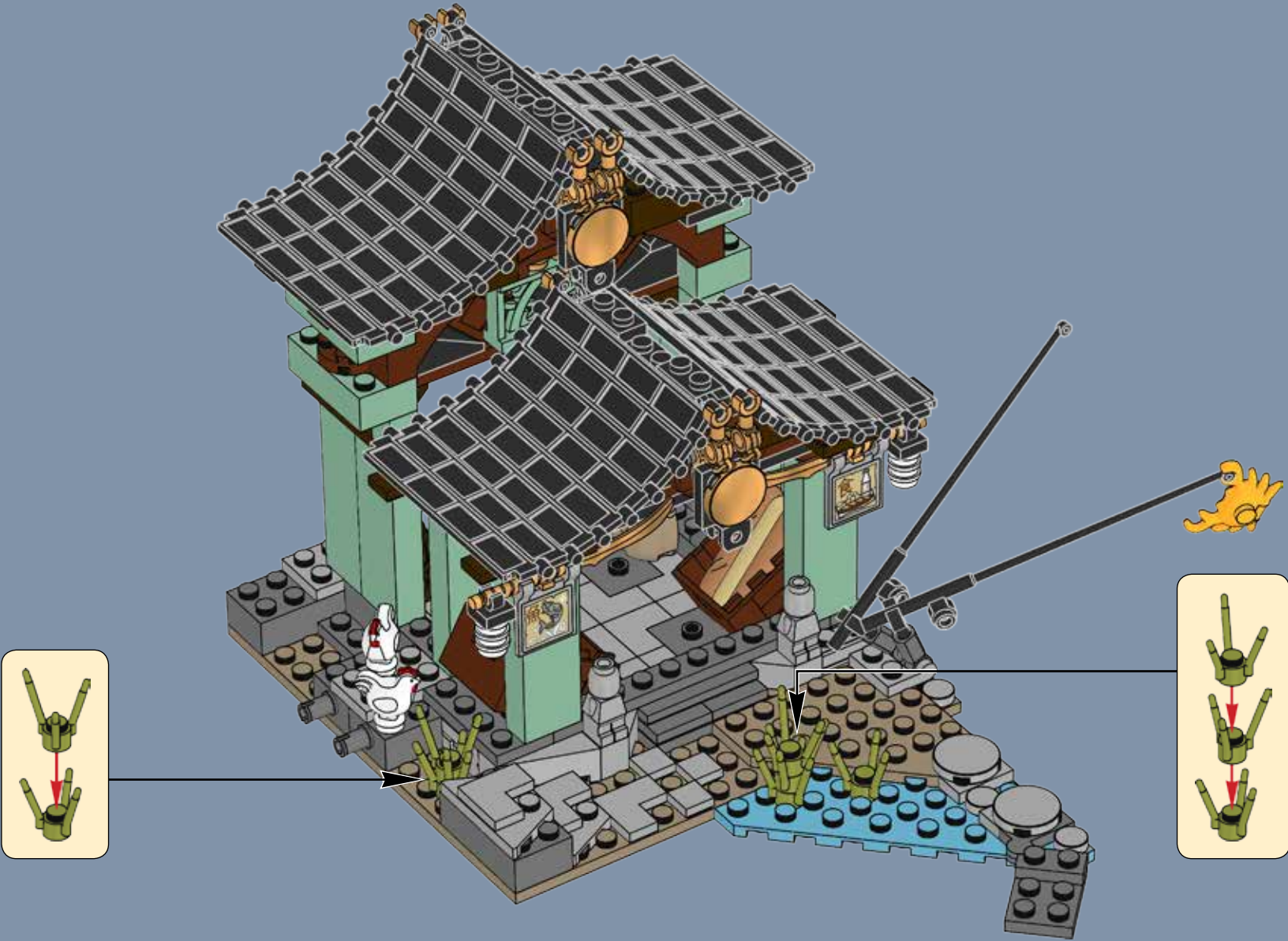

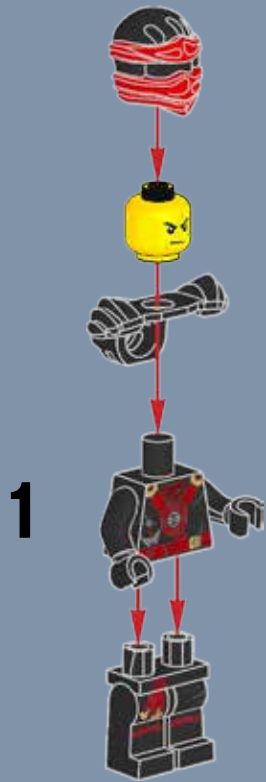
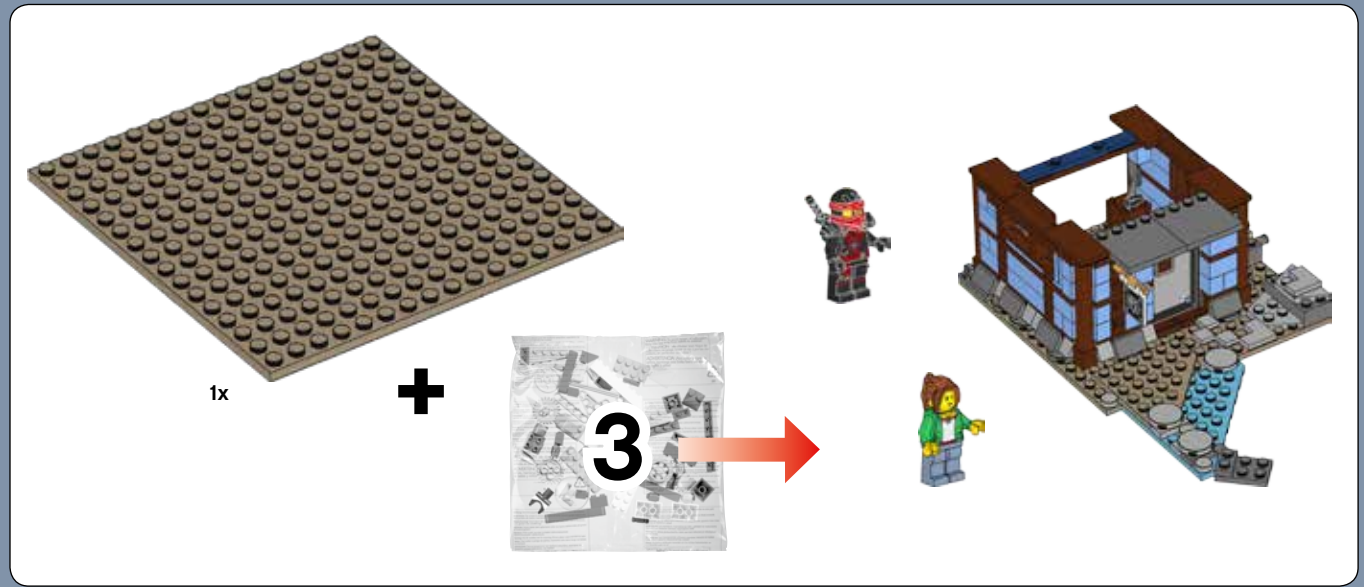

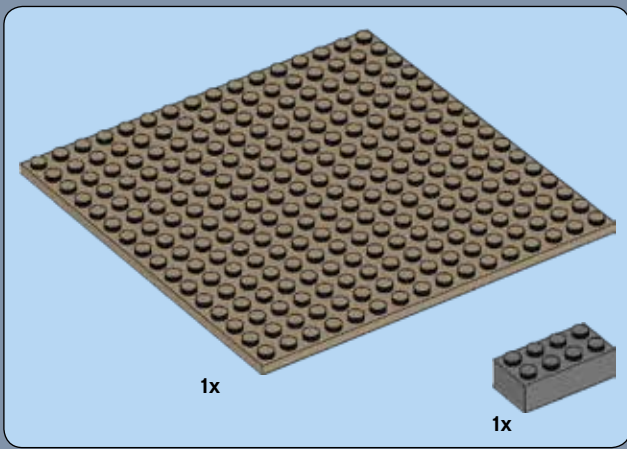

**1**

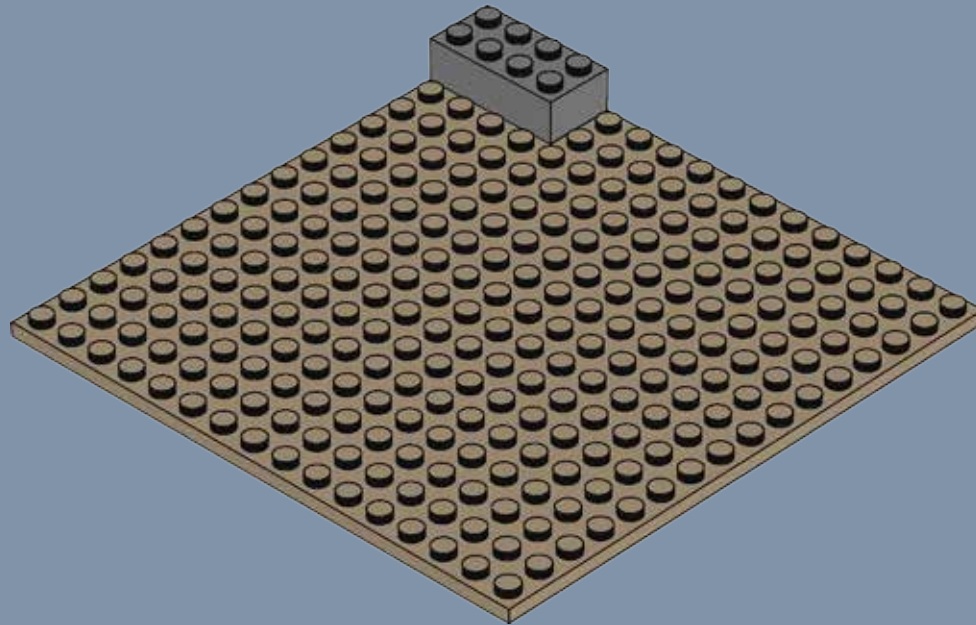

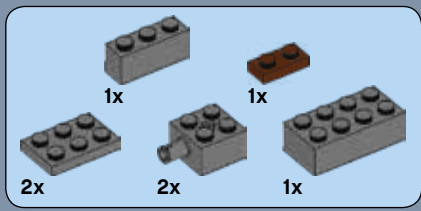

2





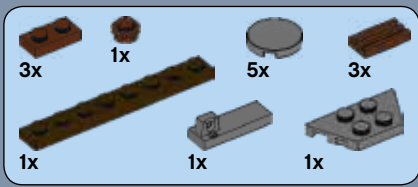

3

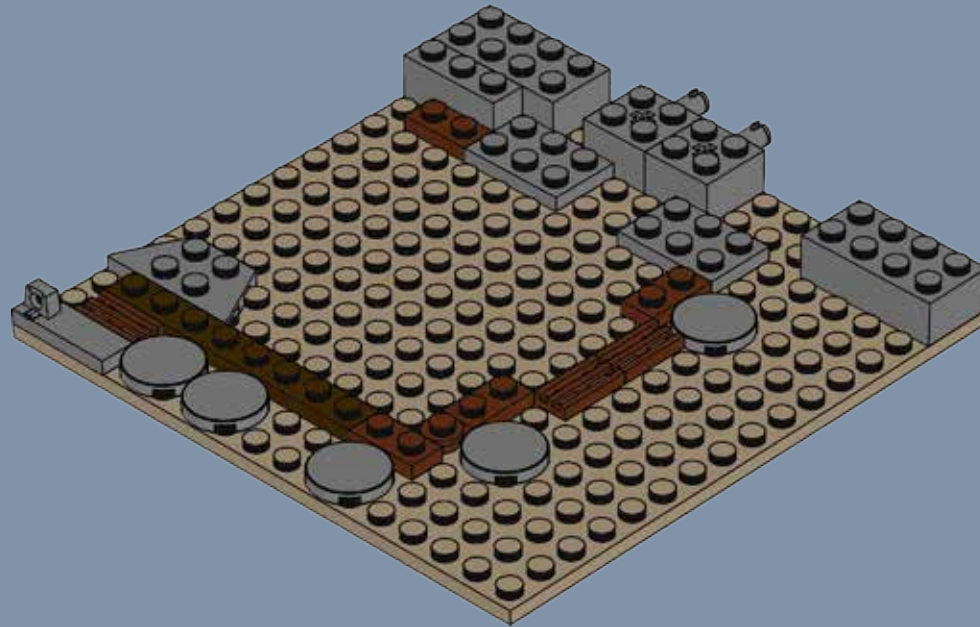



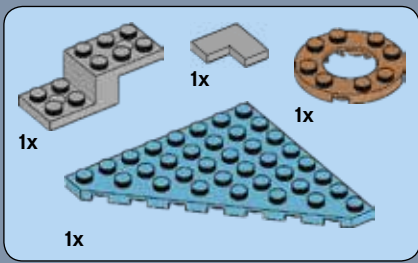

5

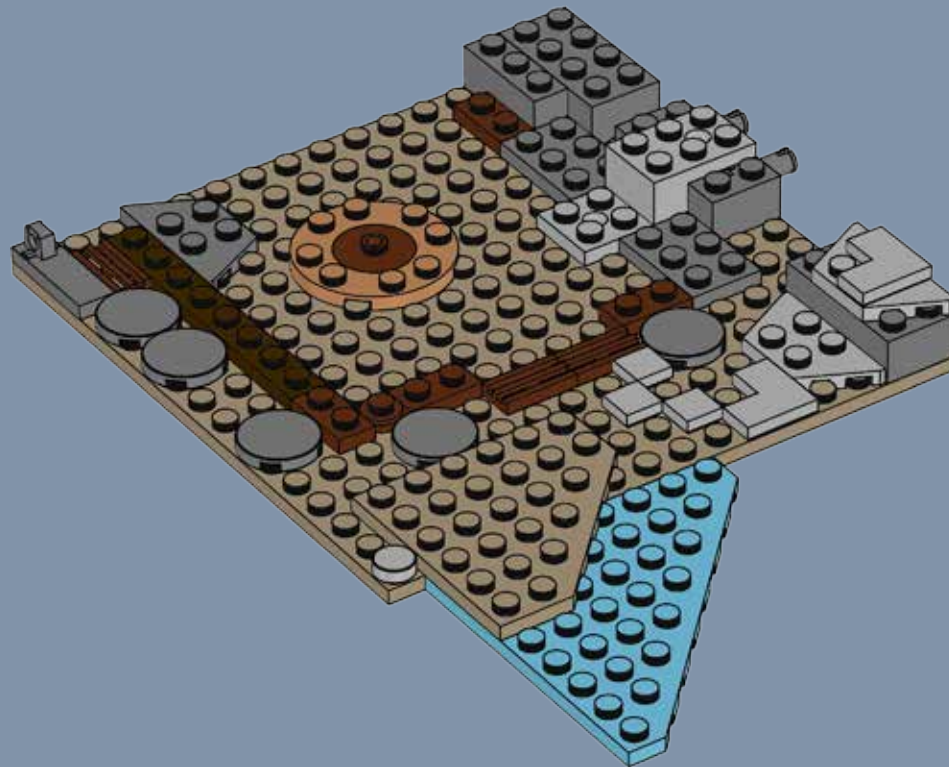

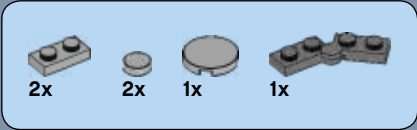

# 6

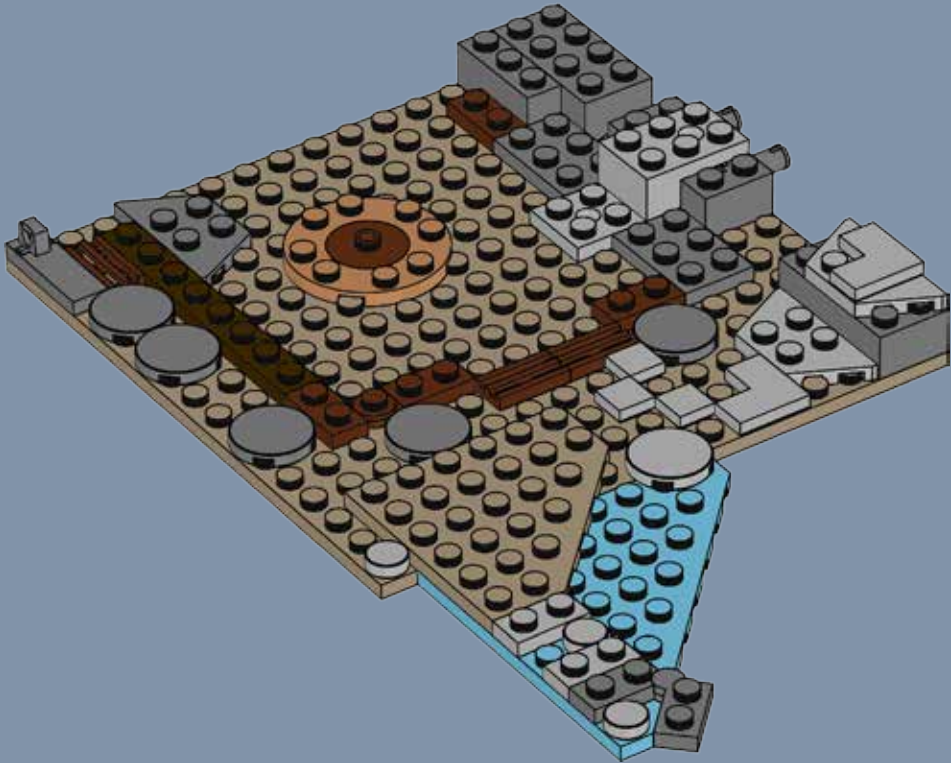



1x



2x

7

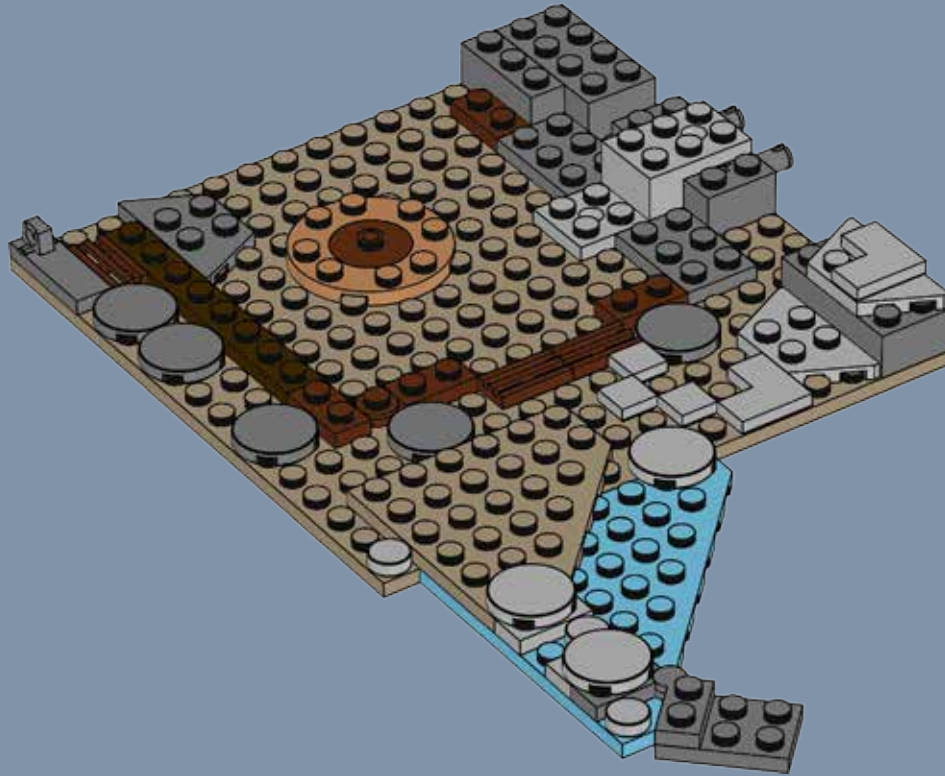

5x 1x

8

2x

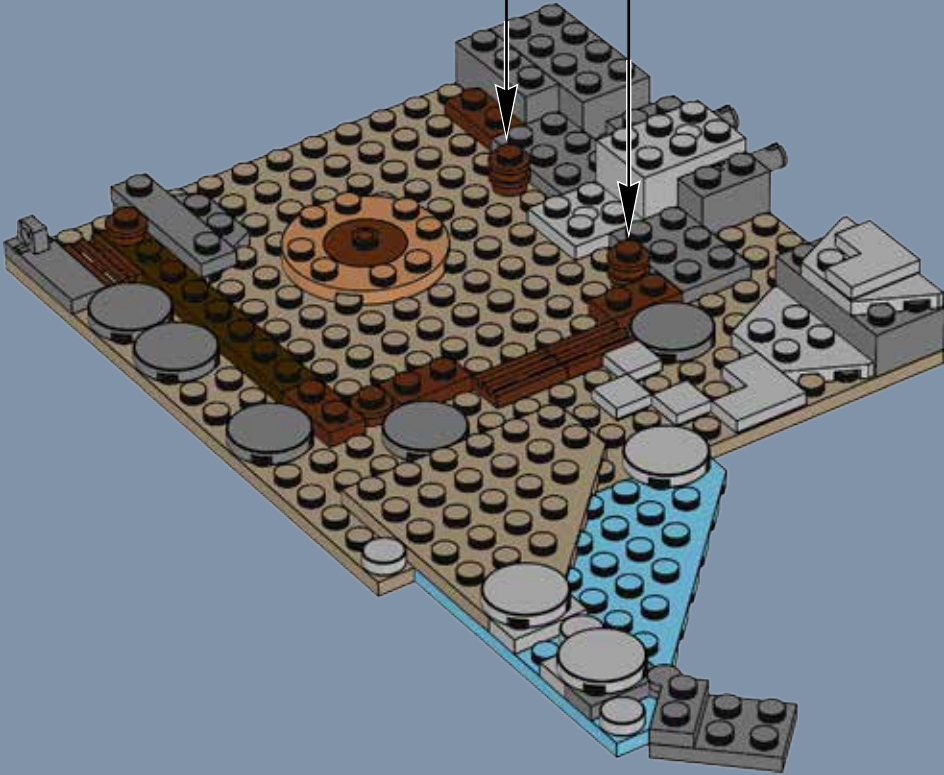



7x

9

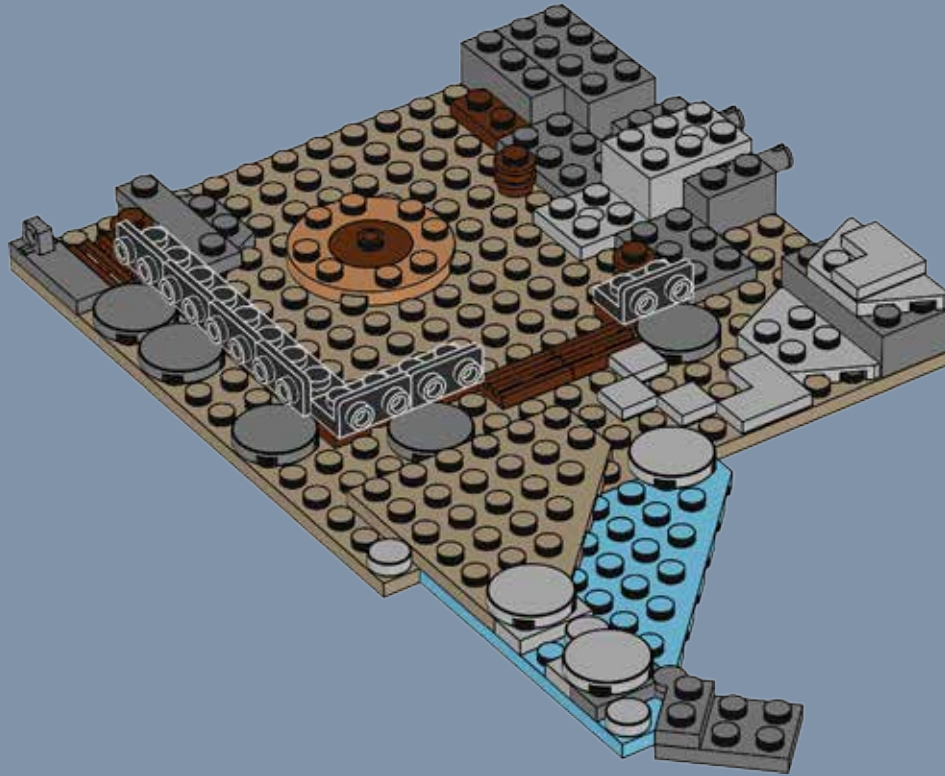

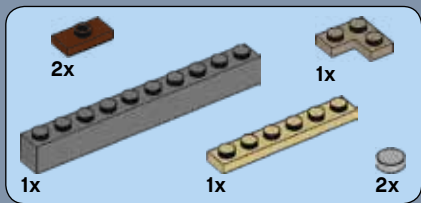

10

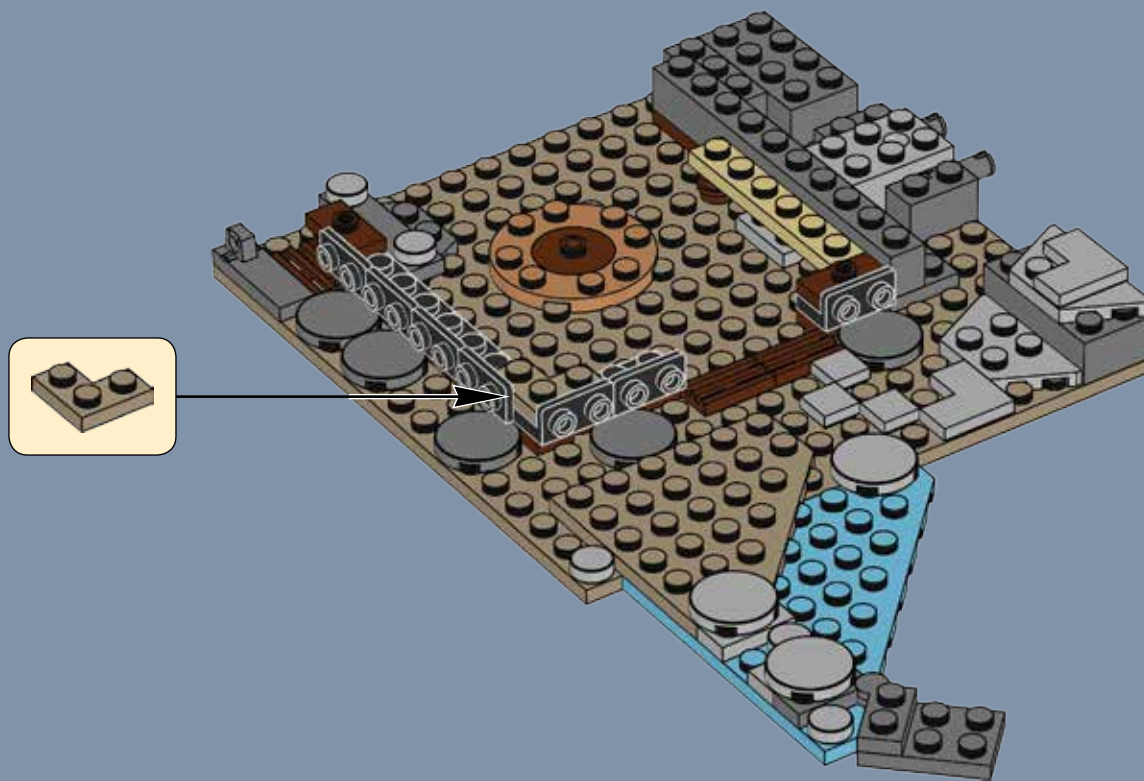



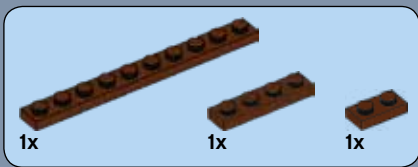

11

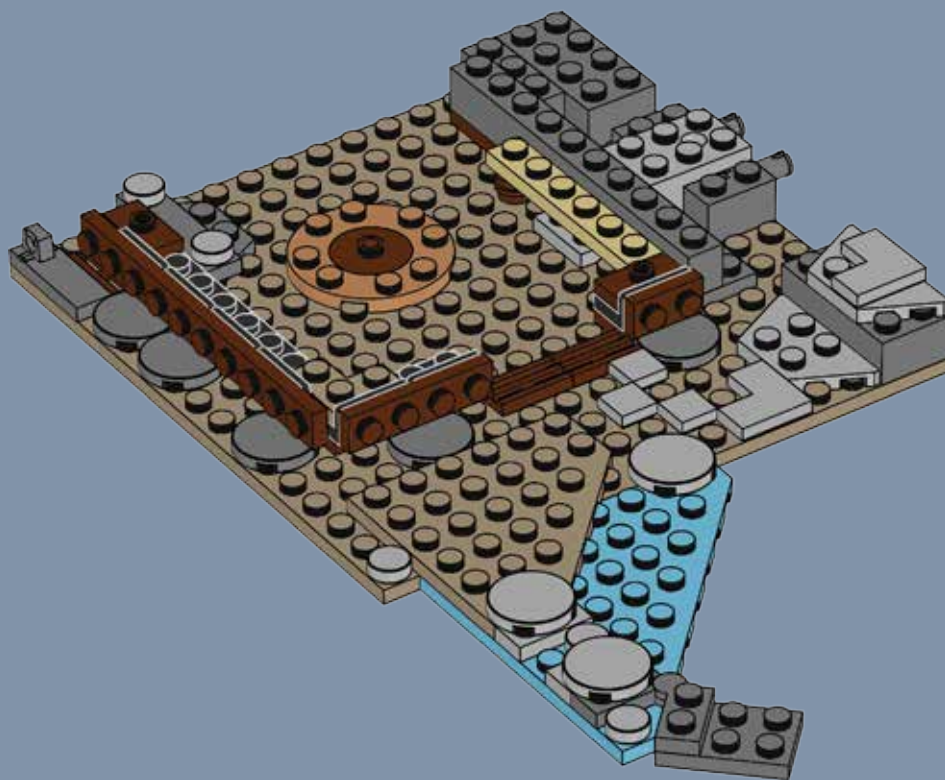



6x



2x

# 12

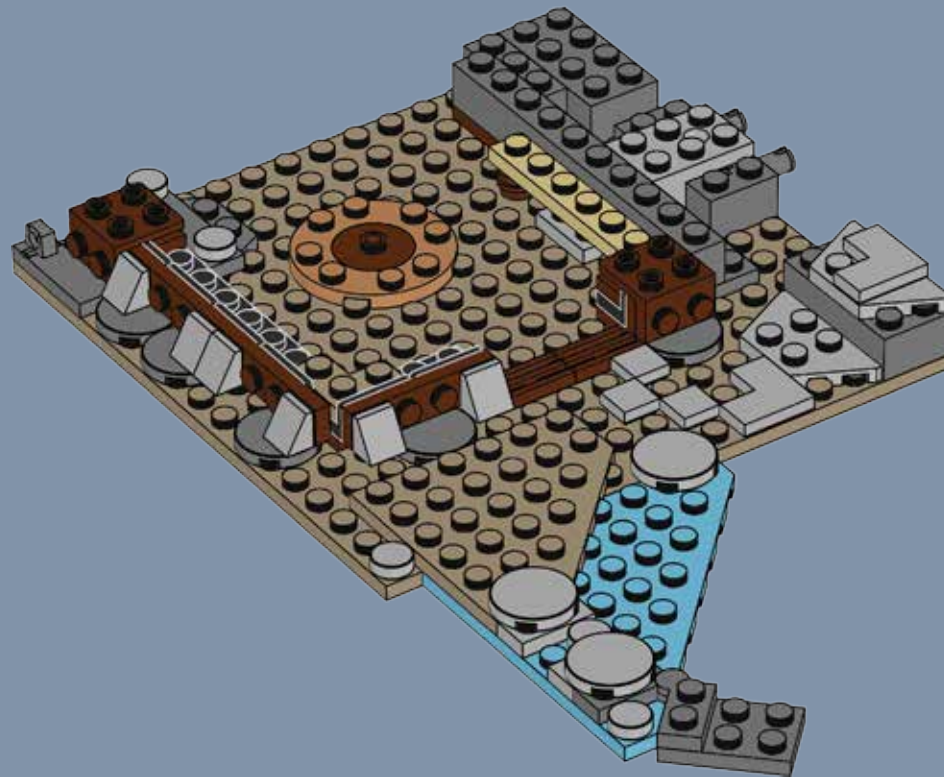

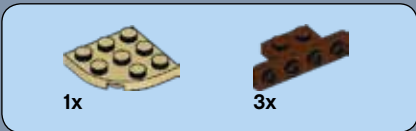

13

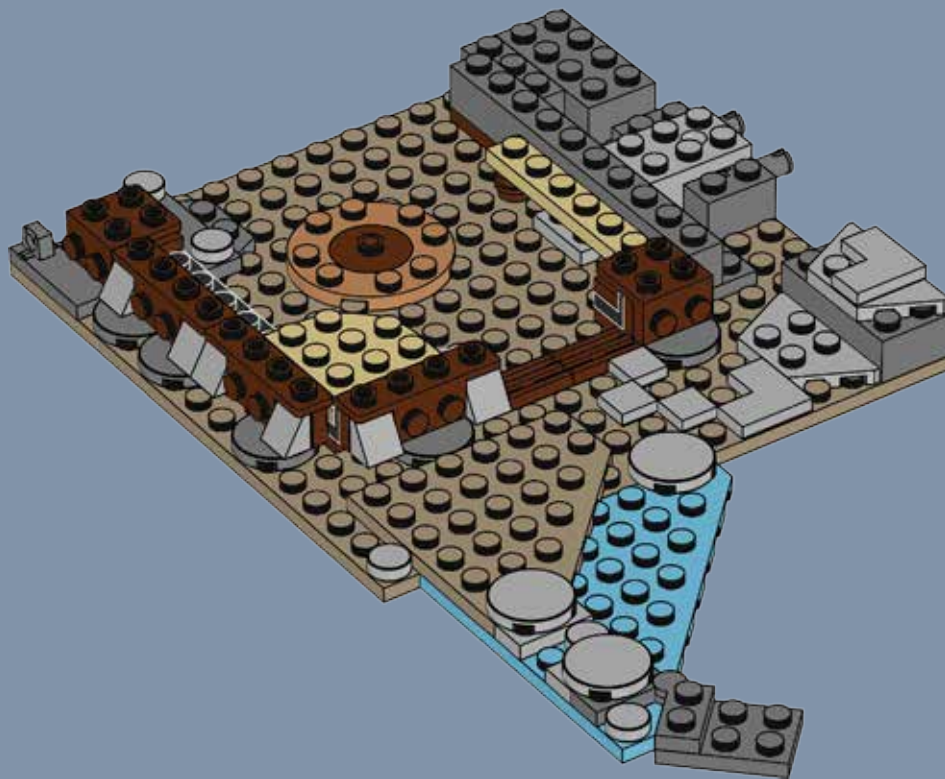

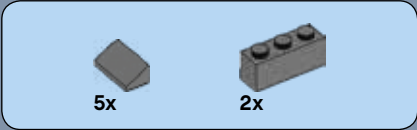

# 14

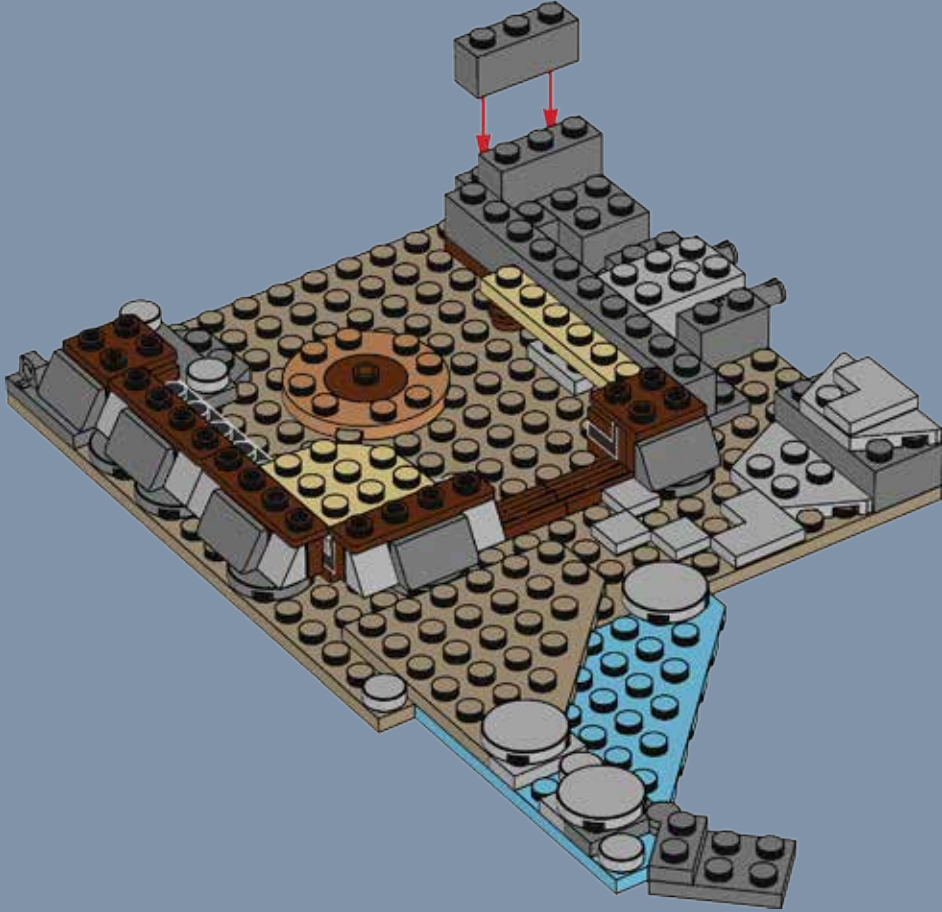



15





# 16

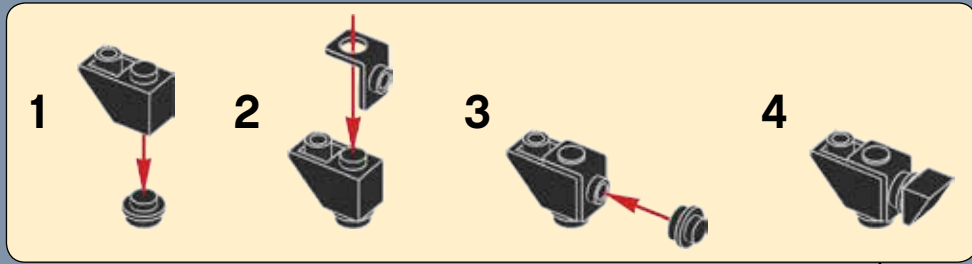



# 17

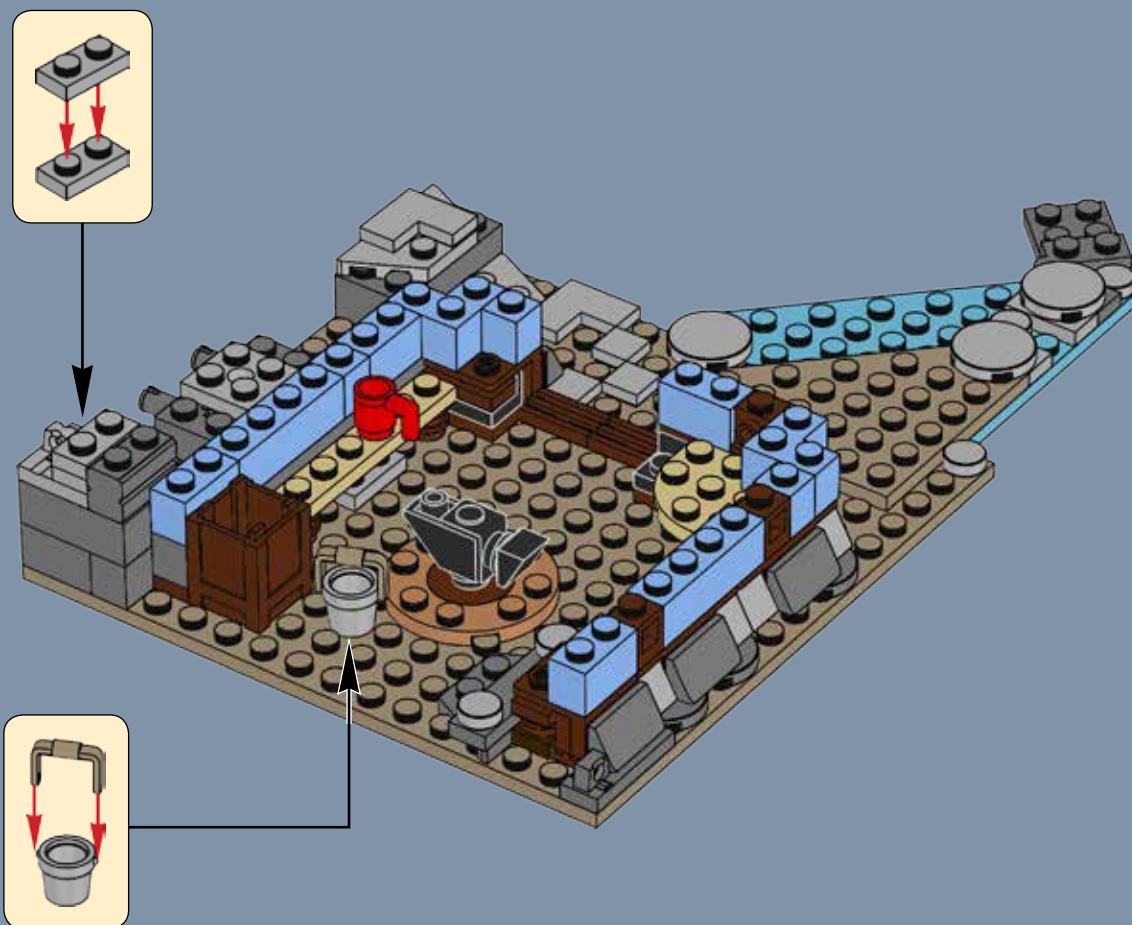

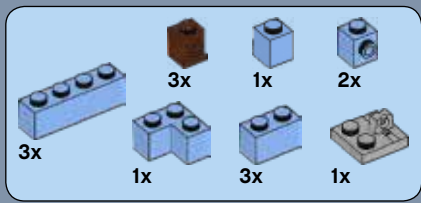

# 18





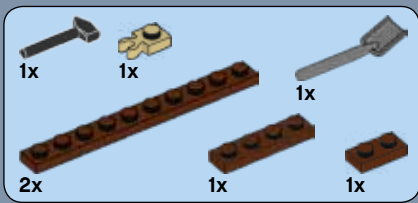

# 19



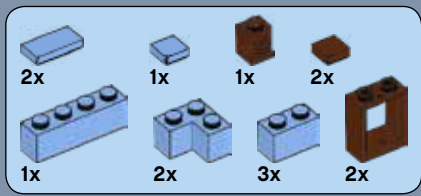

20



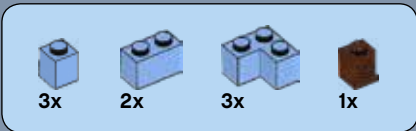

# 21



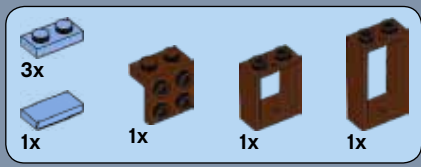

22

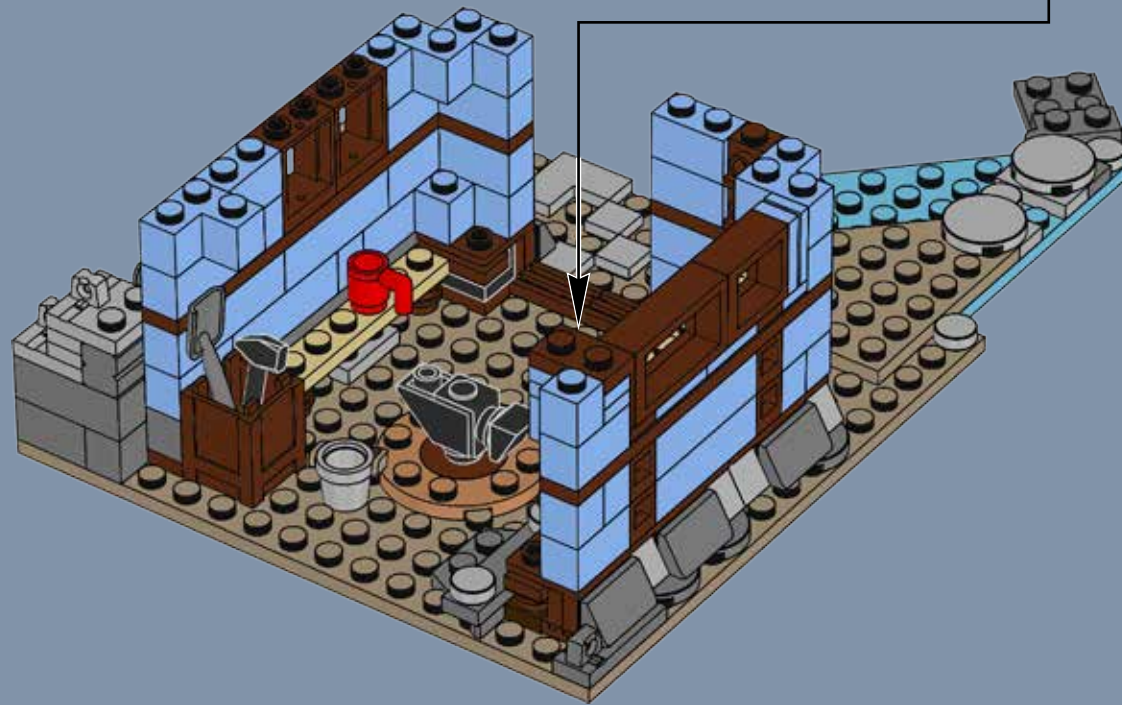
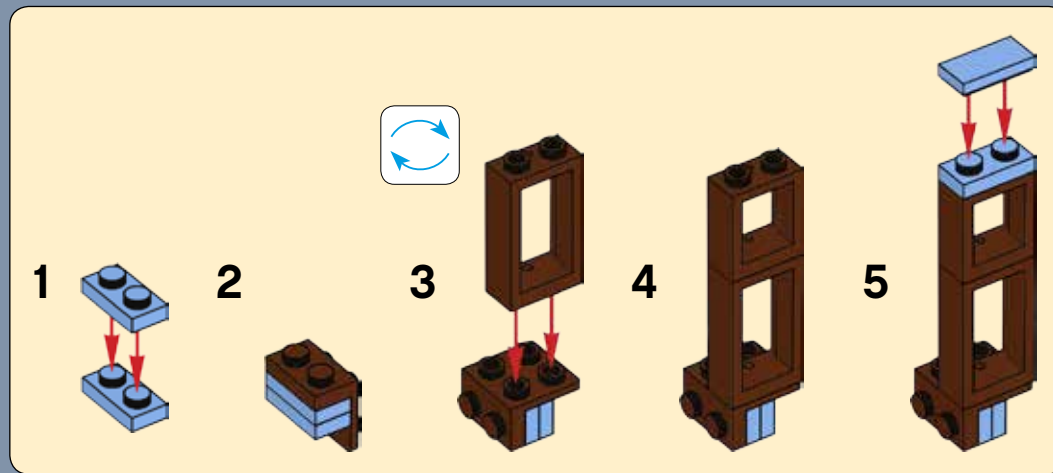



23



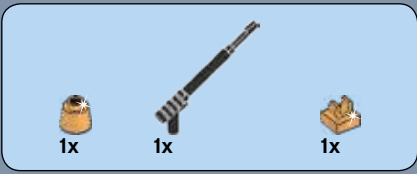

24

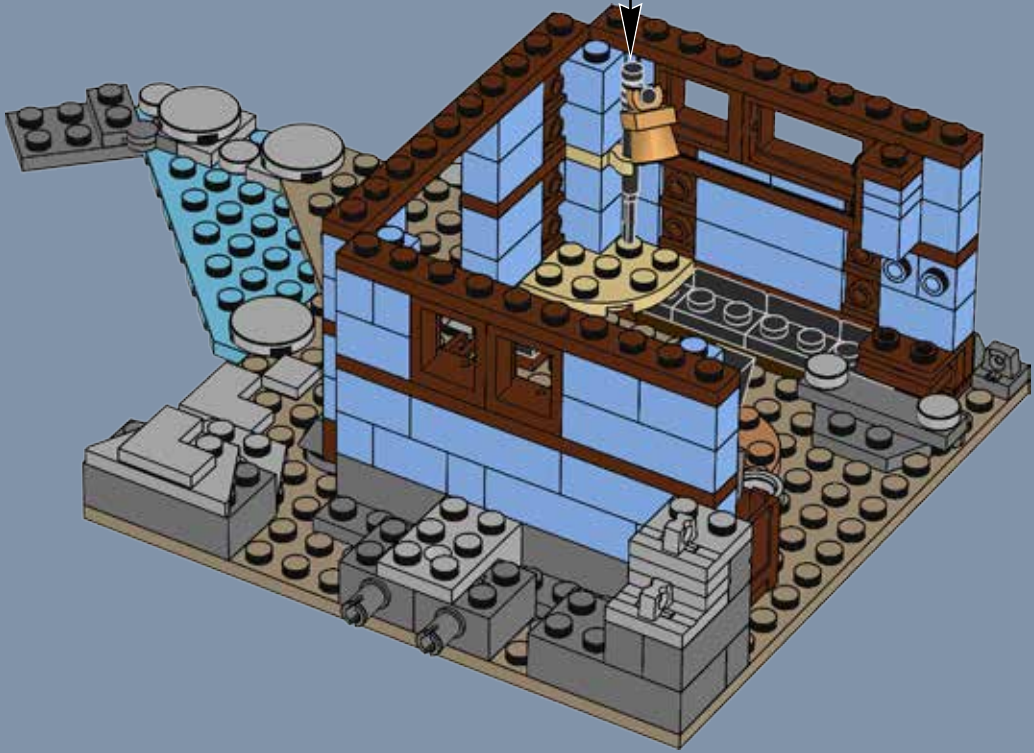
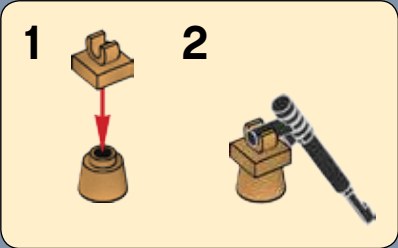

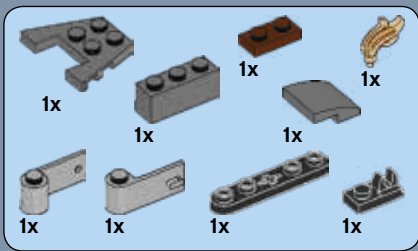

25

1

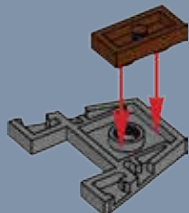

2

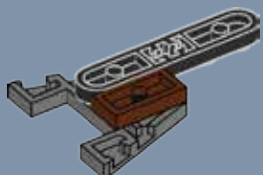

3

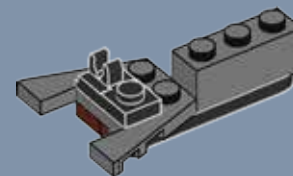

4

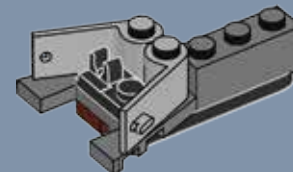

5

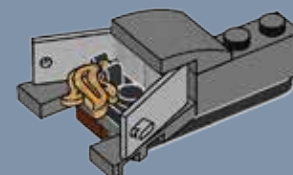





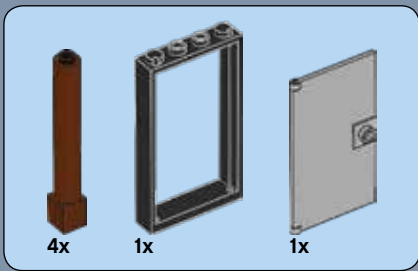

26

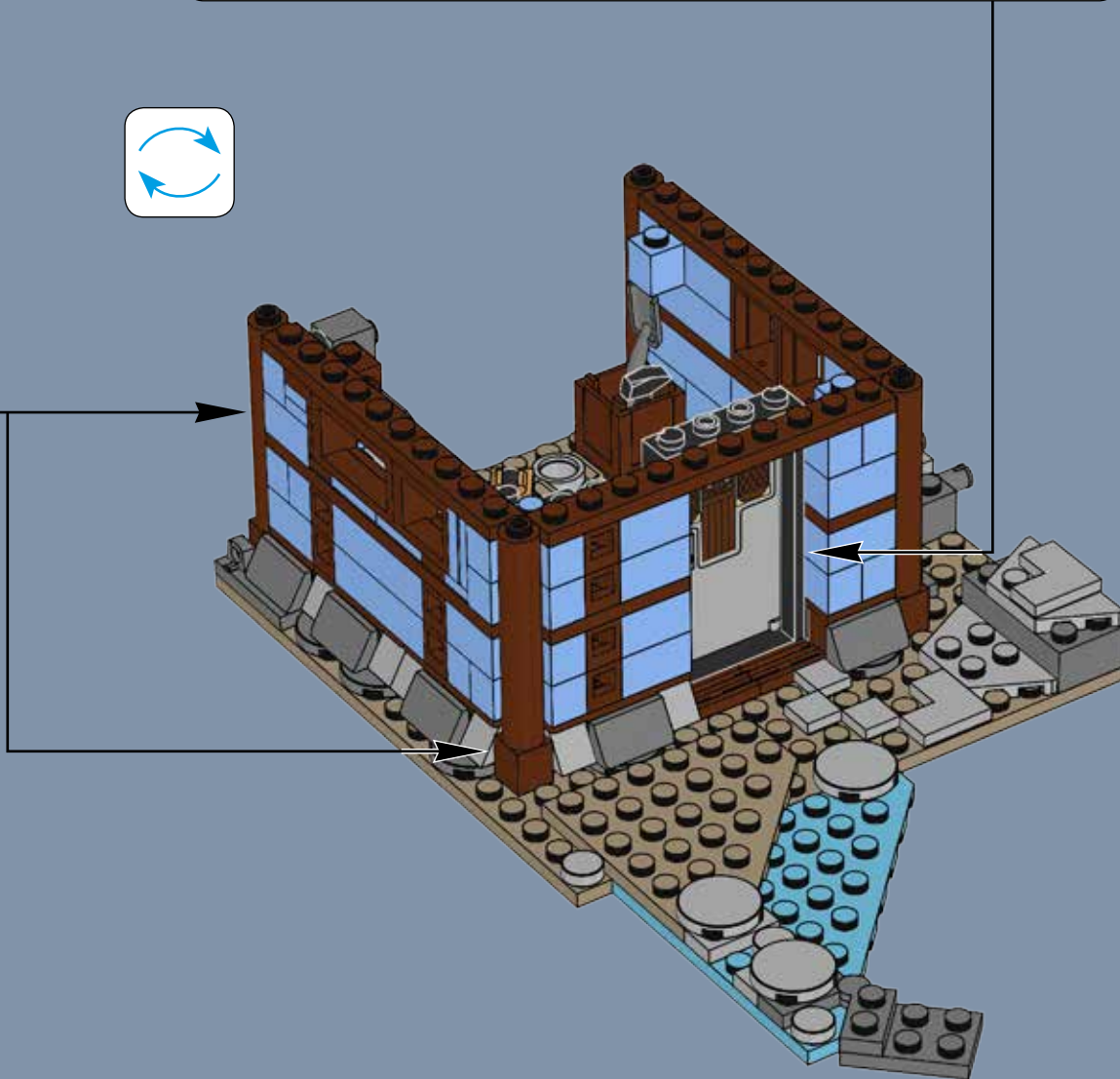
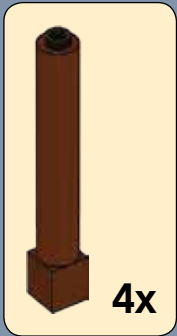
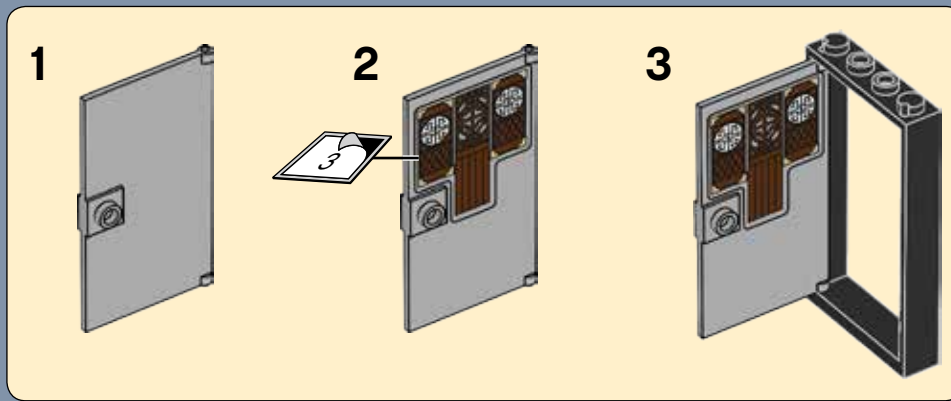

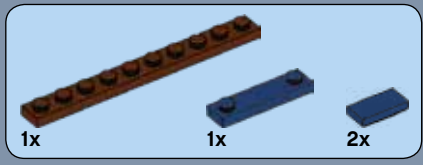

27

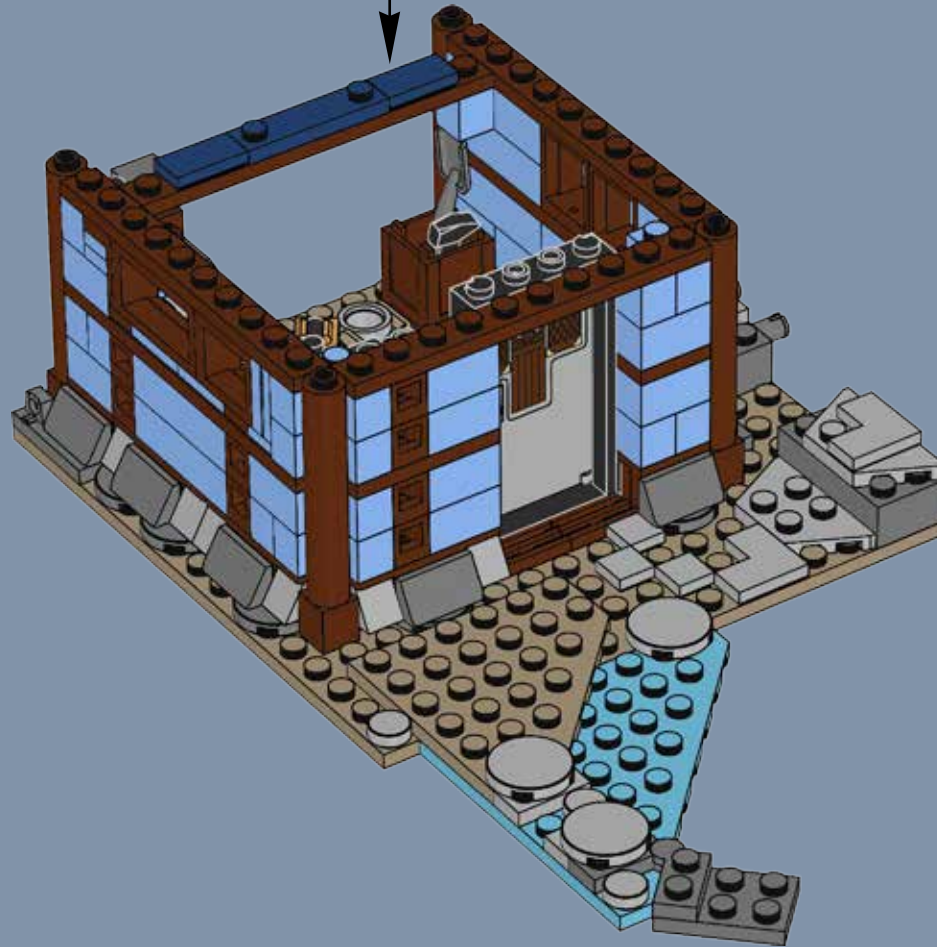
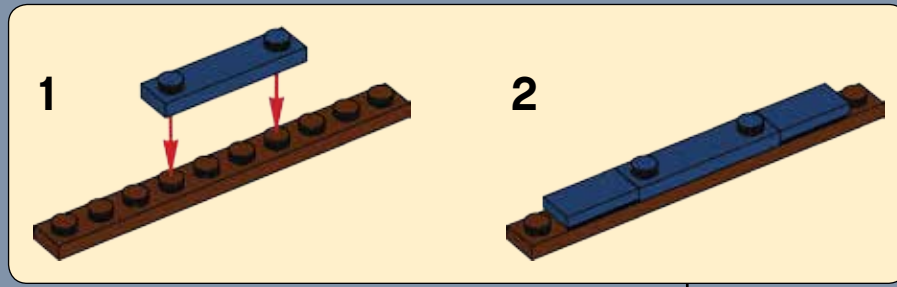



# 28

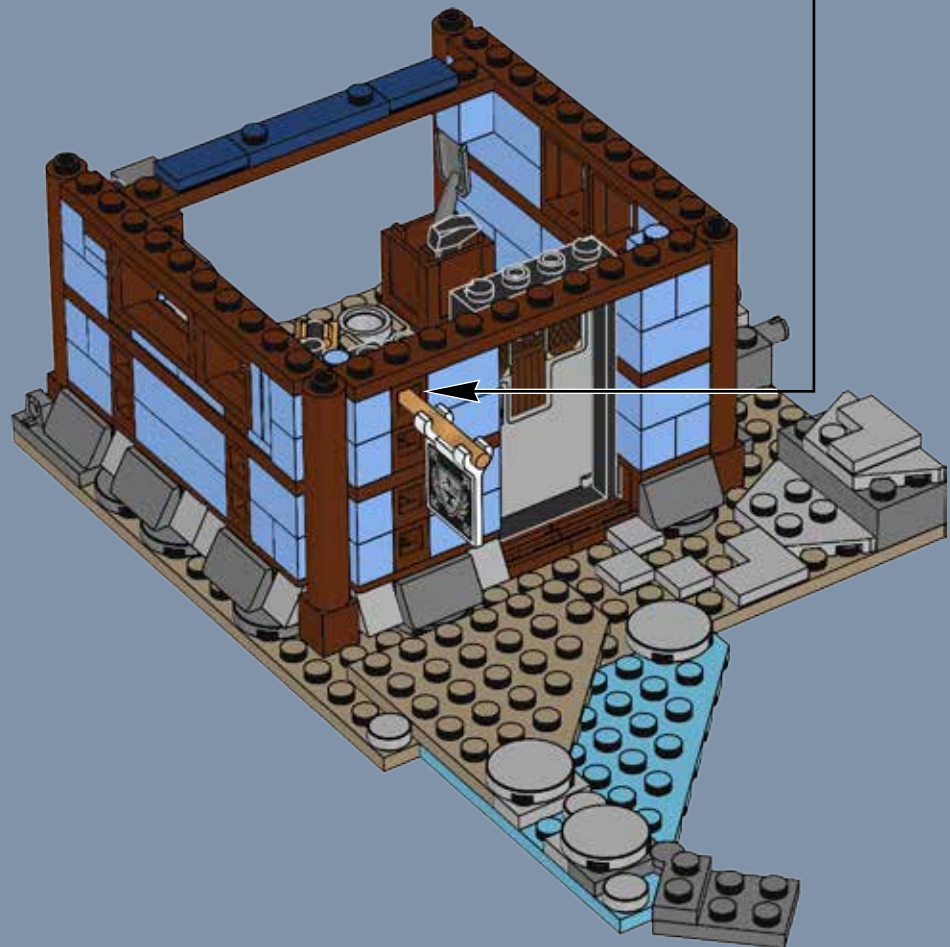
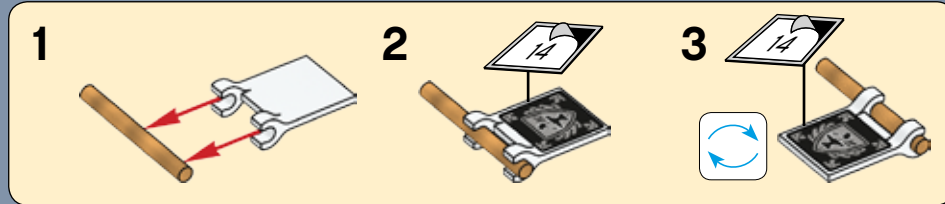

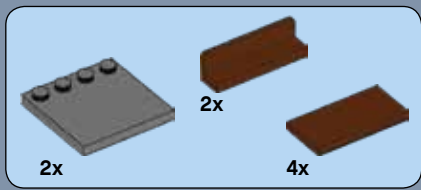

29



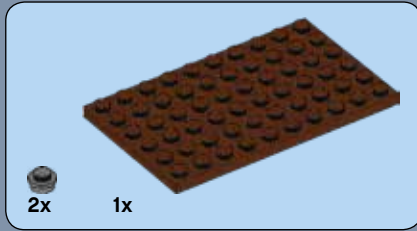
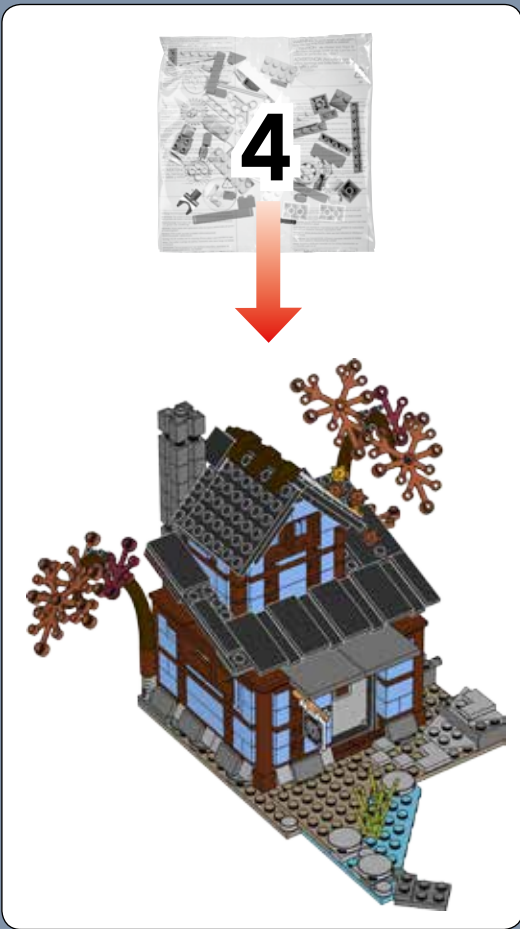

1

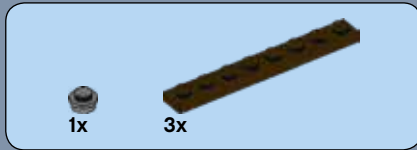
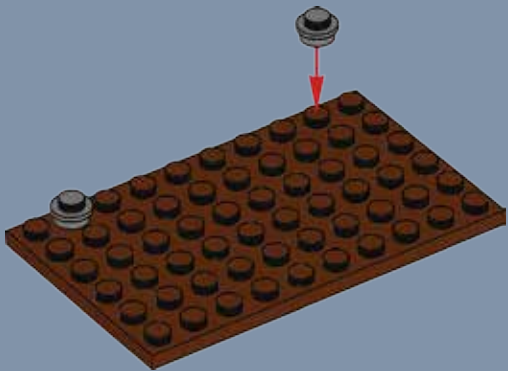

2



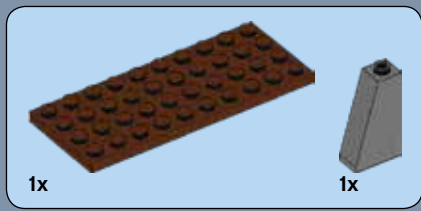

3

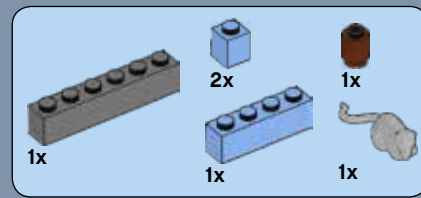
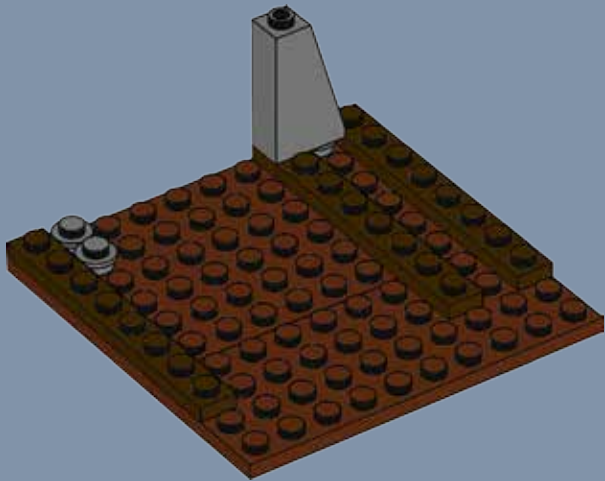

4

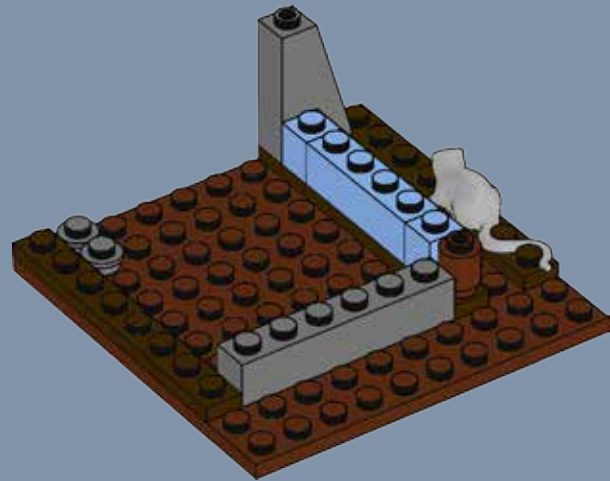

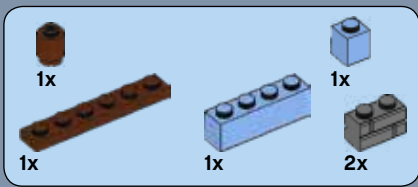

5

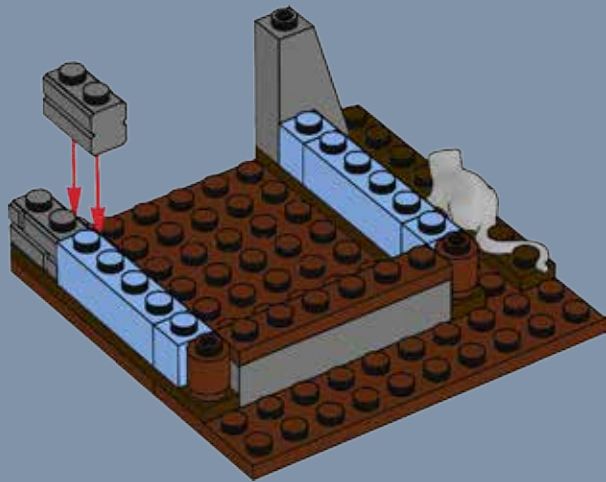

6

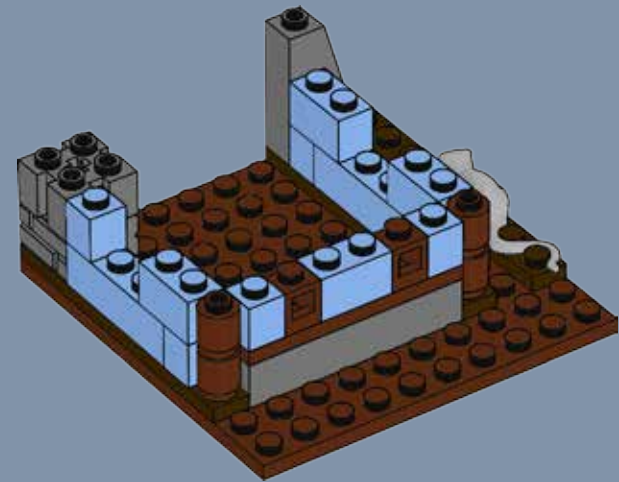

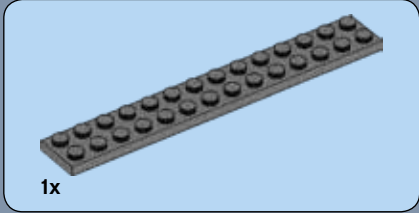
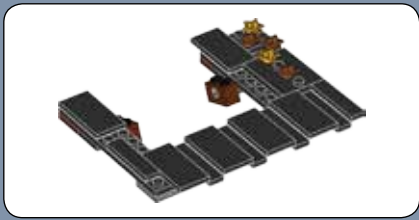

1

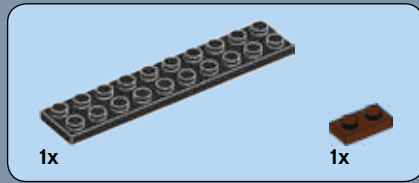
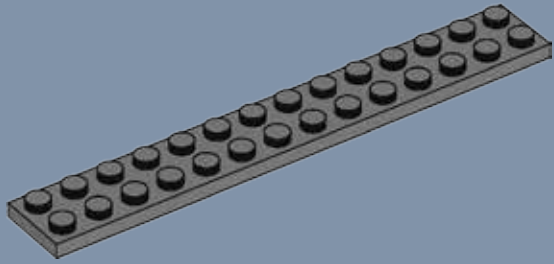

2

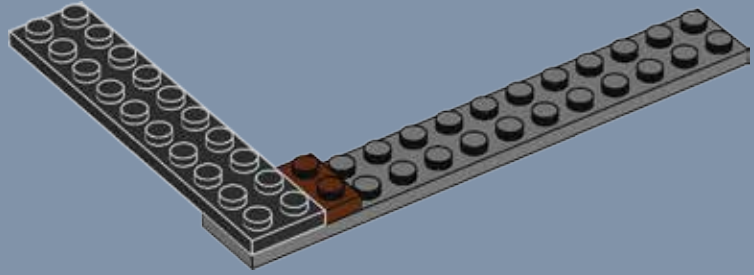



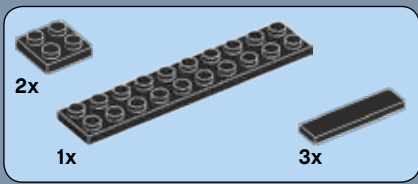

3

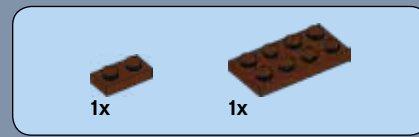
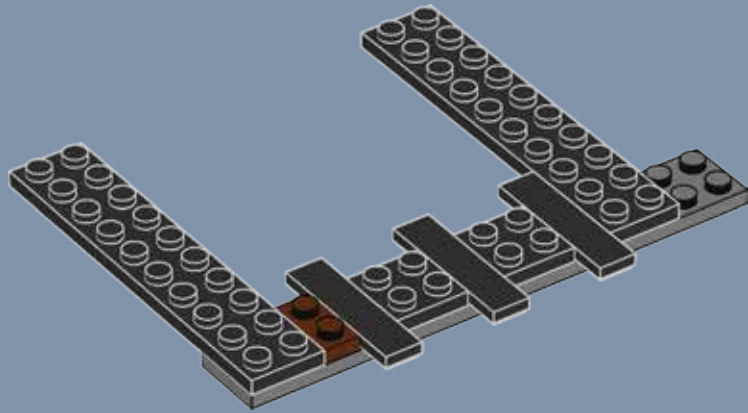

4

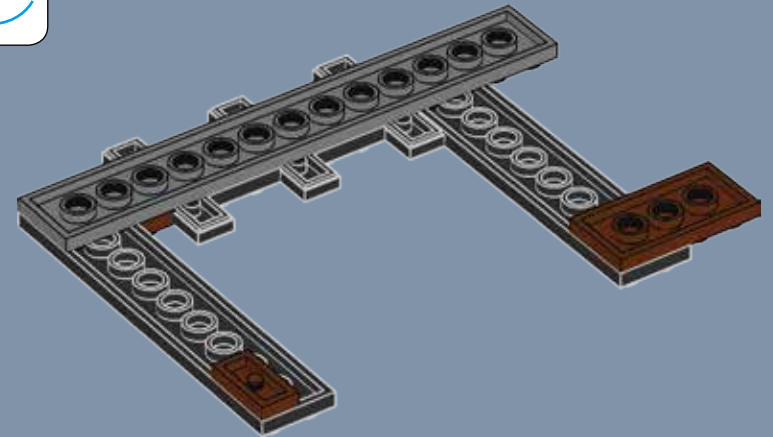

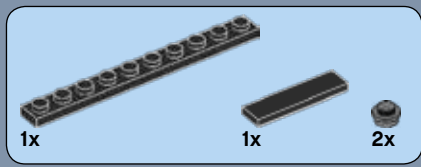

5

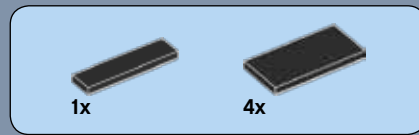
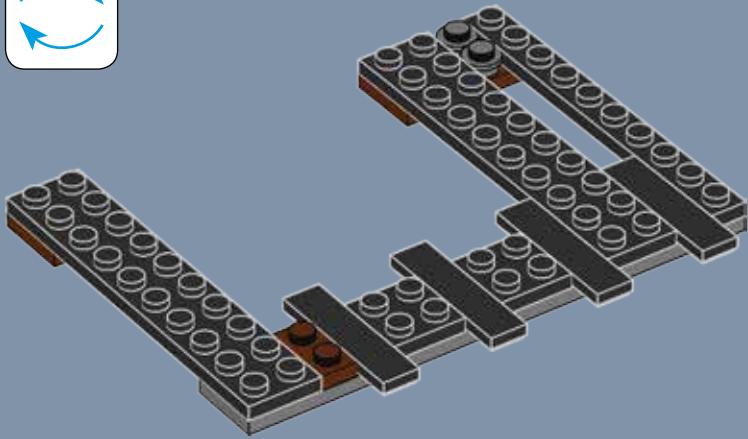

6

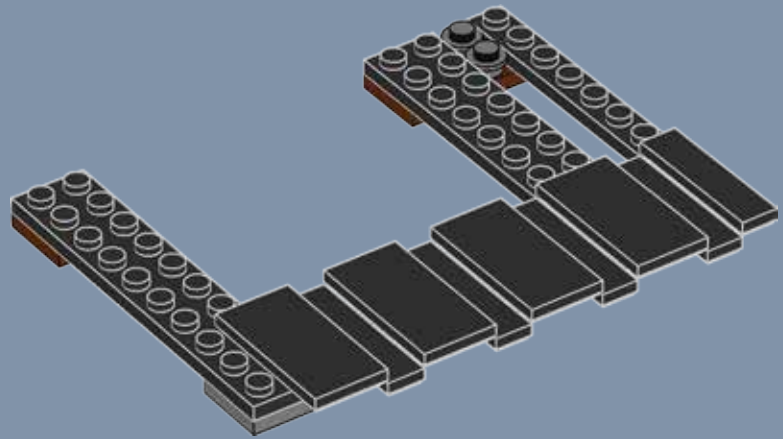

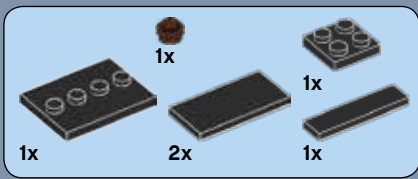

7

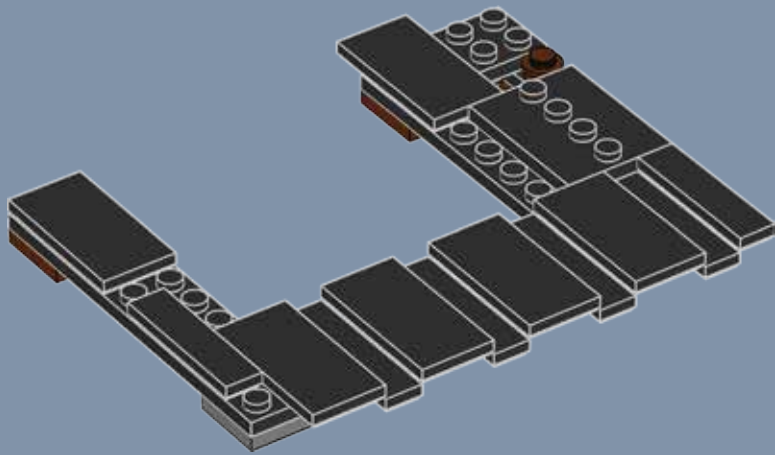

8

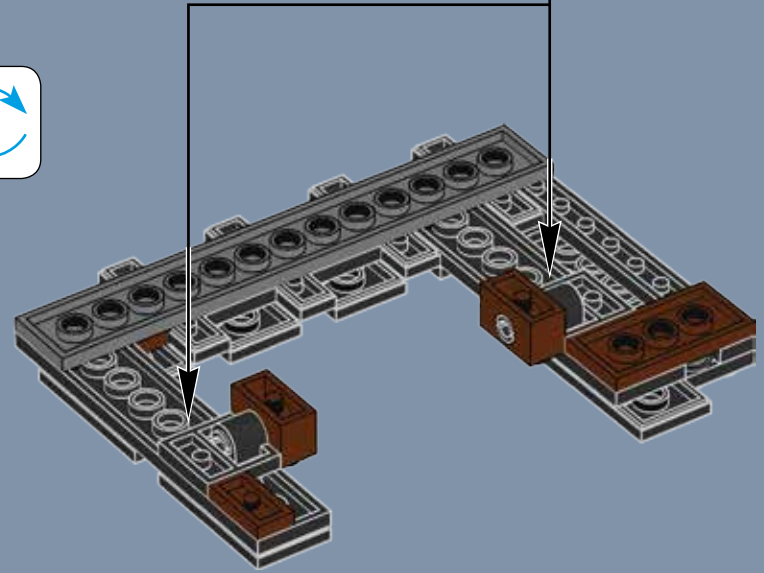
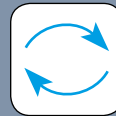
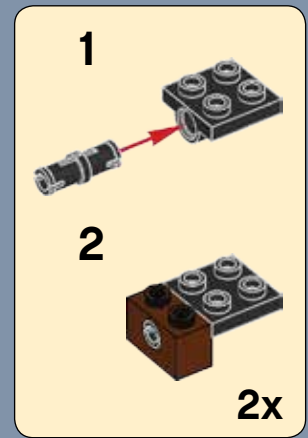

2x  3x 

9

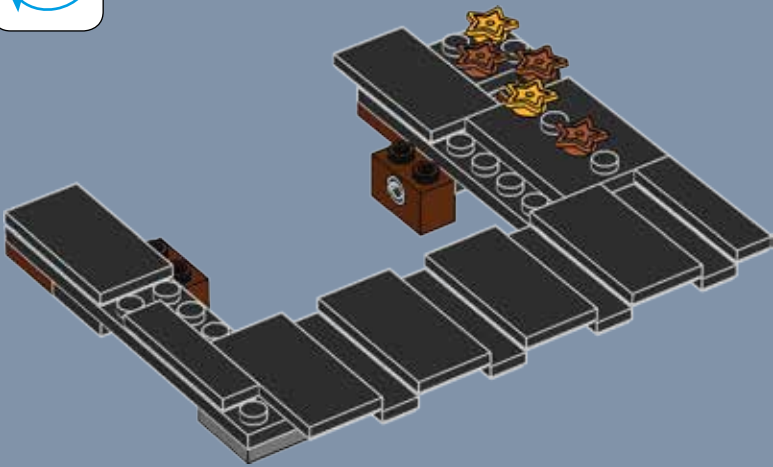

7

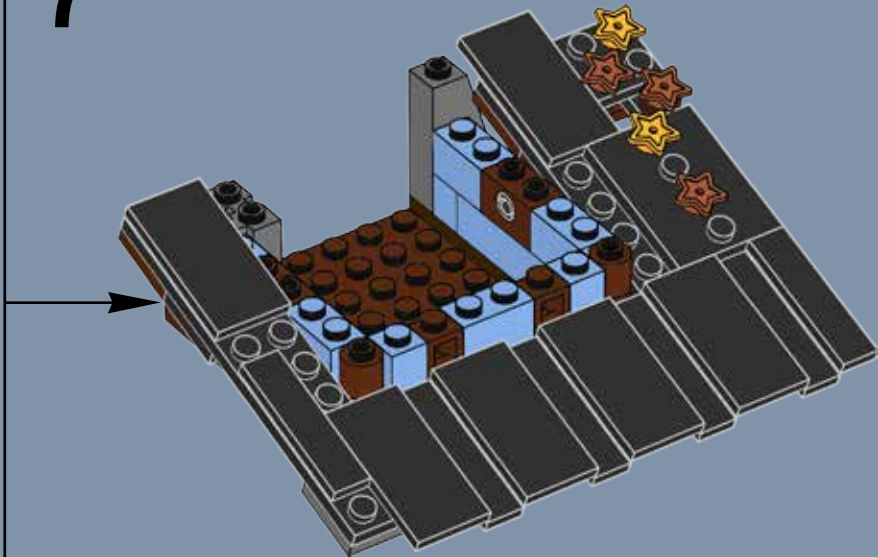

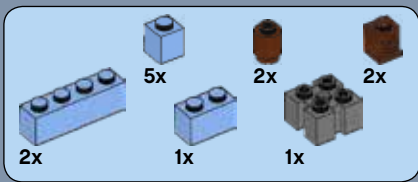

8

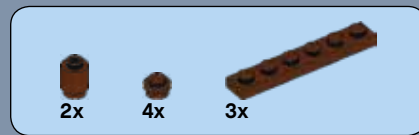
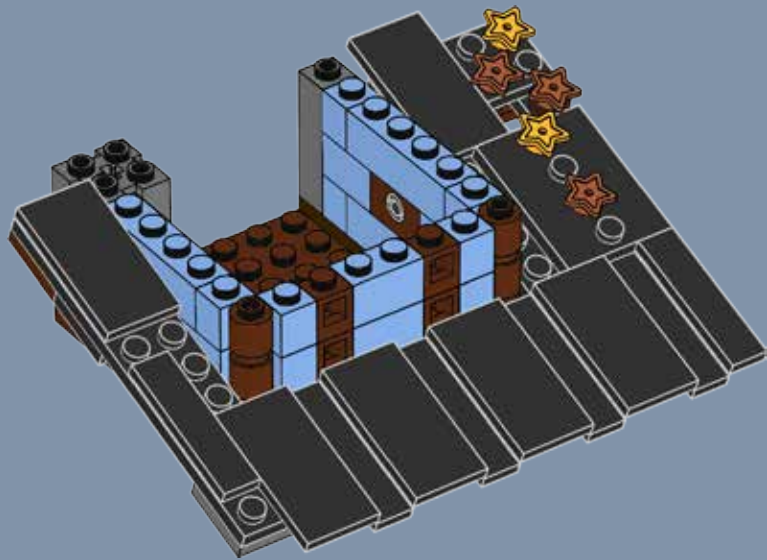

9

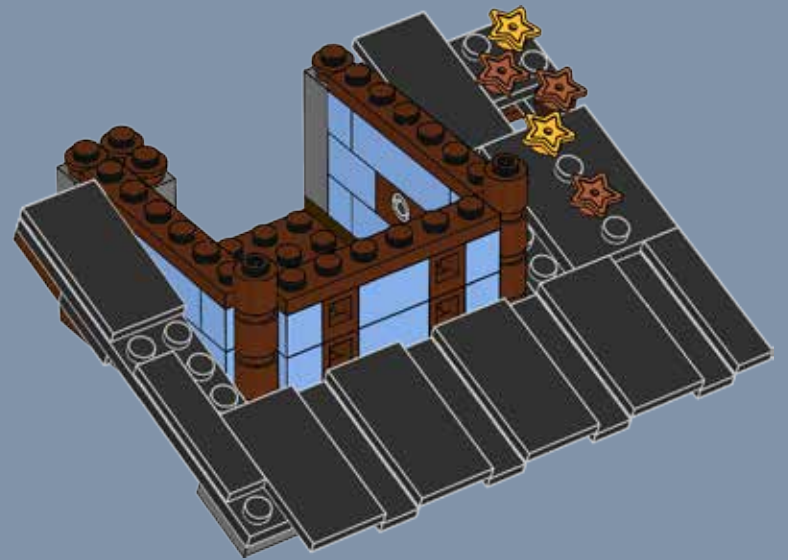



# 10

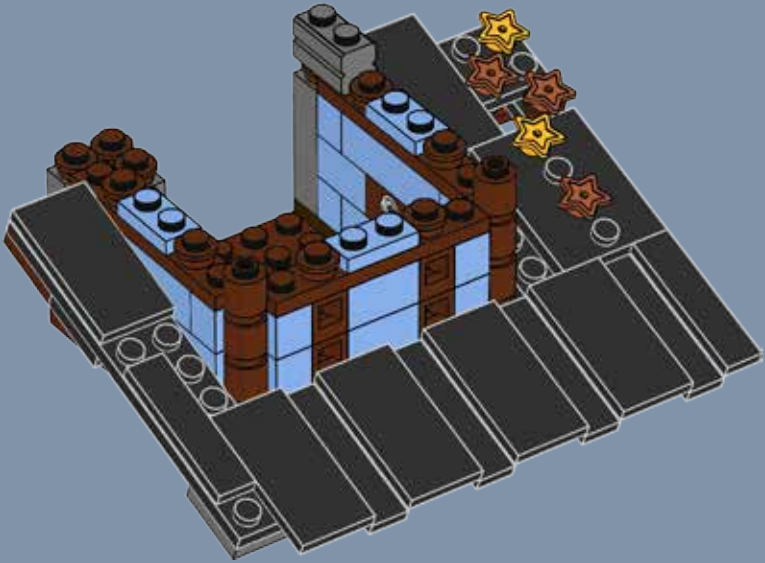

# 11

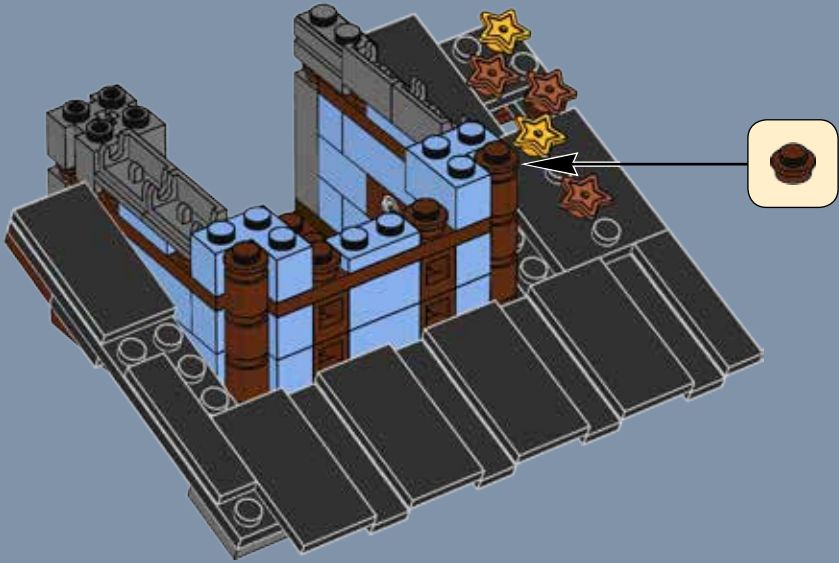



12

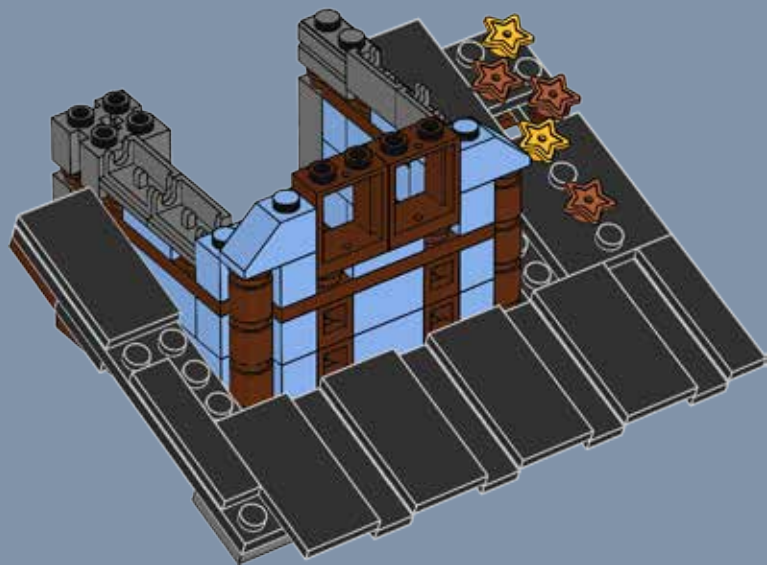

13

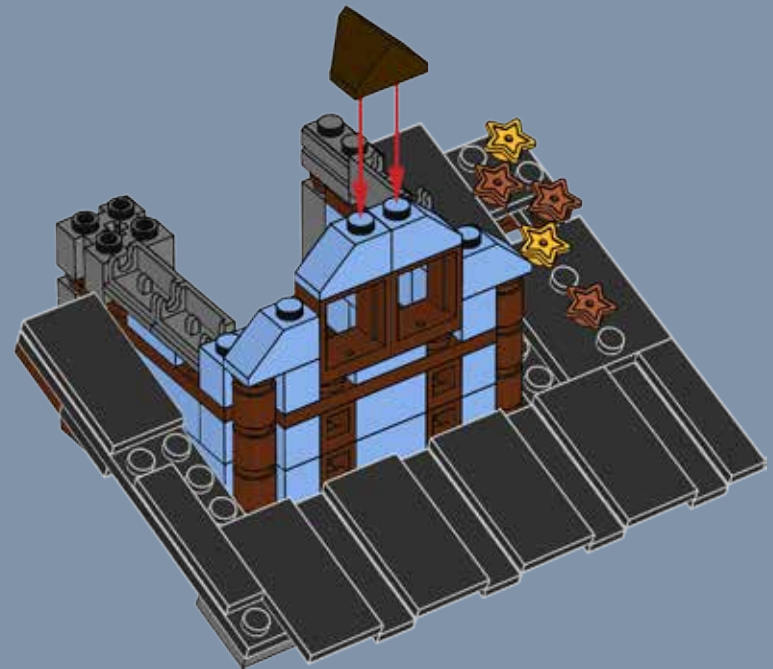

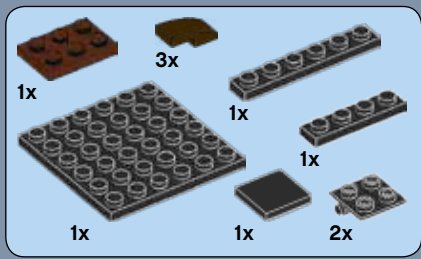

# 14

1

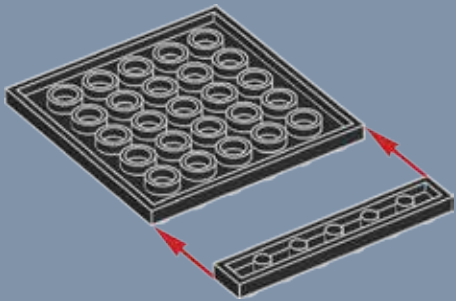

2

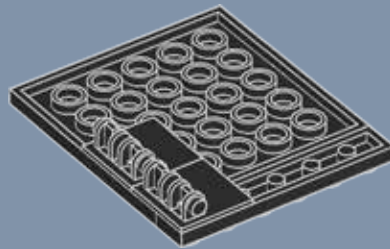

3

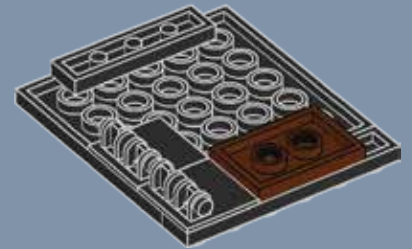



4

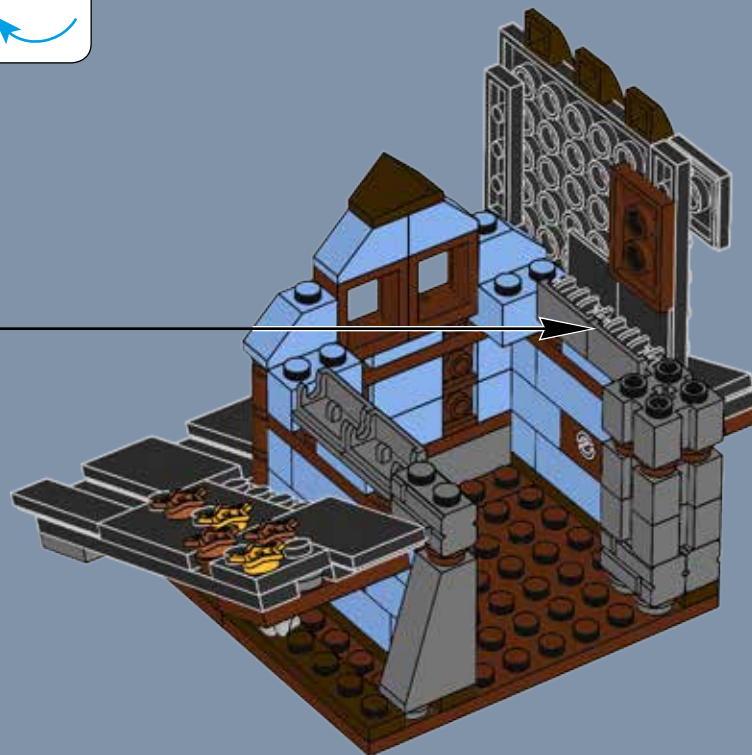
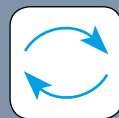
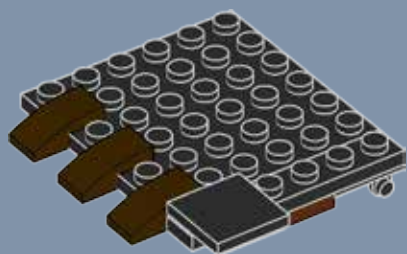

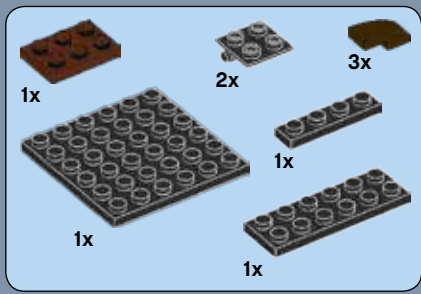

# 15

1

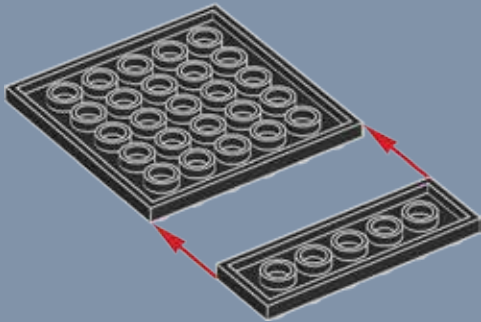

2

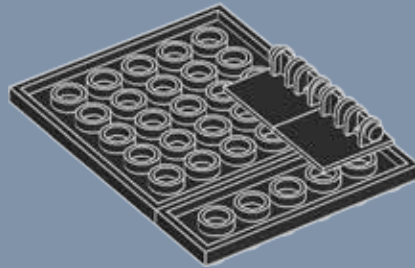

3

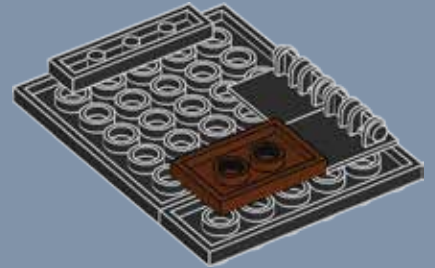

4

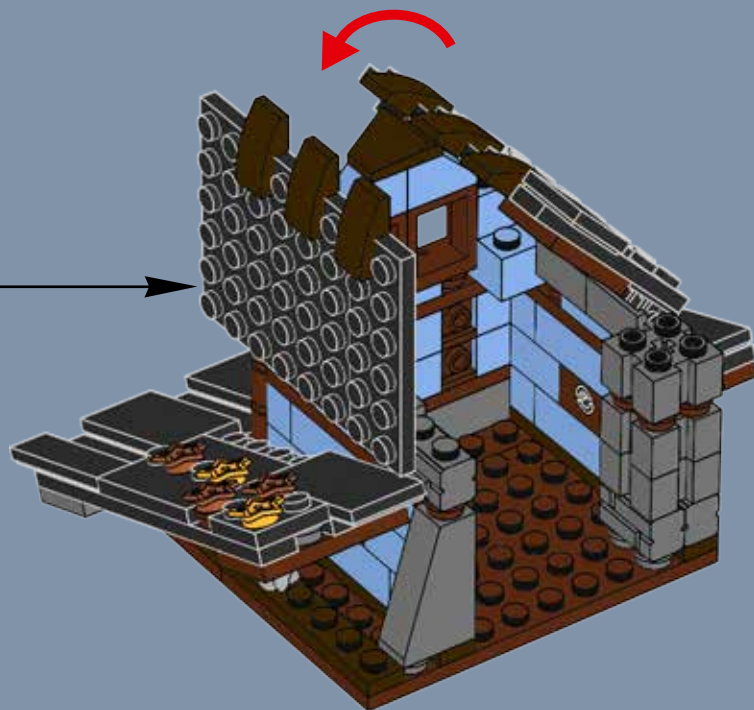
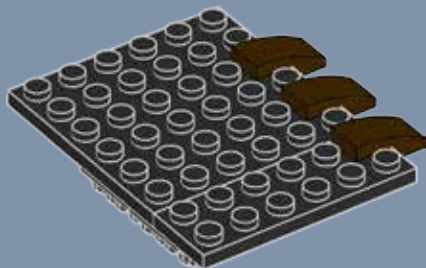



16

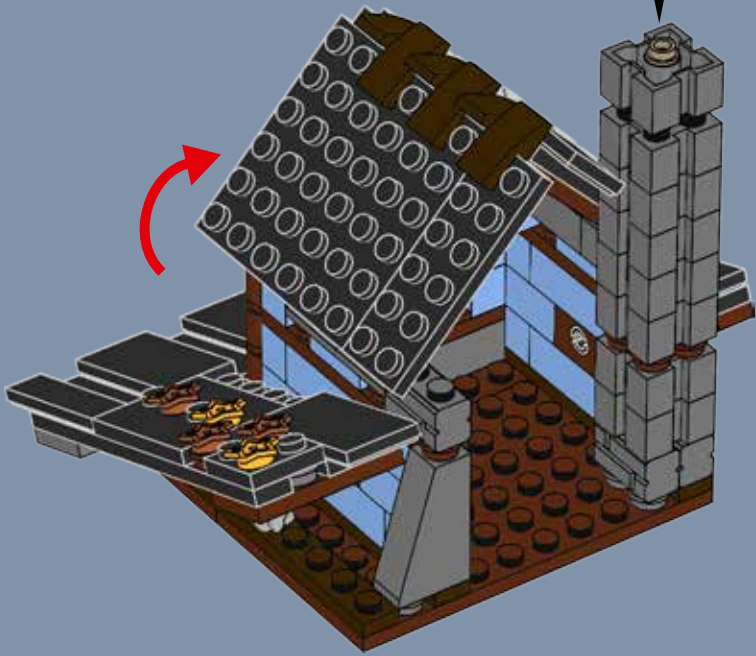
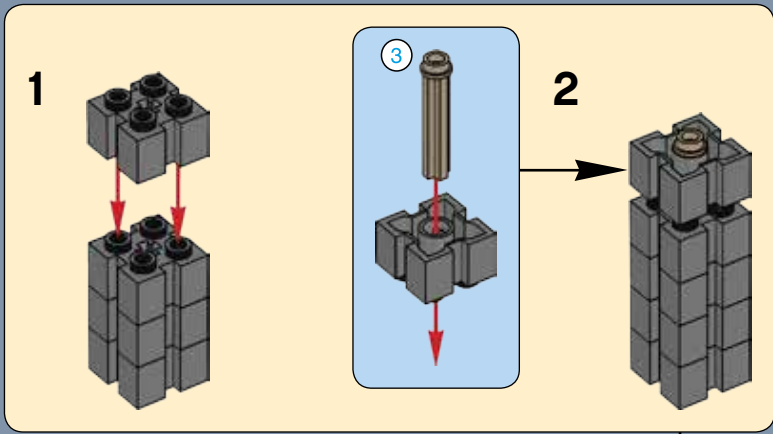

30





# 31

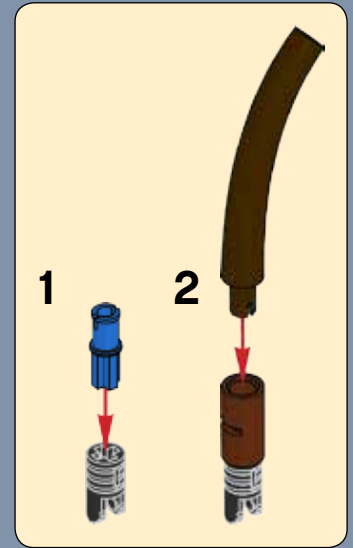
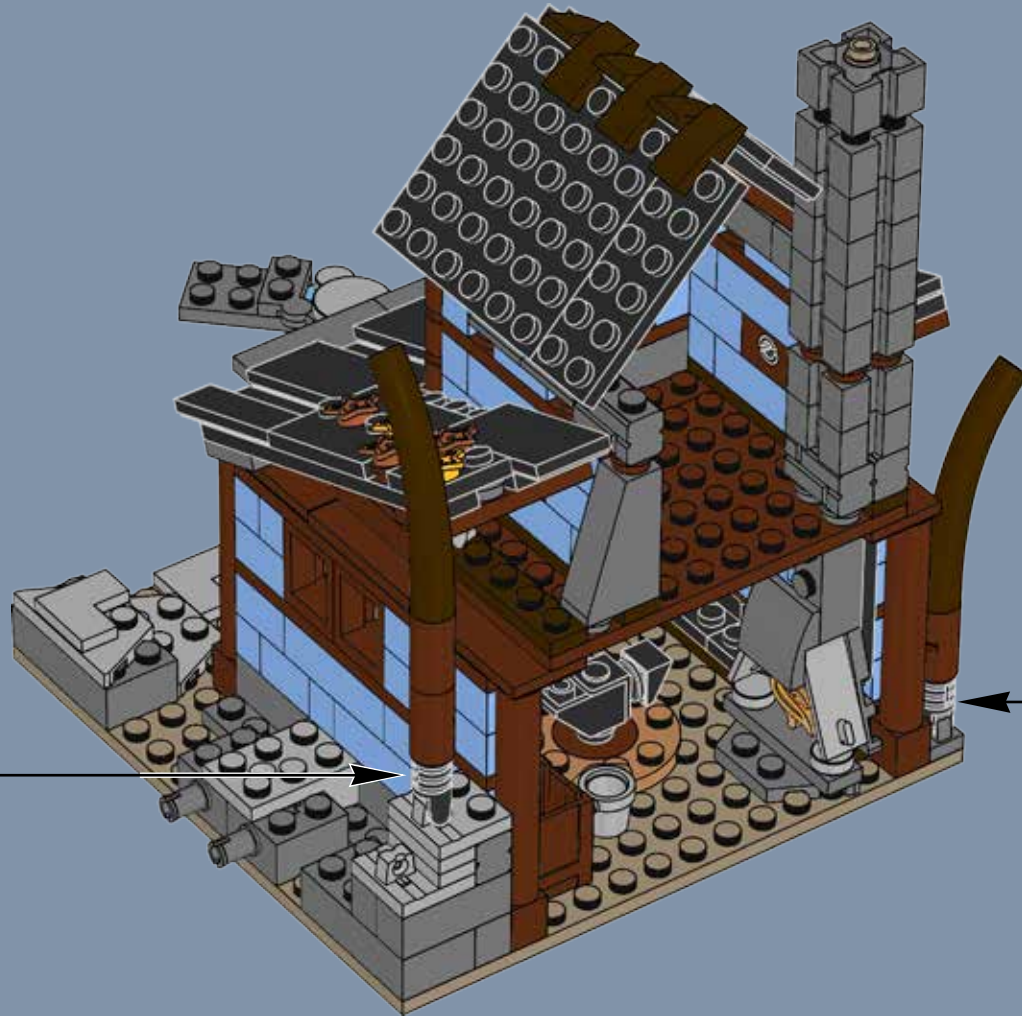
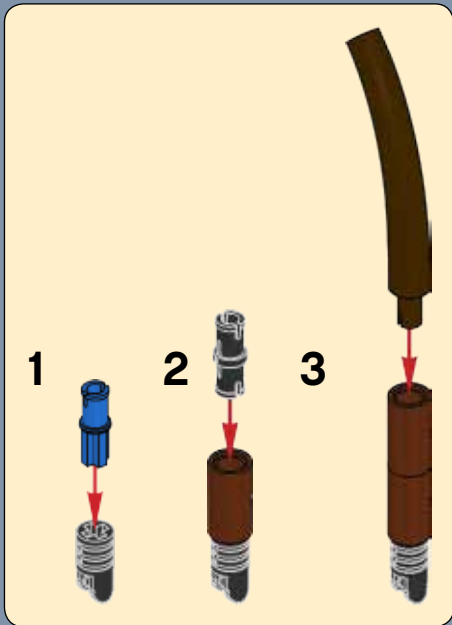

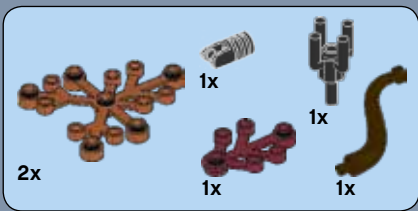

32

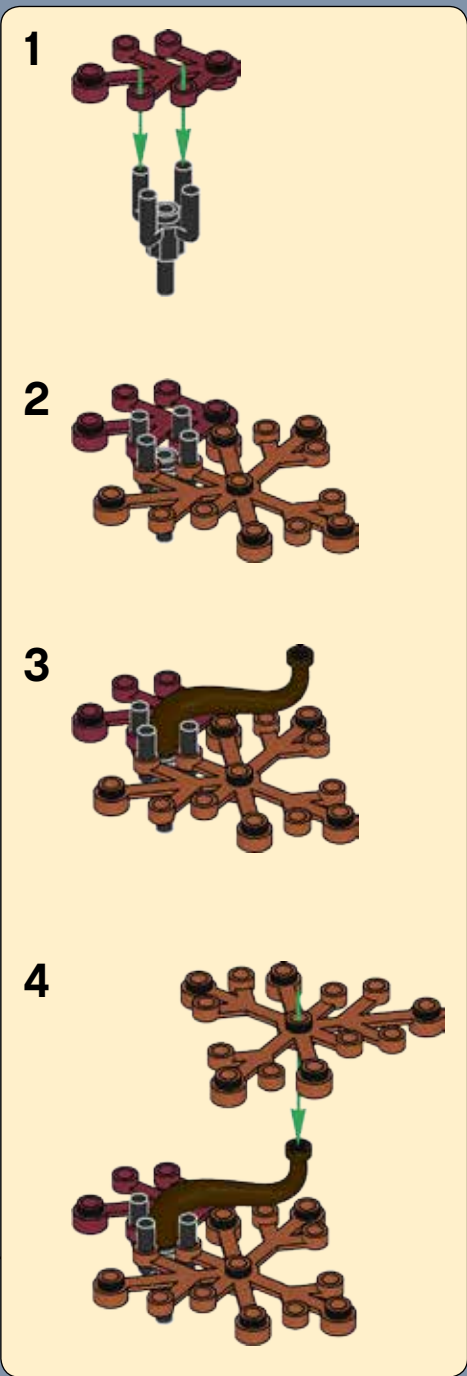



33

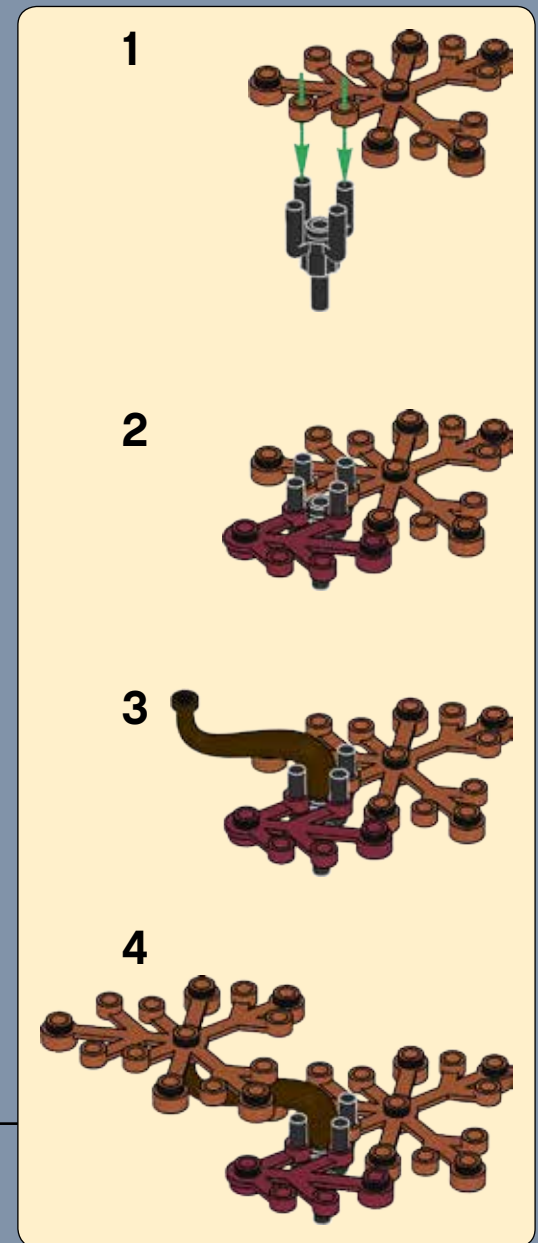



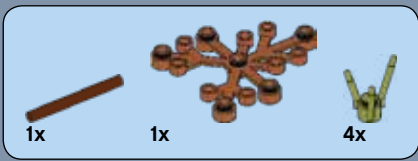

# 34

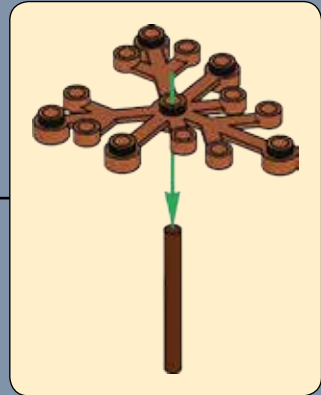
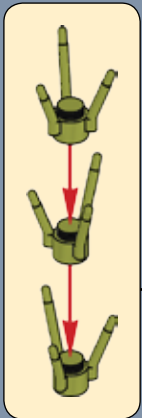

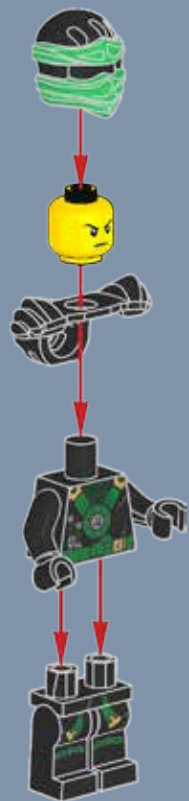
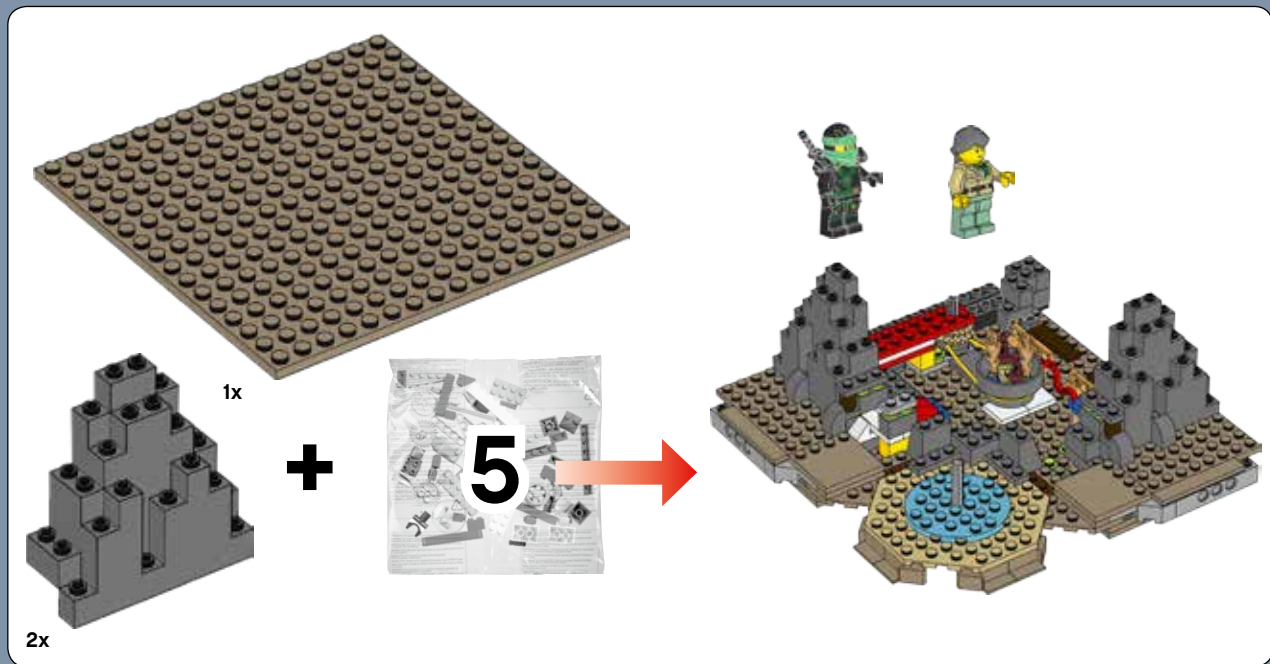
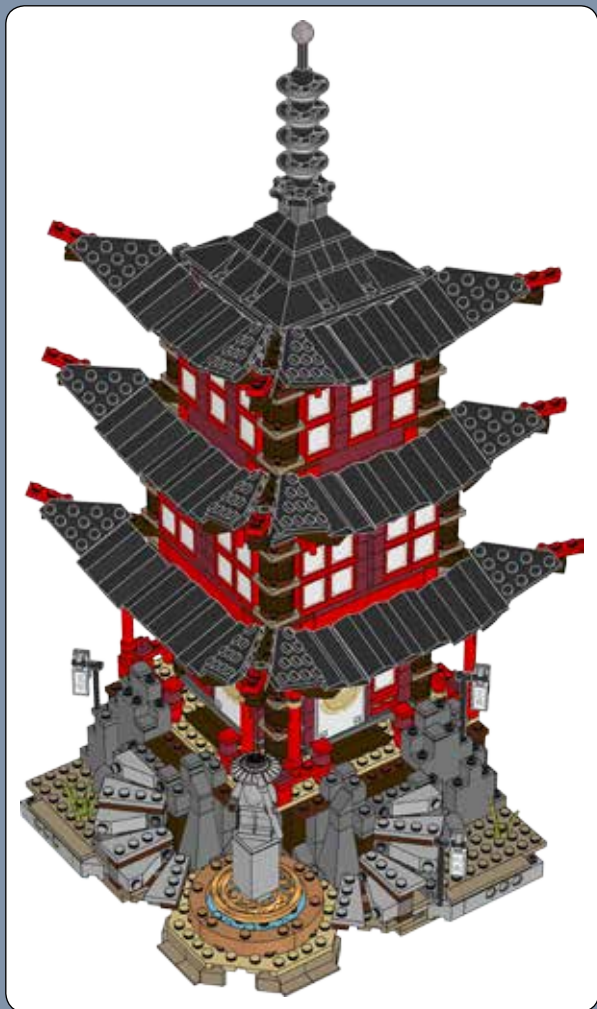

1

2

3



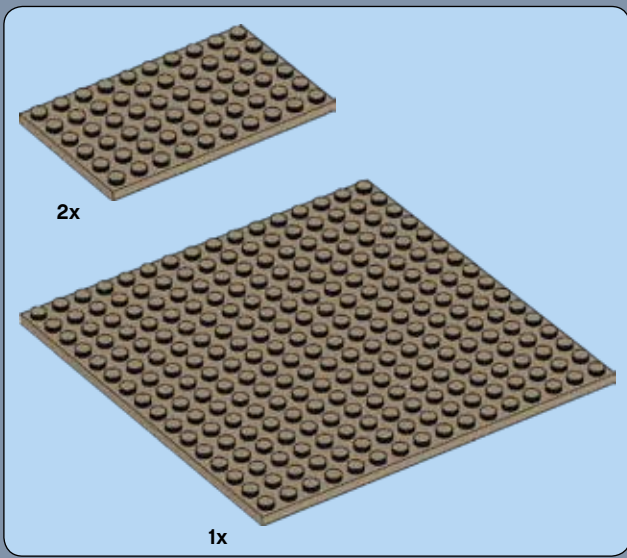

**1**

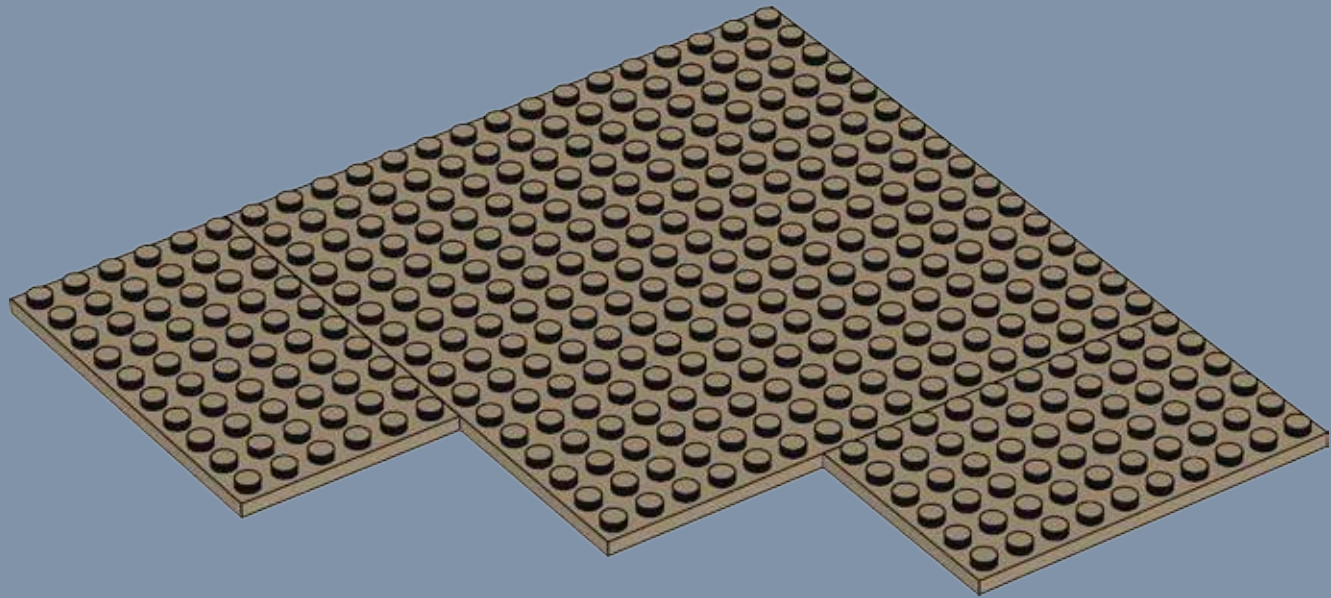

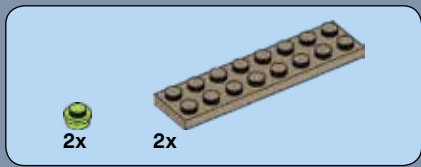

2

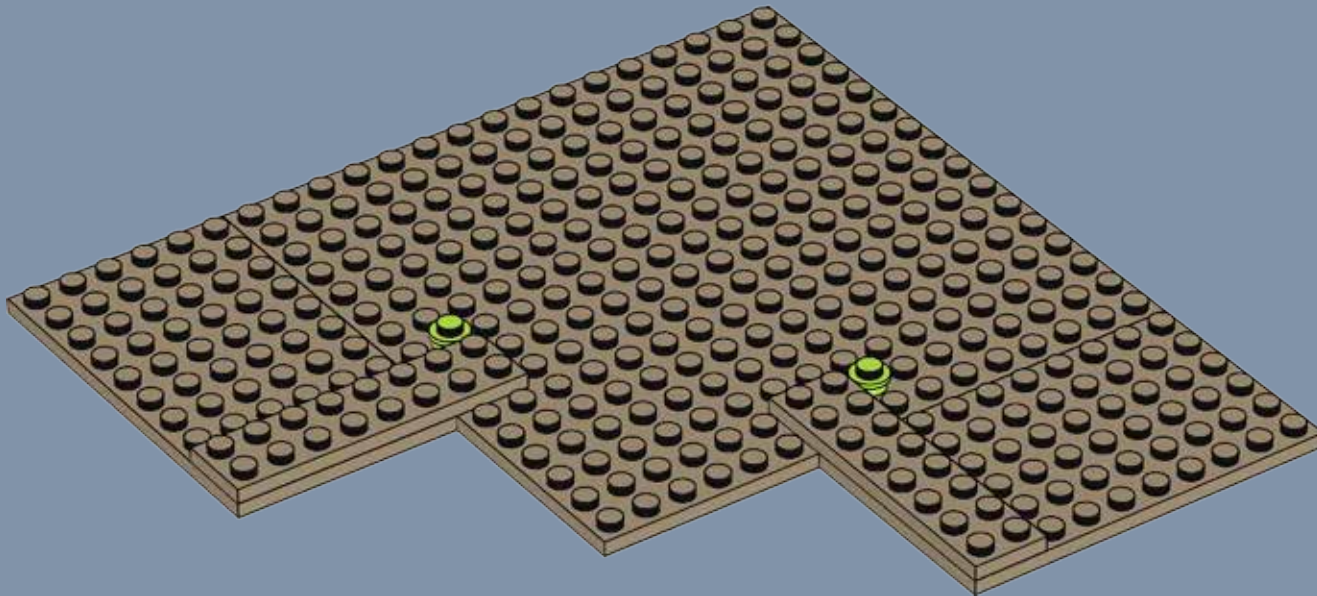

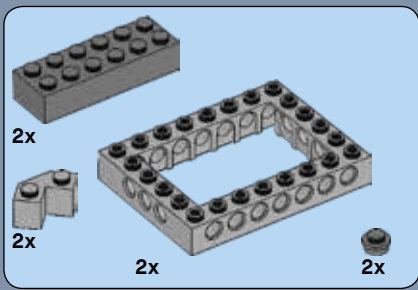

3

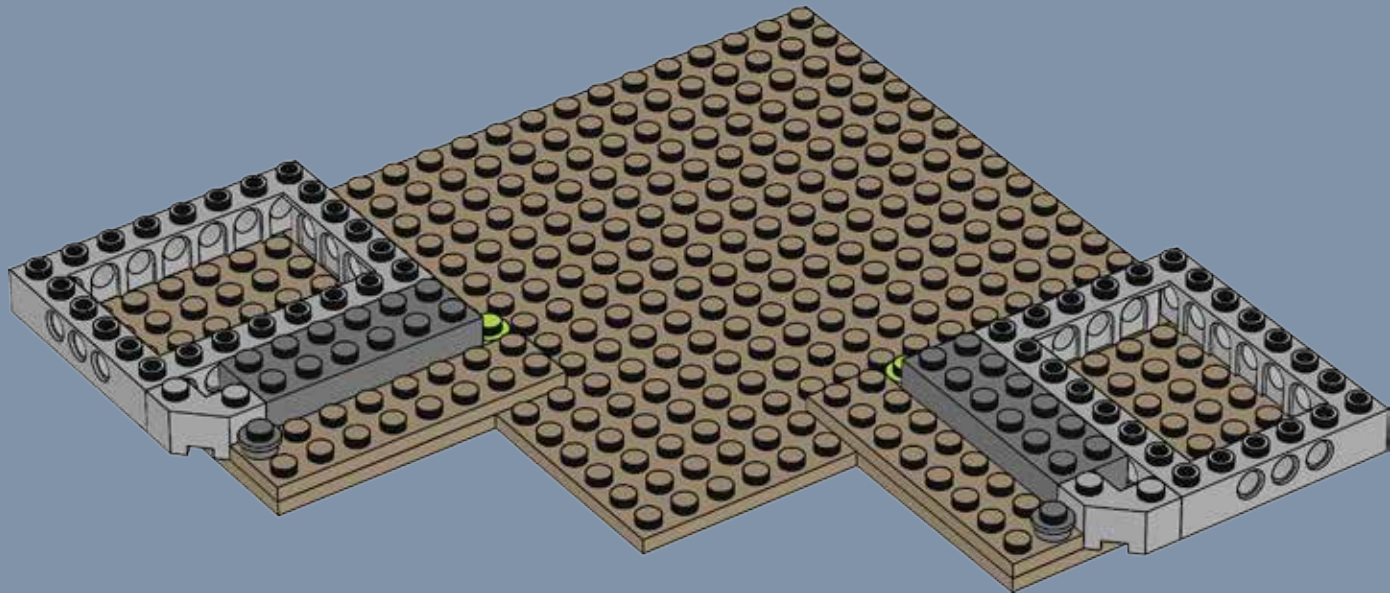



4

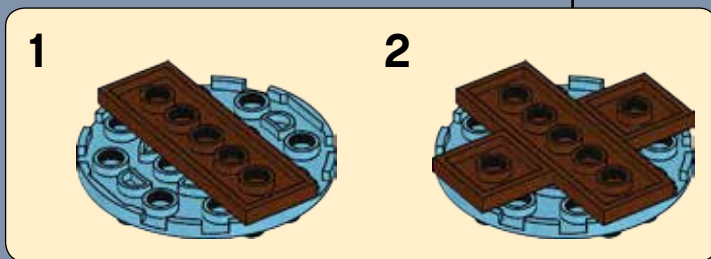
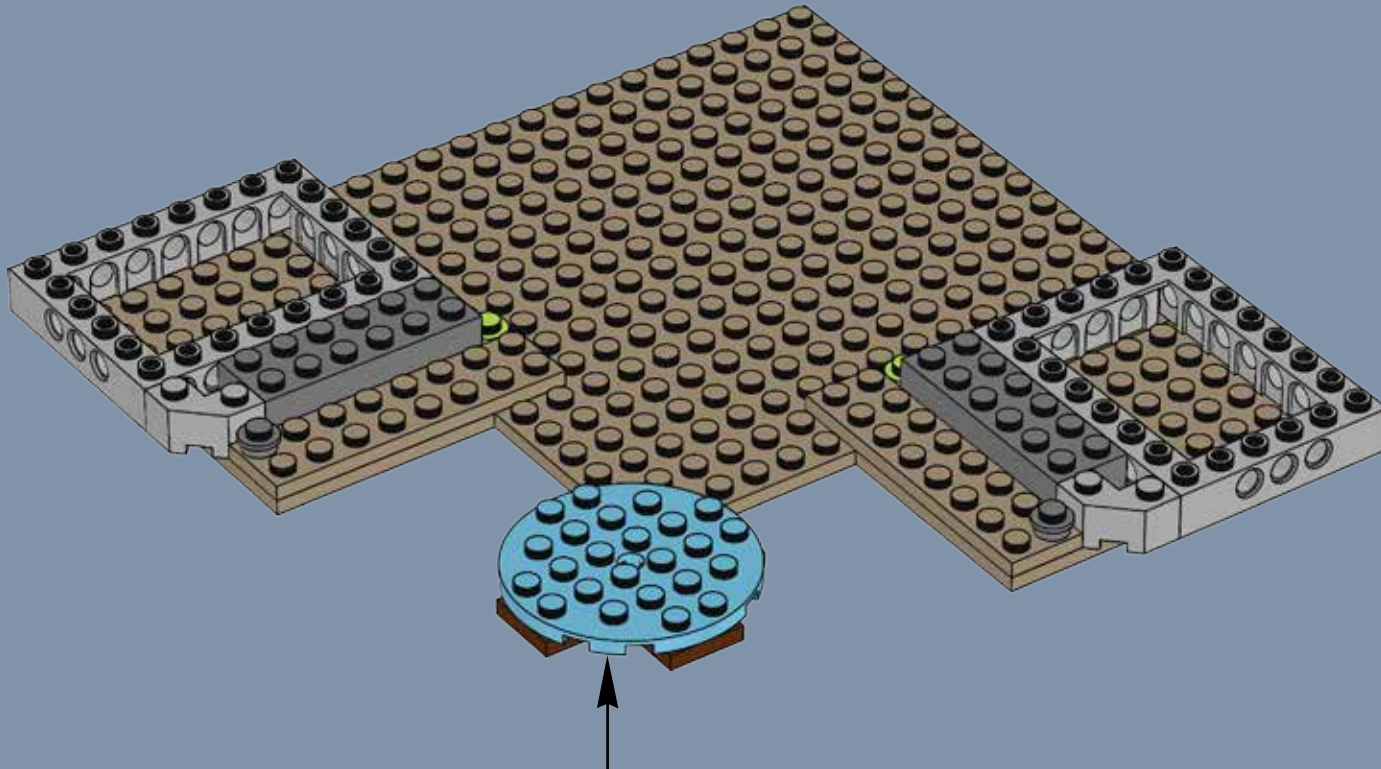

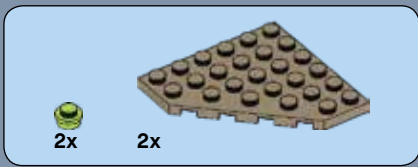

5

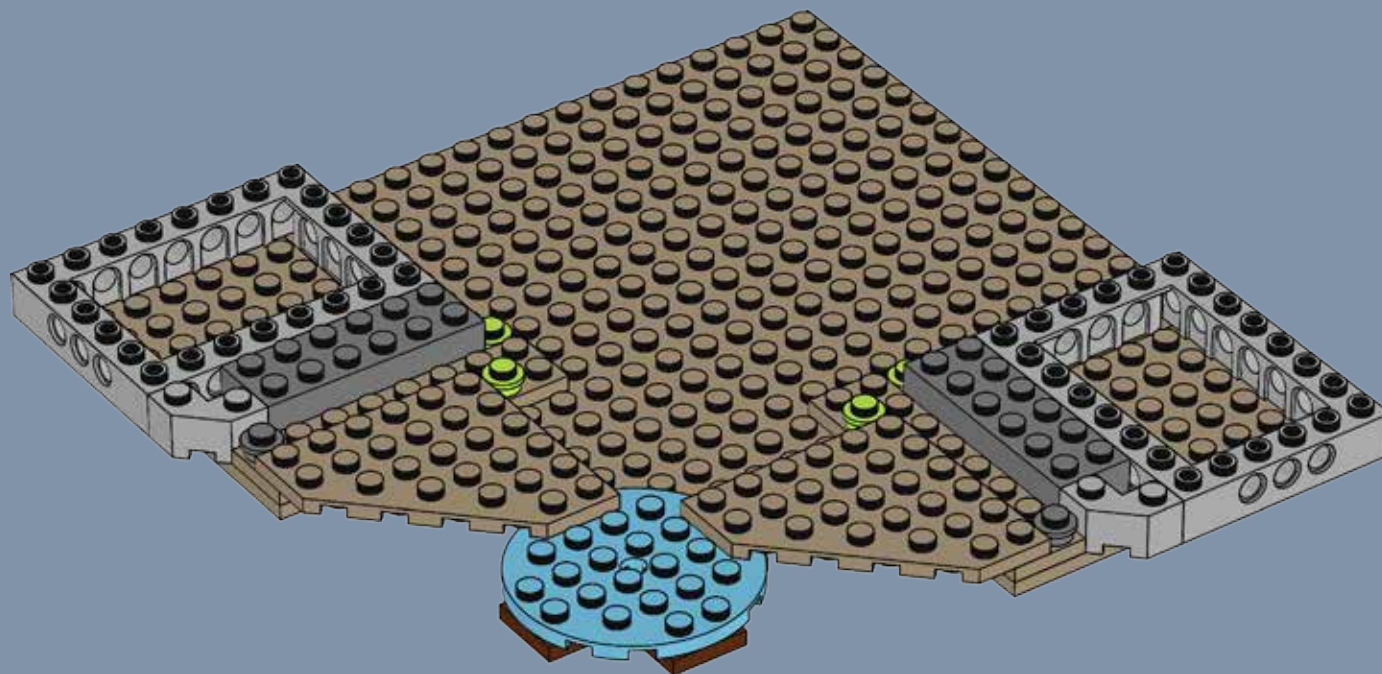

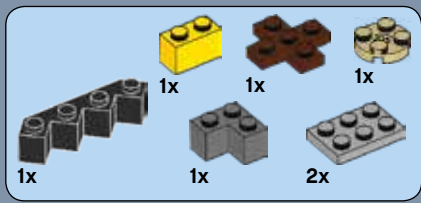

6





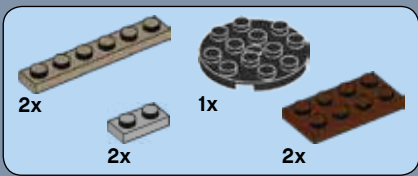

7

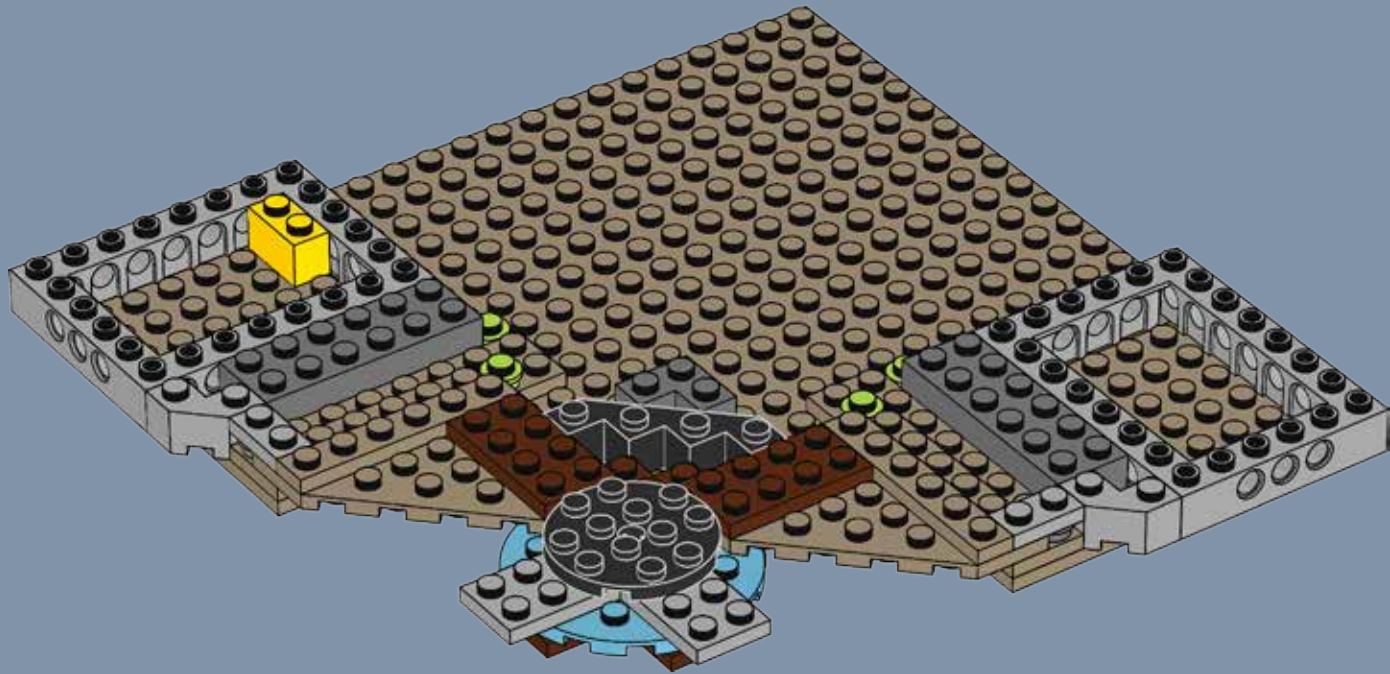



8

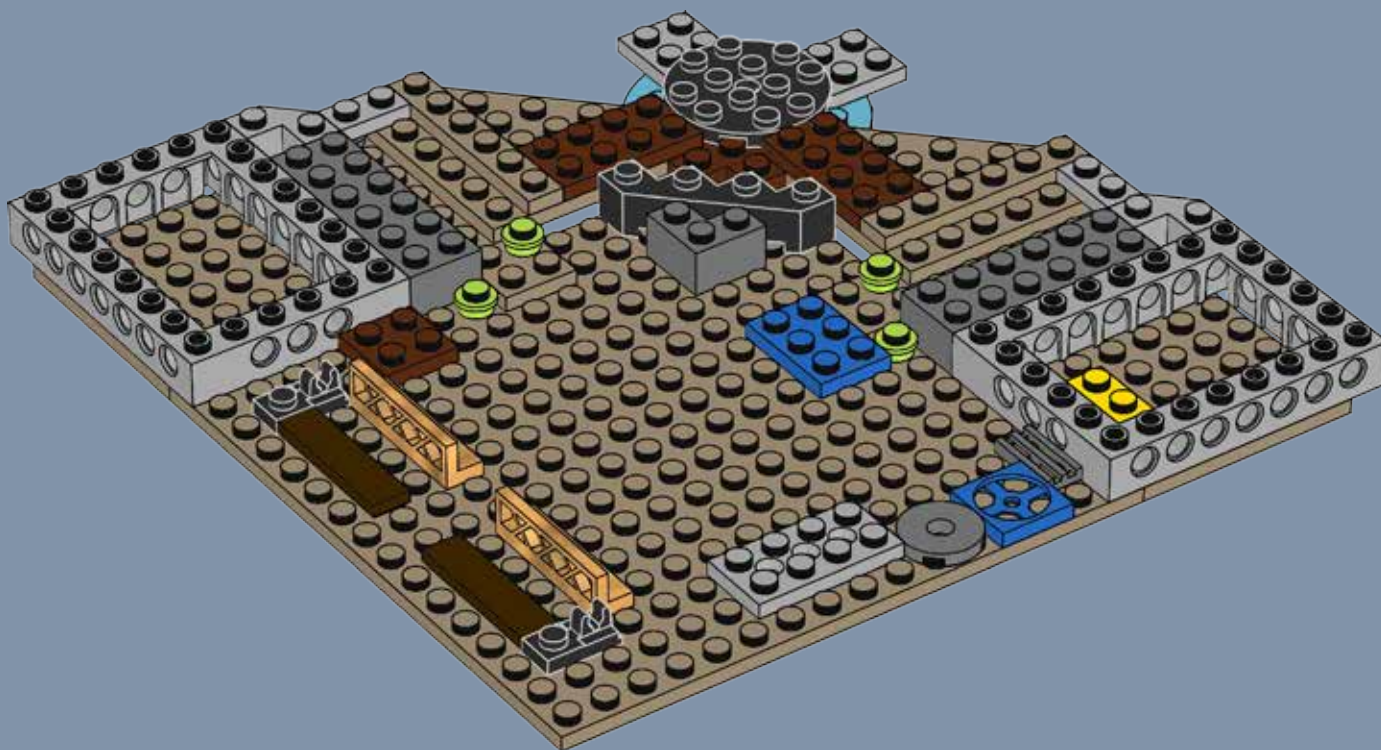
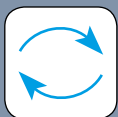



9



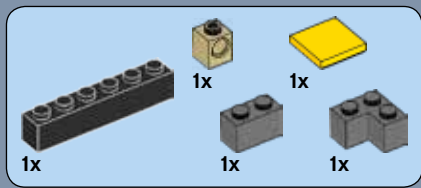

10





11

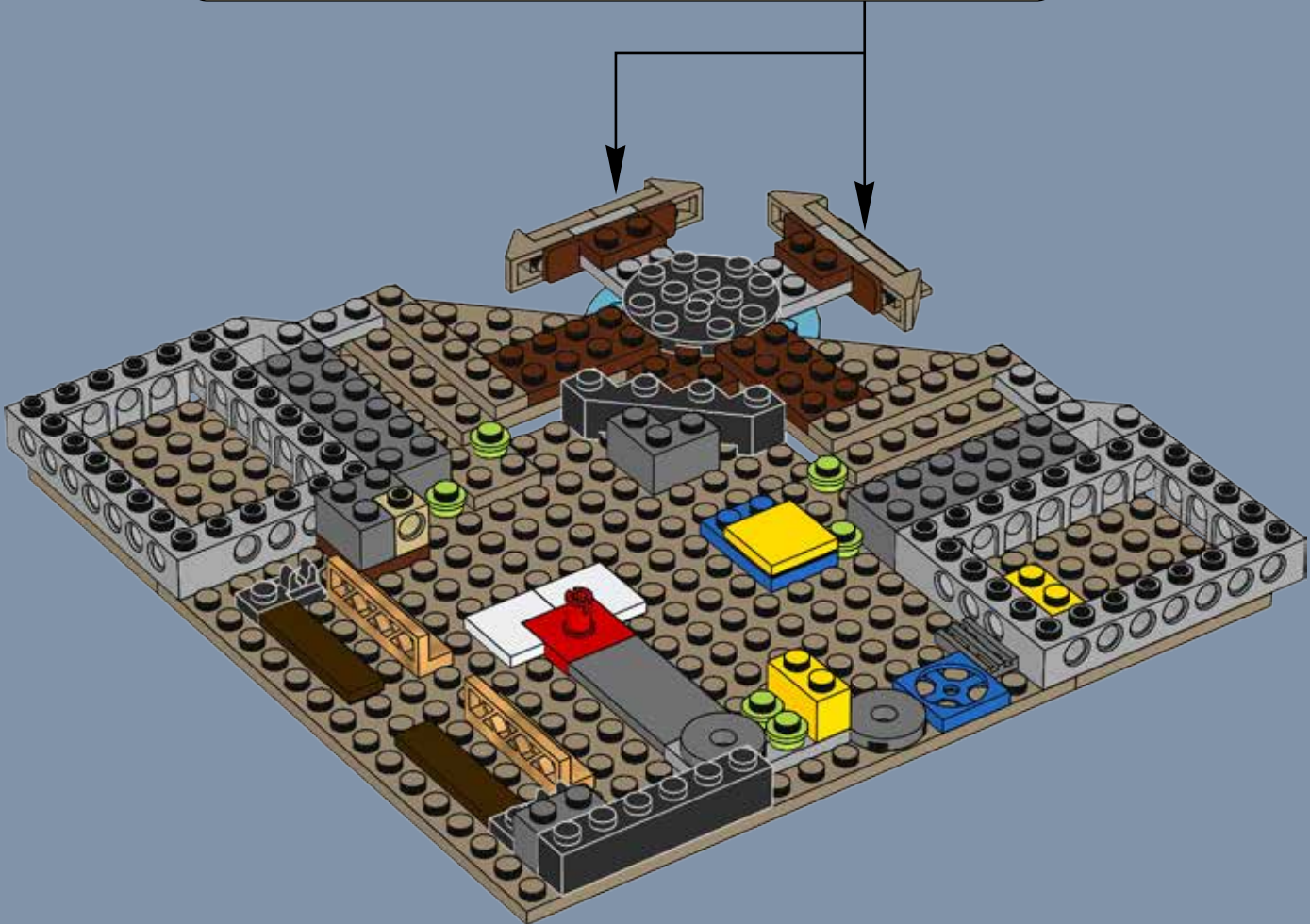
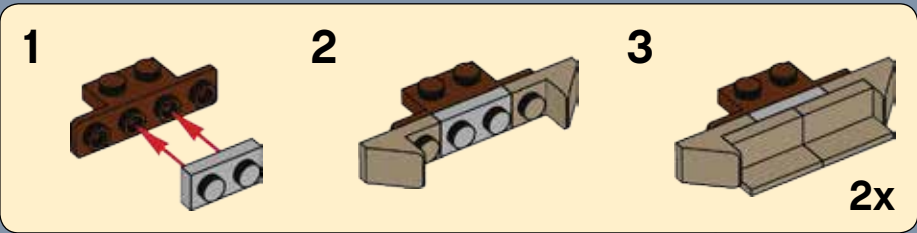

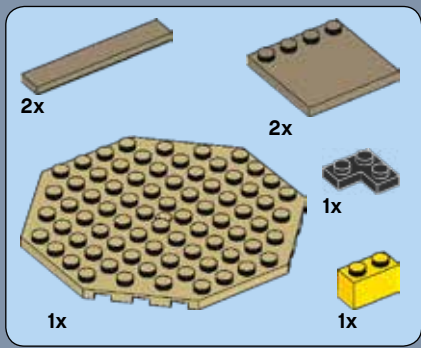

12



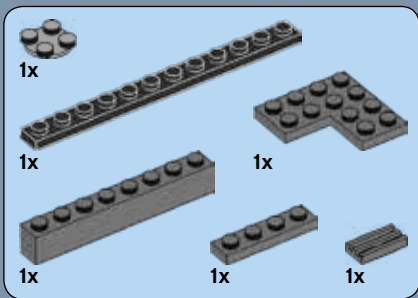

# 13

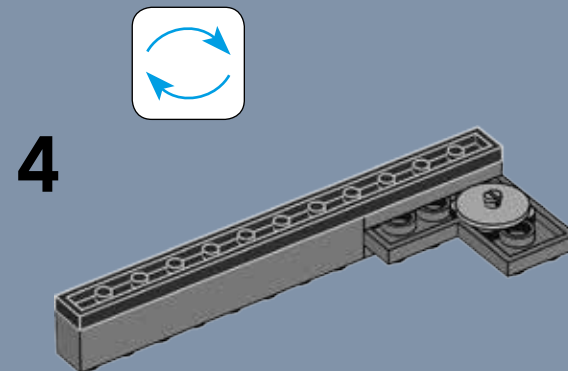
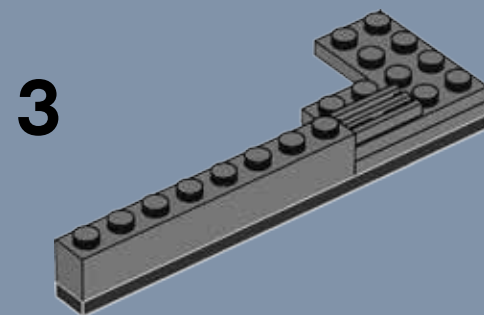
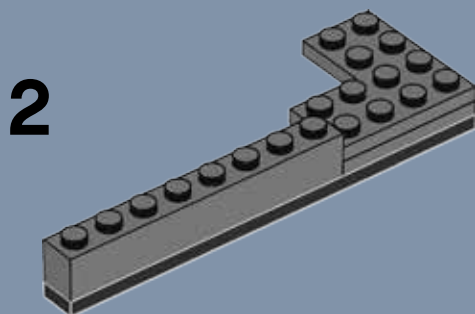
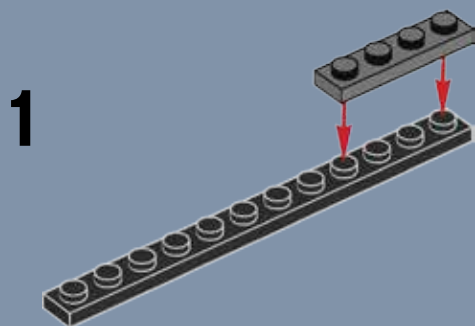

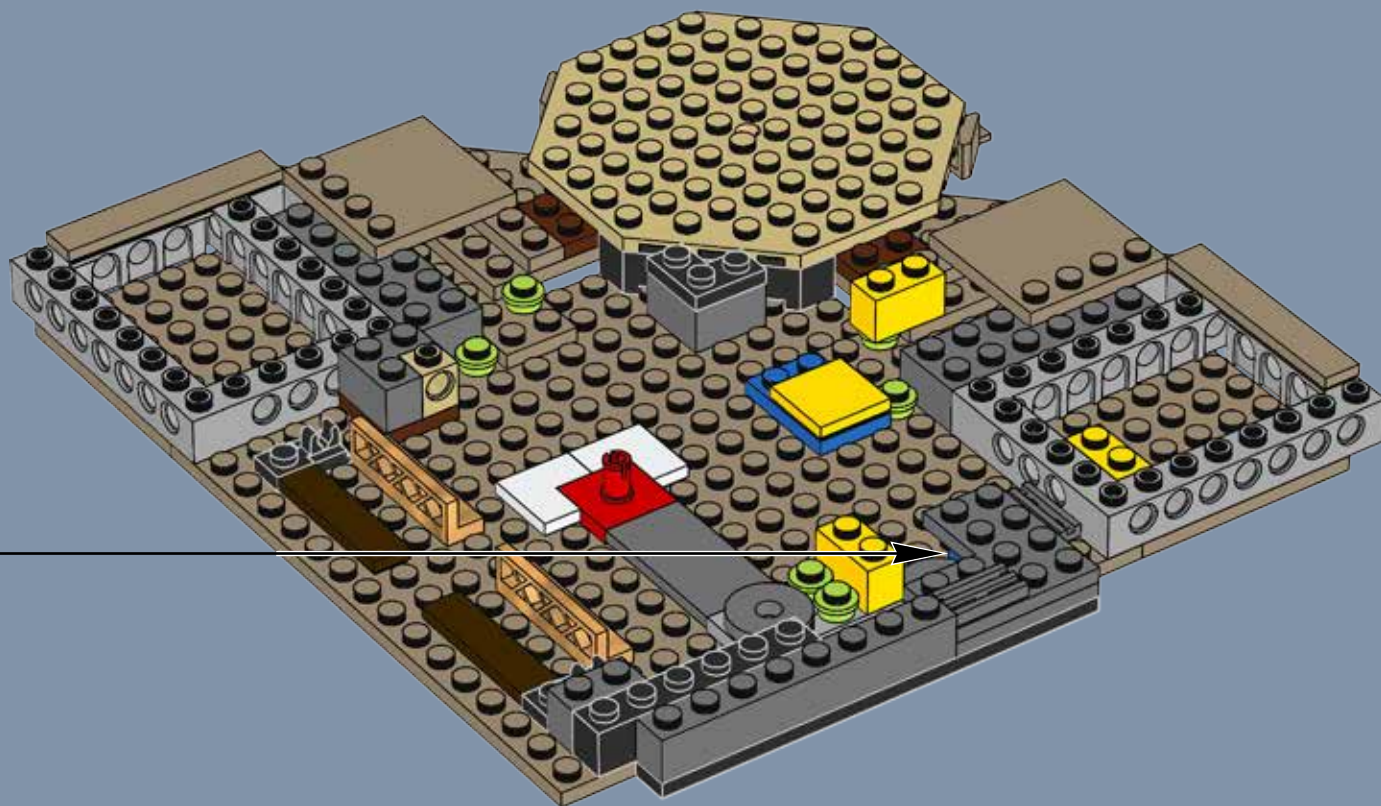



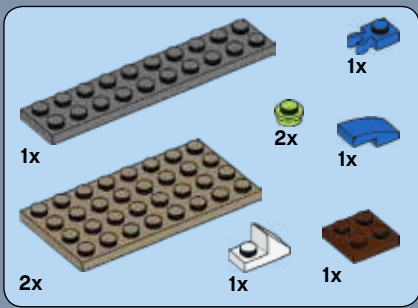

14

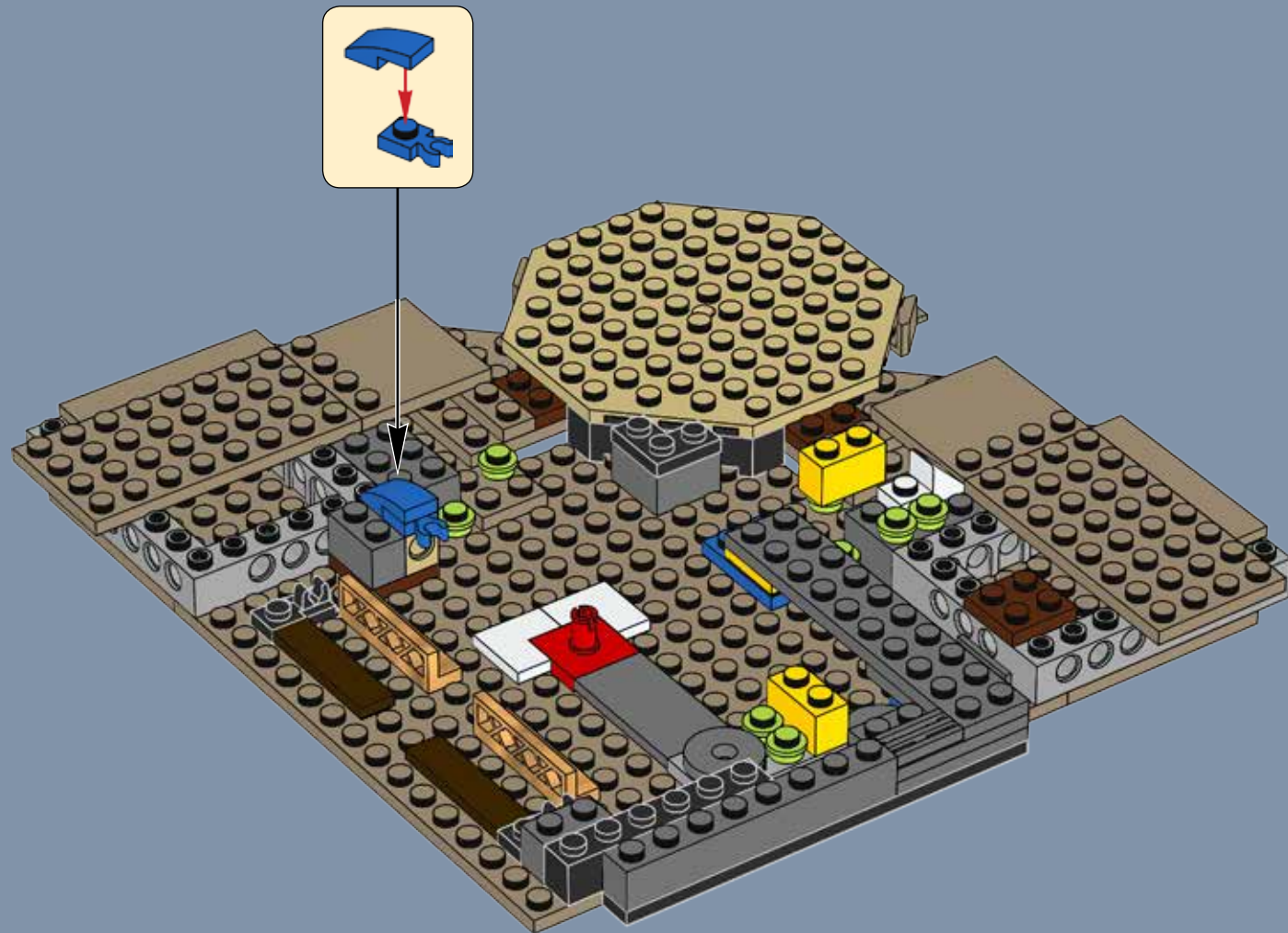

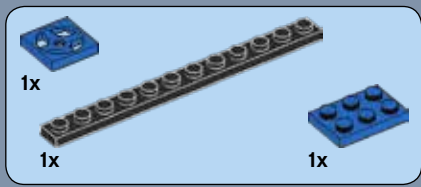

15



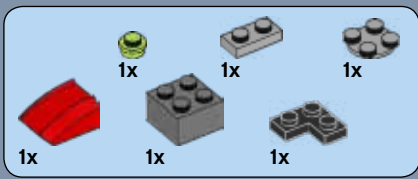

# 16

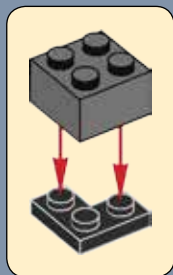
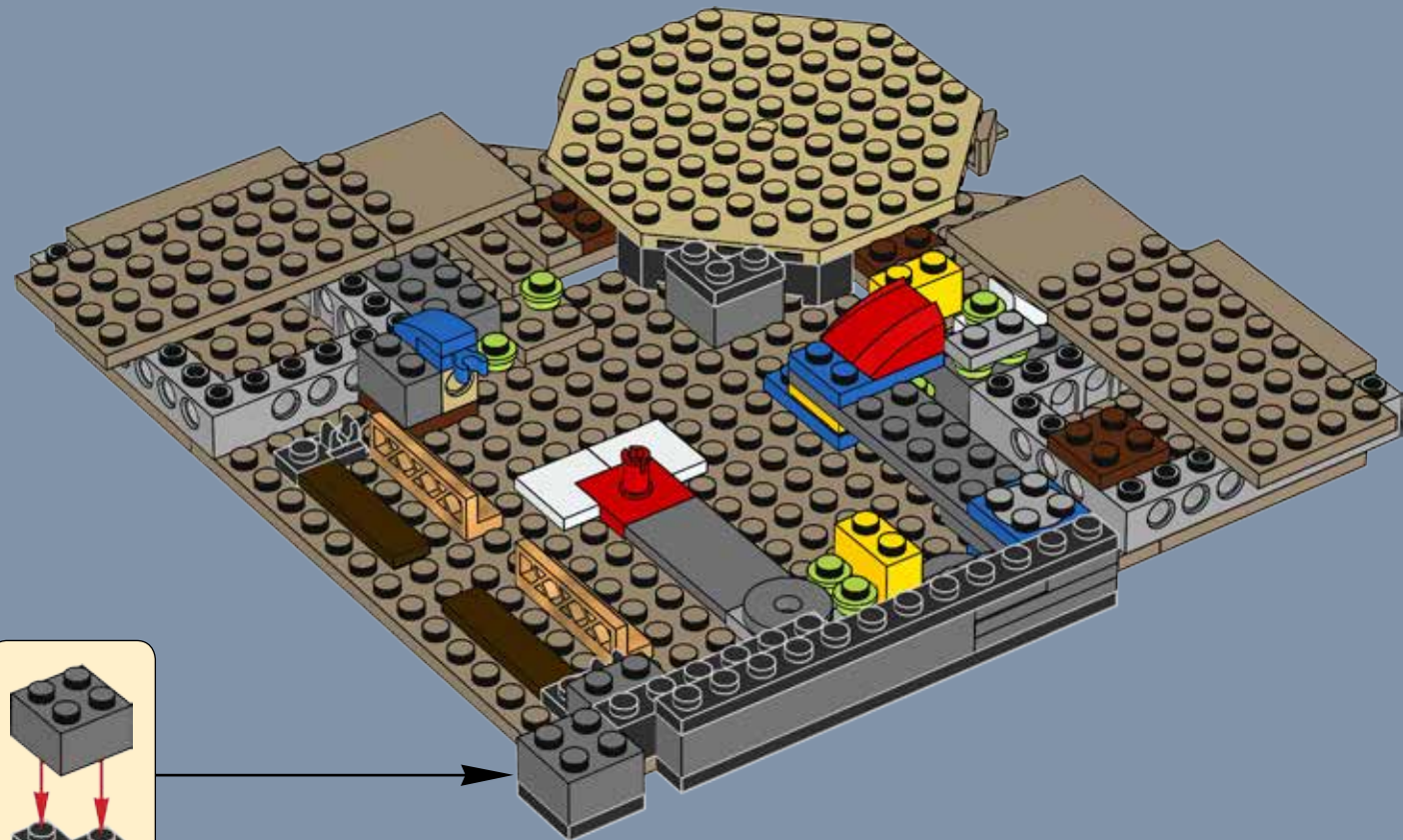

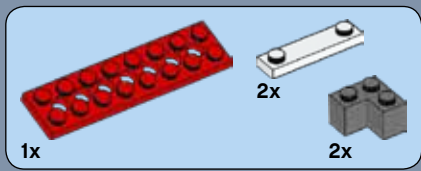

17

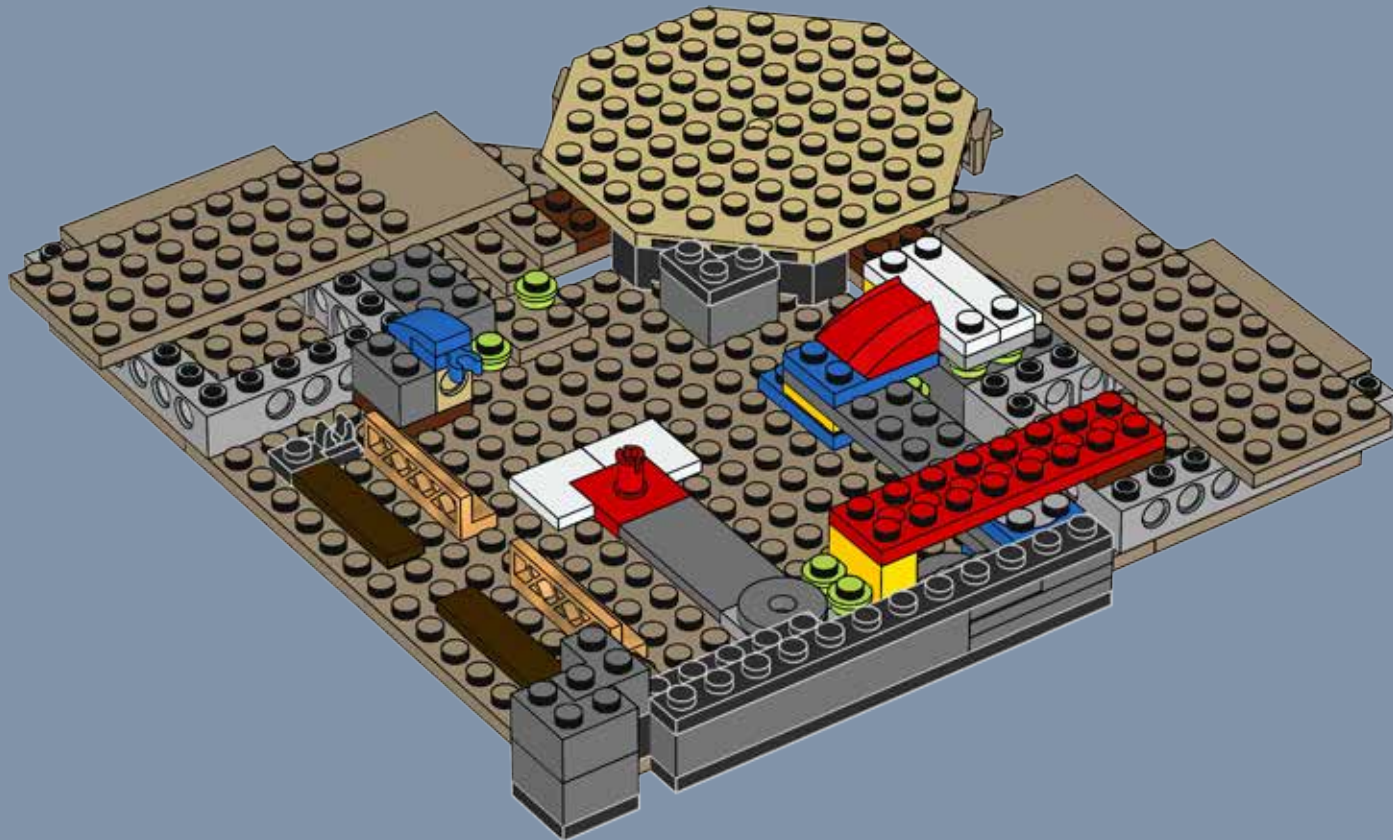



18

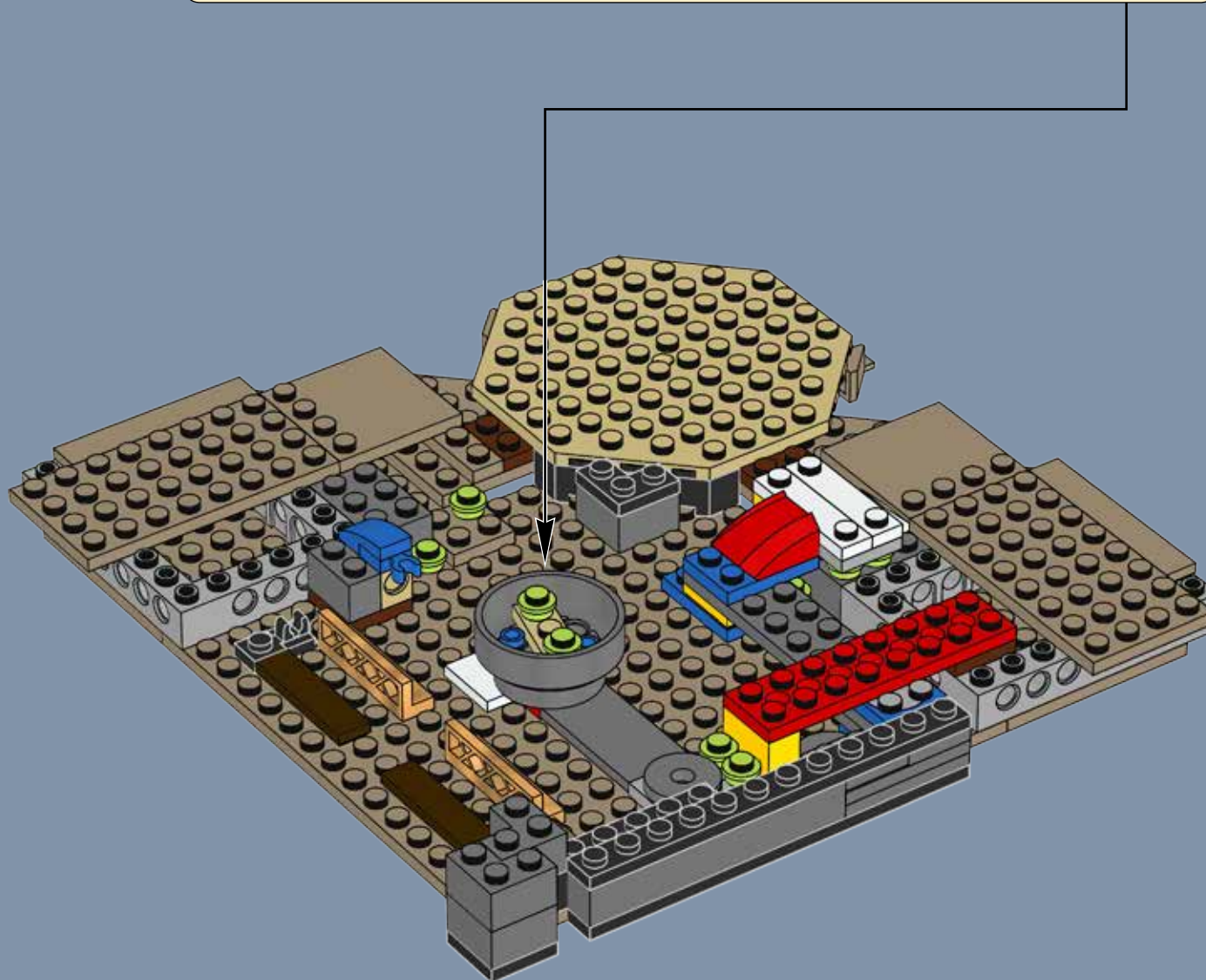
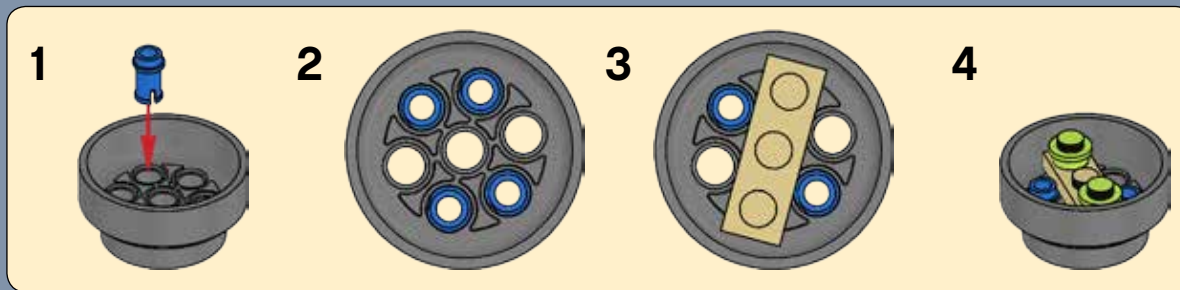

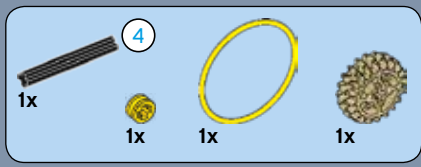

19

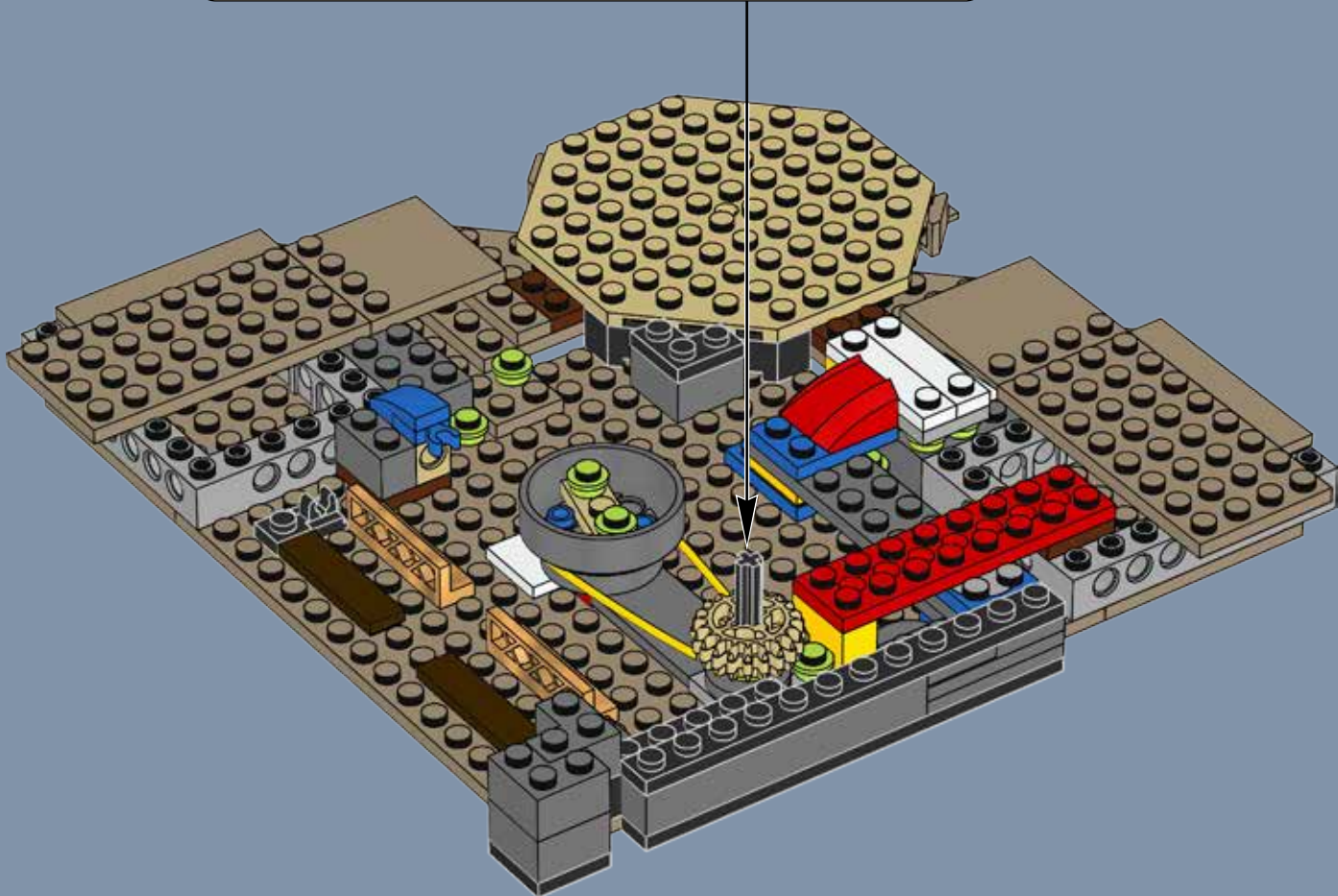
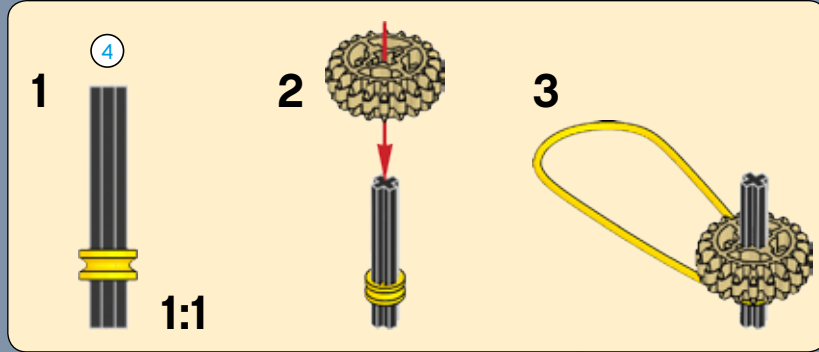

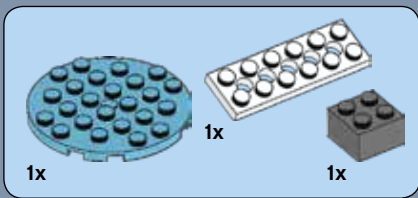

20

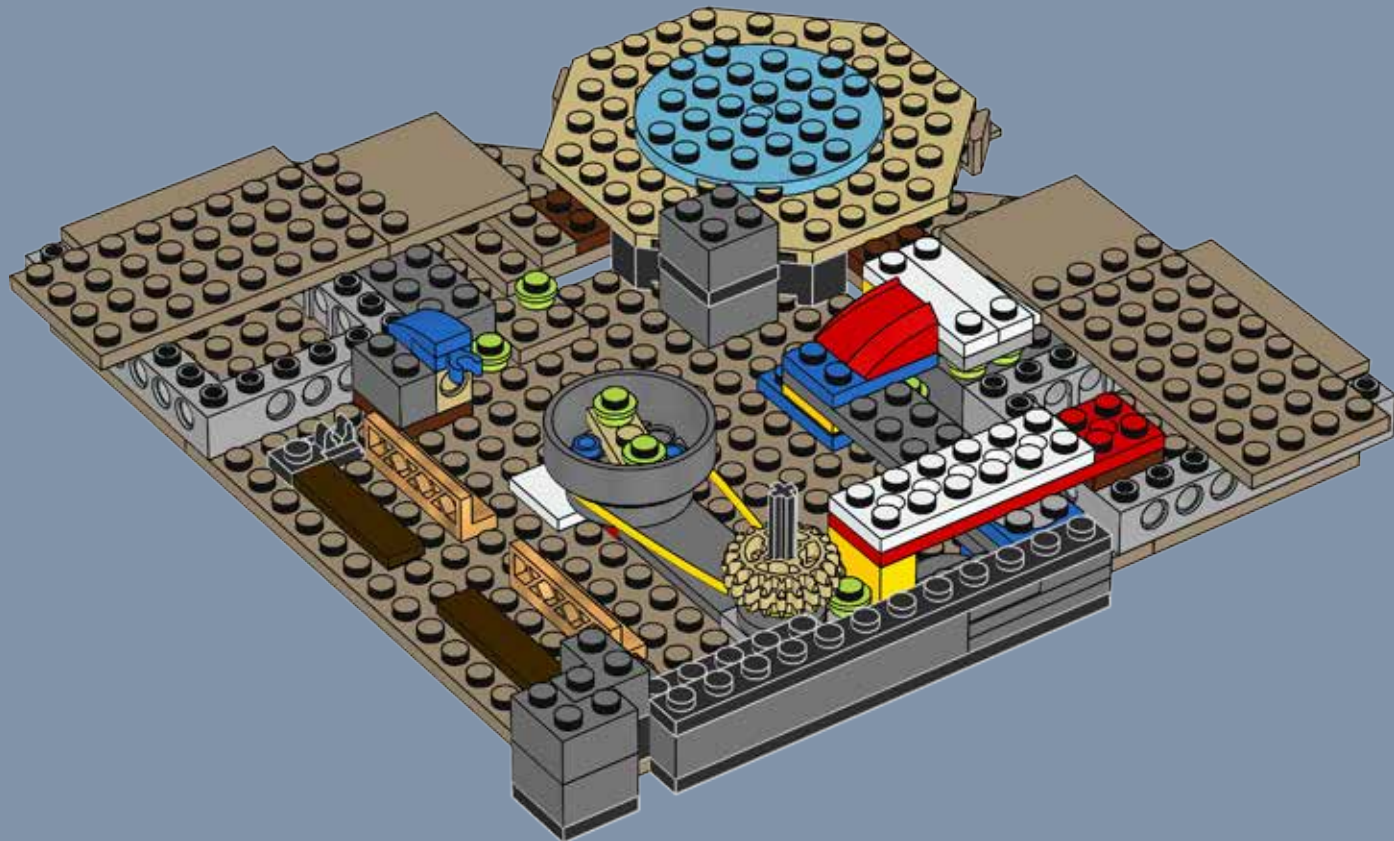

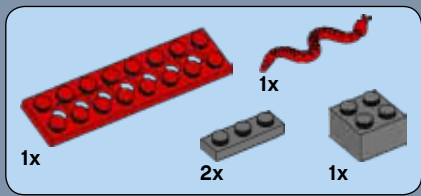

21

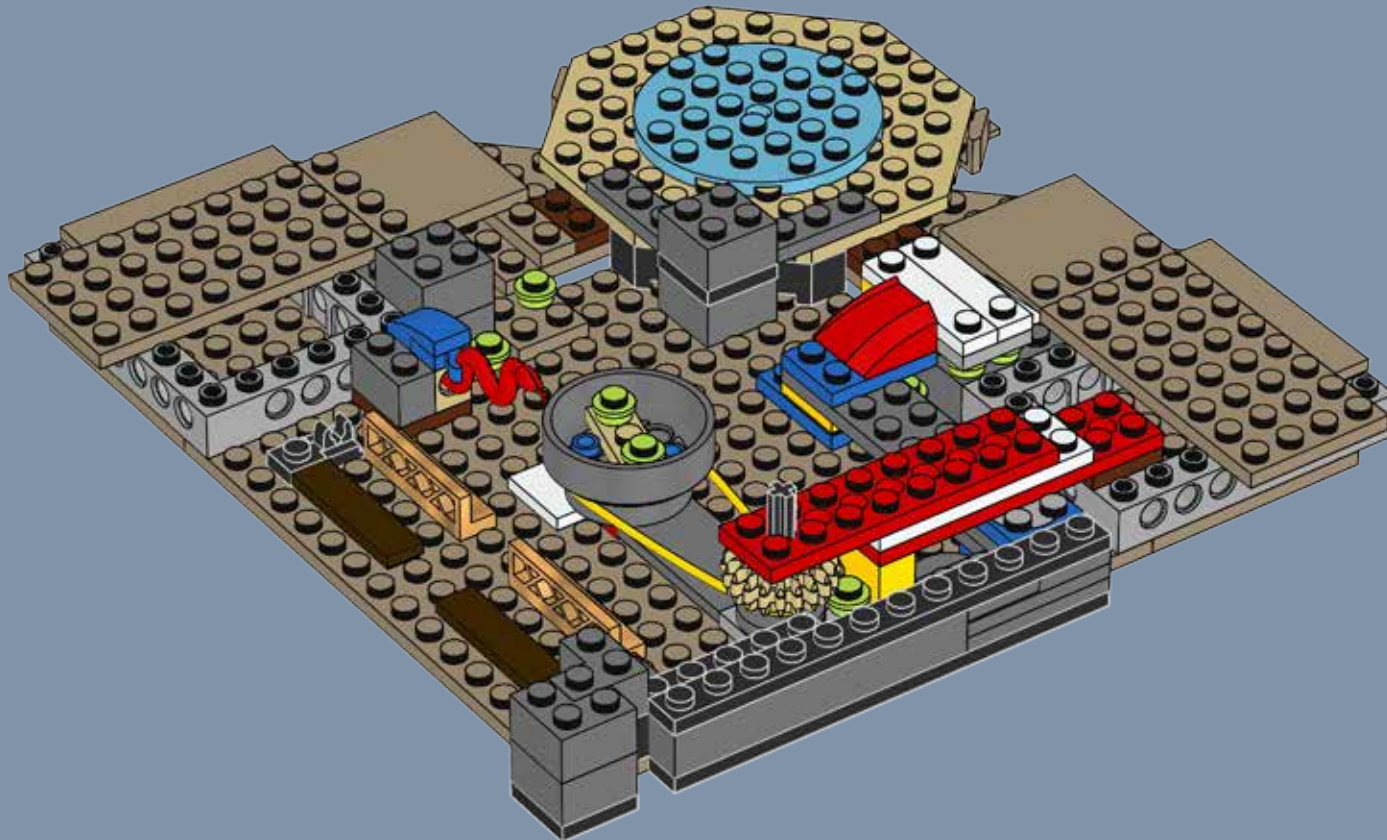



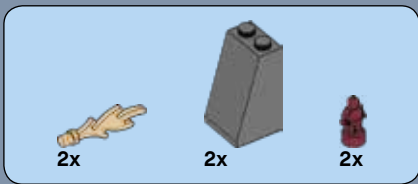

22

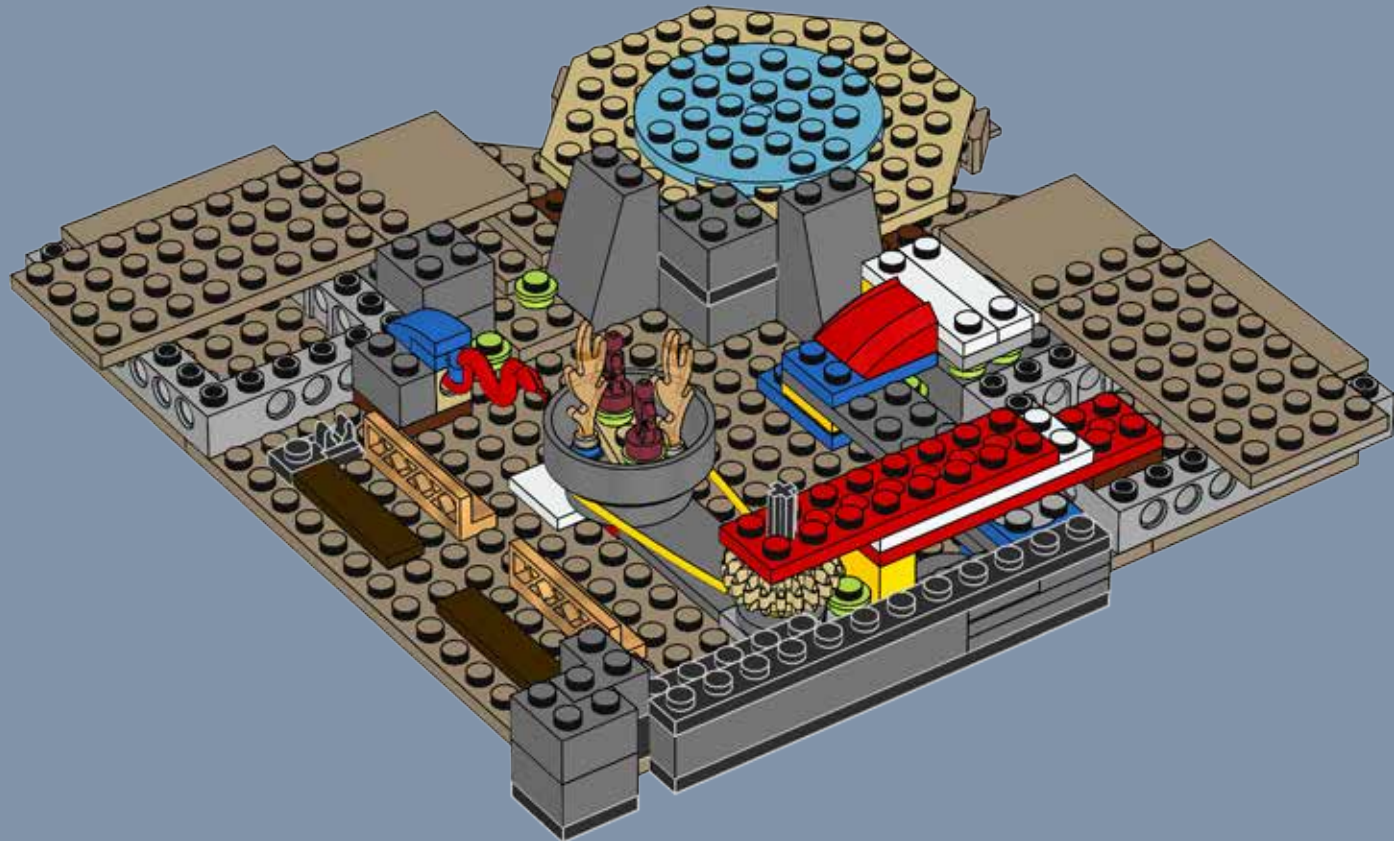

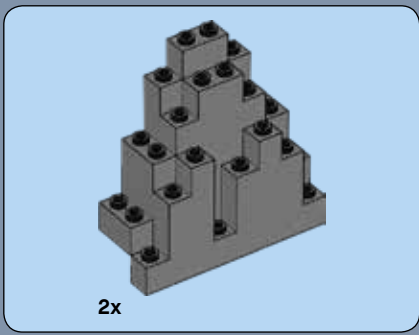

23

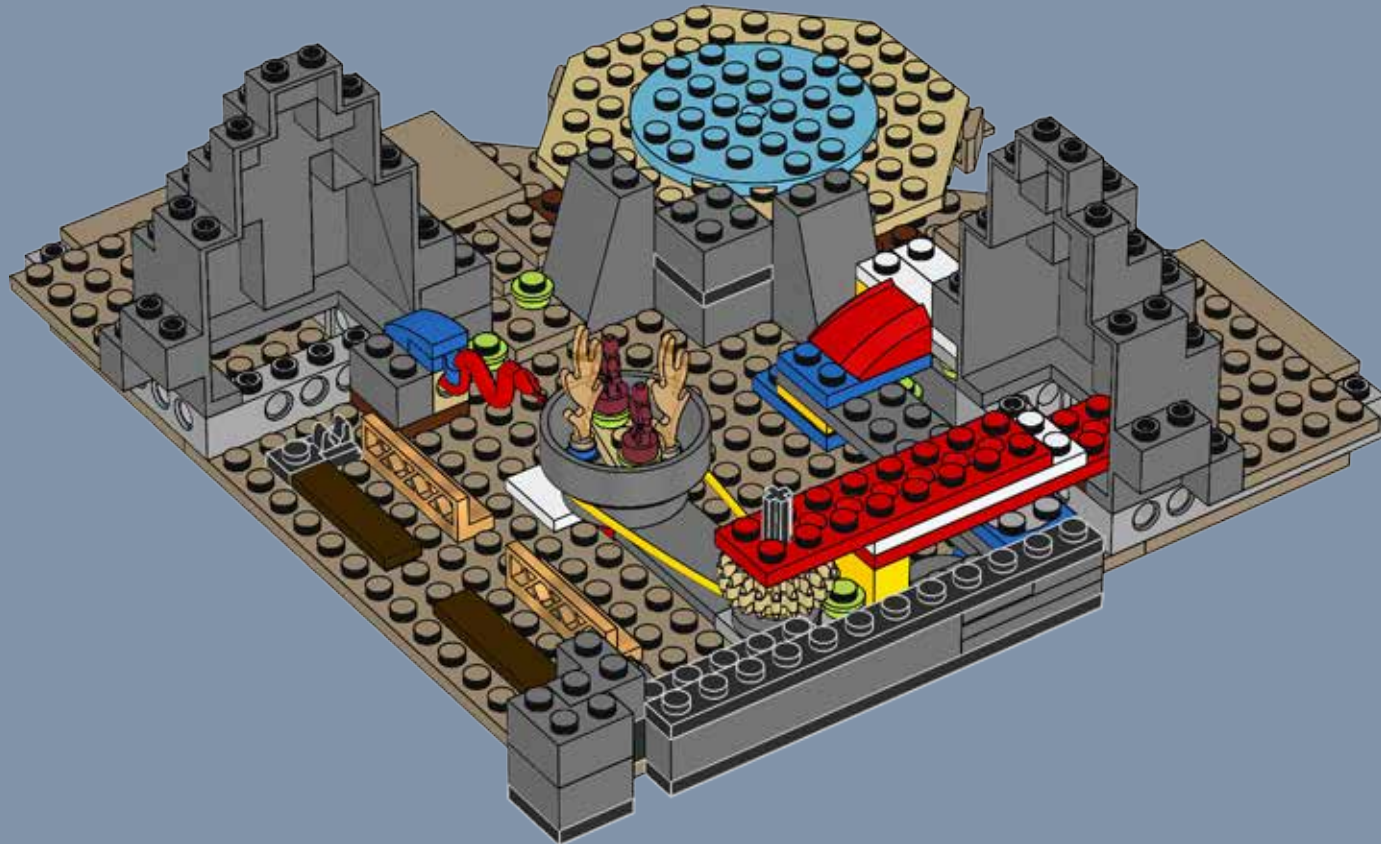

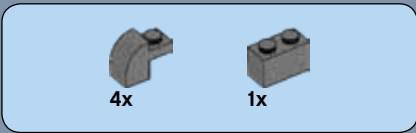

24

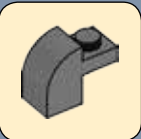



6x



2x

# 25



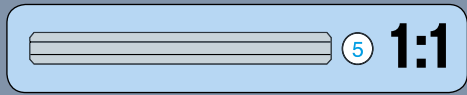
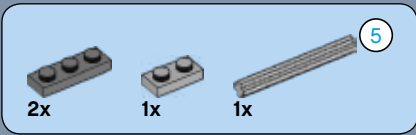

26



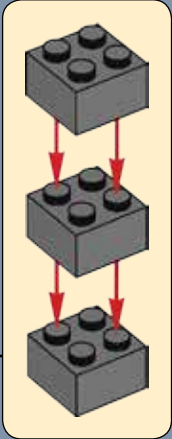
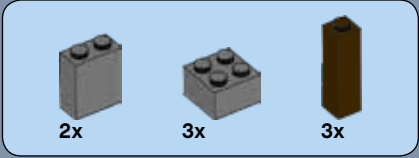
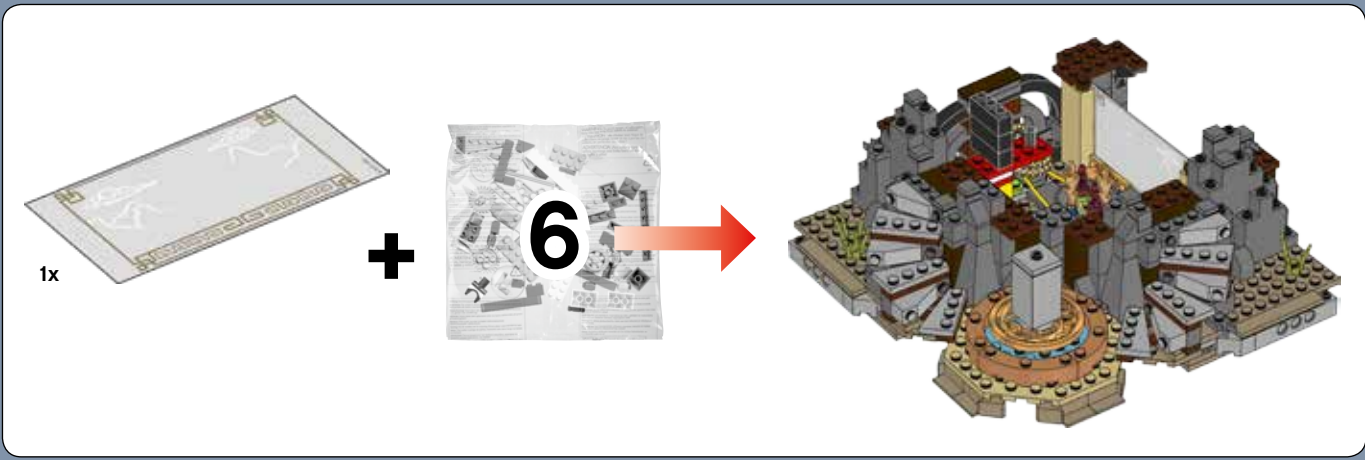

27

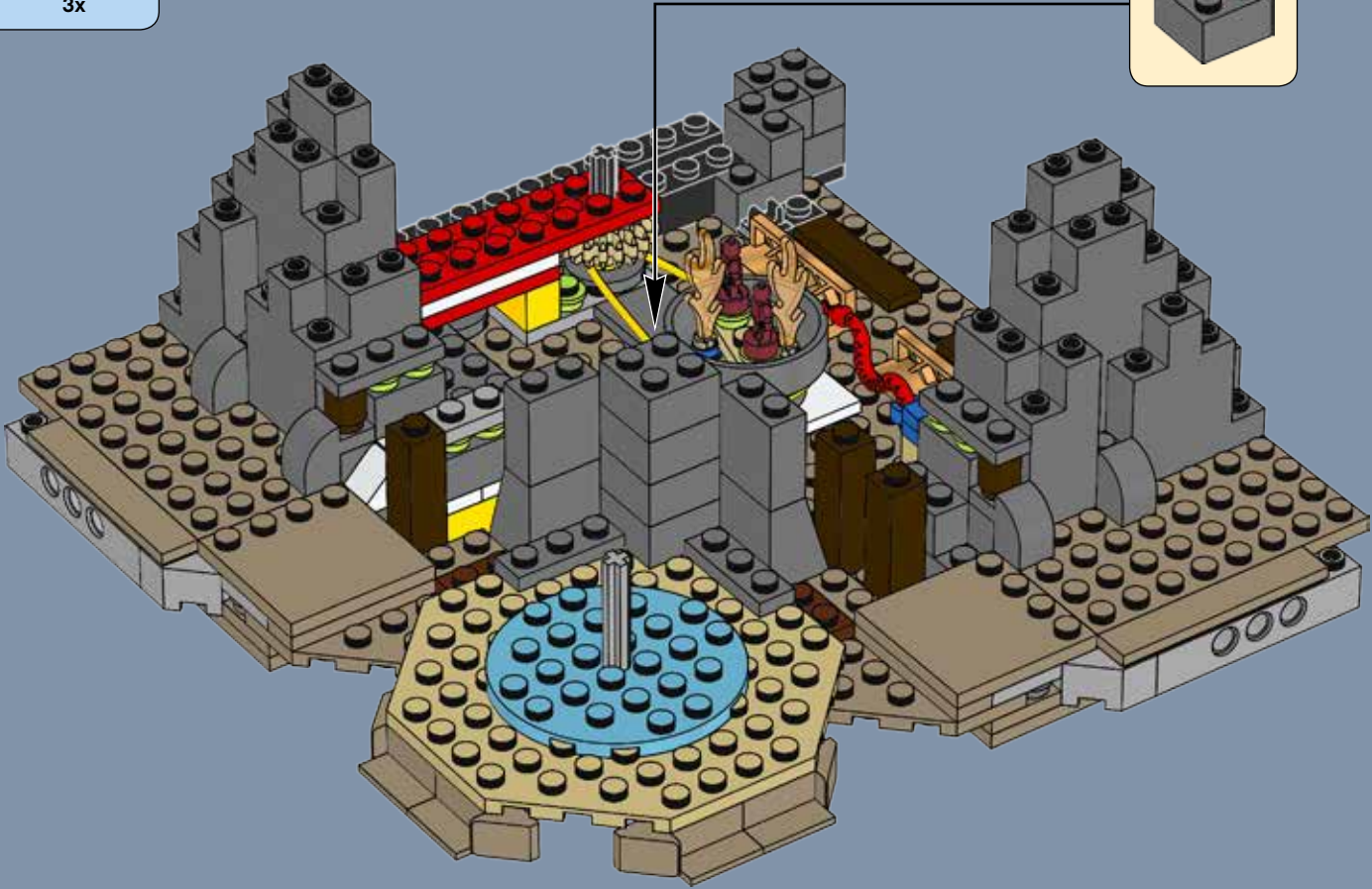



28

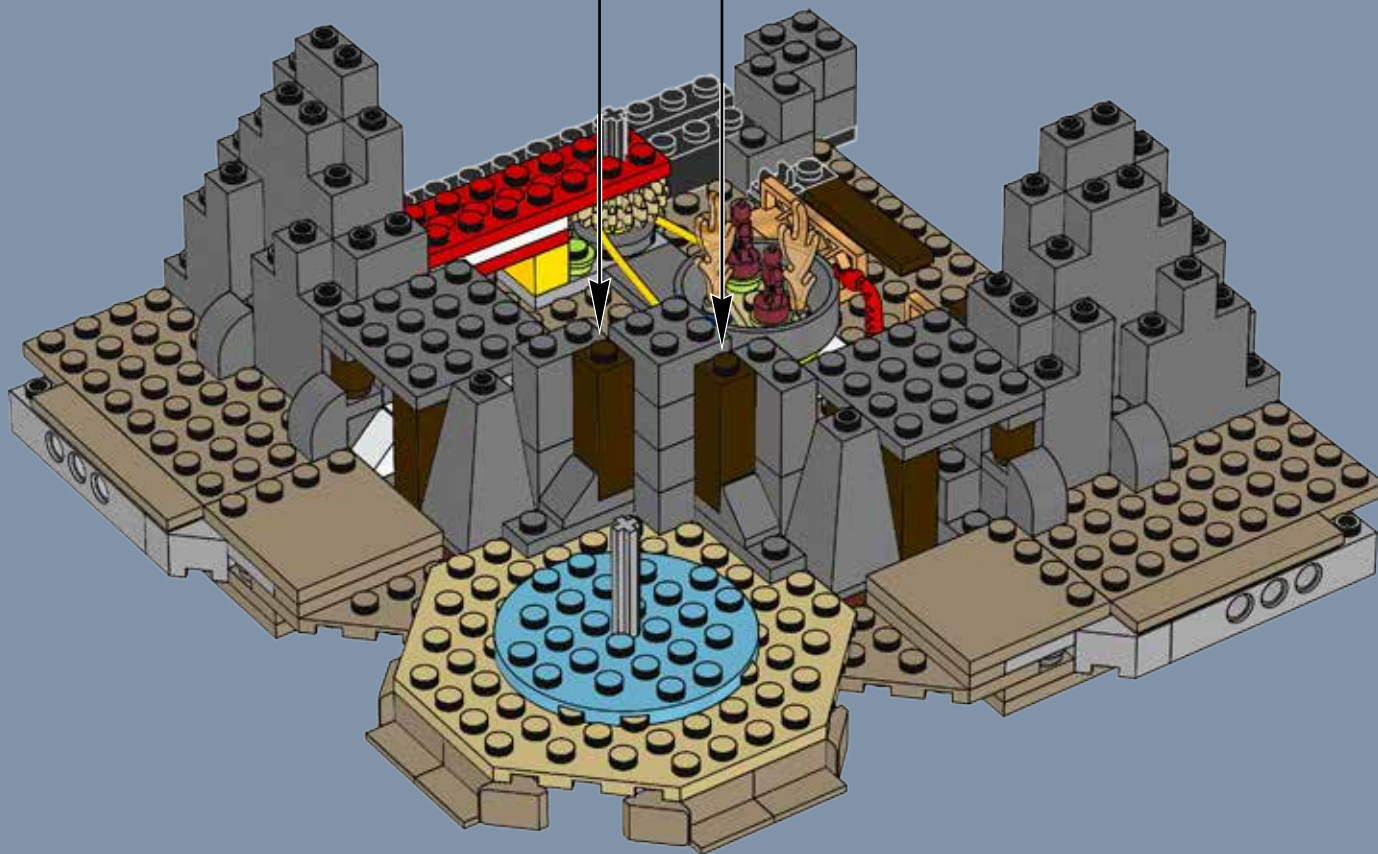
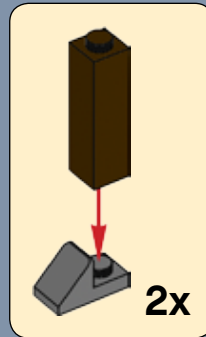

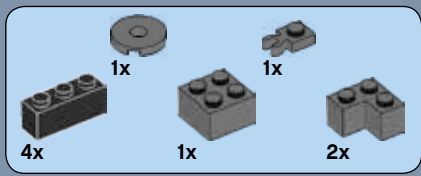

29

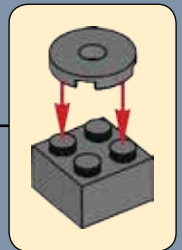
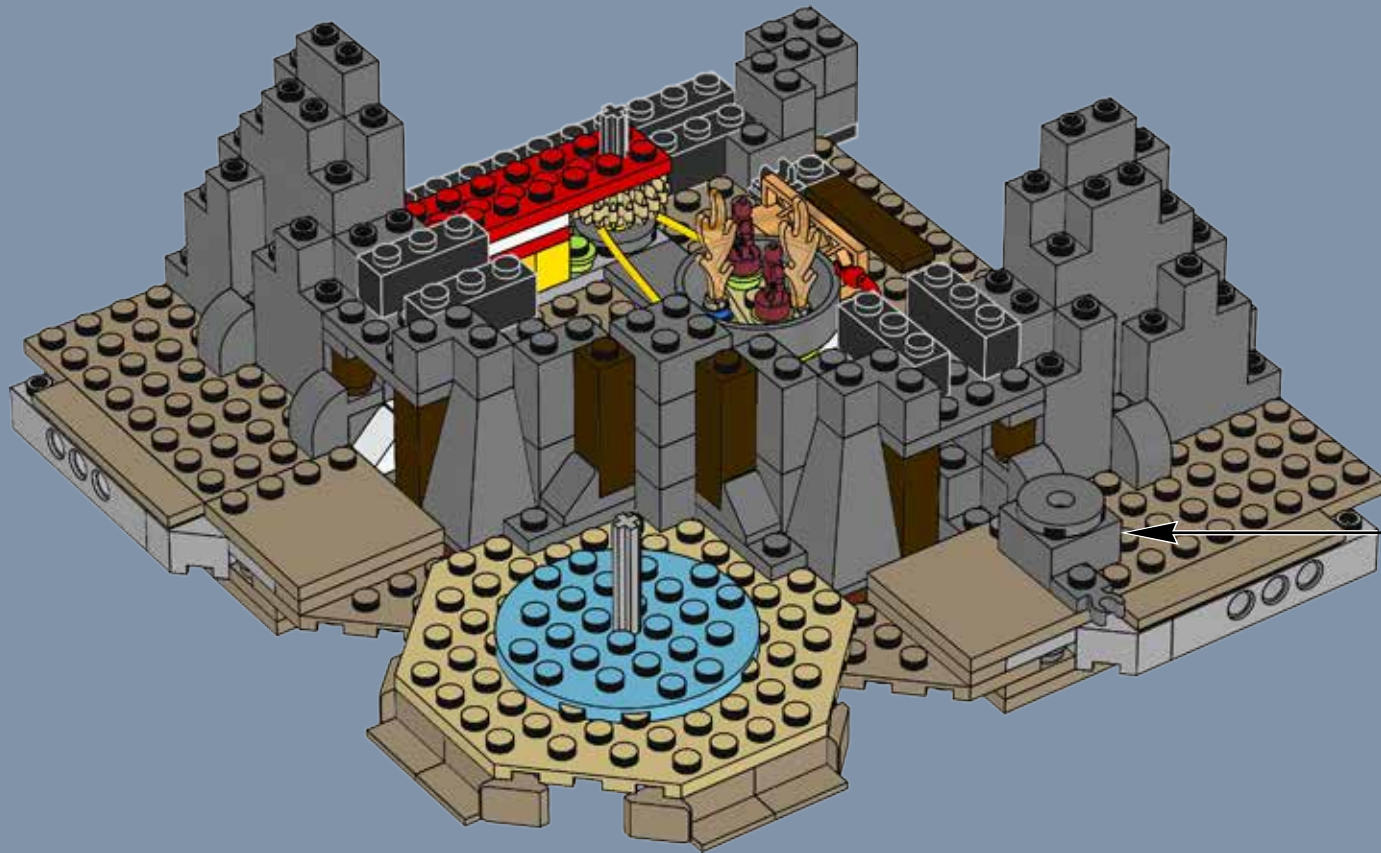



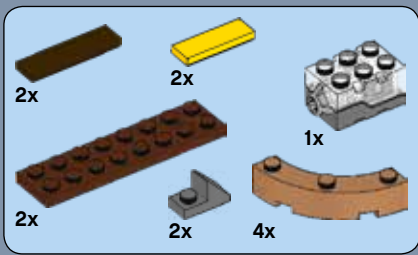

# 30

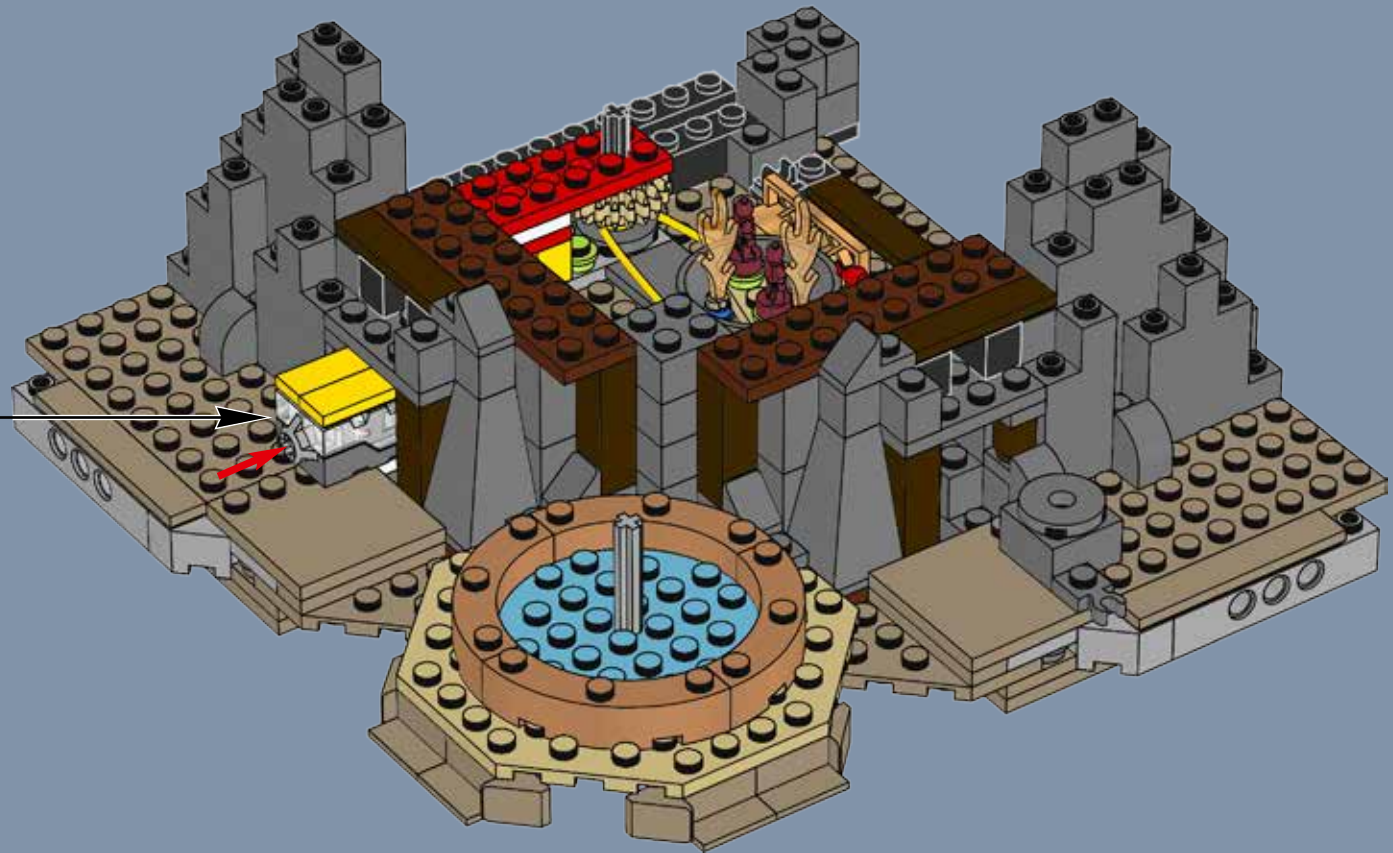

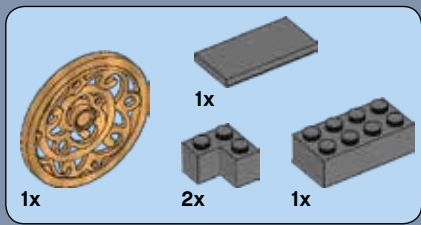

31

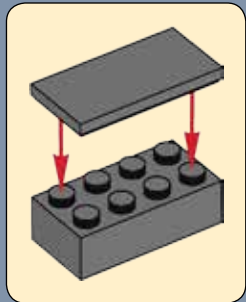

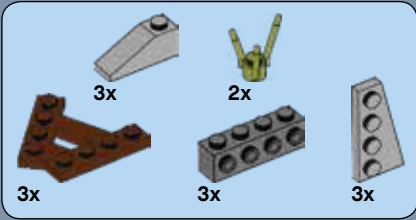

# 32

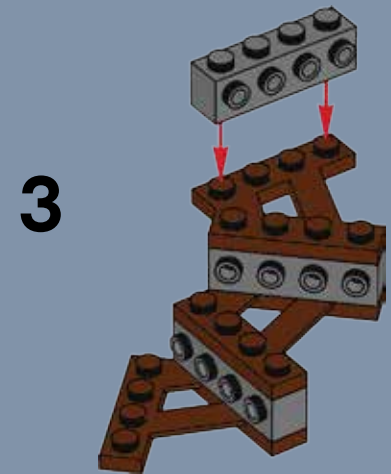
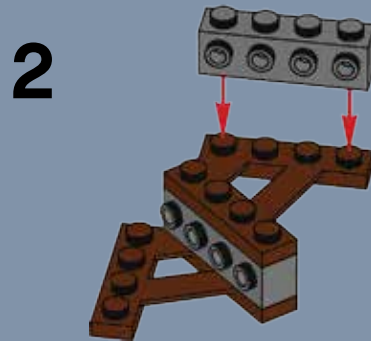
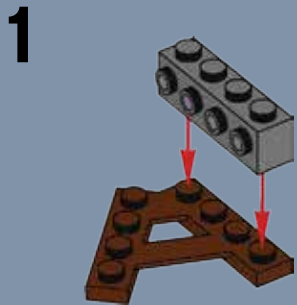

4

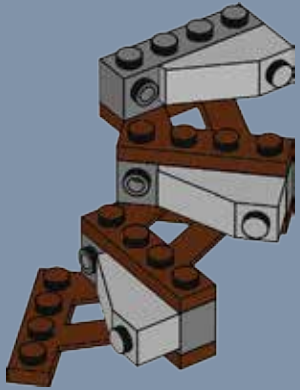

5

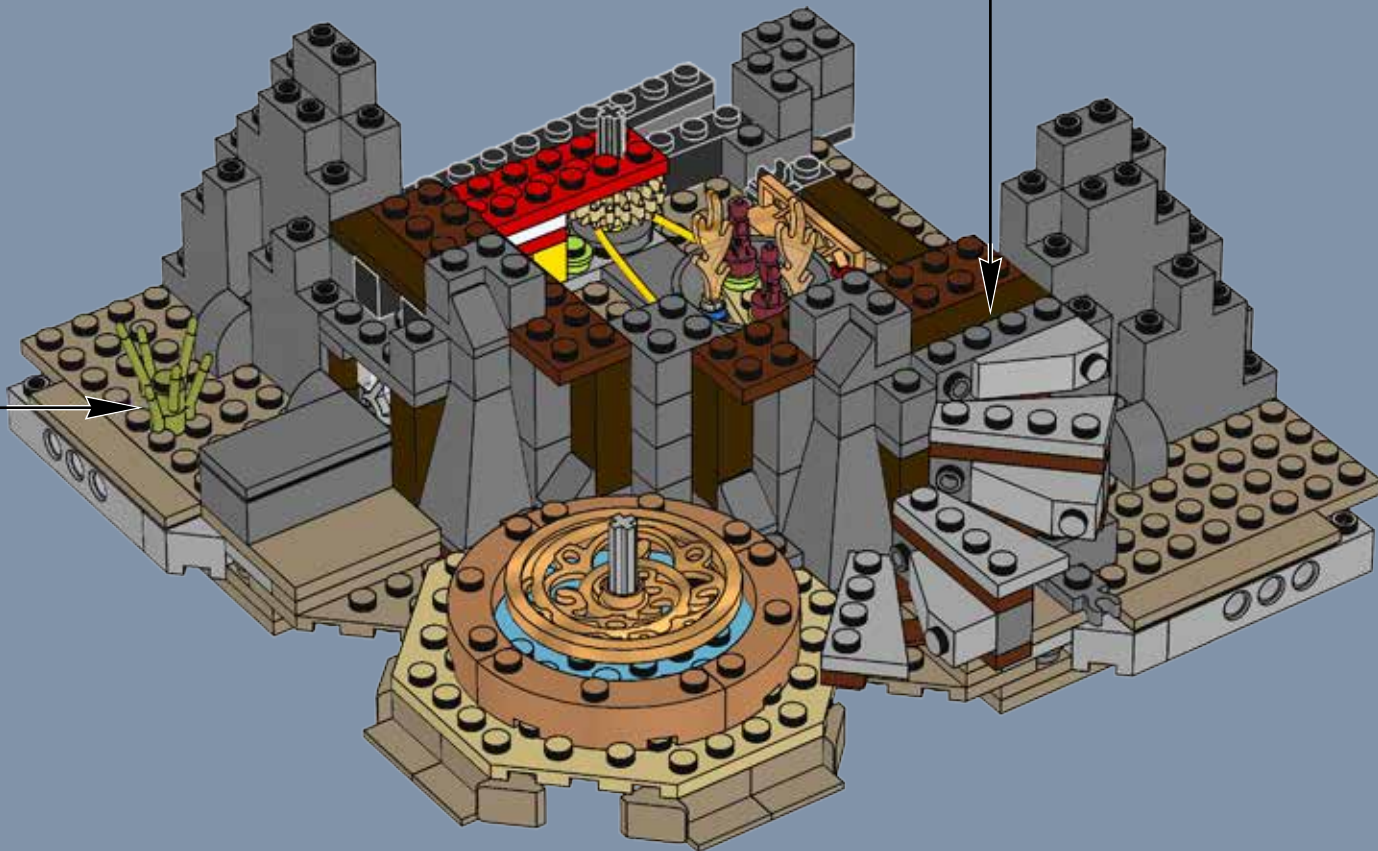
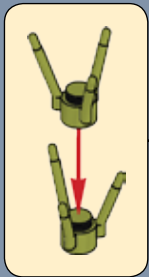
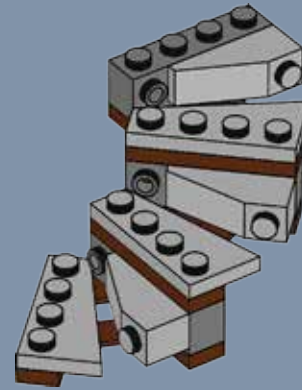

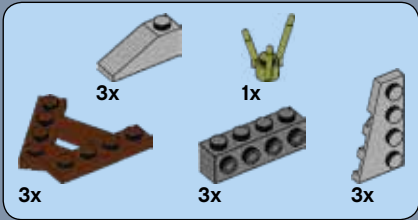

33

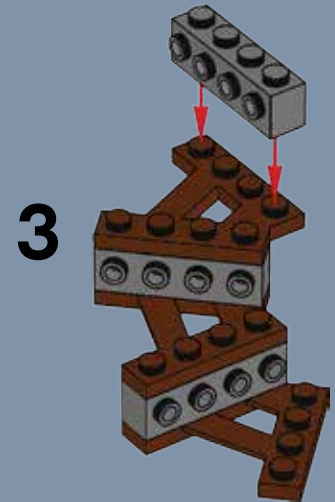
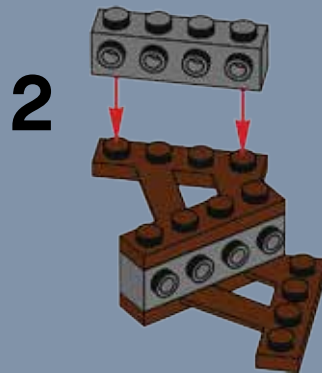
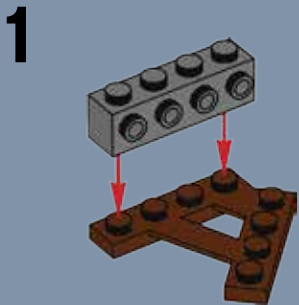

4

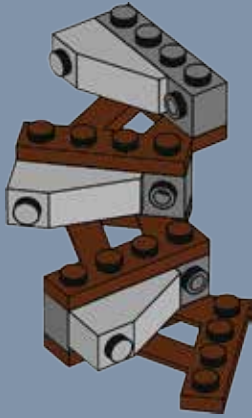

5

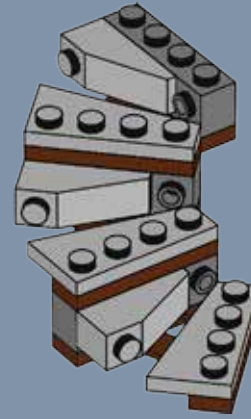

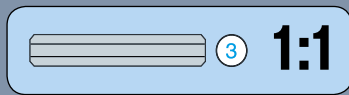
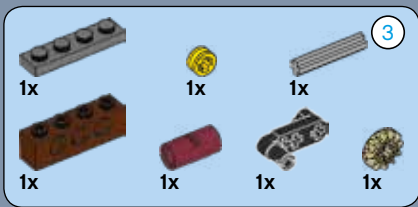

# 34

1

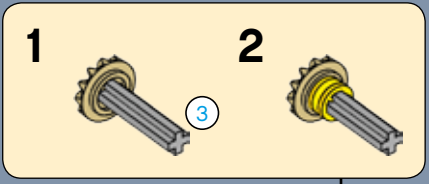
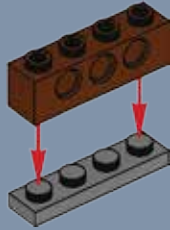

2

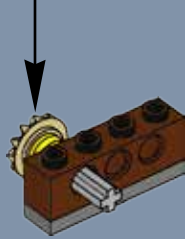

3



4



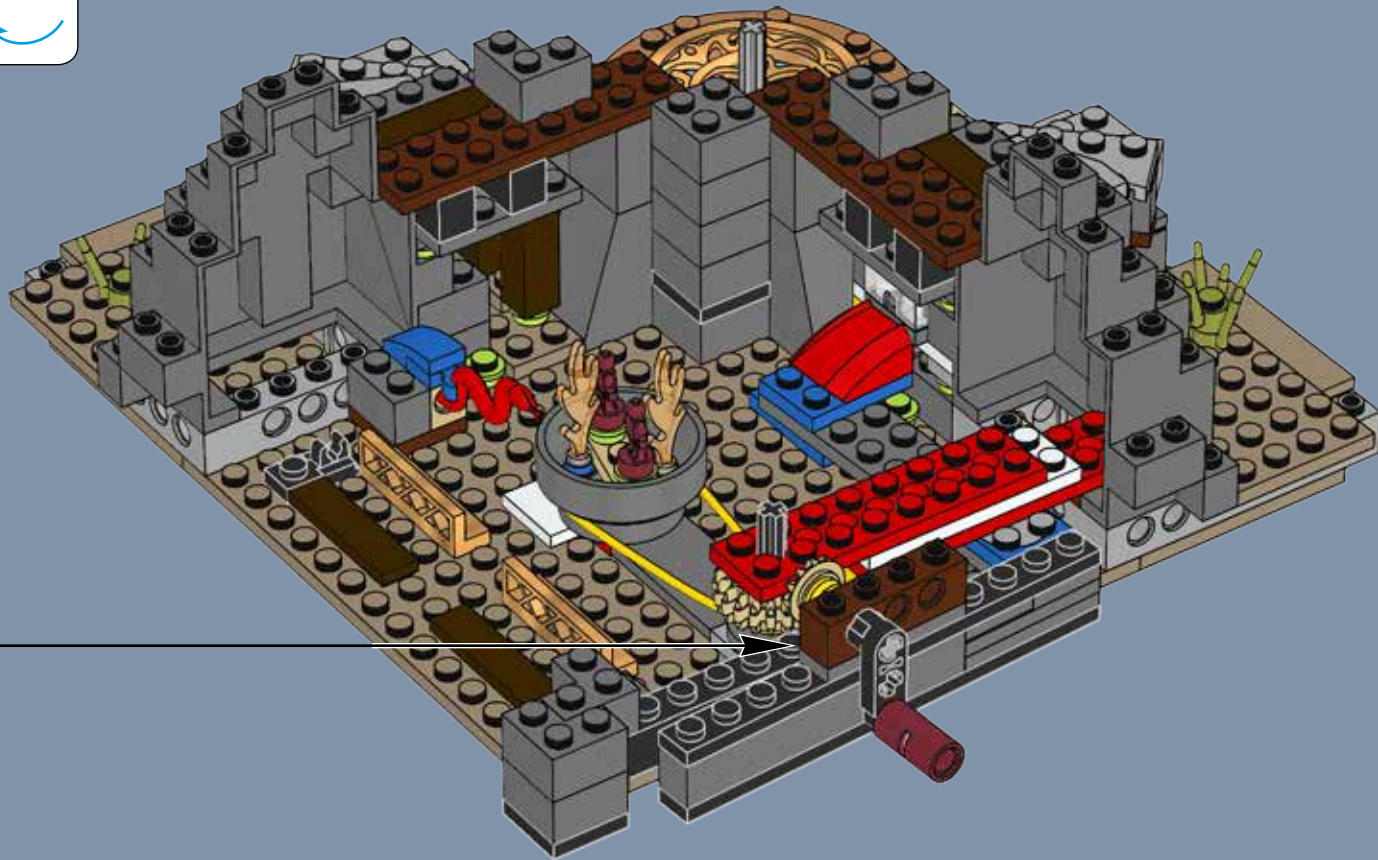



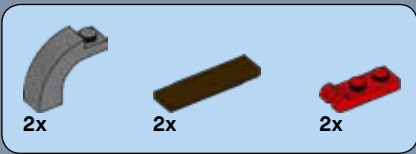

# 35

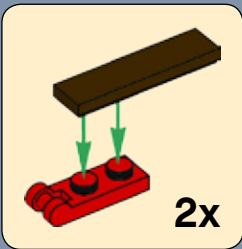
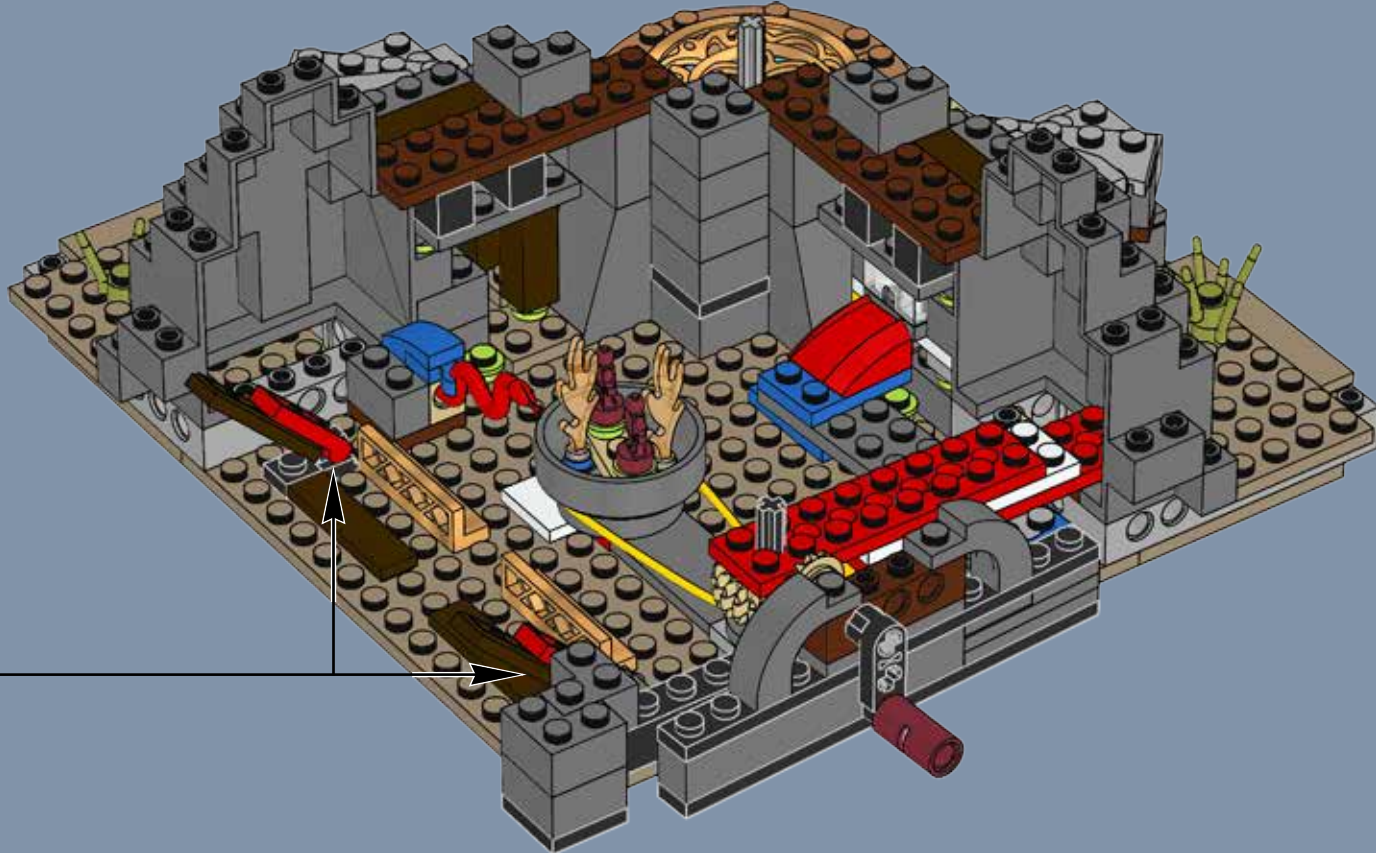

36

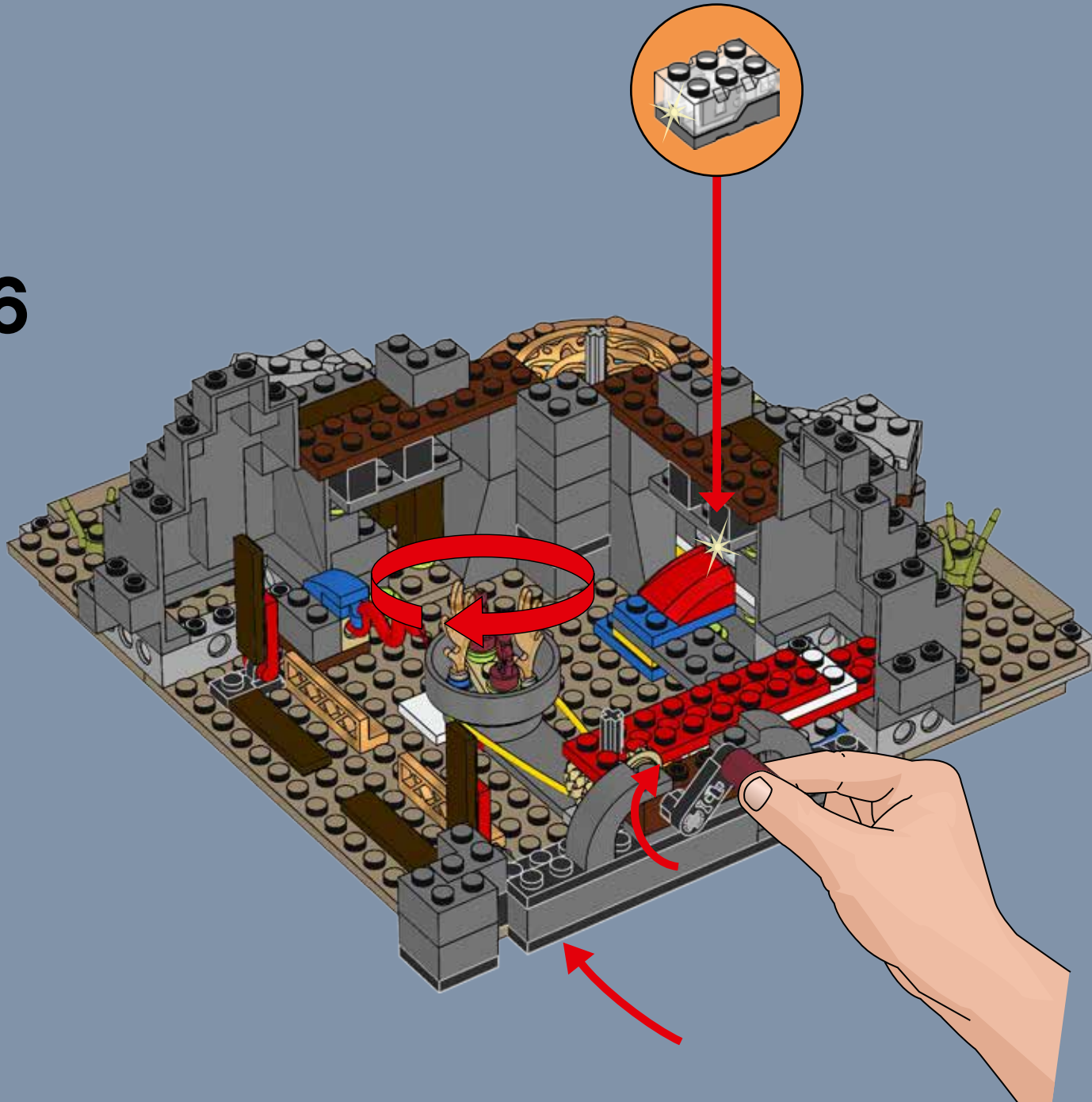

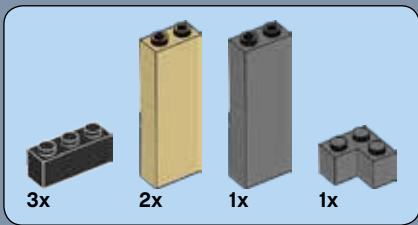

37

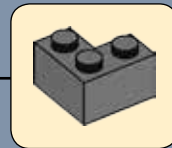
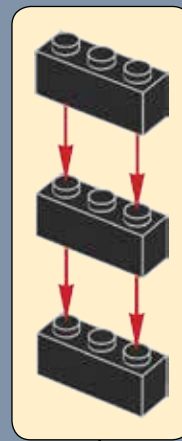

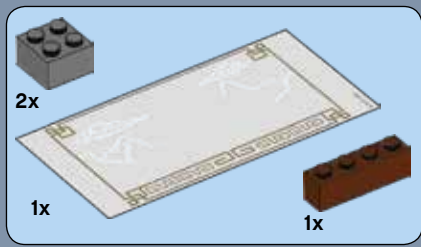

38



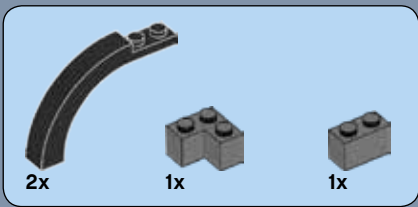

39

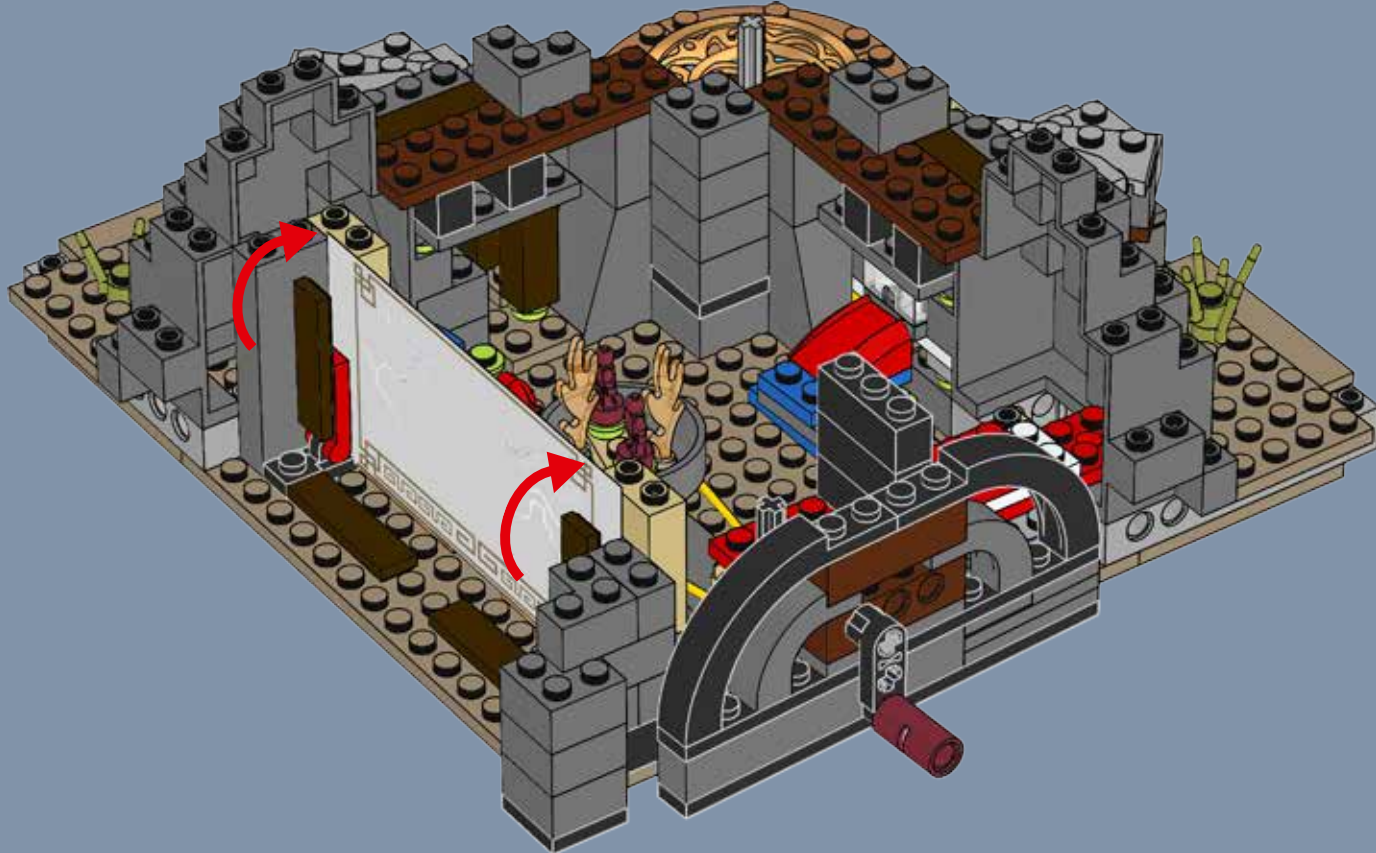

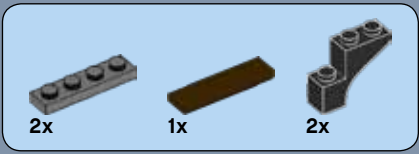

40

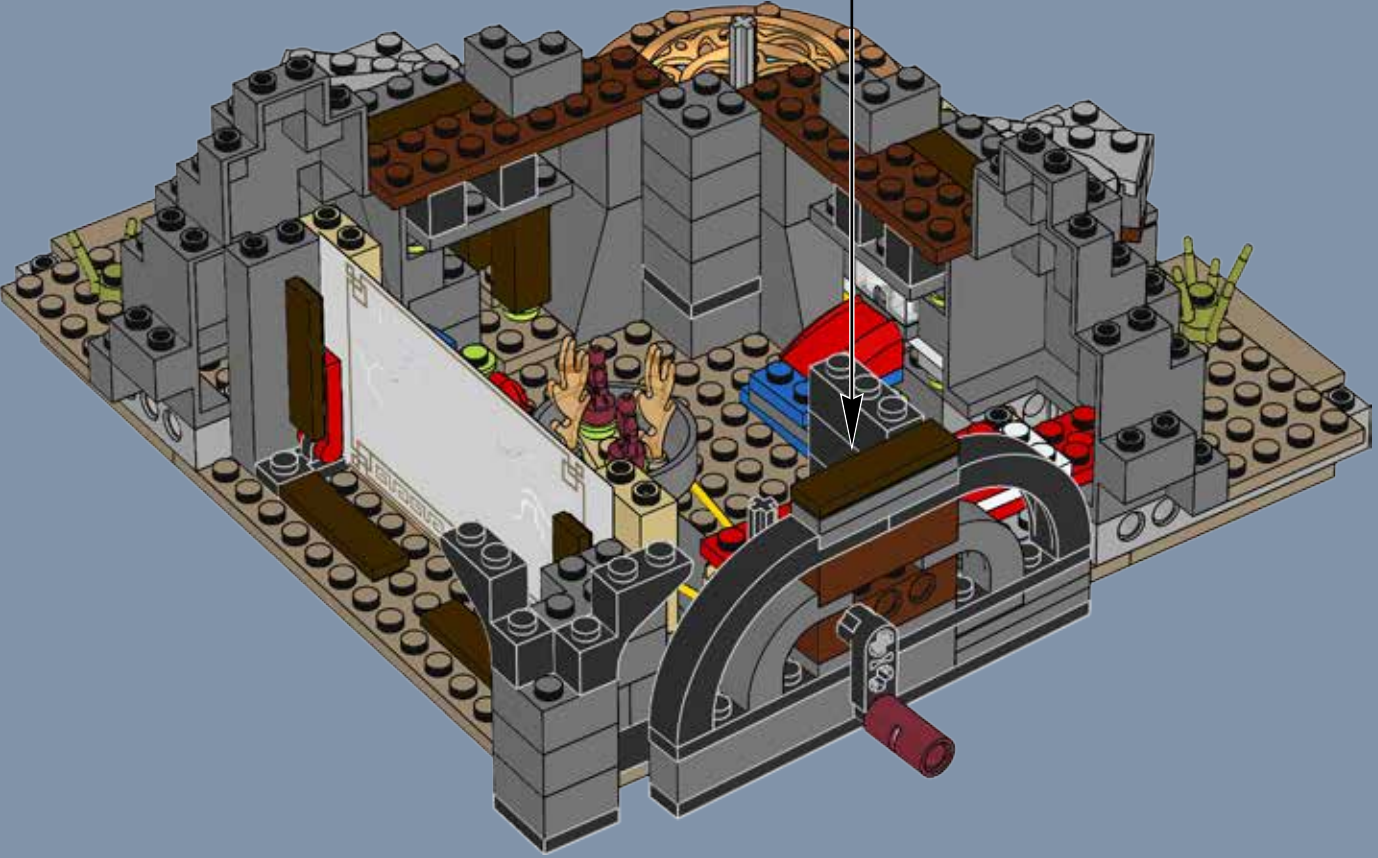
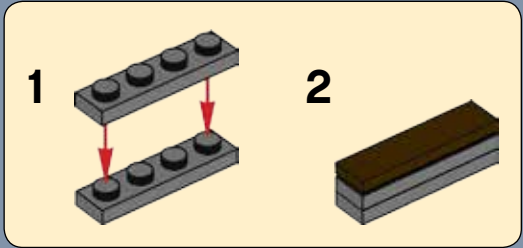



41

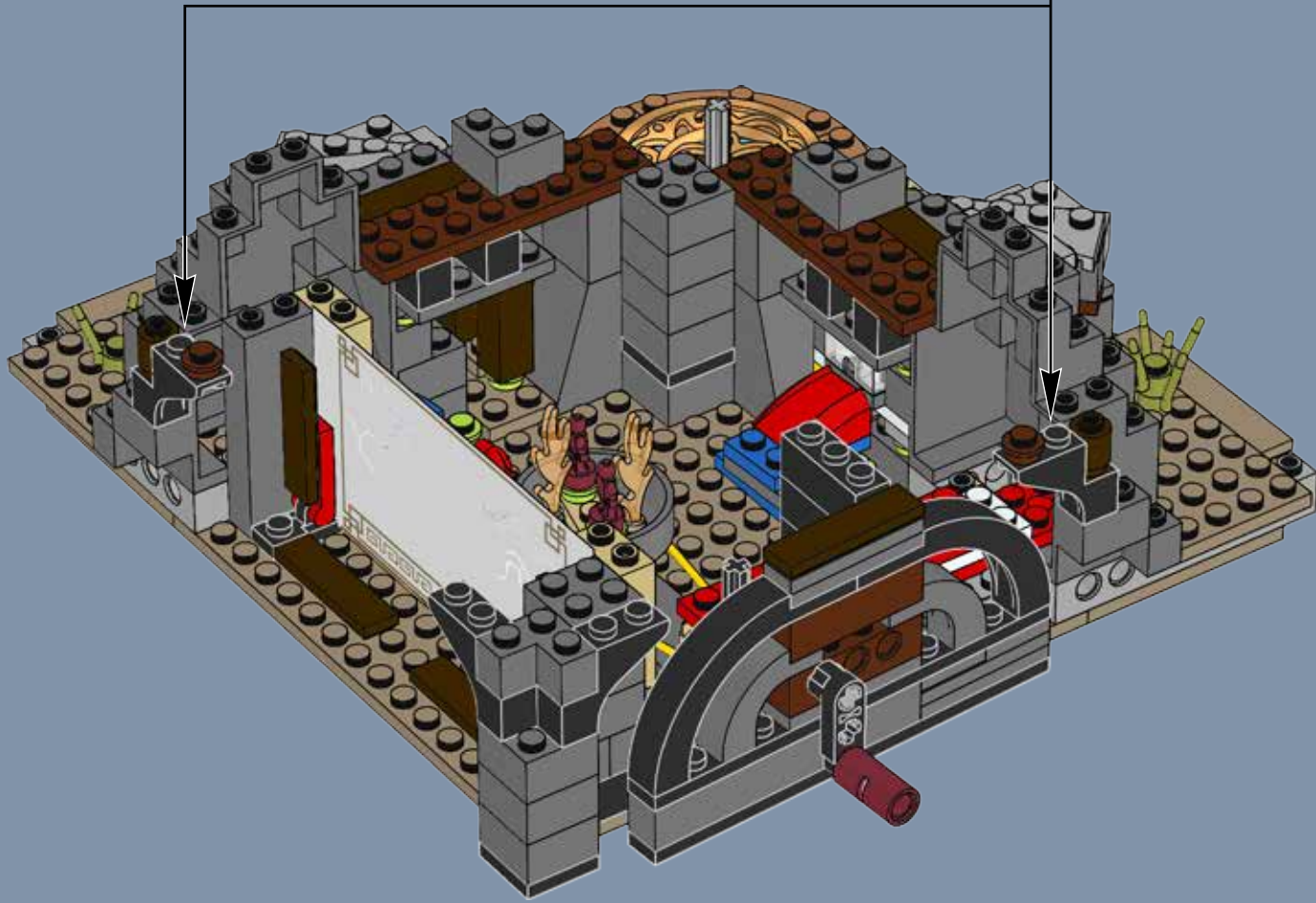
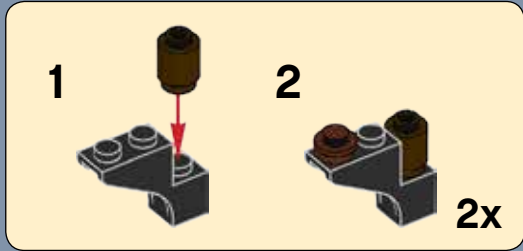



# 42





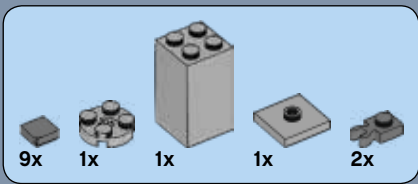

43

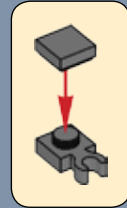
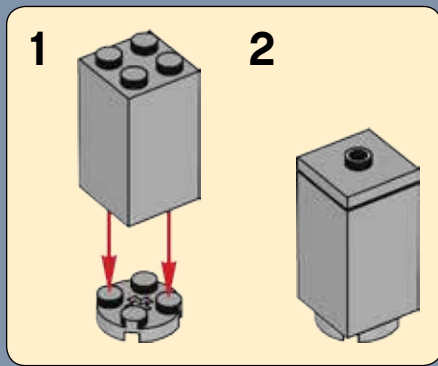

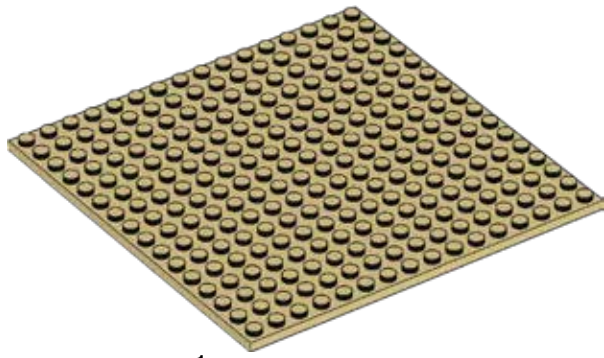

1x

+



7



**2**



**3**



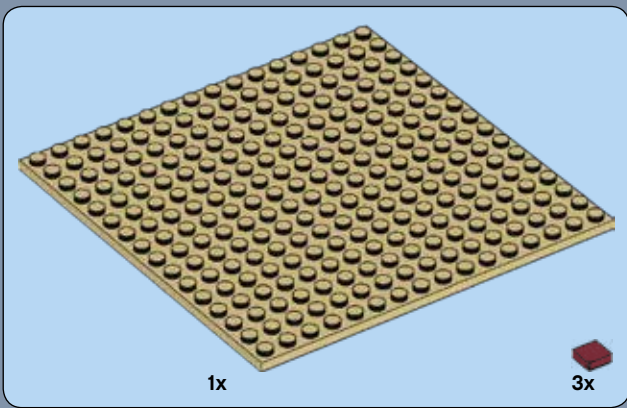

1

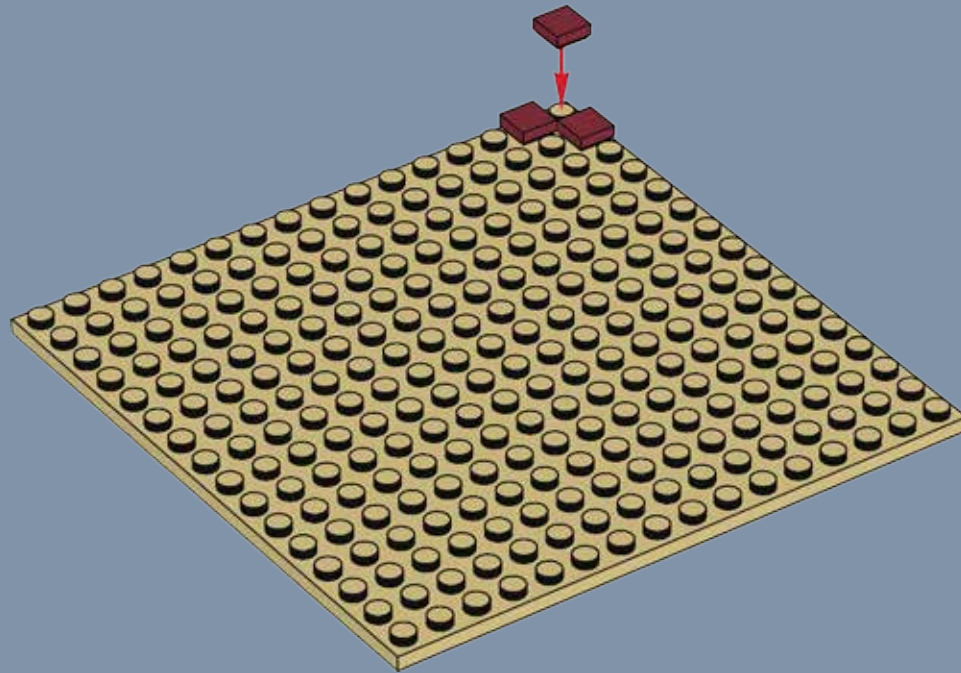

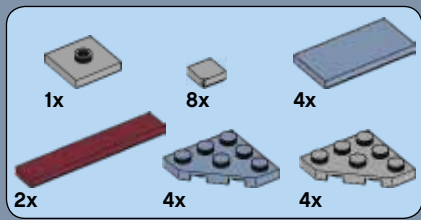

2

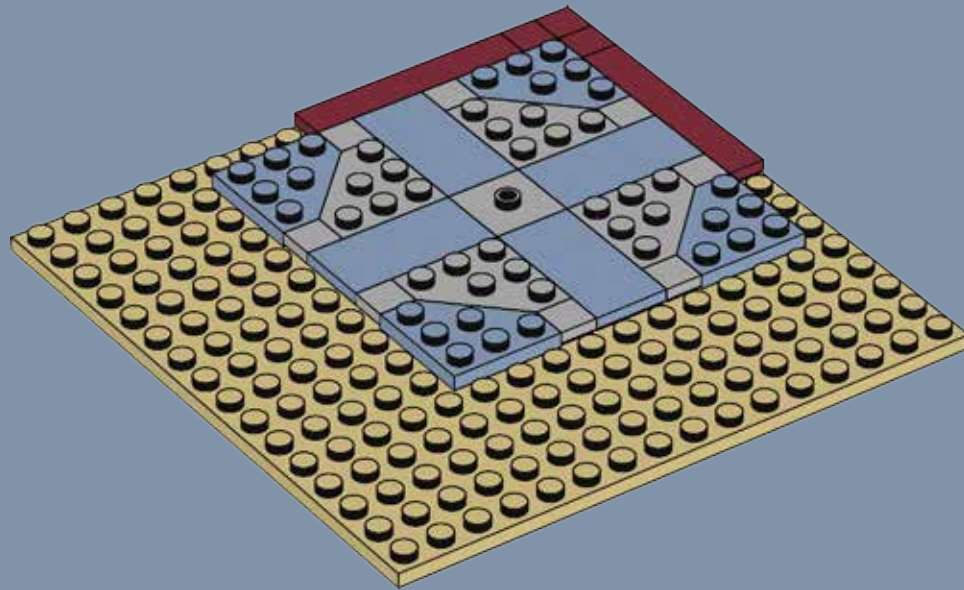



3

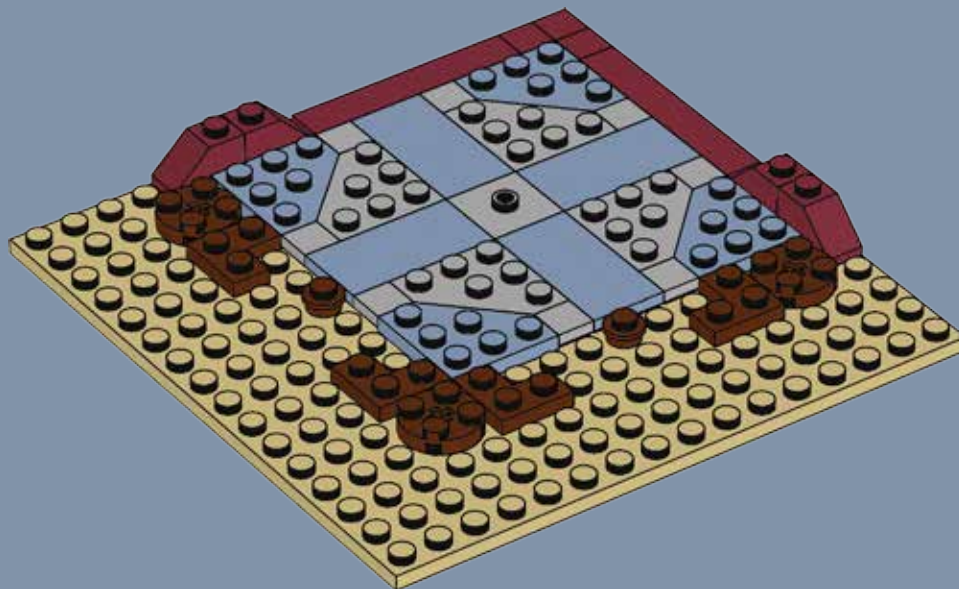



4

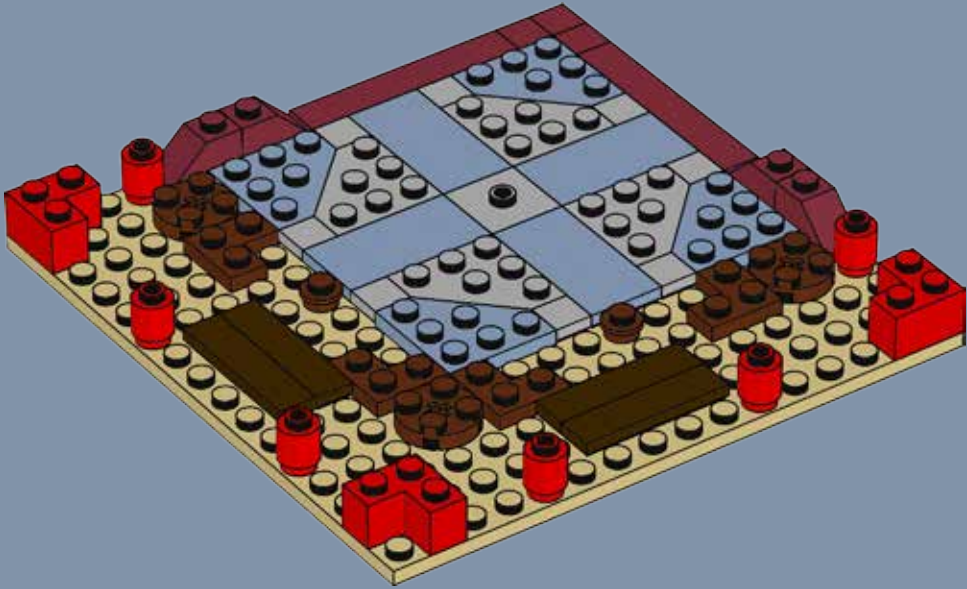

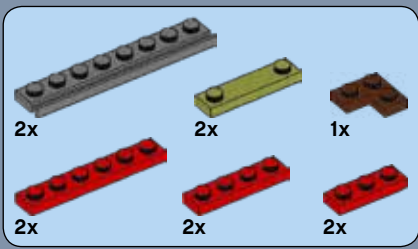

5





# 6

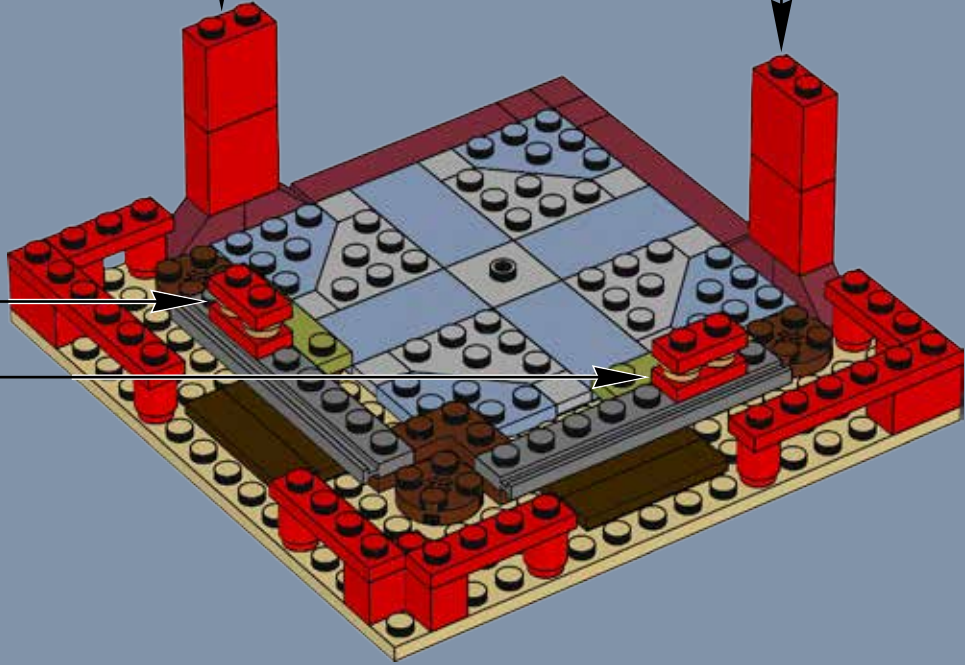
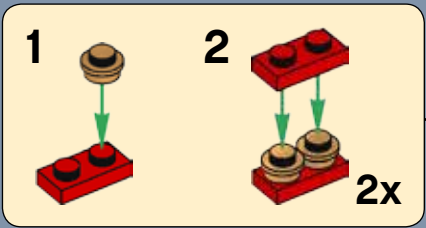
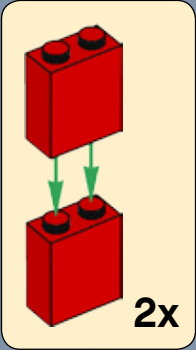



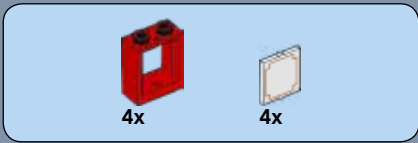

7

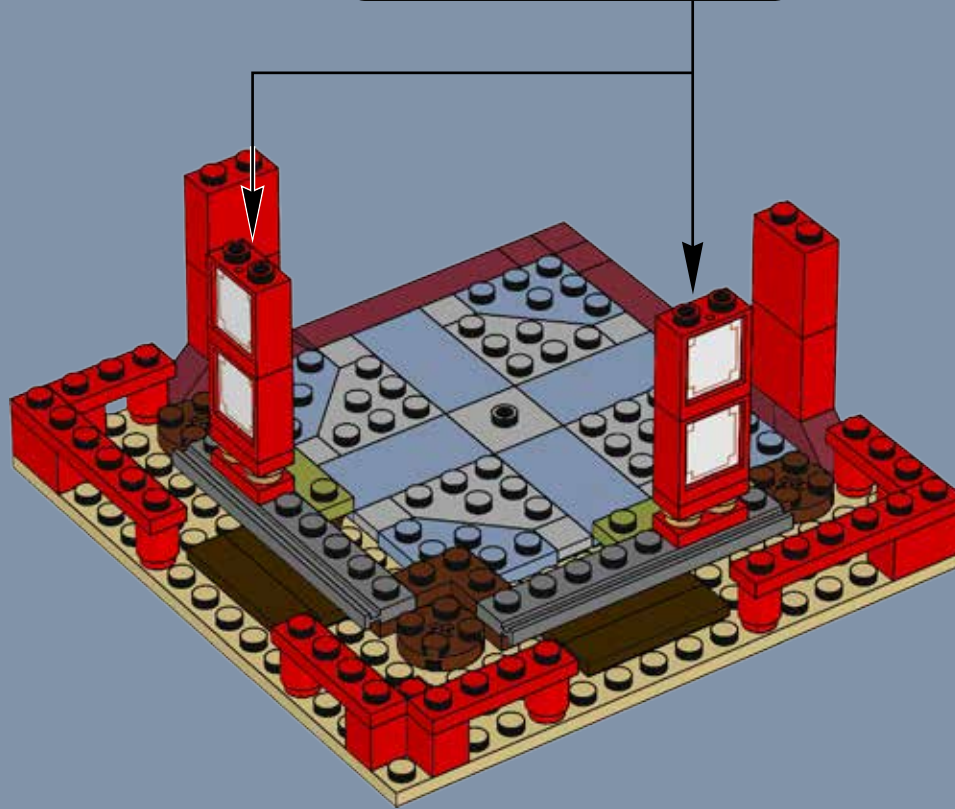
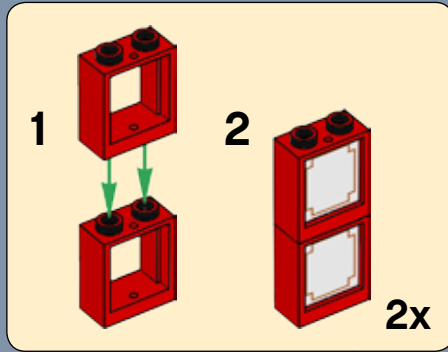



24x

8

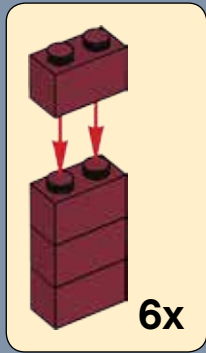

6x

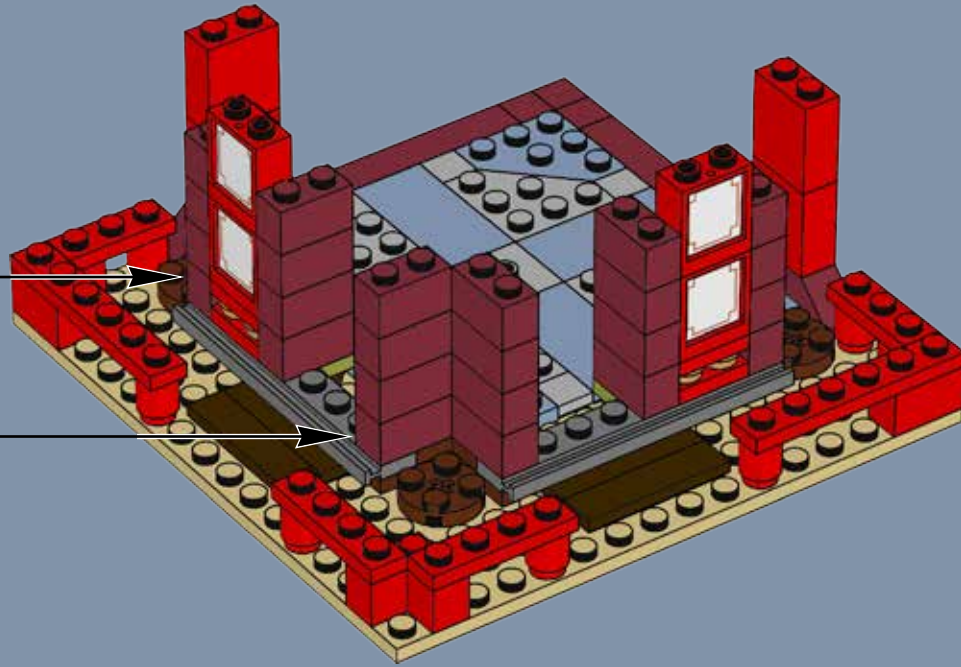



4x



2x

9

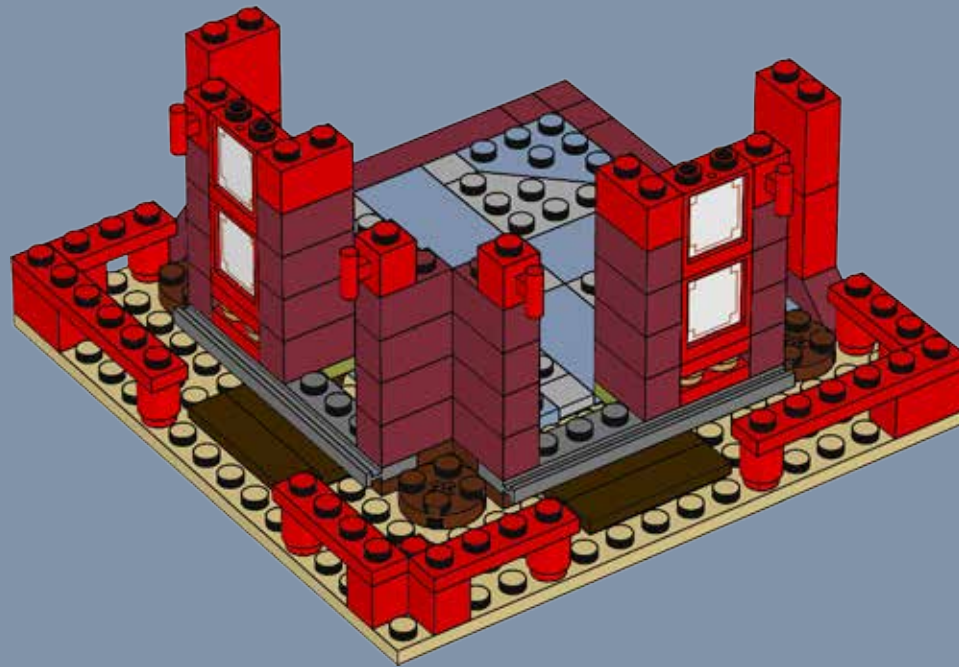

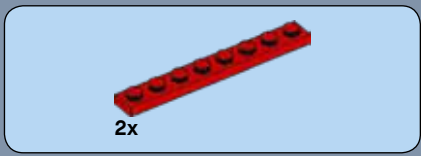

10

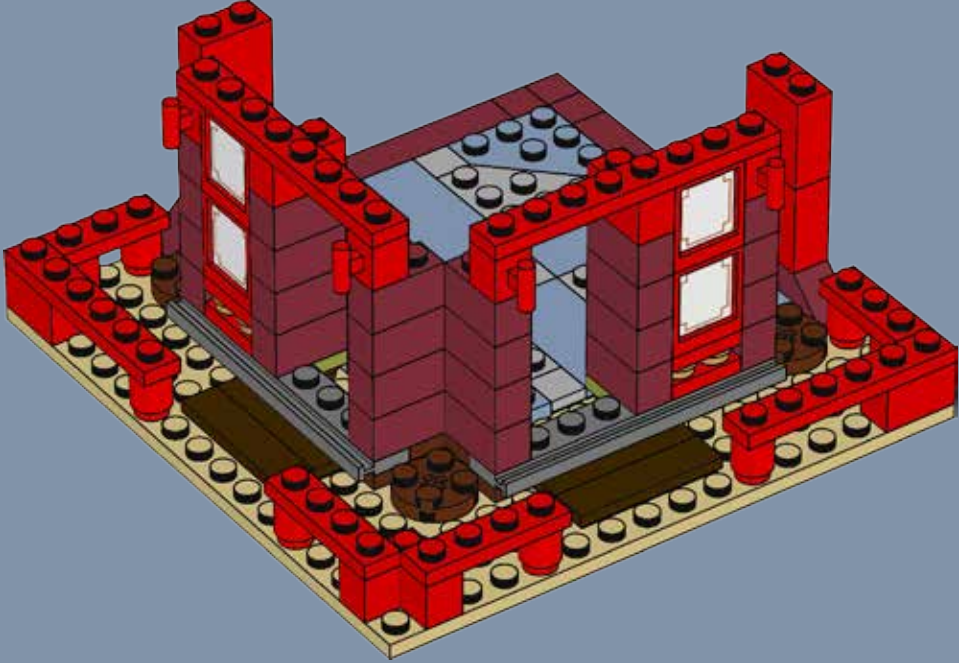



# 11

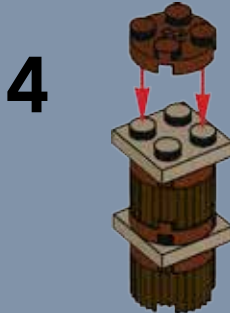

5



6



3x

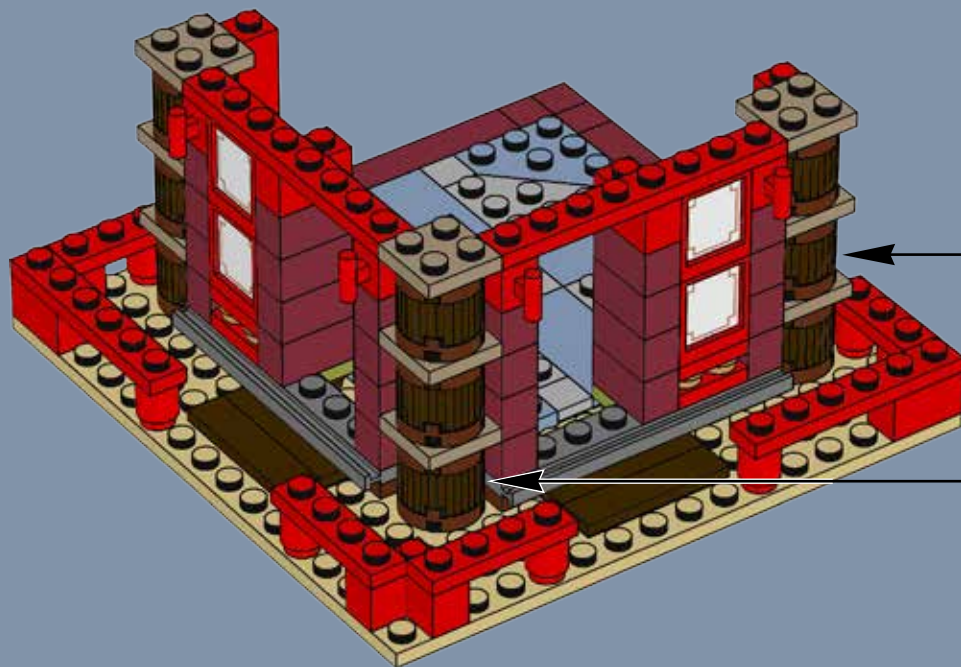



# 12

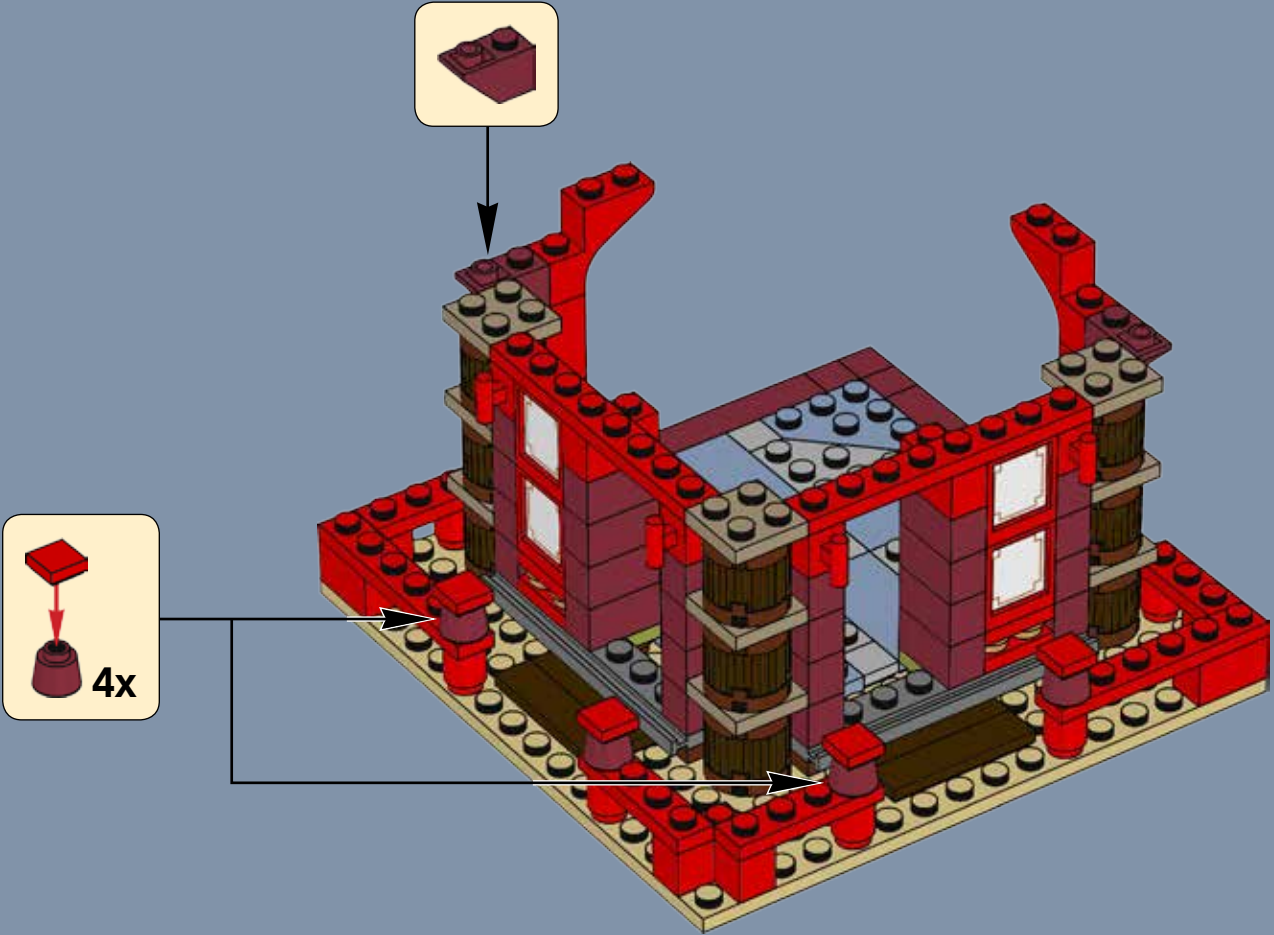



13

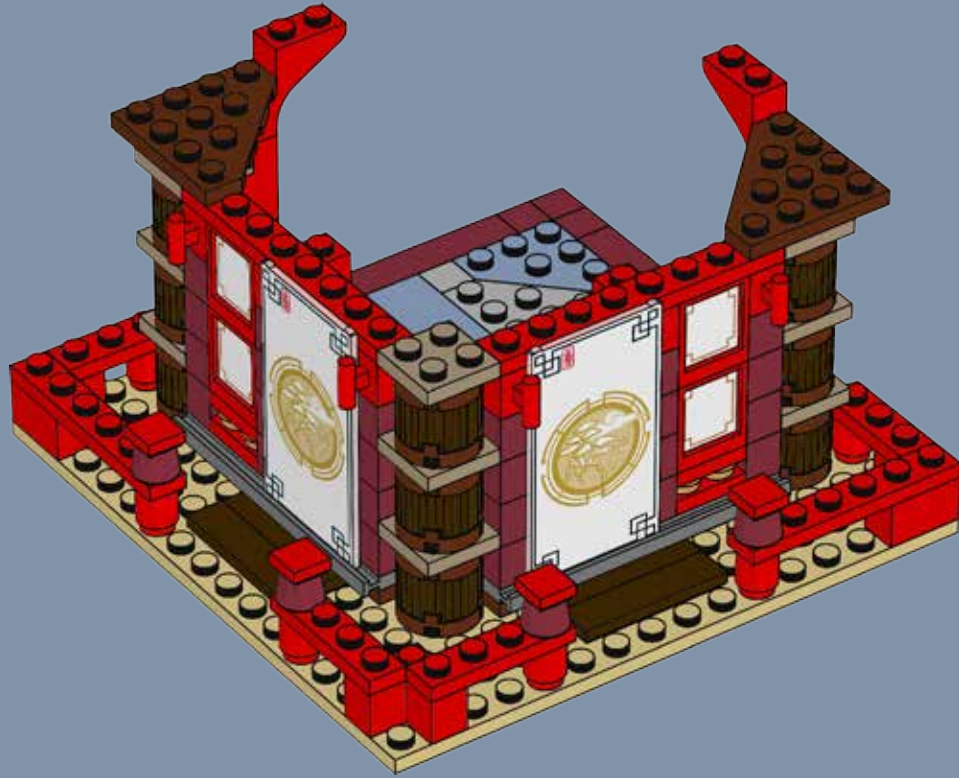



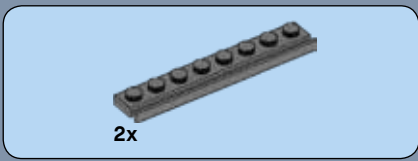

14



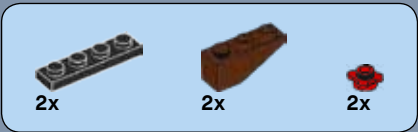

15





# 16



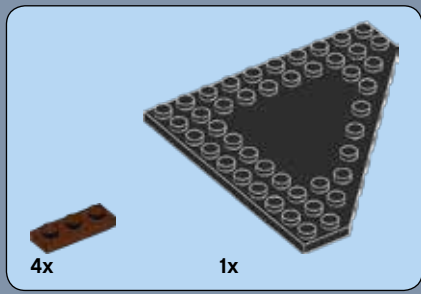

17





18



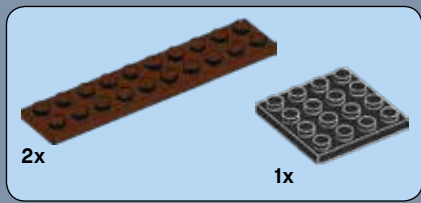

19



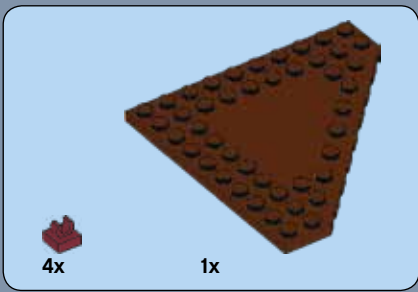

20



44







# 45

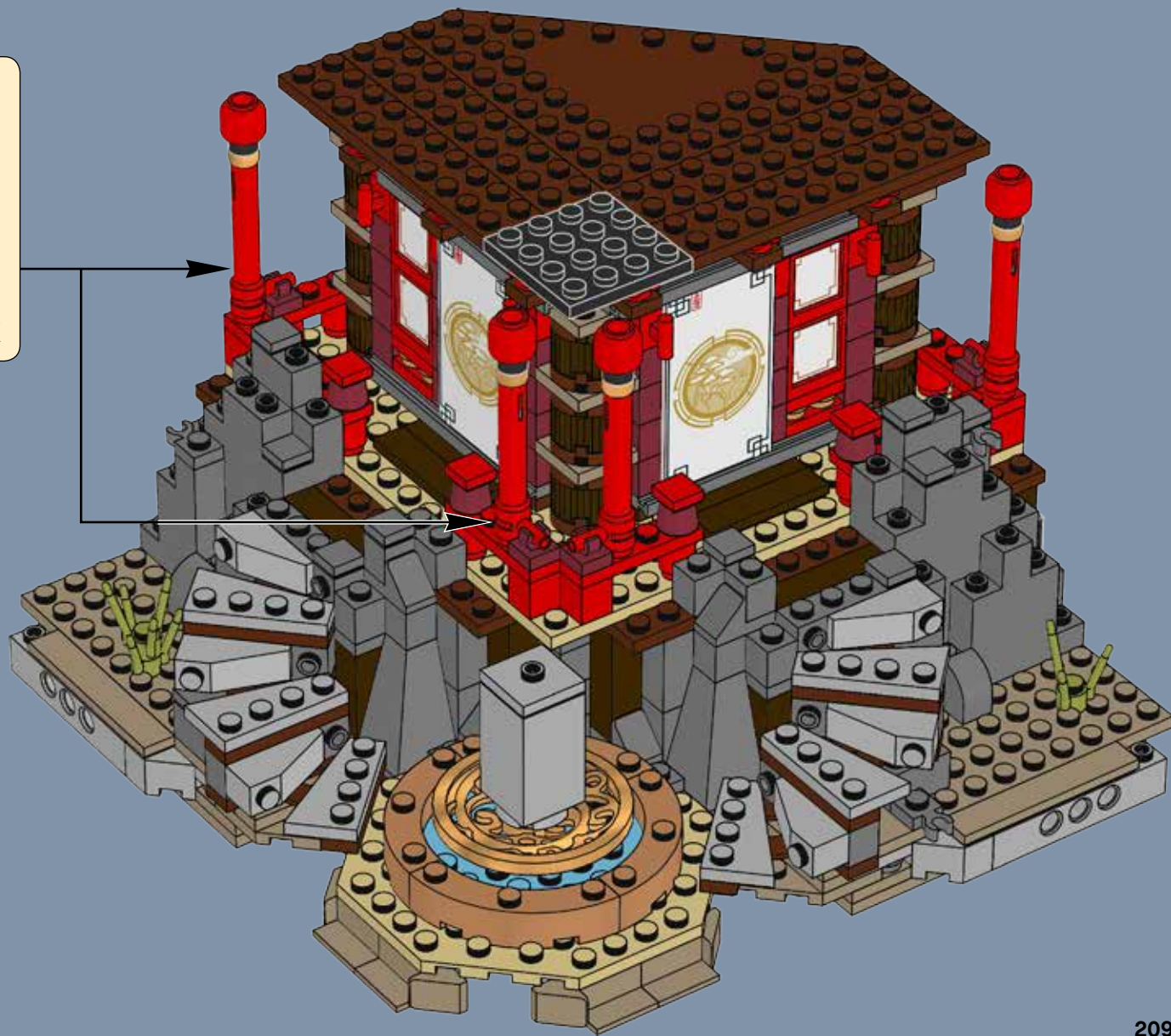
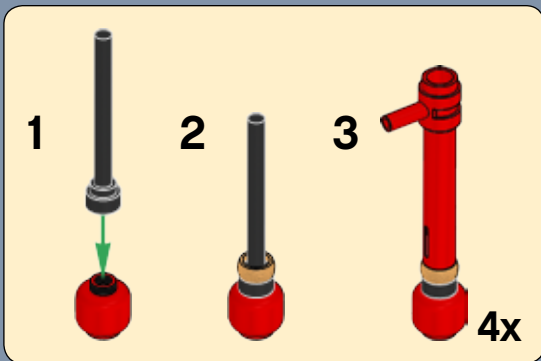





3x



3x

# 47

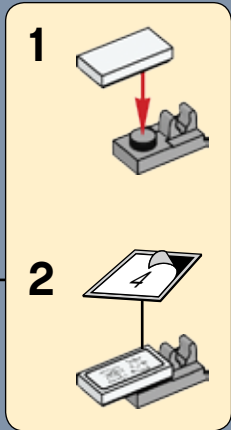
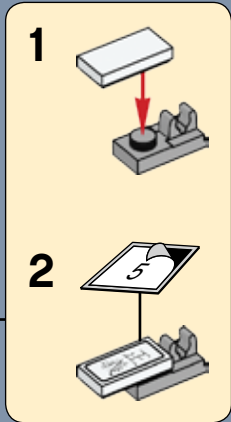
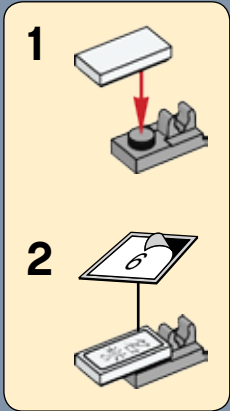

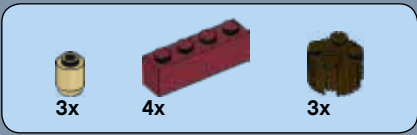

# 48





49

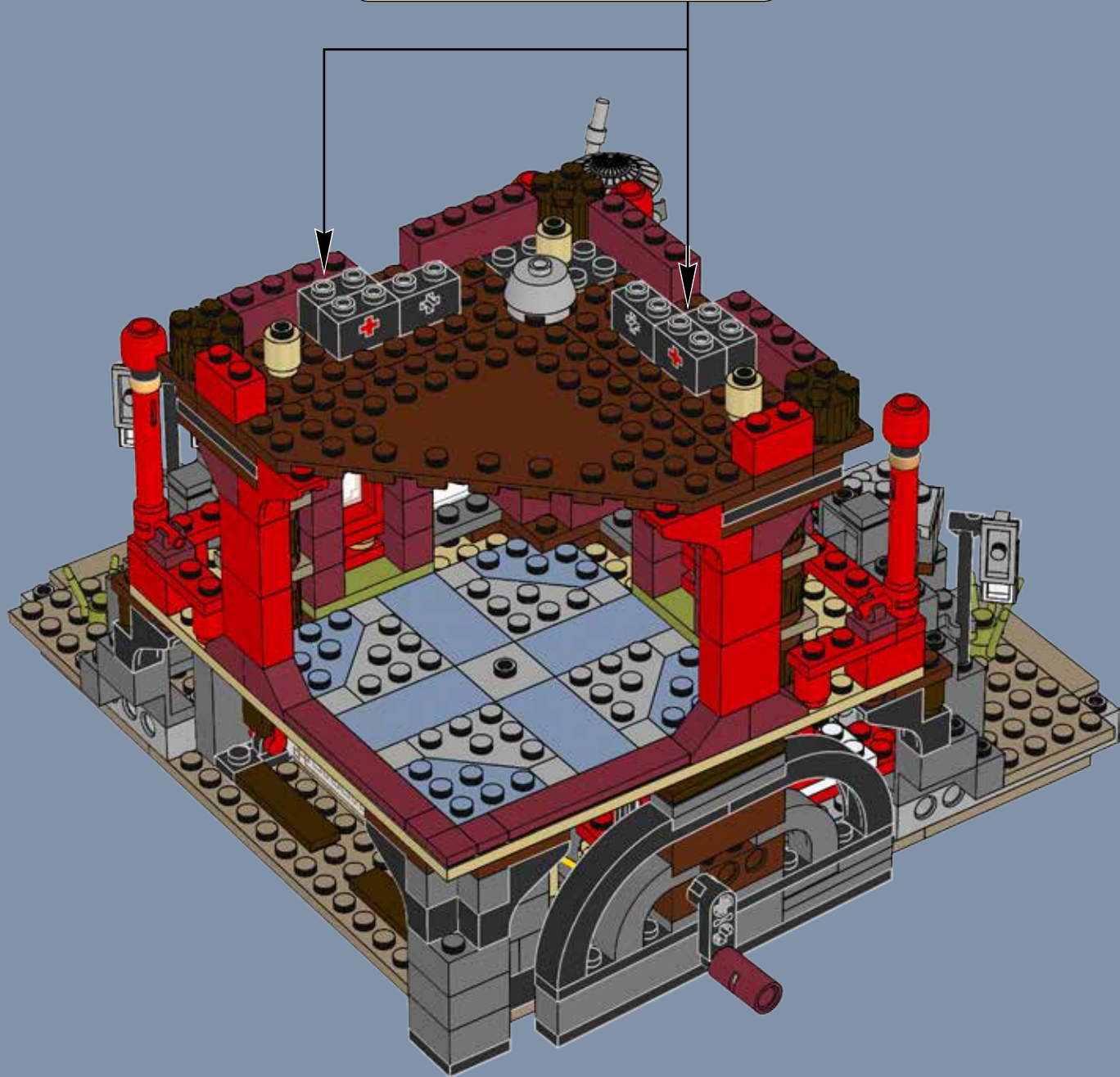
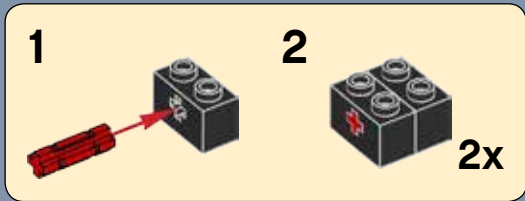

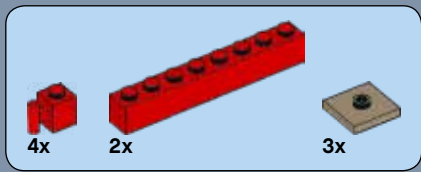

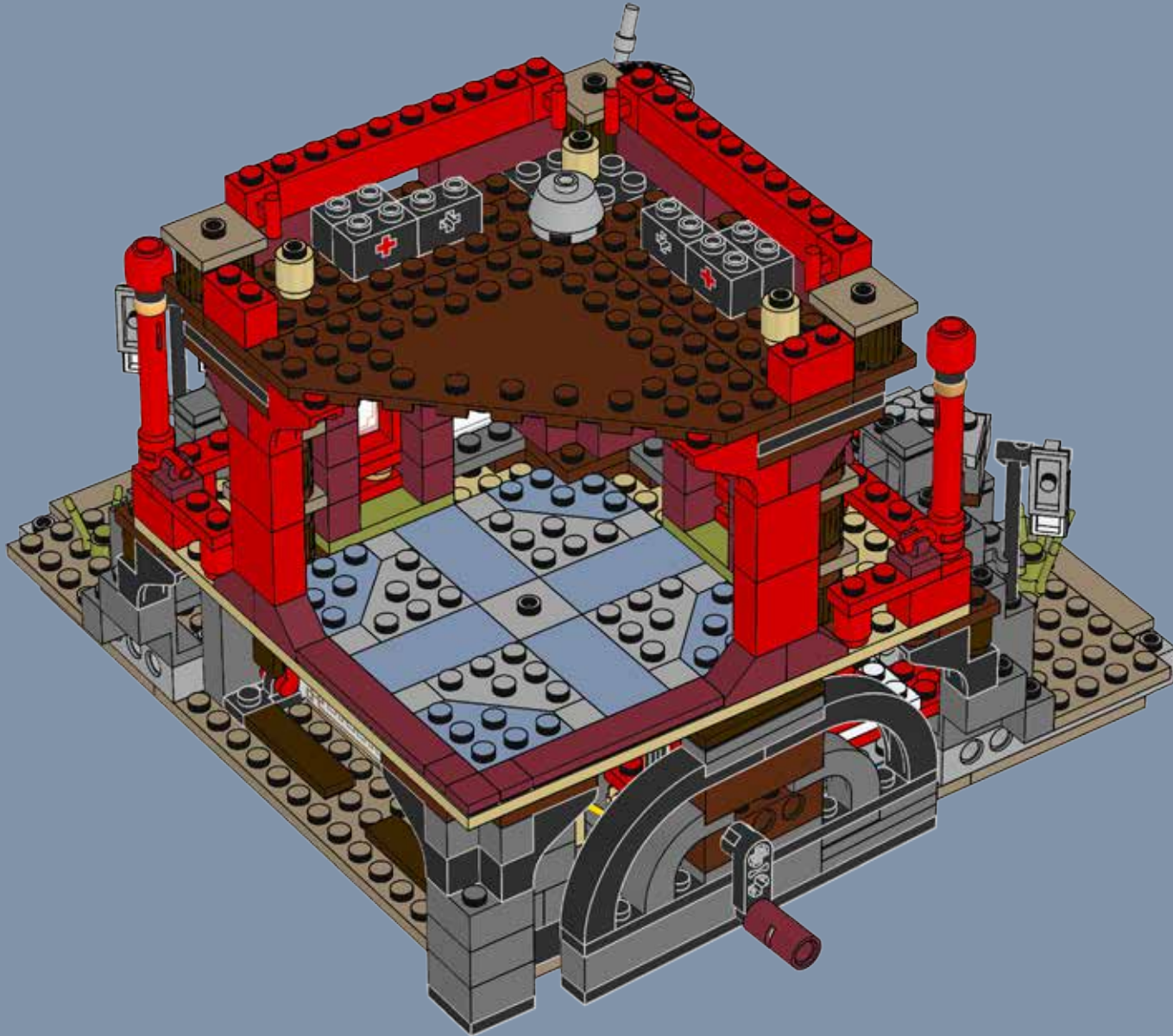

50

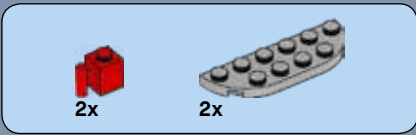

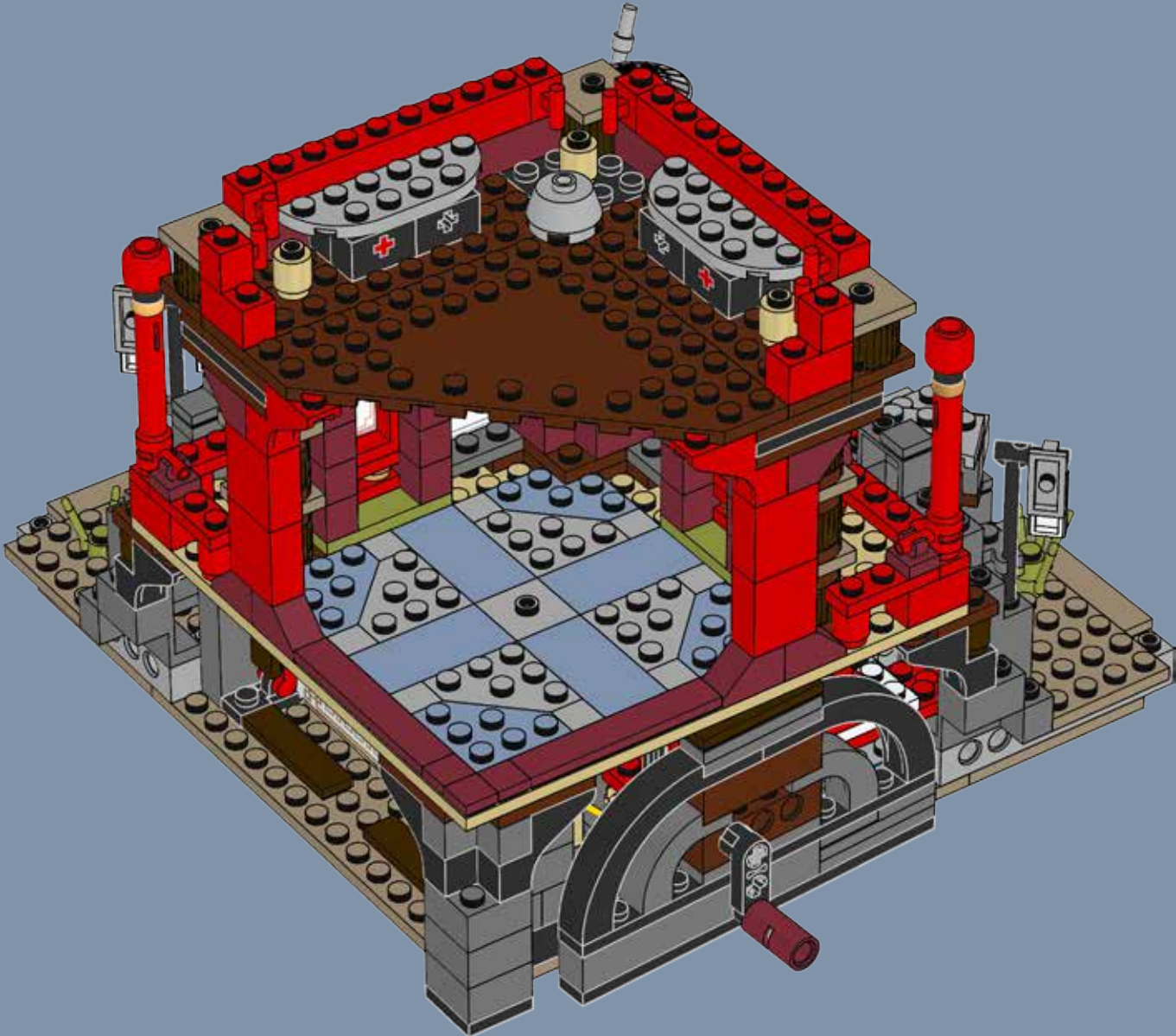

# 51



2x  3x  2x 

# 52





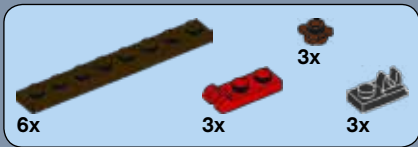

53

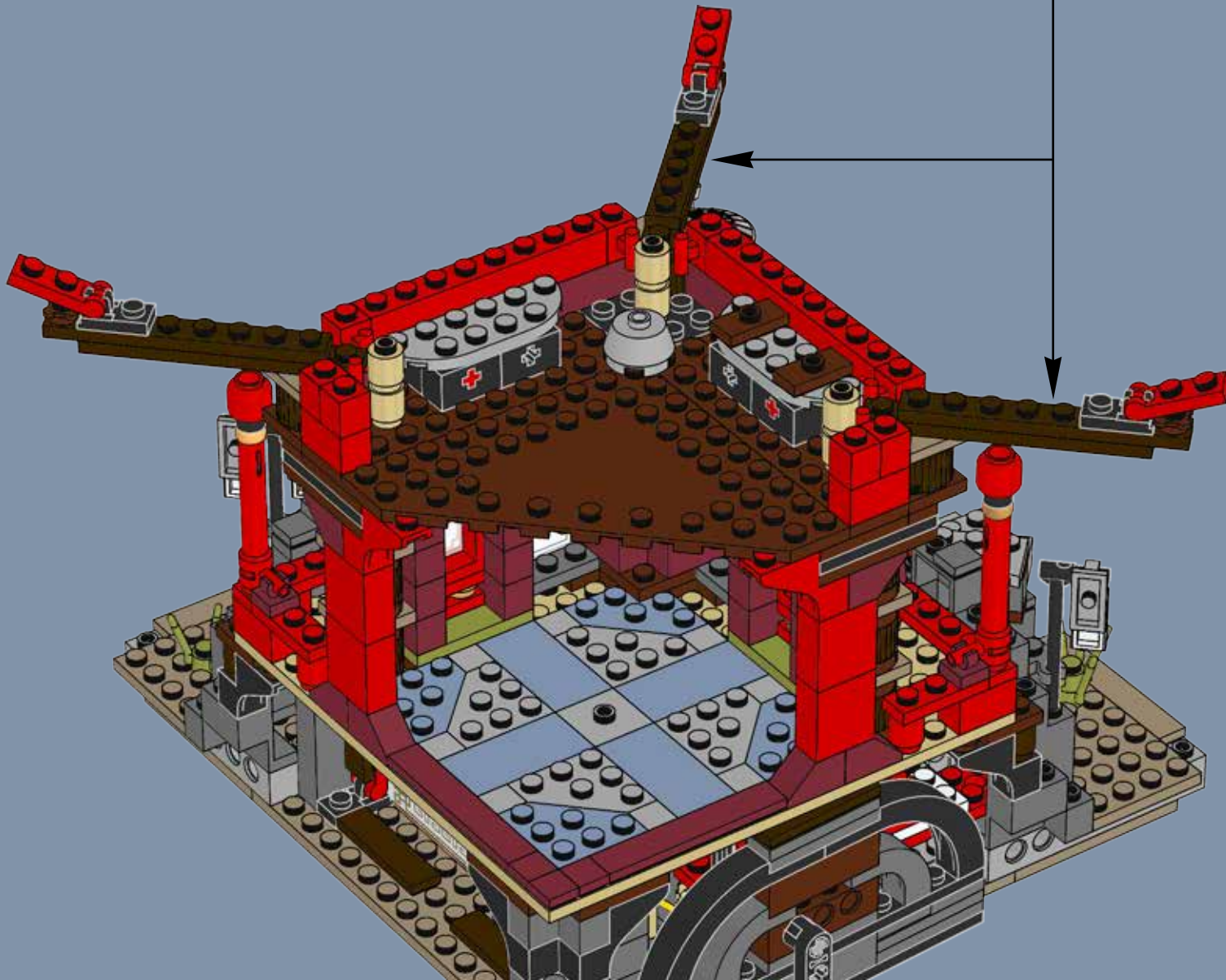
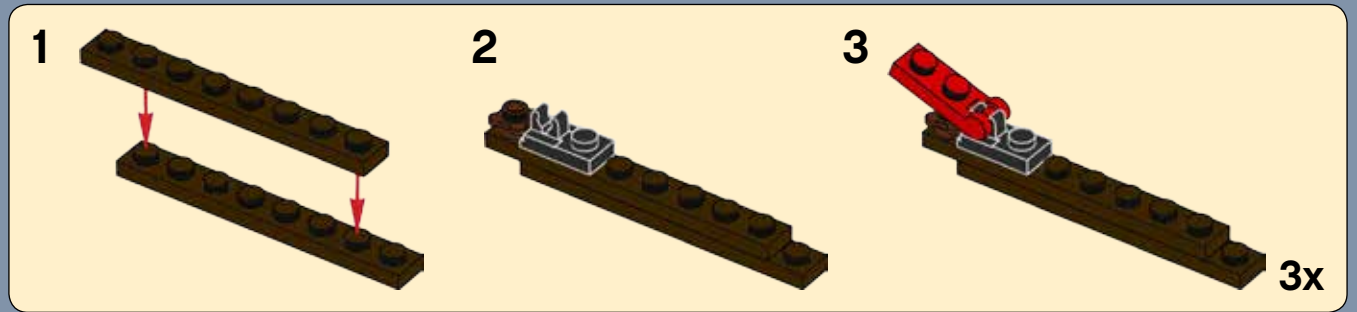

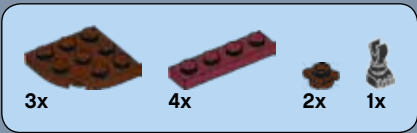

# 54





55

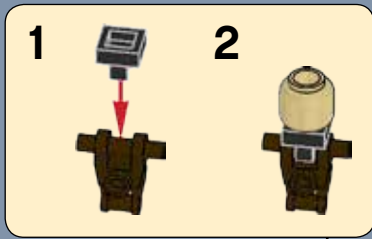

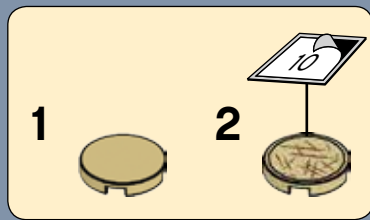
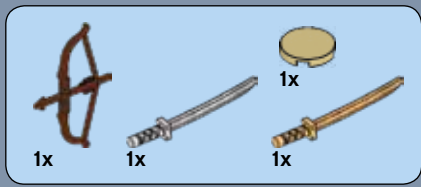

56



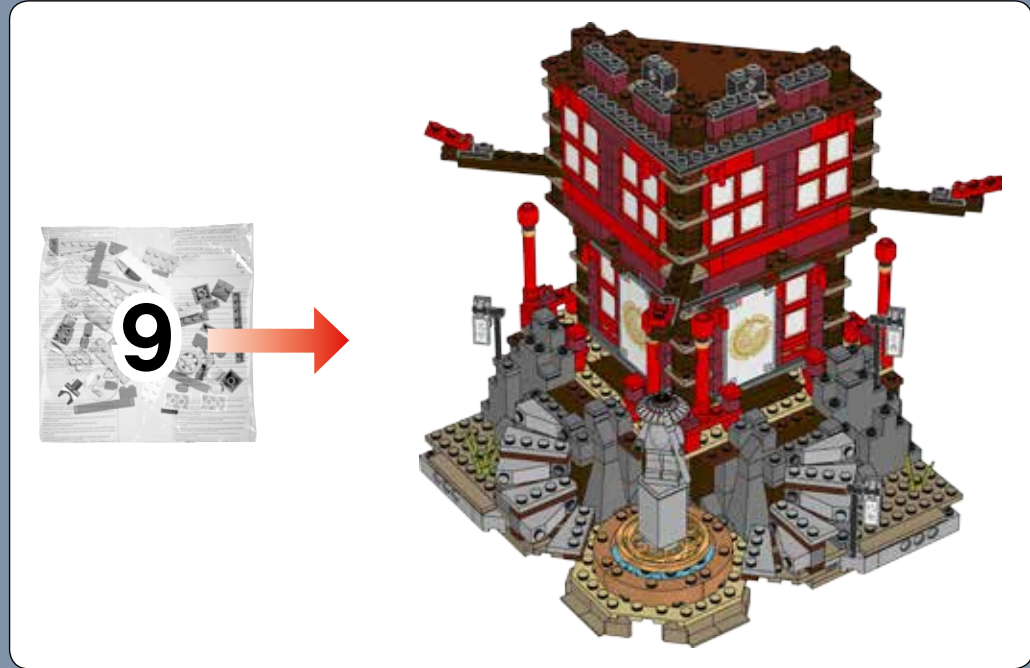



8x

57



2x

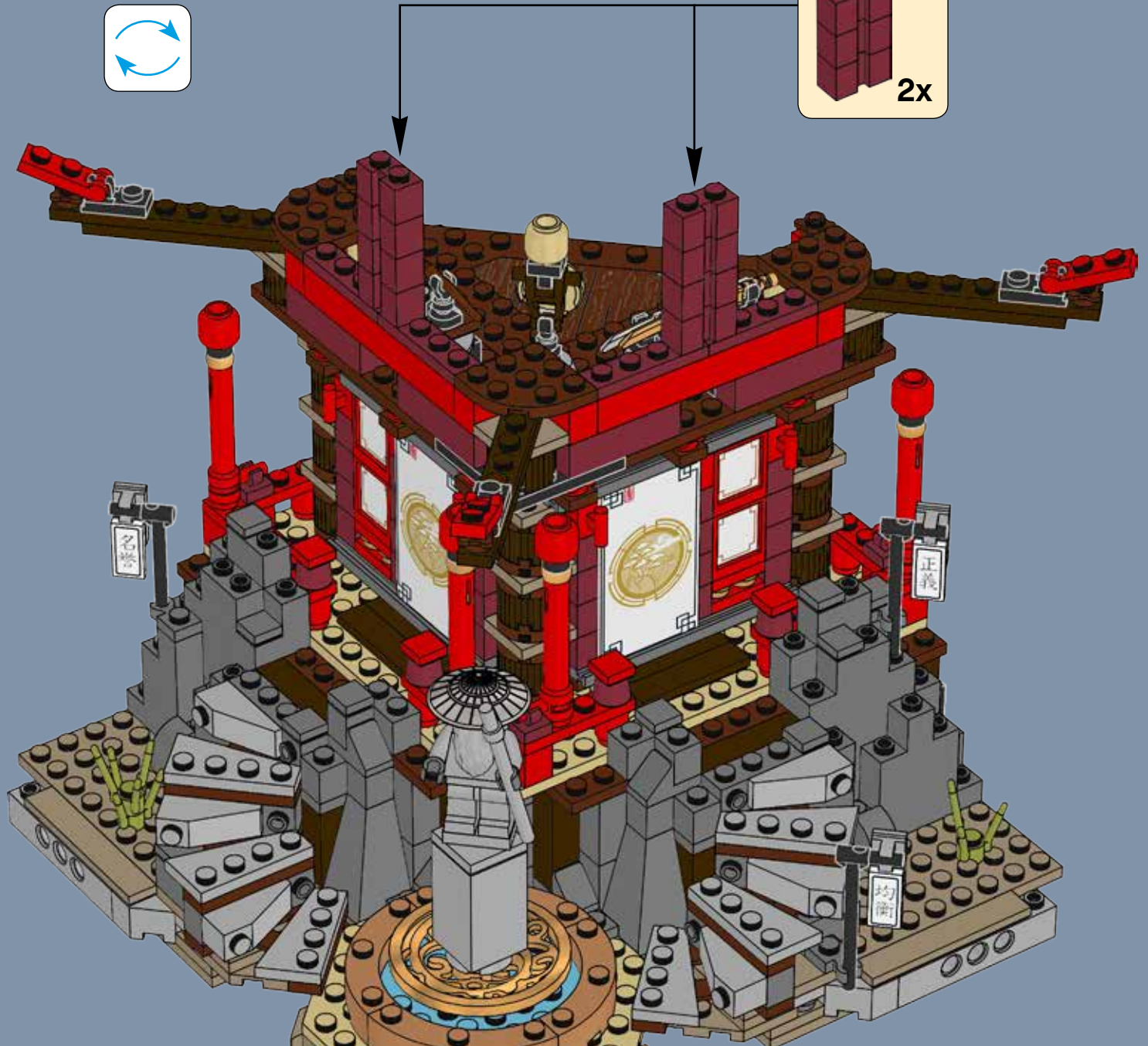



16x



16x

# 58

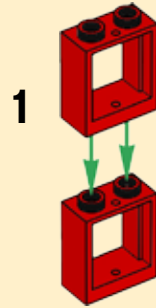

8x





3x



12x



6x



6x

59

1



2



3



4



3x







60

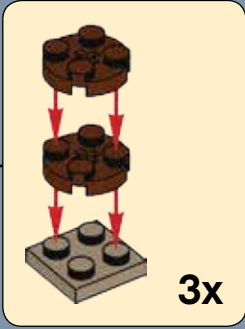

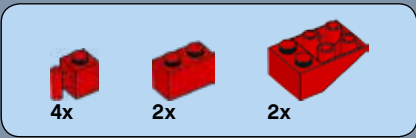

# 61



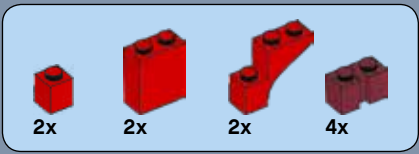

62

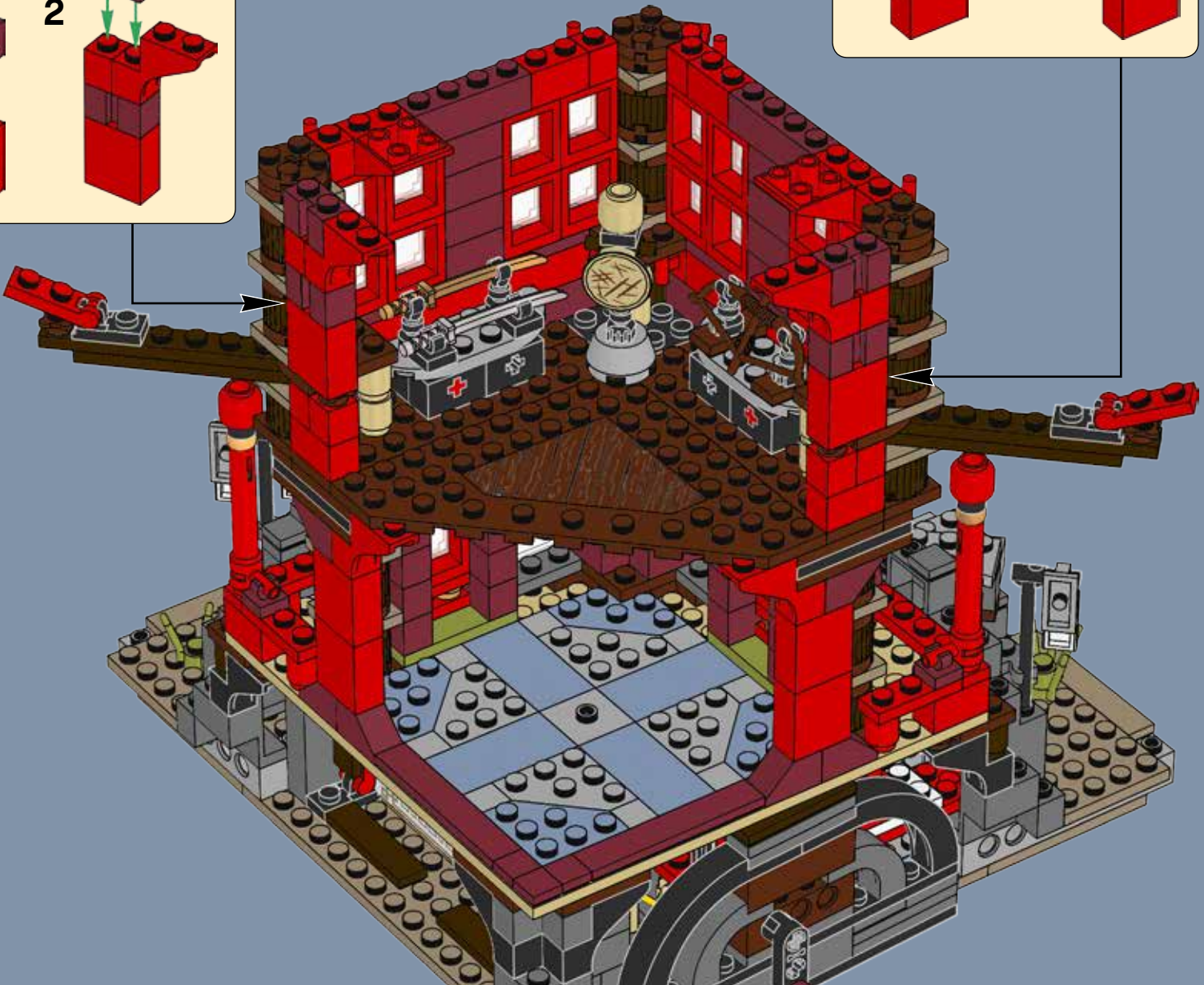
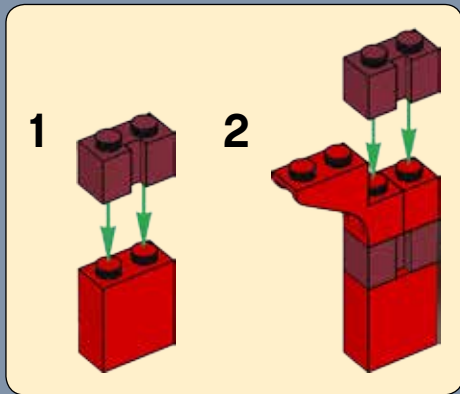
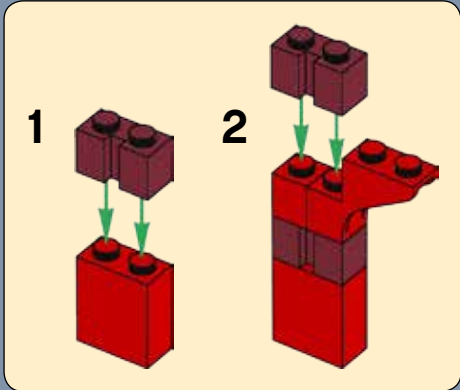

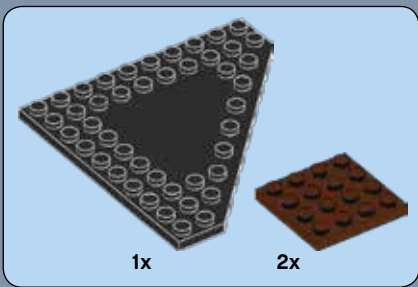

63



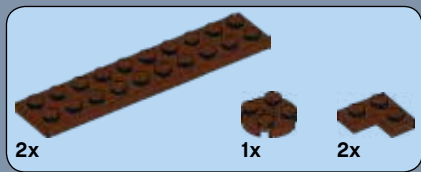

# 64



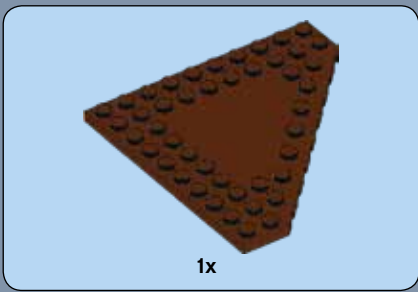

65

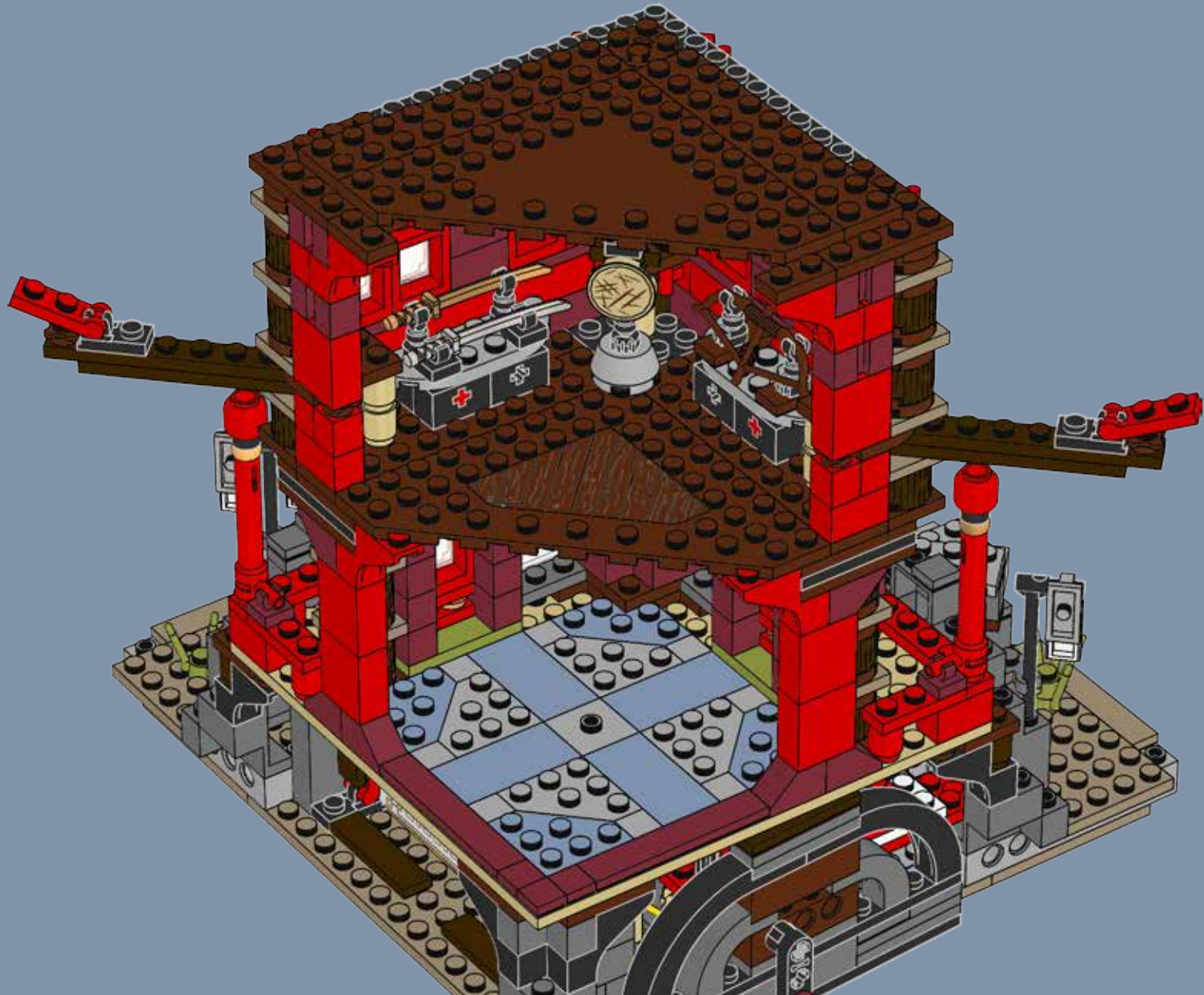



# 66







67



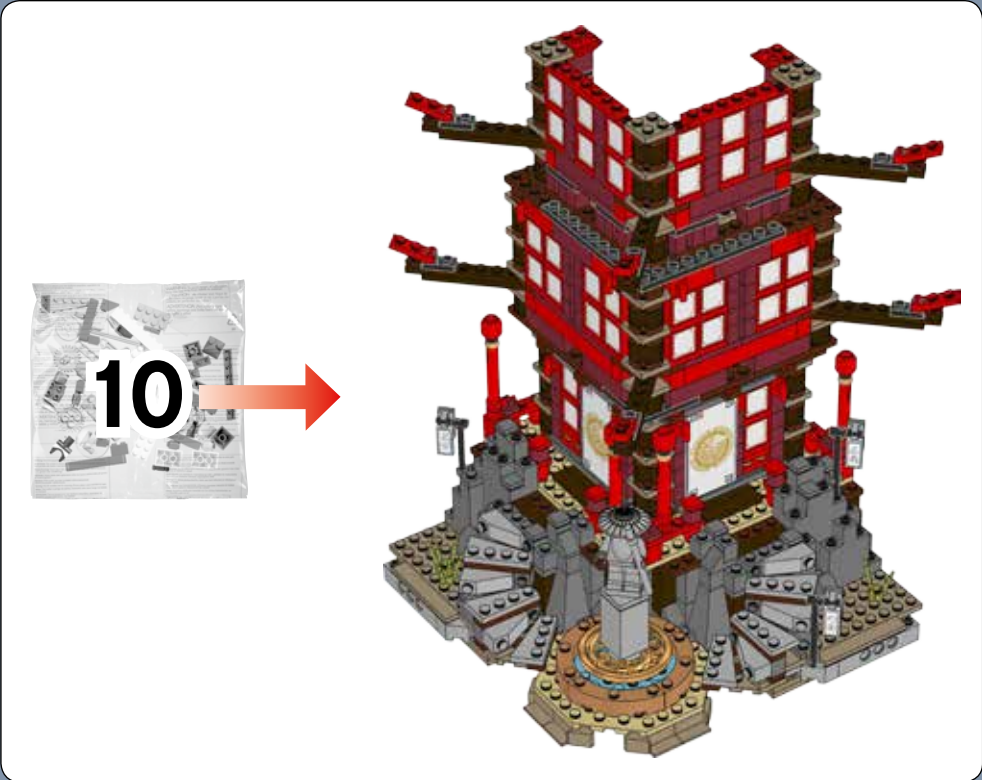



68





69



2x  3x 

70





71



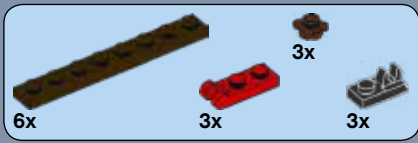

72

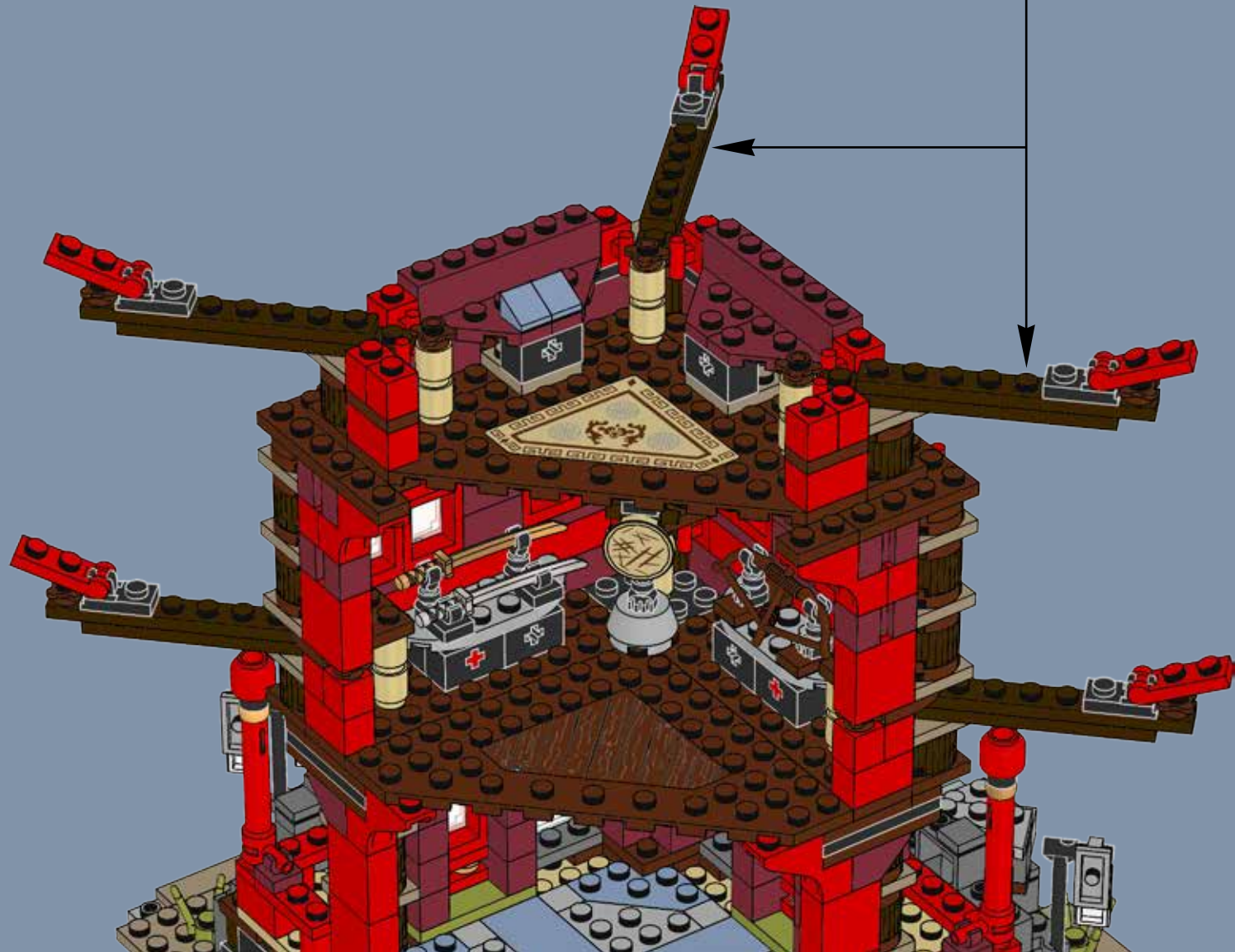
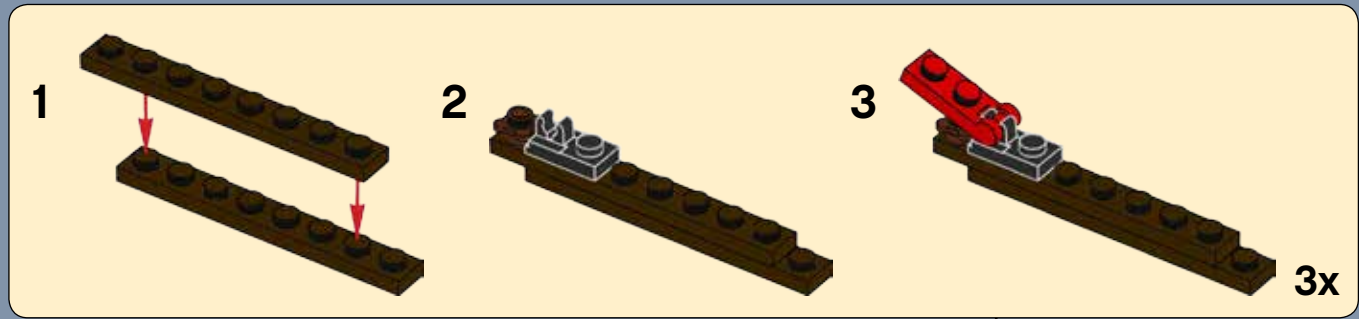

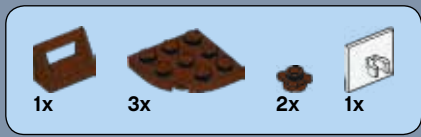

73

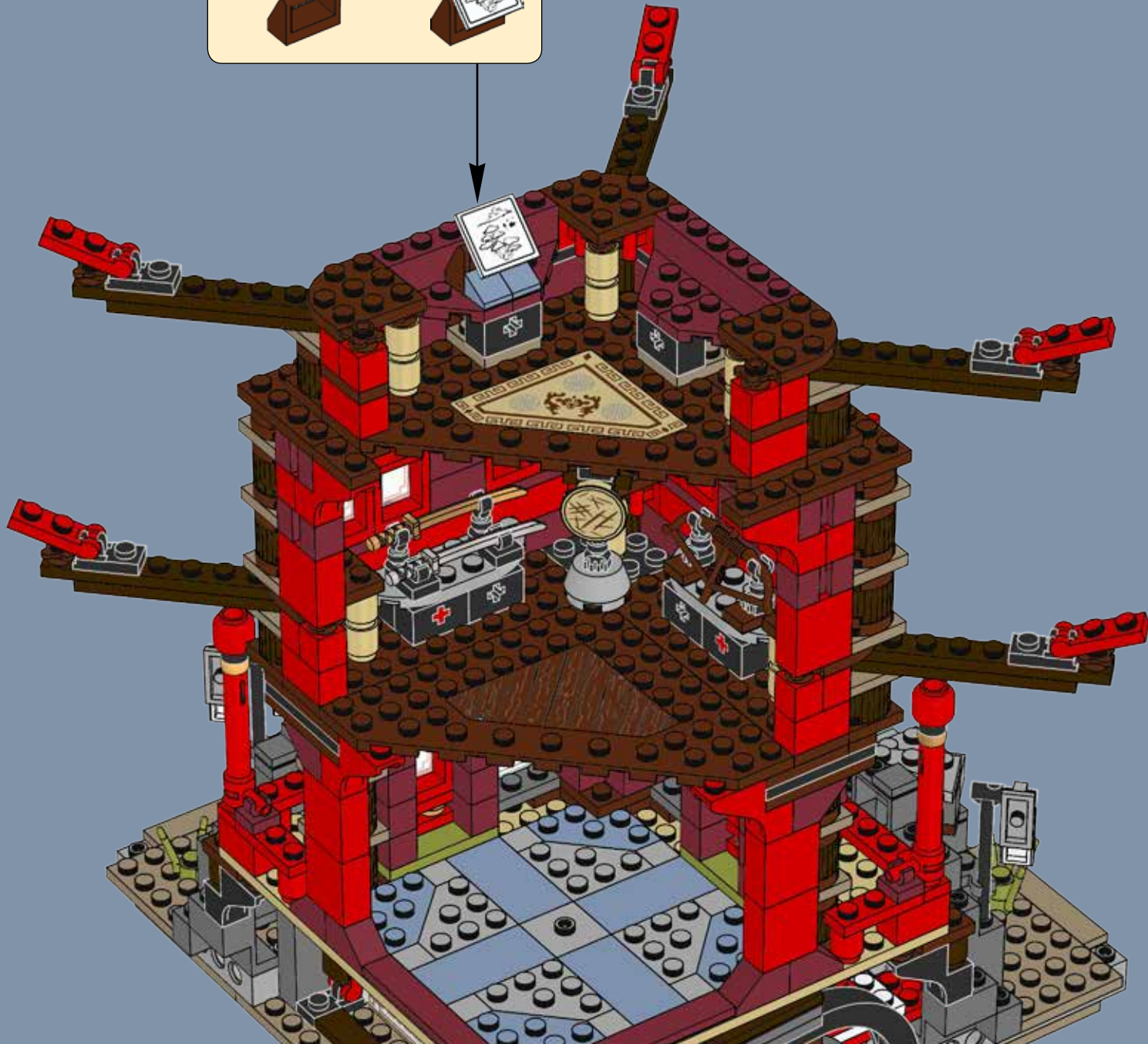
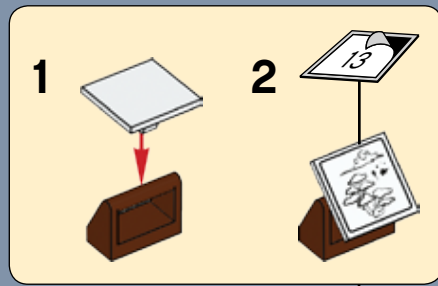





74

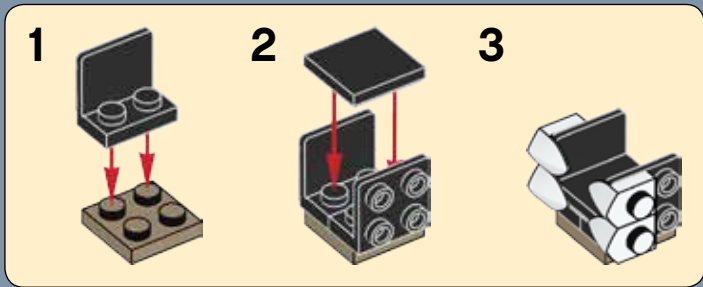



3x



12x



6x



6x

# 75

## 1



## 2



## 3



## 4



# 3x

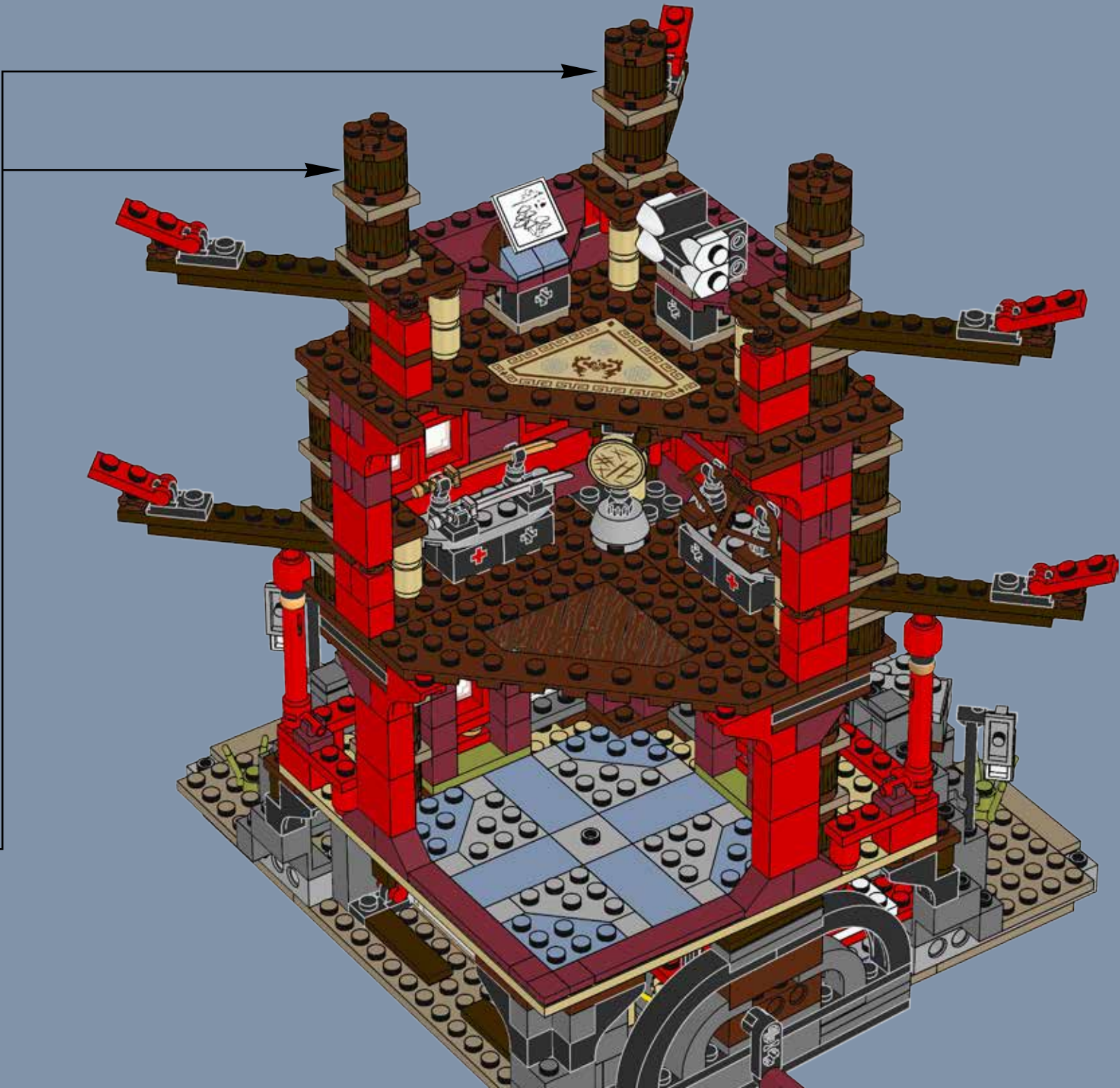



76

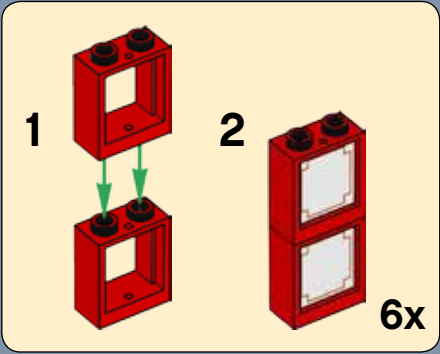



16x

77



4x





78

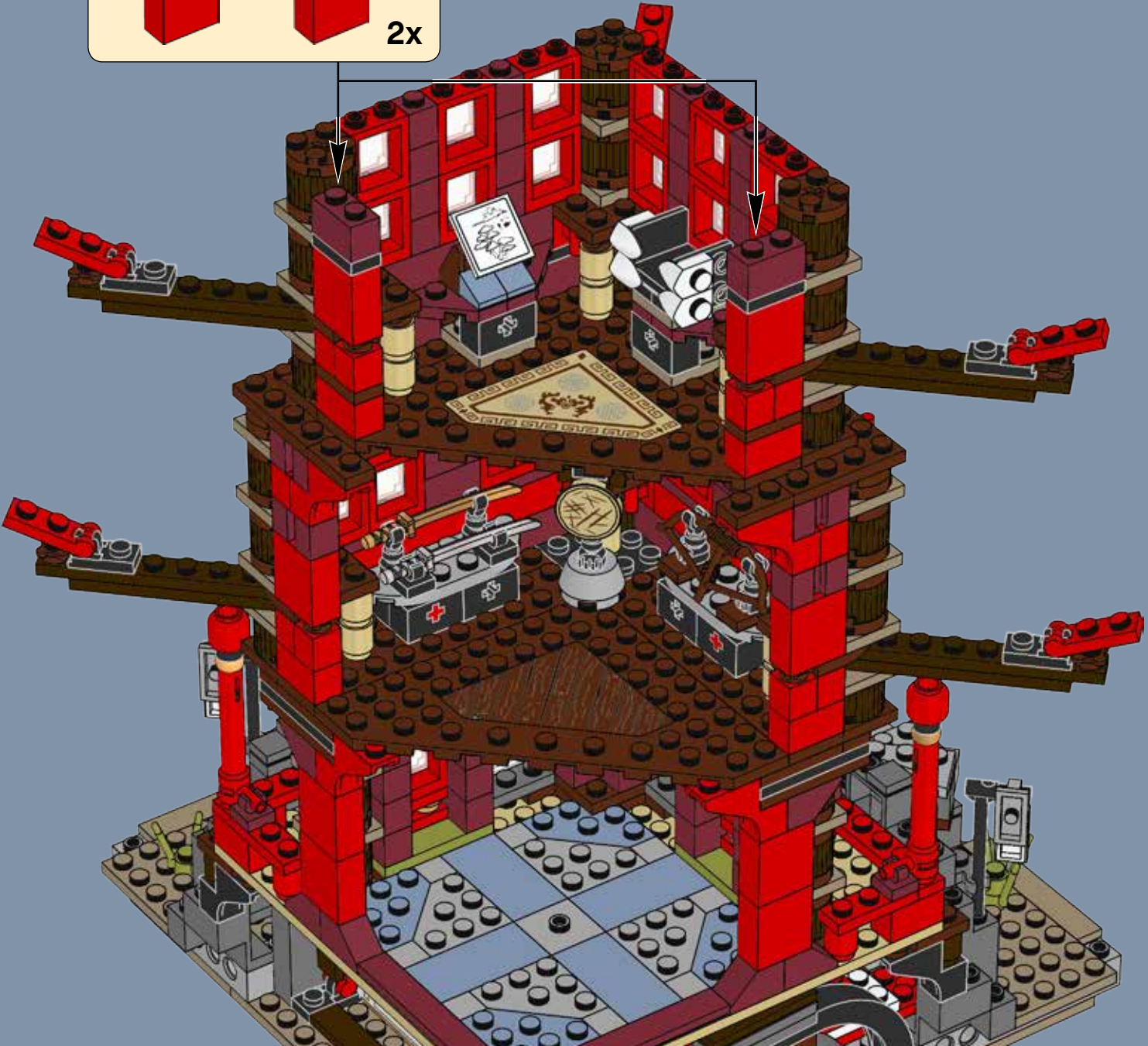
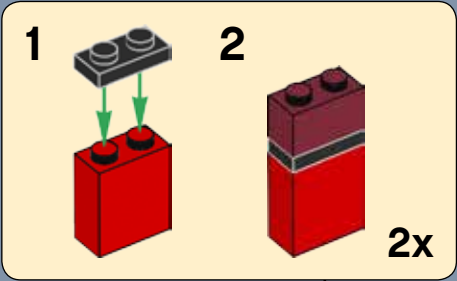

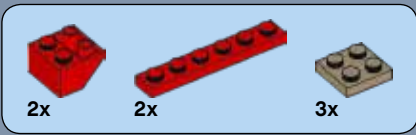

79

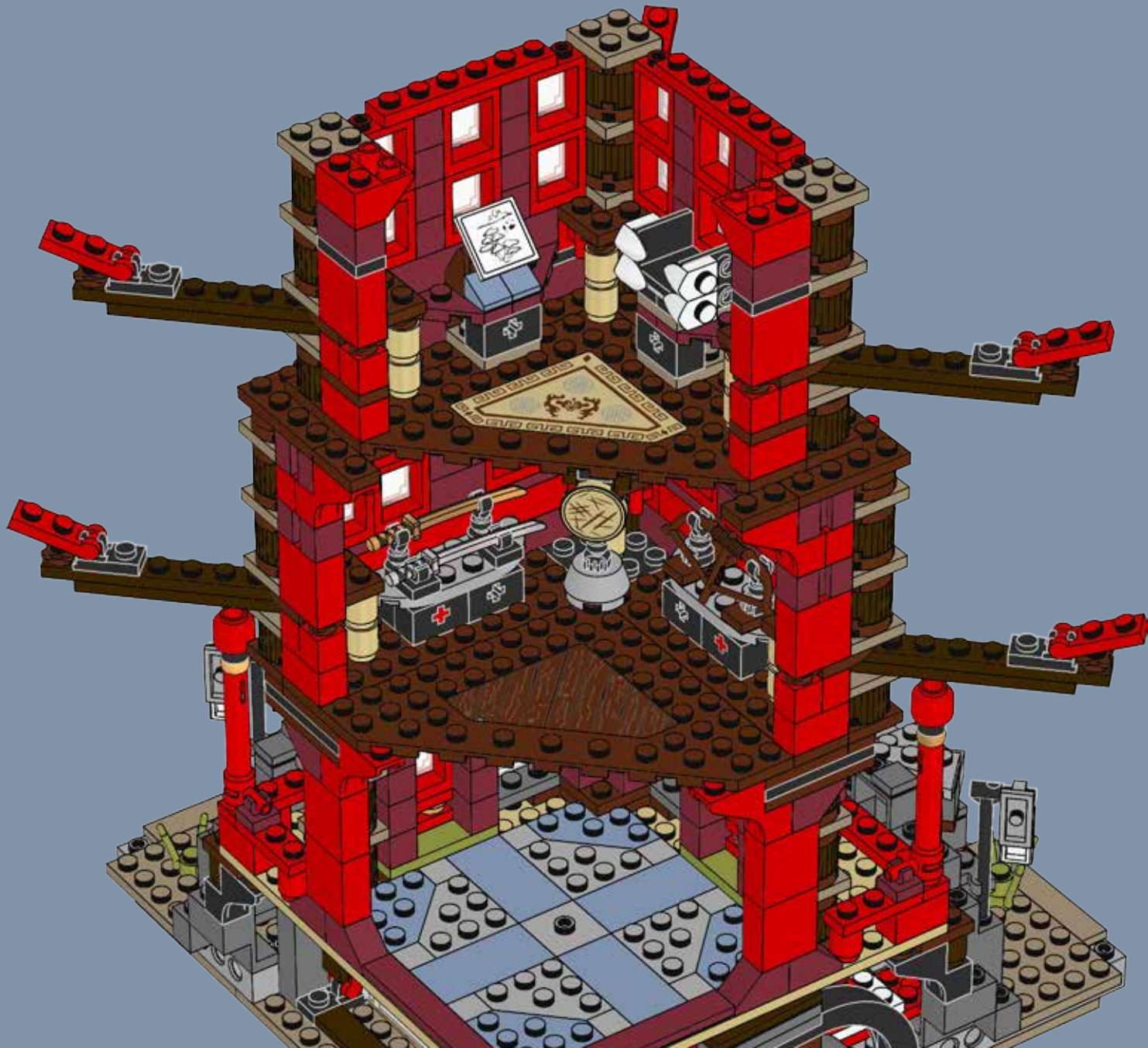







80



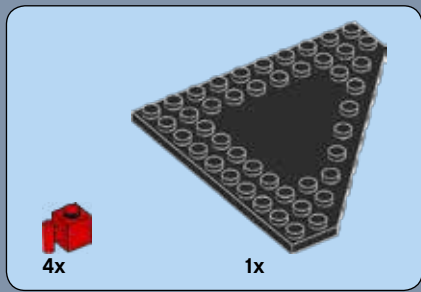

81



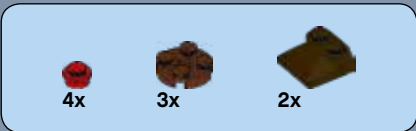

82





4x



3x





# 83





84



2x  4x 

85

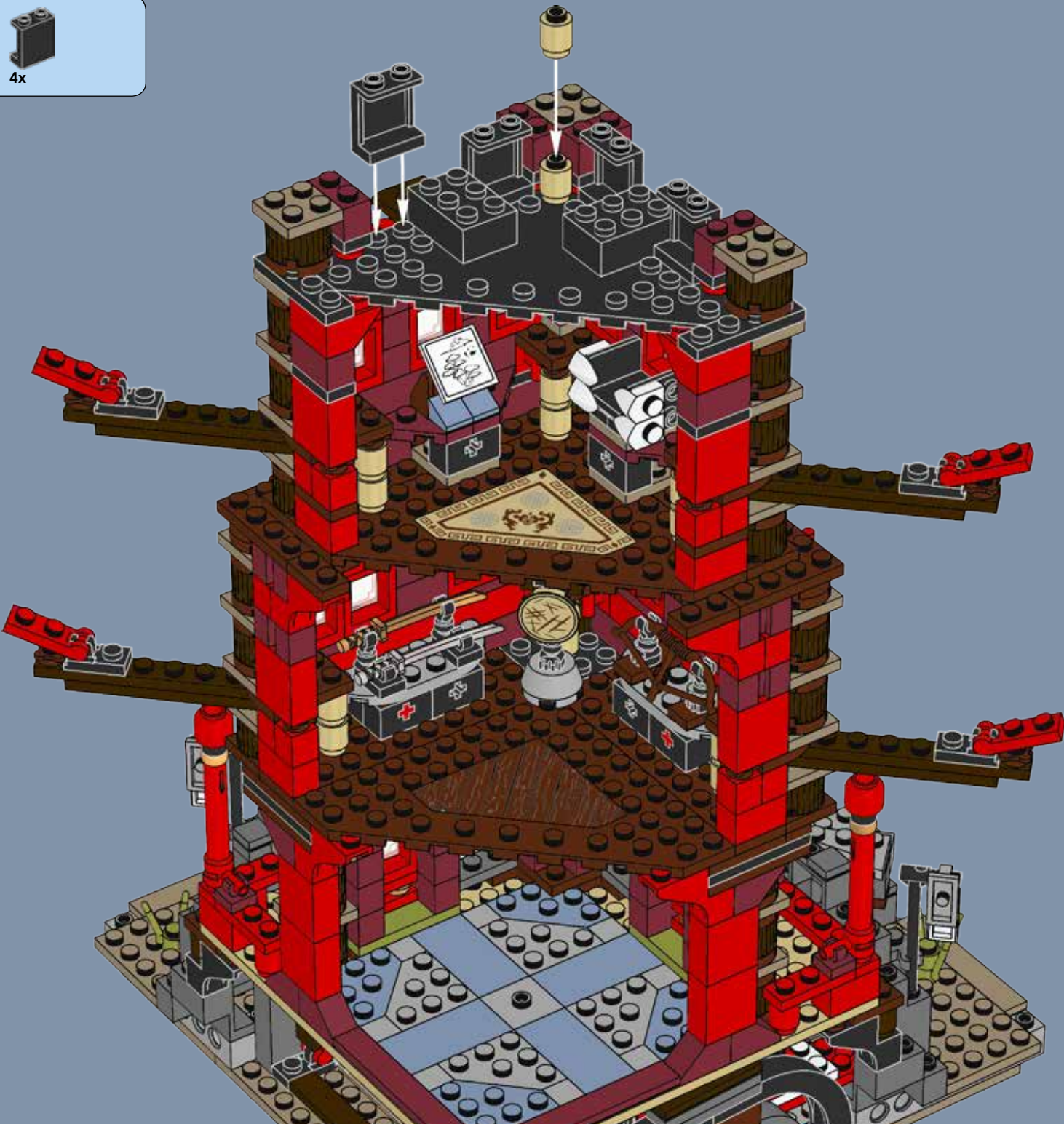

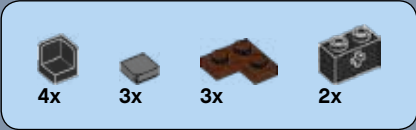

86

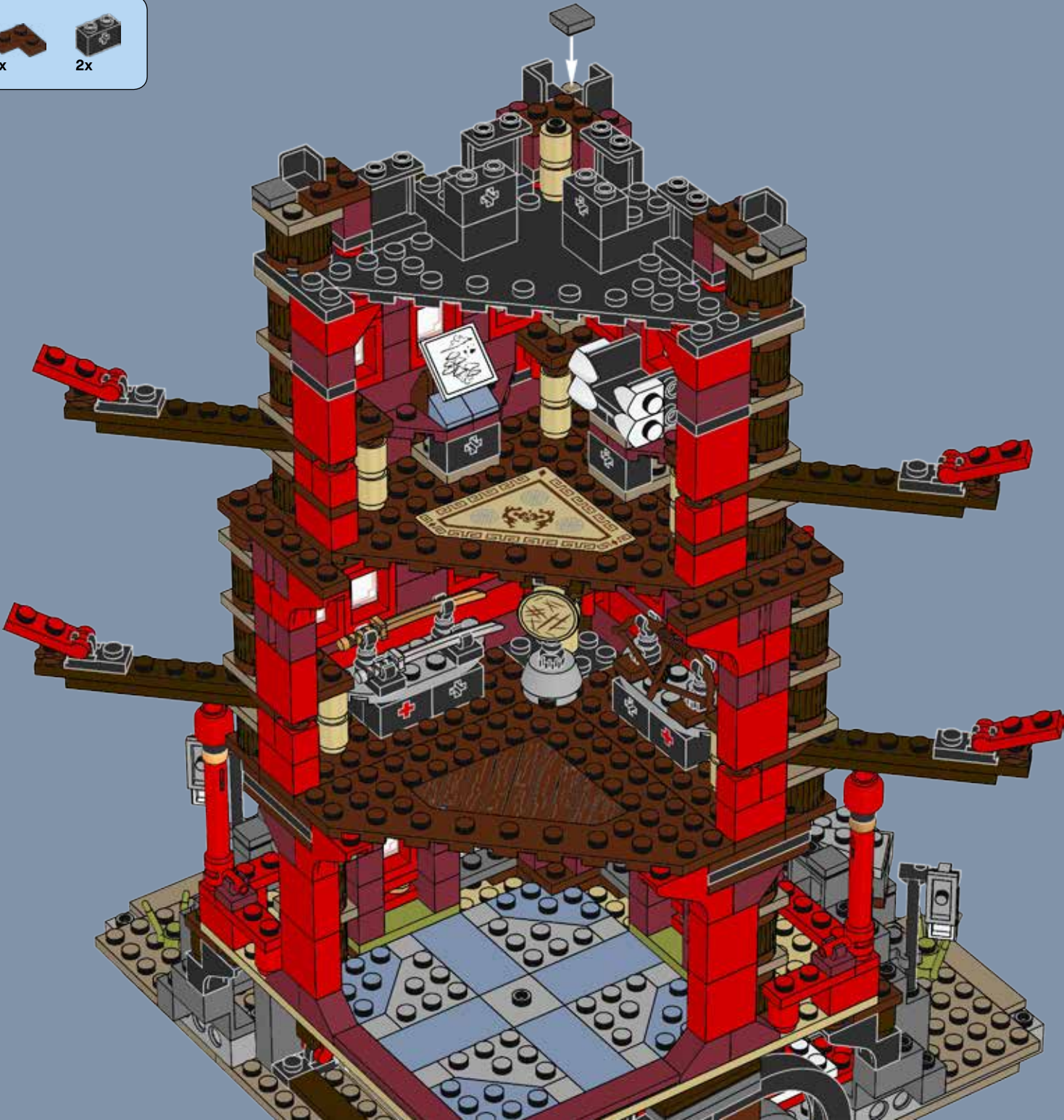

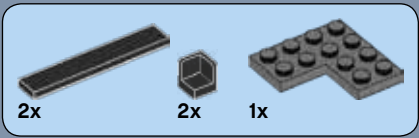

87





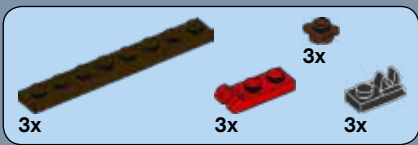

88

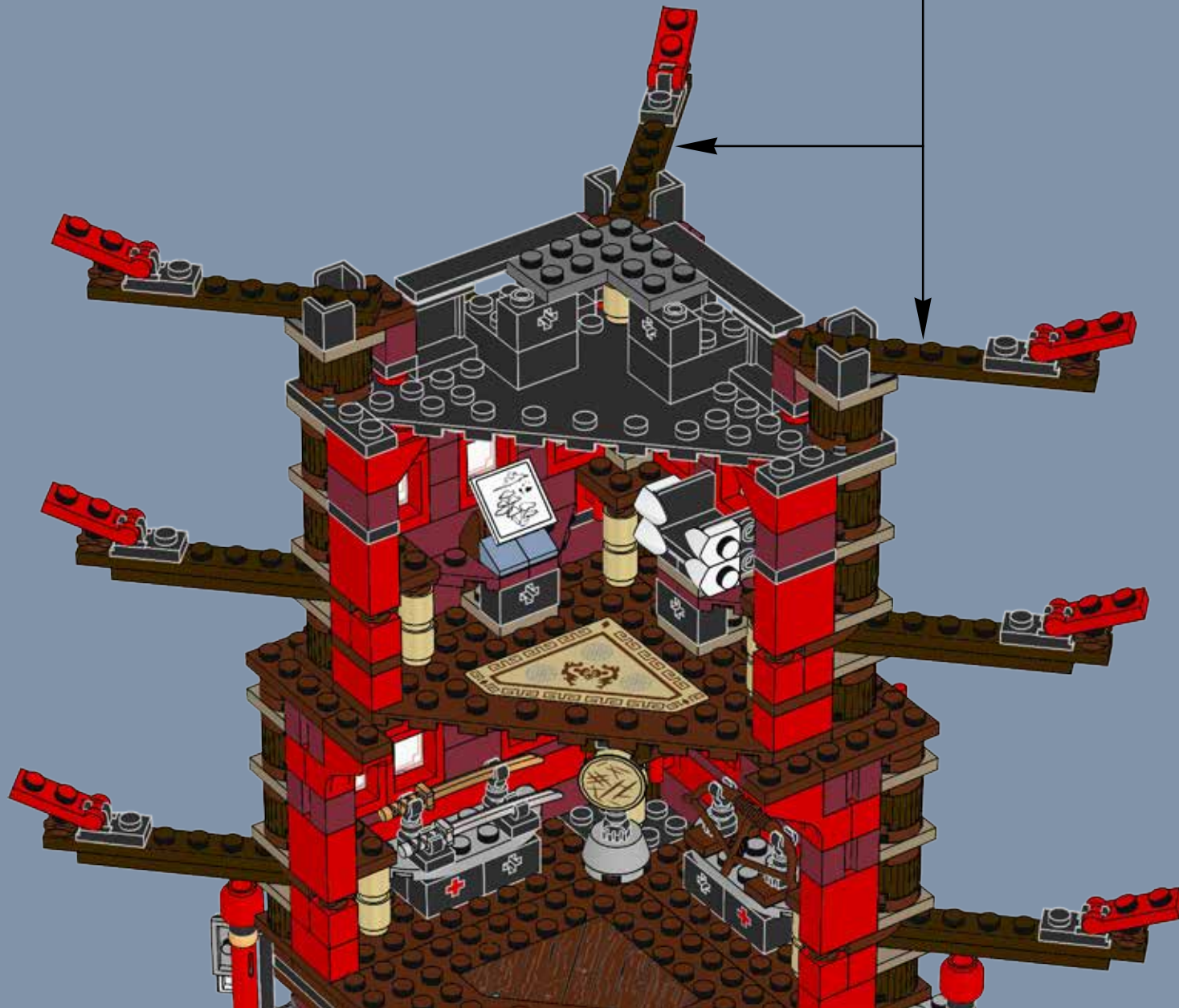
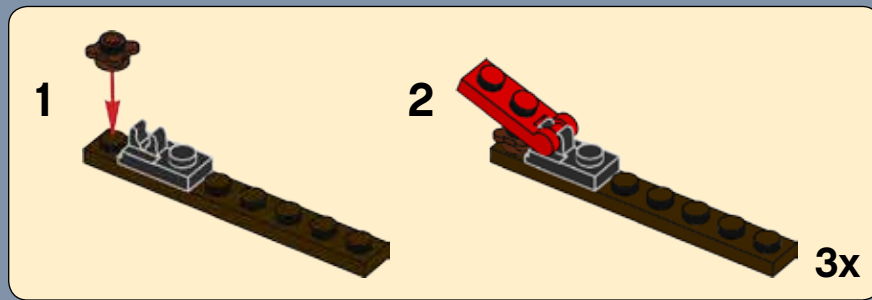



89

1



2



3

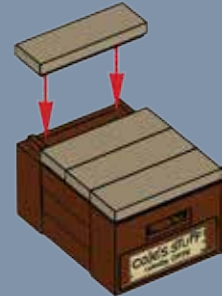

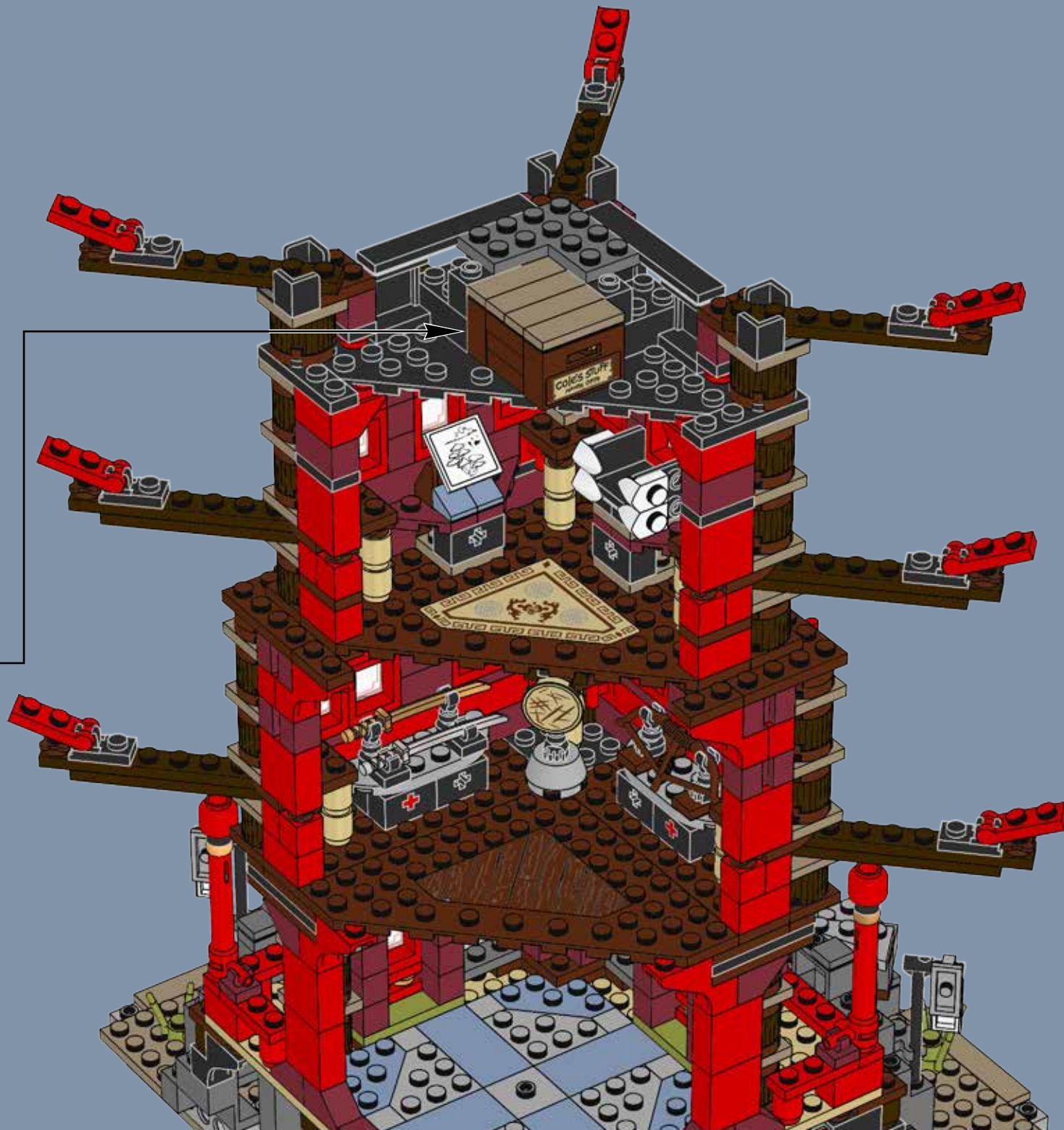

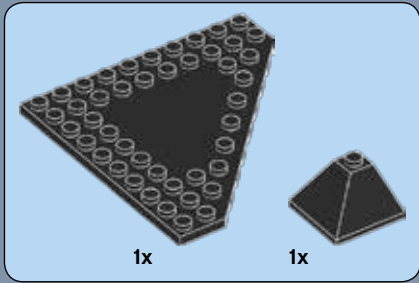

1

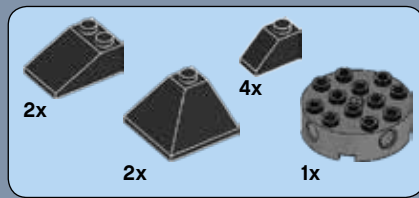
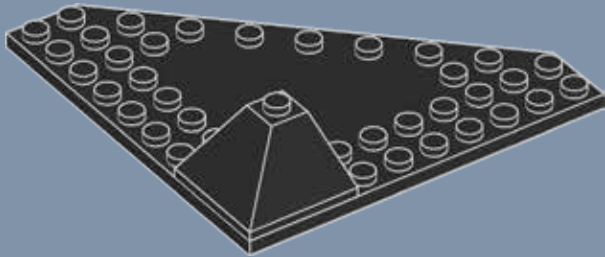

2

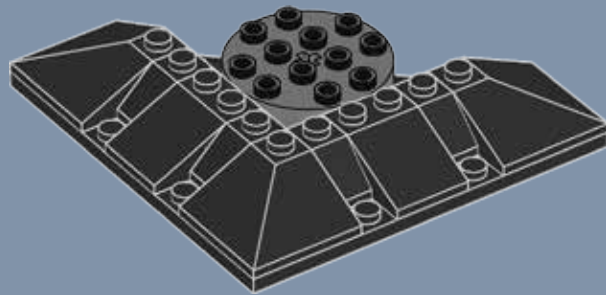



3

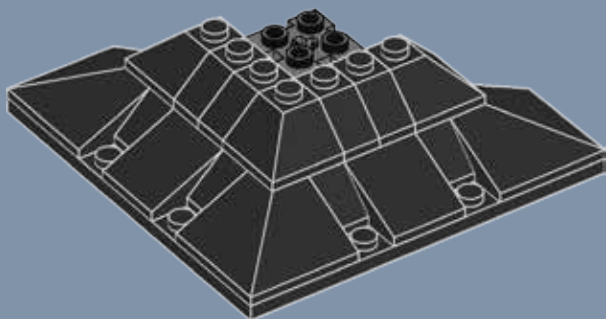

4

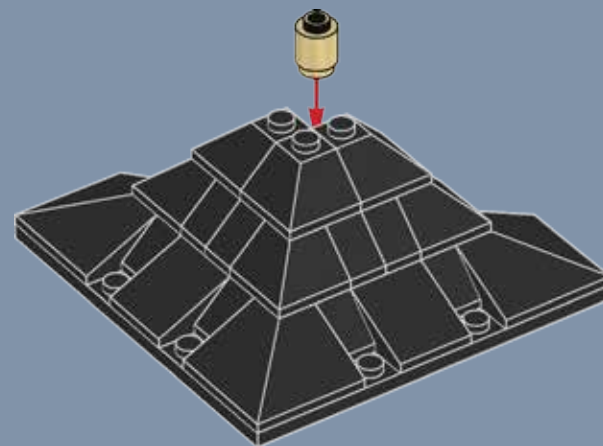

90

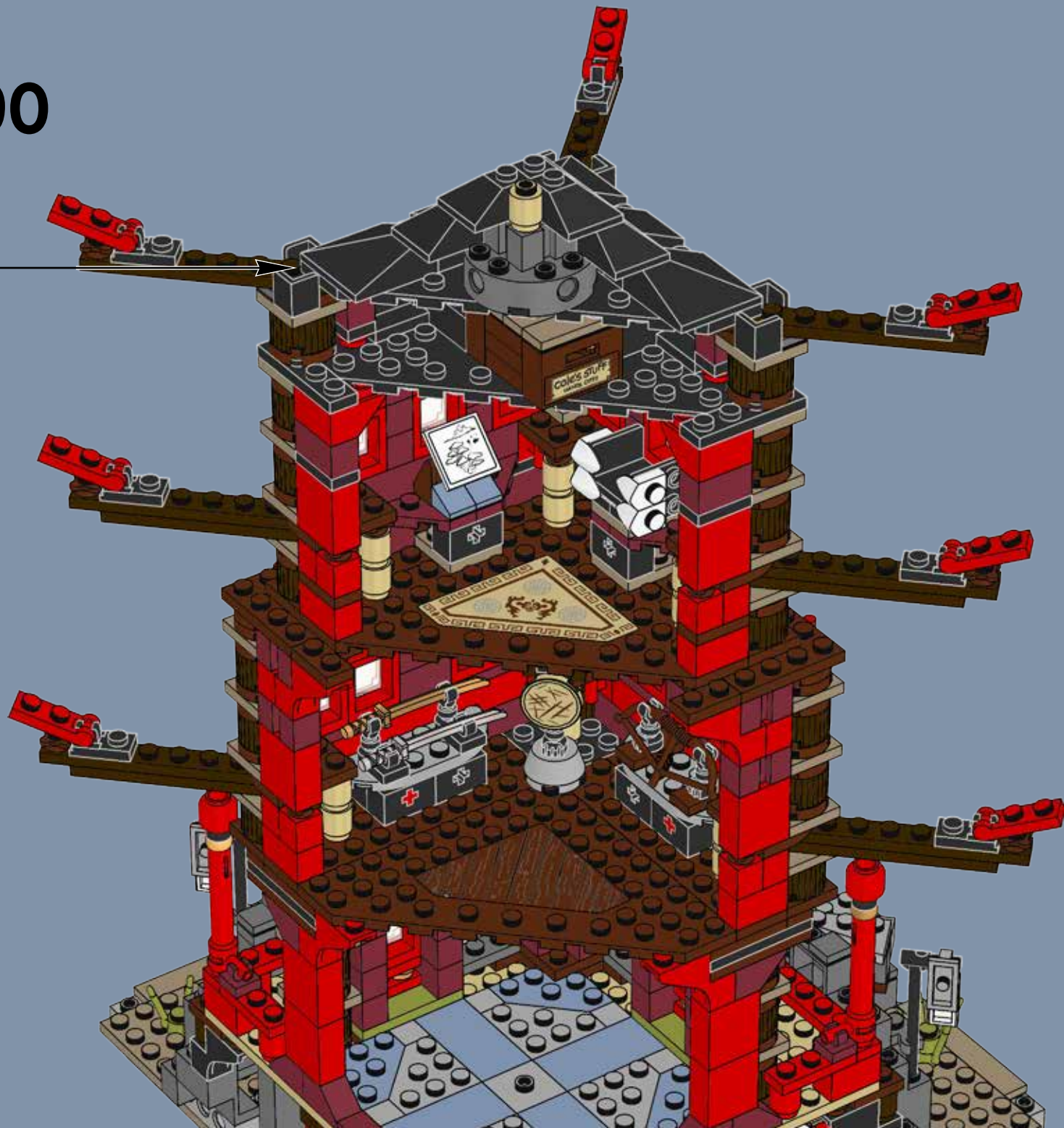

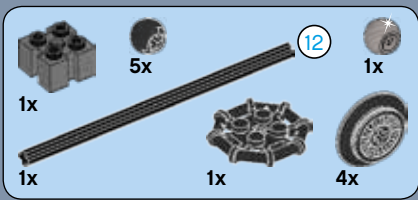

# 91

1

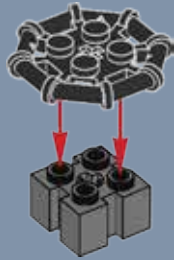

2

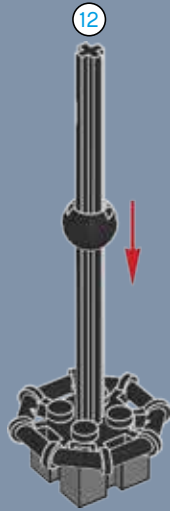

3

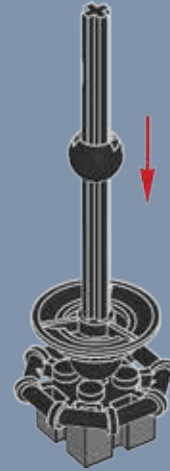

4



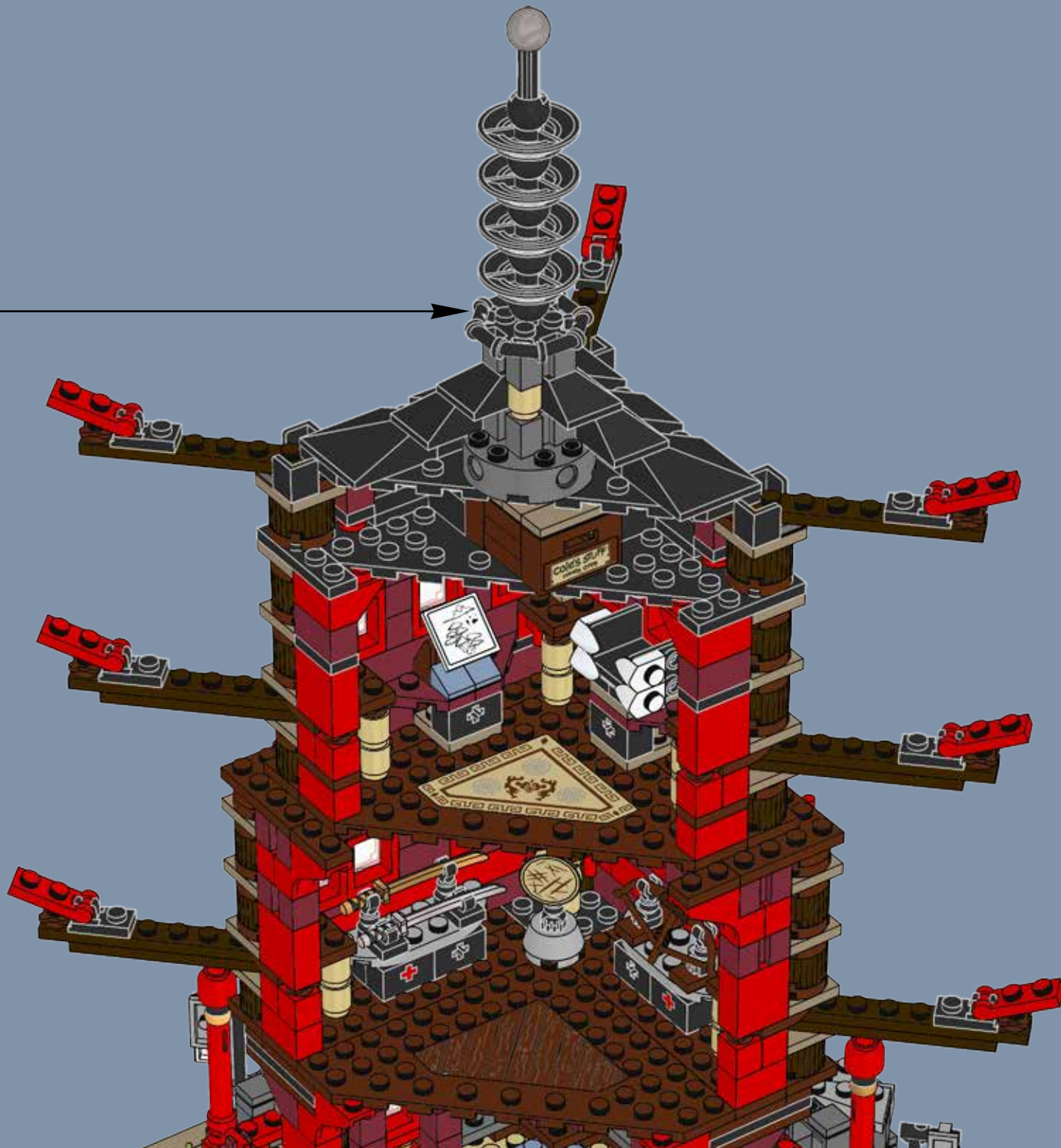





# 92





# 93

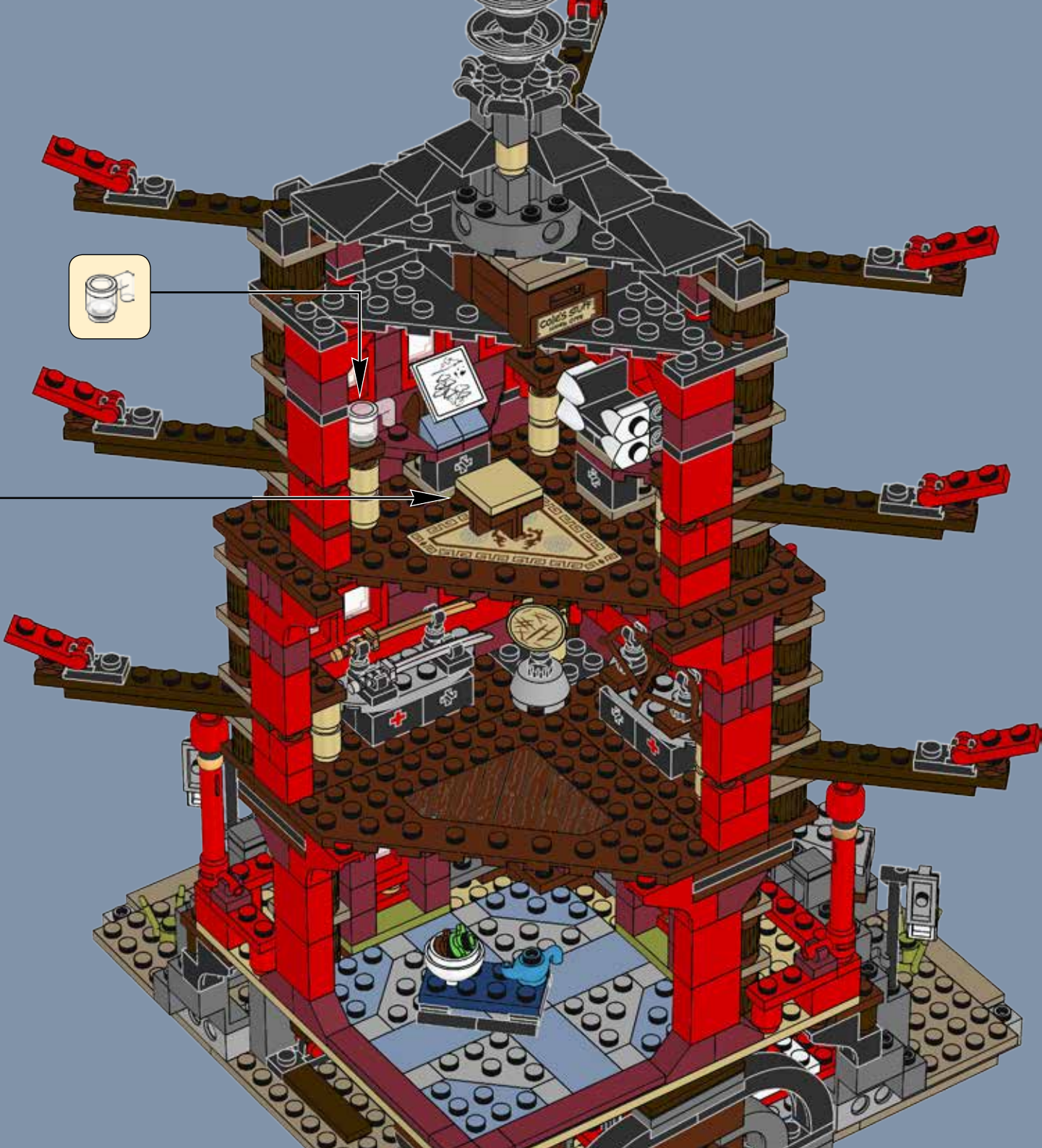
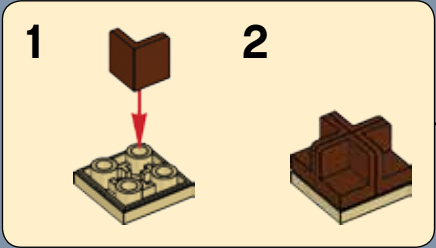



# 94

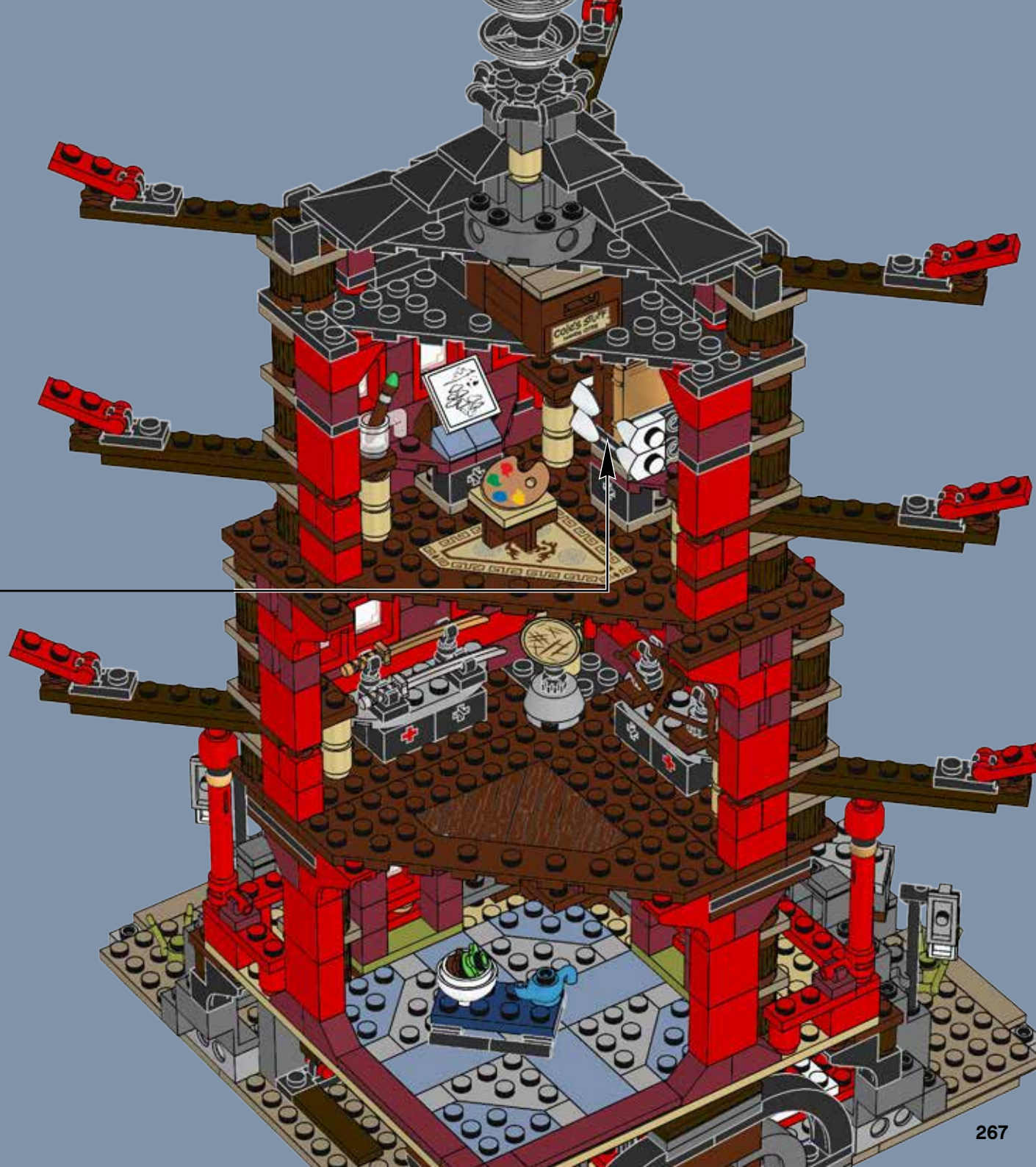
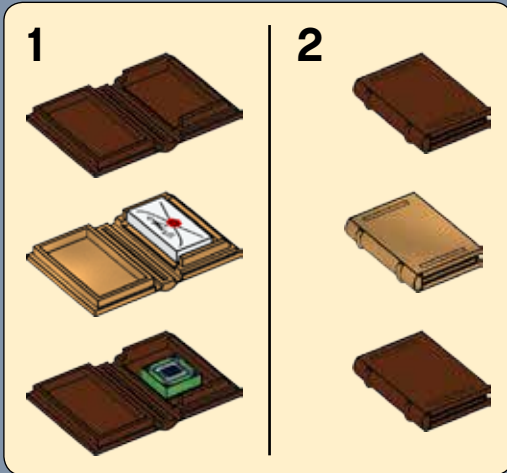



12

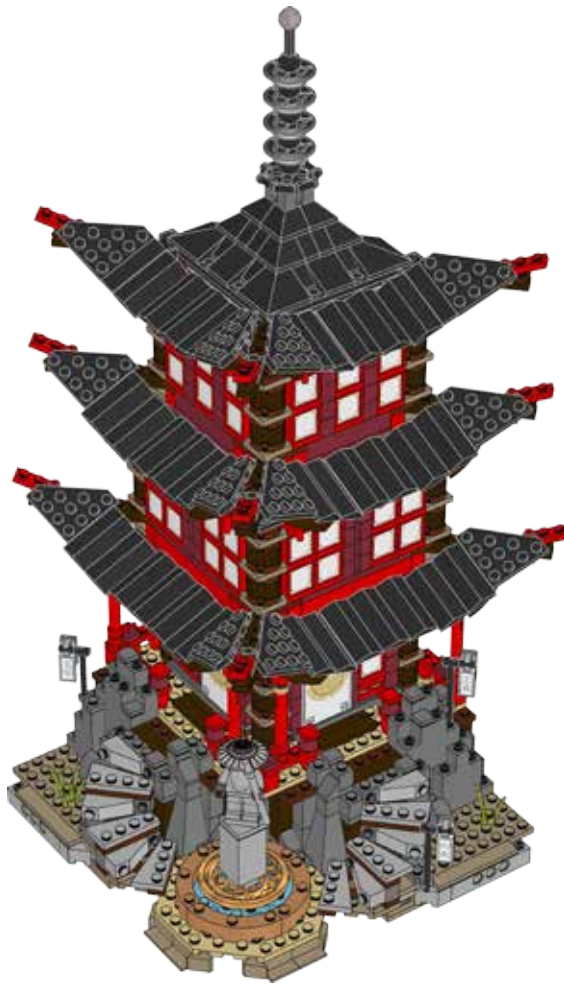

1



2



3



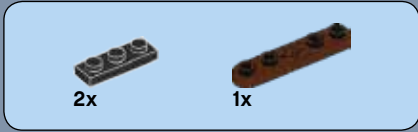
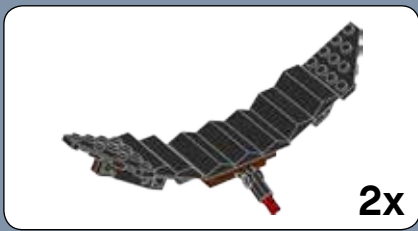

1



2



3

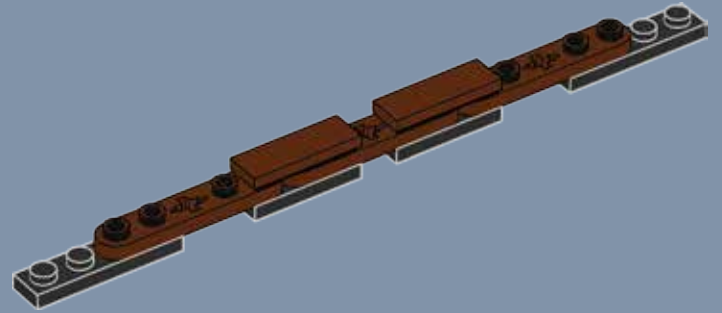

4

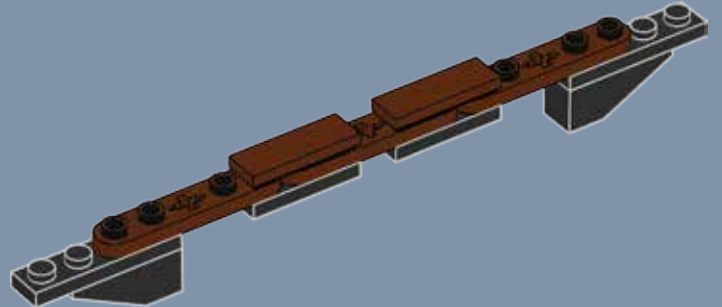

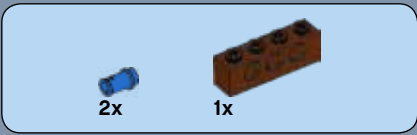

5

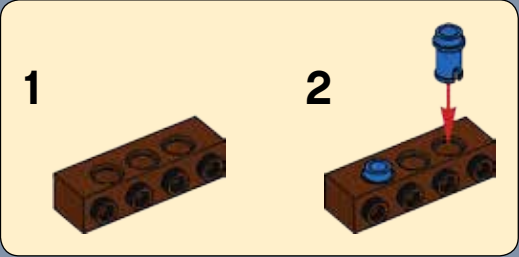
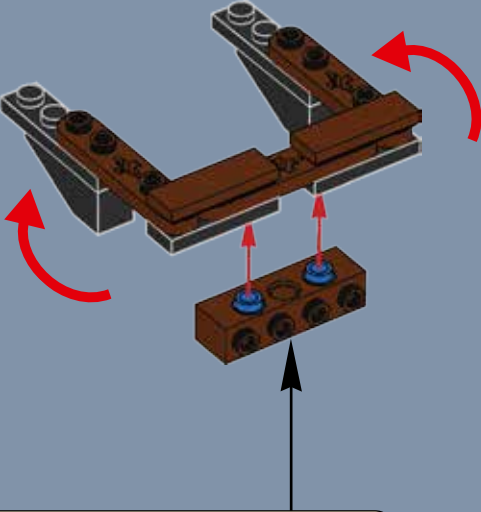

6

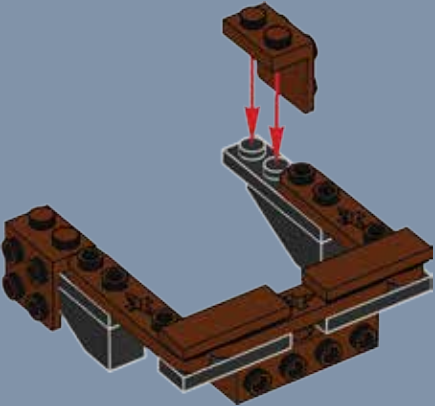

7

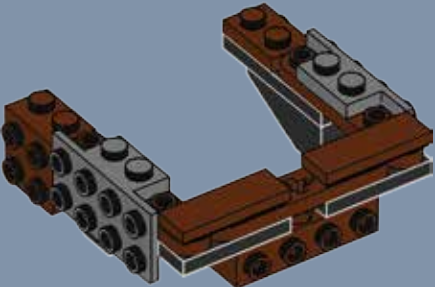



8

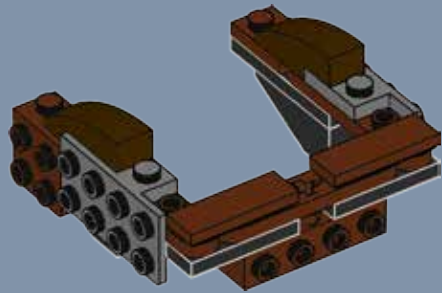

10

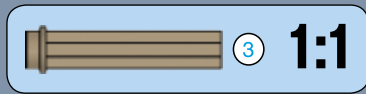
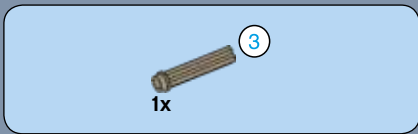
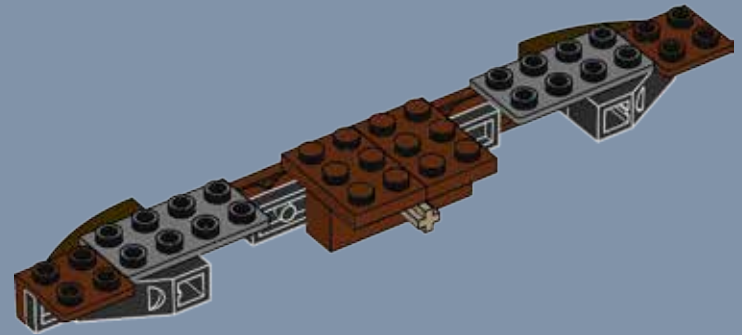

9

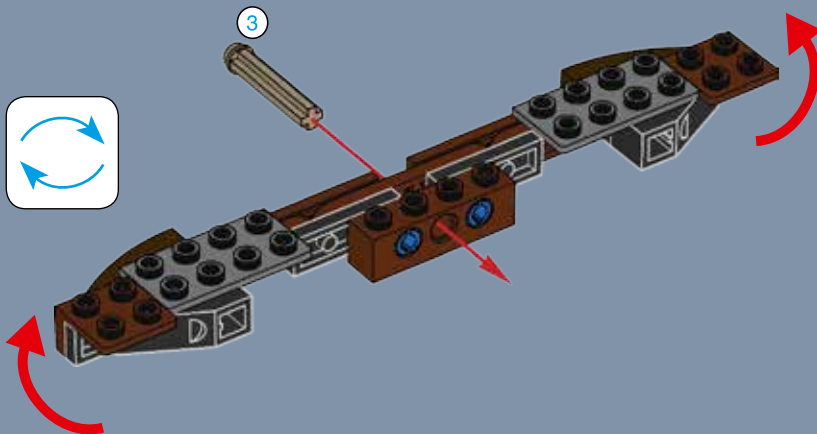

11

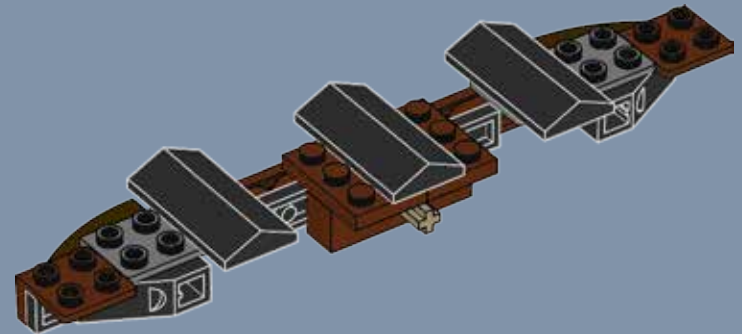



12

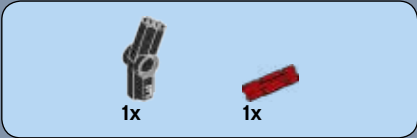
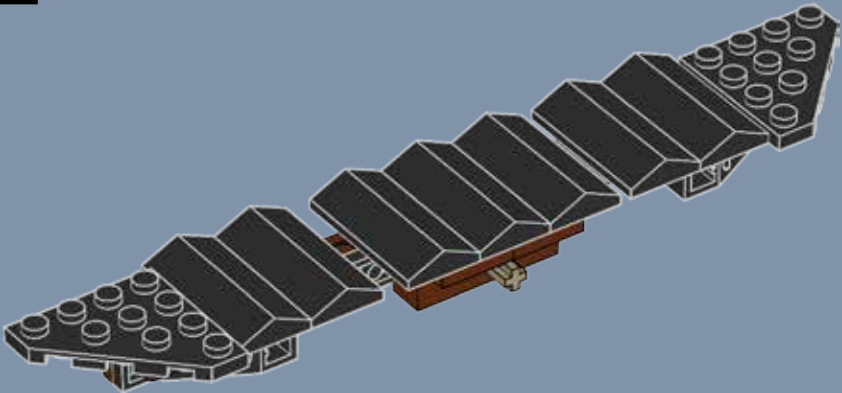

13

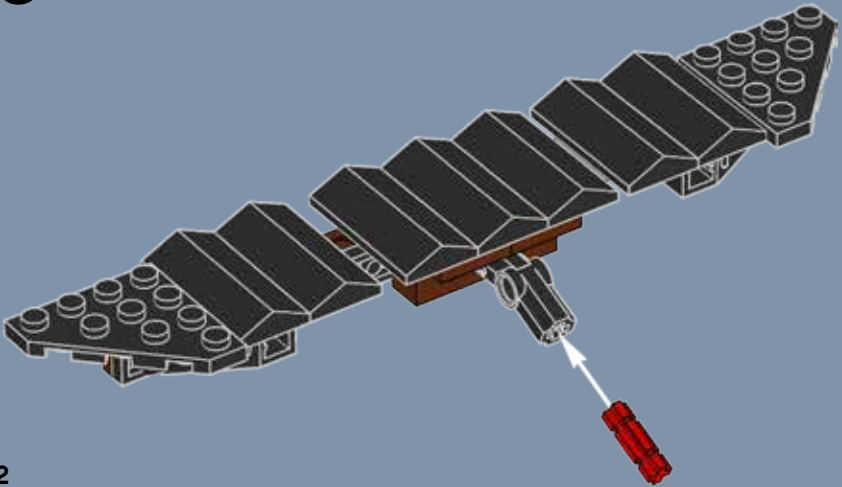

14

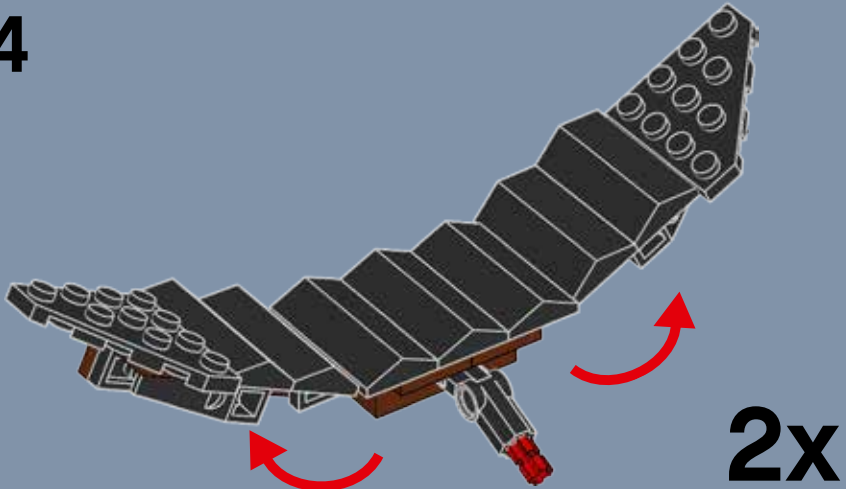



95

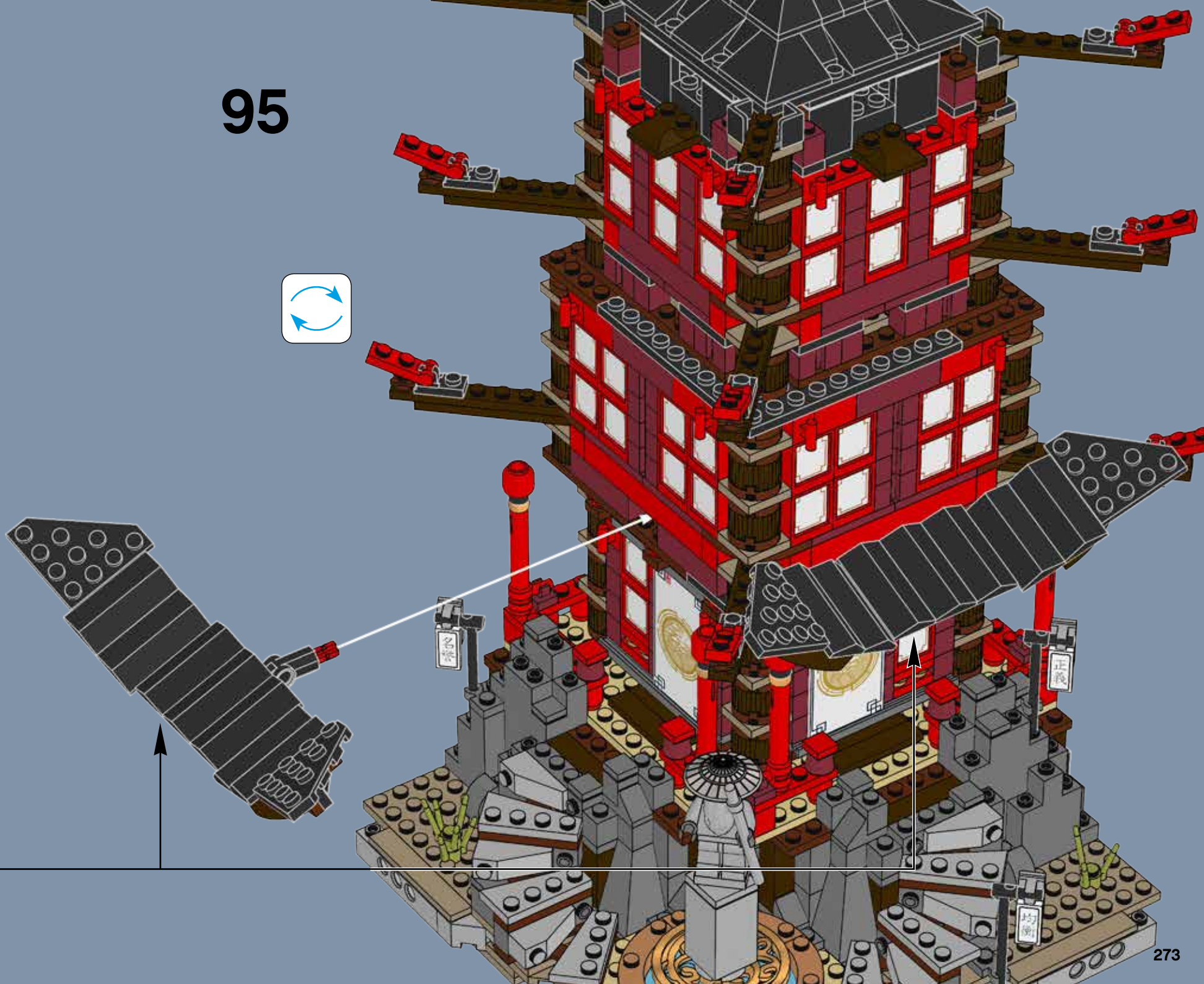

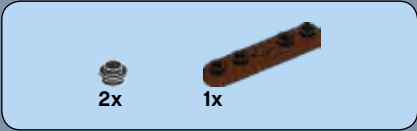
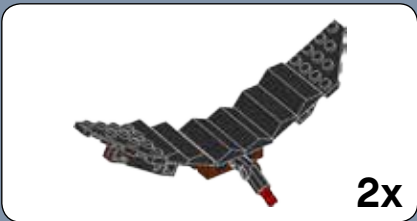

1



2

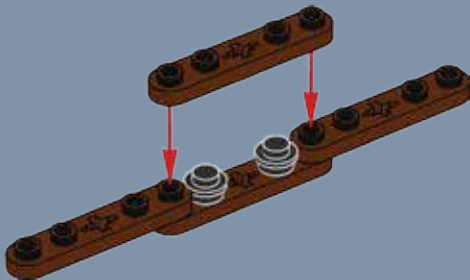

3



4





5

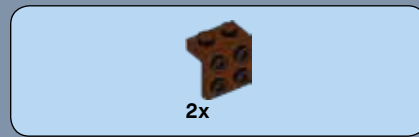
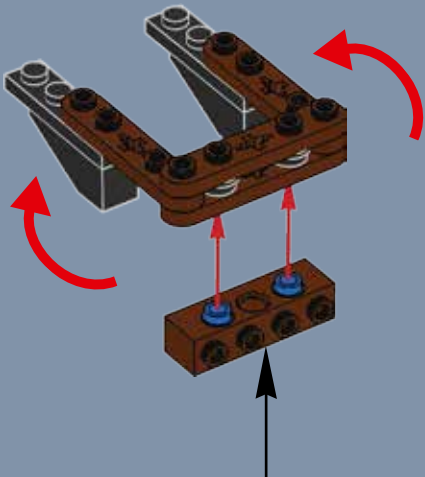

6

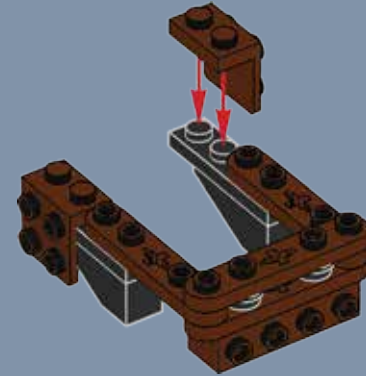

7

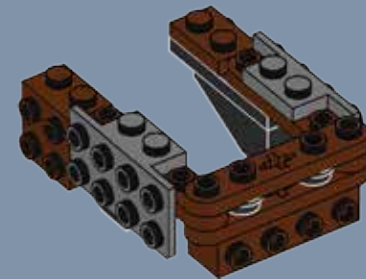



2x

8

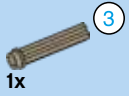
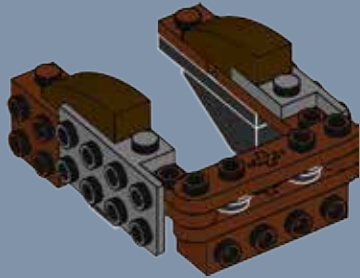

1x

3



3

1:1

9

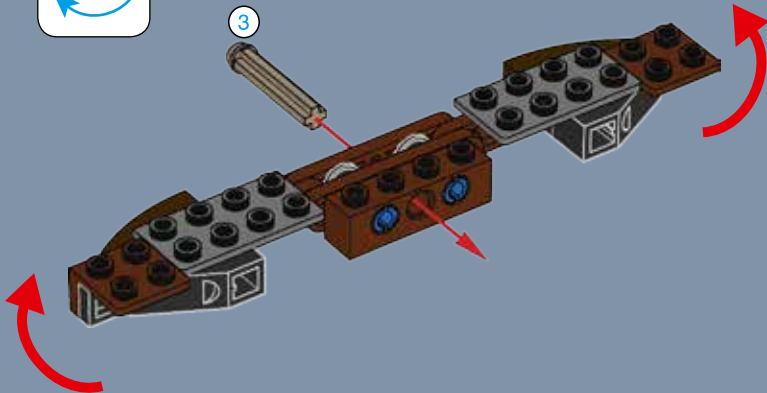

2x

10

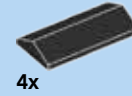

4x

11

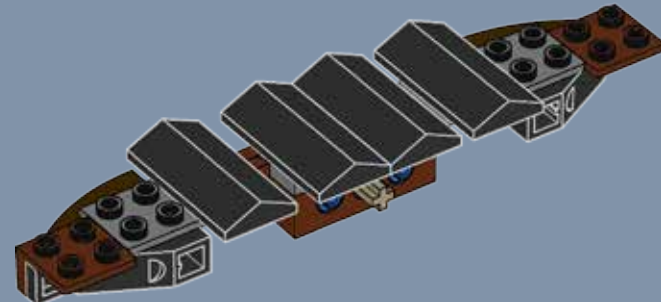



12

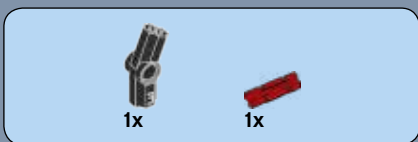
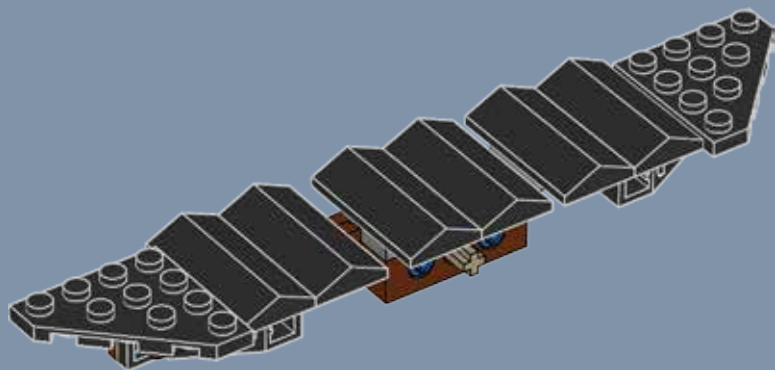

13

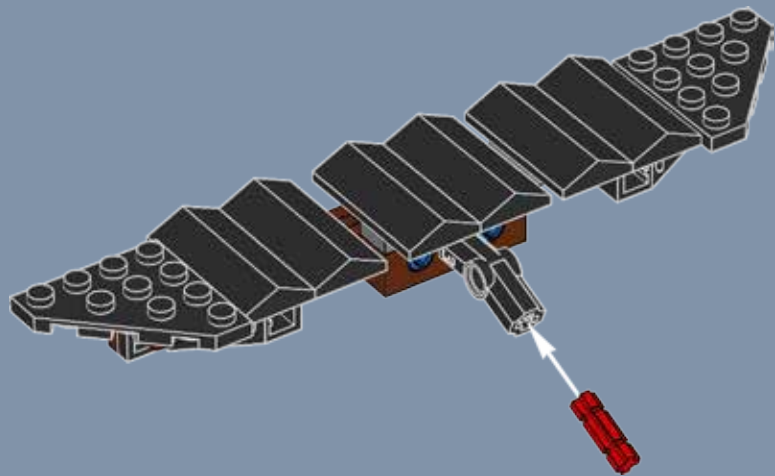

14

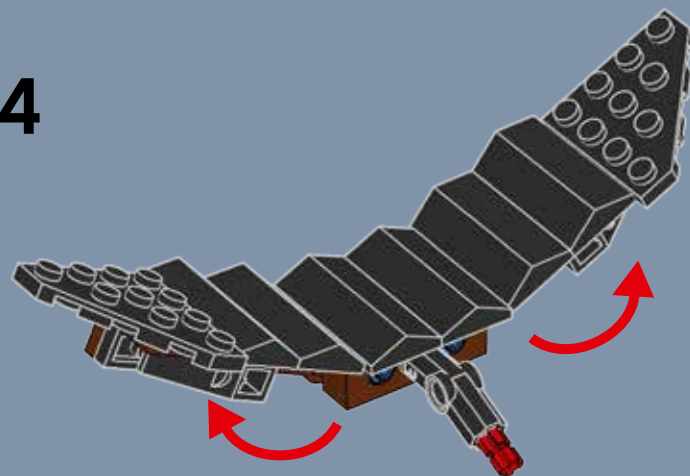

2x

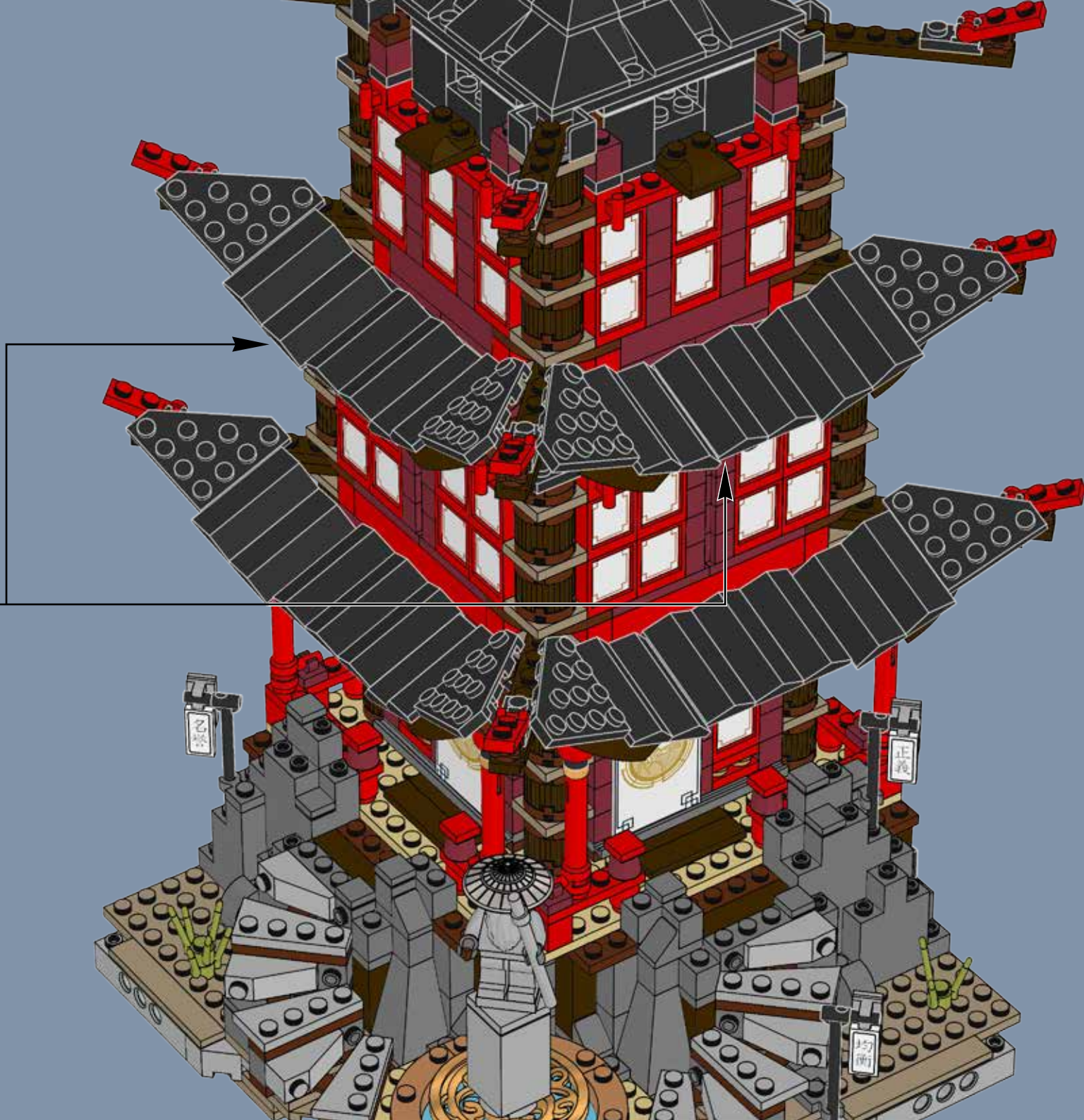

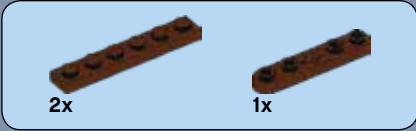

1

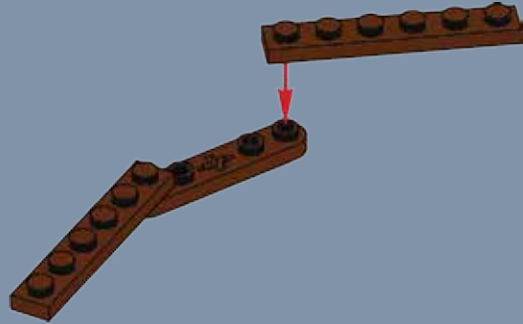

2



3



4

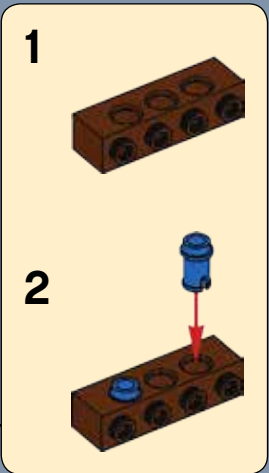
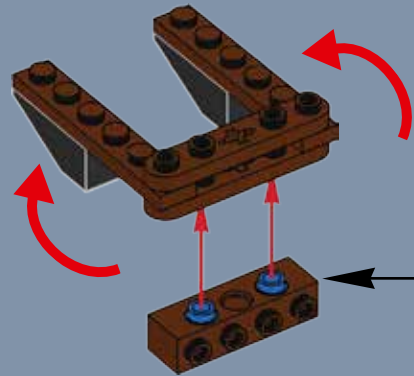

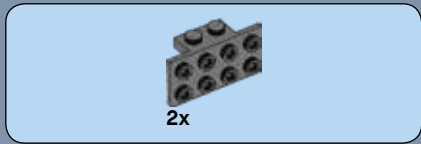

5

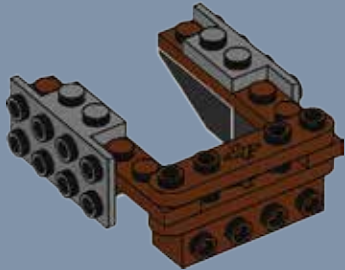

6

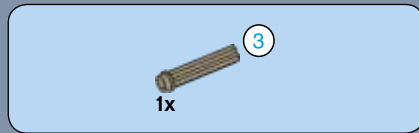
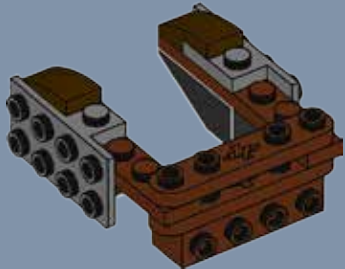

7

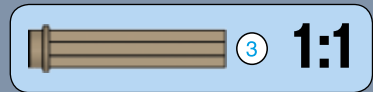
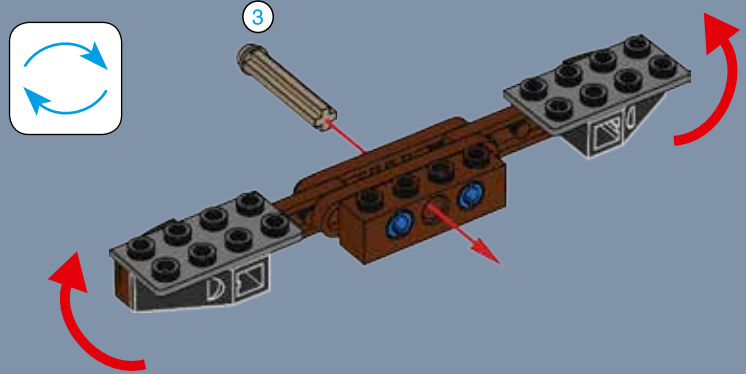

8

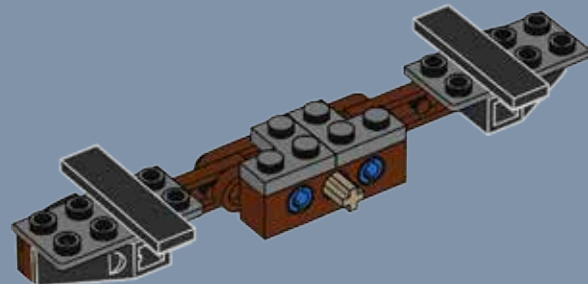





9

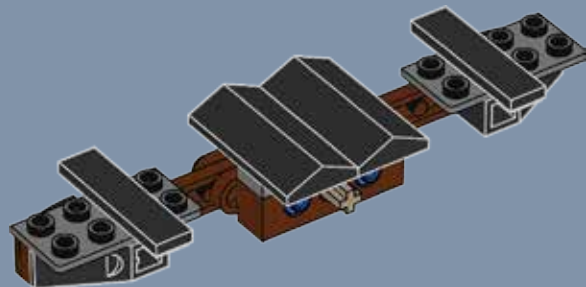

10

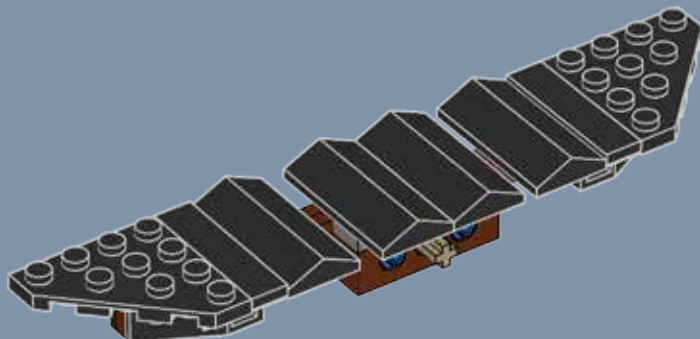

11

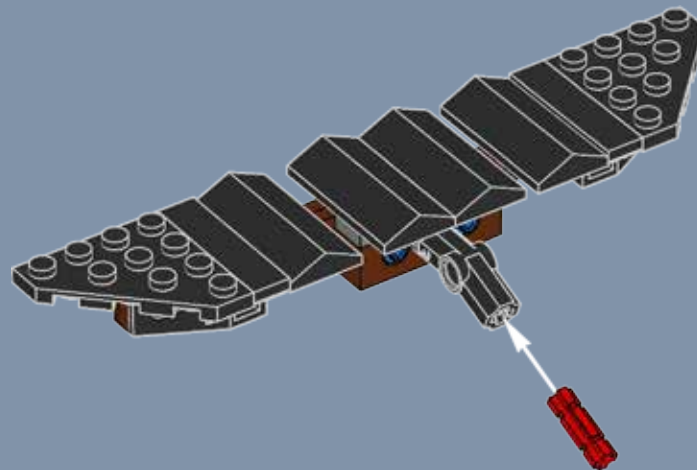

12

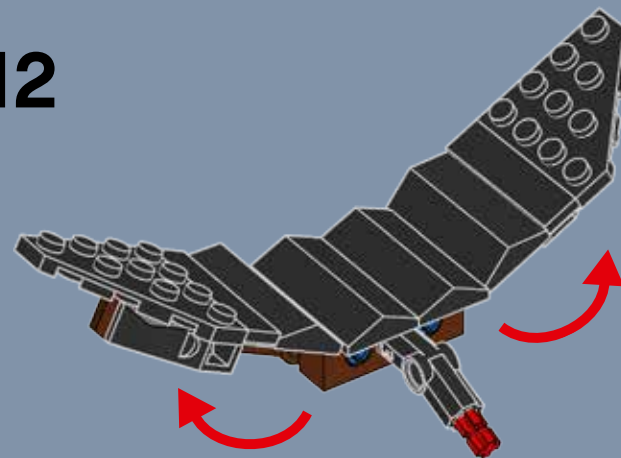

2x

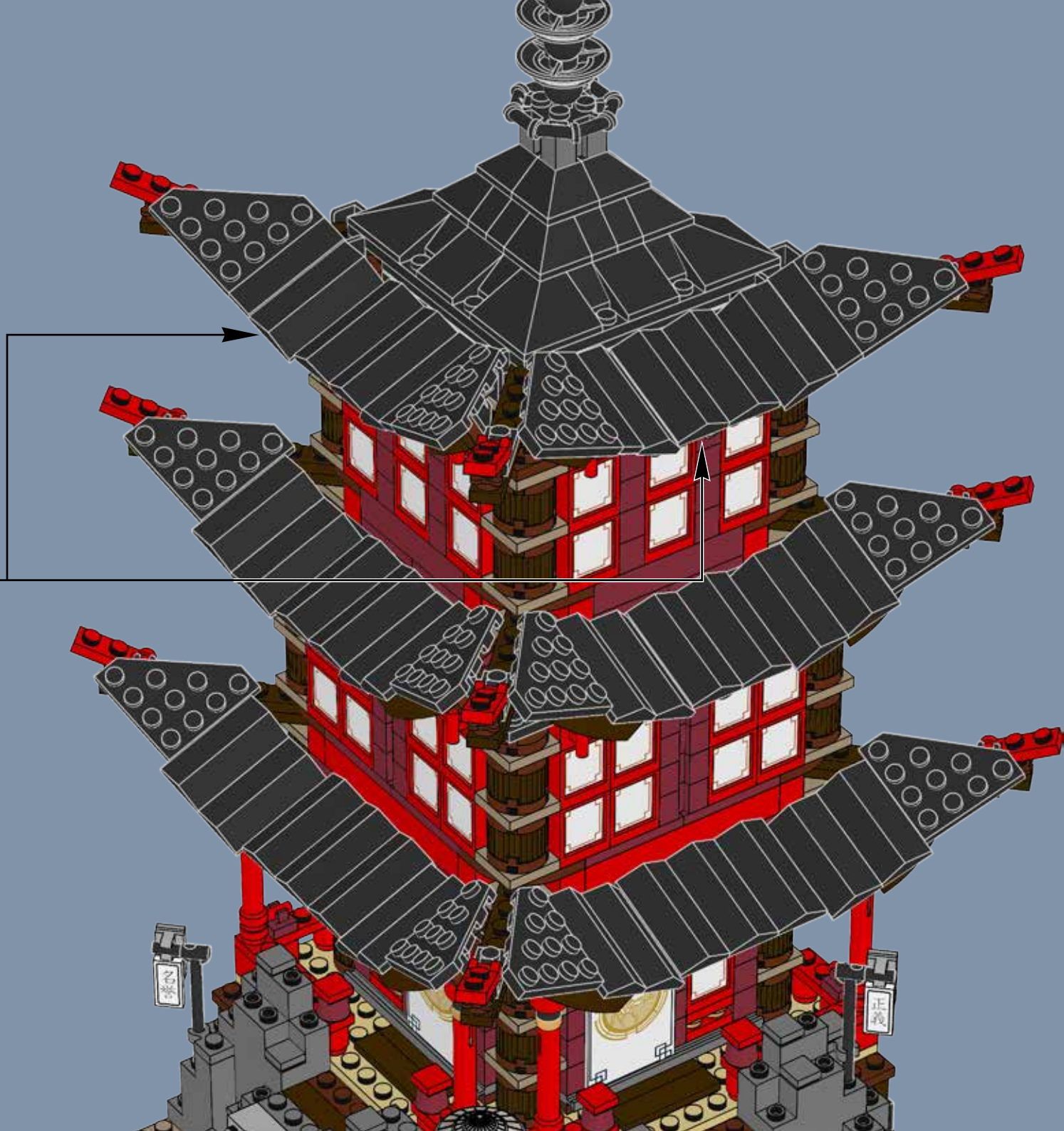

98

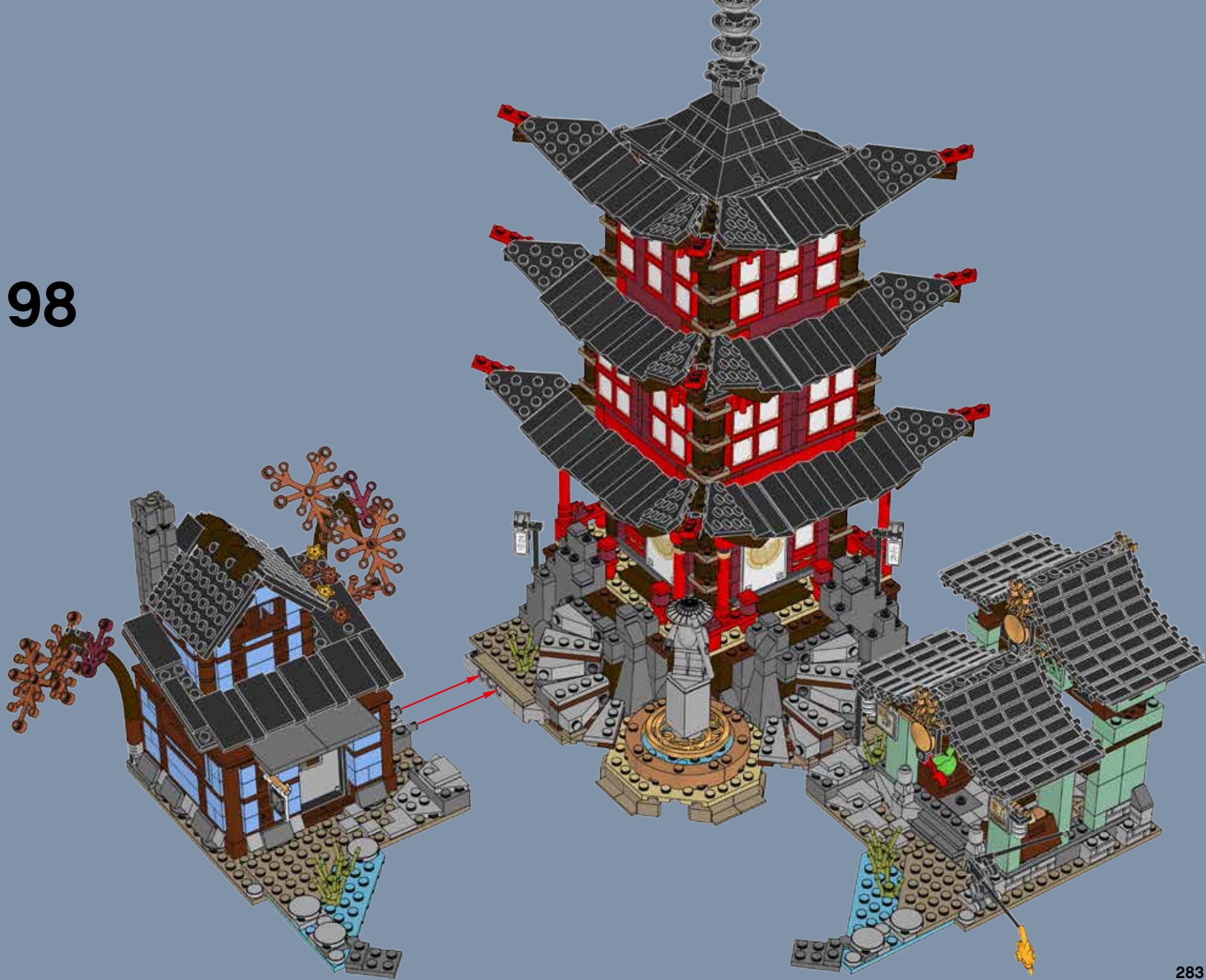



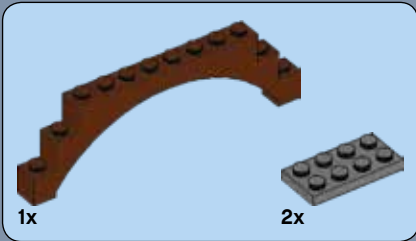

1

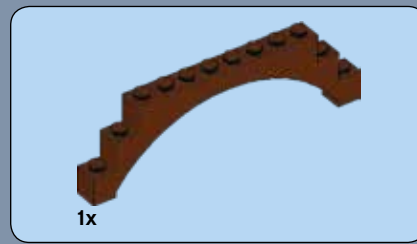
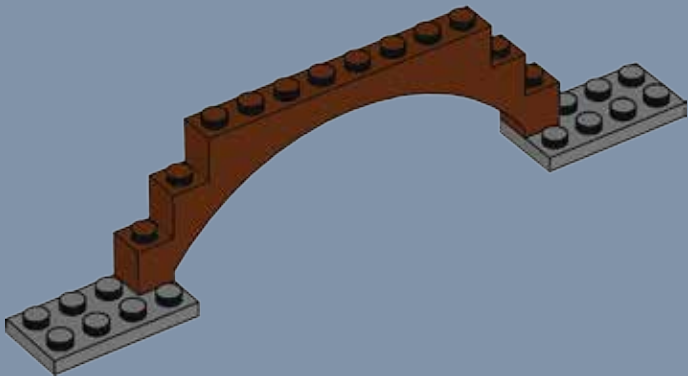

2

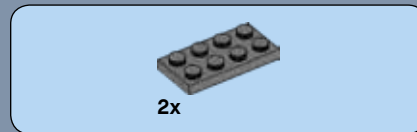
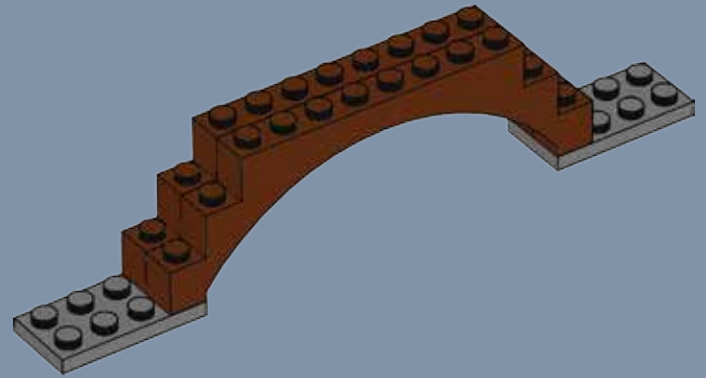

3

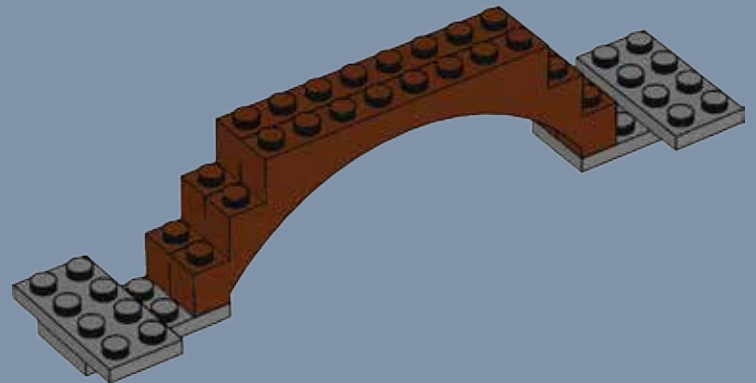

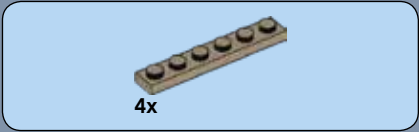

4

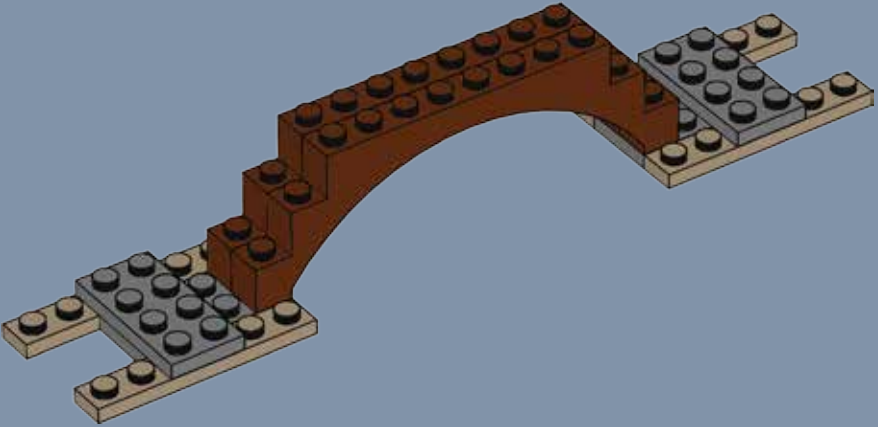

5

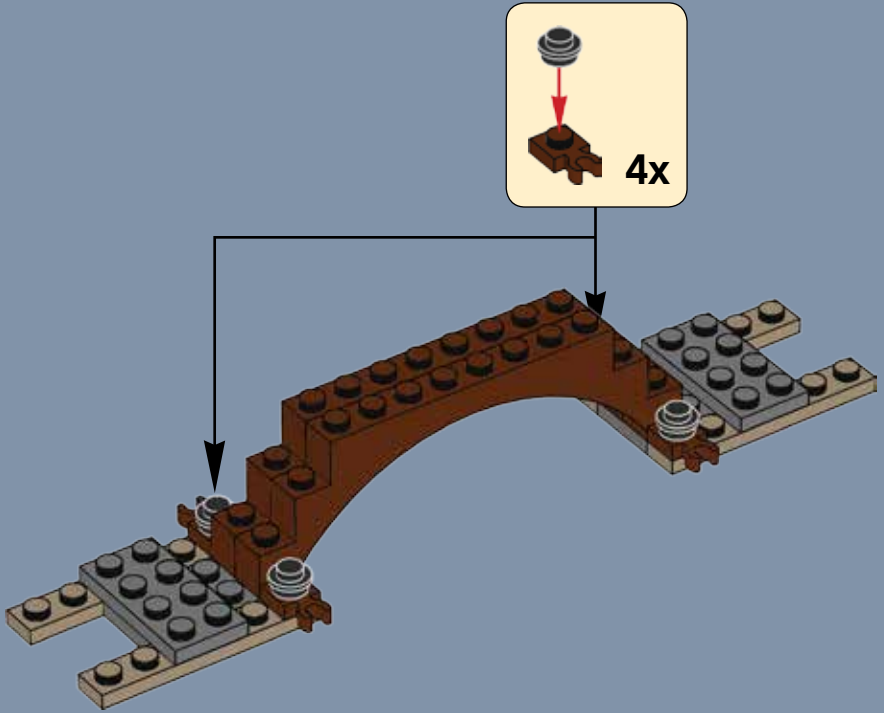



6

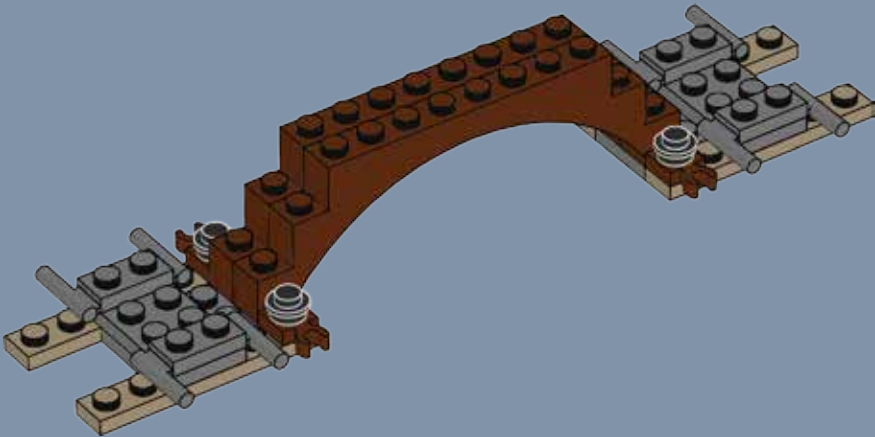

7

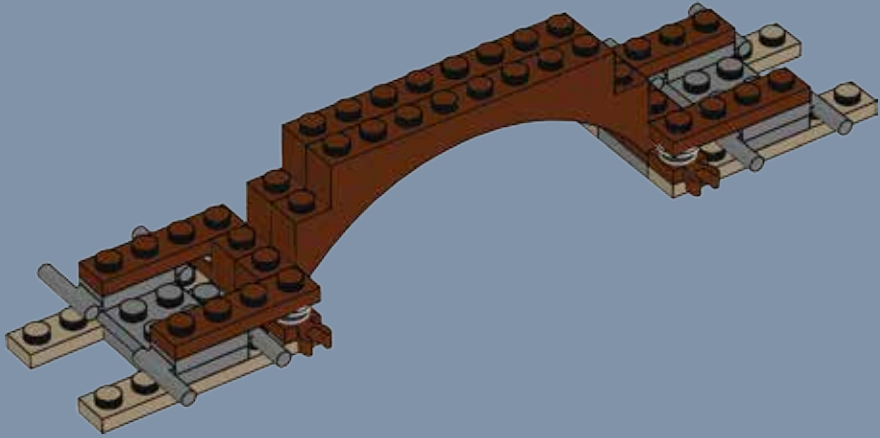

8

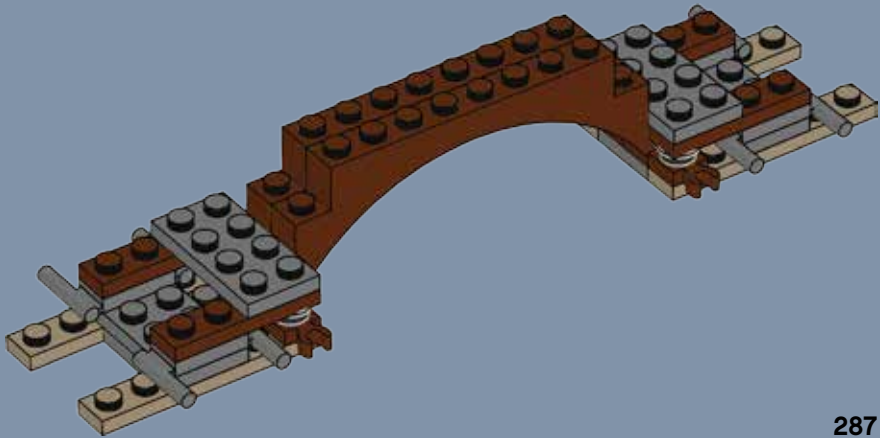



4x

# 9

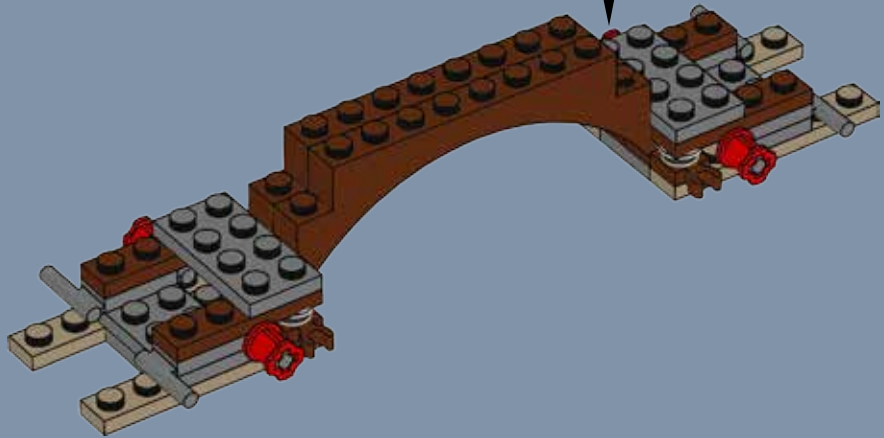

2x

# 10

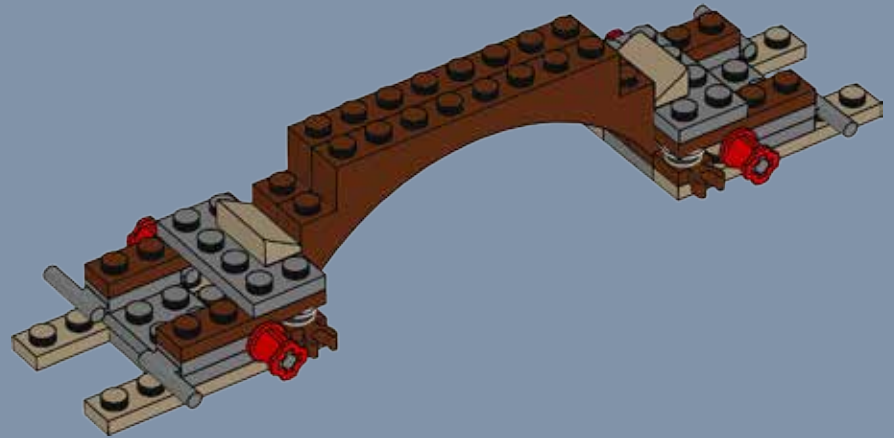



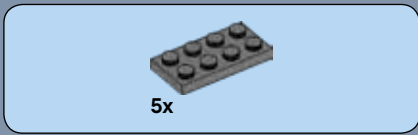

# 11

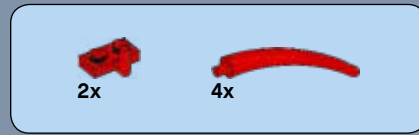
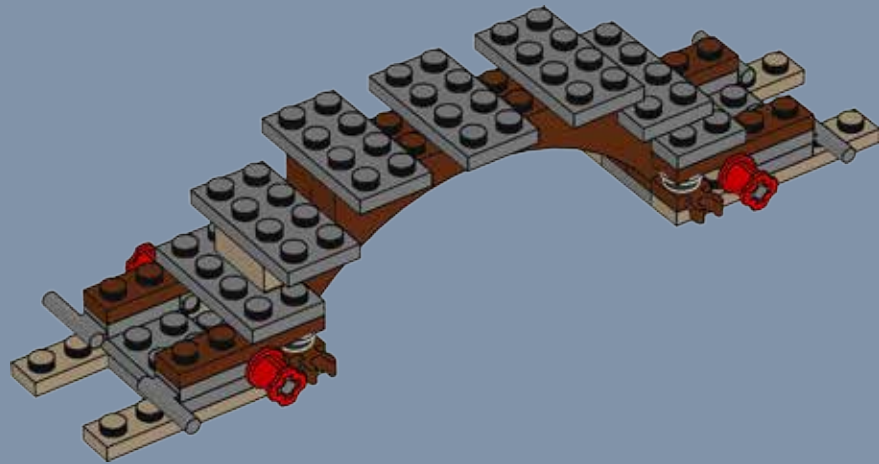

# 12

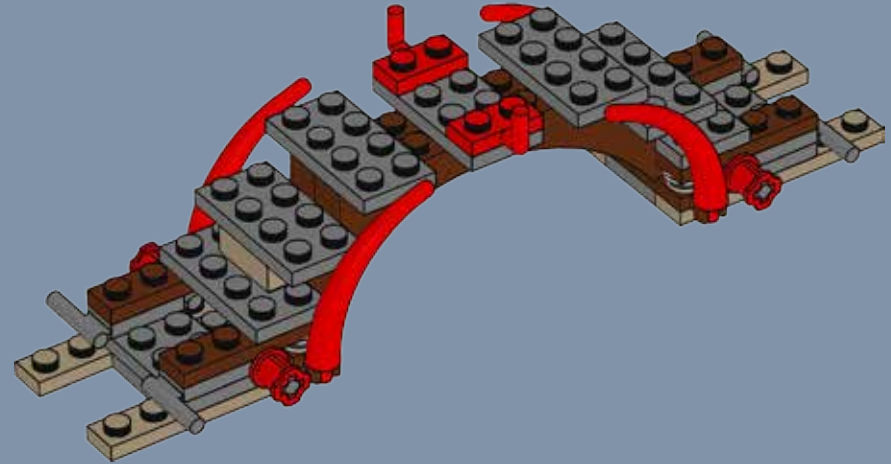

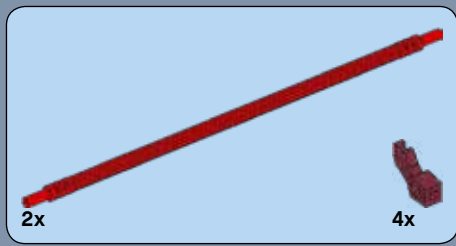

13

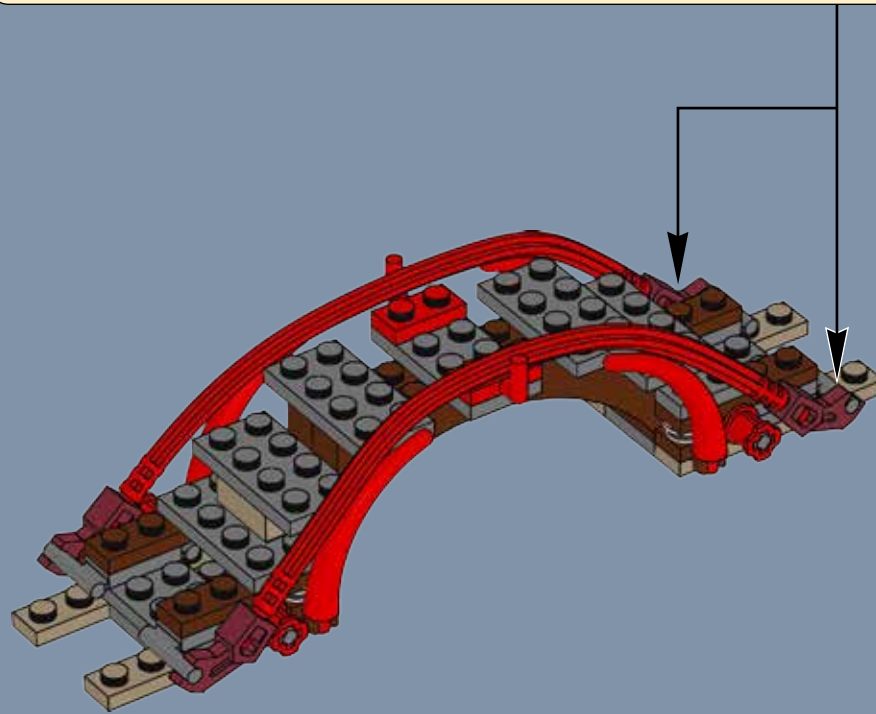
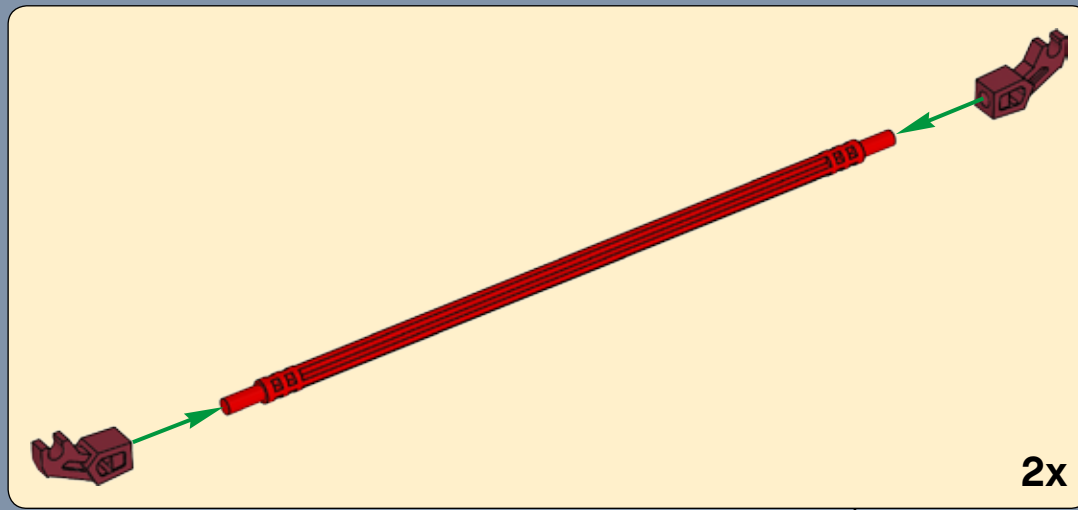



4x

14

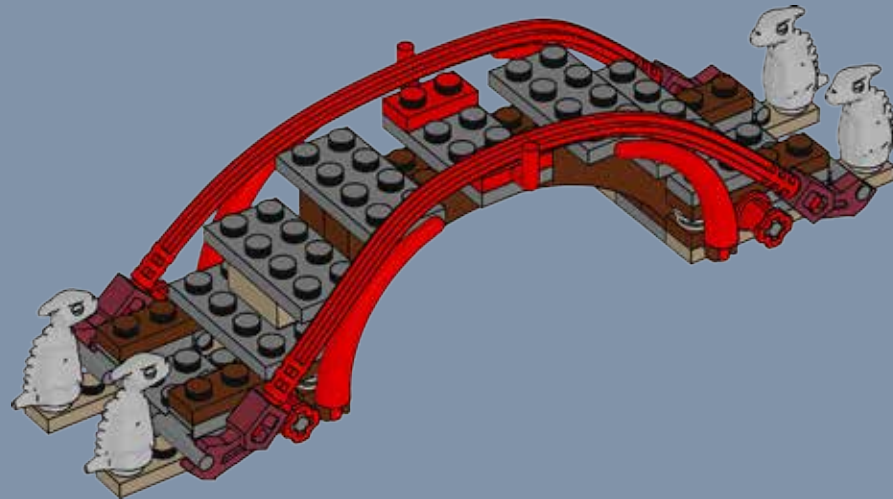

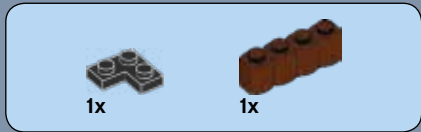

1

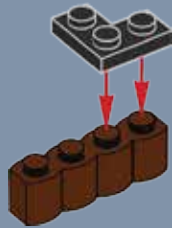

2



3



4

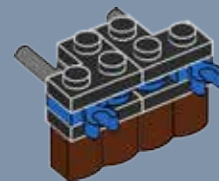

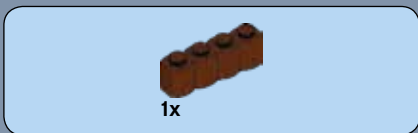

5



6

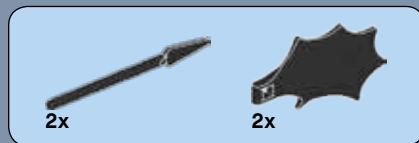
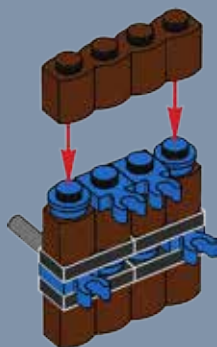

7



8

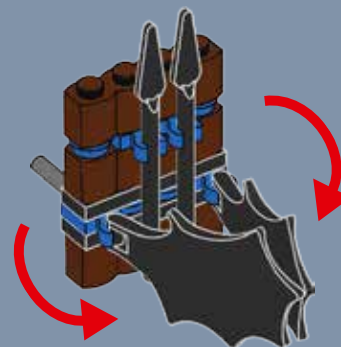

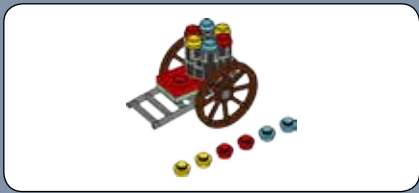

1

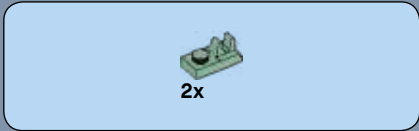

2

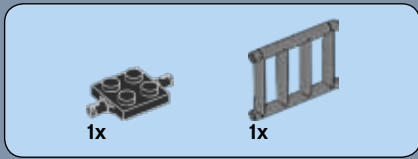
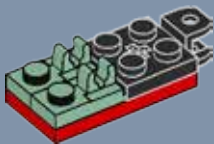

3

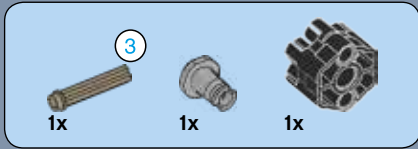
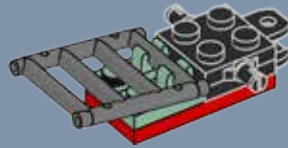

4

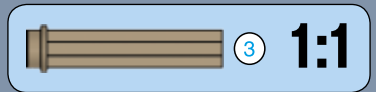
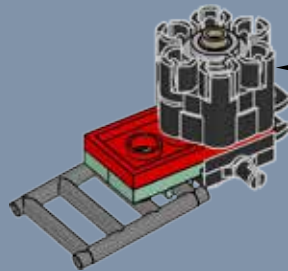
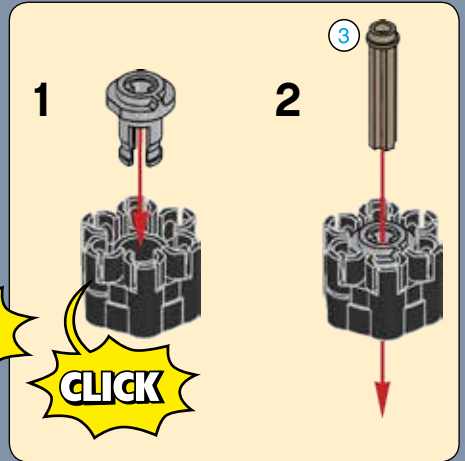

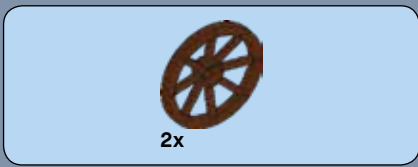

5

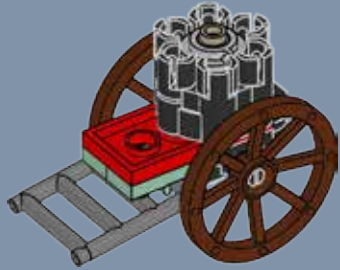

6

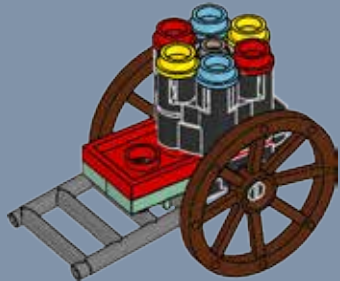

7

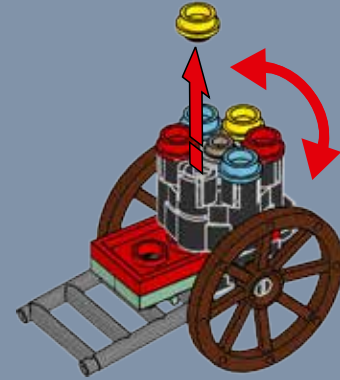

8

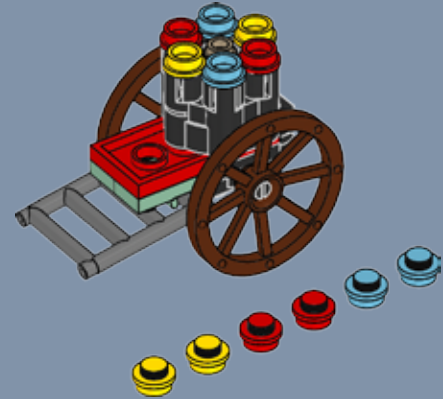

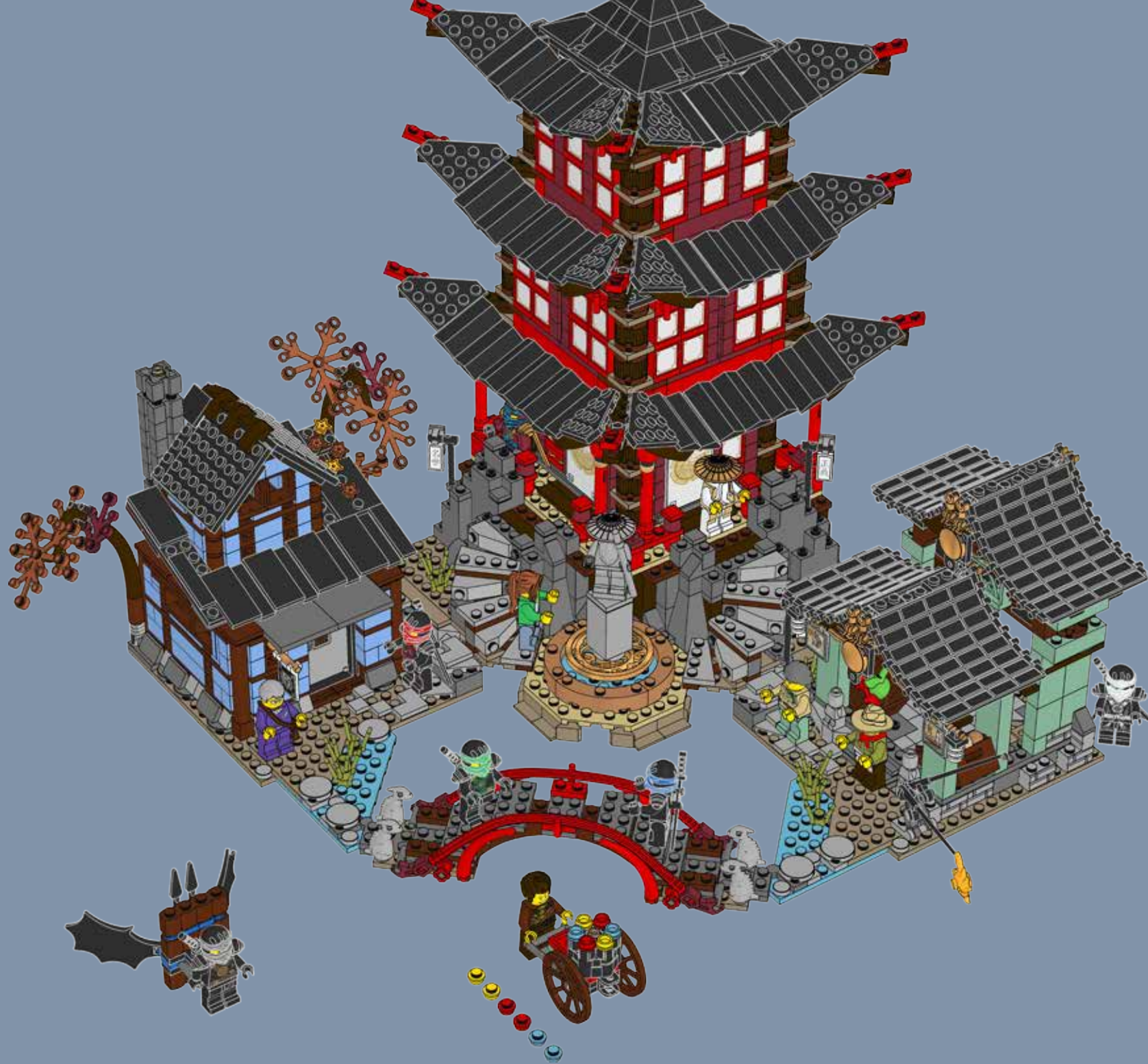









1x 6050914  
1x 6069002  
1x 4119410  
4x 306901  
2x 6058329  
2x 4597131  
1x 4527947  
6x 614101  
1x 6046383  
1x 6011794  
1x 6123750  
1x 4609289  
2x 6063275  
4x 6046905  
1x 4526981

2x 4114064  
15x 4117070  
1x 4179771  
2x 4624086  
1x 4121921  
2x 4118790  
1x 4124067  
1x 6029889  
1x 6013081  
1x 4140562  
1x 6066344  
1x 6037610  
1x 6037610  
1x 4611414

1x 4543858  
1x 6124267  
1x 6123735  
1x 4569547  
1x 4540107  
1x 4582437  
1x 4565452  
1x 6084724  
1x 6055065  
2x 302123  
5x 4613257  
4x 614123  
2x 393723  
2x 368023

16x 4143005  
2x 4206482  
2x 366021  
2x 4500462  
4x 6056816  
4x 307021  
4x 302321  
2x 362321  
2x 371021  
4x 366621  
2x 346021  
2x 4611701  
1x 246021  
11x 4515365  
1x 370921  
2x 373821

8x 6035617  
4x 4173441  
1x 389921  
2x 6054438  
1x 4174747  
1x 4114052  
4x 6018583  
1x 4144413  
4x 4565432  
4x 4227155  
8x 4142865  
24x 292121  
32x 4521438  
8x 614121  
6x 306221  
2x 300821  
2x 4614802

6x 300521  
8x 300421  
8x 4543832  
3x 300424  
1x 306824  
2x 4558172  
4x 614124  
1x 4611426  
1x 6092676  
1x 6057957  
1x 6057958  
1x 6124264  
1x 6123977  
1x 6100203  
1x 6107469  
1x 4651443  
3x 235721

1x 6100249  
1x 6057982  
1x 4544151  
2x 4239601  
7x 362226  
2x 300226  
1x 300926  
1x 6039347  
11x 4233487  
1x 4504382  
10x 6069000  
8x 4121966  
1x 366526  
1x 4163373  
6x 4189064  
12x 428726

4x 329826  
3x 367526  
34x 4529155  
4x 4581280  
2x 6056500  
6x 302326  
4x 6092585  
2x 306826  
7x 302226  
6x 242026  
8x 362326  
14x 371026  
10x 243126  
6x 4560182  
1x 6076678

5x  
6066102

12x  
4598528

2x  
6000650

7x  
6020193

4x  
4183043

5x  
366626

2x  
663626

1x  
4243819

1x  
379526

2x  
395826

1x  
447726

2x  
383226

3x  
4514845

5x  
4529064

2x  
6061032

2x  
383926

1x  
6018805

1x  
4114689

10x  
614126

1x  
4515350

12x  
4160025

4x  
4599461

6x  
4106347

4x  
4593678

1x  
4535834

34x  
4582536

4x  
395726

3x  
4623113

1x  
6117412

1x  
6117007

1x  
6117002

1x  
6117729

1x  
6117277

1x  
6117061

1x  
6117066

1x  
6117082

1x  
6117084

1x  
6117211

1x  
6113986

1x  
6113987

1x  
6113991

1x  
6113995

1x  
6113079

5x  
6038453

2x  
4286122

1x  
4106552

1x  
434926

1x  
452226

1x  
6043130

5x  
6116592

2x  
449726

1x  
6020192

5x  
6116639

2x  
4277967

1x  
460026

4x  
4621116

2x  
4289538

2x  
4532220

3x  
4143372

6x  
4124096

5x  
4286267

1x  
4563044

6x  
4107082

3x  
4121715

1x  
370526

2x  
373726

1x  
370826

1x  
6100104

1x  
6100844

1x  
4619599

1x  
4107050

5x  
6039193

1x  
4614107

3x  
6035618

32x  
6120263

2x  
6101944

1x  
626440

4x  
4626883

1x  
4527526

6x  
4179825

3x  
4168345

18x  
4179830

17x  
4179833

10x  
6000880

10x  
4163696

2x  
4649756

4x  
6015452

6x  
6015424

2x  
4507047

2x  
4616574

2x  
4246957

4x  
6030845

2x  
6006524

2x  
6096215

1x  
6118917

3x  
4613196

2x  
6015449

4x  
6093064

6x  
4578032

33x  
6047415

1x  
4550168

4x  
6005897

1x  
4626884

1x  
4623481

1x  
4654448

17x  
4183133

2x  
6062686

4x  
6124349

4x  
6051596

1x  
4267425

4

8

12



2x 4598955  
8x 6031821  
2x 4528488  
1x 6036240  
1x 4667595  
5x 4521948  
4x 6075623  
6x 6075621  
4x 6075626  
2x 4625236  
1x 6097680  
1x 4206504  
20x 4541376  
30x 4539102

6x 6052777  
2x 4541528  
16x 6070691  
2x 4590811  
4x 4541526  
3x 4550169  
4x 4539061  
2x 4650865  
4x 6071222  
4x 4539064  
2x 6024916  
1x 6116780  
1x 6117079  
4x 4549992  
1x 6113999  
4x 6006738

2x 6107894  
1x 4539091  
1x 4649066  
2x 4261397  
1x 4243668  
2x 6017001  
1x 6005772  
3x 4211181  
1x 4211225  
12x 4225469  
8x 4211183  
4x 4520612  
2x 4211252  
7x 4267994  
2x 4211195

1x 4658005  
4x 6066142  
1x 4211219  
2x 4211288  
3x 4224243  
4x 6092590  
17x 4211150  
17x 4211257  
6x 4216695  
1x 6050918  
4x 6100769  
7x 4211152  
6x 4211189  
8x 4211190  
4x 4579690  
4x 4211186  
8x 4221590

4x 6096379  
3x 4243838  
1x 4211247  
2x 4211211  
8x 4223683  
7x 4211214  
1x 4225715  
1x 6058247  
11x 6117976  
5x 6123759  
20x 6035580  
25x 4216581

64x 4211159  
1x 6102360  
6x 4283660  
6x 6084573  
2x 4224732  
2x 6107938  
4x 4645400  
1x 6058084  
5x 4595814  
2x 6092659  
19x 4623429  
1x 4520638  
2x 4211163

2x 4533101  
3x 4211185  
1x 6116613  
1x 6123948  
1x 6047551  
1x 4610041  
1x 6121728  
2x 4211279  
2x 4598334  
3x 6055781  
11x 6000066  
1x 4211650  
2x 6028811

1x 6028324  
4x 4651063  
1x 4527767  
2x 4211848  
6x 4521921  
6x 4211488  
14x 4211415  
13x 4211398  
3x 4211414  
2x 4565393  
2x 4211397  
19x 6065824  
2x 4211396  
2x 4599498  
3x 4598526  
1x 4244627

2x 4666449  
1x 4211444  
8x 4650260  
3x 4211735  
3x 4211732  
5x 6052200  
1x 4211475  
4x 4507056  
4x 4211361  
2x 6105964  
1x 6065151  
1x 6078211  
1x 6078212  
1x 4211503

2x 6011817  
1x 6081975  
2x 4558465  
1x 4227657  
1x 4292298  
1x 4211585  
1x 6075237  
1x 6057487  
1x 6002762  
4x 6109356  
1x 4512743  
2x 4540203  
1x 4211815  
1x 4211639  
1x 6121787  
1x 6097090

3

5

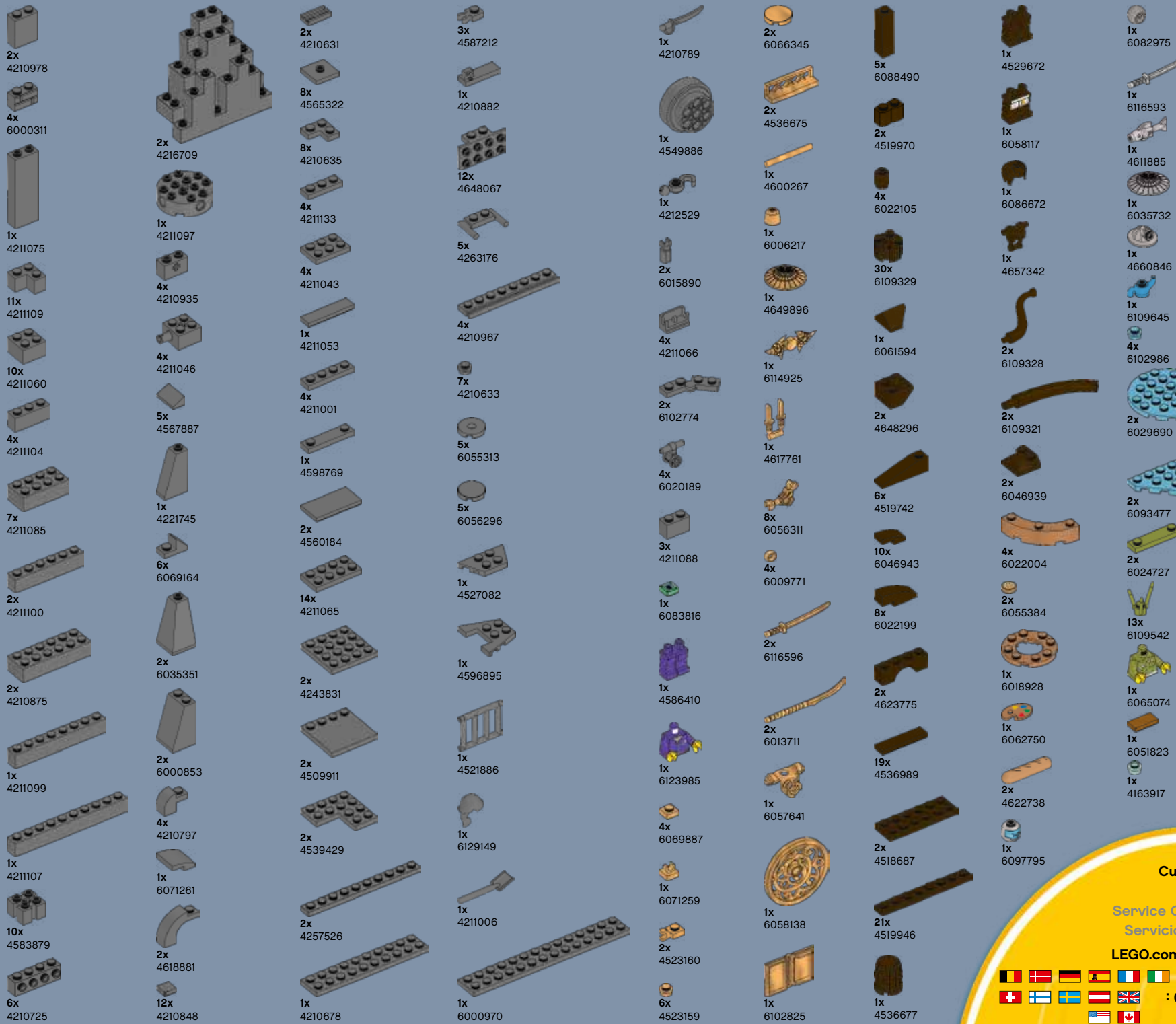

**Customer Service**  
 Kundenservice  
 Service Consommateurs  
 Servicio Al Consumidor  
[LEGO.com/service](http://LEGO.com/service) or dial  

 : 00800 5346 5555  
 : 1-800-422-5346