



NINJAGO

Masters of Spinjitzu



70622



7

LEGO.com/NINJAGO



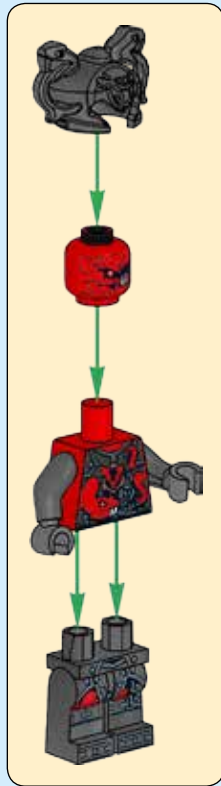

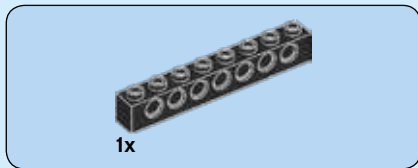
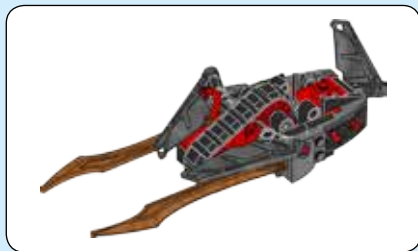

1x

1

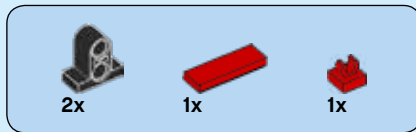
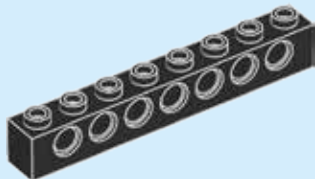

2x

1x

1x

2

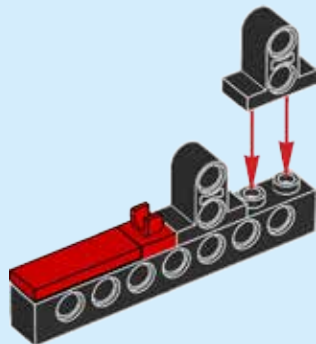



2x

3

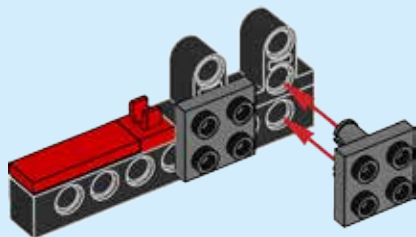

4



1x



1x



1x

4

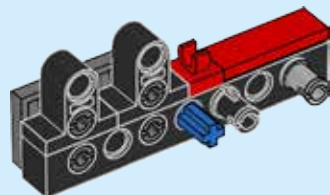
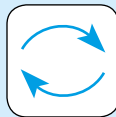



2x

5

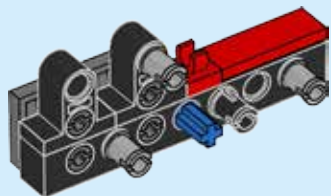

1x



1x

6

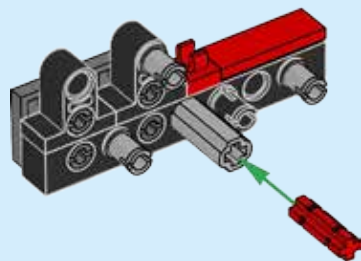



7

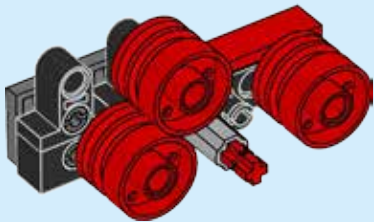

6

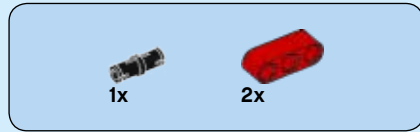

8

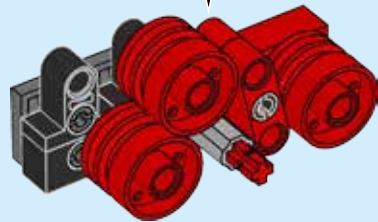
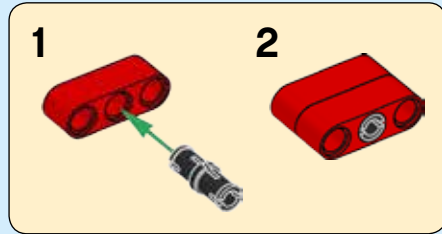



1x



3x

9

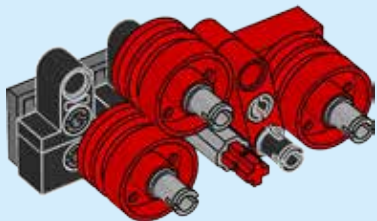

1x

10

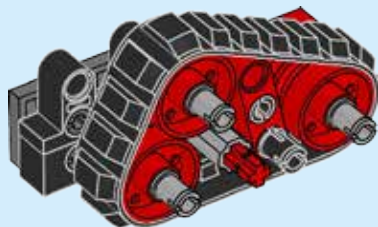

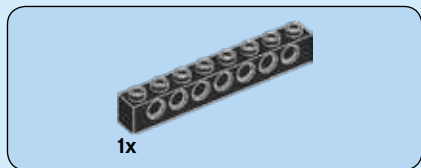

11

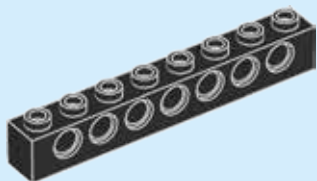

8

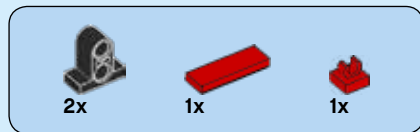

12

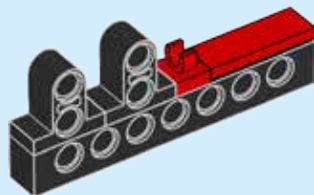



2x

13

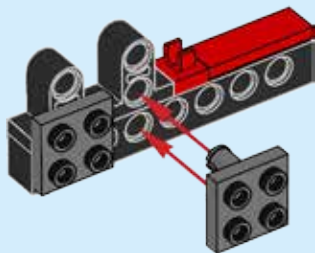

14

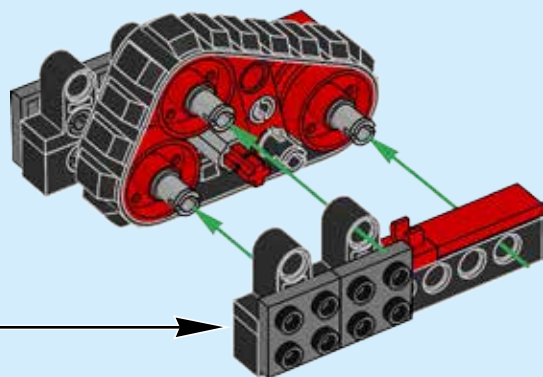



1x

15

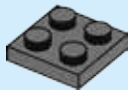

2x

16





1x



1x

17

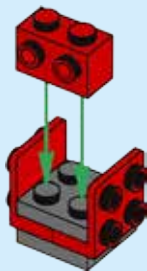

1x



2x



1x

18

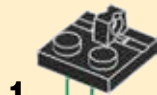

1



2



3

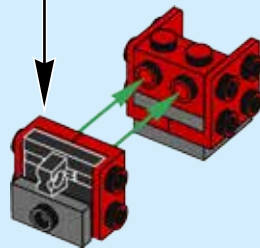



1x

19

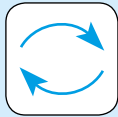

1x



1x

20

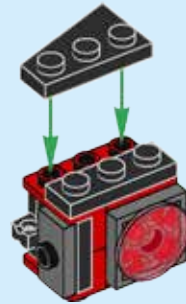

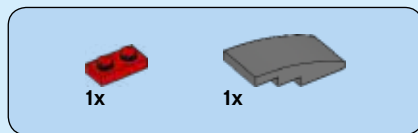

21

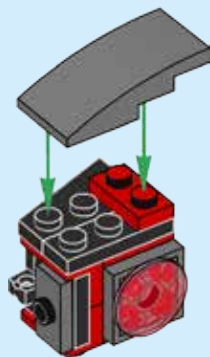

22

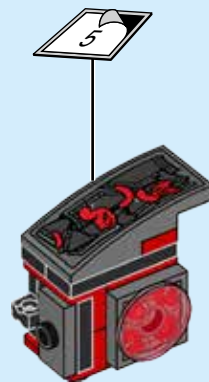

23

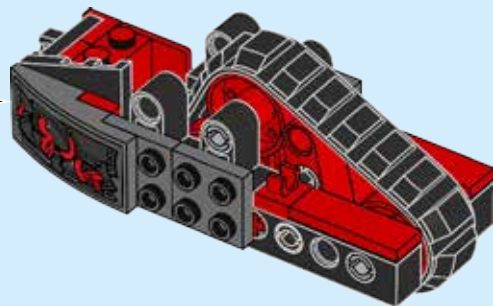

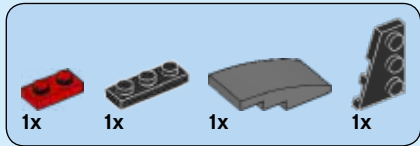

24

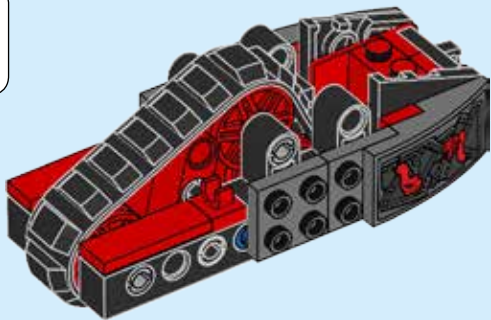
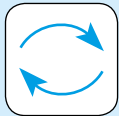
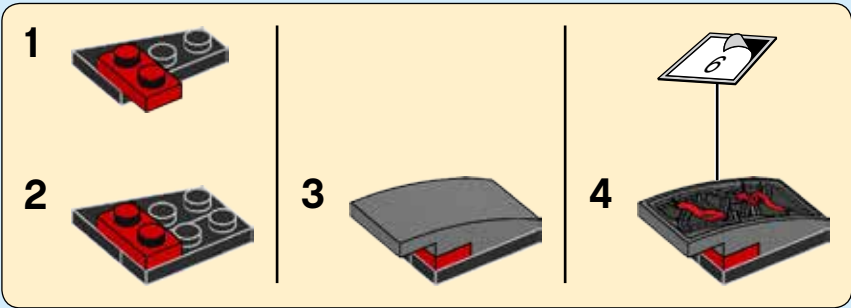

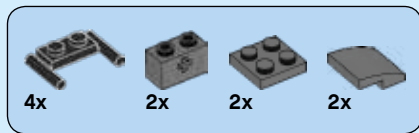

25

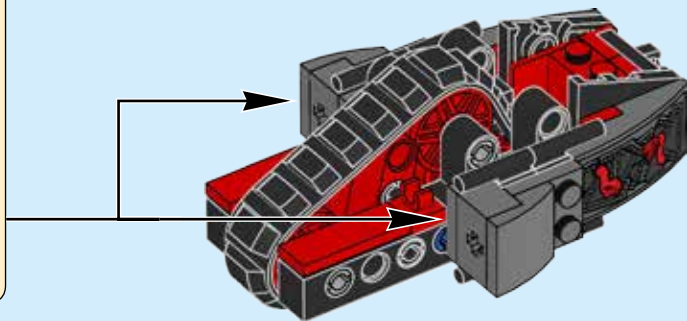
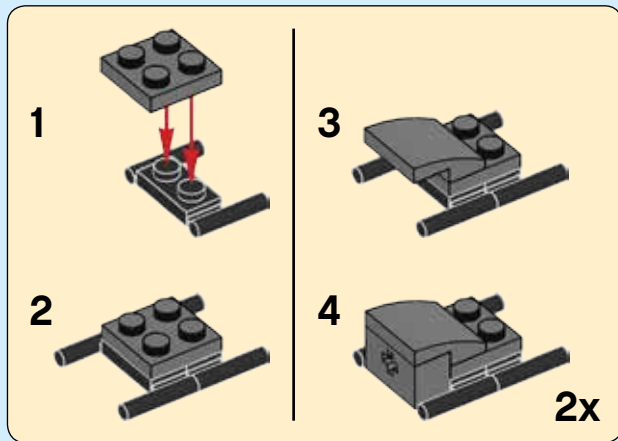



26

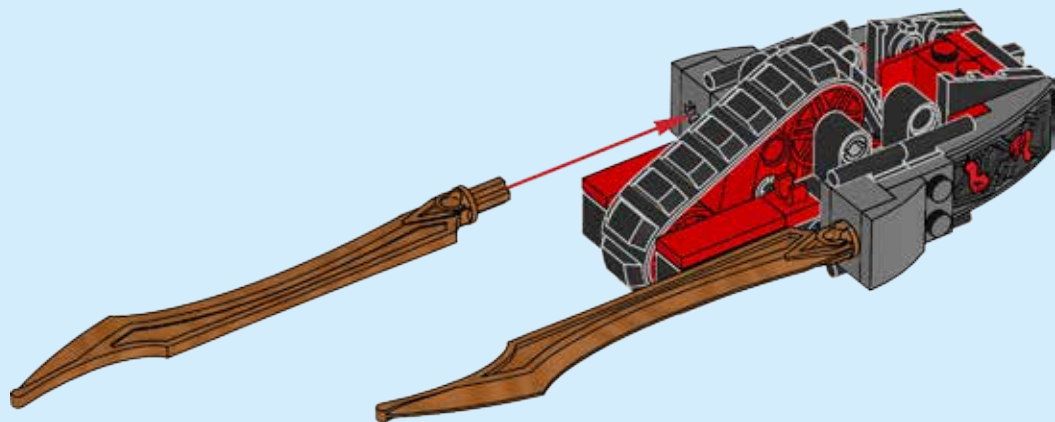



2x

27



2x

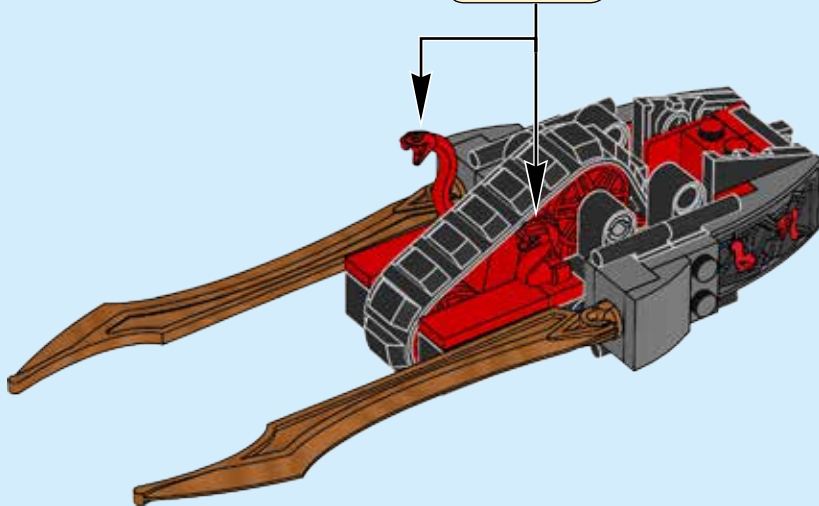

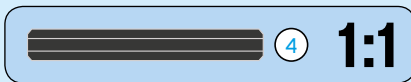
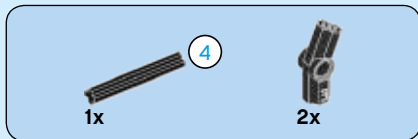

28

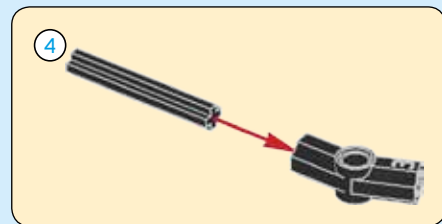
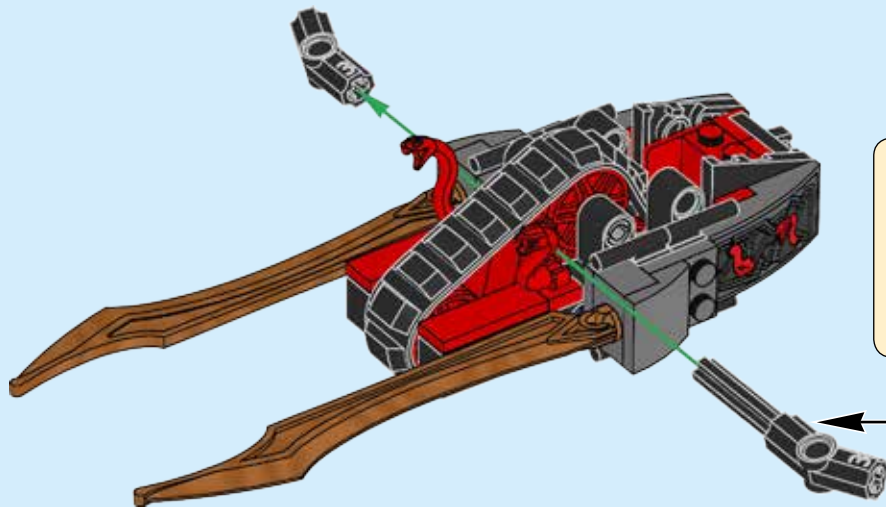



2x

29

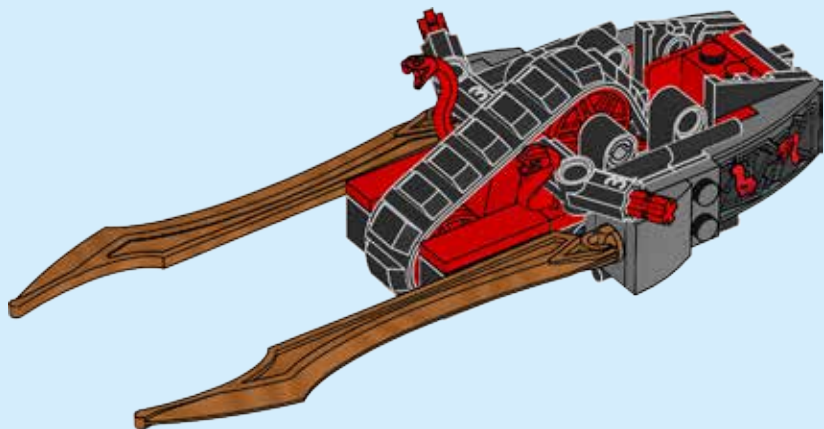

20

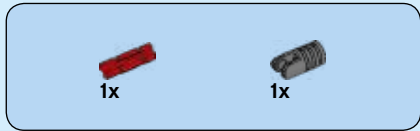

30

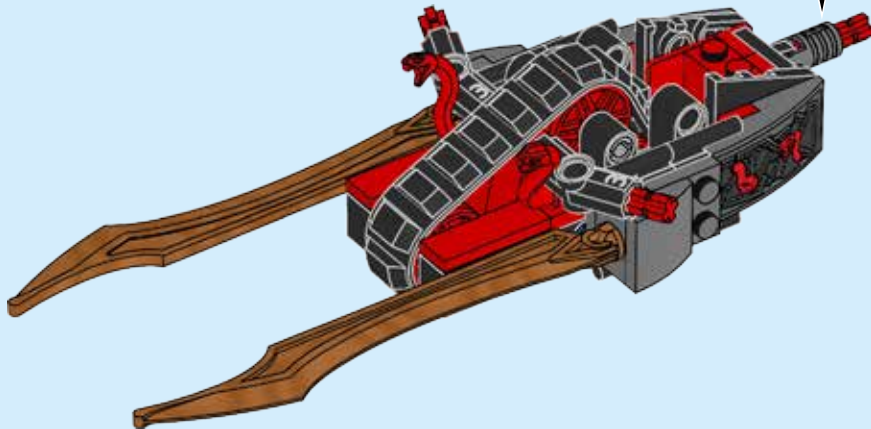
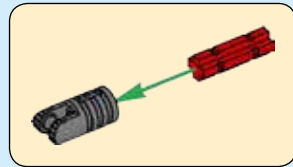

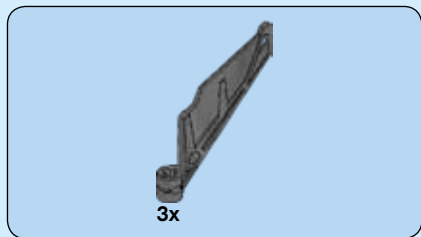

31

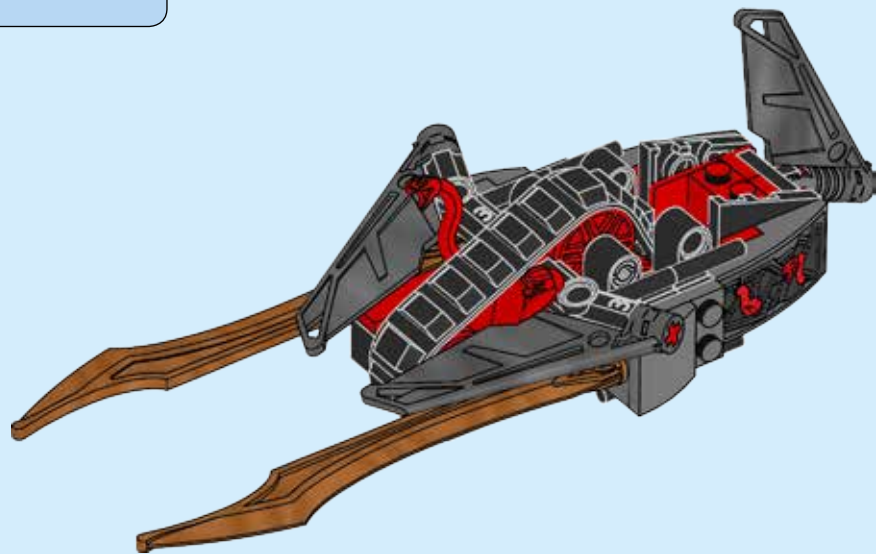



LEGO

NINJAGO

Masters of Spinjitzu





NINJAGO

Masters of Spinjitzu



LEGO.COM/NINJAGO



NINJAGO

Masters of Spinjitzu



LEGO.COM/NINJAGO



Download on the
App Store



Apple and the Apple logo are trademarks of Apple Inc., registered in the U.S. and other countries. App Store is a service mark of Apple Inc.

Google Play is a trademark of Google Inc.



ANDROID APP ON
Google play

Ask parents' permission first./Bitte frage erst deine Eltern um Erlaubnis./Demande d'abord l'autorisation d'un parent./Pide antes permiso a tus padres./Pede primeiro permissão aos teus pais./Először kérj engedélyt a szüleidtől! /先请求家长的许可。



Customer Service

Kundenservice

Service Consommateurs

Servicio Al Consumidor

LEGO.com/service or dial



: 00800 5346 5555

: 1-800-422-5346



All your LEGO® fun in one app



Minifigure yourself

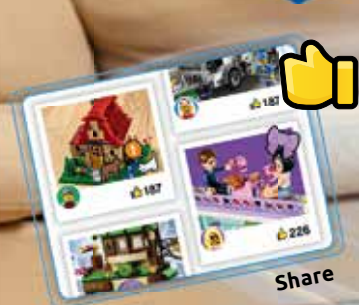

Share



Create



6196069

LEGO, the LEGO logo, the Minifigure, the Brick and Knob configurations and the LIFE logo are trademarks of the LEGO Group. ©2017 The LEGO Group.

Check availability of LEGO LIFE in your country now on LEGO.com/life
Ask parents' permission first.

Consulta si LEGO LIFE está disponible en tu país en LEGO.com/life
Pide antes permiso a tus padres.

Auf LEGO.com/life erfährst du jetzt, ob LEGO LIFE in deinem Land verfügbar ist
Bitte frage erst deine Eltern um Erlaubnis.

Verifica agora a disponibilidade de LEGO LIFE no teu país em LEGO.com/life
Pede primeiro permissão aos teus pais.

Vérifie la disponibilité de LEGO LIFE dans ton pays sur LEGO.com/life
Demande d'abord l'autorisation d'un parent.

Ellenőrizd a LEGO LIFE elérhetőségét a lakóhelyeden, most a LEGO.com/life honlapon!
Először kérj engedélyt a szüleidtől!

访问 LEGO.com/life 网站, 查看乐高生活系列是否已在你所在国家上线。先请求家长的许可。

Apple and the Apple logo are trademarks of Apple Inc., registered in the U.S. and other countries.
App Store is a service mark of Apple Inc. Google Play is a trademark of Google Inc.