

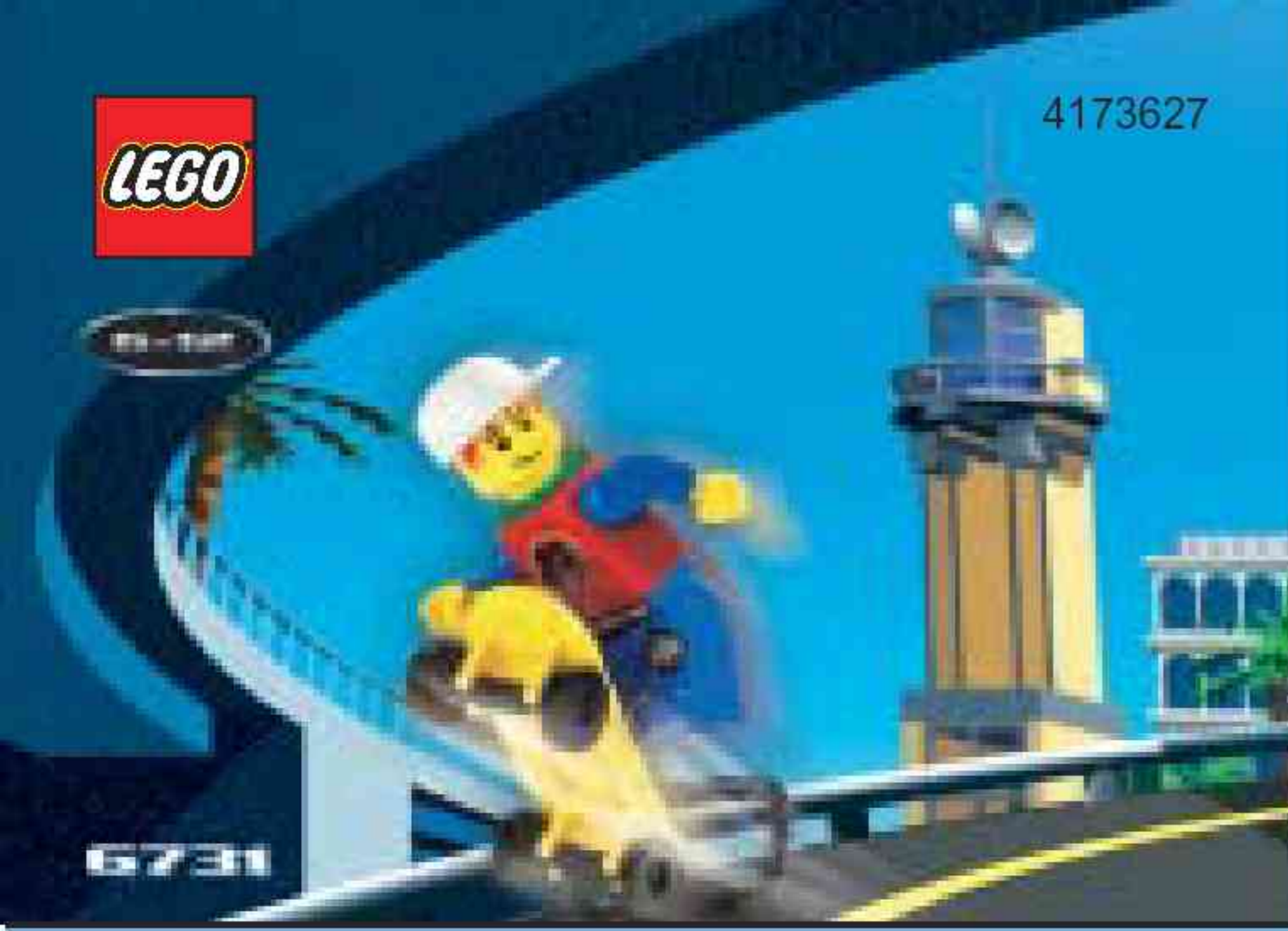

4173627

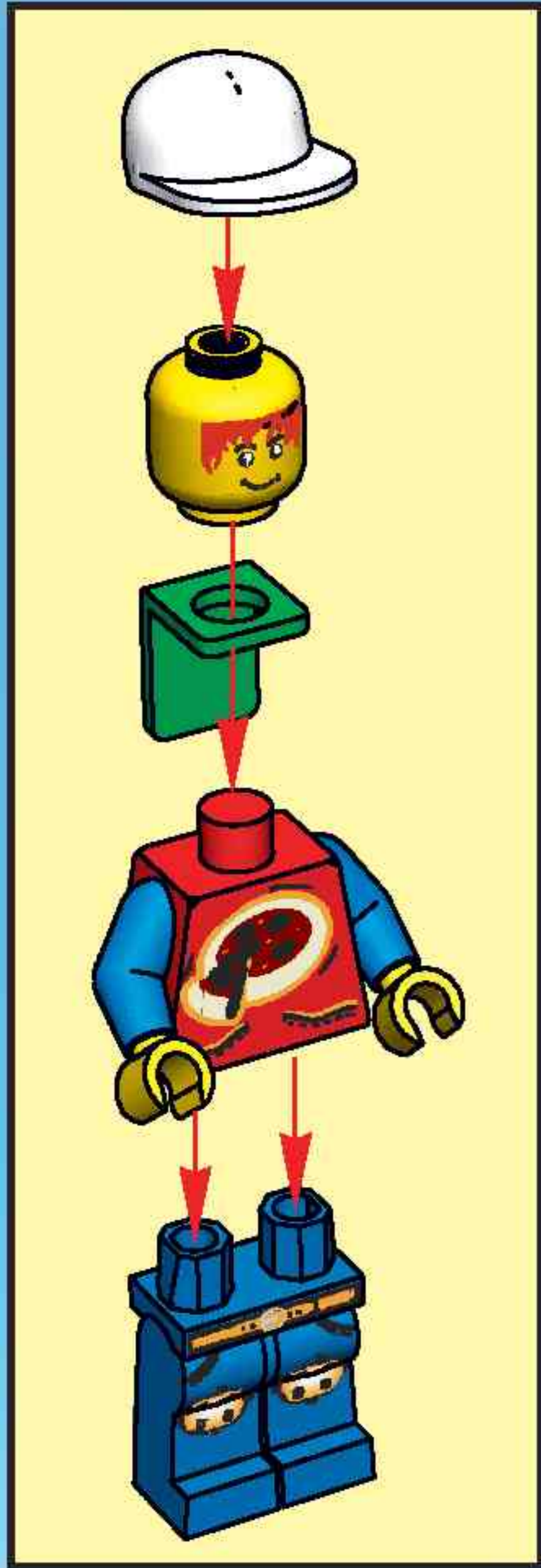

15731



1

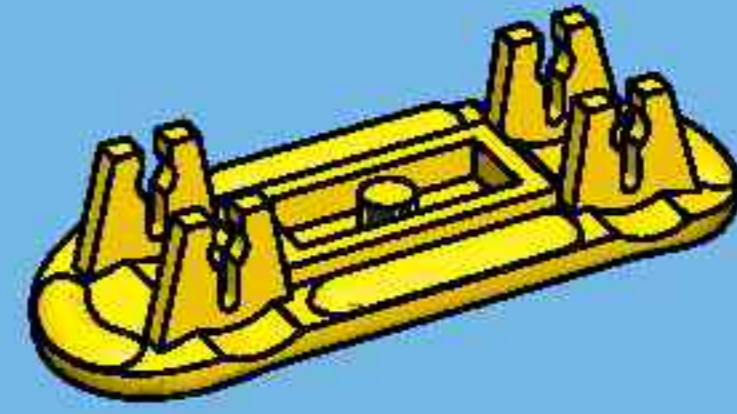

2

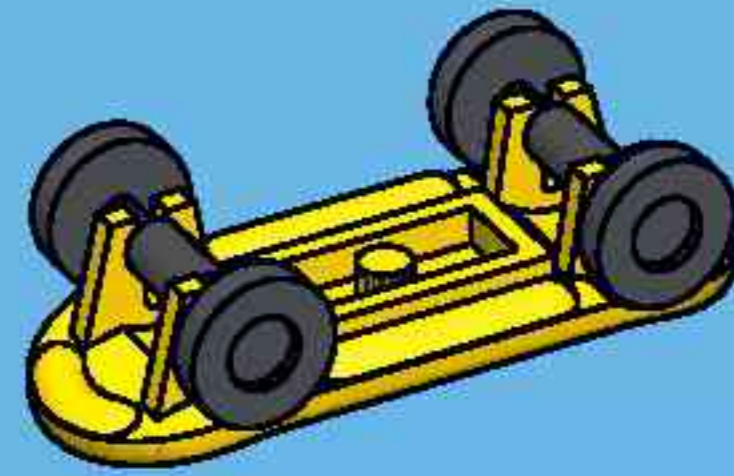

3



1

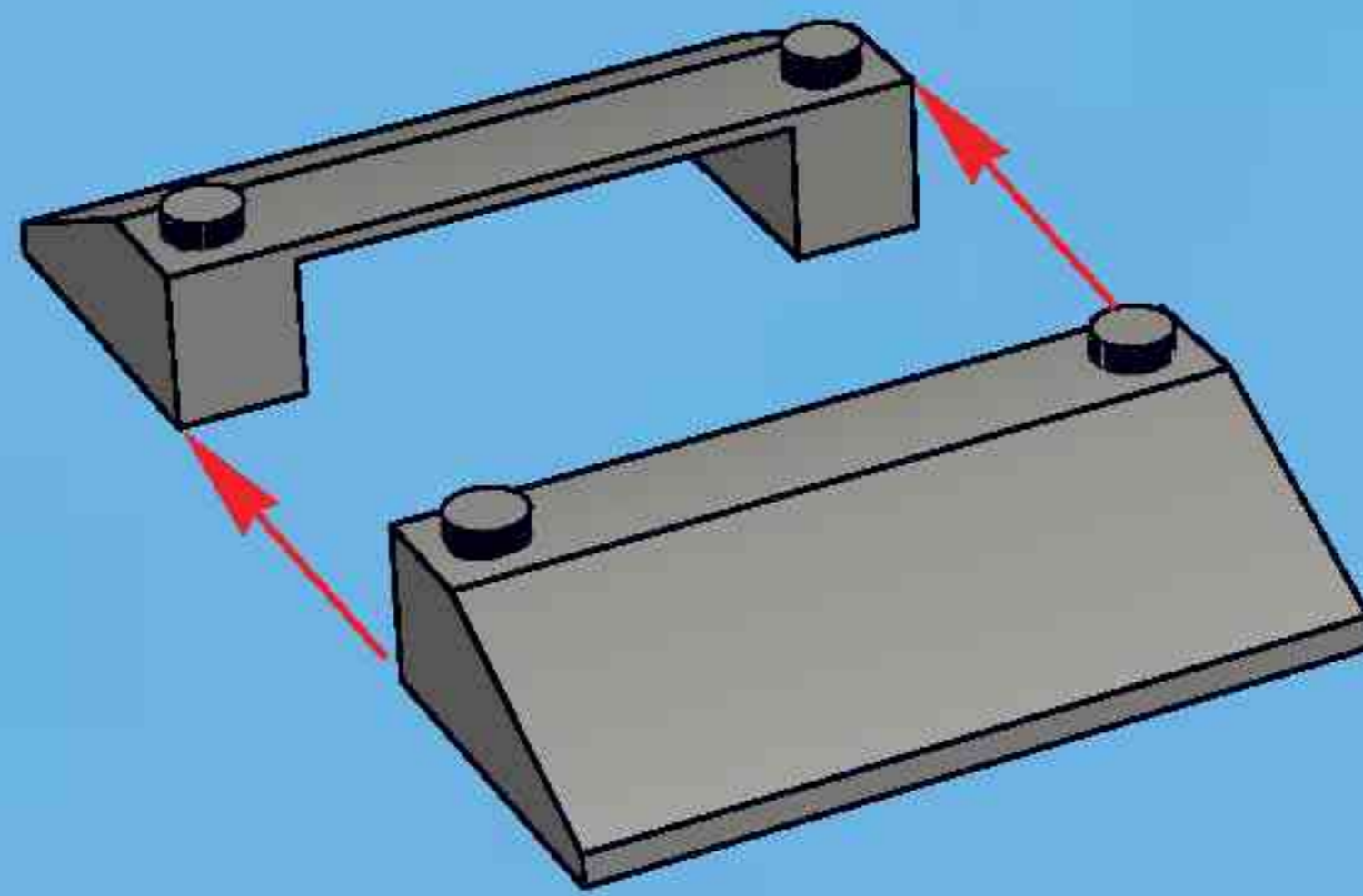

2

