

The LEGO logo is positioned in the top left corner of the page. It consists of the word "LEGO" in white, bold, sans-serif capital letters, set against a red square background.

# HERO FACTORY



6202



**WARNING: CHOKING HAZARD.**  
Toy contains small parts and a small ball.  
Not for children under 3 years.

HEROFACTORY.LEGO.COM



# HERO FACTORY

# +300

# GAME POINTS

Use the code - get 300 game points  
Utilise le code - obtiens 300 points bonus  
Consigue 300 puntos para el juego en la web con este código







1

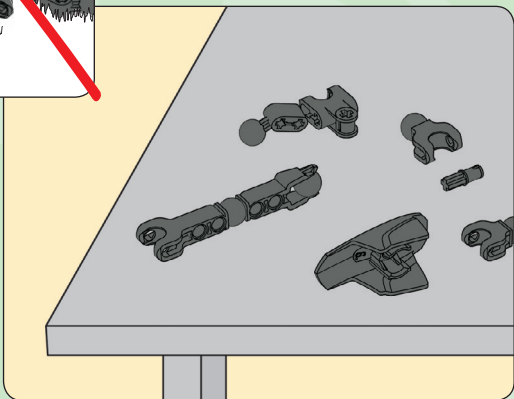
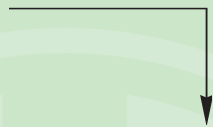
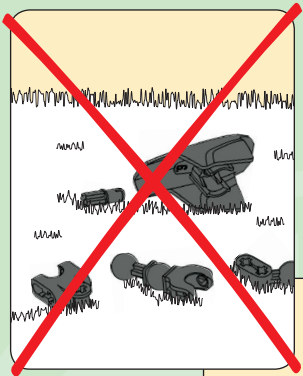

2

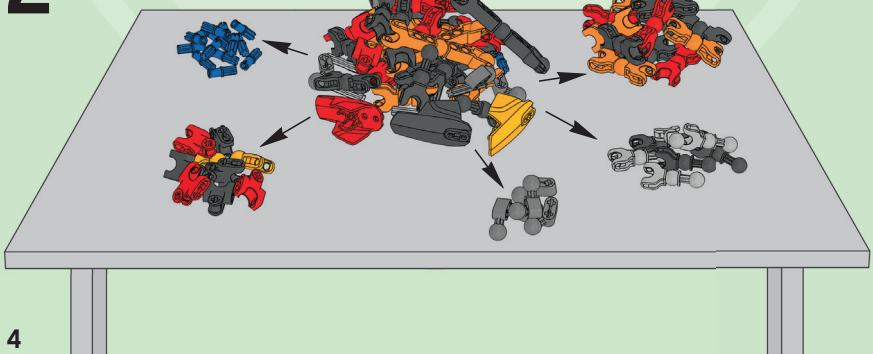

4



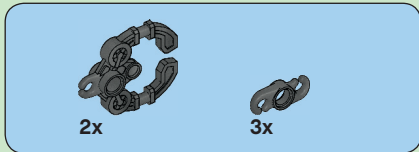

1

**AVERTISSEMENT : RISQUE D'ÉTOUFFEMENT.**  
Le jouet contient des petites pièces ainsi qu'une petite boule.  
Il ne convient pas aux enfants de moins de 3 ans.

**ADVERTENCIA: PELIGRO DE ASFIXIA.**  
Juguete que contiene partes pequeñas y una pelota pequeña.  
No recomendado para niños menores de 3 años.



1

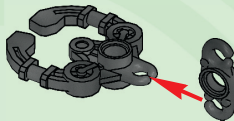

2

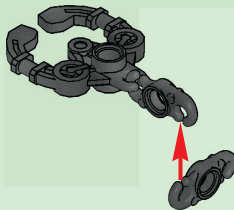

3

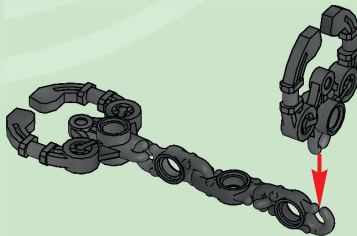

5



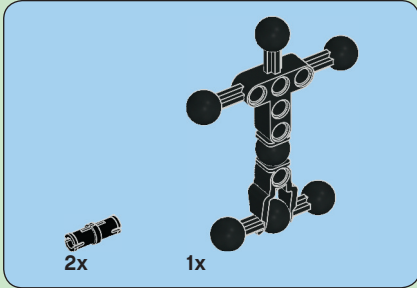

1

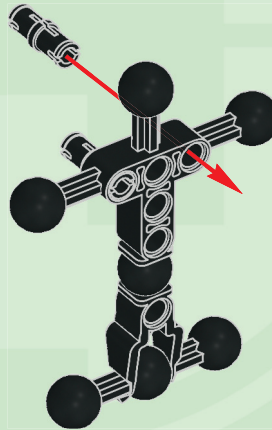

6



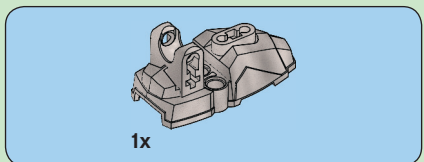

2

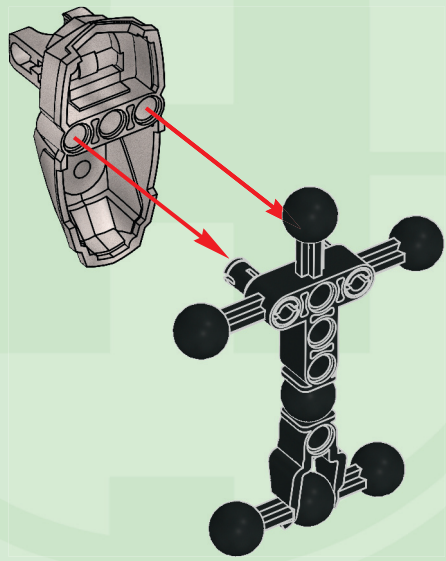

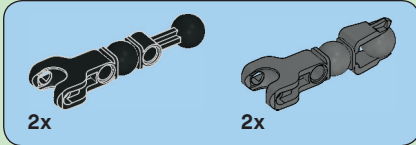

**3**

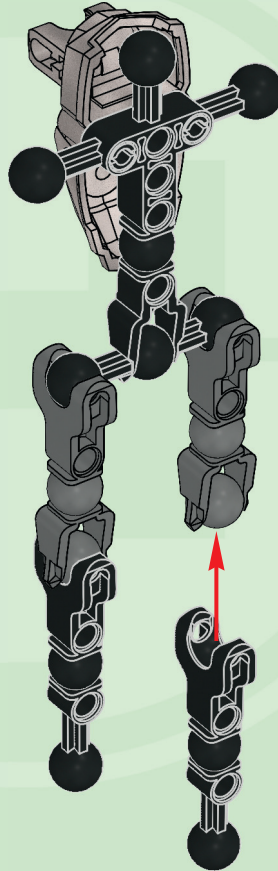

**8**





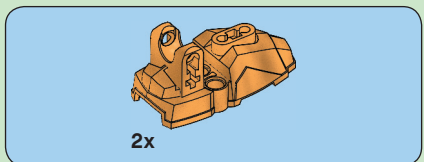

4

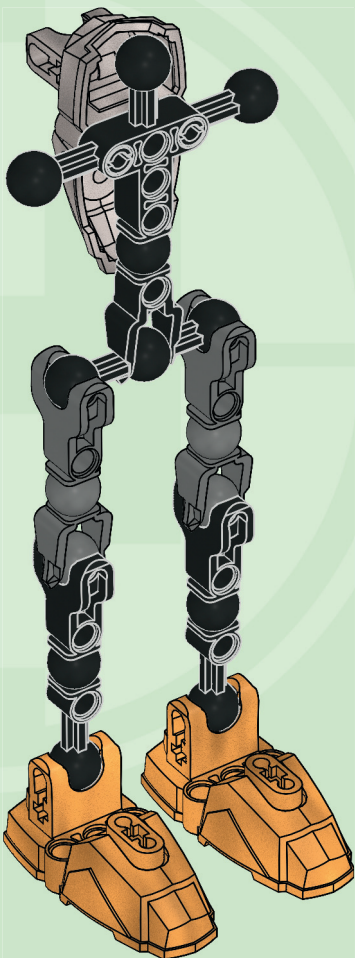

9



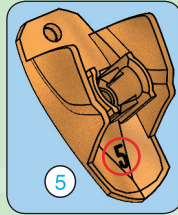
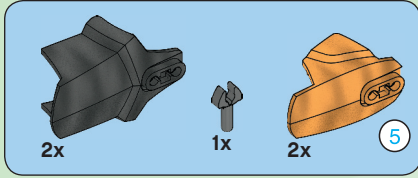

# 5

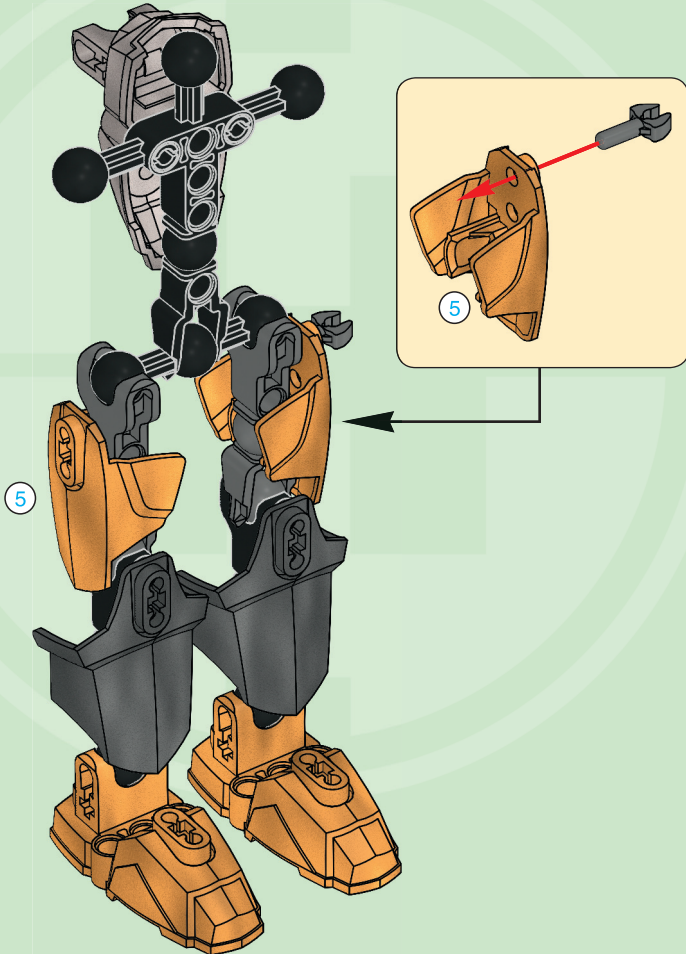

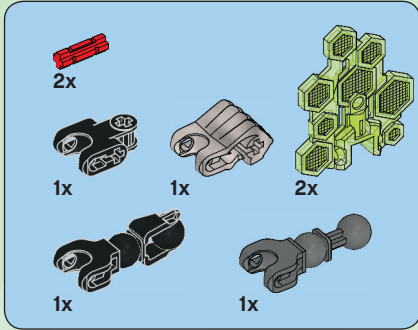
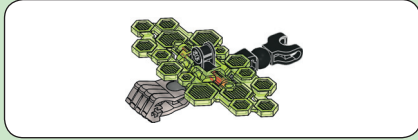

6

1

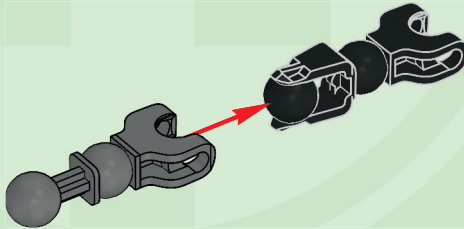



2

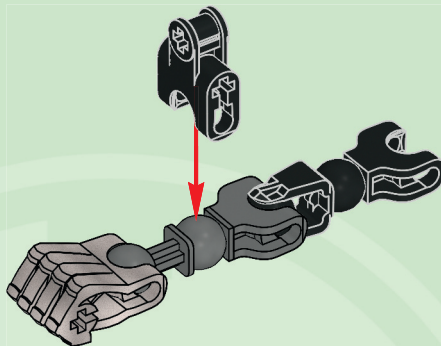

3

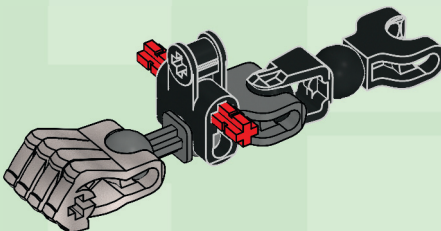

4

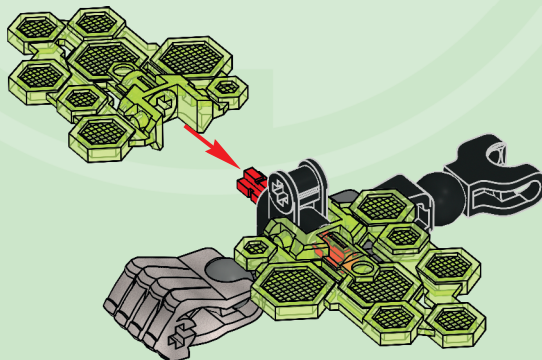

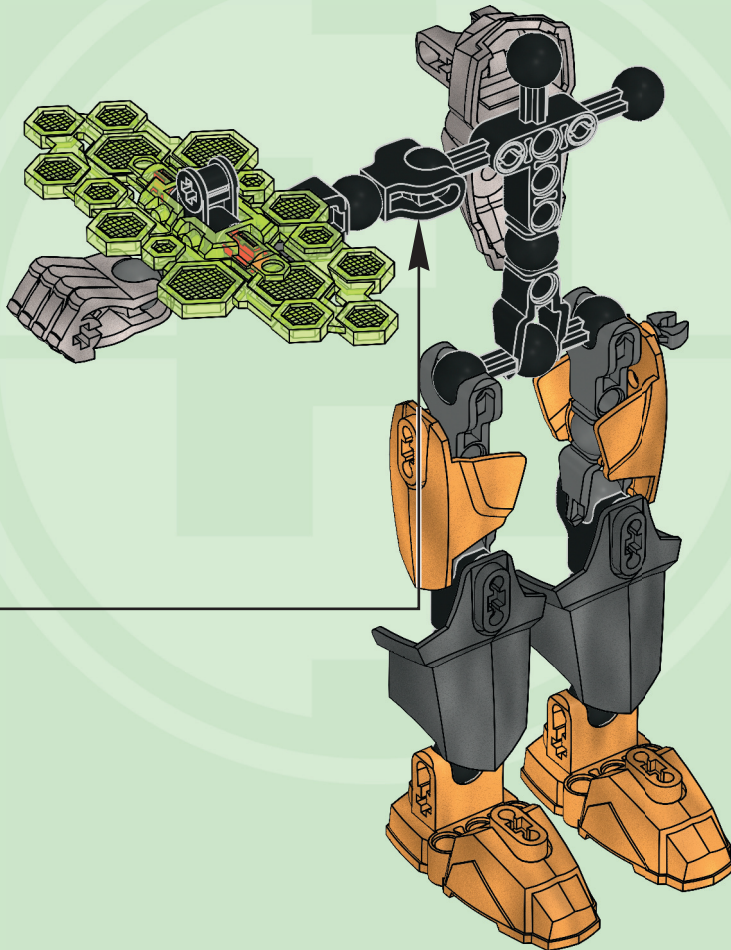

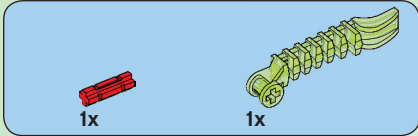
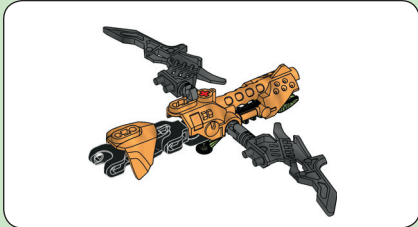

1

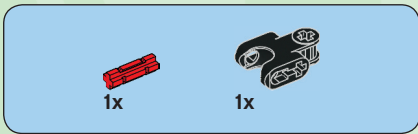
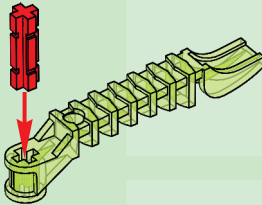

2

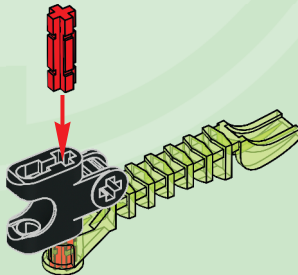

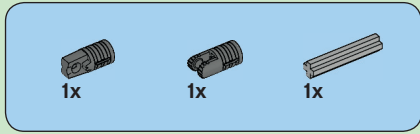

### 3

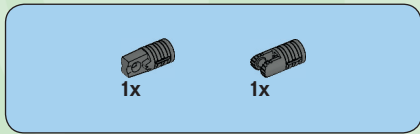
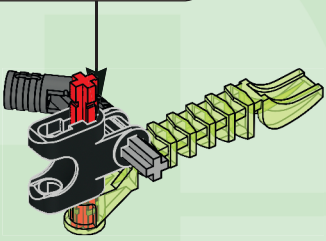
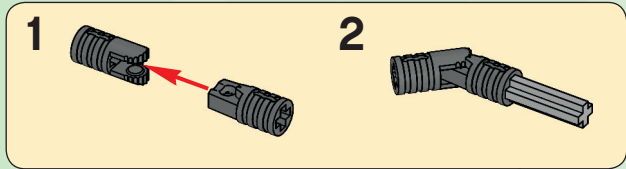

### 4

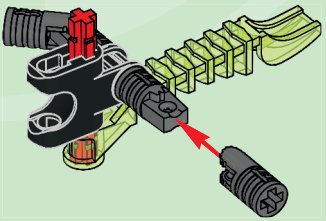



5

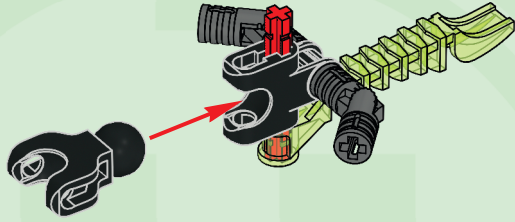

6

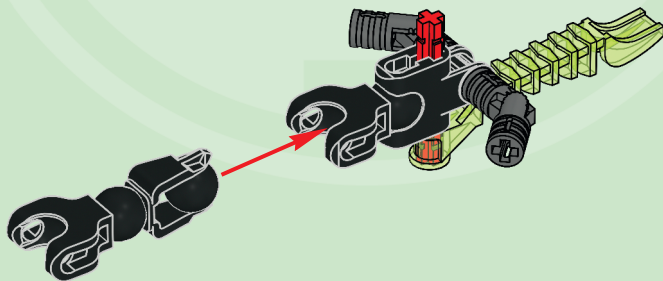

16





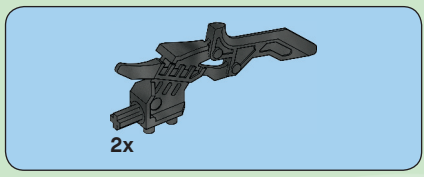

7

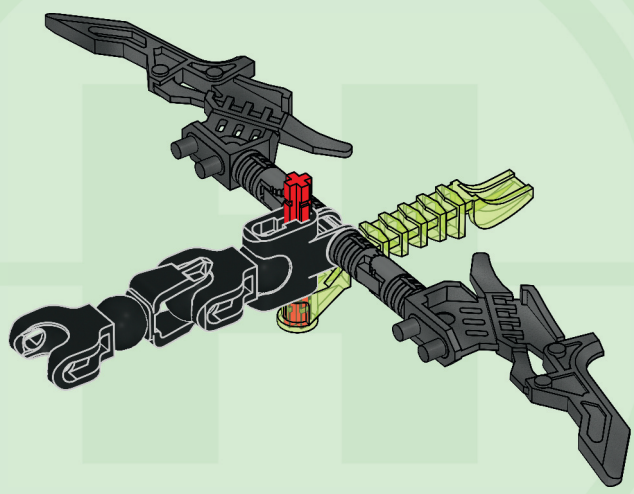

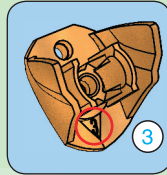
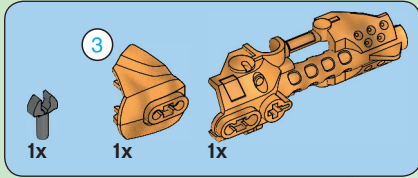

# 8

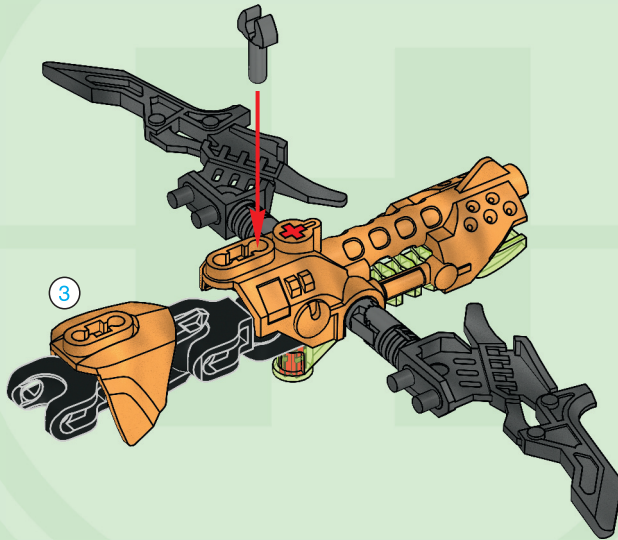

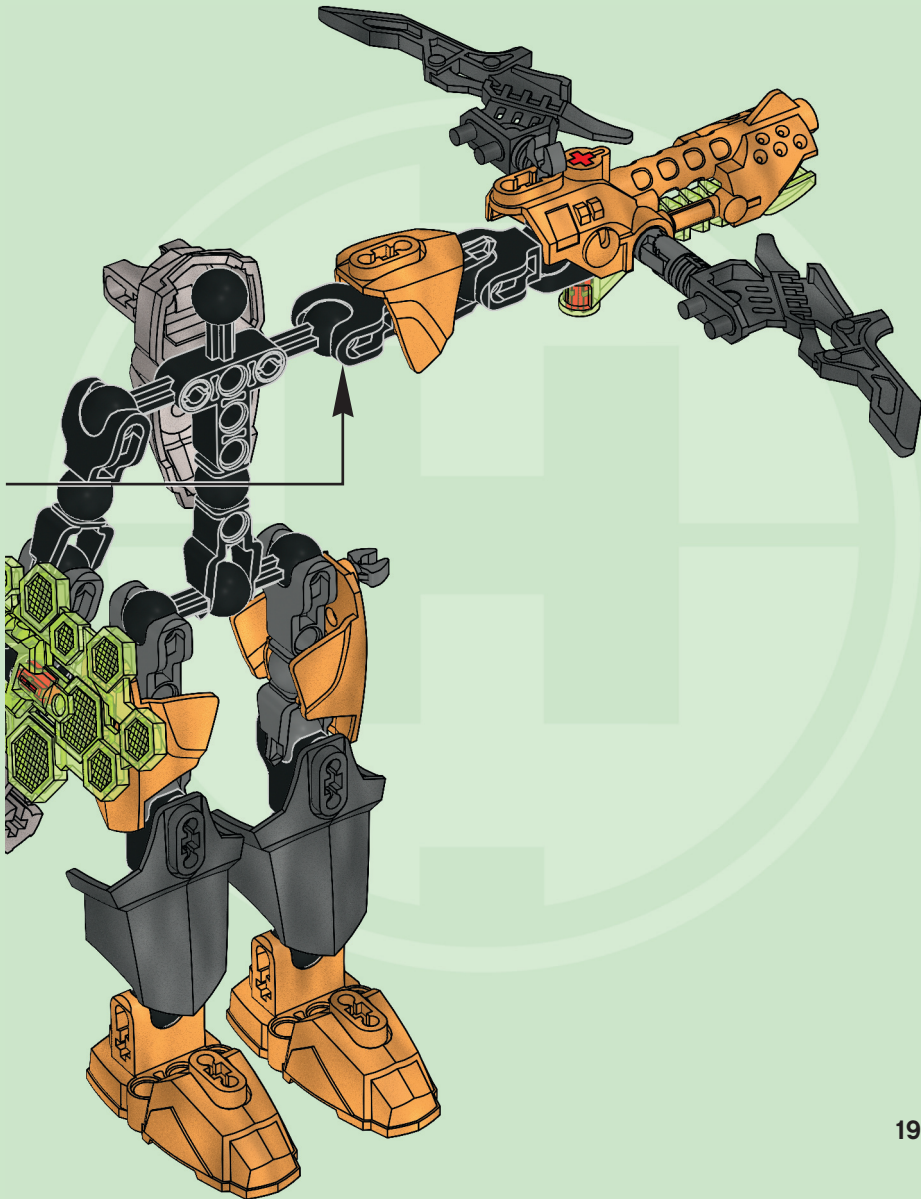

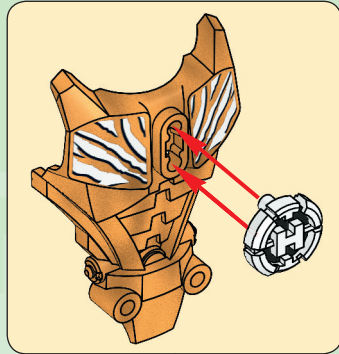
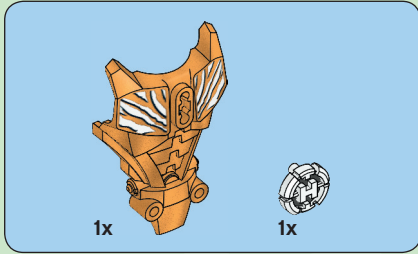

9



20



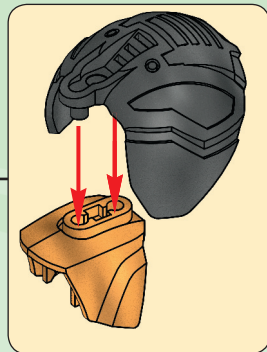
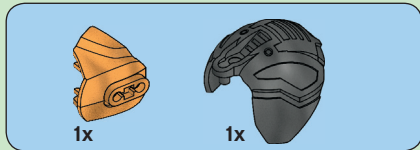

10



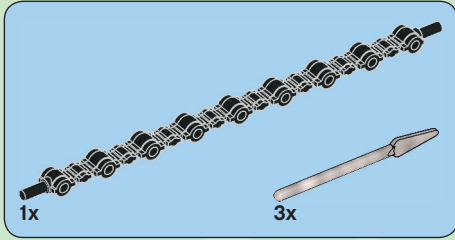

11

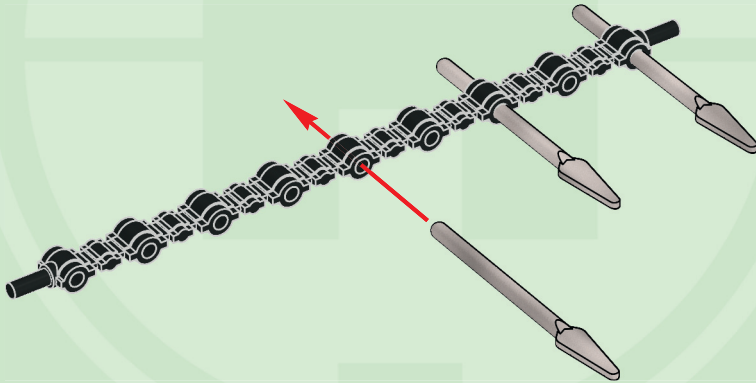

22



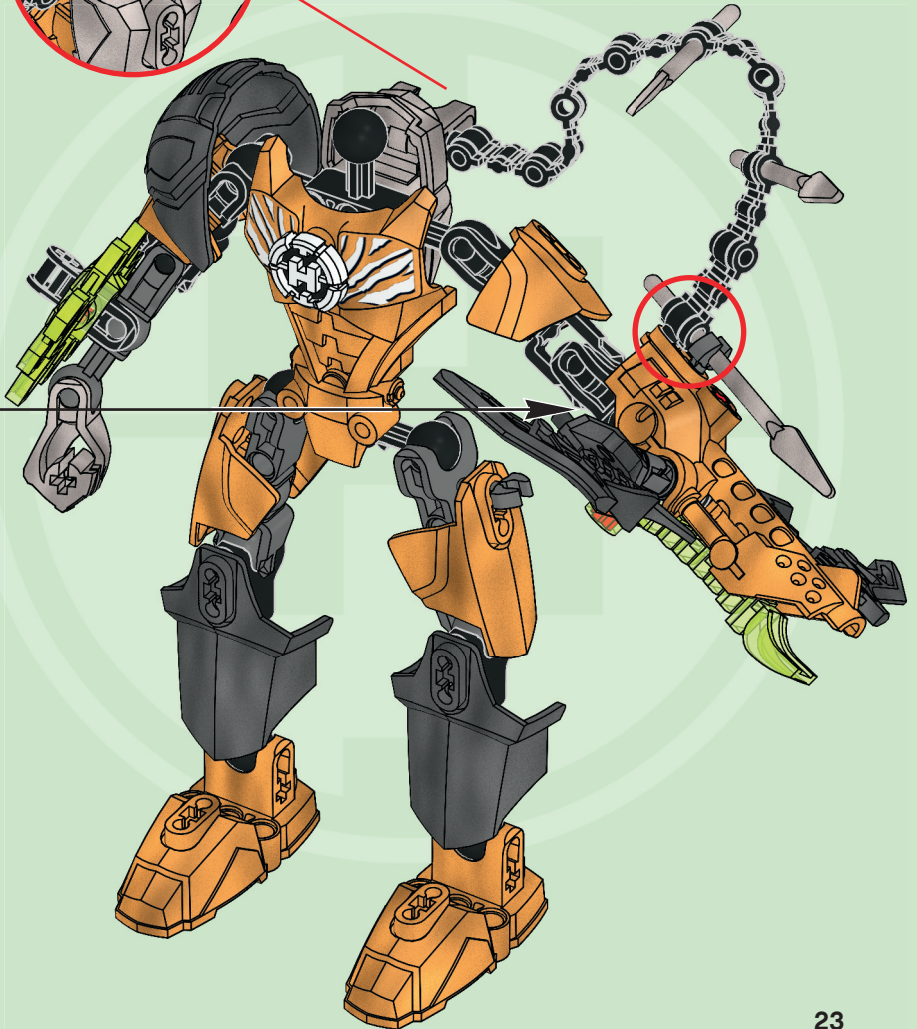

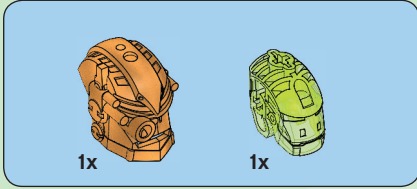

# 12

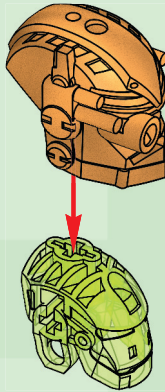

24





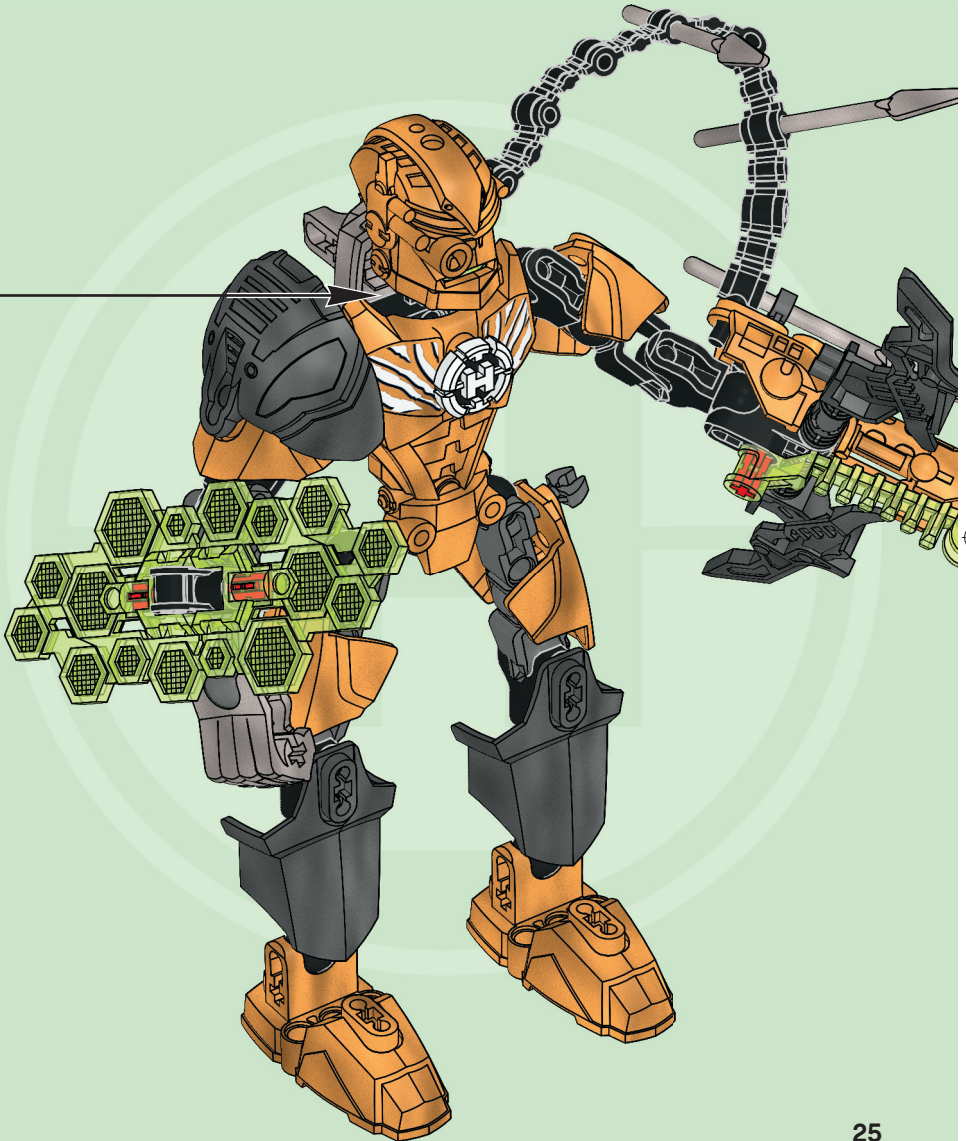

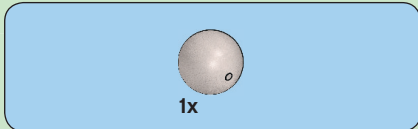

13

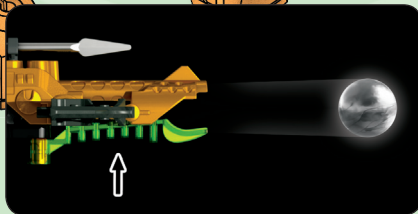

26





3x  
4611883



1x  
4619077

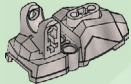

1x  
4632585



2x  
4610948



1x  
4593557



2x  
4589952



1x  
4589953



2x  
4593553



2x  
4121715



1x  
4652060



2x  
4289542



2x  
4210694



2x  
4210695

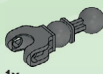

1x  
4618992

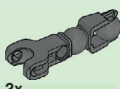

2x  
4655899



1x  
4653135

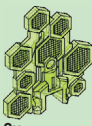

2x  
4652059

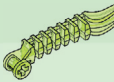

1x  
4652057



1x  
4211815

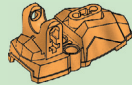

2x  
4632581



1x  
4652177

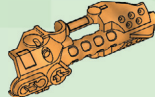

1x  
4652192



2x  
4624197



2x  
4632639



1x  
4655682



3x  
4654504



2x  
4652053



1x  
4652174

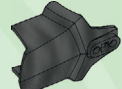

2x  
4611812



2x  
4612489



1x  
4655097



1x  
6000979



4x  
4142865



Customer Service

Kundenservice

Service Consommateurs

Servicio Al Consumidor

[www.lego.com/service](http://www.lego.com/service) or dial



: 00800 5346 5555



: 1-800-422-5346





# HERO FACTORY



6202



6203





HEROFACORY.LEGO.com/BI





6202

6203





www.LEGOclub.com

# LEGO club™

**FREE! GRATIS! GRATUIT!**



LEGO Club Magazine



LEGO Club Email



**SIGN UP ONLINE!**  
**www.LEGOclub.com**

VISIT THE WORLD'S  
BIGGEST LEGO® SHOP!  
**www.LEGOshop.com**

00800 5346 5555   
 **1-866-534-6258 • 1-877-518-5346**  
US & Canada only Canada seulement



\* Freephone. Mobile charges may apply. \* Numéro sans frais. Des frais peuvent s'appliquer avec les téléphones cellulaires. \* Gebührenfrei, Kosten für Anrufe aus Mobilfunknetzen können abweichen. \* Gratis telefoonnummer vanaf vaste lijn. \* Det er et gratis nummer, når du ringer fra fasttelefon. \* Det är gratis, när du ringer från en fast telefon. \* Numéro sans frais. Des frais peuvent s'appliquer avec les téléphones portables.

B1112



# WIN!

Go to [www.LEGOsurvey.com/product](http://www.LEGOsurvey.com/product) to fill out a survey for a chance to win a cool LEGO® Product.  
No purchase necessary.  
Open to all residents where not prohibited.



[www.LEGO.com](http://www.LEGO.com)



## [www.LEGOsurvey.com/product](http://www.LEGOsurvey.com/product)

### GEWINNE!

Nimm an der Umfrage auf [www.LEGOsurvey.com/product](http://www.LEGOsurvey.com/product) teil und hab die Chance ein cooles LEGO® Produkt zu gewinnen!  
Die Teilnahme am Gewinnspiel führt zu keinerlei Kaufverpflichtungen, Teilnahme in allen nicht ausgeschlossenen Ländern möglich.

### WIN!

Ga naar [www.LEGOsurvey.com/product](http://www.LEGOsurvey.com/product), vul een enquêteformulier in en maak kans op een cool LEGO® product.  
Geen aankoopverplichting.  
Iedereen mag deelnemen, uitgezonderd ingezetenden van landen waar een enquêteverbod geldt.

### GAGNE!

Visite [www.LEGOsurvey.com/product](http://www.LEGOsurvey.com/product) pour répondre à un questionnaire et avoir une chance de gagner un produit LEGO® très cool!  
Aucune obligation d'achat.  
Ouvert à tous les résidents des pays autorisés.

### 当てよう!

[www.LEGOsurvey.com/product](http://www.LEGOsurvey.com/product) にアクセスして、アンケートにご記入ください。  
当選者にはレゴ®製品を差し上げます。  
お買い上げの必要はありません。  
禁止されていない限り、すべての皆様にご利用いただけます。

6002552

LEGO and the LEGO logo are trademarks of the/sonnt des marques de commerce de/son marcas registradas de LEGO Group. ©2012 The LEGO Group.