



CITY

60021



WARNING: CHOKING HAZARD.
Small parts. Not for children under 3 years.

1



2



3



4



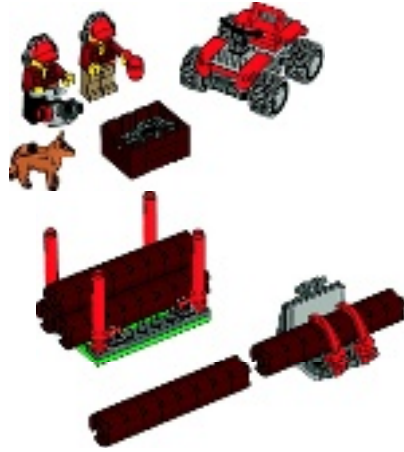

AVERTISSEMENT : RISQUE D'ÉTOUFFEMENT.
Contient des petites pièces. Ne convient pas aux enfants de moins de 3 ans.



ADVERTENCIA: PELIGRO DE ASFIXIA.
No recomendado para niños menores de 3 años. Contiene piezas pequeñas.

1



2



3



4



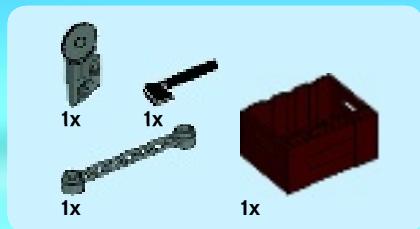

1

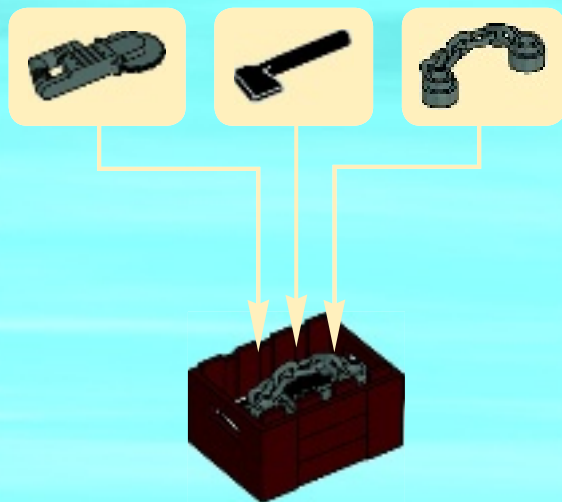



1x

1

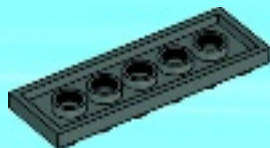

2x

2





2x

3



1x

4





1x



1x

5



2x



4x

6





2x

7

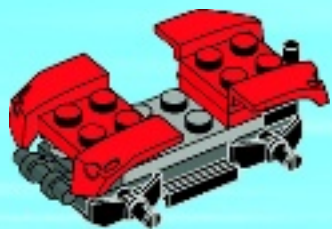

2x

8

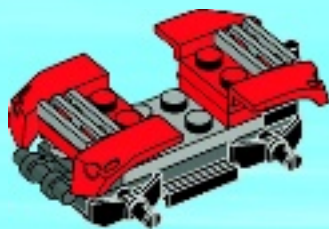



1x



1x

9

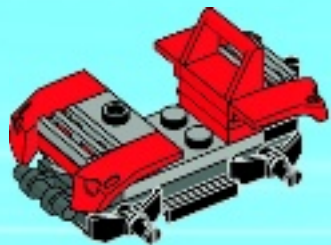

1x



1x

10





4x



4x

11



4x



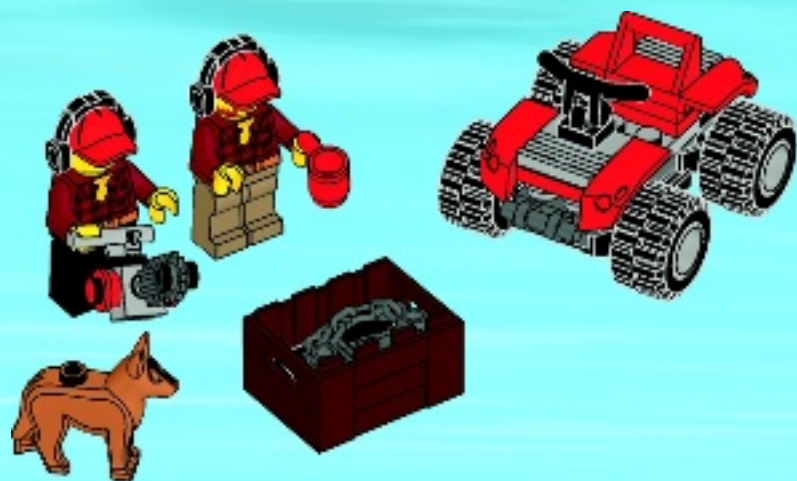

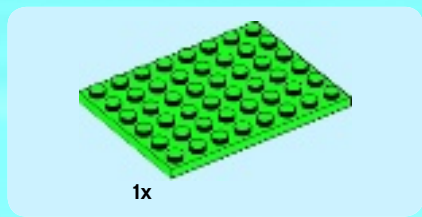
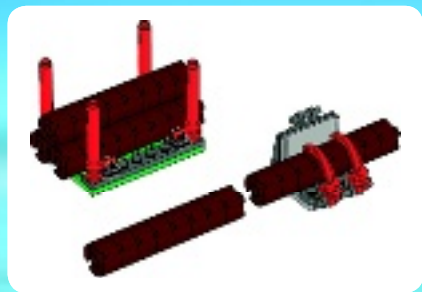

1x

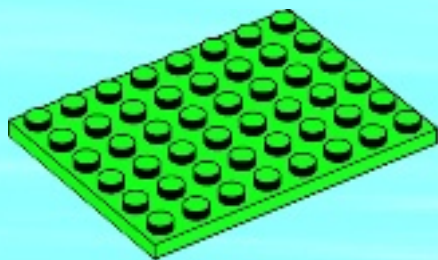

1



2x

2

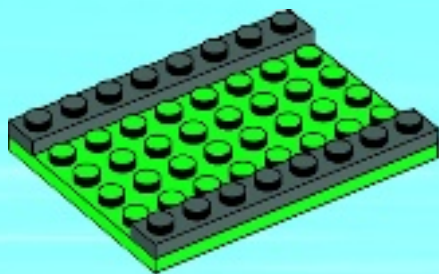



4x

3

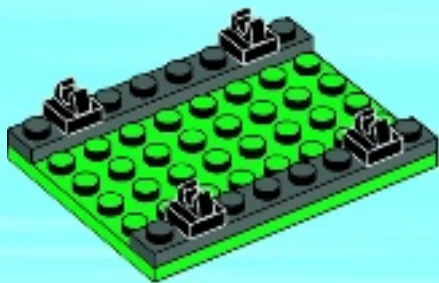

4x

4

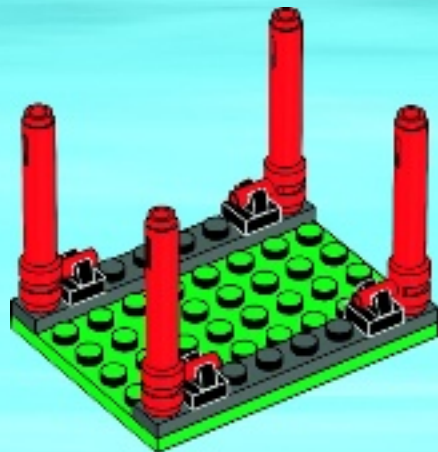



40x

5

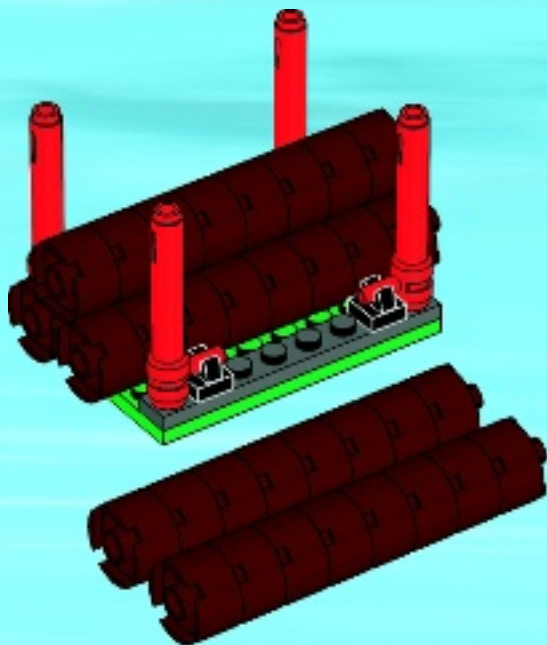

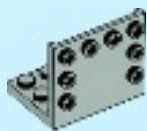

1x

1

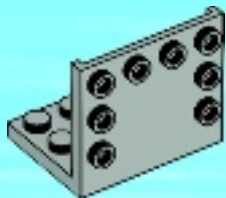

1x

2

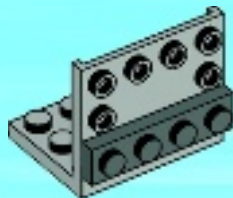



1x



2x

3

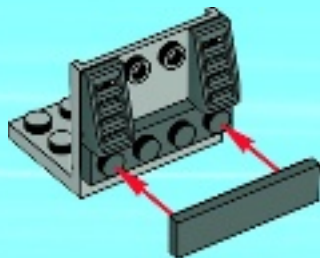

1x

4

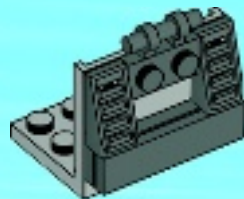



2x

5

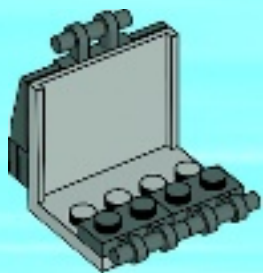

2x

6

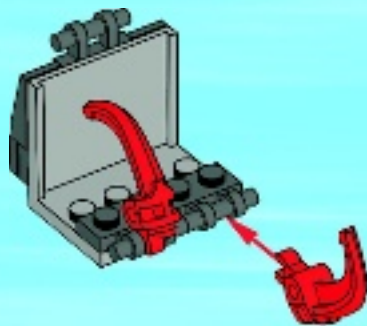

7

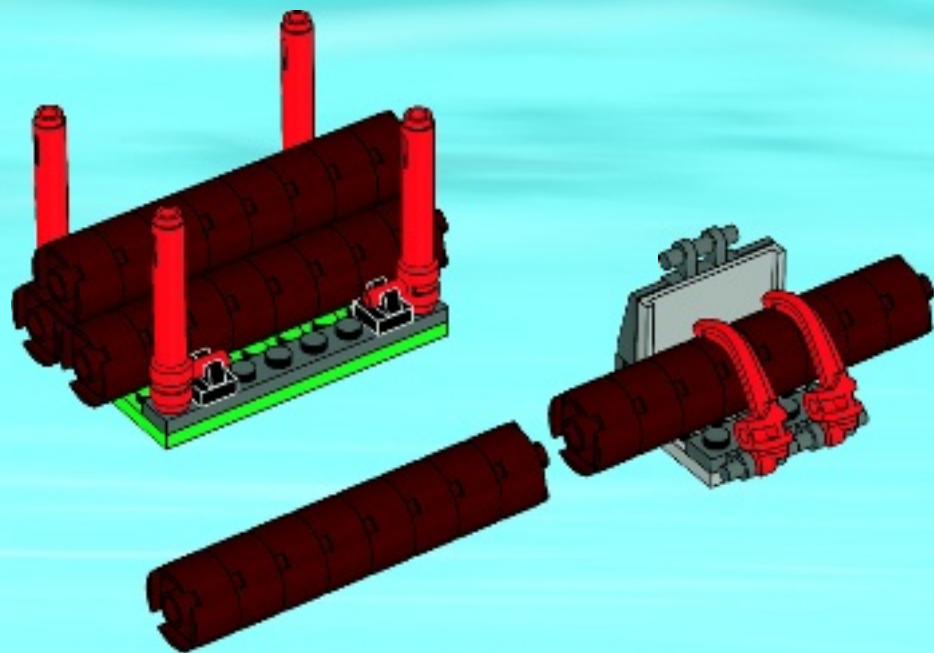



CITY





CITY



60008



60007



60006

Nintendo



CITY
UNDERCOVER



Game and system sold separately/Le jeu et le système sont vendus séparément. ©2013 The LEGO Group.
™ & © Warner Bros. Entertainment Inc. (s13). Wii U is a trademark of/est une marque déposée de Nintendo. © 2013 Nintendo.

EVERYONE 10+

Cartoon Violence
Crude Humor

CONTENT RATED BY
ESRB



WIN!

Go to LEGO.com/productfeedback to fill out a survey for a chance to win a cool LEGO® Product.

No purchase necessary.
Open to all residents where not prohibited.



LEGO.com/productfeedback

GEWINNE!

Nimm an der Umfrage auf LEGO.com/productfeedback teil und hab die Chance ein cooles LEGO® Produkt zu gewinnen!

Die Teilnahme am Gewinnspiel führt zu keinerlei Kaufverpflichtungen. Teilnahme in allen nicht ausgeschlossenen Ländern möglich.

 LEGO.com

6084441

WIN!

Ga naar LEGO.com/productfeedback, vul een enquêteformulier in en maak kans op een cool LEGO® product.

Geen aankoopverplichting.
Iedereen mag deelnemen, uitgezonderd ingezetenden van landen waar een enquêteverbod geldt.

GAGNE!

Visite LEGO.com/productfeedback pour répondre à un questionnaire et avoir une chance de gagner un produit LEGO® très cool!

Aucune obligation d'achat.
Ouvert à tous les résidents des pays autorisés.

当てよう!

LEGO.com/productfeedback にアクセスして、アンケートにご記入ください。当選者にはレゴ®製品を差し上げます。

お買い上げの必要はありません。
禁止されていない限り、すべての皆様にご利用いただけます。

LEGO and the LEGO logo are trademarks of the/son des marques de commerce de/son marcas registradas de LEGO Group. ©2014 The LEGO Group.