



4-7
5899







1

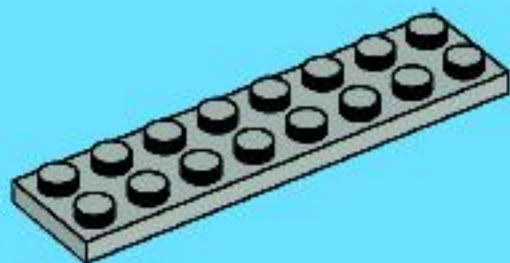

2

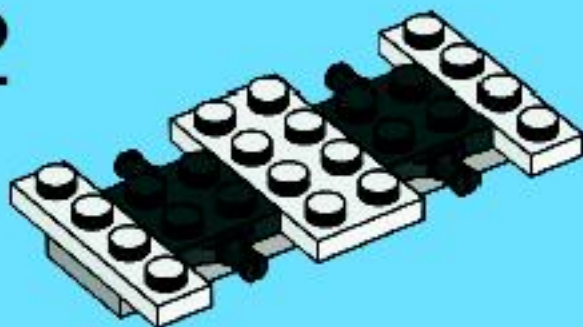

3

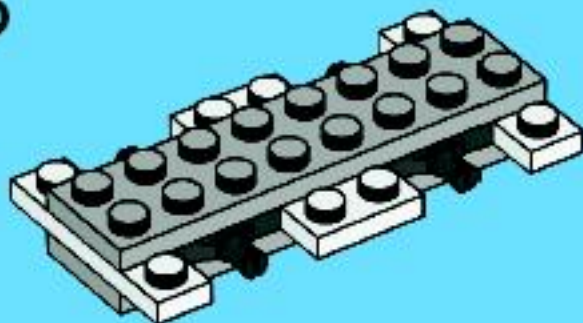

4

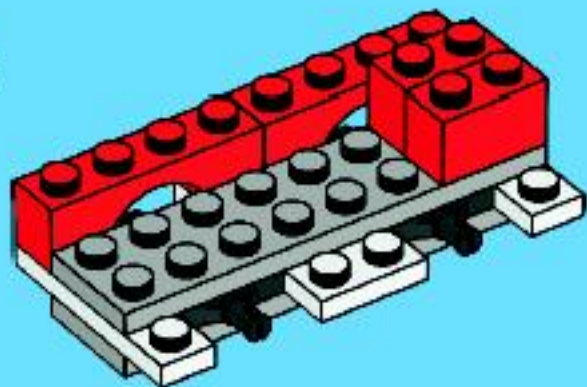

5

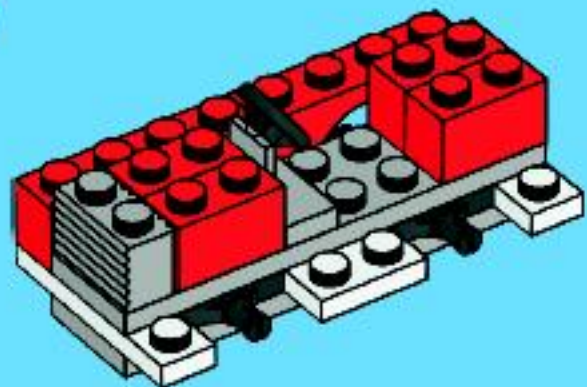

6

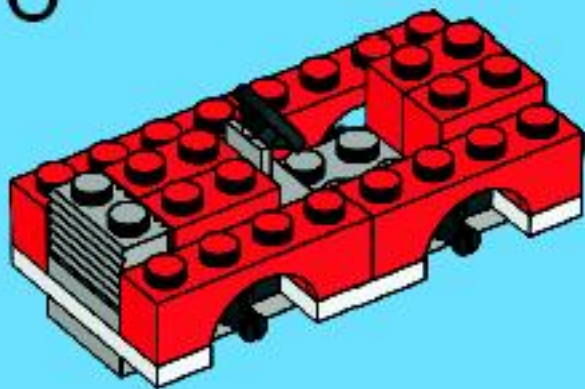

7

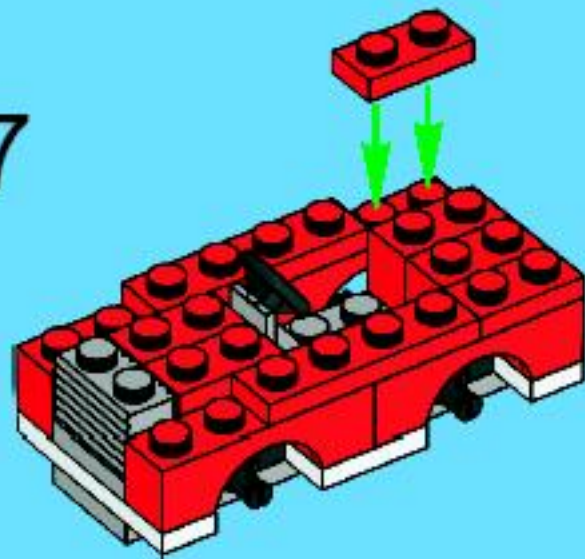

8

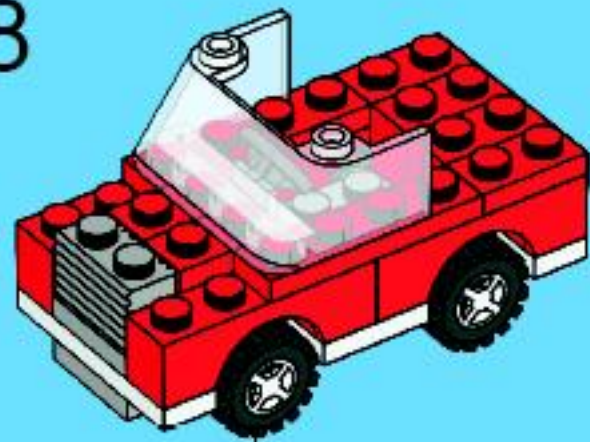



1

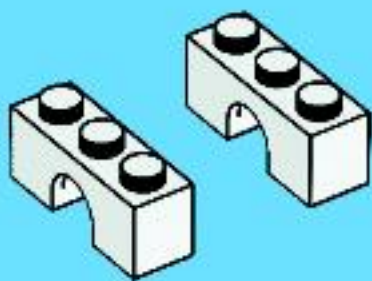

2



3

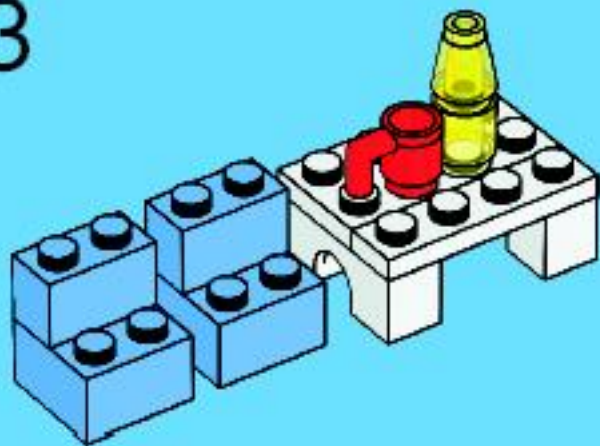





1

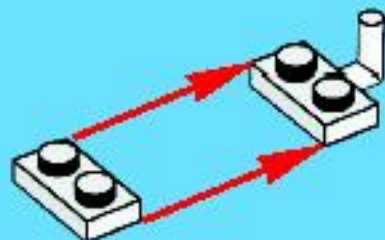

2

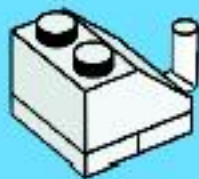

3



4







1

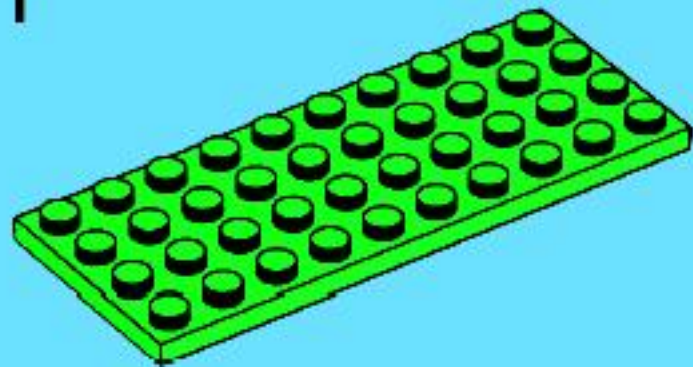

2

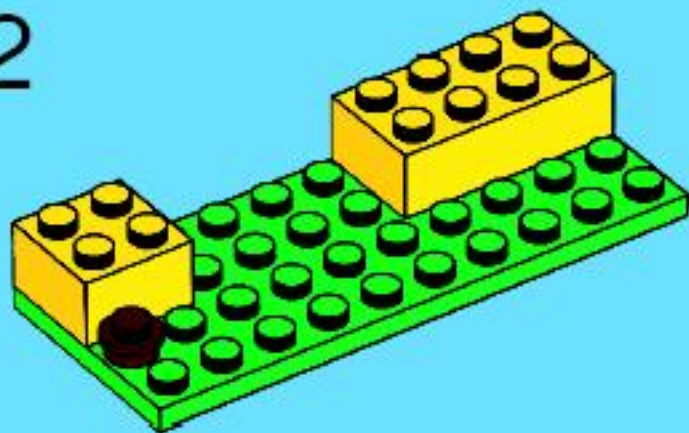

3

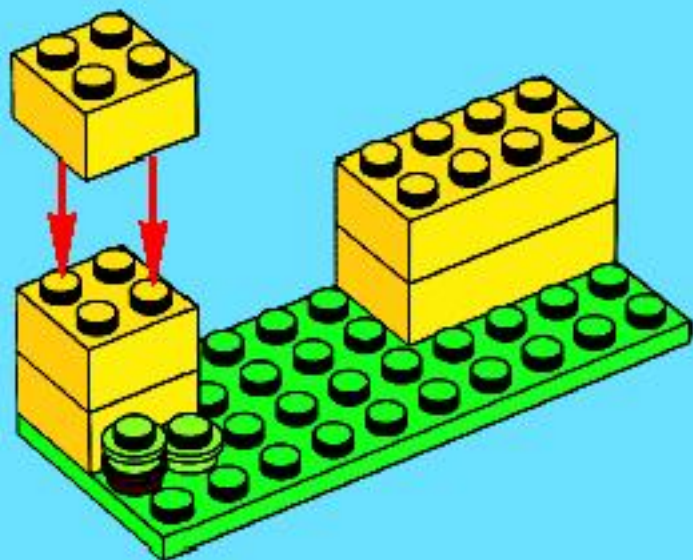

4

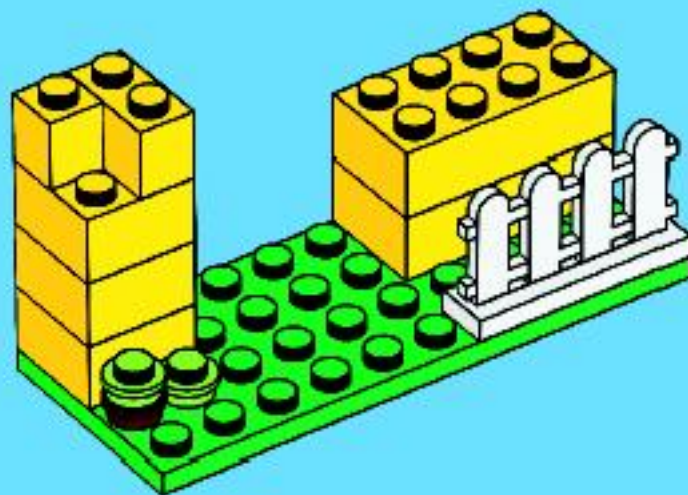

5

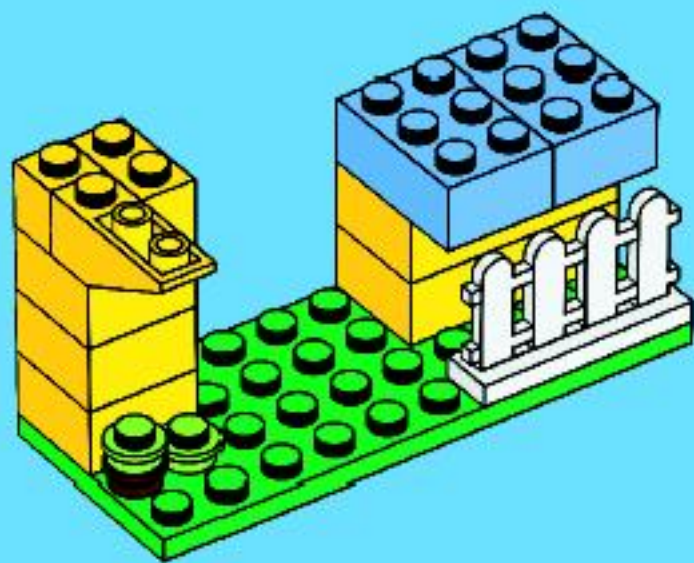

6

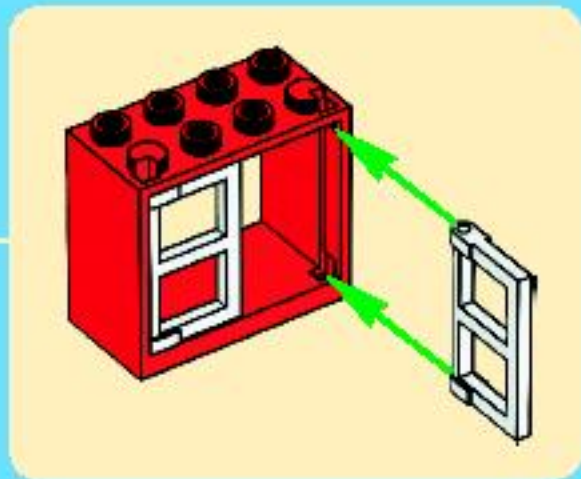
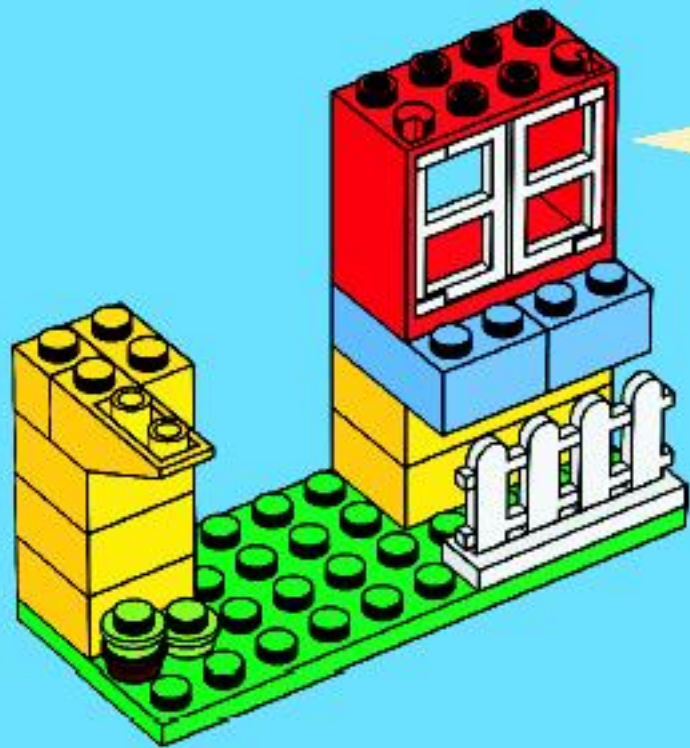

7

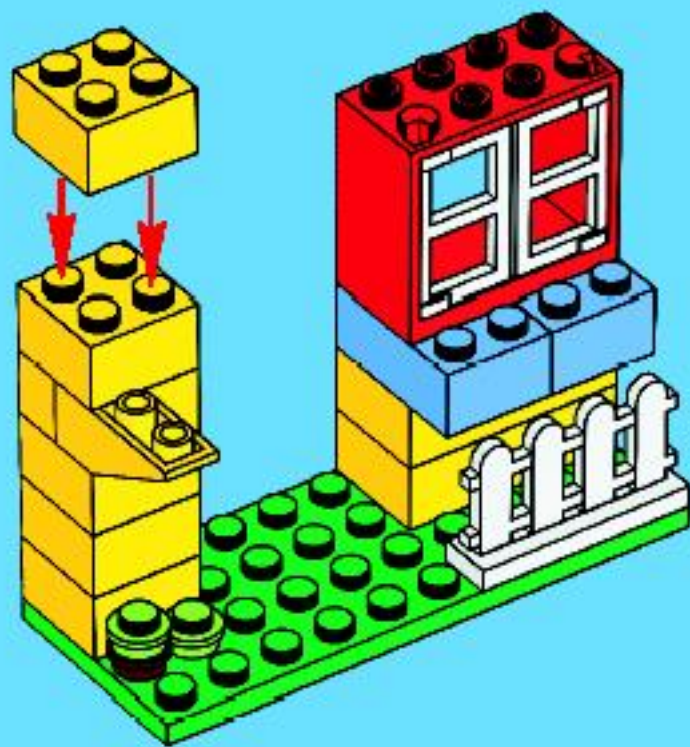

8

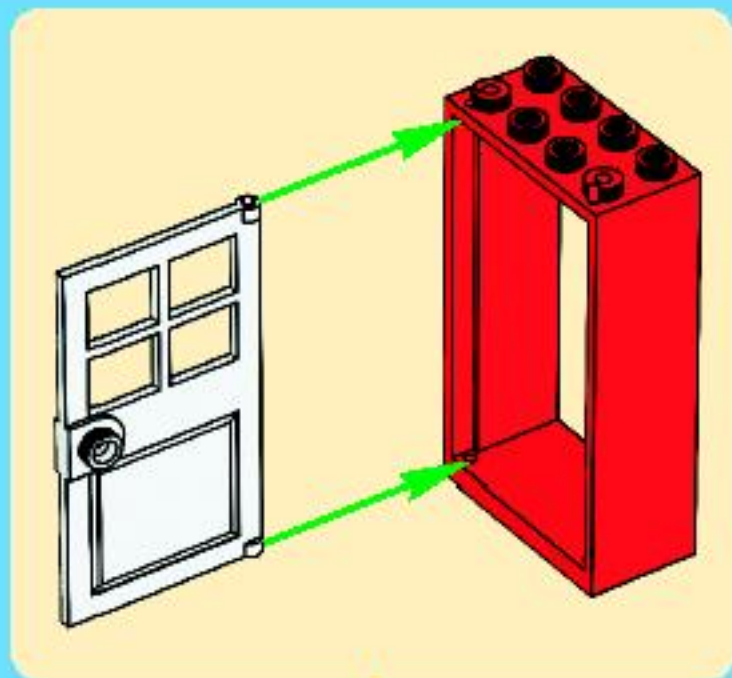
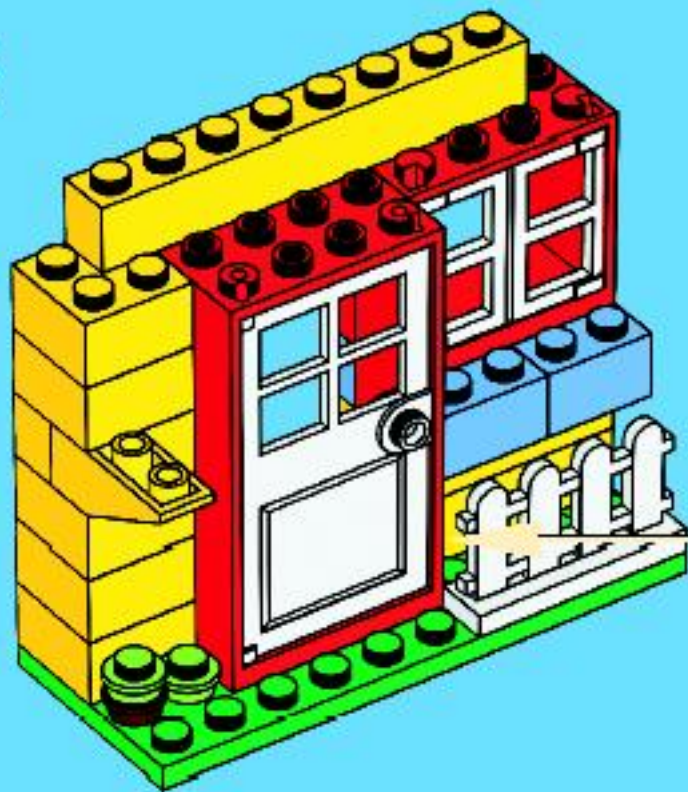

9

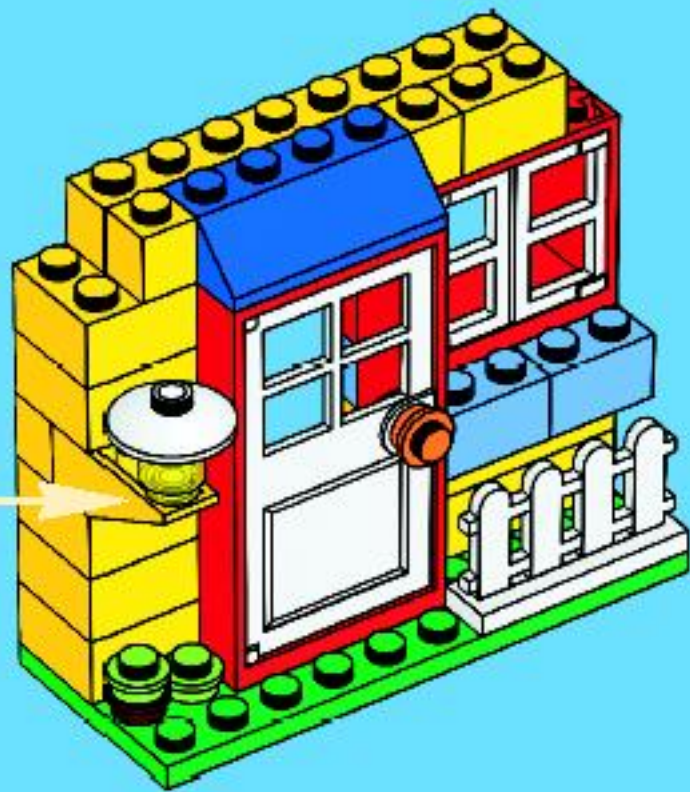
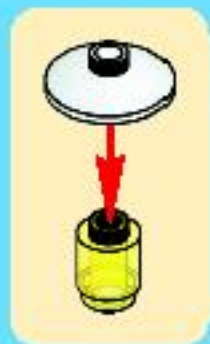

10

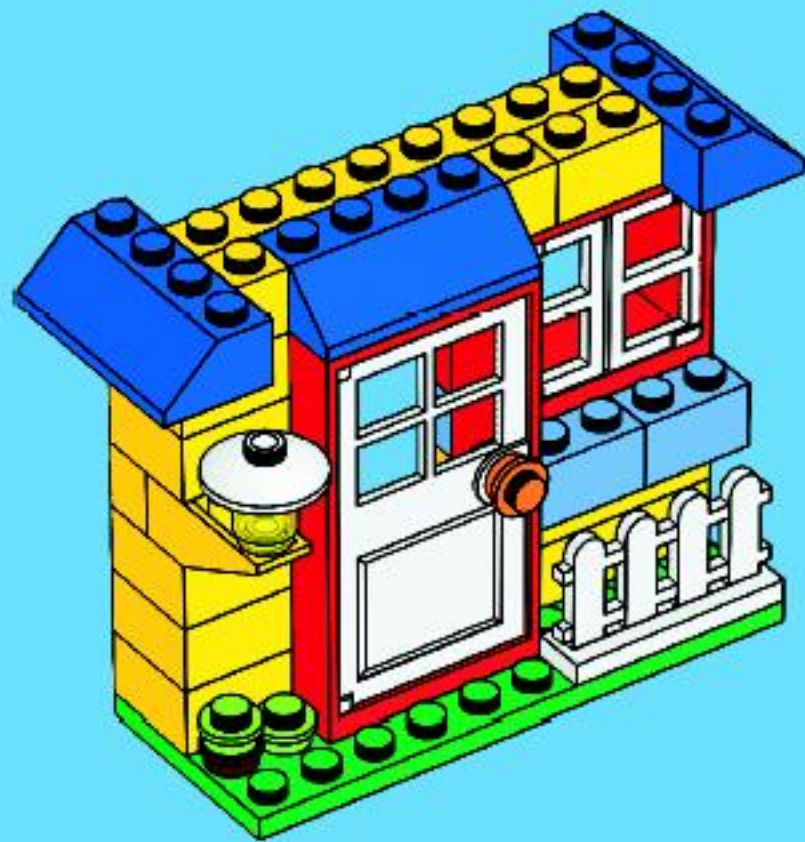

11

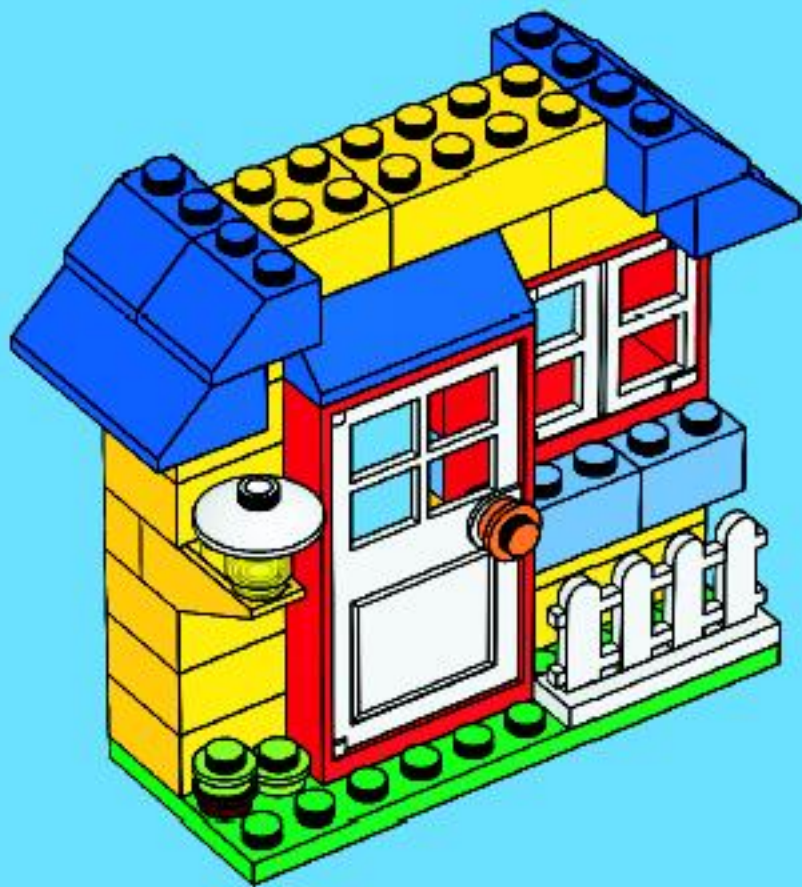

12



13

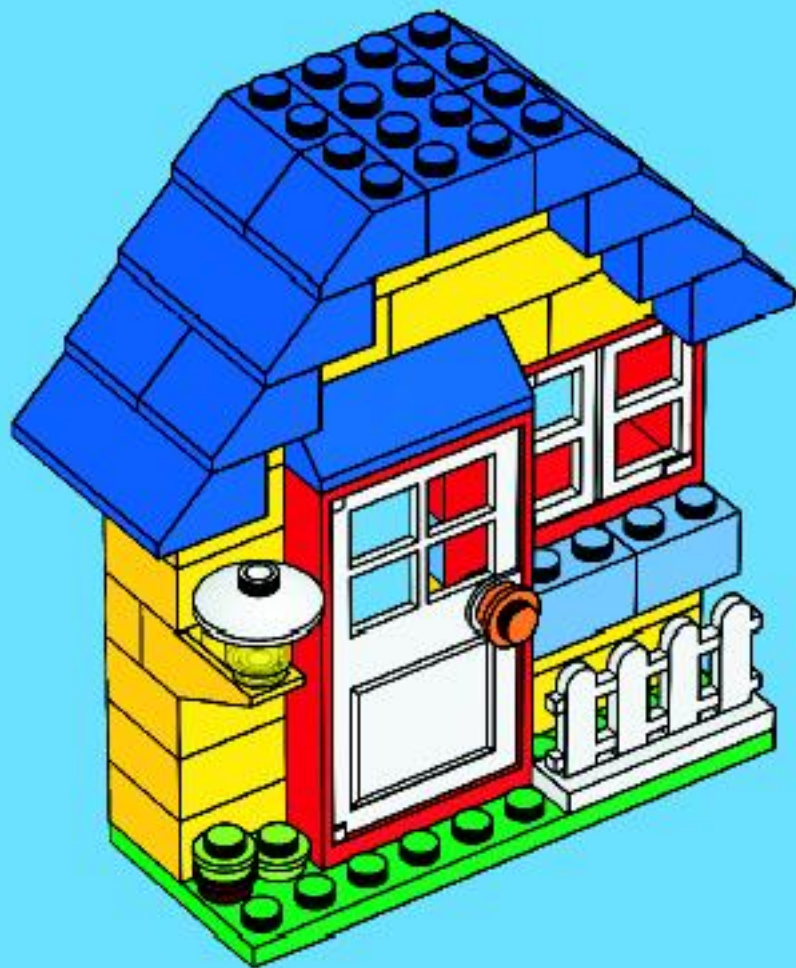



6192



6191



5898



626

5560



6194

6166



www.LEGO.com





1x
389921



4x
302321



2x
371021



2x
302121



4x
300421



4x
365921



1x
4550848



1x
4540429



1x
4528164



1x
4528139



2x
300123



1x
9341



8x
303923



5x
4107437



2x
301023



2x
4179830



4x
4179833



3x
4201235



2x
4210130



1x
81508



2x
4520970



4x
371001



4x
302001



1x
4141607

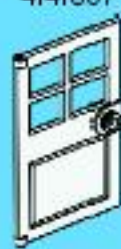

1x
4521943



1x
474001



1x
302301



2x
303901



2x
4520842



1x
462301



4x
462401



1x
4521778



1x
302224



2x
428724



3x
300524



2x
300424



6x
300324



4x
300124



1x
300824



1x
4261269



1x
4293369



2x
4567332



2x
3006844



2x
4216581



1x
4211165



2x
4211210



2x
4157103



4x
4501046



2x
460026



2x
4504382



1x
400626



4x
4164022



2x
4183133



2x
4143562



1x
300328



2x
4109674



1x
74040



1x
4223986



1x
4535553



1x
4226995



1x
4211383



2x
4211406



Customer Service

Kundenservice

Service Consommateurs

Servicio Al Consumidor

www.lego.com/service or dial



00800 5346 5555

1-800-422-5346



WIN!



Go to www.nielsen.com/LEGO
to fill out a survey for a chance
to win a cool LEGO® Product.
No purchase necessary.
Open to all residents where not prohibited.



www.nielsen.com/lego

GEWINNE!

Nimm an der Umfrage auf www.nielsen.com/LEGO teil und hab die Chance ein cooles LEGO Produkt zu gewinnen! Die Teilnahme am Gewinnspiel führt zu keinen Kaufverpflichtungen. Teilnahme in allen nicht ausgeschlossenen Ländern möglich.

WIN!

Ga naar www.nielsen.com/LEGO, vul een enquêteformulier in en maak kans op een cool LEGO® product. Geen aankoopverplichting. Iedereen mag deelnemen, uitgezonderd ingezetenden van landen waar een enquêteverbod geldt.

GAGNE!

Visite www.nielsen.com/LEGO pour répondre à un questionnaire et avoir une chance de gagner un produit LEGO® très cool! Aucune obligation d'achat. Ouvert à tous les résidents des pays autorisés.

当てよう!

www.nielsen.com/LEGO にアクセスして、アンケートにご記入ください。当選者にはレゴ製品を差し上げます。当選しなくてもご迷惑いたしません。抽籤されていない限り、すべての情報にご迷惑いたしません。