



4+

5482

Idea book



Pictured models cannot be built simultaneously

Die abgebildeten Modelle lassen sich nicht gleichzeitig bauen

Les modèles présentés ne peuvent pas être construits simultanément

I modelli illustrati non possono essere costruiti simultaneamente

De afgebeelde modellen zijn niet tegelijkertijd te bouwen

Los modelos ilustrados no pueden construirse simultáneamente

De viste modeller kan kun bygges én ad gangen

Kuvissa näkyvilt mallit voidaan rakentaa yksi kerrallaan

Modellerna som visas kan inte byggas samtidigt

Os modelos nas imagens não podem ser construídos em simultâneo

Ta jorváltá nou arakovlžyvat' byj jurockúy va kotoakakavatoúv taurožyova

A képen látható modelleket nem építheted meg egyszerre









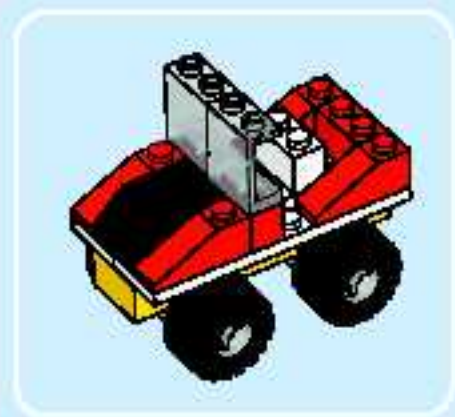

1

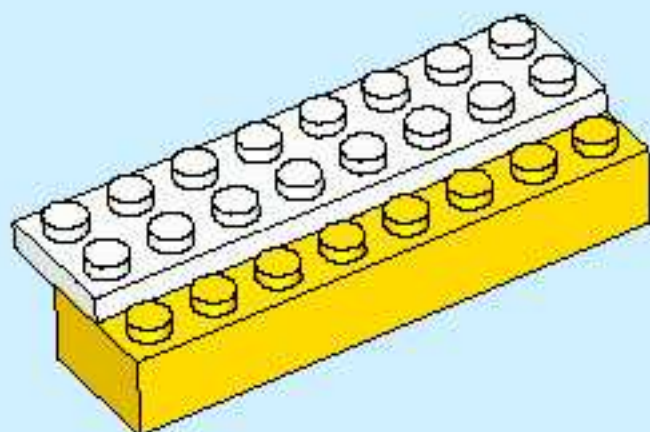

2

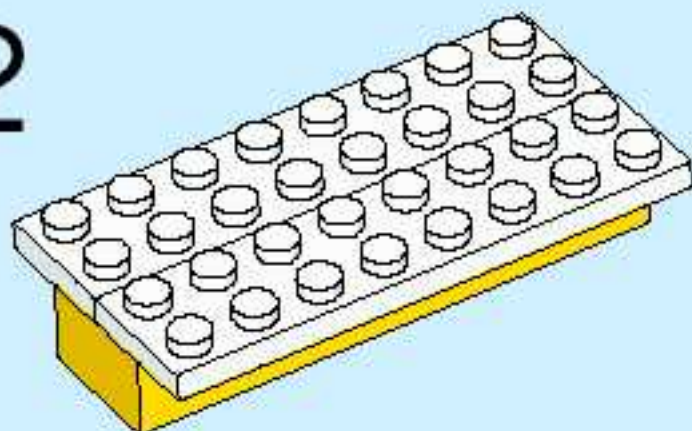

3

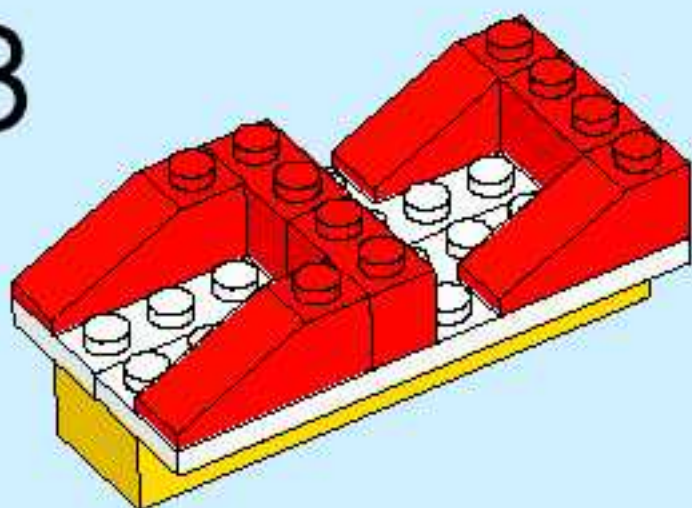

4

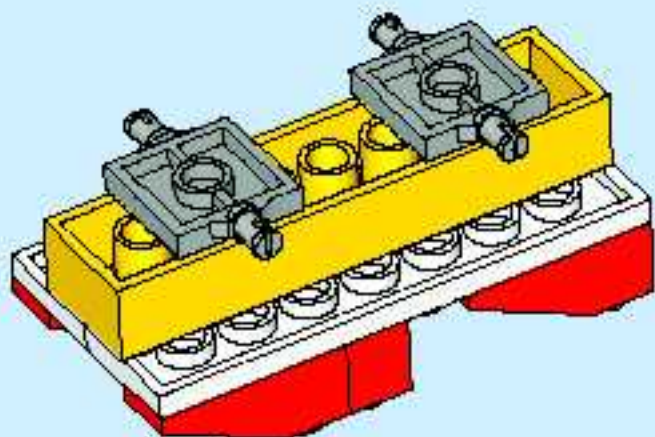

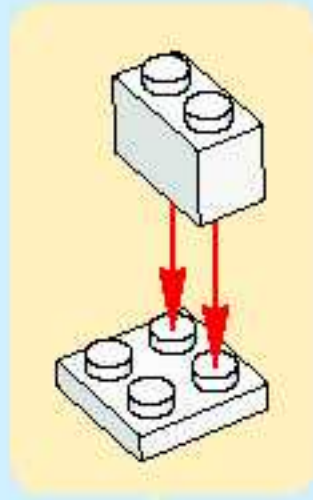

5

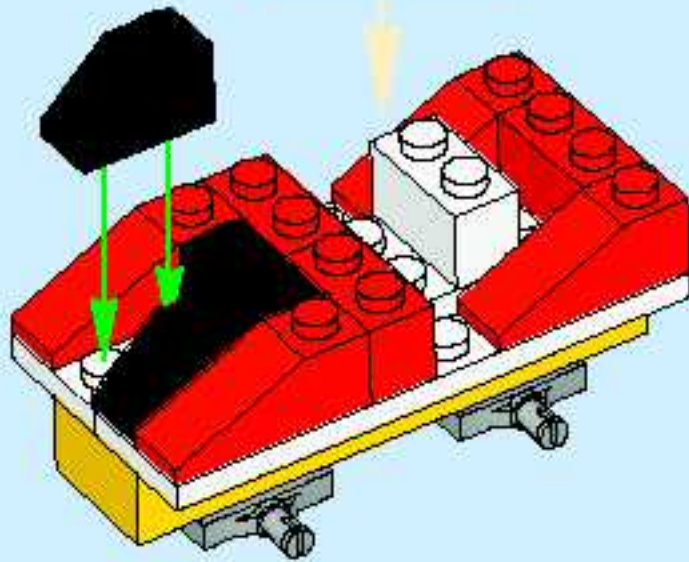

6

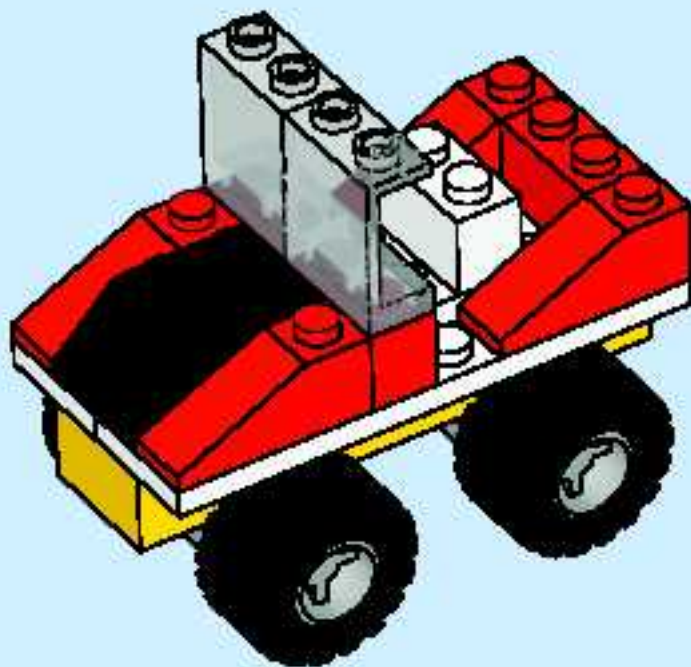

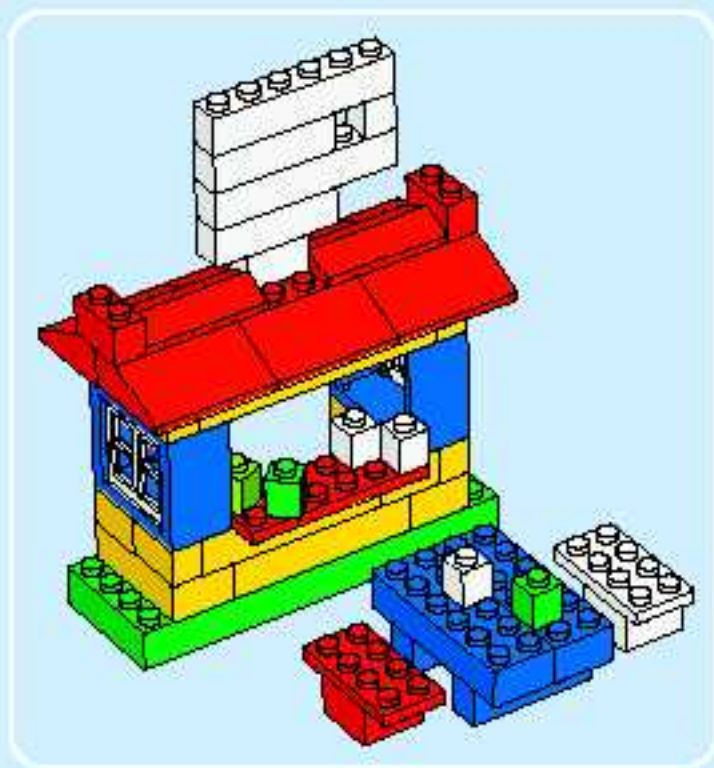

1

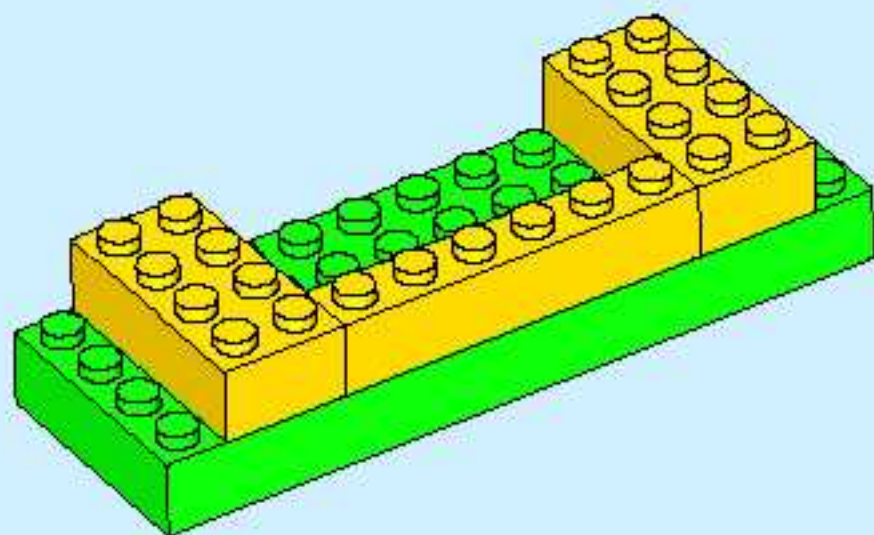

2

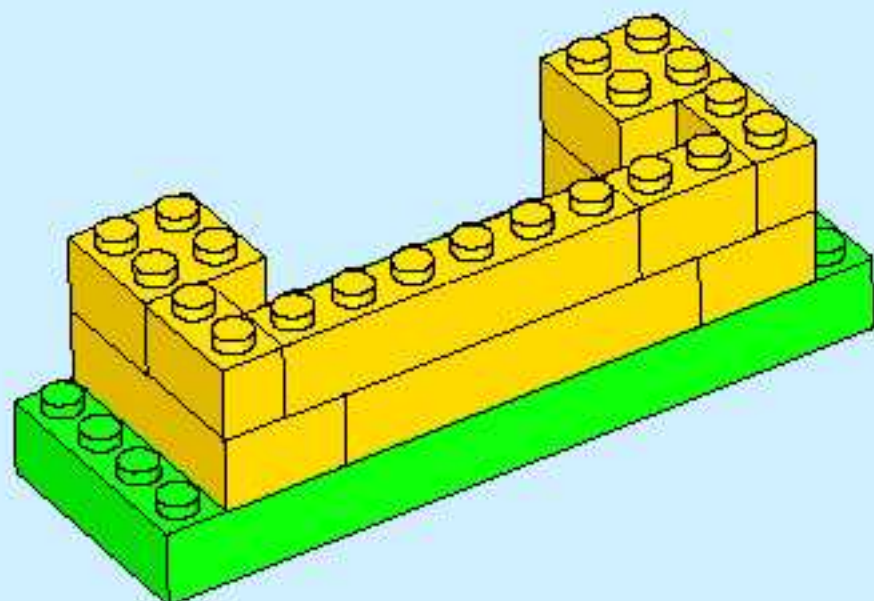

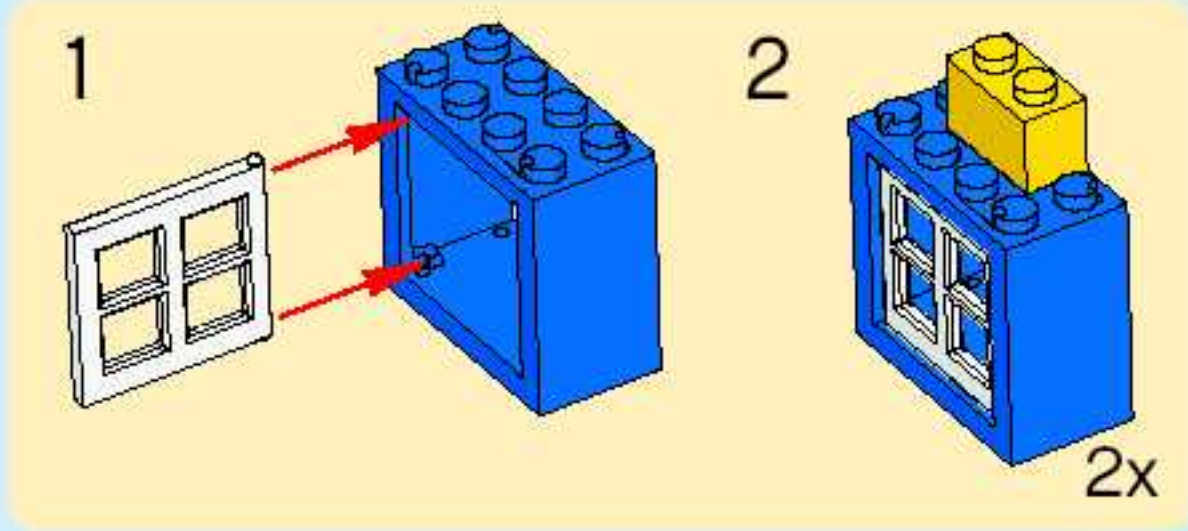

3

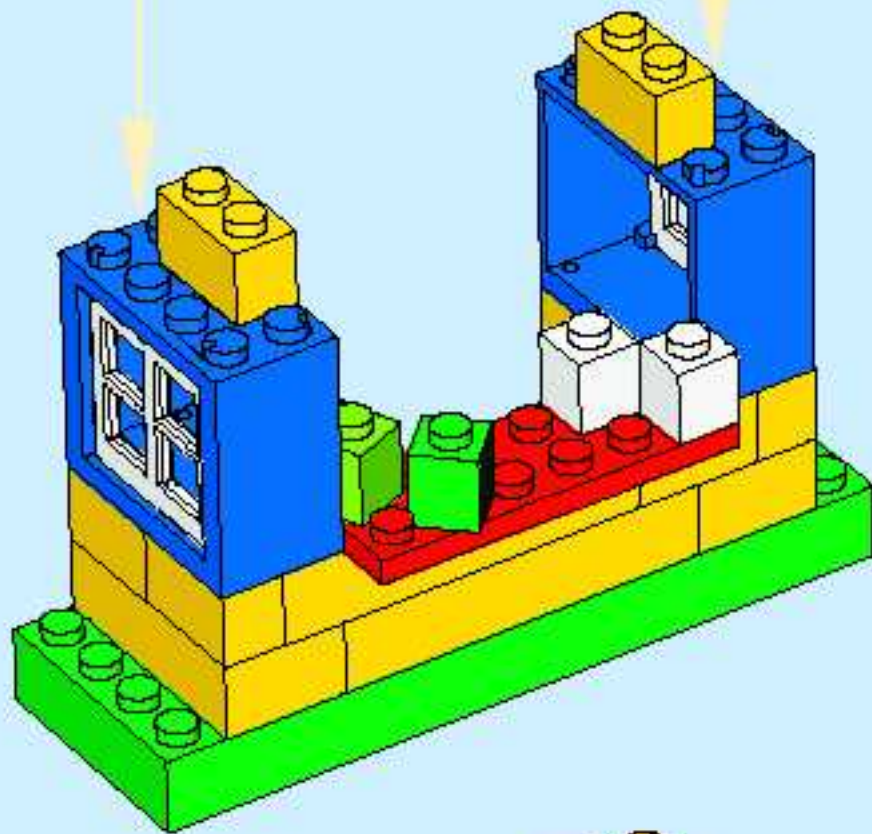

4

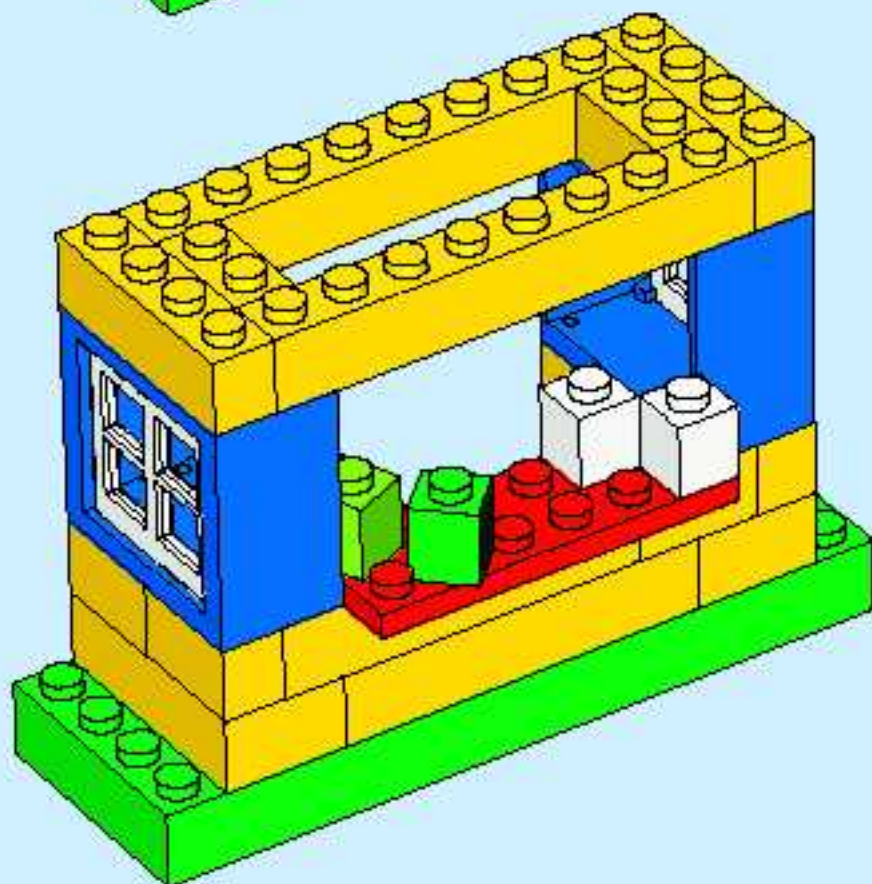

5

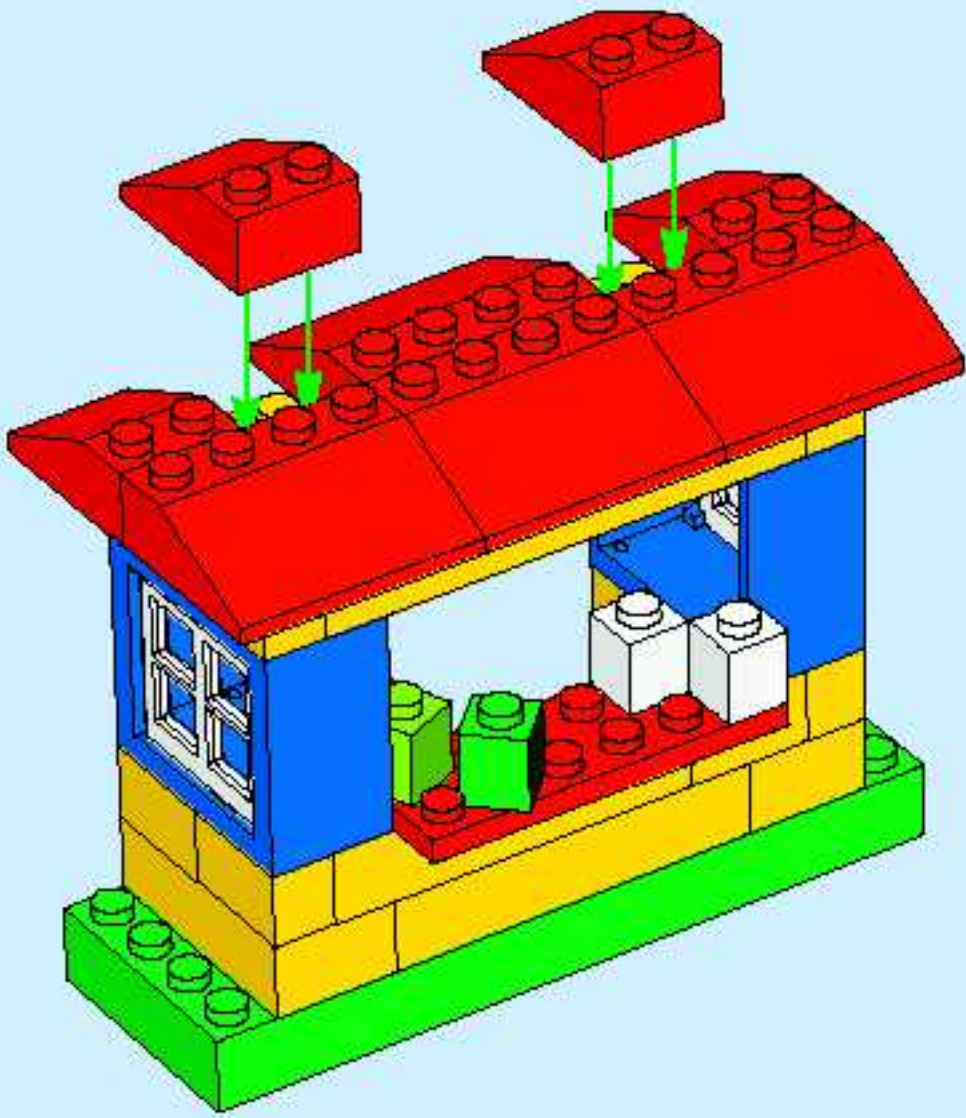

6

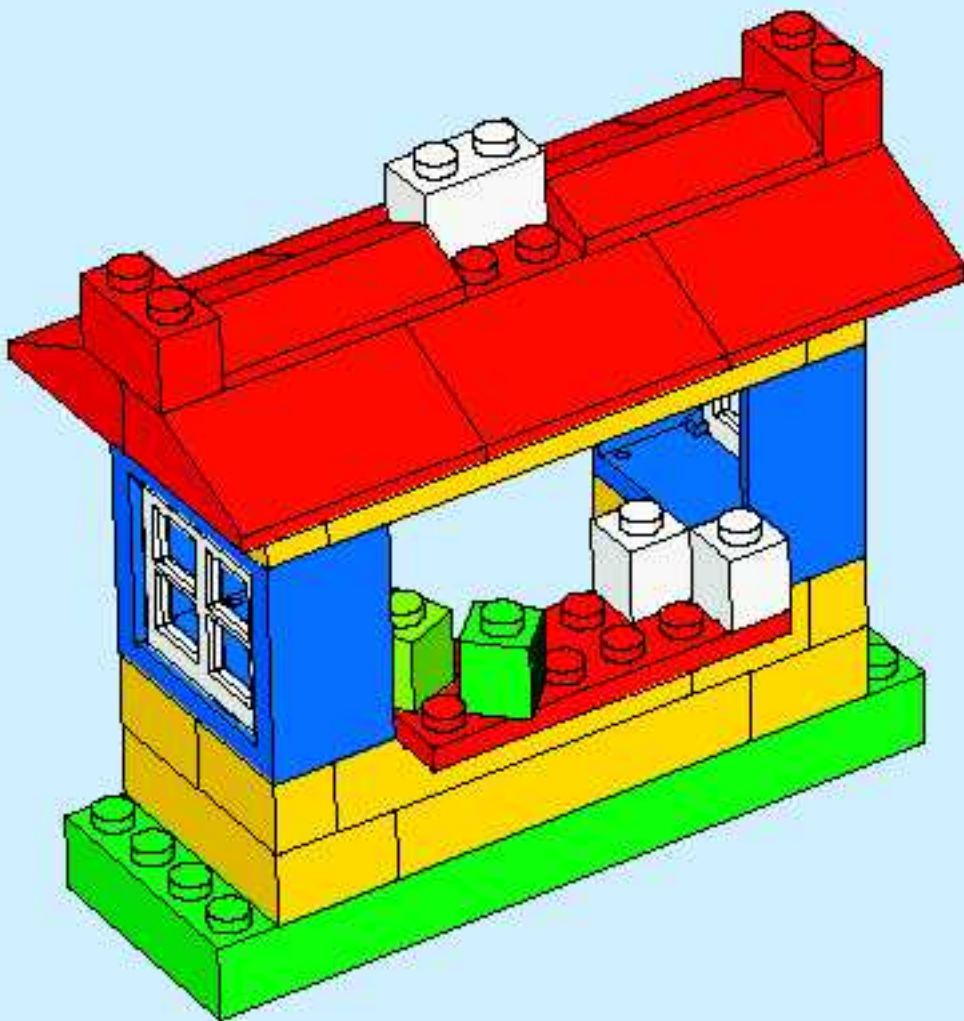

7

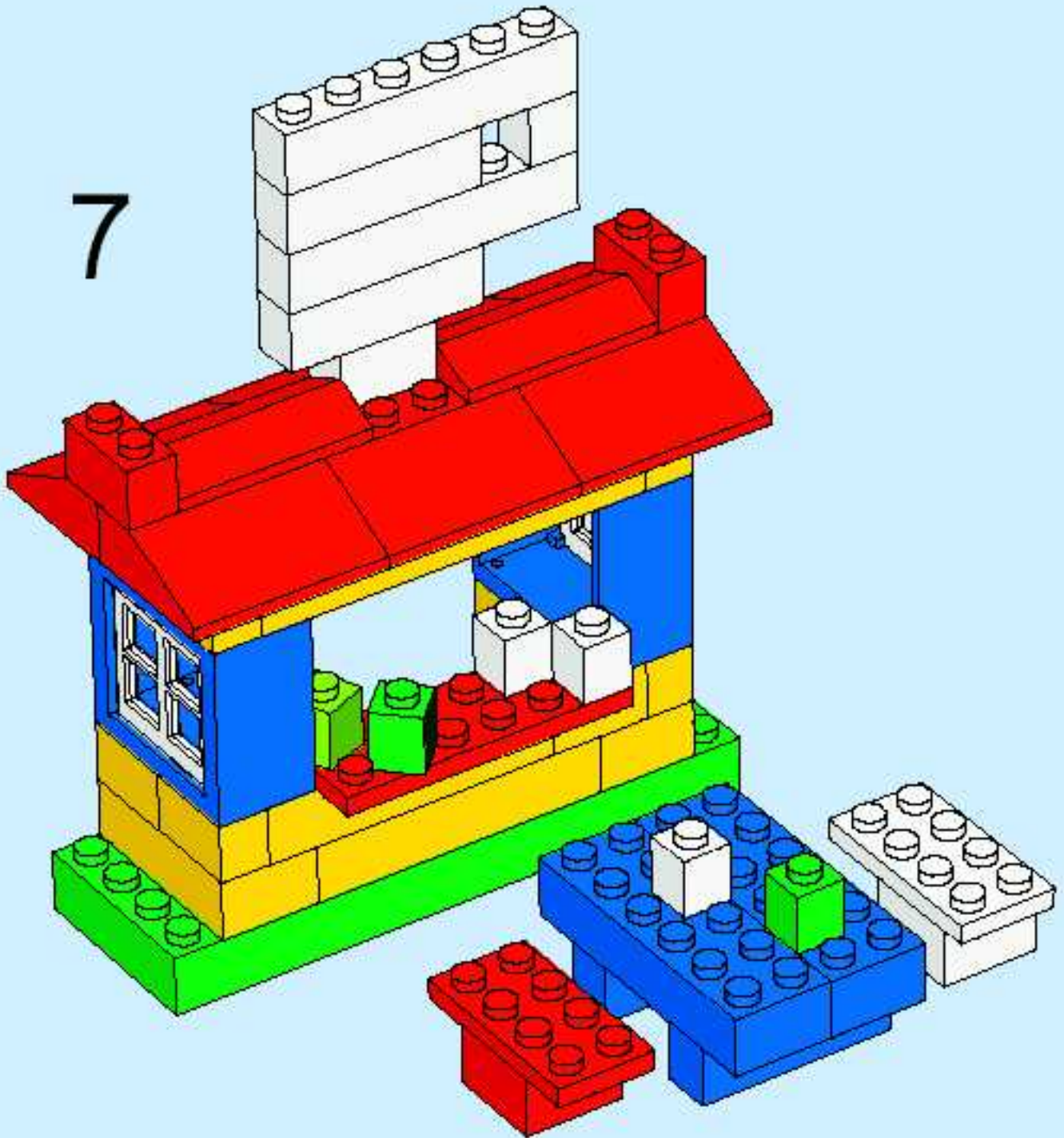

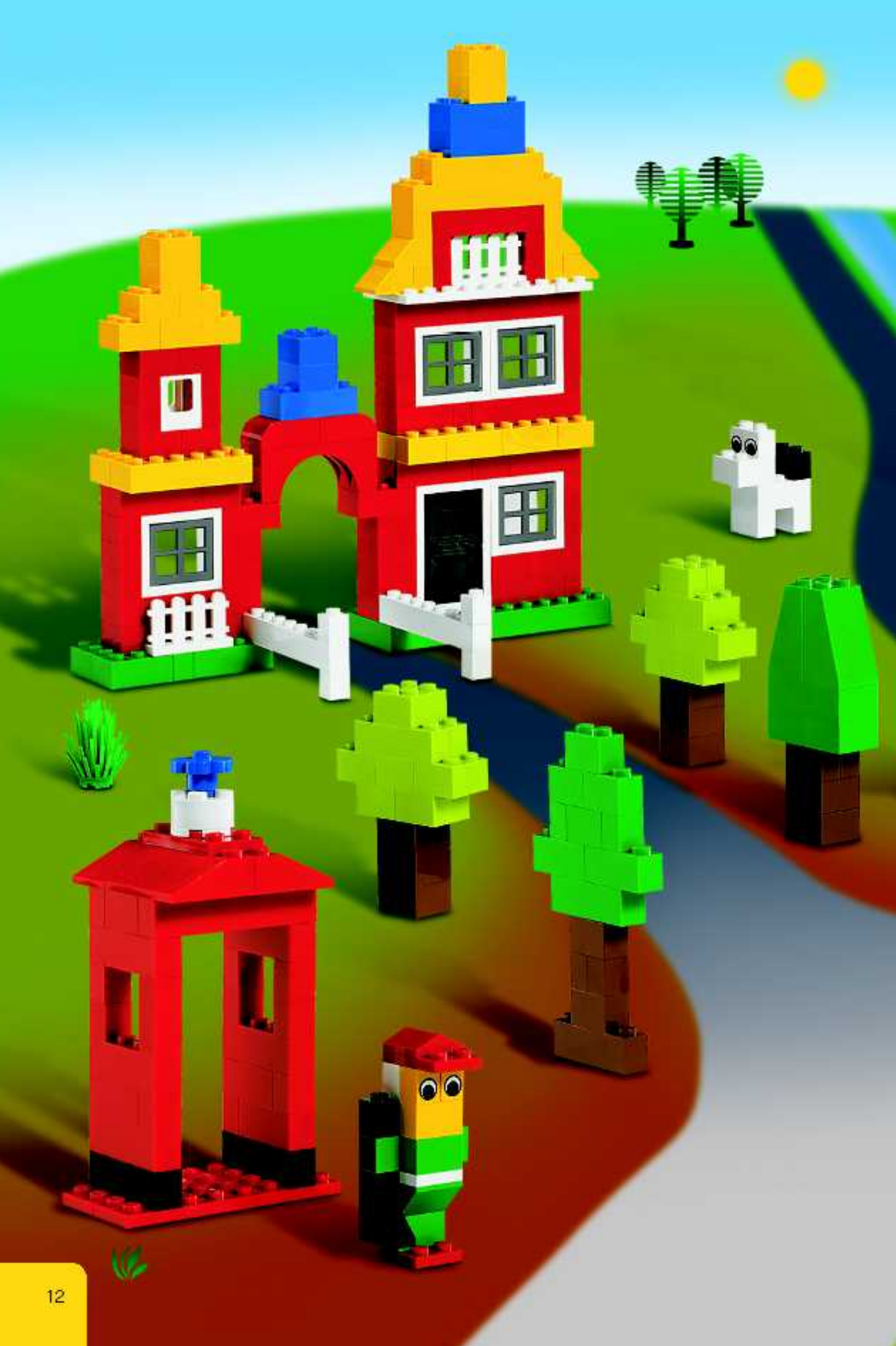



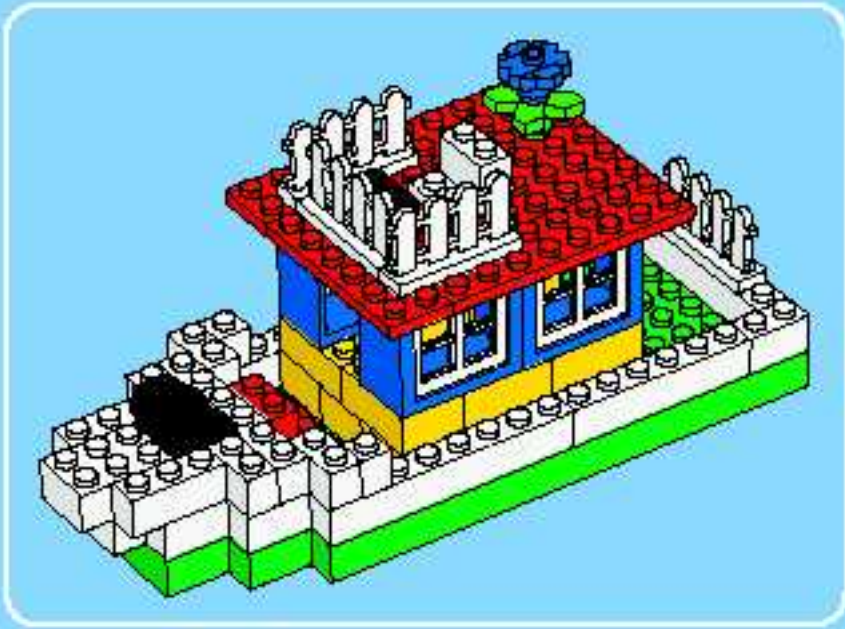

1

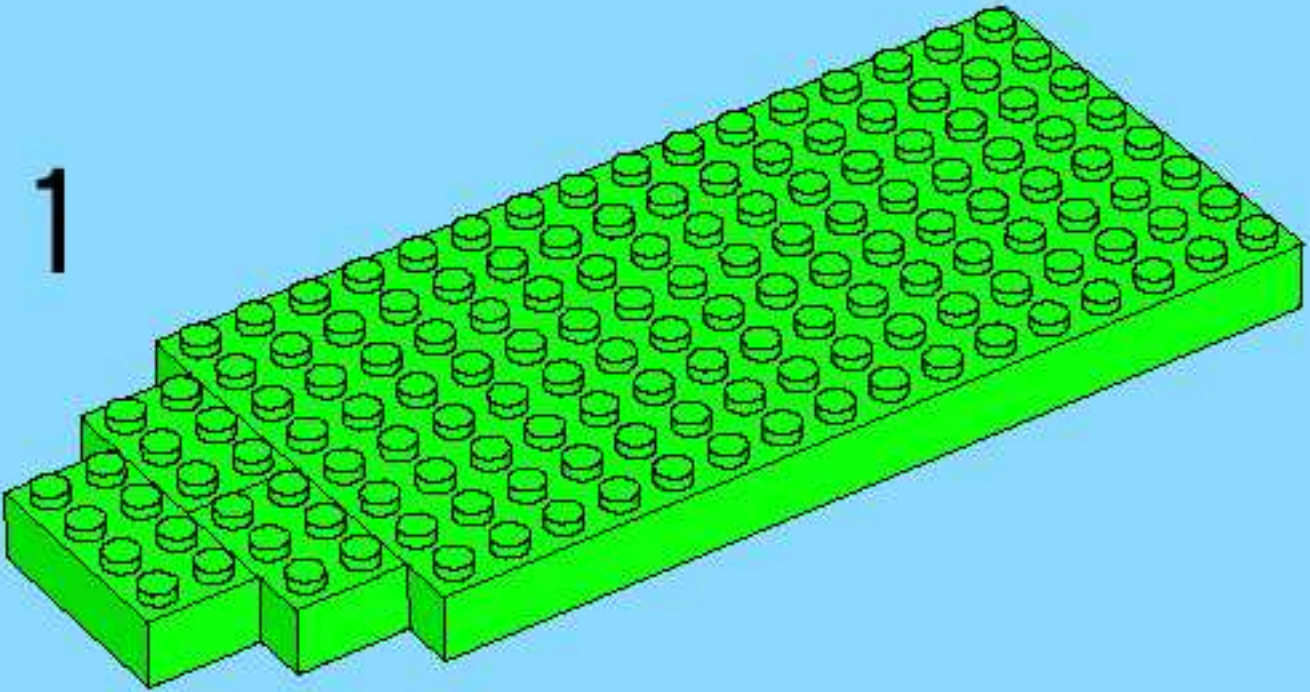

2

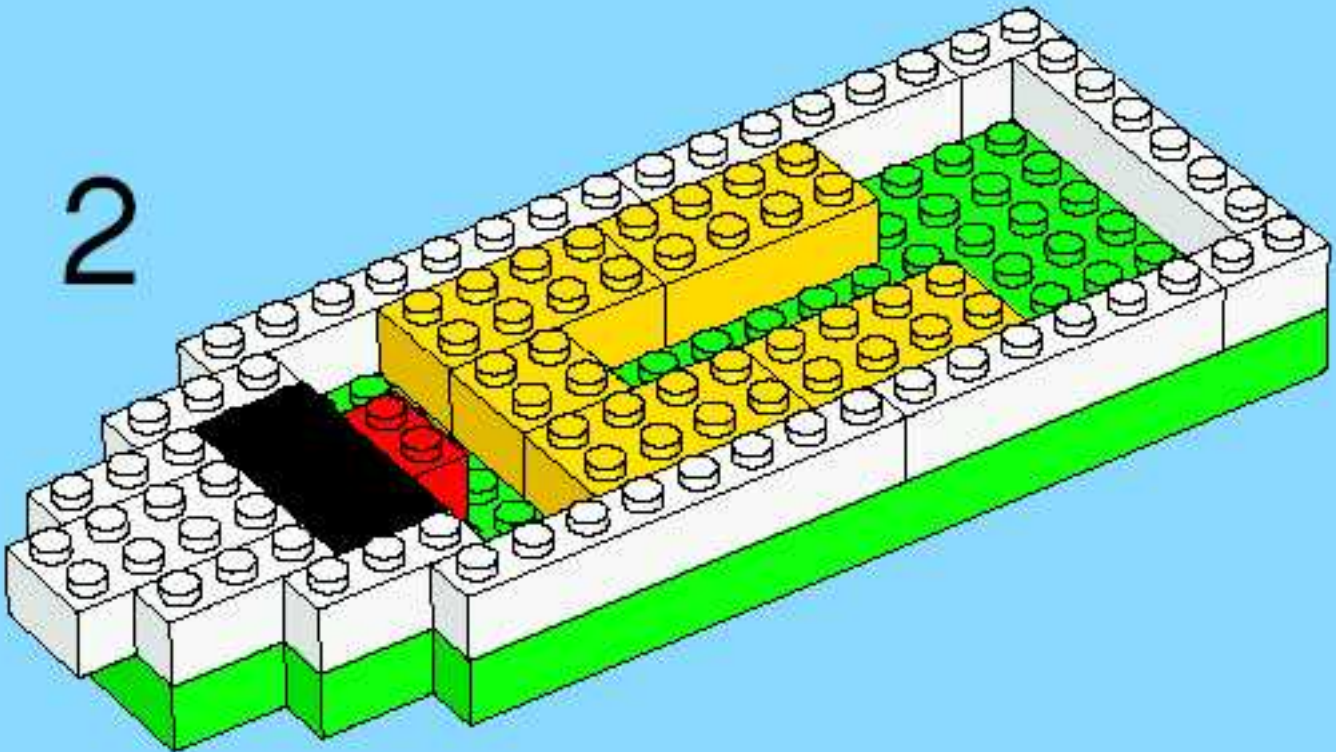

3

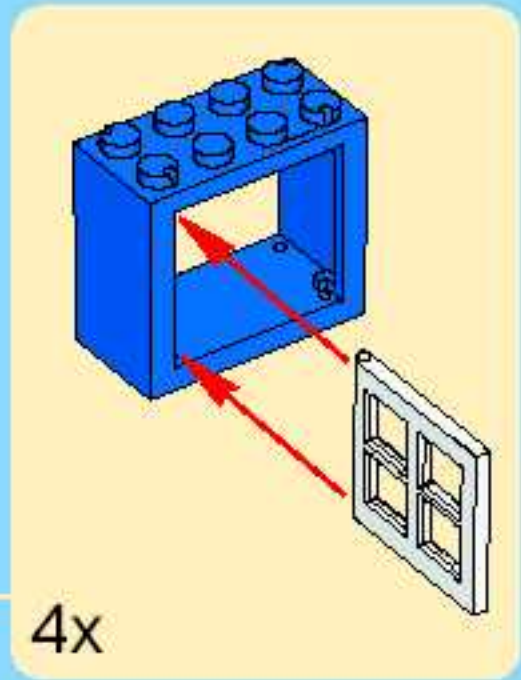
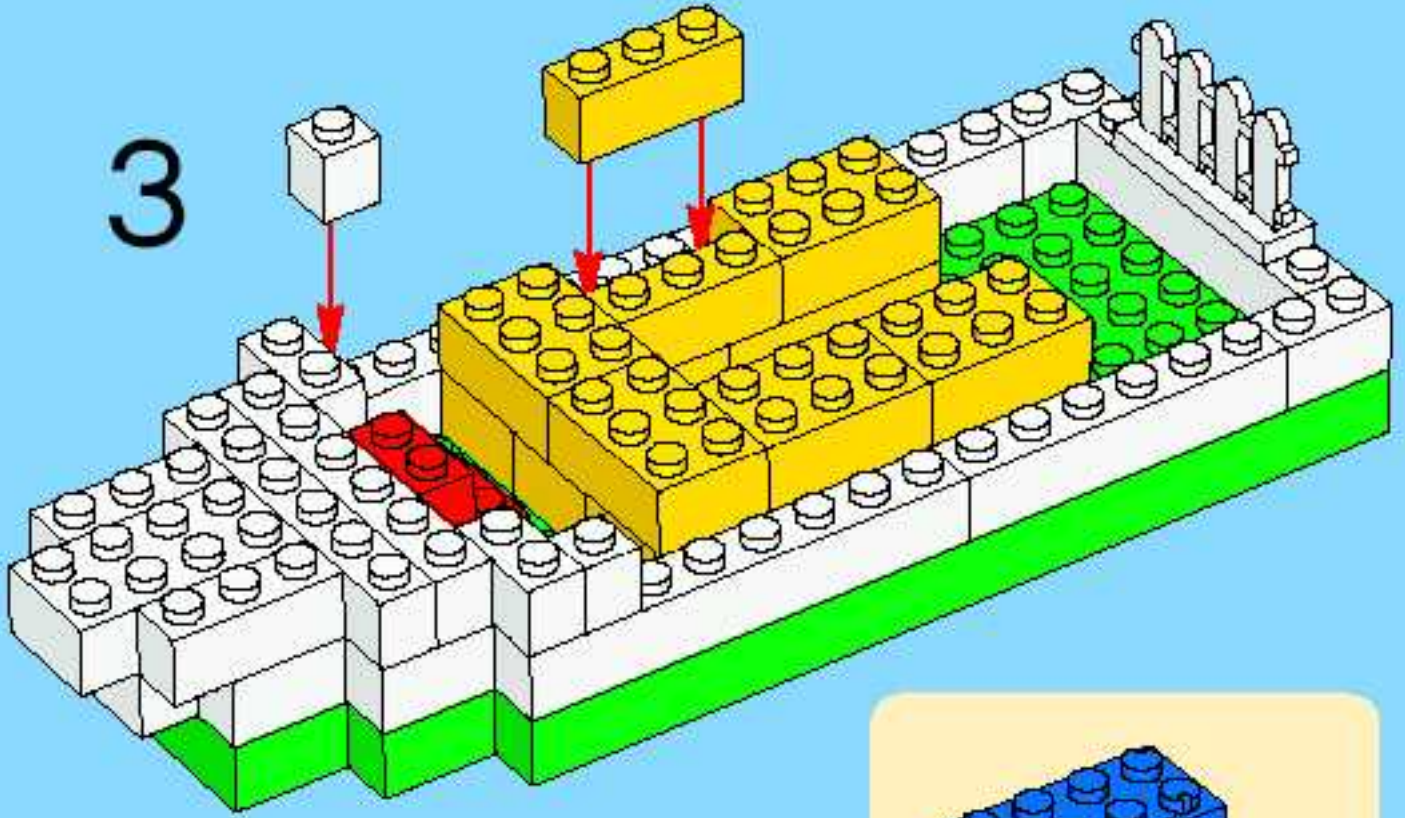

4x

4

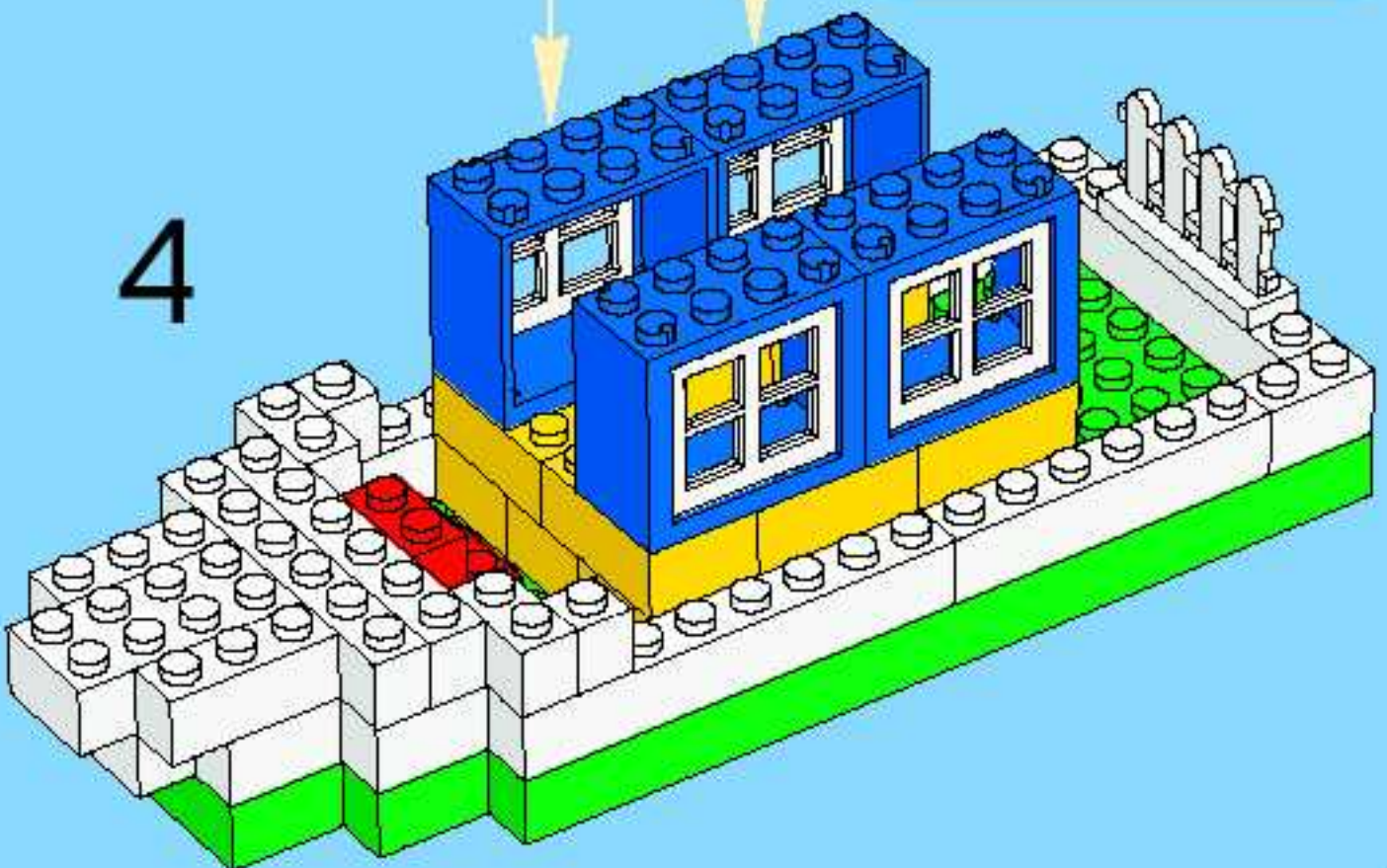

5



6

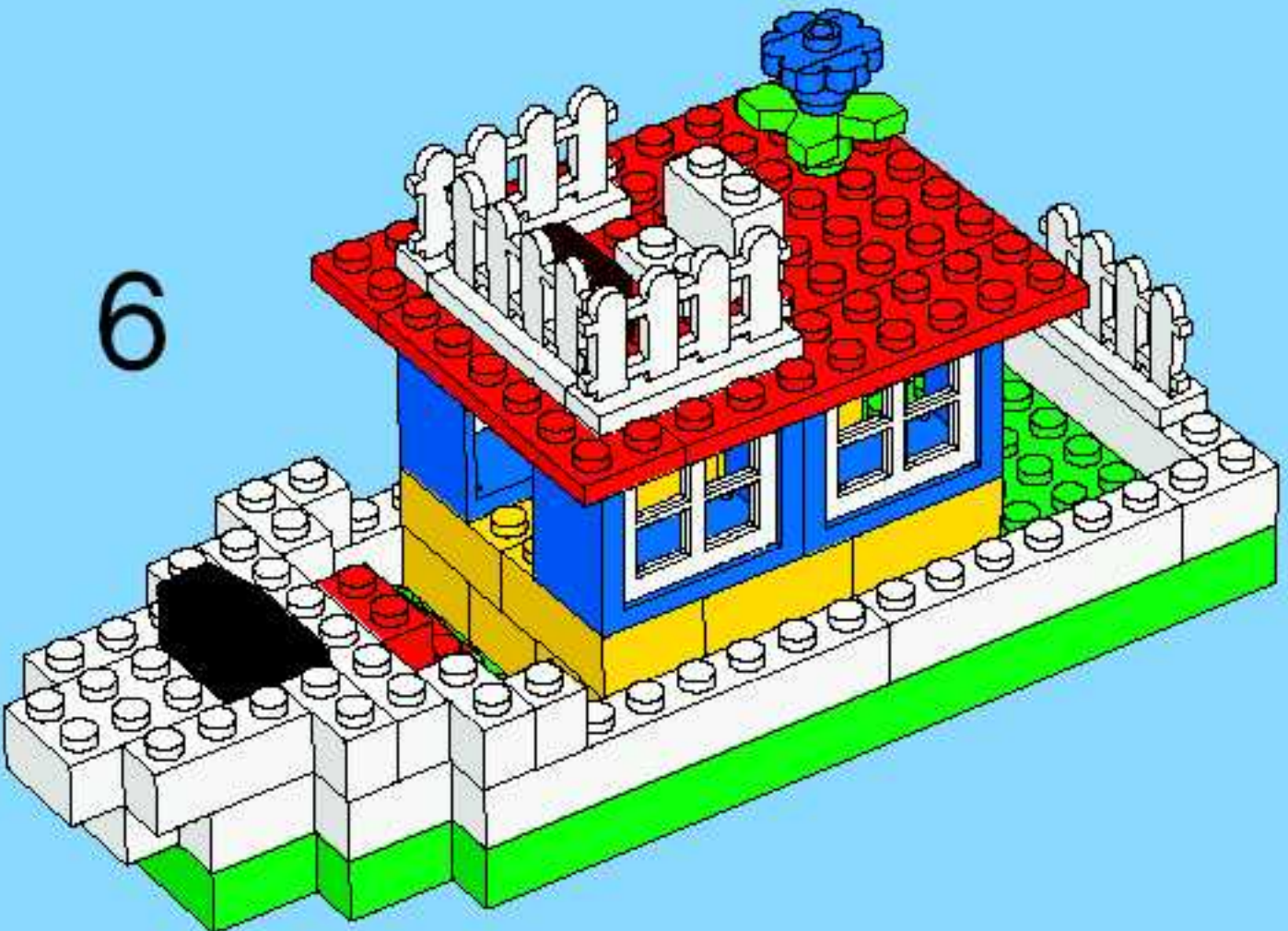



1

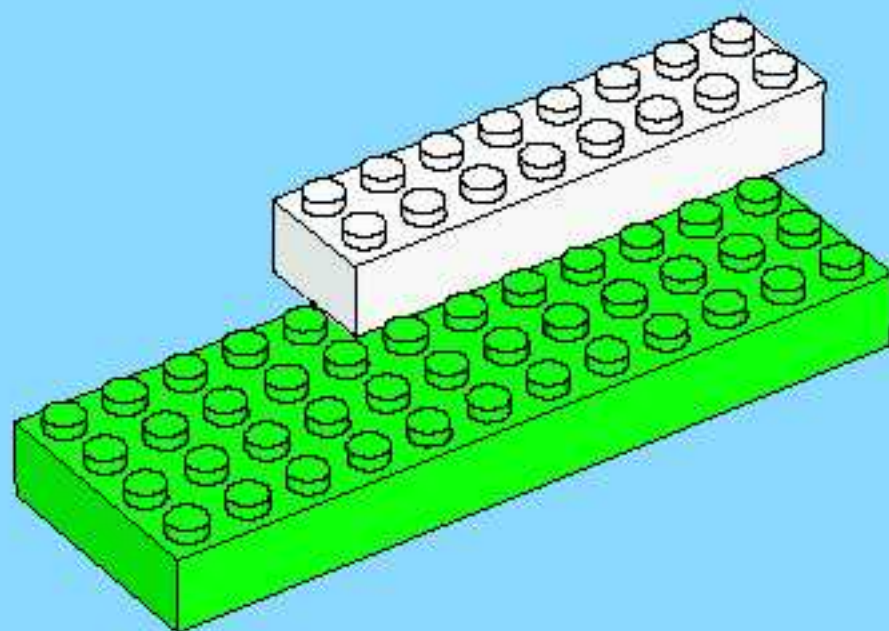

2

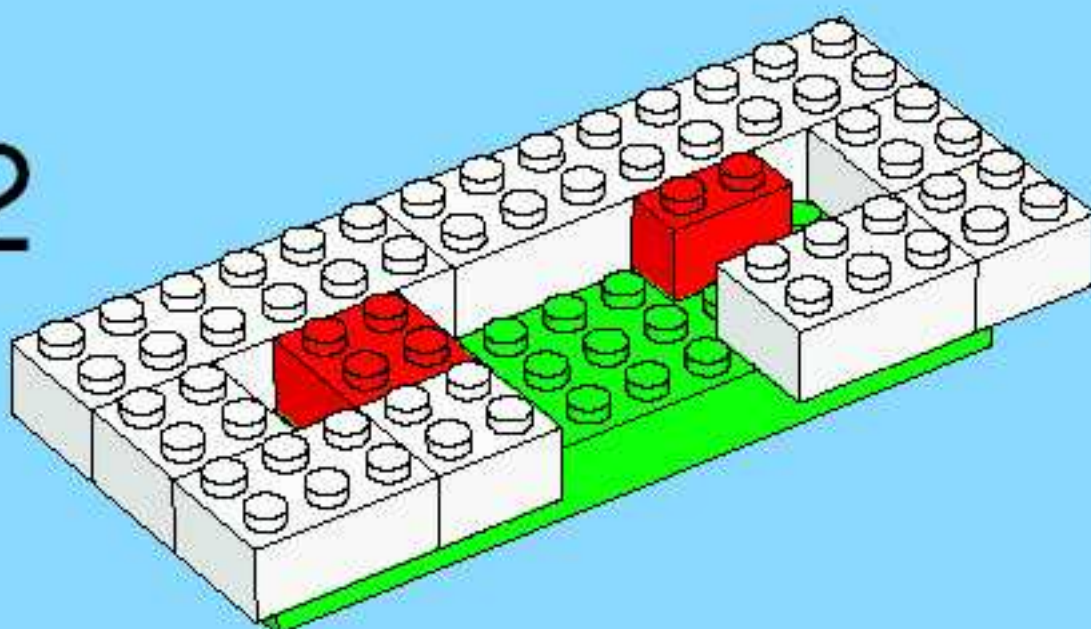

3

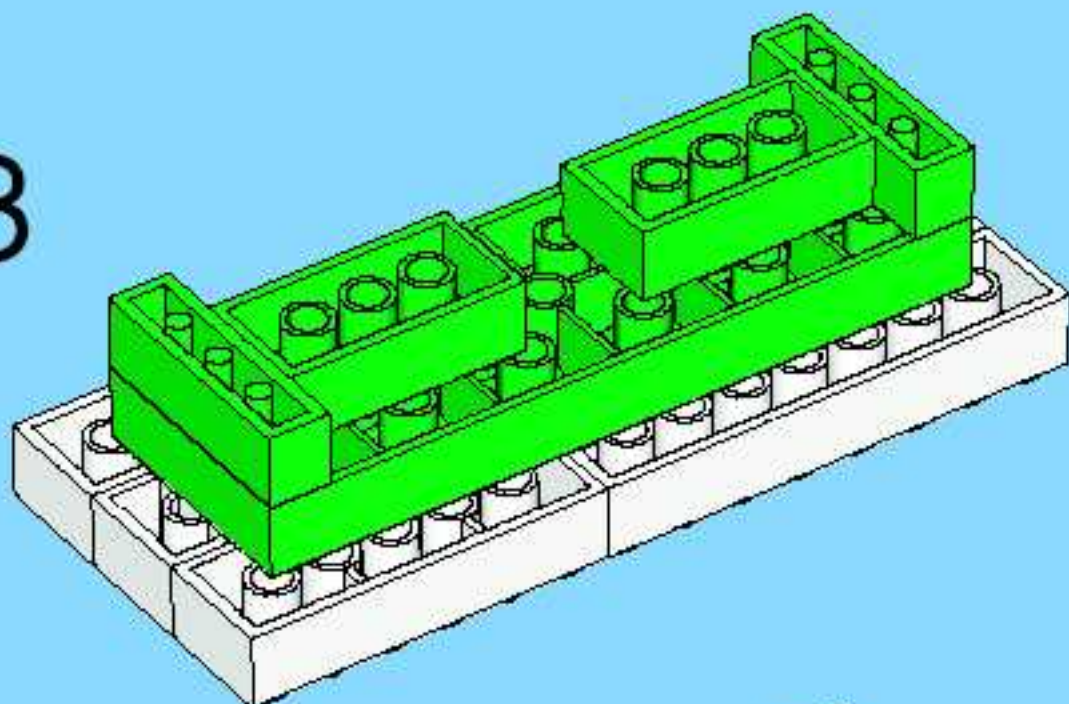

4

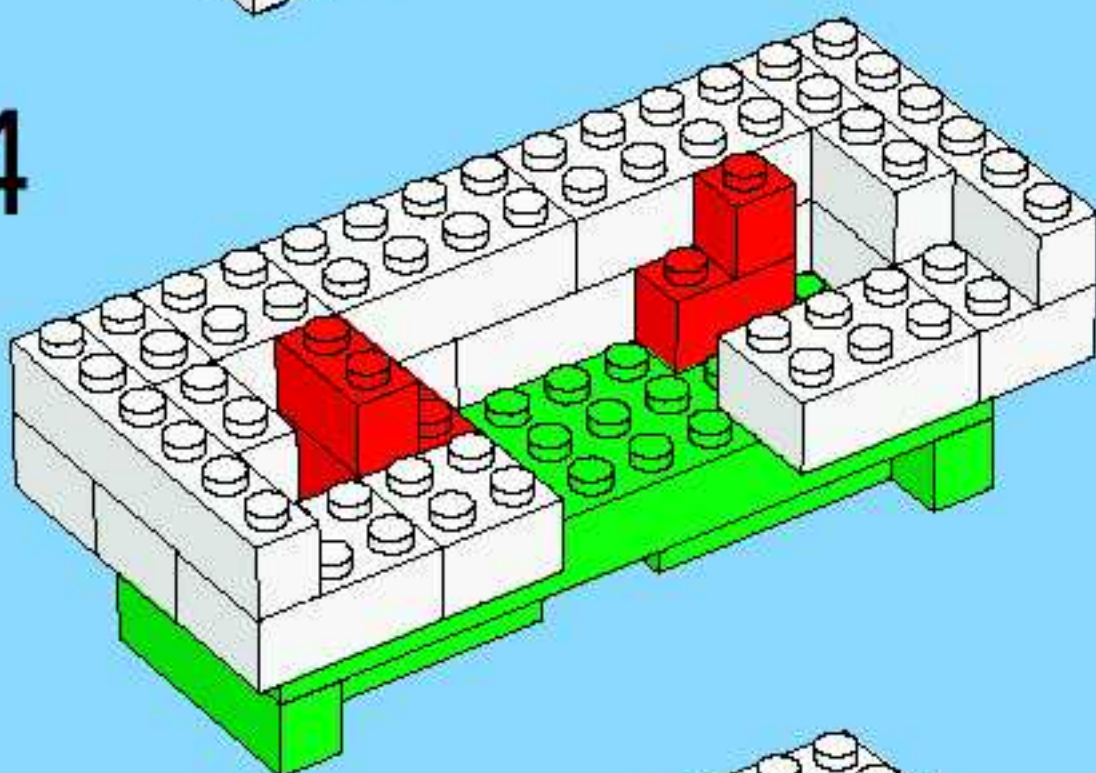

5

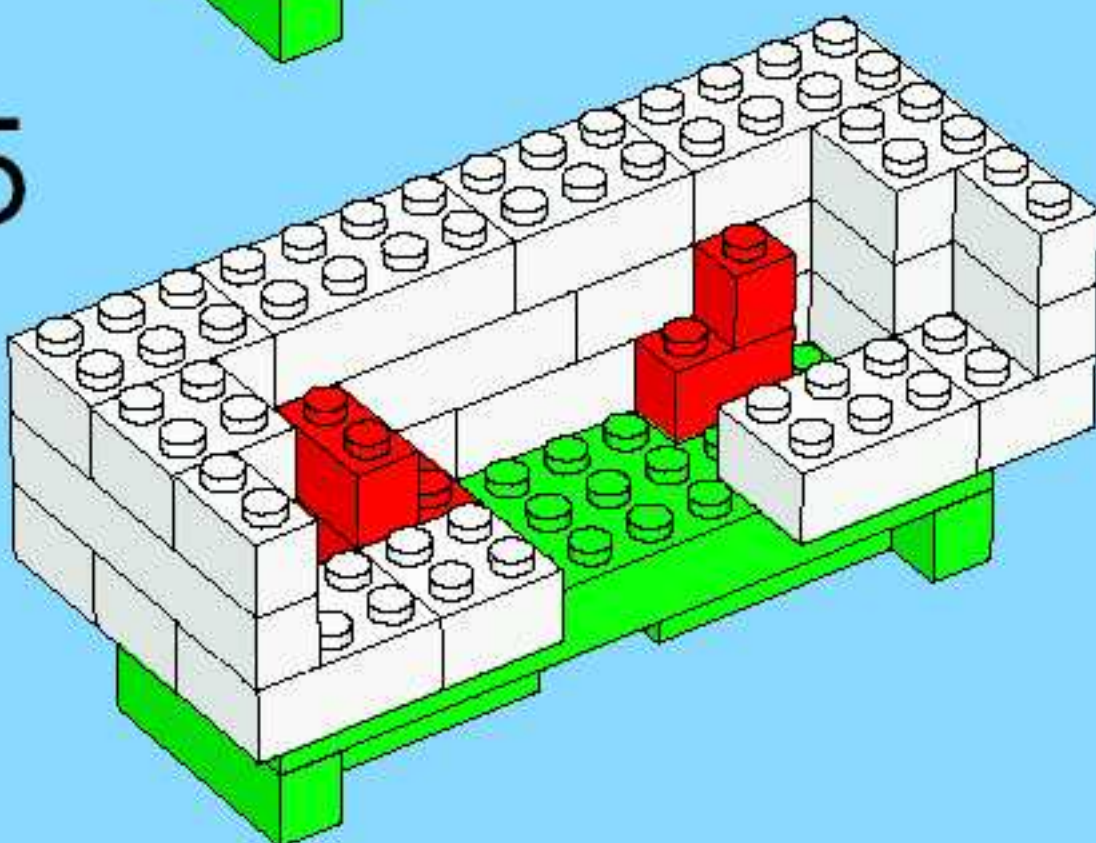

6

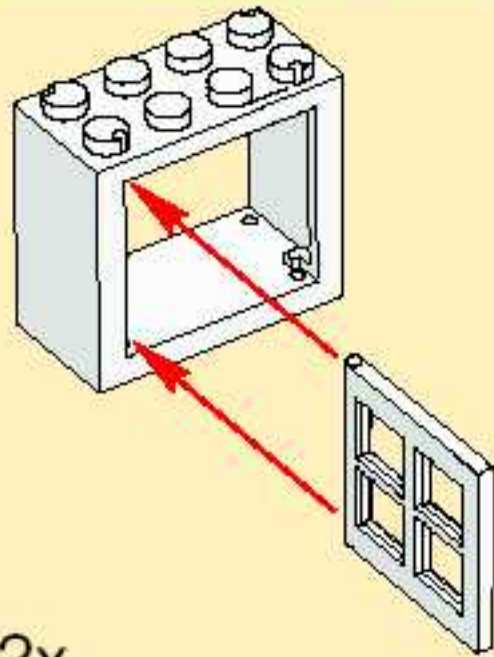
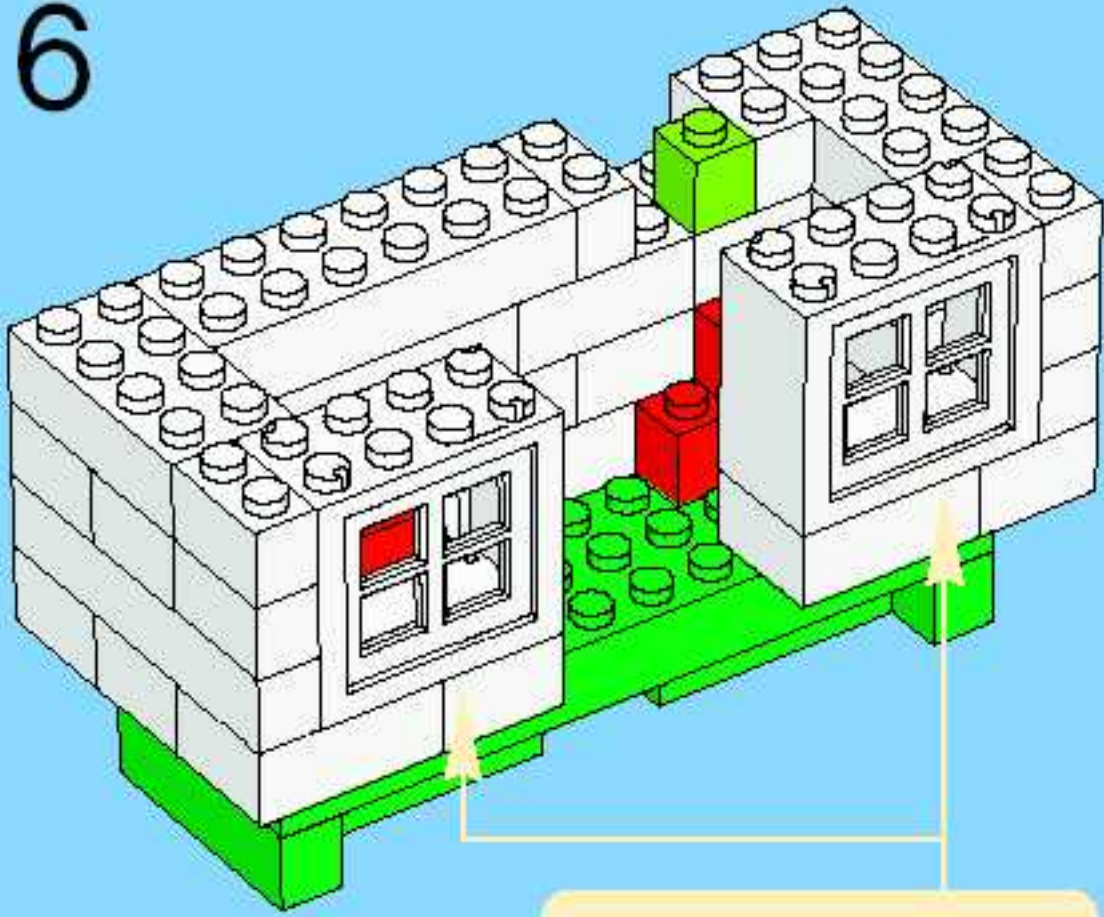

2x

7

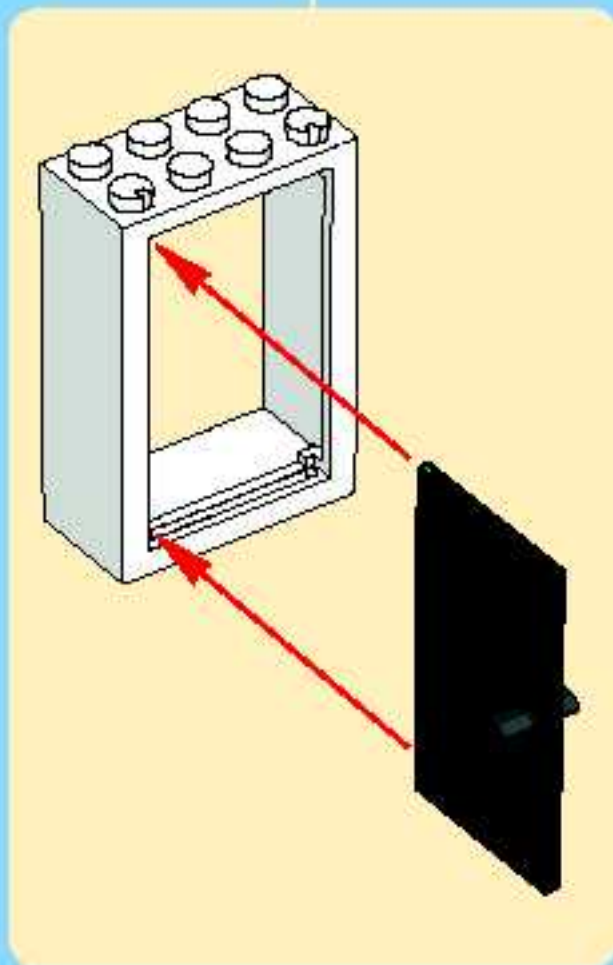
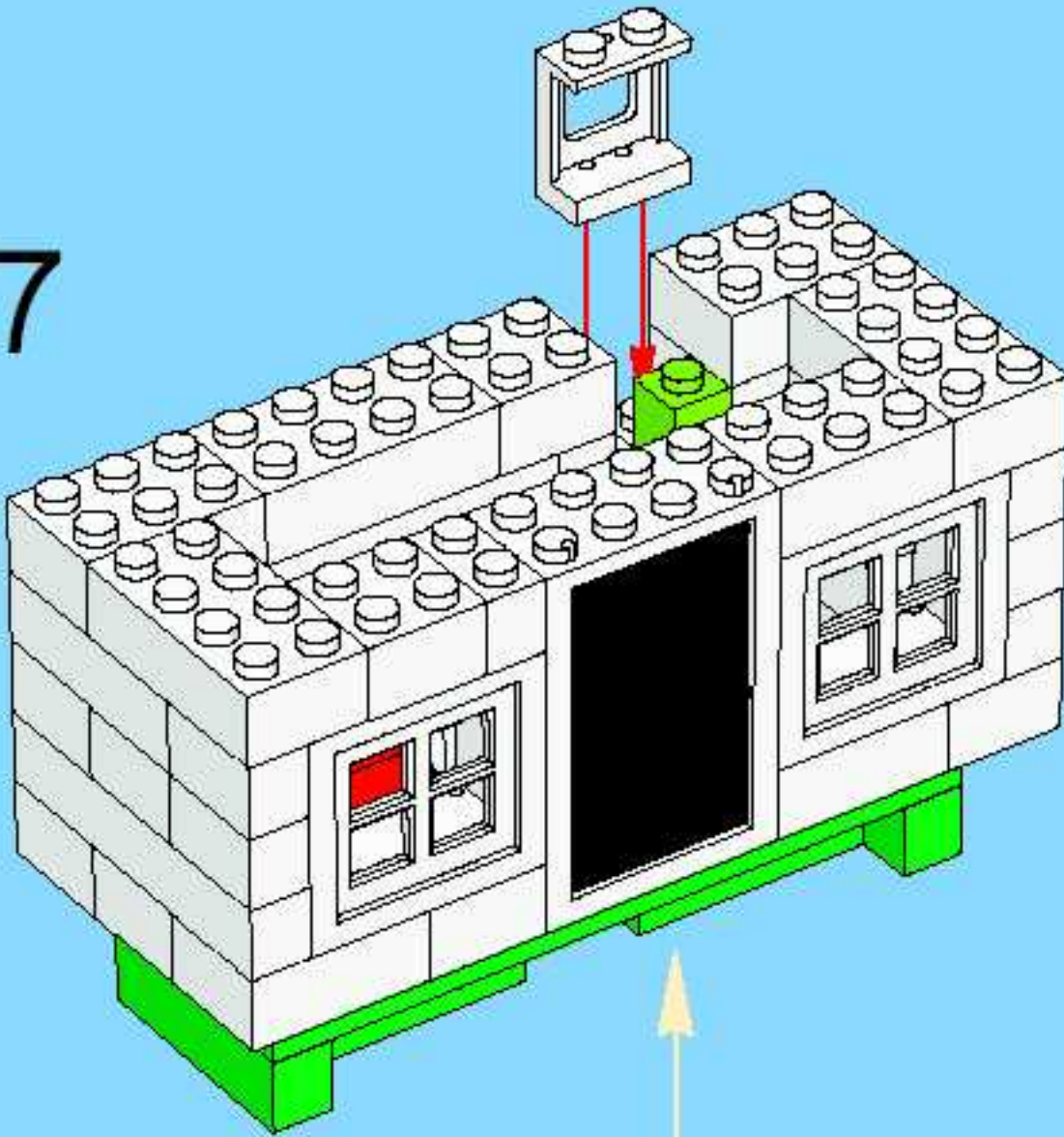

8

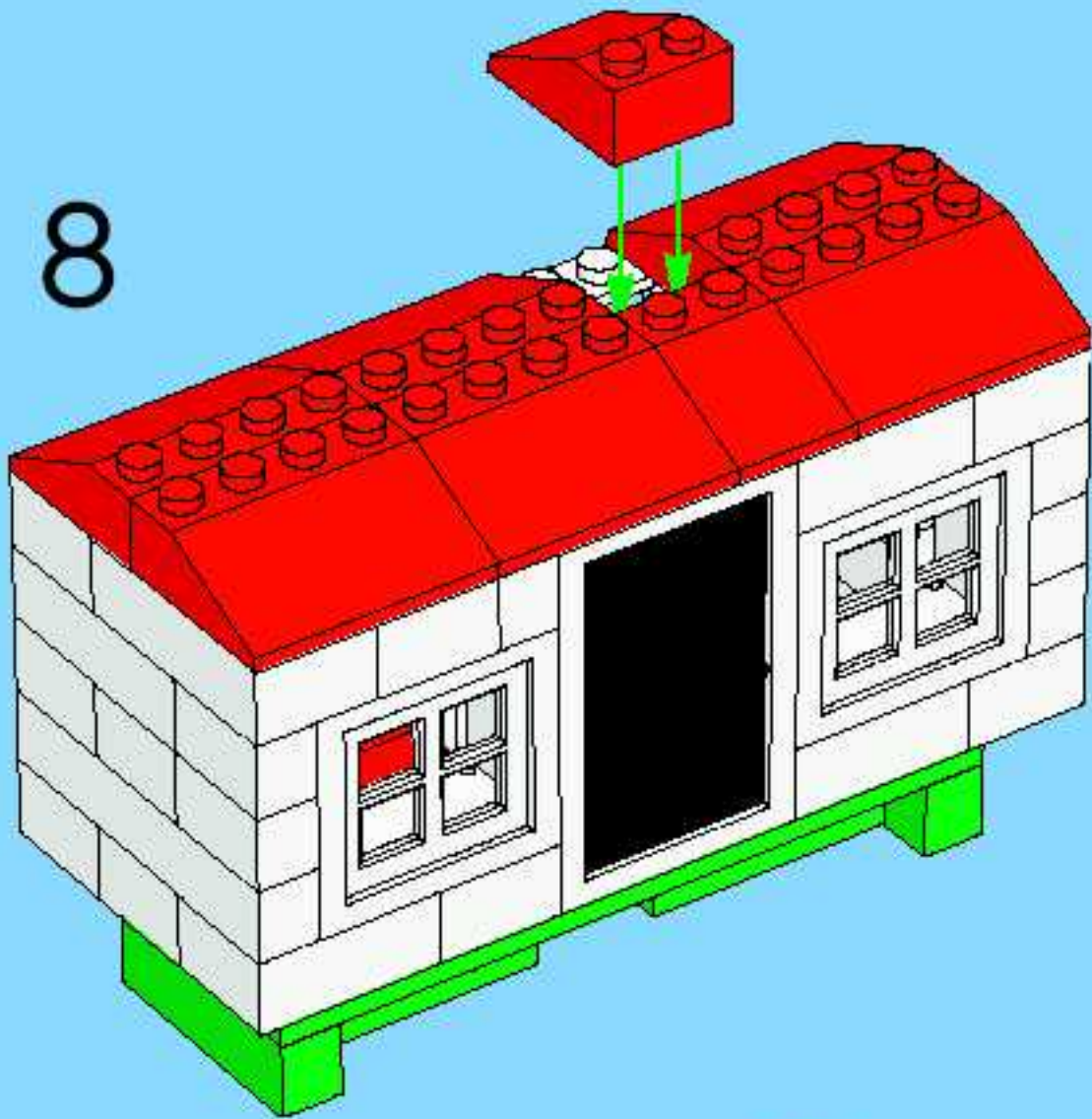

9

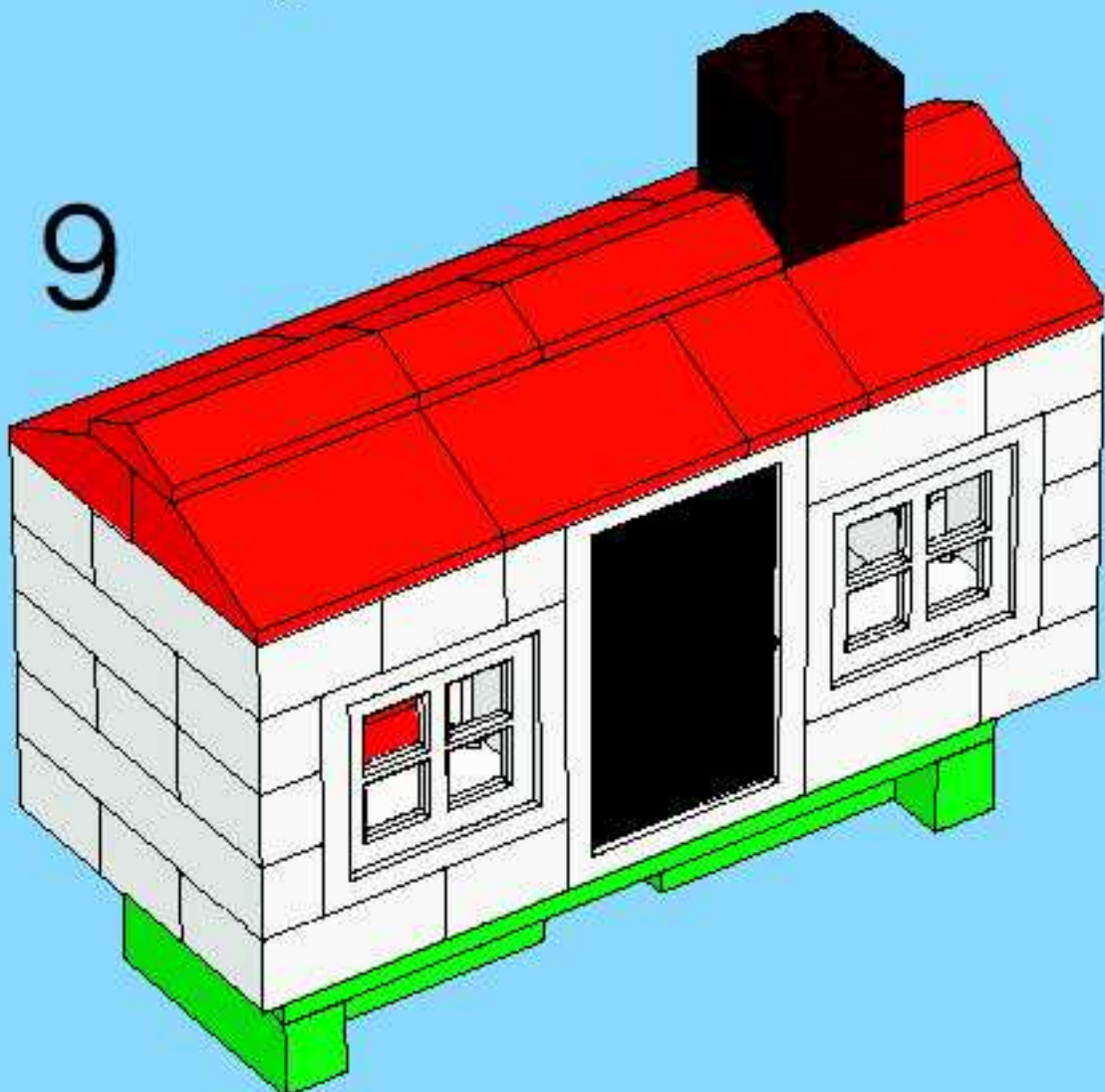

10

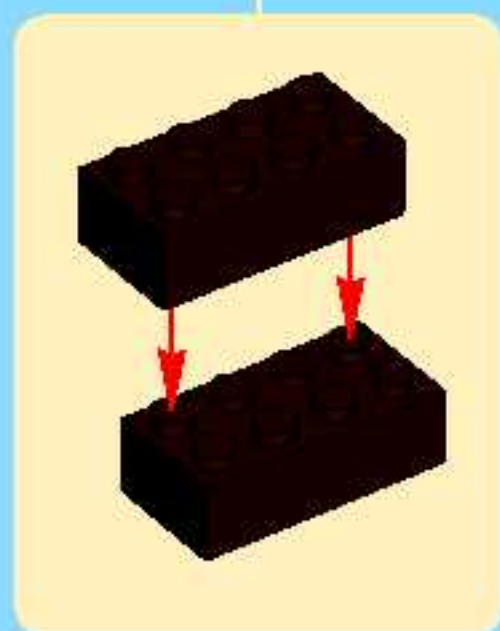
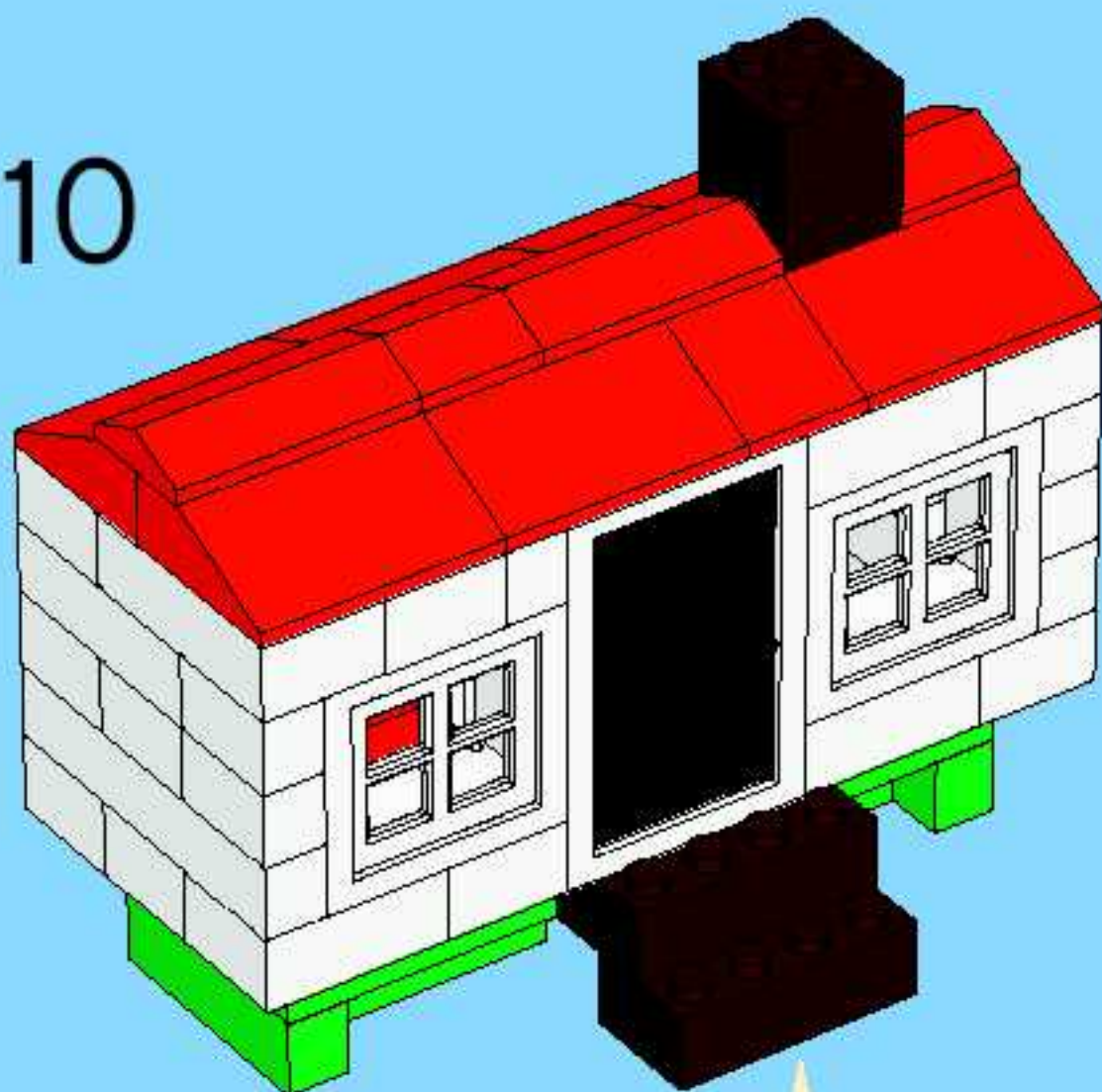

11

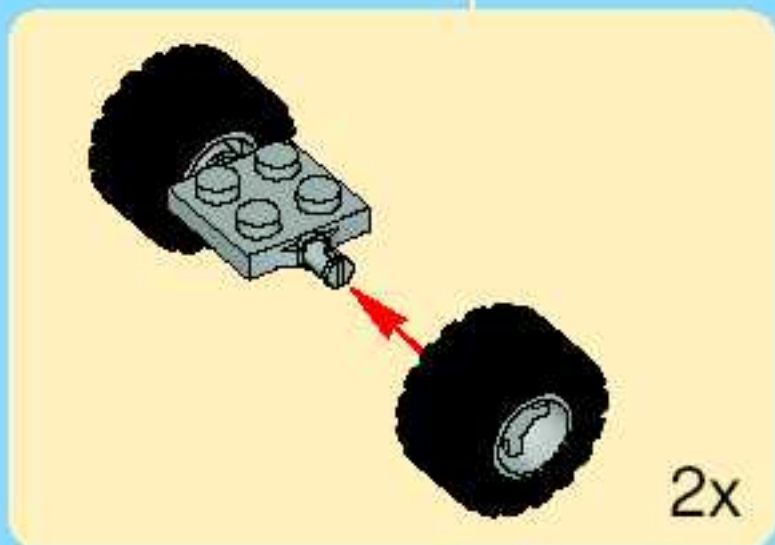
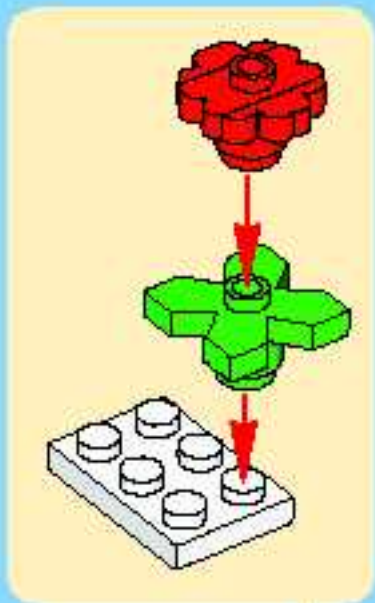
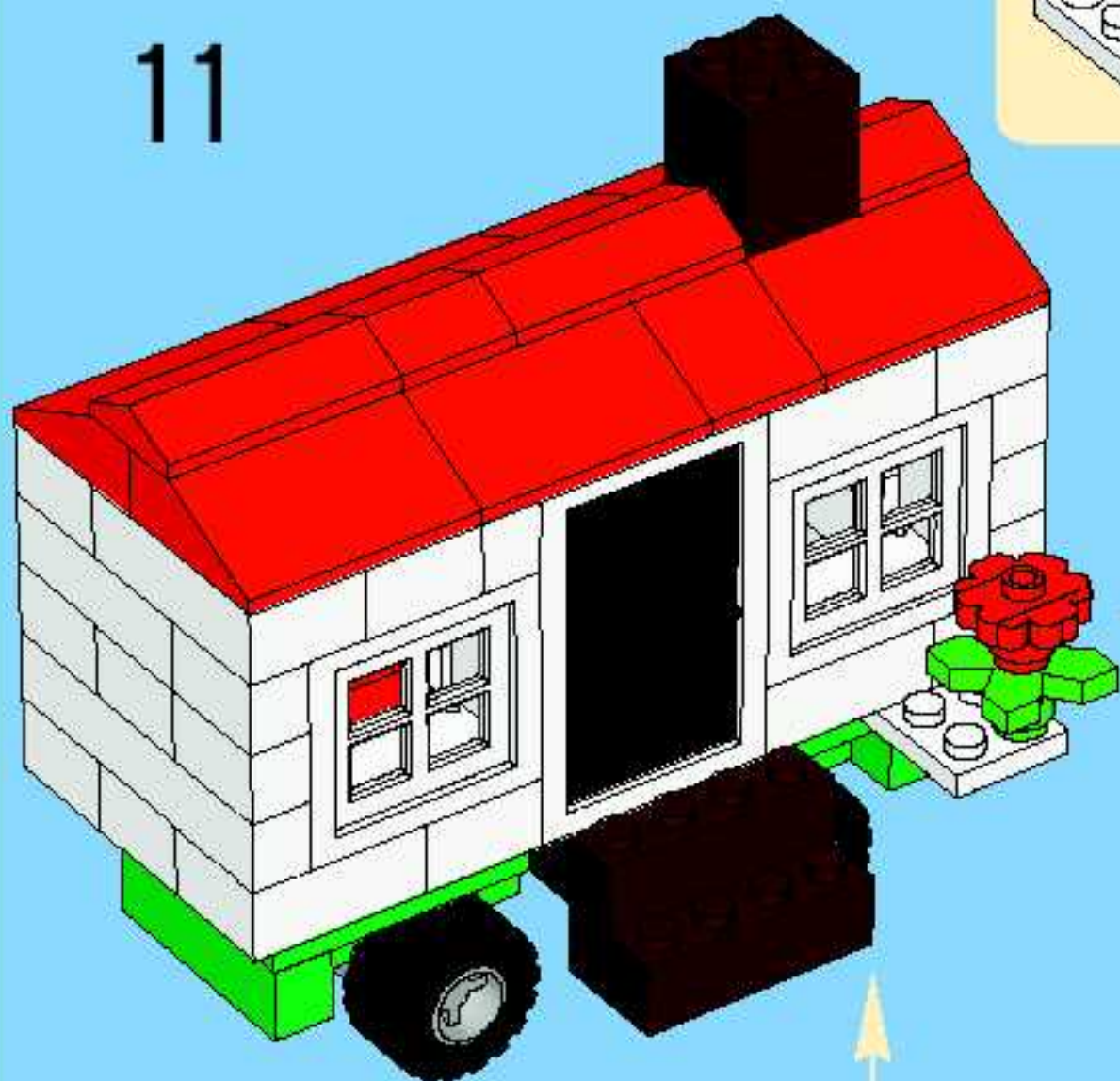











1

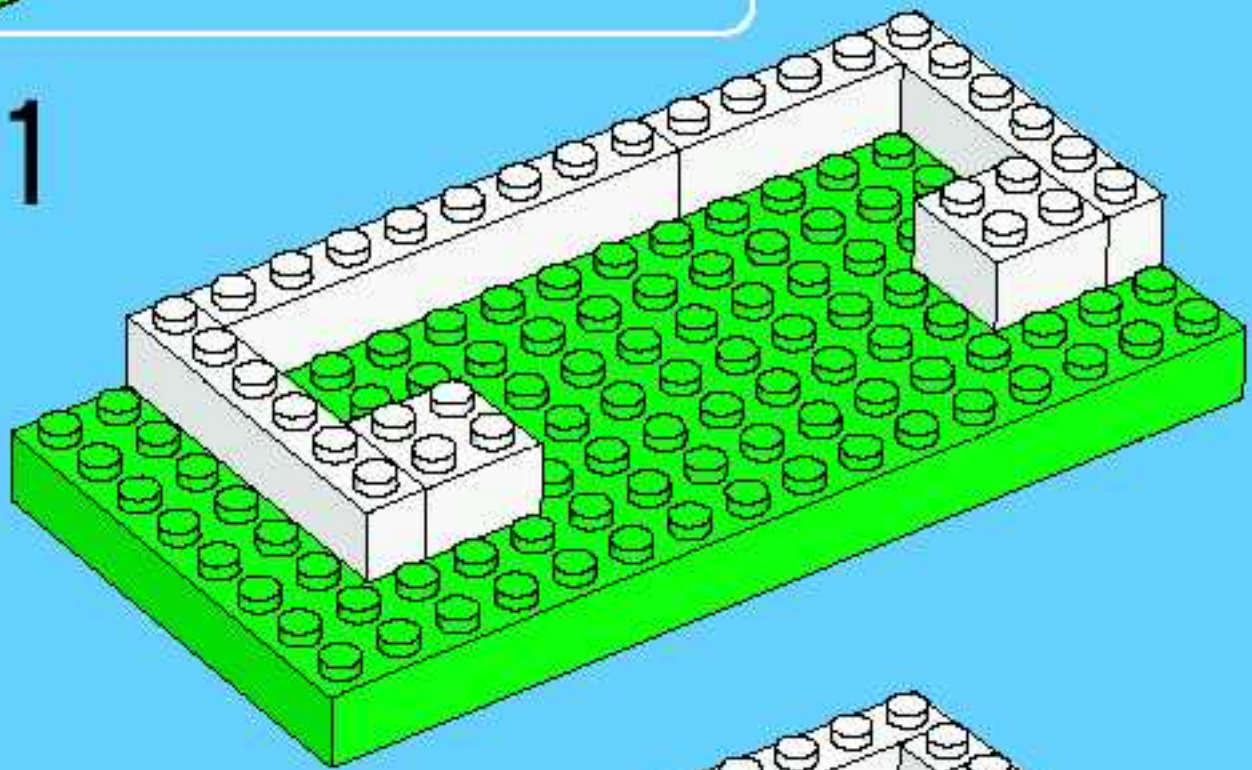

2

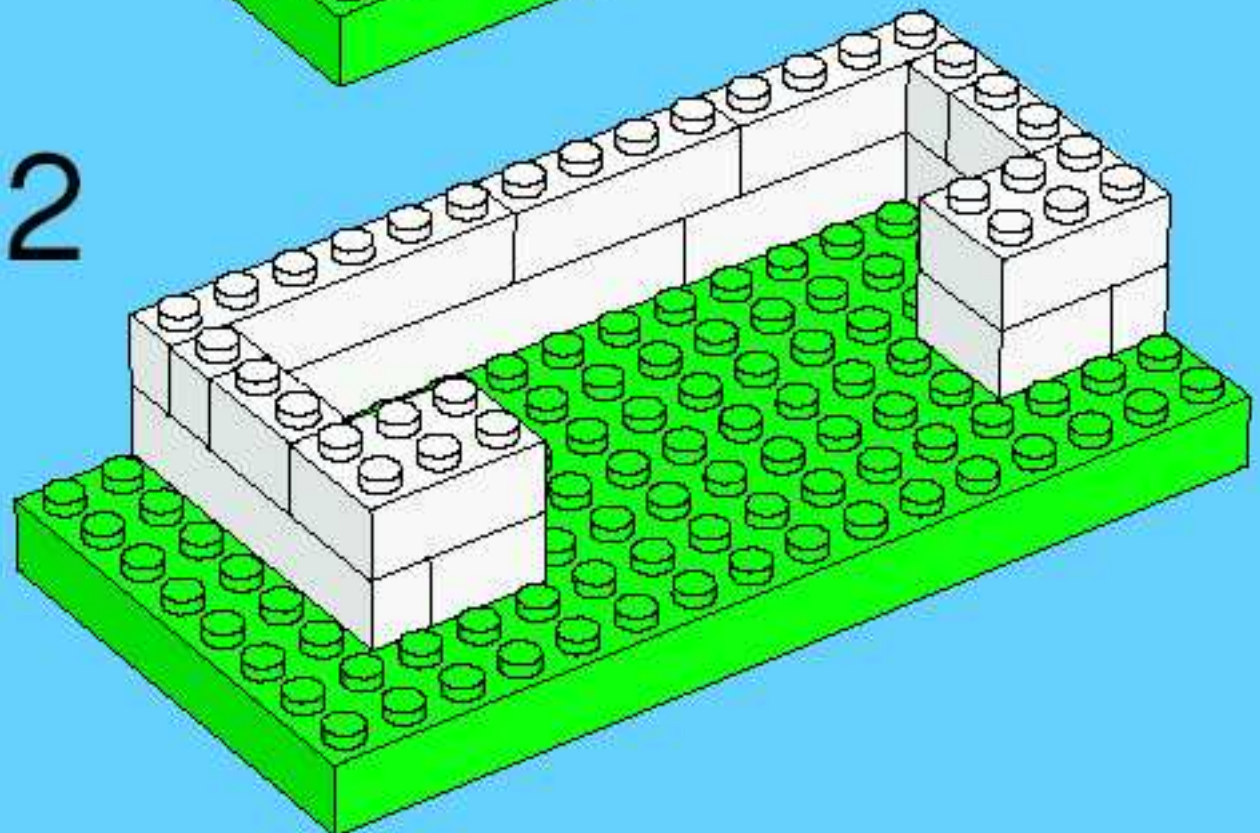

3

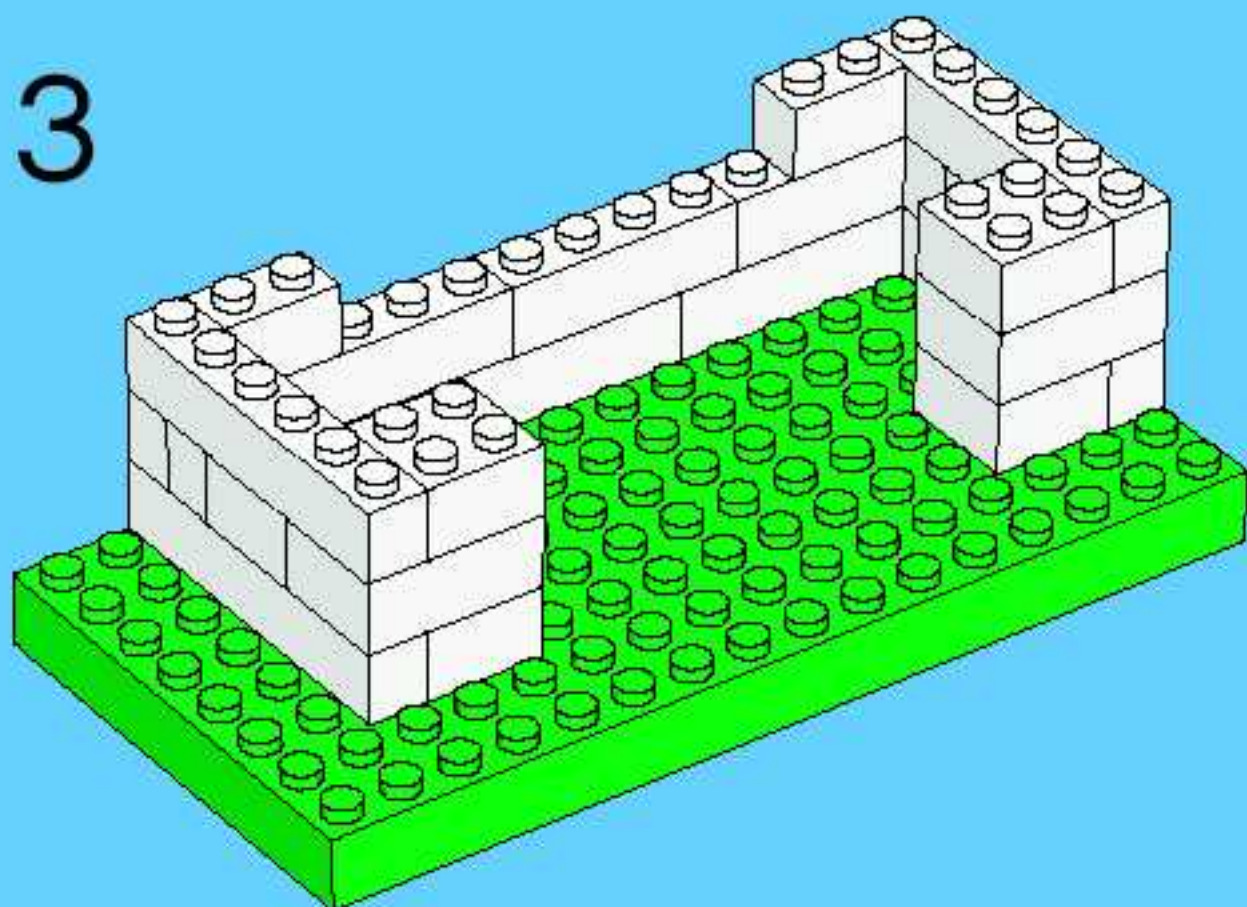

4

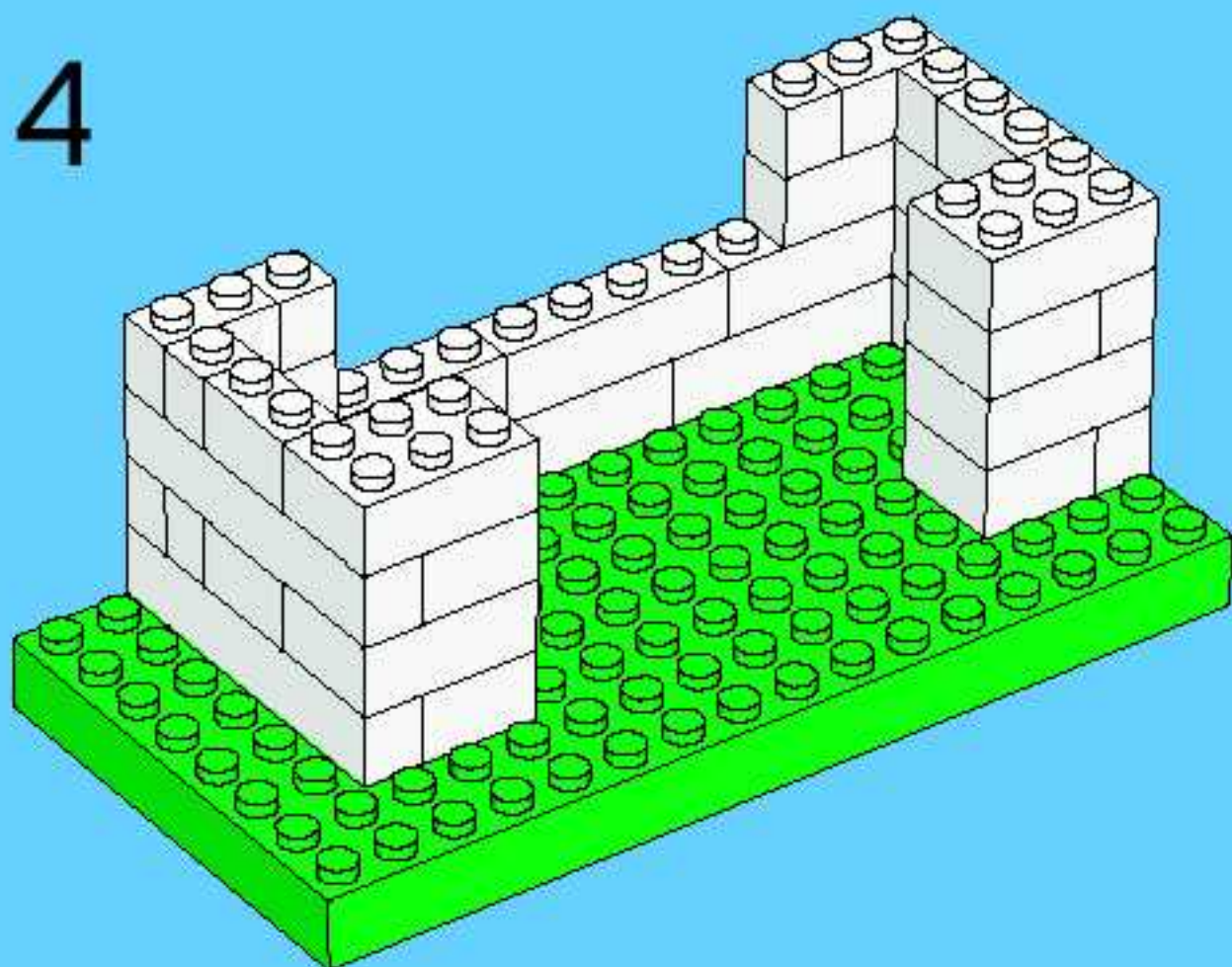

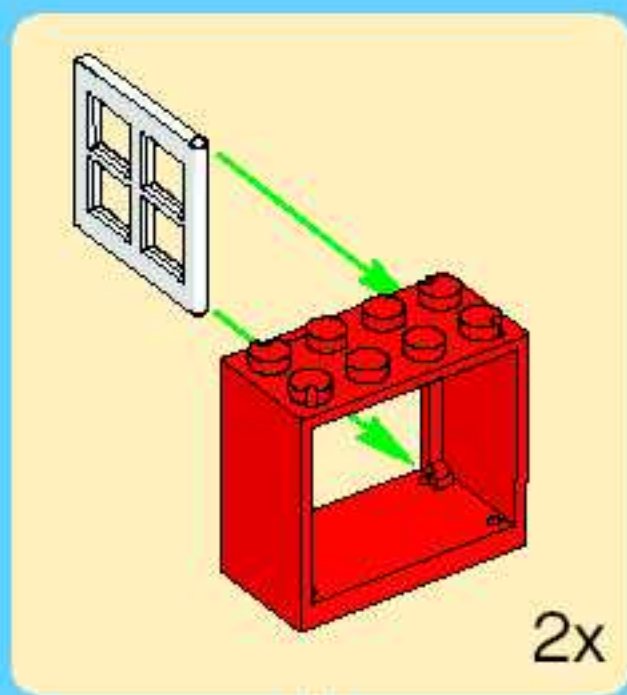

5

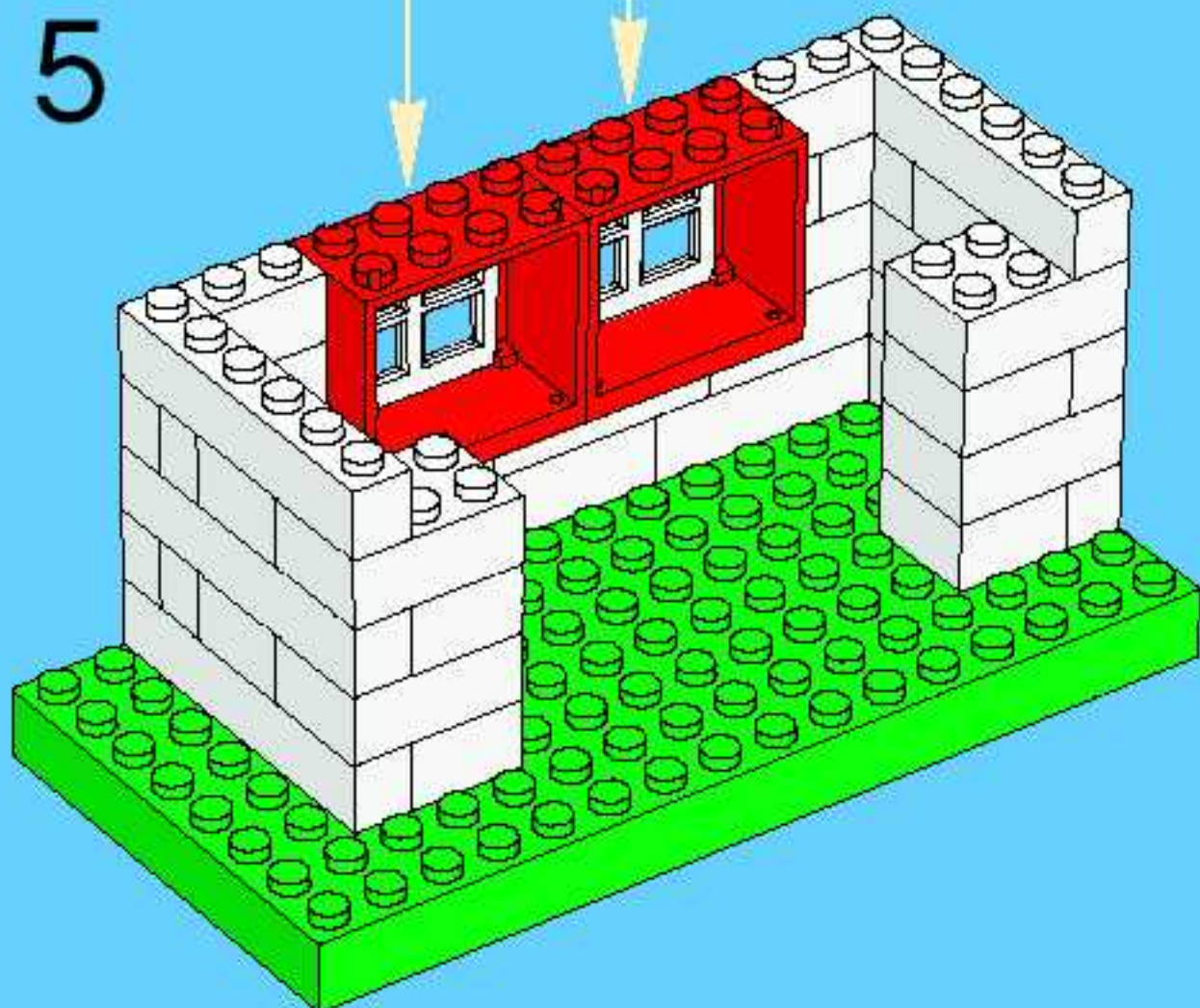

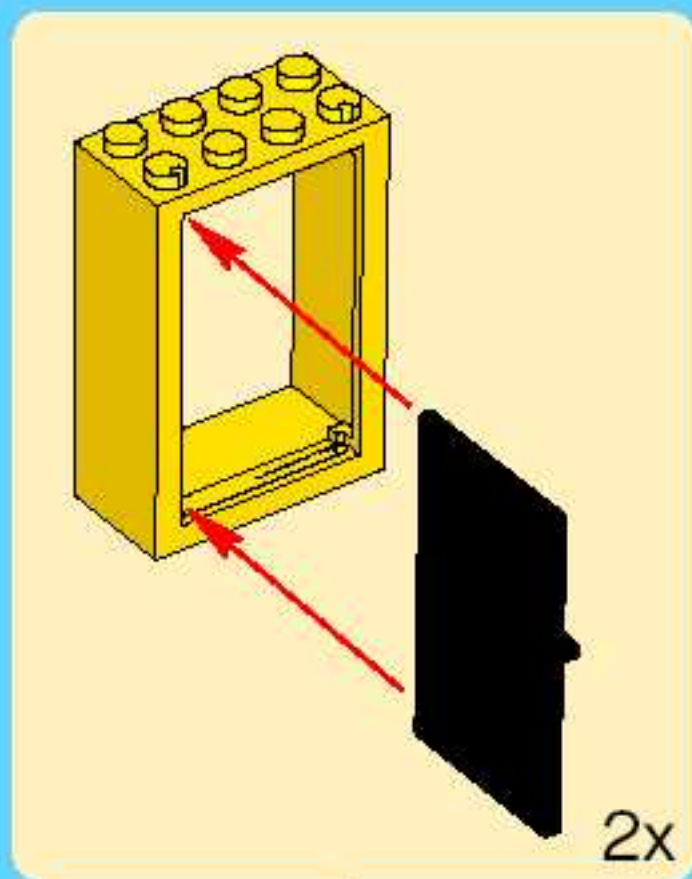

6

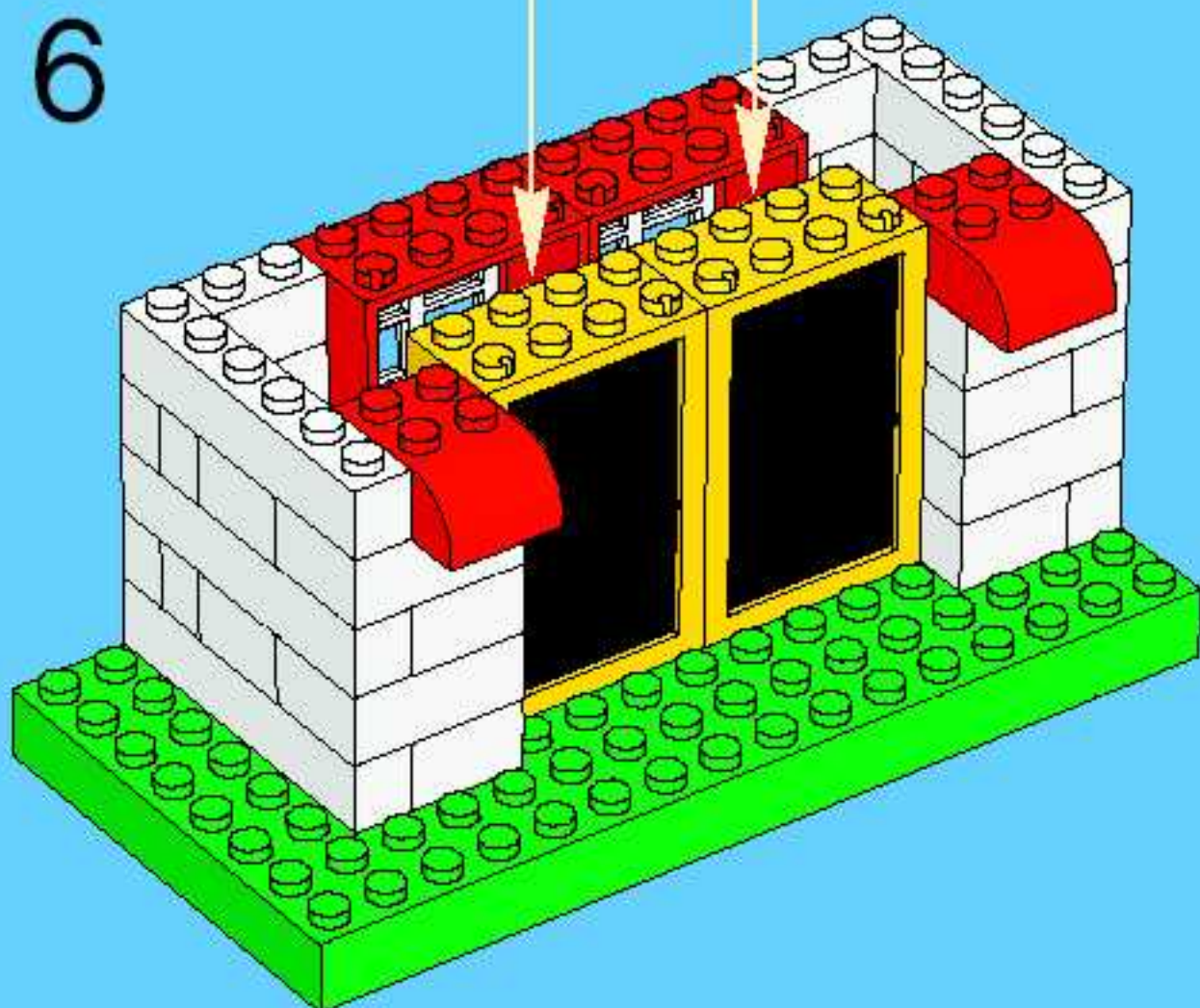

7



8

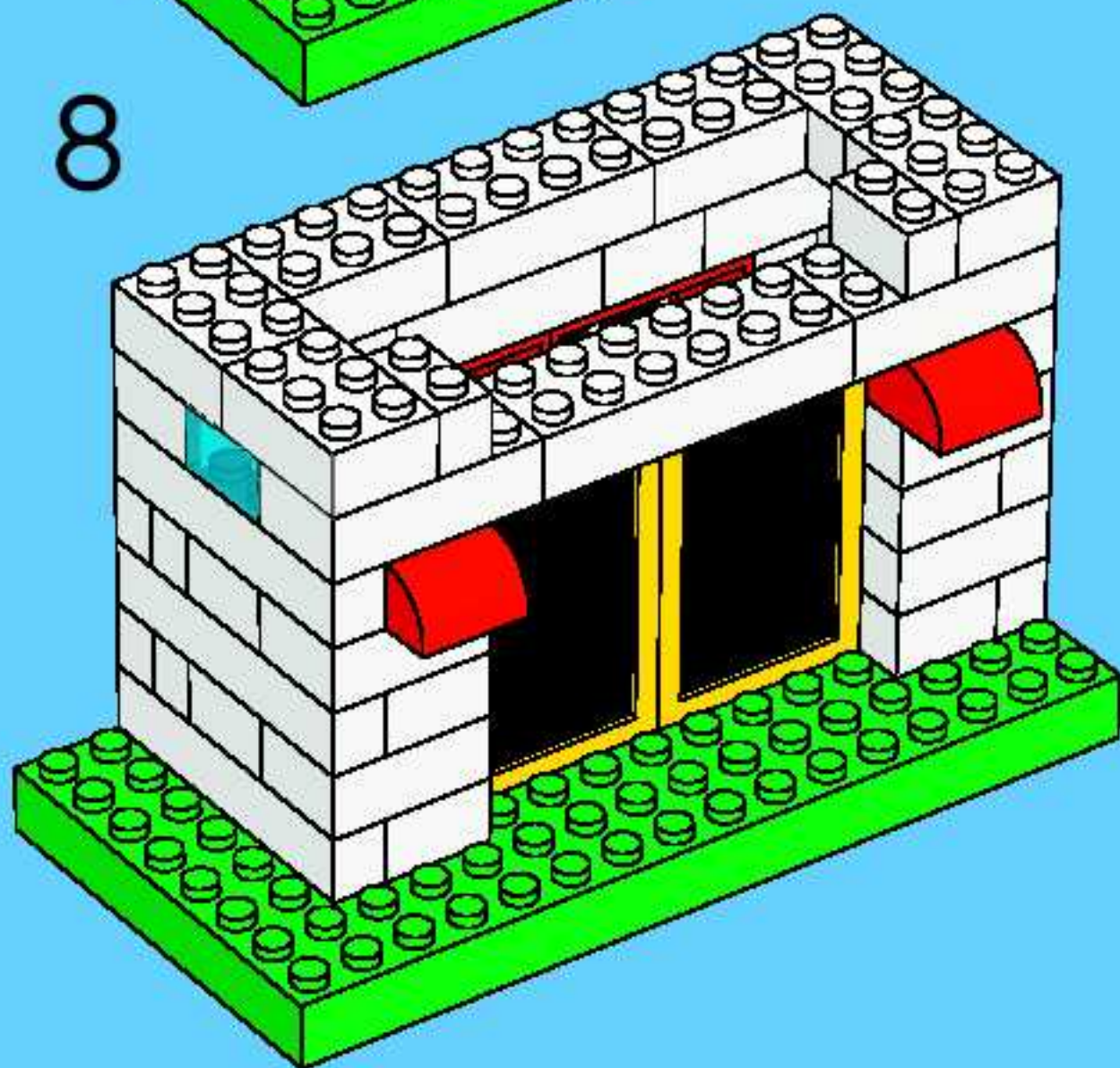

9



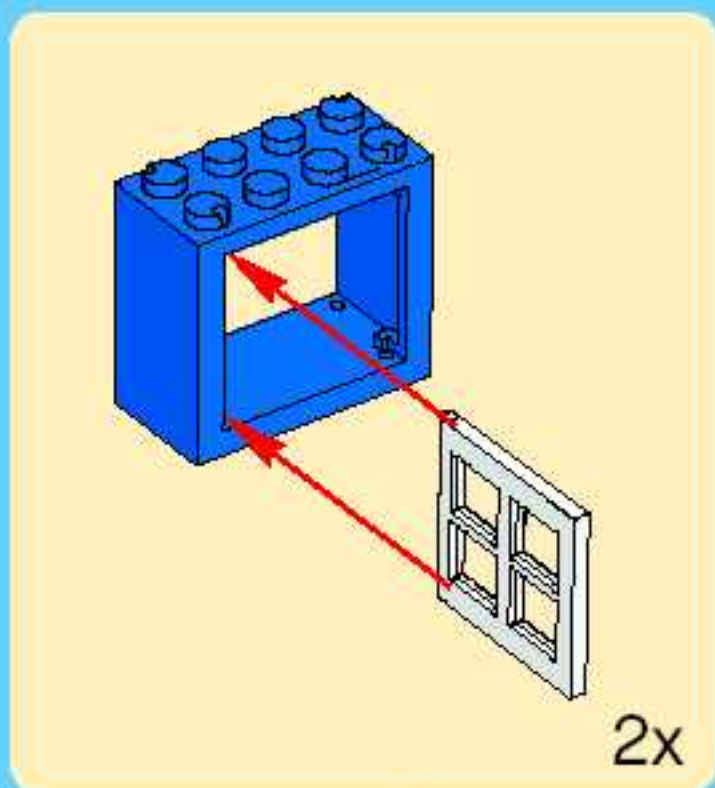

10

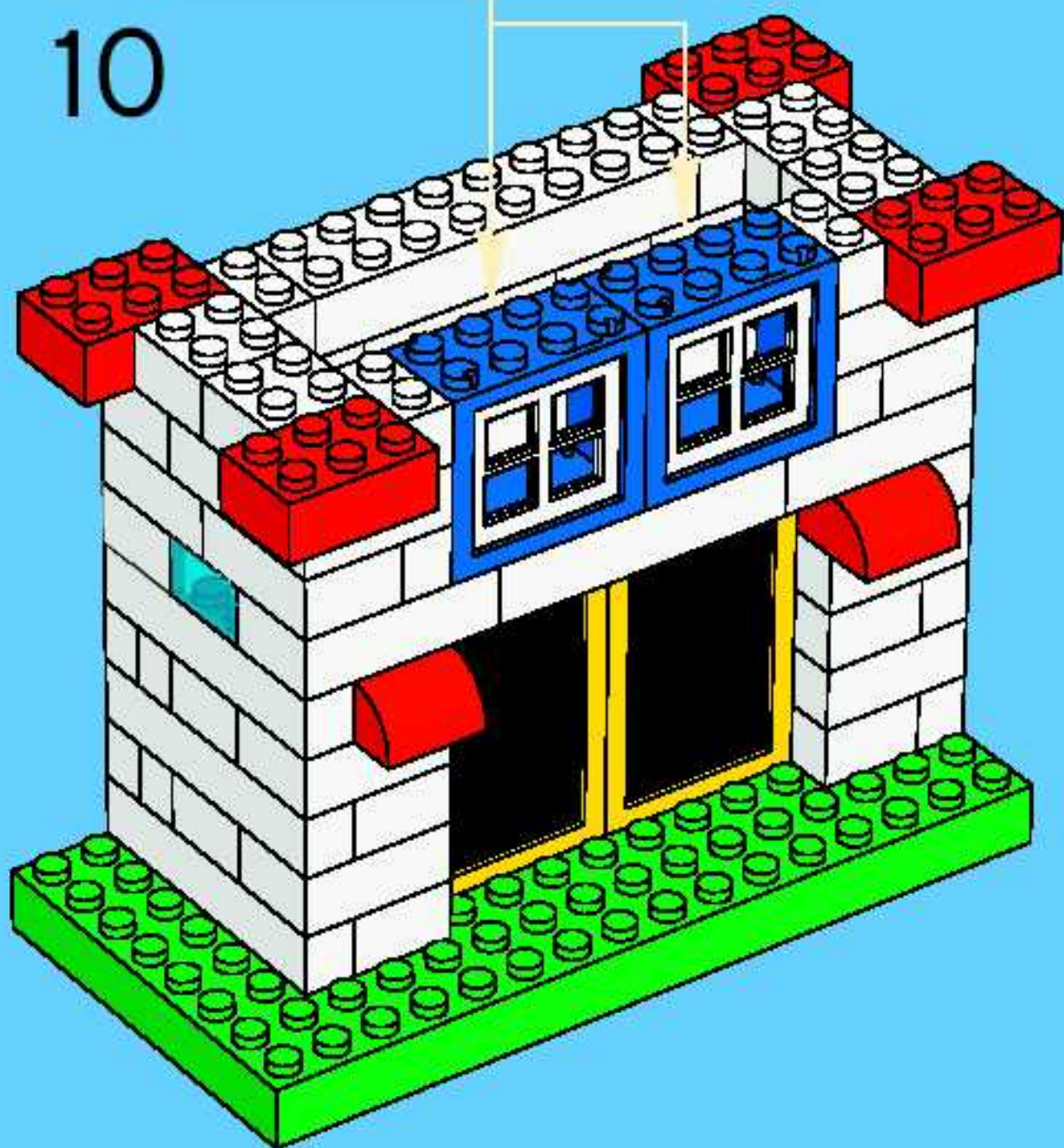

11

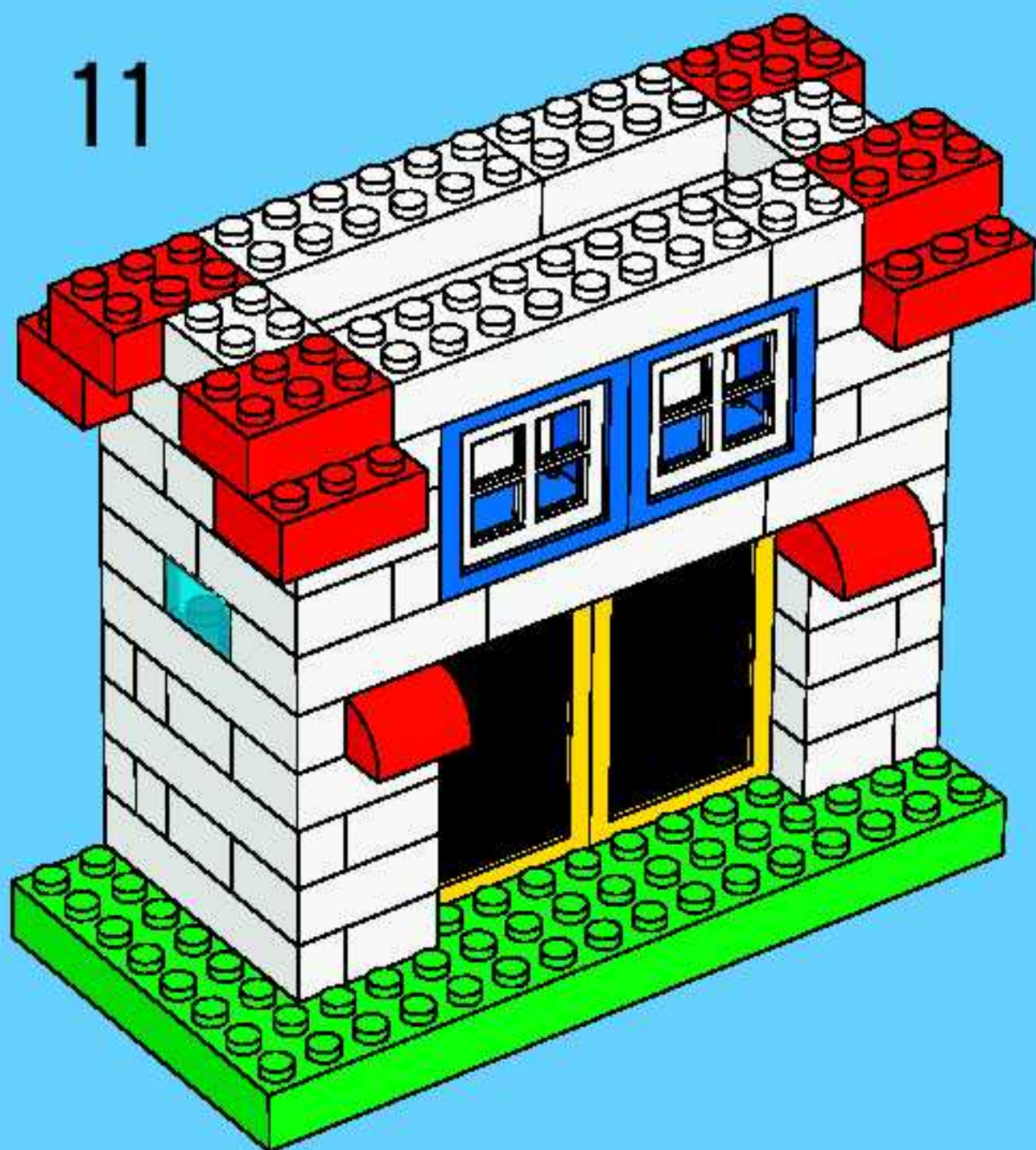

12

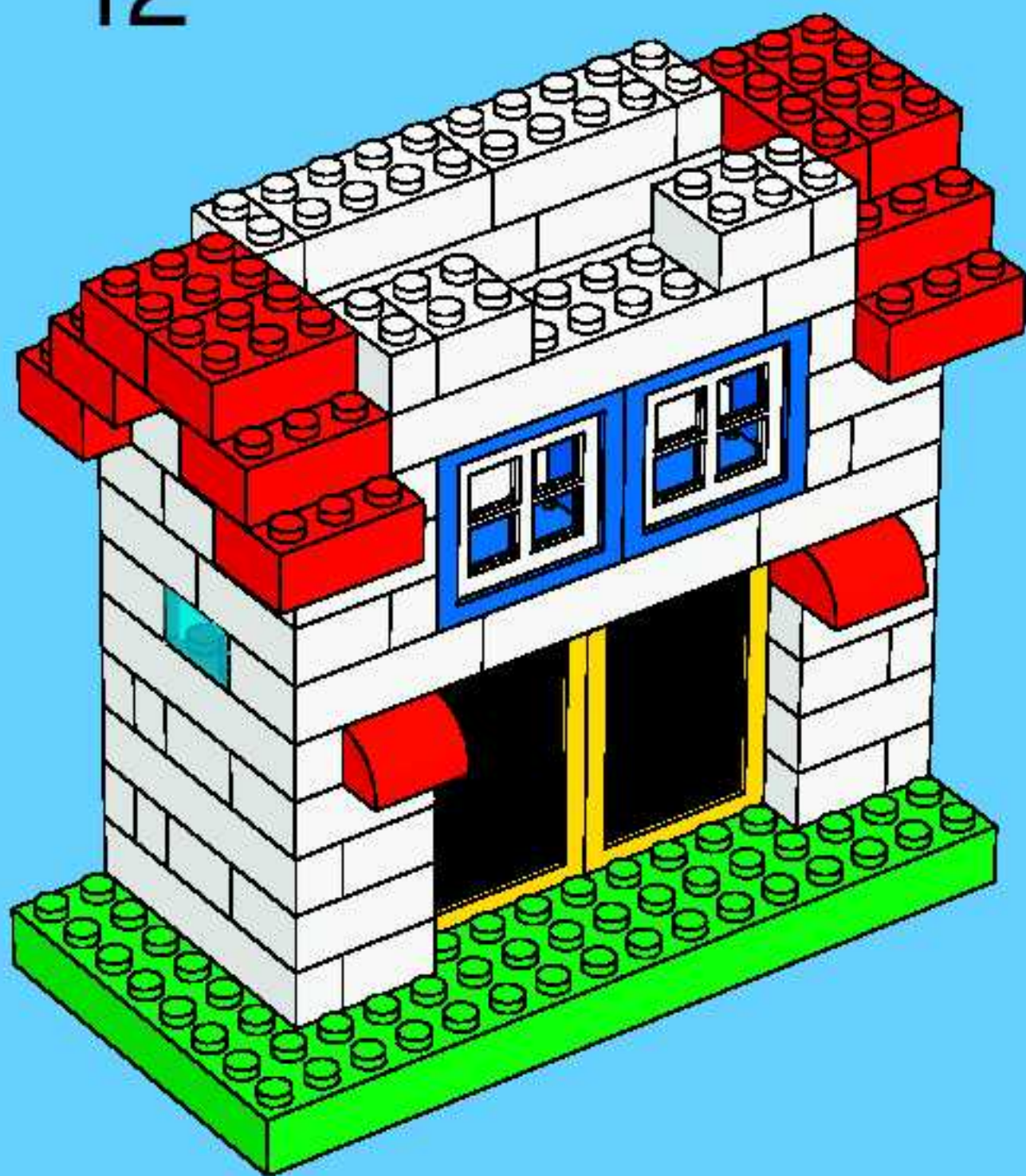

13

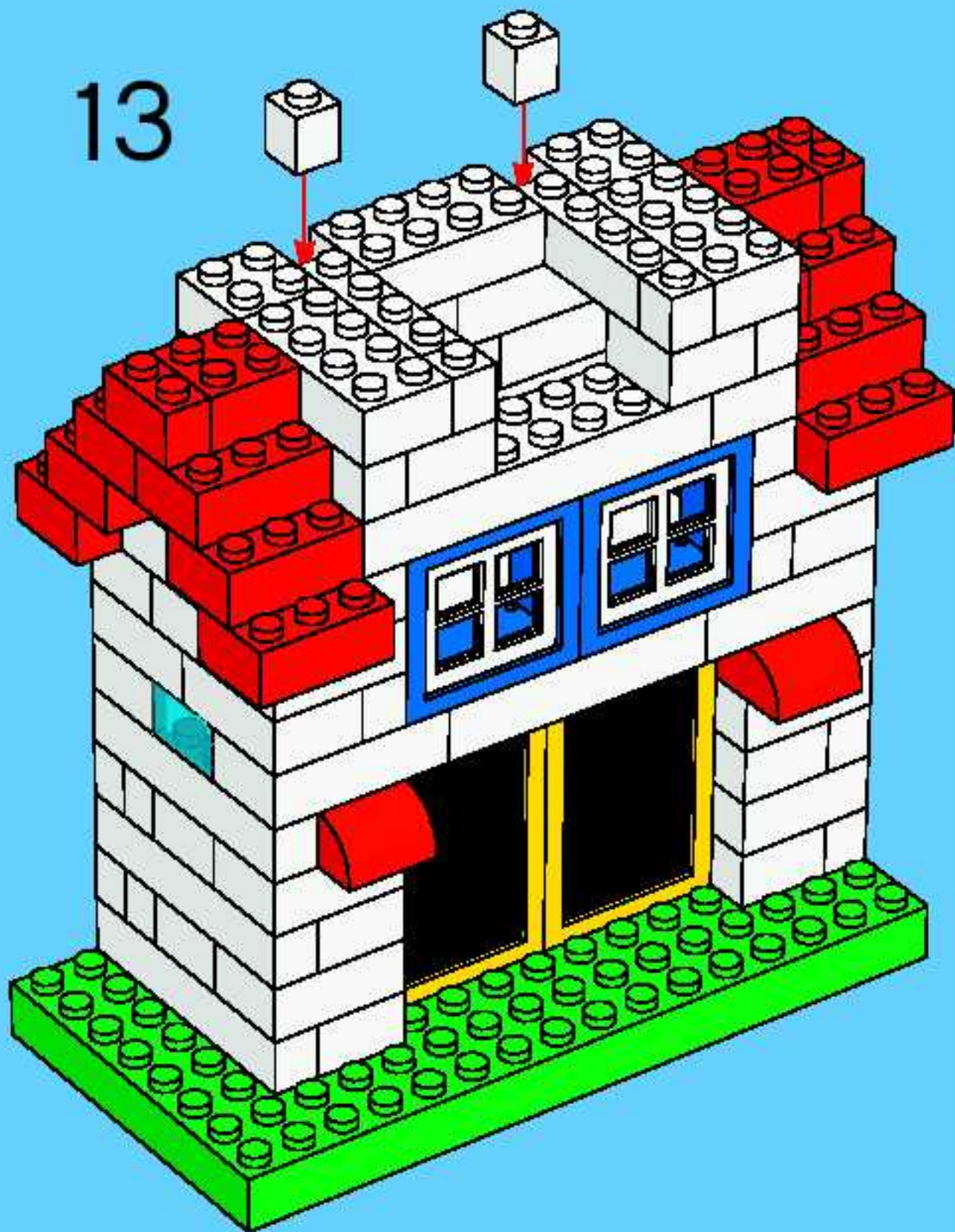

14

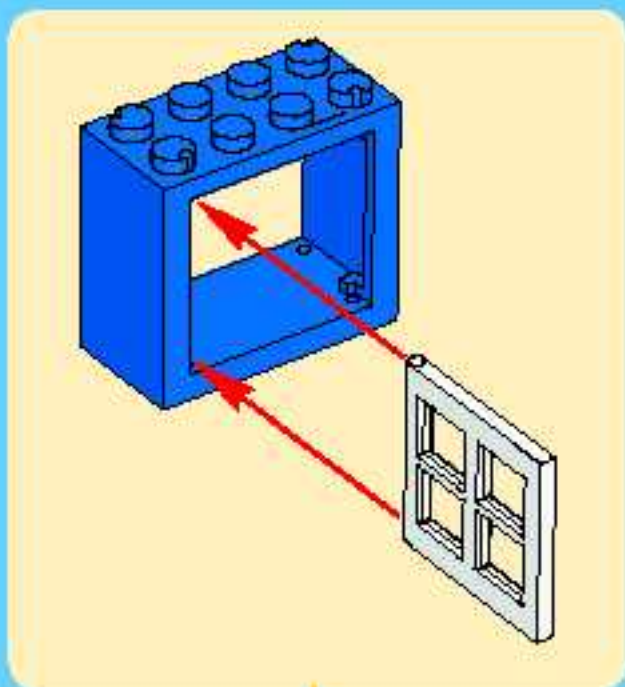

15



16



17



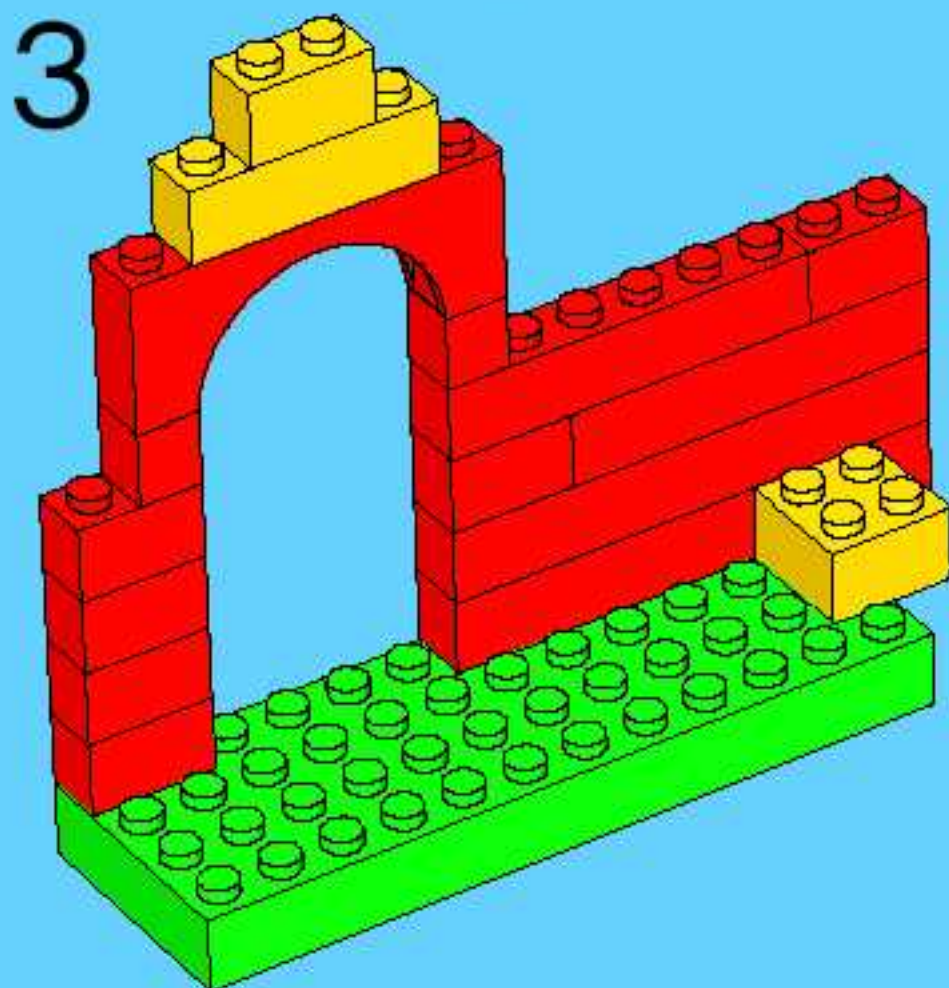
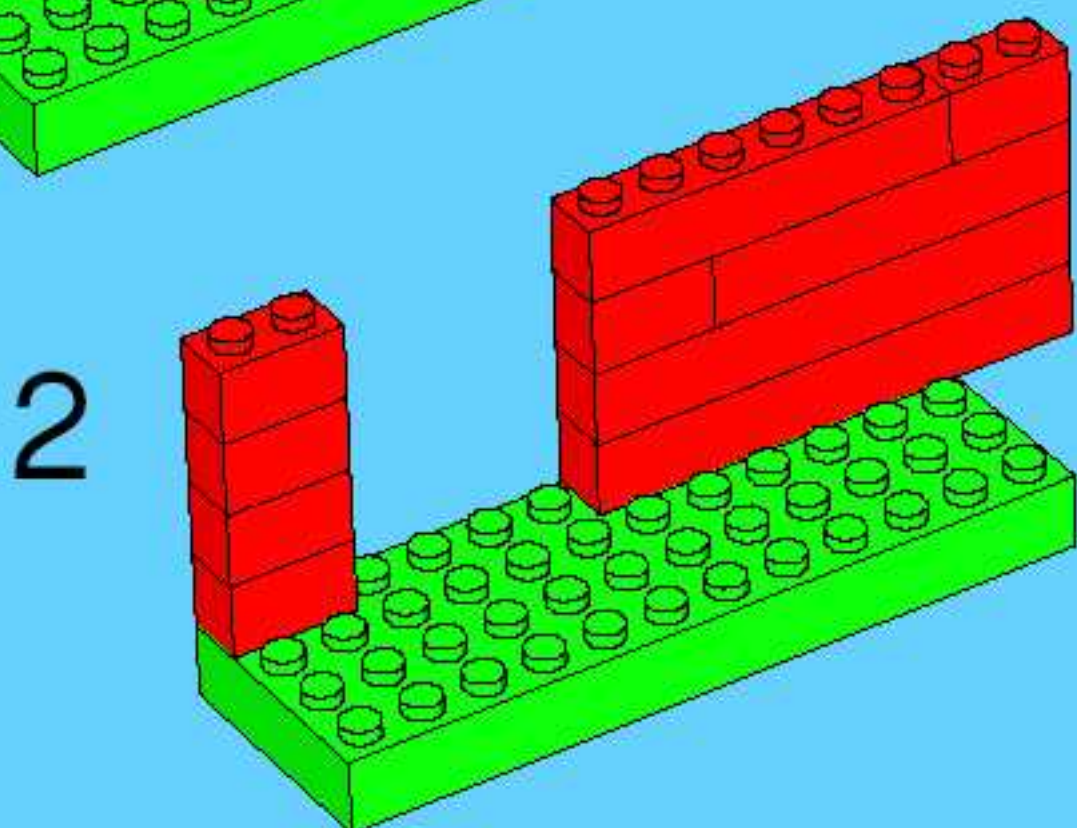
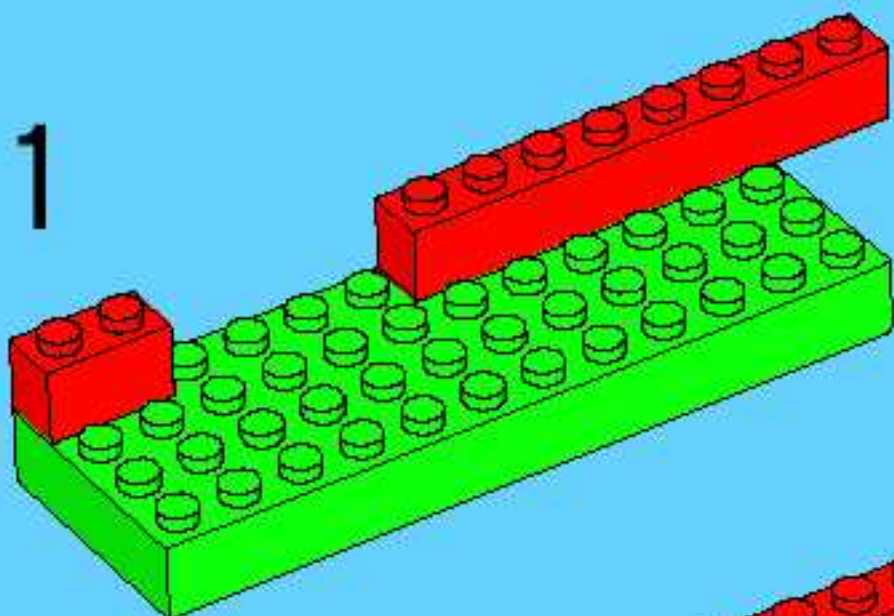

1



2



3



4



4

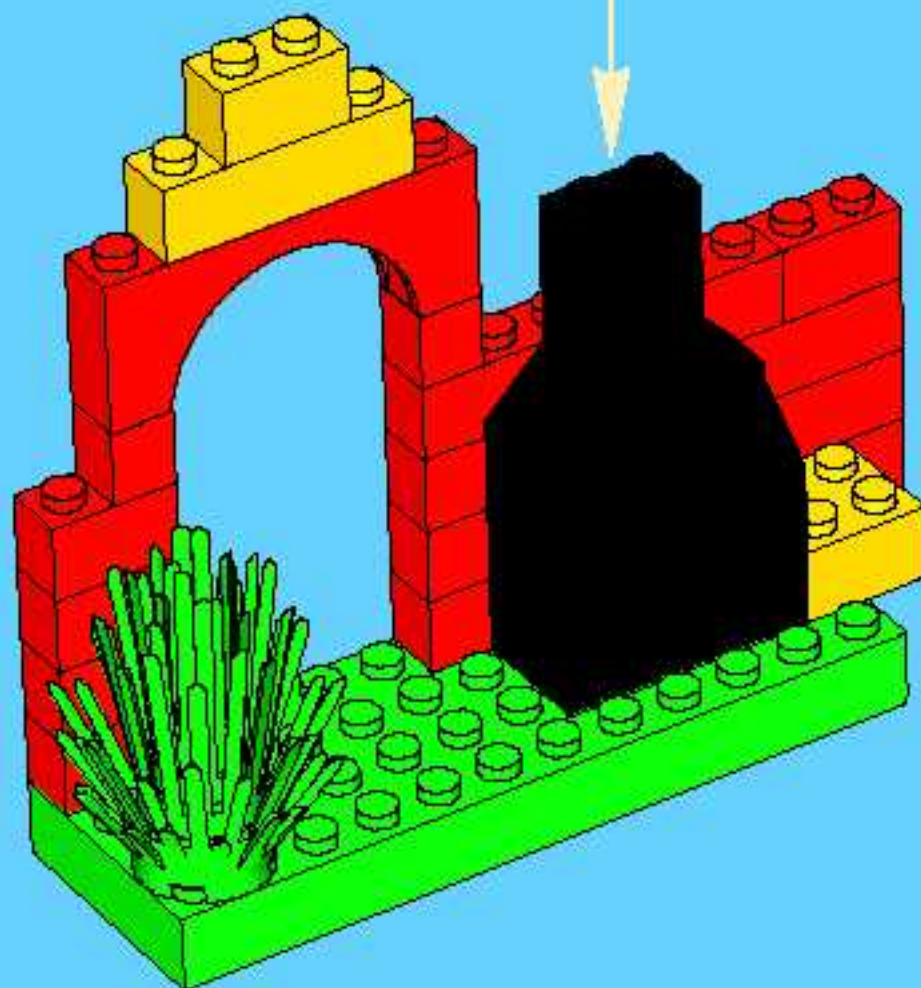

5

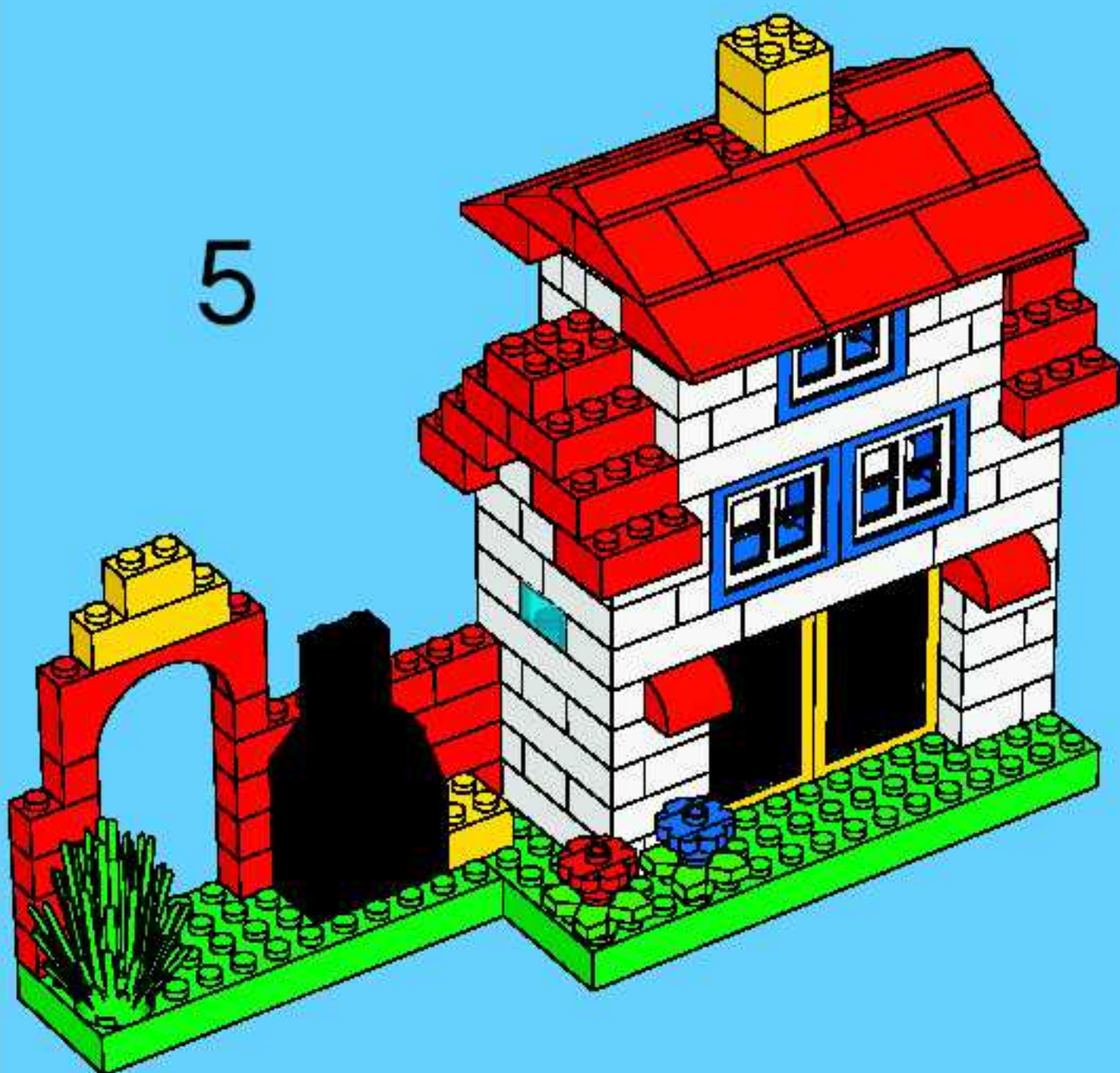

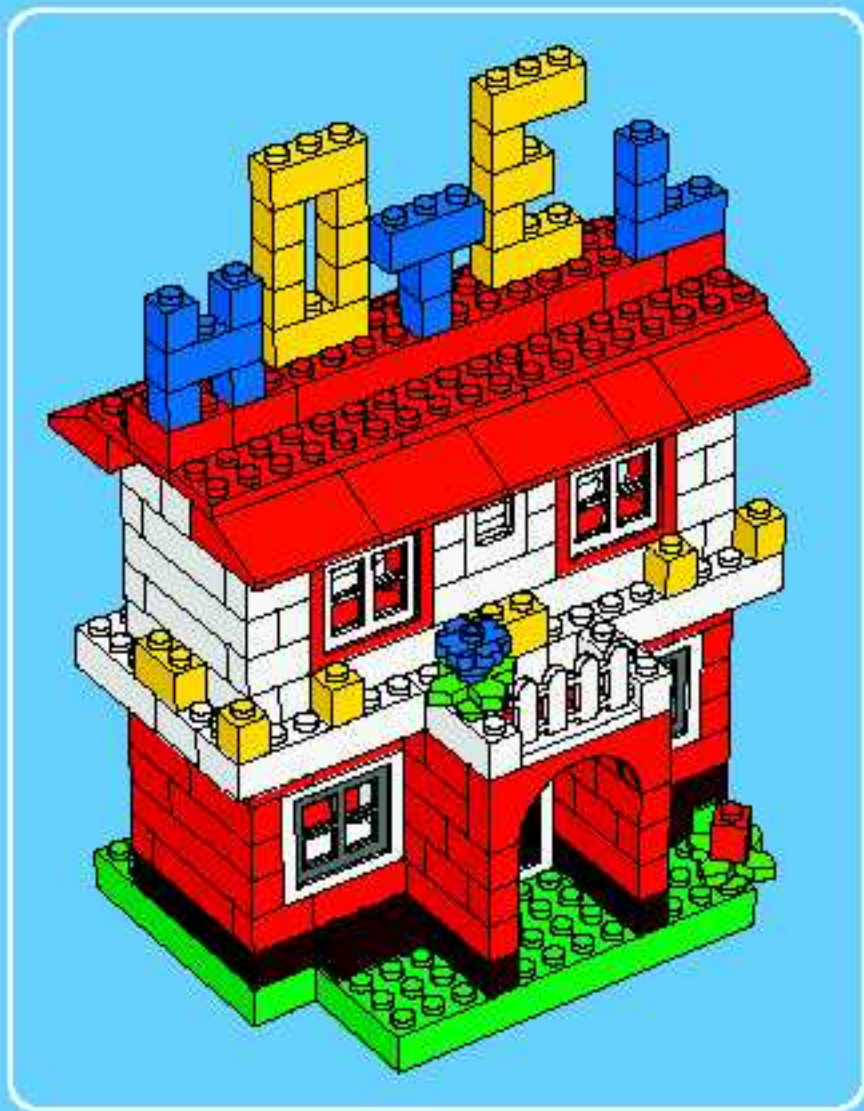

1

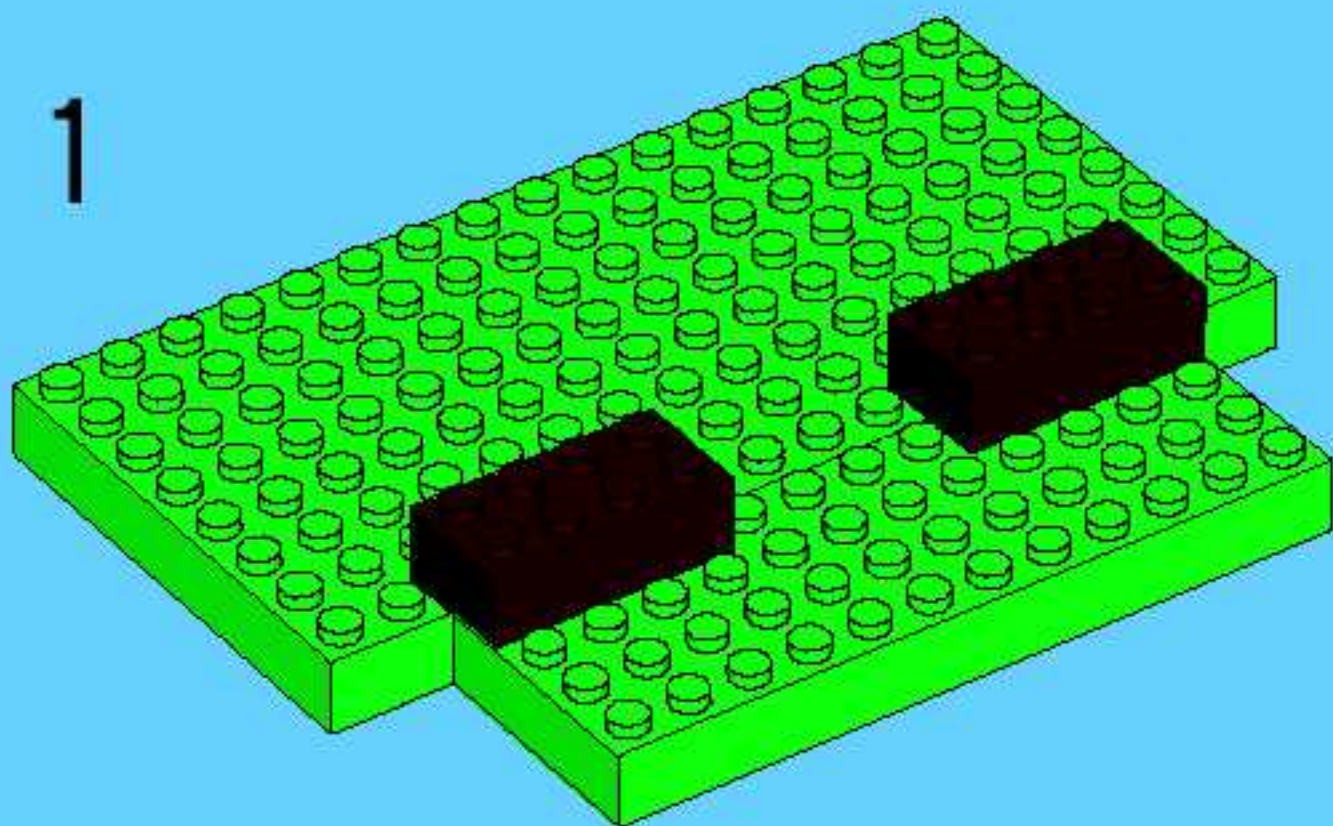

2

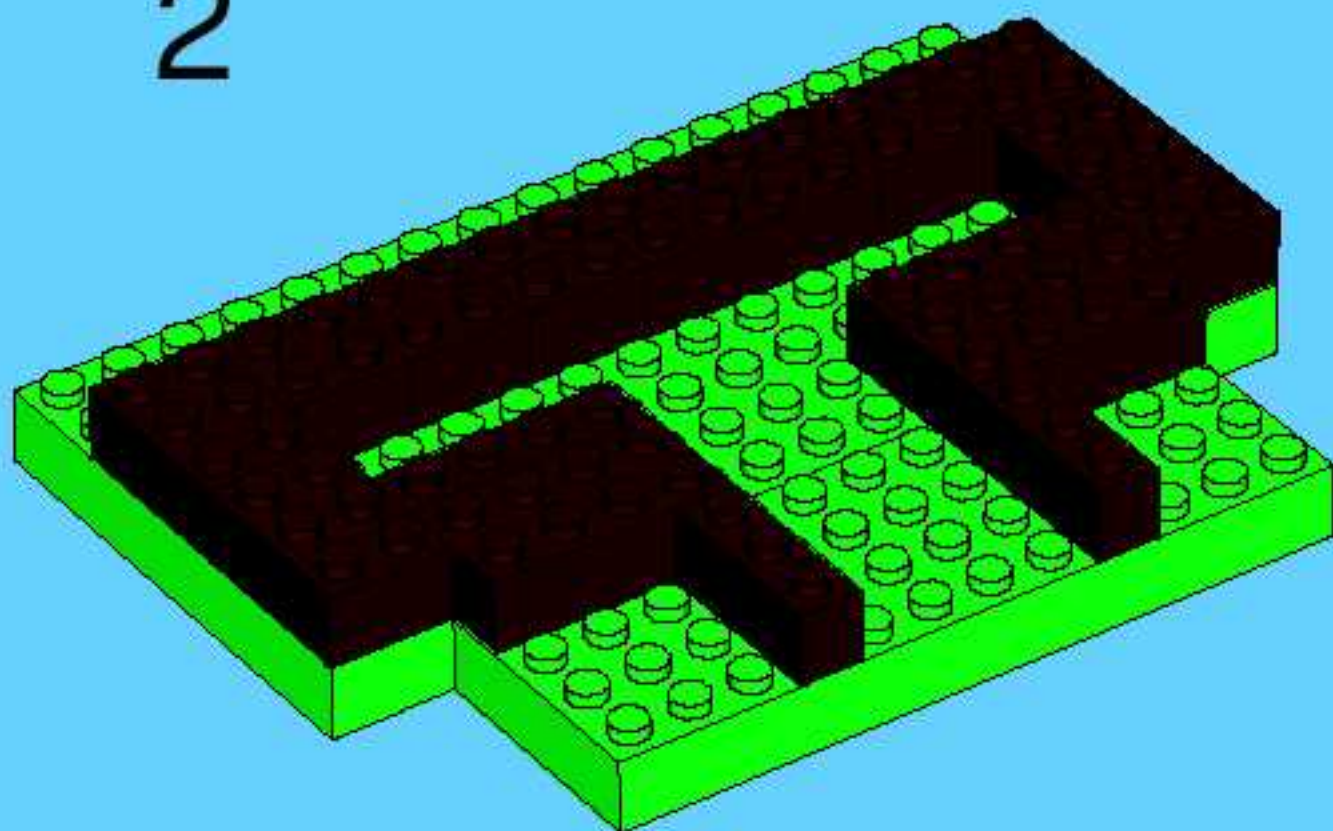

3

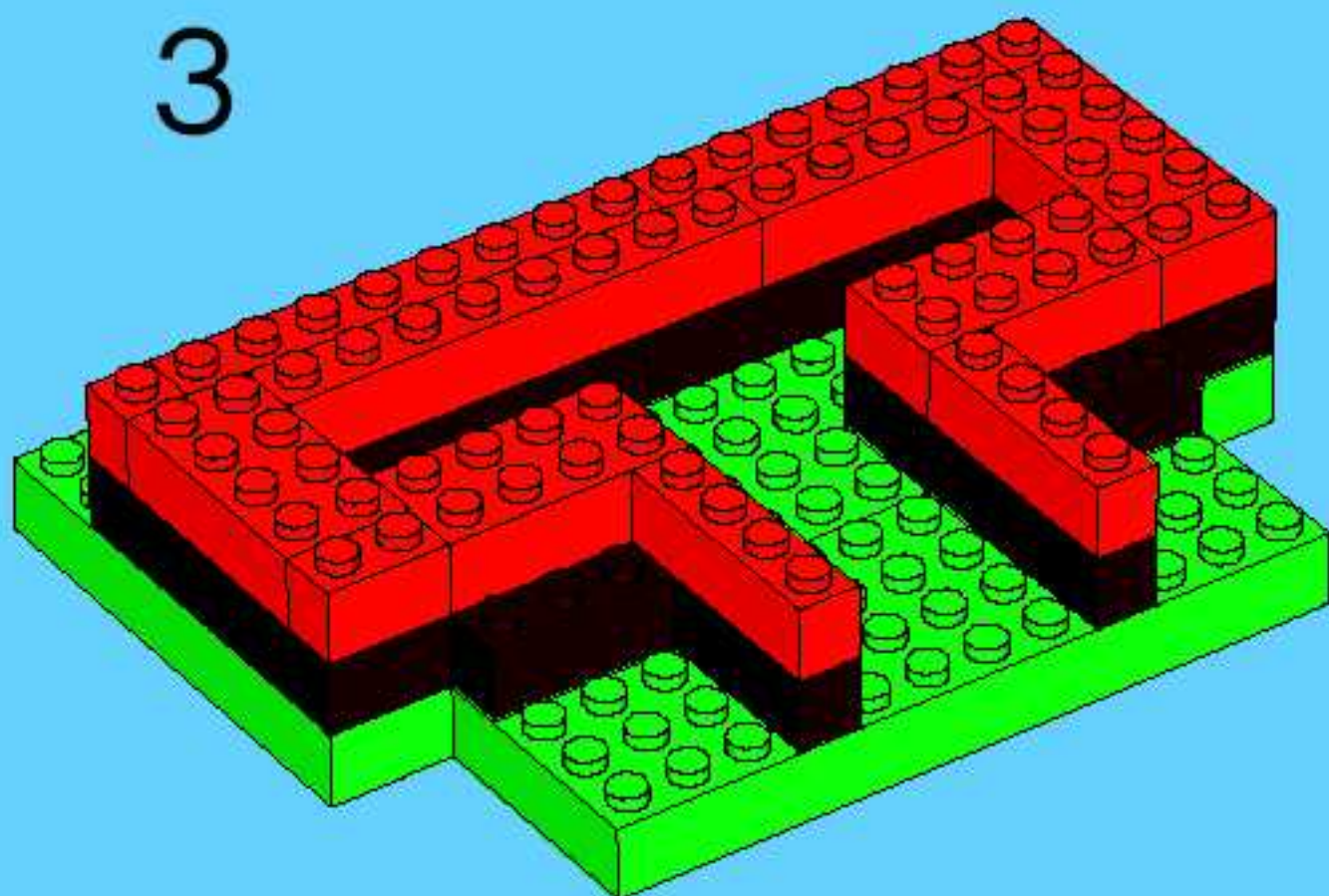

4

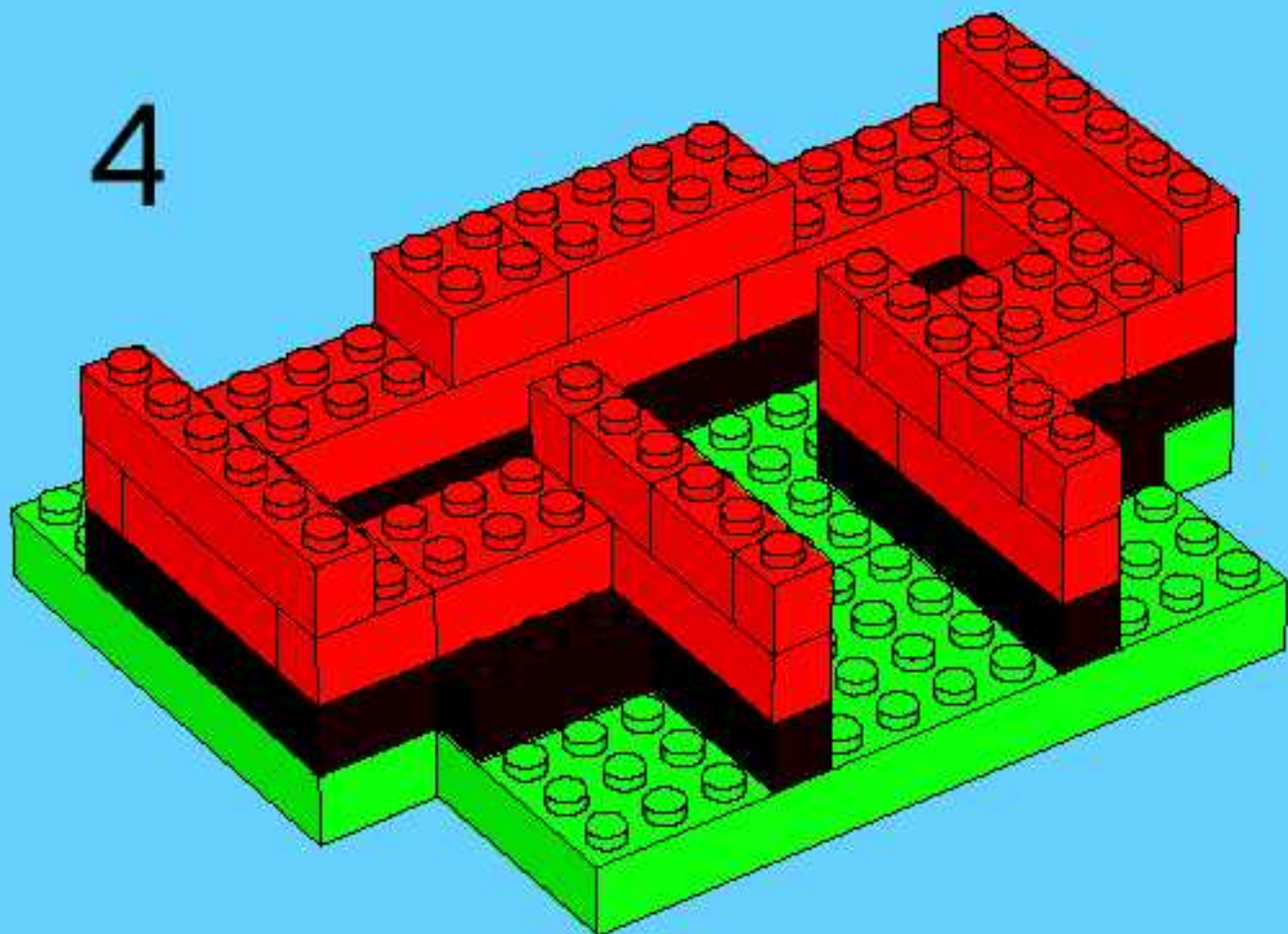

5

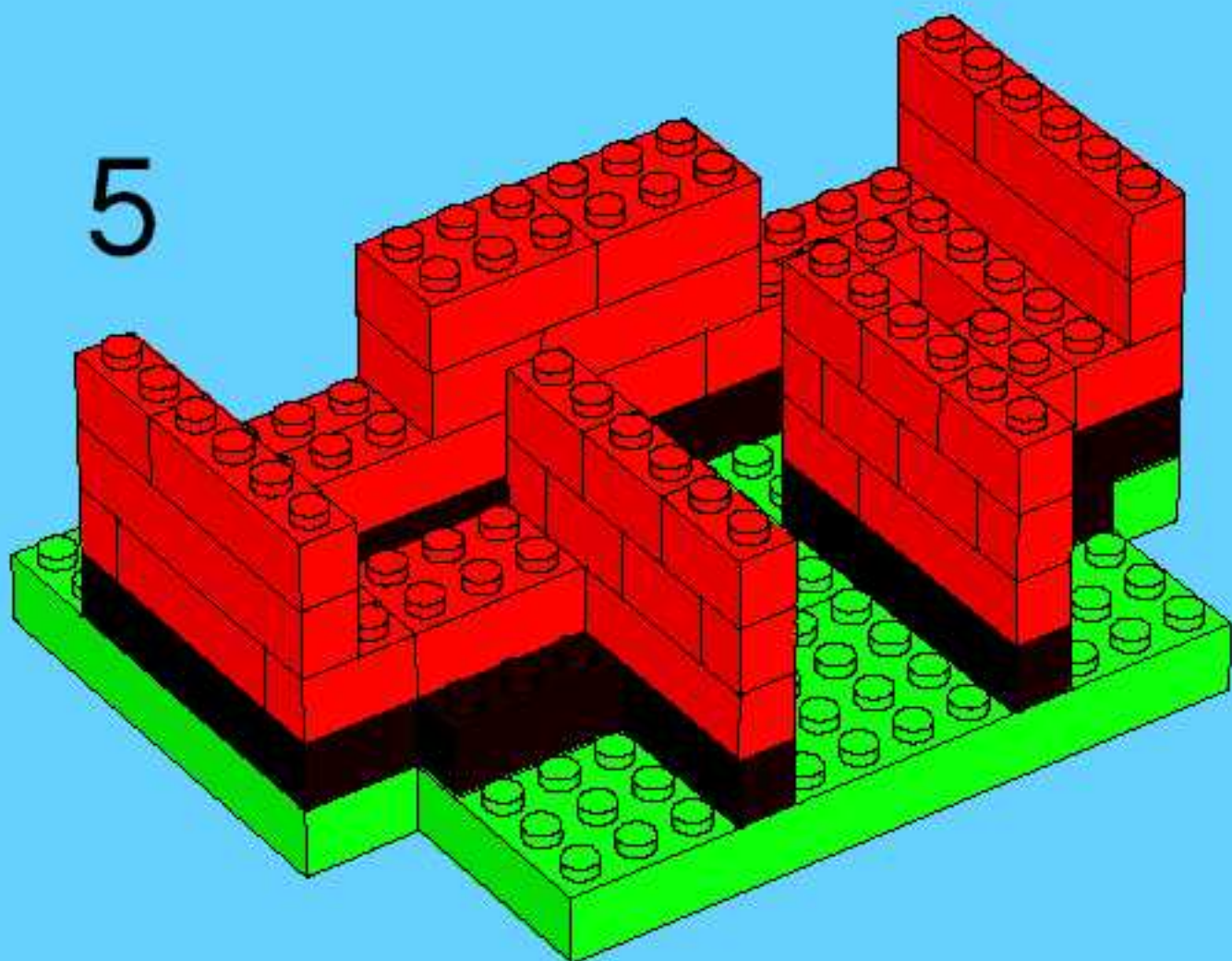

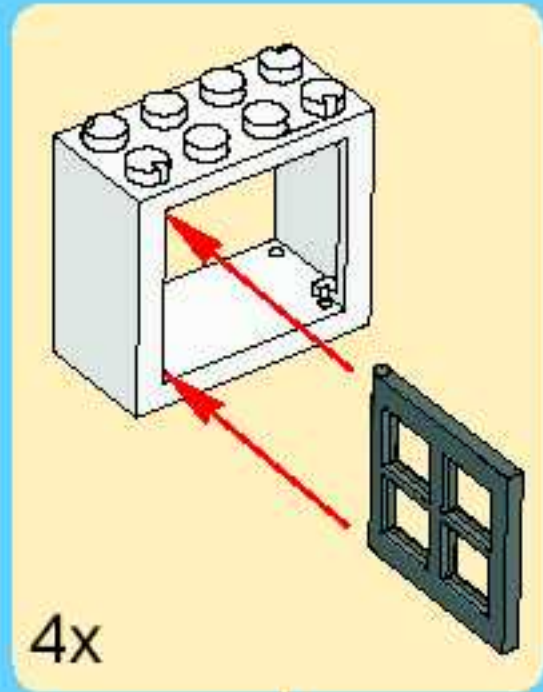
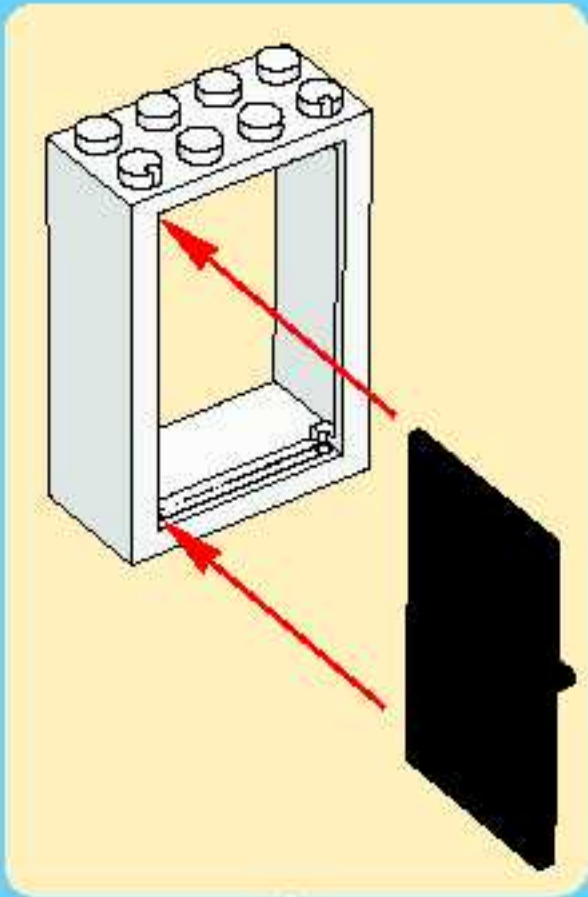

6



7



8

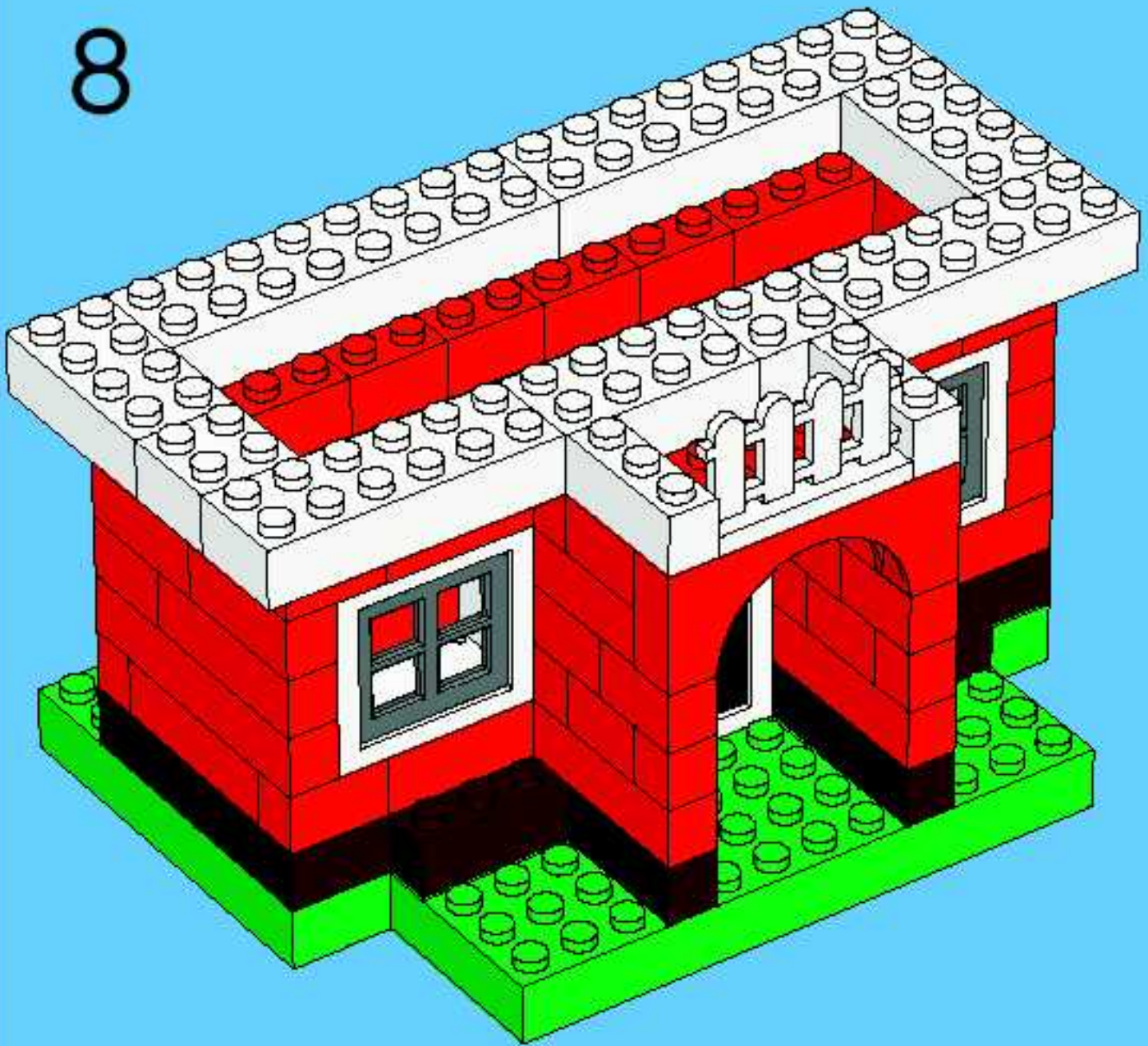

9

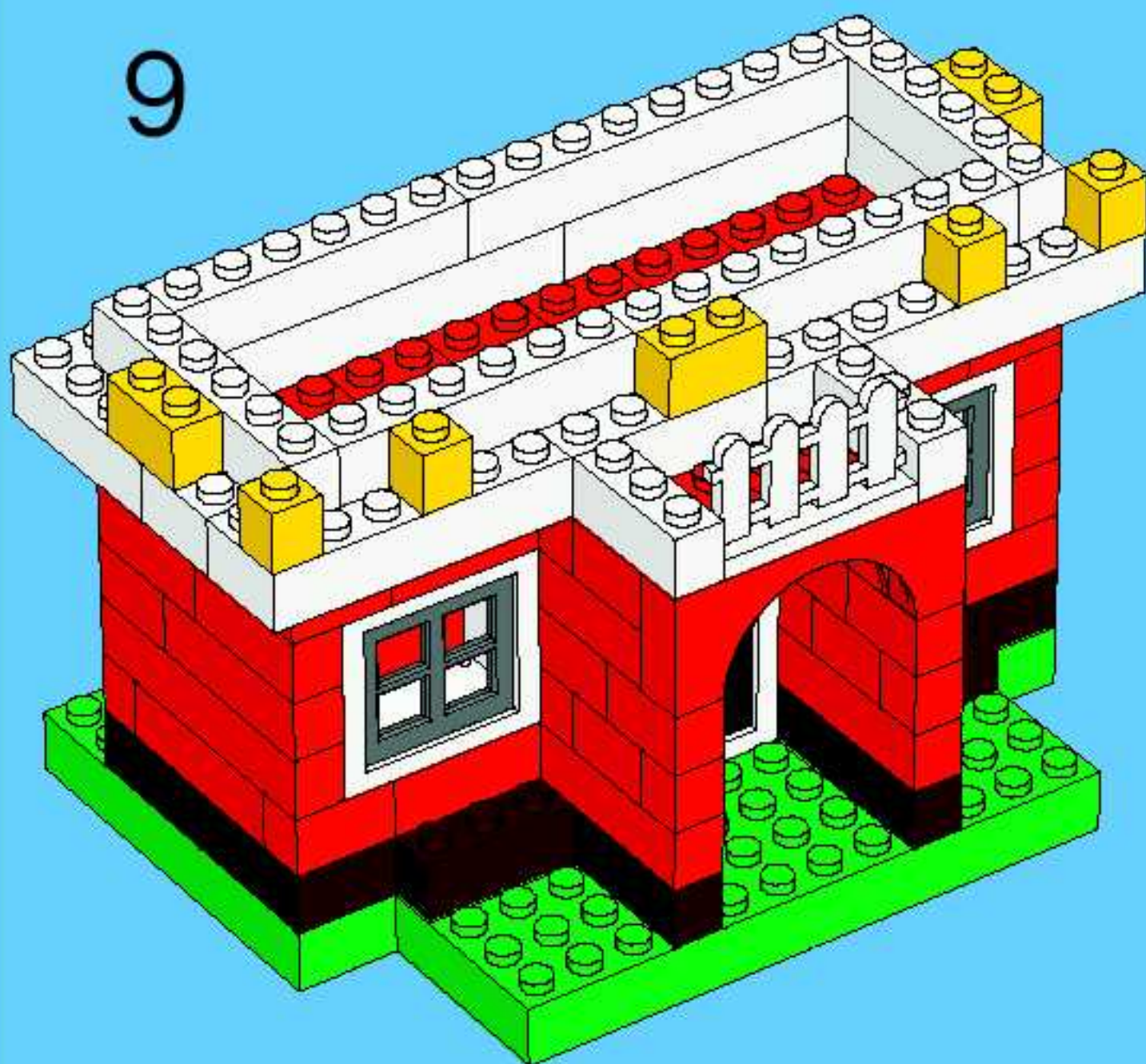

10

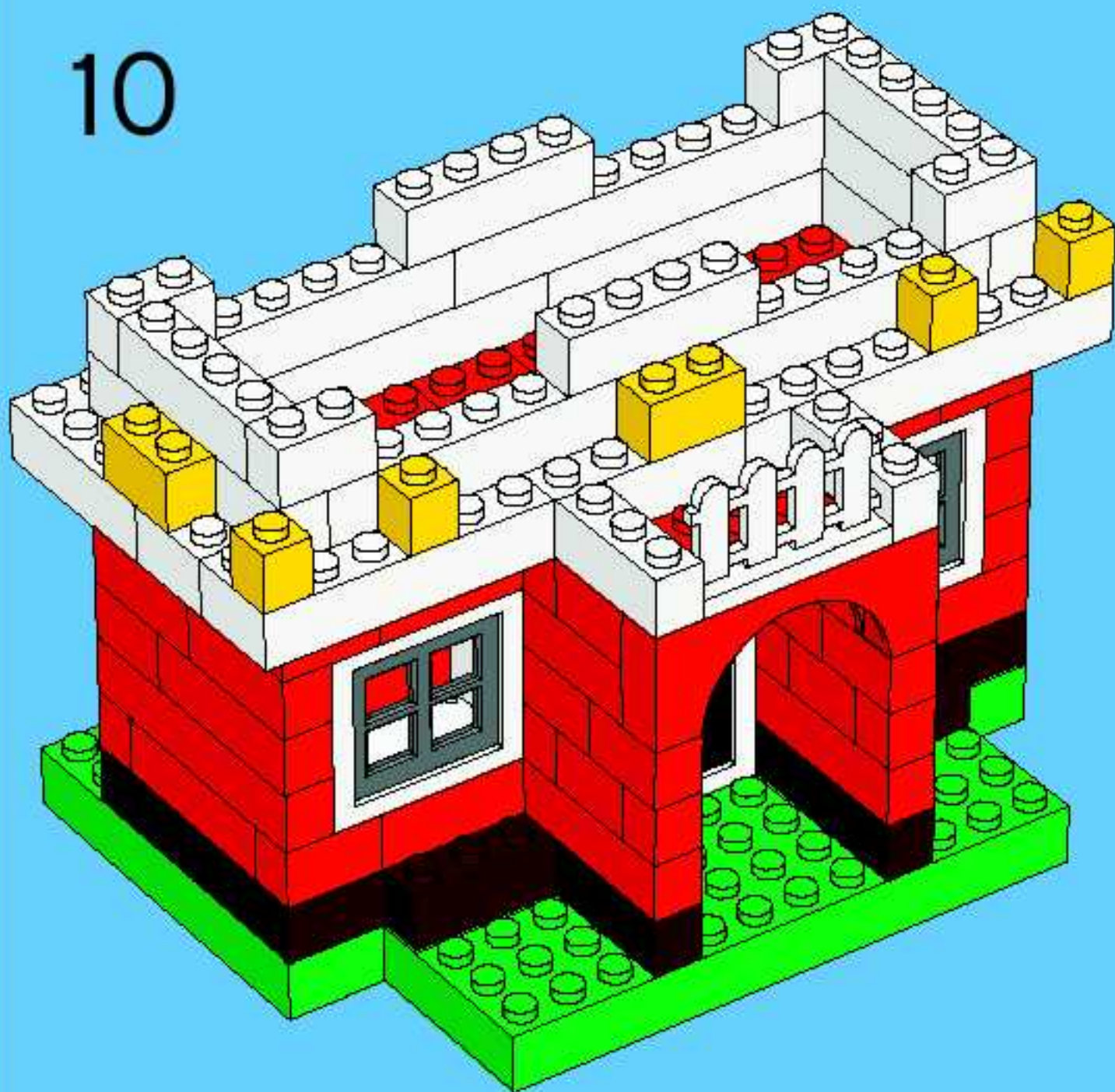

11

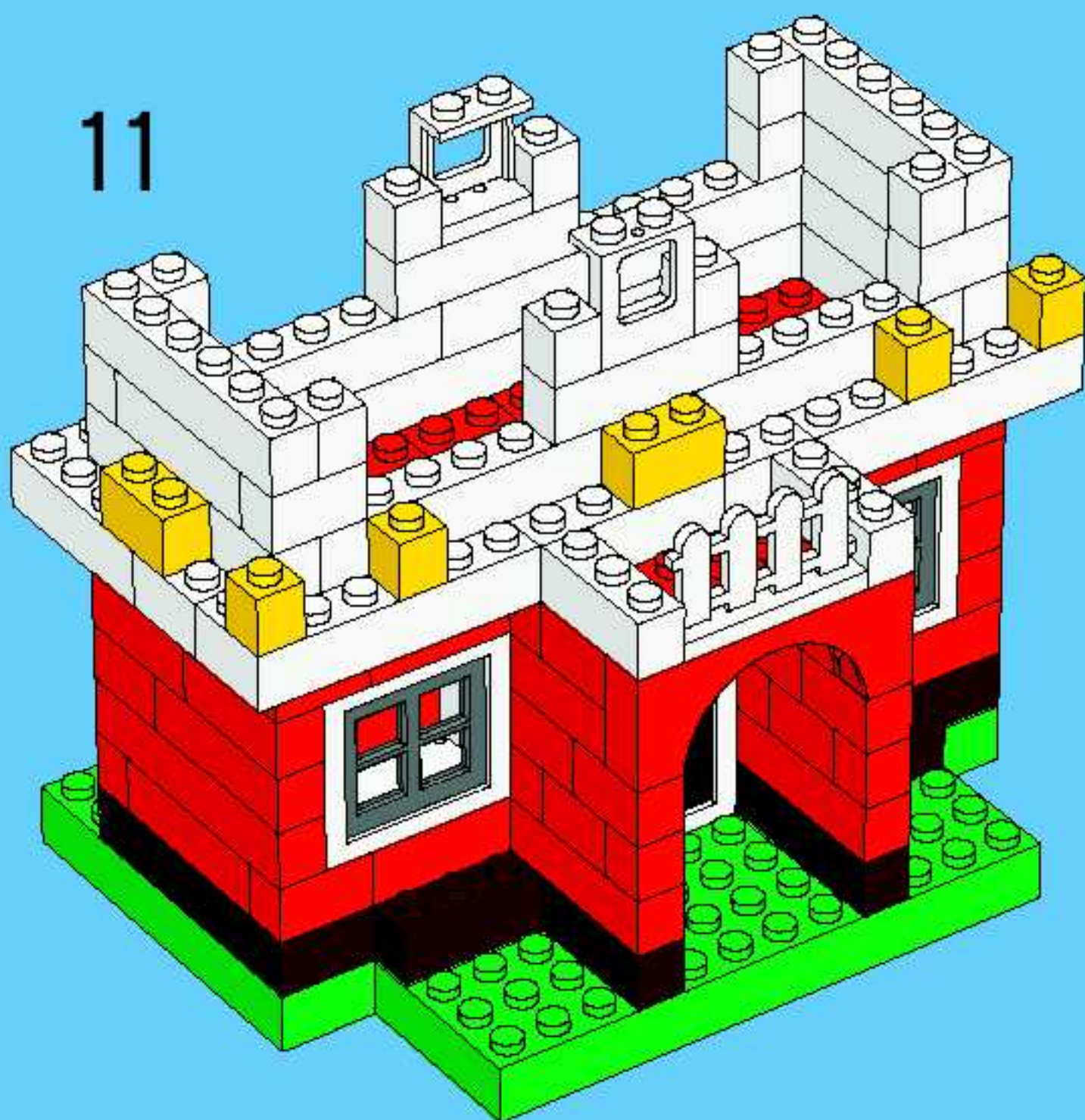

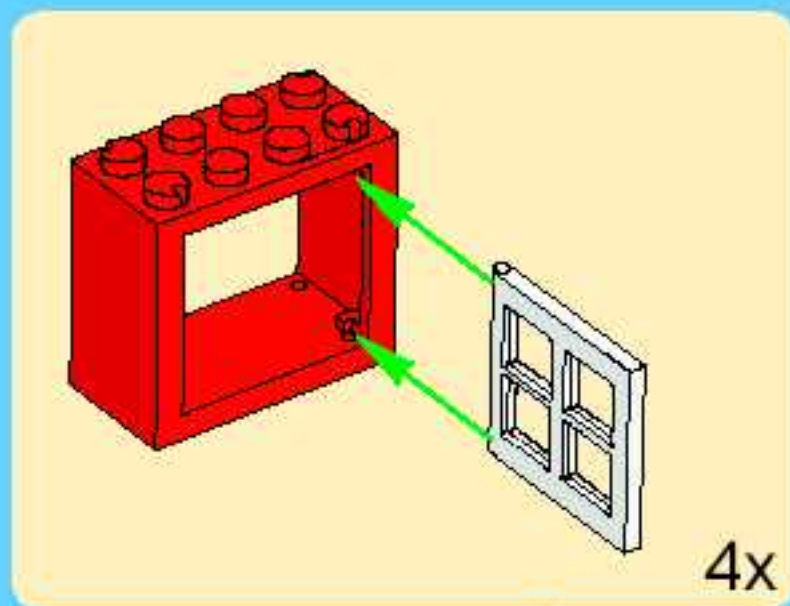

12

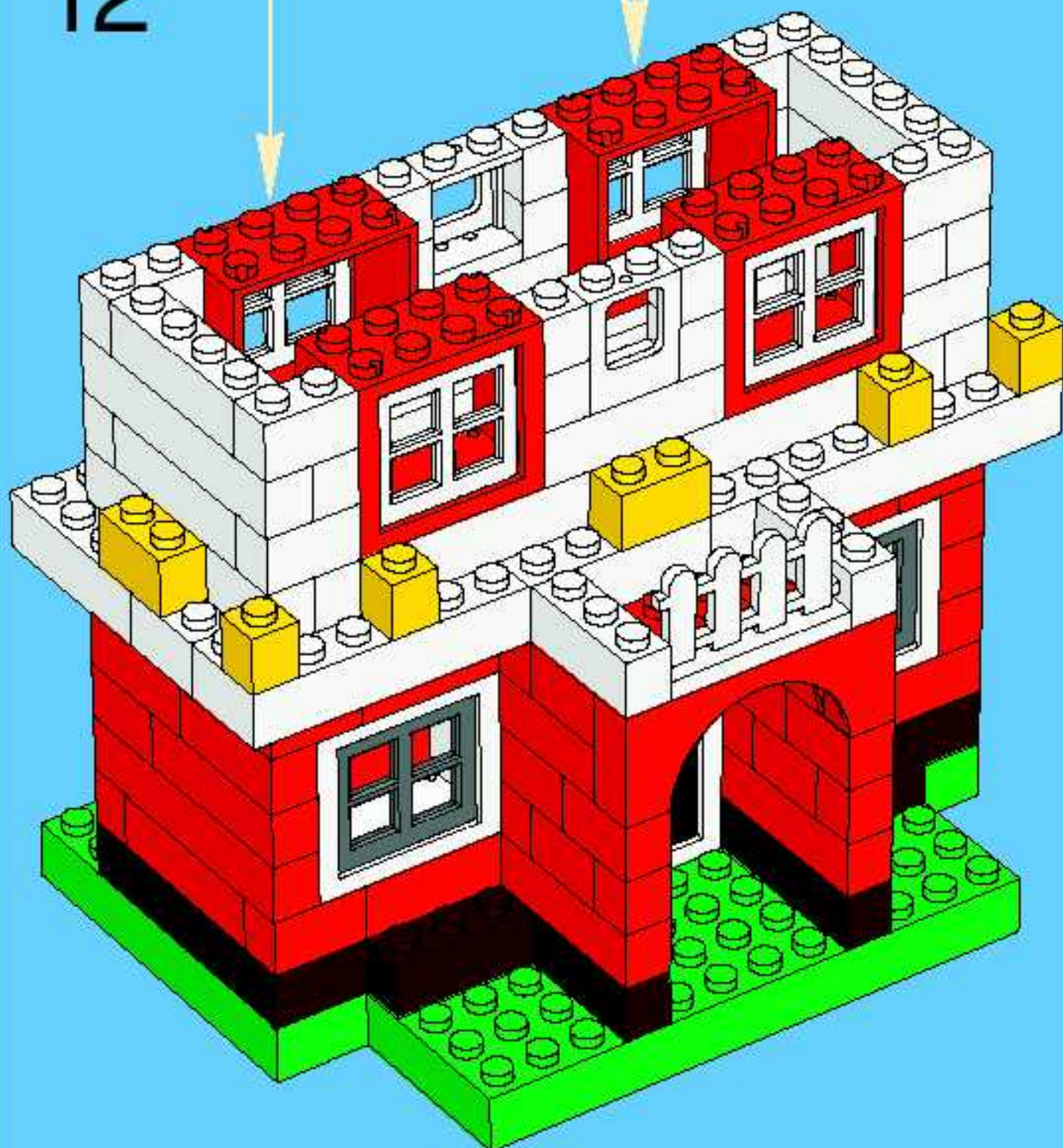

13

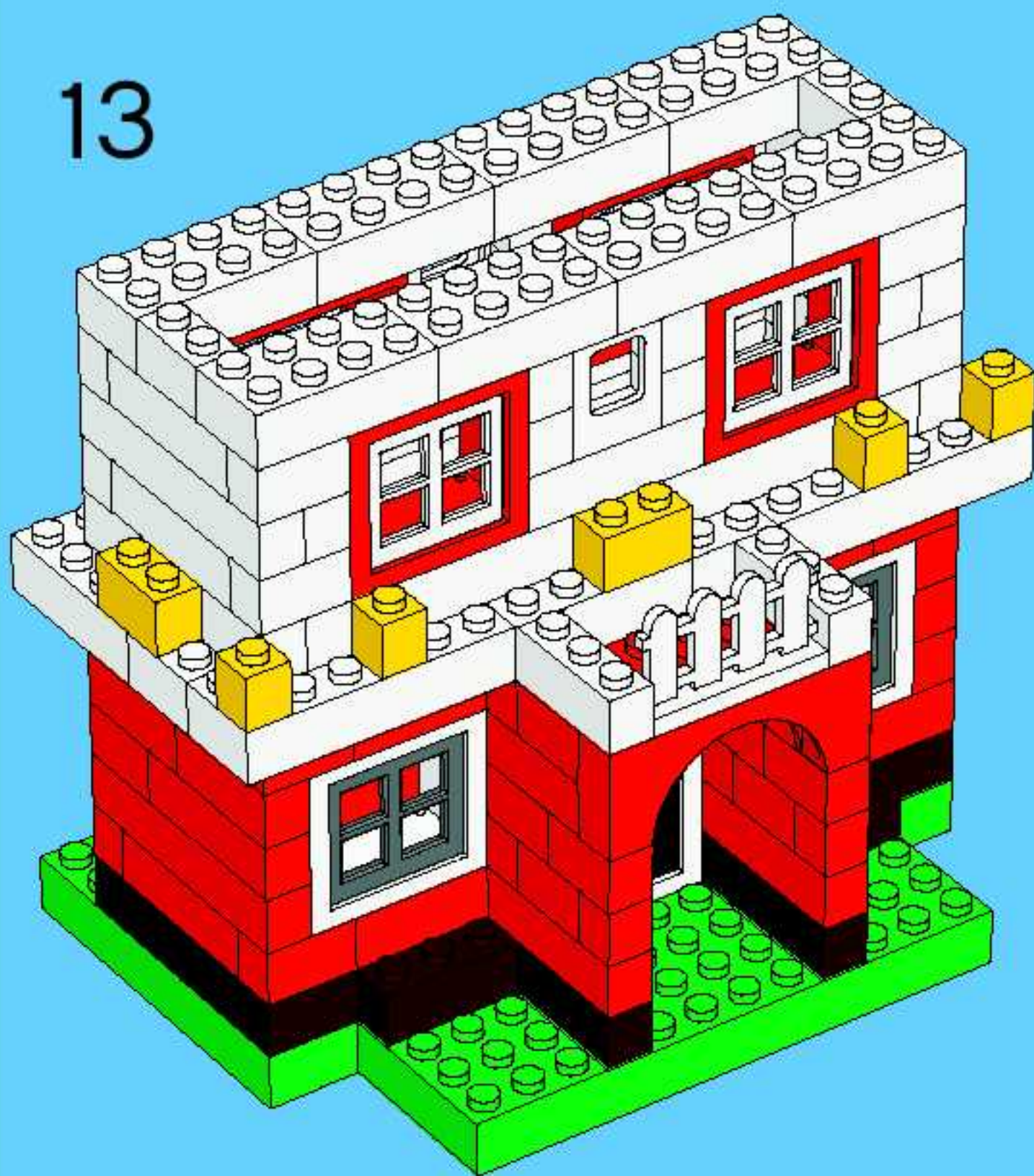

14

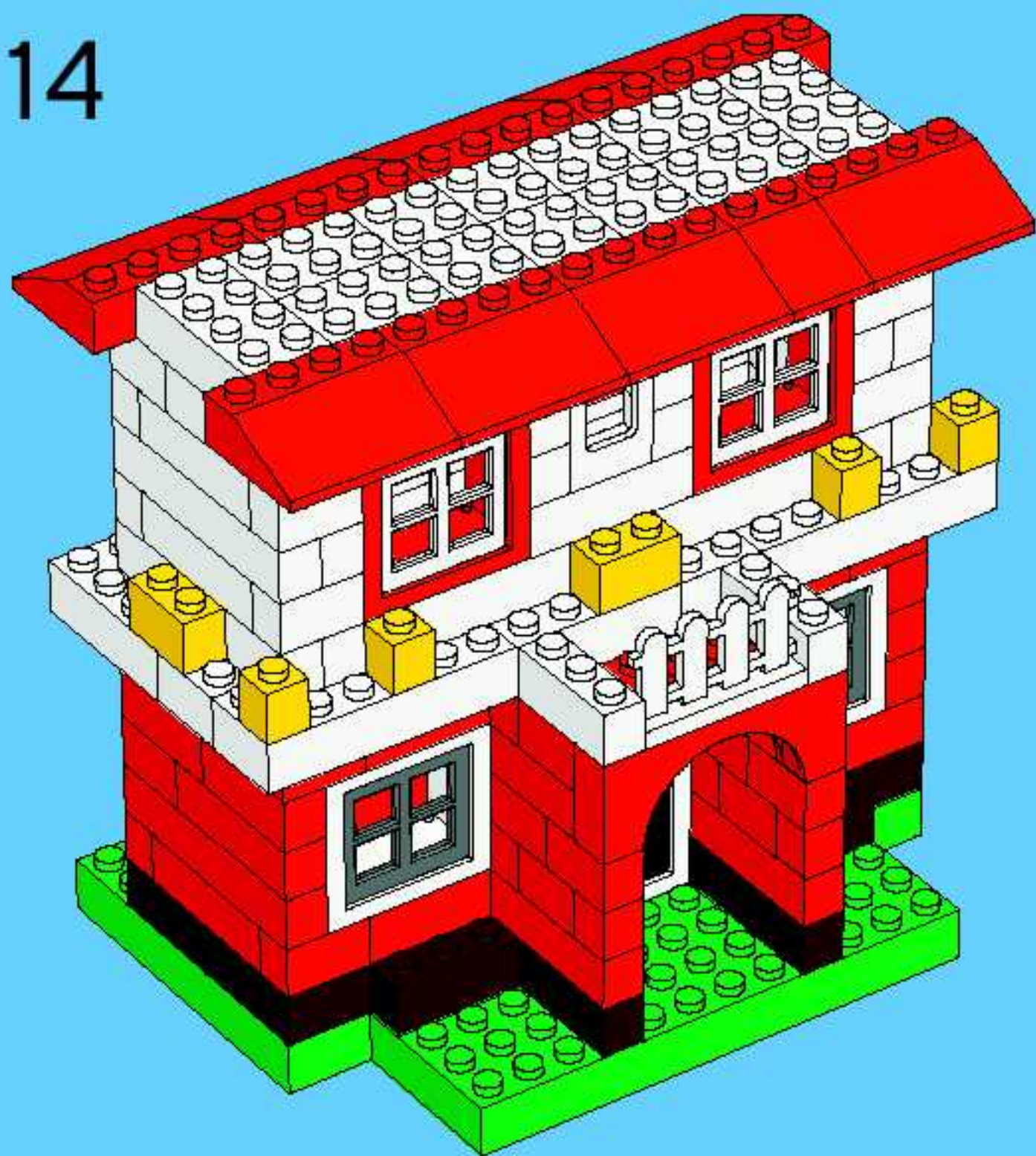

15

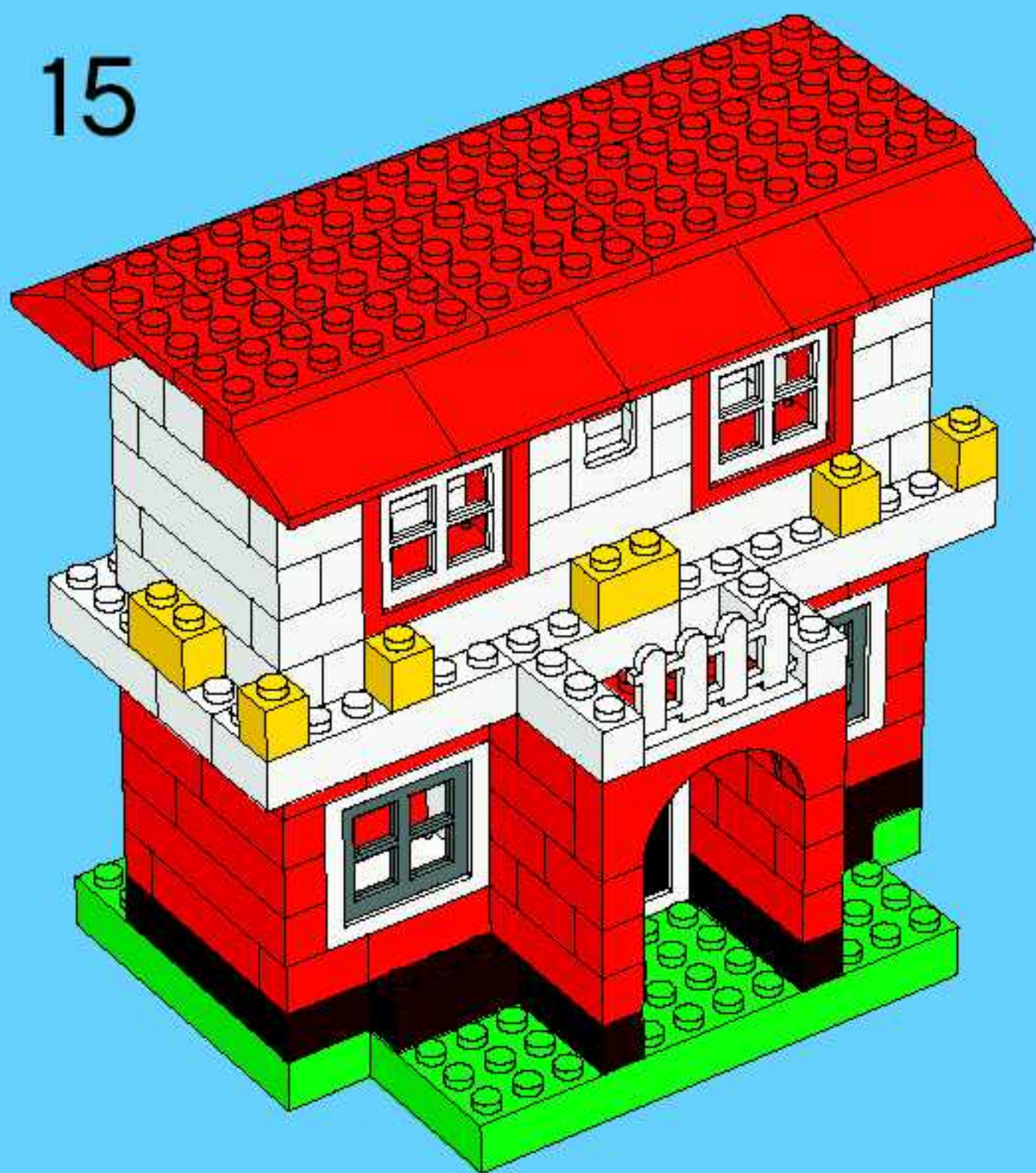



16x
300501



2x
4140002



24x
300401



8x
362201



10x
301001

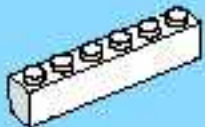

8x
300901



4x
300801



32x
300301



14x
300201



14x
300101



2x
4181142



2x
300701



2x
614301

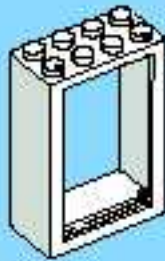

2x
4218637

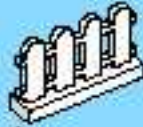

4x
4141607



2x
302201



2x
302101



2x
302001



2x
303401



2x
4194517



8x
4113220



4x
4218638



1x
472821



2x
366621



14x
300521



24x
300421



6x
362221



6x
301021



4x
300921



2x
300821



20x
300321



10x
300221



2x
621521



8x
300121



2x
4181138



1x
300721

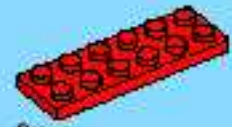

2x
379521



2x
303421



1x
4243814



1x
303521



2x
330021



3x
329921



4x
428621



8x
329821



12x
329721



4x
413221



2x
330721



2x
302221

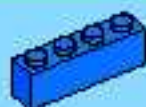

3x
301023



12x
300524

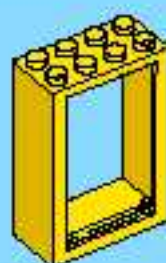

2x
4217794



3x
300126



2x
302121

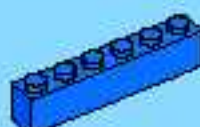

4x
300923



22x
300424

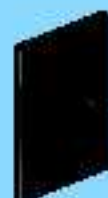

4x
4217795



2x
302021

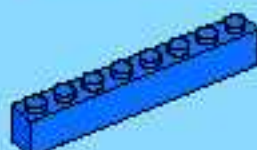

2x
300823



4x
362224



2x
366524



2x
4163373



6x
4211242



16x
300323



4x
301024



2x
4121965



1x
304126



8x
4211149



8x
300223



4x
300924



4x
303924



4x
4121966



2x
4211220



6x
300123



2x
300824



2x
366024



2x
303926



2x
4211225

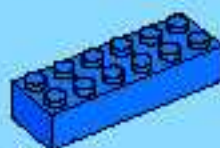

2x
4181139



18x
300324



2x
82357



6x
303726



6x
4211210



1x
300723



8x
300224



6x
300526



6x
303726



2x
4216668



1x
472823



8x
300124



10x
300426



4x
601526



2x
4211201



4x
4143291

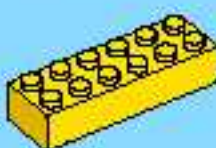

2x
4181143



4x
362226



2x
4113028



10x
300523



2x
306543

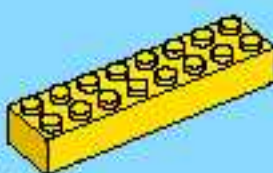

1x
300724



2x
301026



2x
4211504



20x
300423



8x
300326

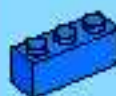

4x
362223



4x
300226



4x
4211764



6x
300528



10x
4107736



4x
4109679



2x
4112838



8x
300328



4x
4109674



3x
4106356



1x
606428



2x
303928



2x
4142717



2x
4220027



2x
4143562

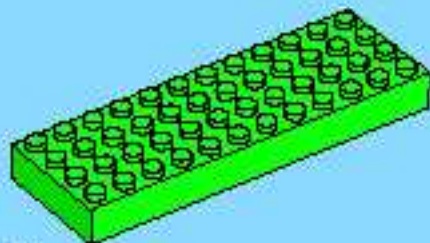

2x
4250511

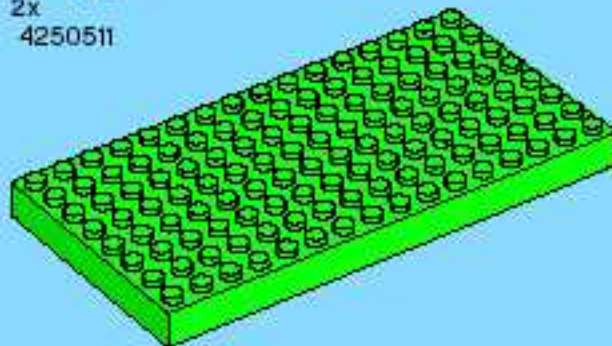

1x
4181116



6x
4220634



8x
4164022



2x
4166093



2x
4234716



6x
4220632



2x
4220631



2x
4165967

Win!

Gagne! 当たります

Gewinne!



Win LEGO products

We would like to know what you think about your new LEGO product. Log on to the web address below for further instructions.

Gagne des produits LEGO

Nous aimerions savoir ce que tu penses de ton nouveau produit LEGO. Tu obtiendras davantage d'informations en visitant le site Internet indique ci-dessous.

Gewinne LEGO produkte

Wir sind sehr an deiner Meinung über dein neues LEGO Produkt interessiert. Gehe einfach zu der unten angegebenen Webadresse – dort findest du weitere Informationen.

Estimado usuario LEGO

Al contestar algunas preguntas en inglés, francés, alemán o japonés, en el sitio www.acnielsen.aim.dk/lego, podrás participar en el sorteo de algunos valiosos premios LEGO.

Caro Consumidor da LEGO

Ao responder a algumas perguntas em Inglês, Francês, Alemão ou Japonês no endereço www.acnielsen.aim.dk/lego irá participar num concurso para ganhar valiosos prémios da LEGO.

Kedves ifjú LEGO Vásárló

Ha ellátogatsz a www.acnielsen.aim.dk/lego honlapra és ott angol, francia, német vagy japán nyelven megválaszolsz néhány kérdést, akkor részt veszel egy versenyben, amelyben értékes LEGO díjakat nyerhetsz.

抽選でレゴの製品が当たります

私たちは、皆さんが好きなレゴの製品についての皆さんの感想をお待ちか、お待ちしております。質問に答えて、楽しいレゴ製品の抽選に応募してください。アンケートの結果には、日本人の皆さんとしかがかりません！詳しくは、以下のウェブアドレスまでアクセスしてください。



www.acnielsen.aim.dk/LEGO



Any questions regarding your new LEGO product, please contact:

Customer Service | Kundenservice

Service Consommateurs

Servicio Al Consumidor at

www.lego.com/service or dial

               :

00800 5346 5555

  :

1-800-422-5346



Discover the **LEGO® UNIVERSE!**

Entdecke das **LEGO® UNIVERSUM!**

Ontdek het **LEGO® UNIVERSUM!**

Découvre **L'UNIVERS LEGO® !**



FREE LEGO Magazines
Des Magazines LEGO GRATUITS !
GRATIS LEGO Magazine
KOSTENLOSE LEGO Magazine



SHOP at HOME



BIC26 BIC26



BI06U BI06U BI06F BI06C BI06C BI06C BI06N

Sign up now! Jetzt anmelden!

Abonnez-vous maintenant! Meld je nu aan!

<http://club.LEGO.com/signup>

www.LEGOshop.com/catalog

