



4645

# CITY





4

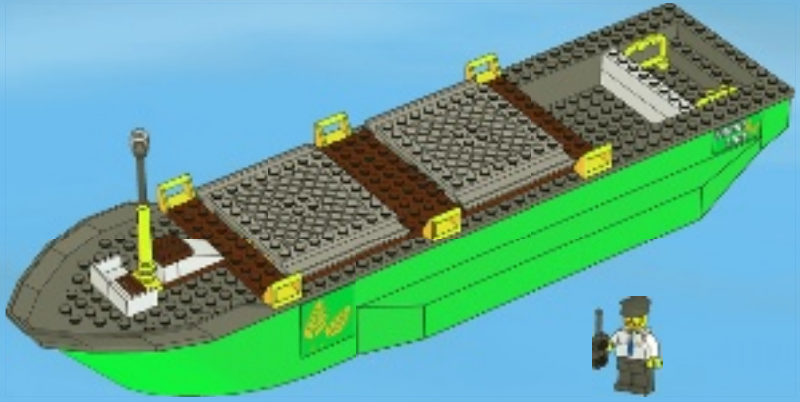

5

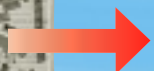



4

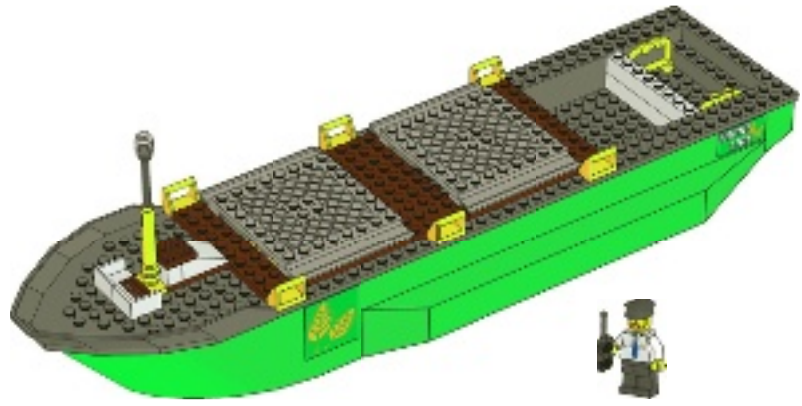



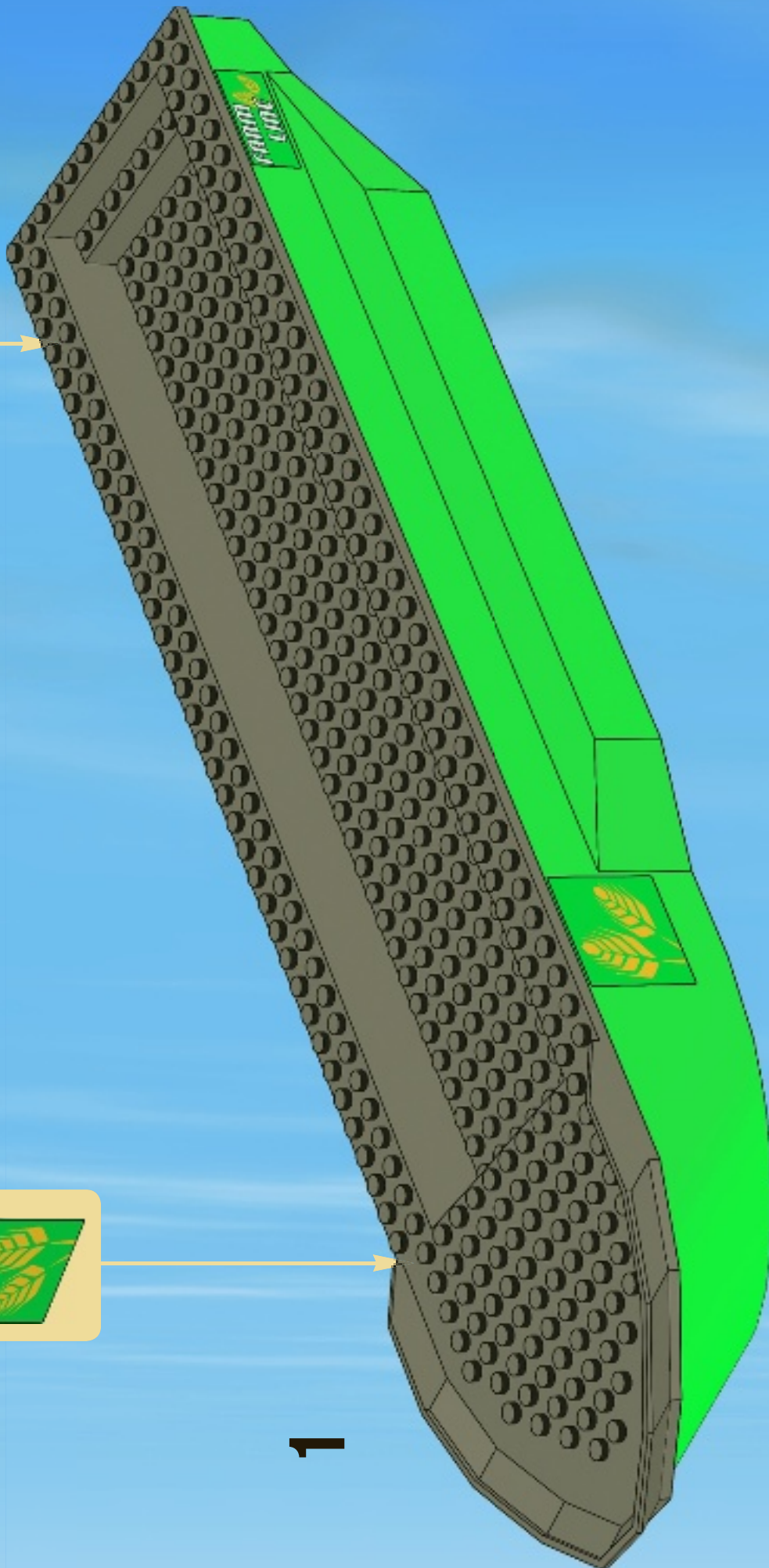

1

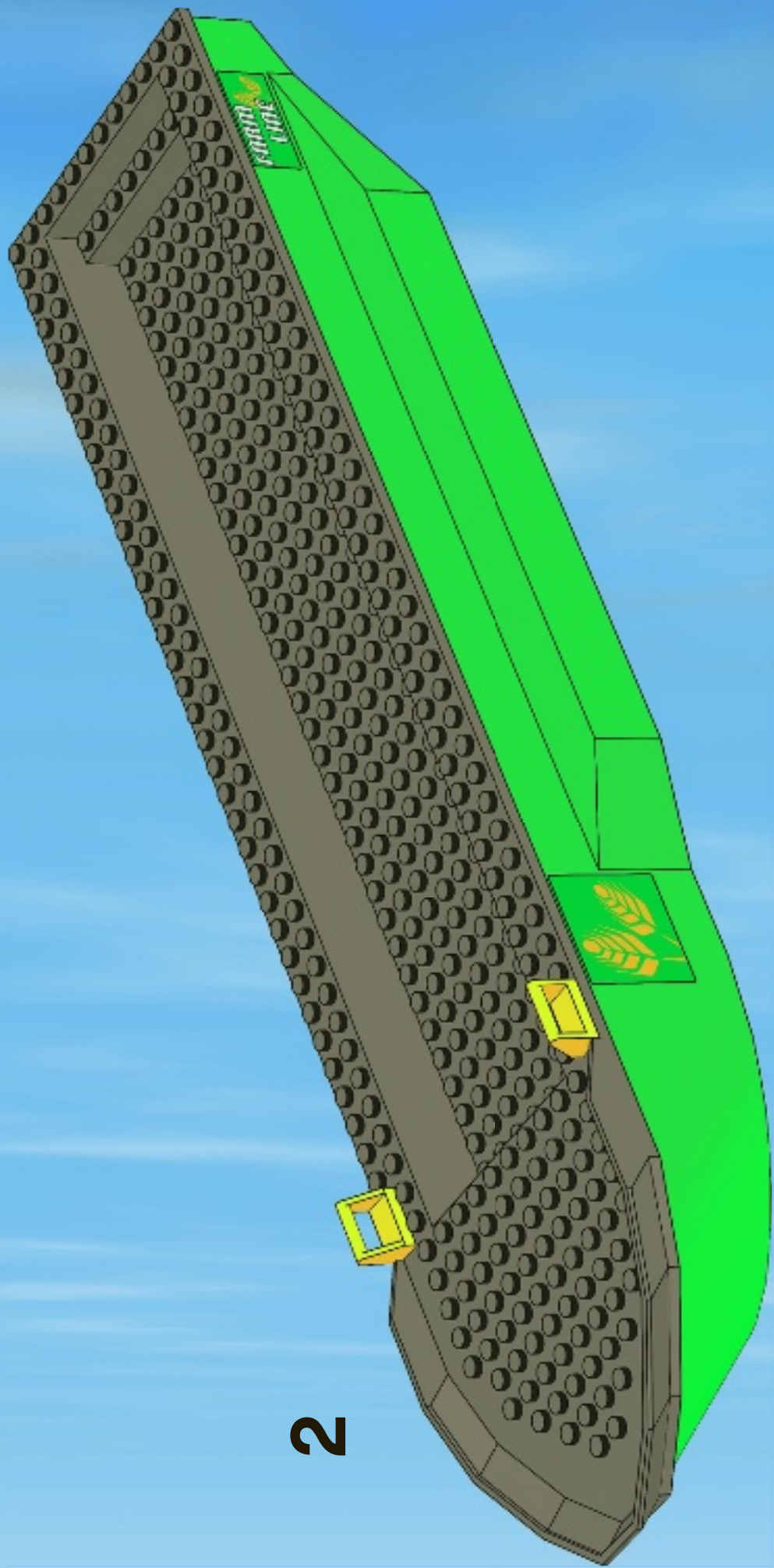

2

3

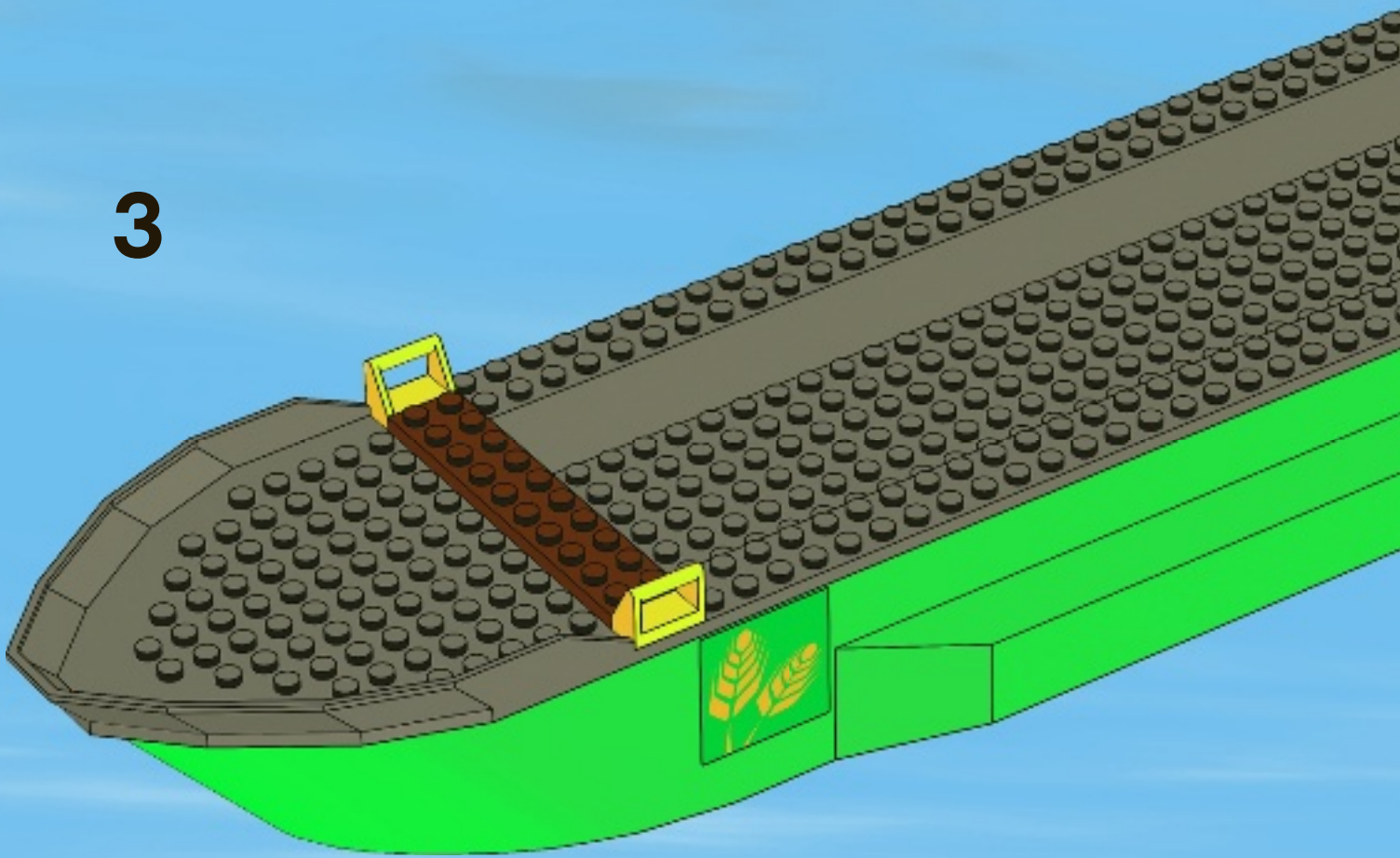



4

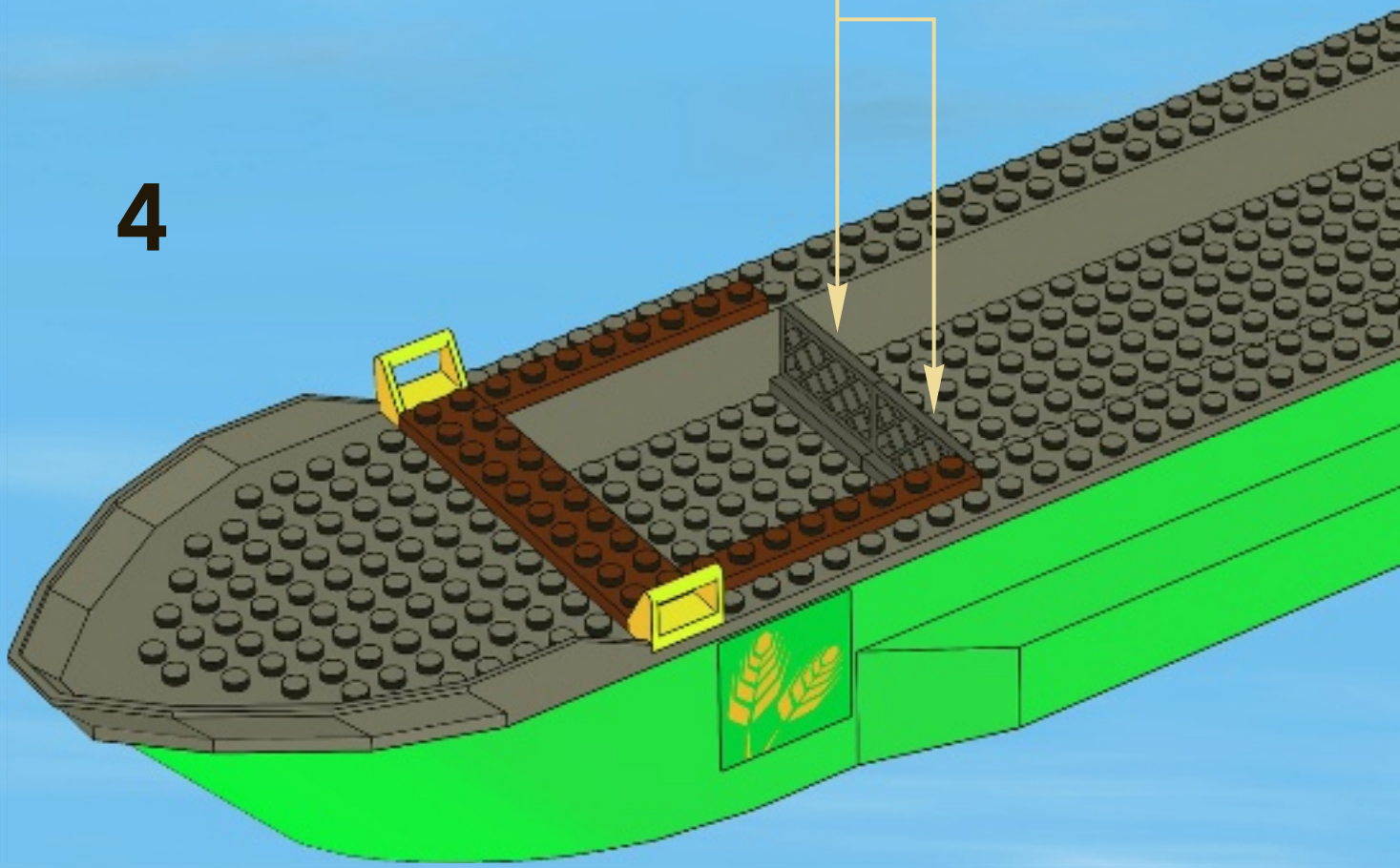
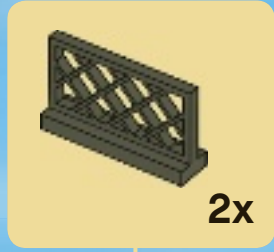

5

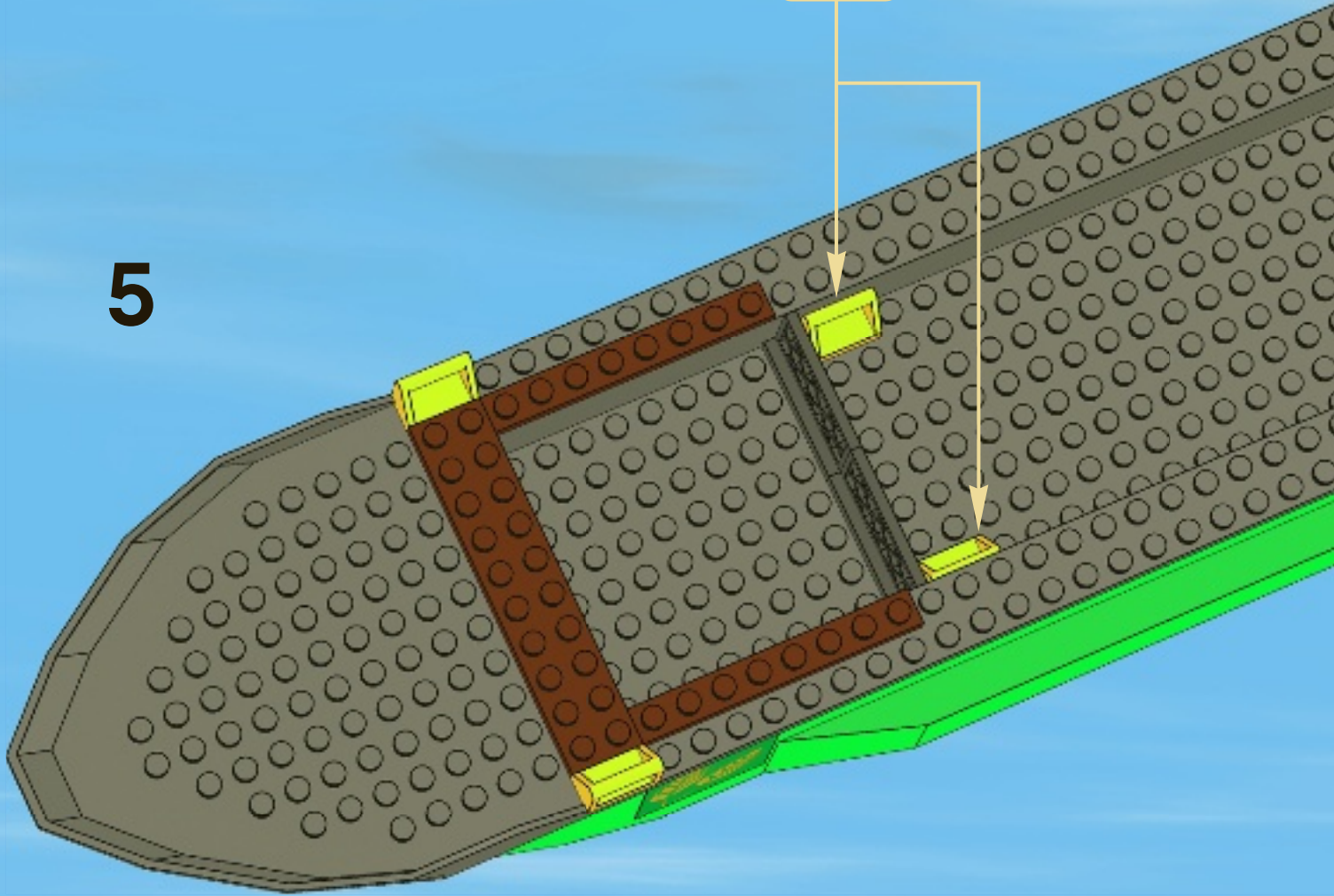
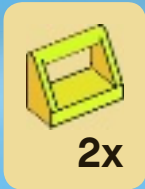



6

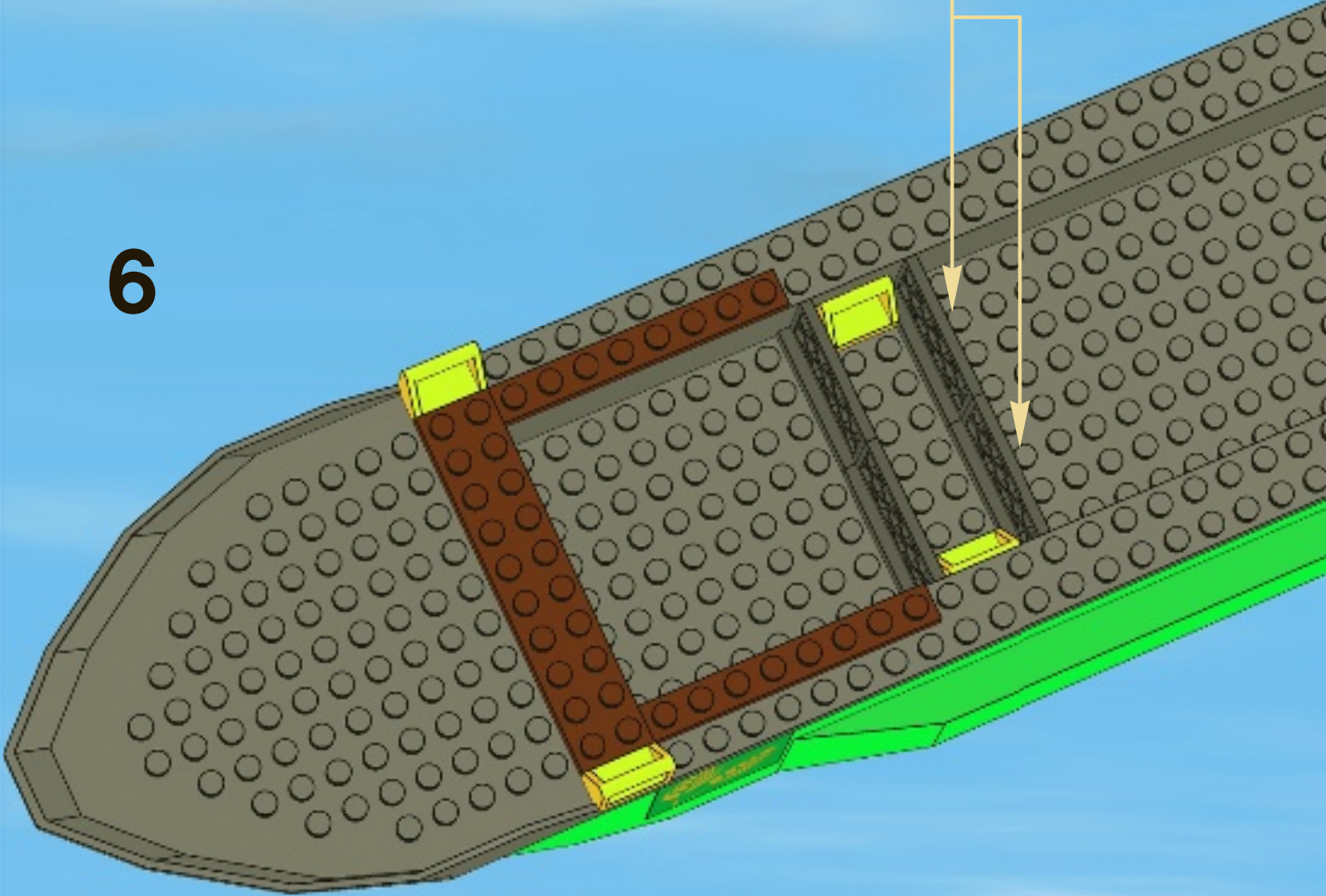
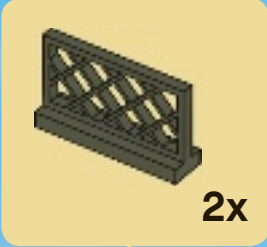

7

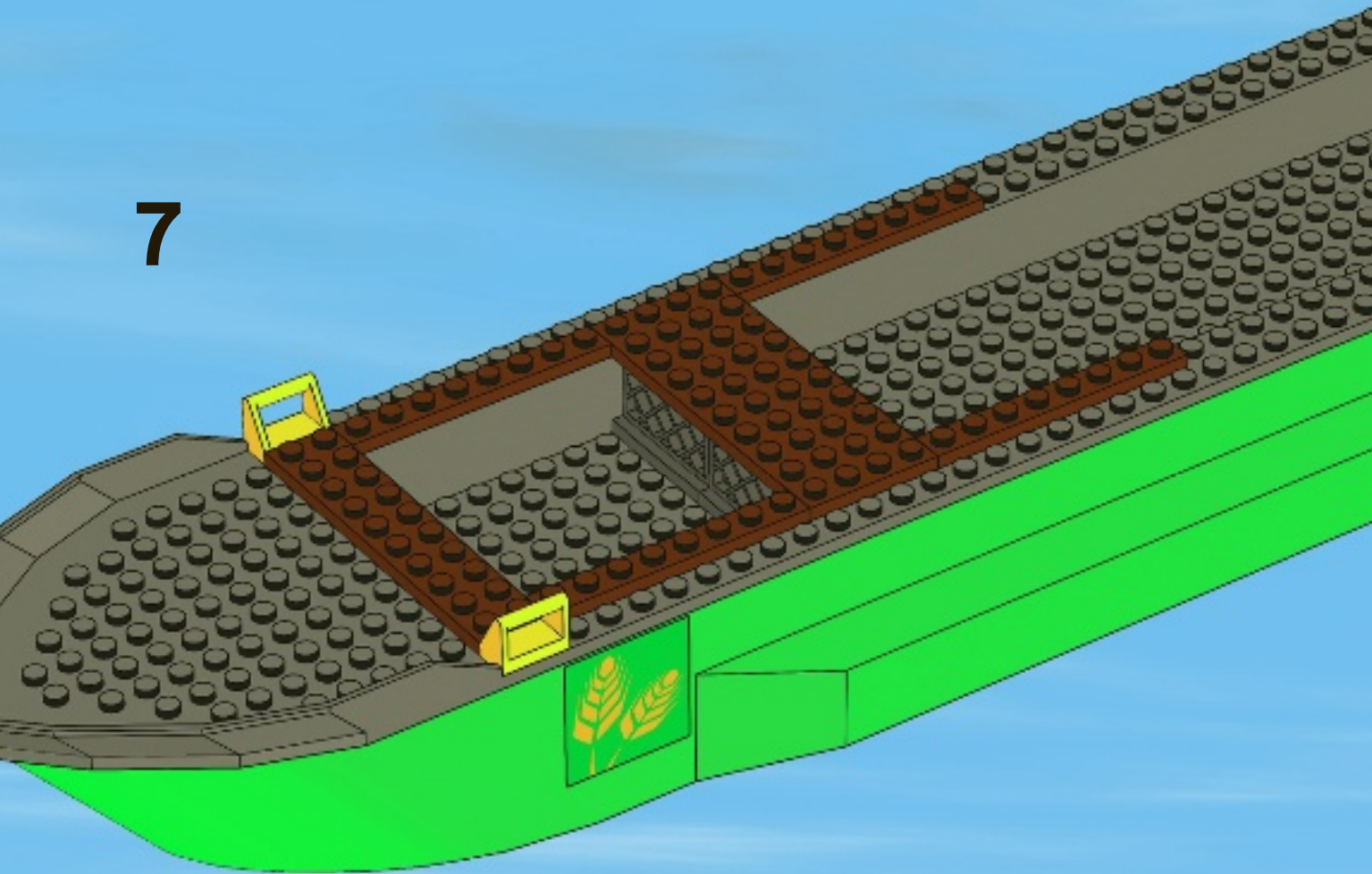

8

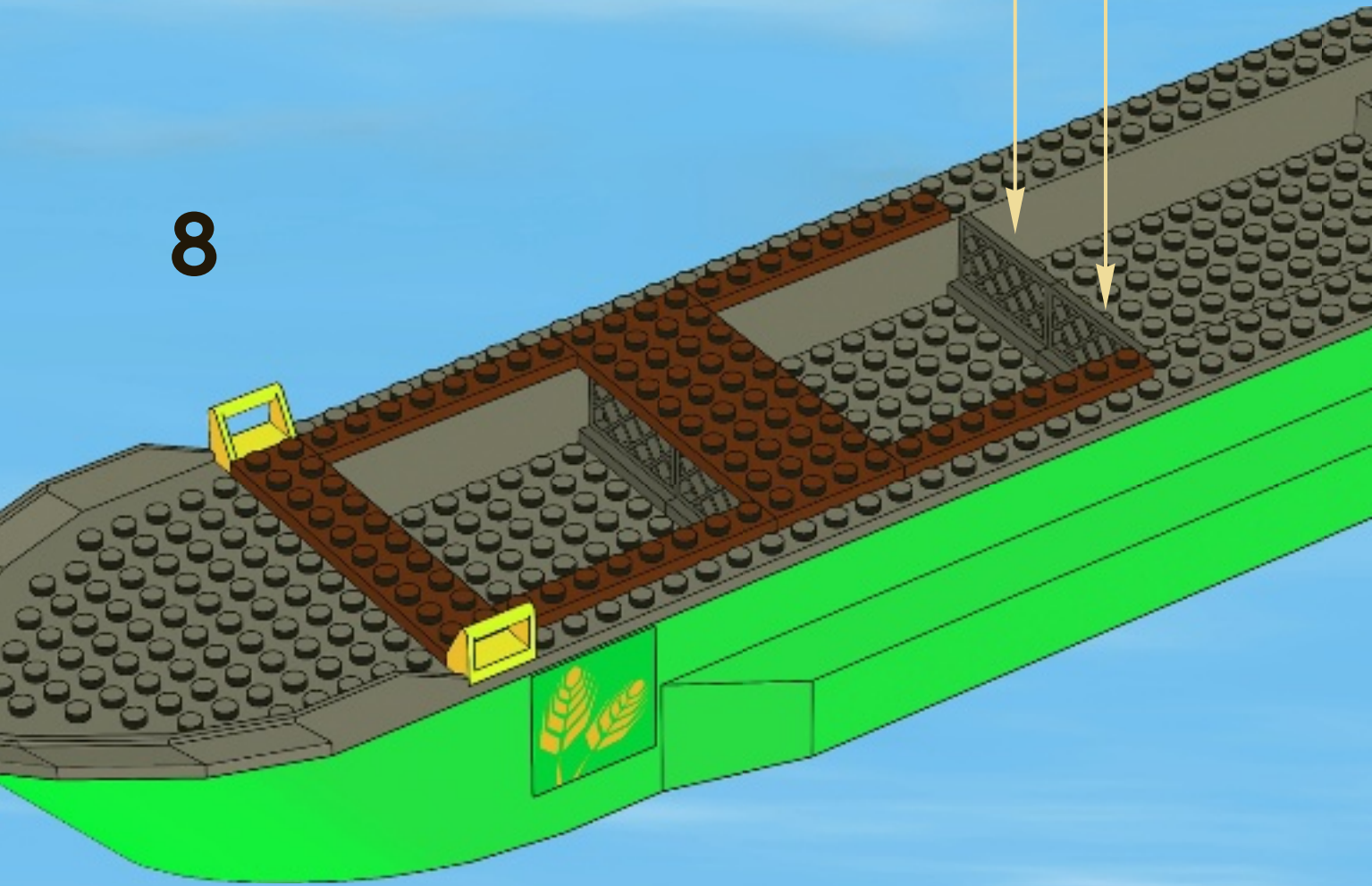
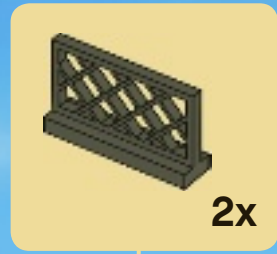



9

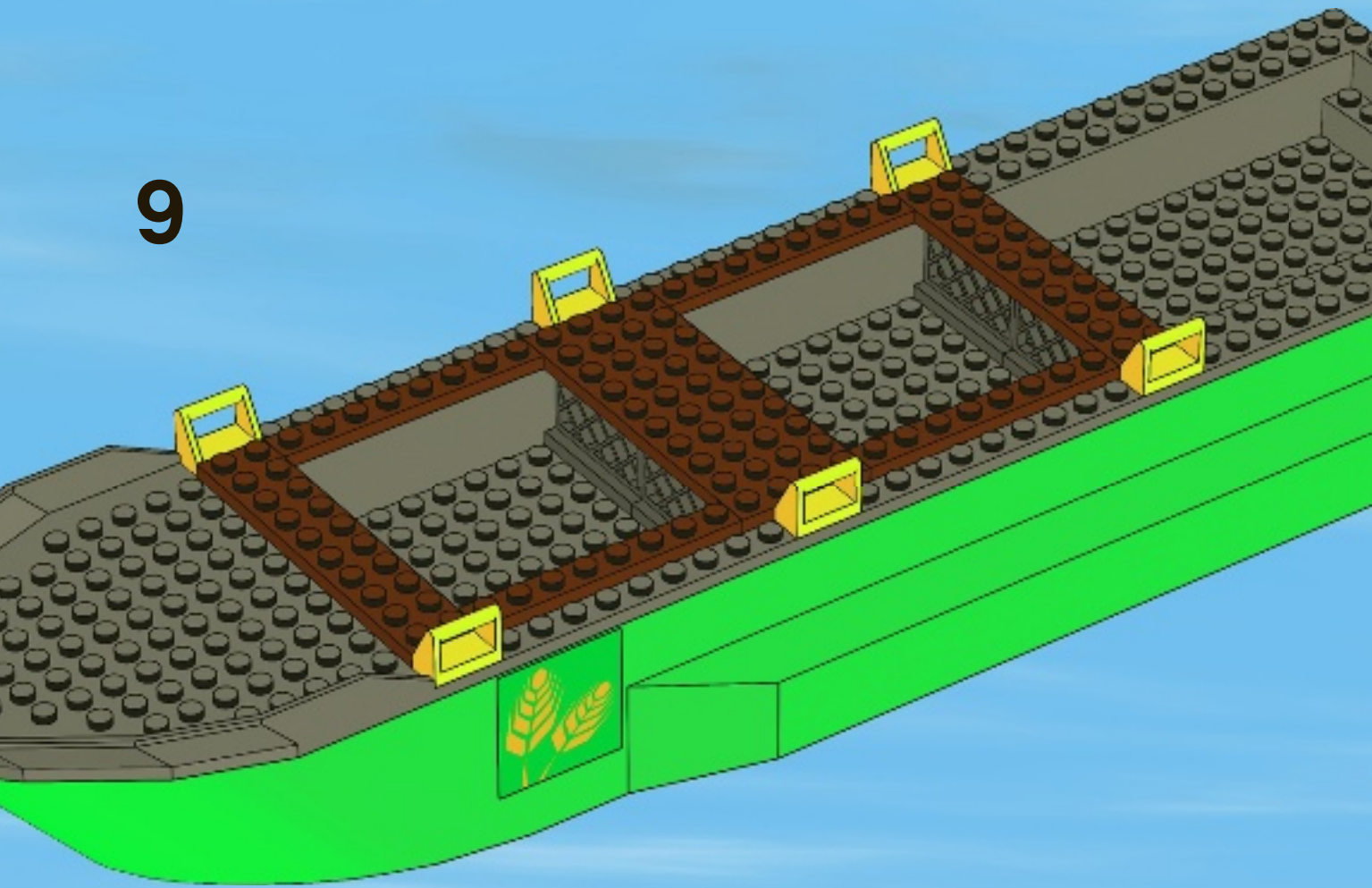

10

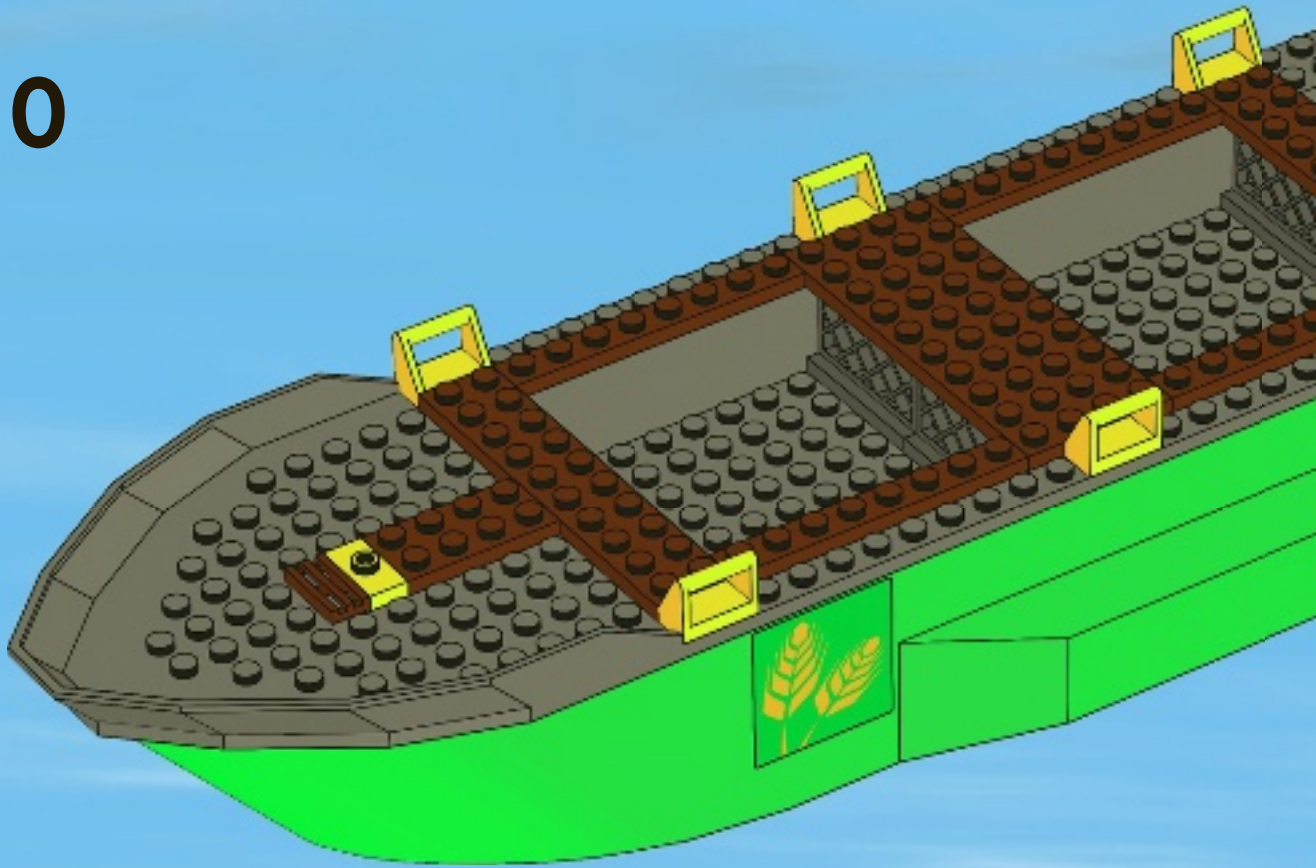

11

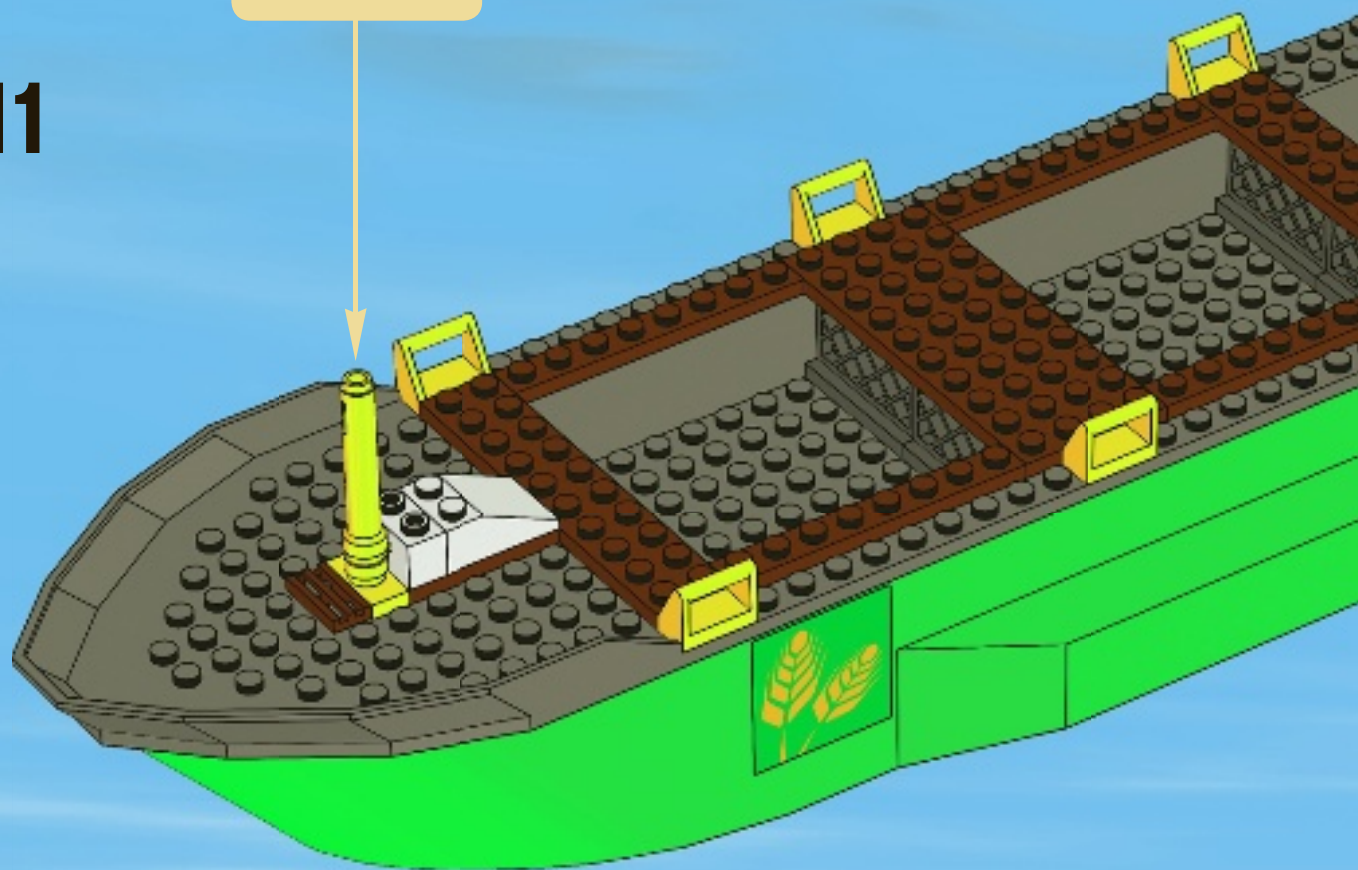
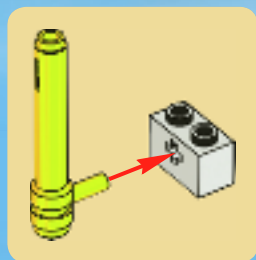



12

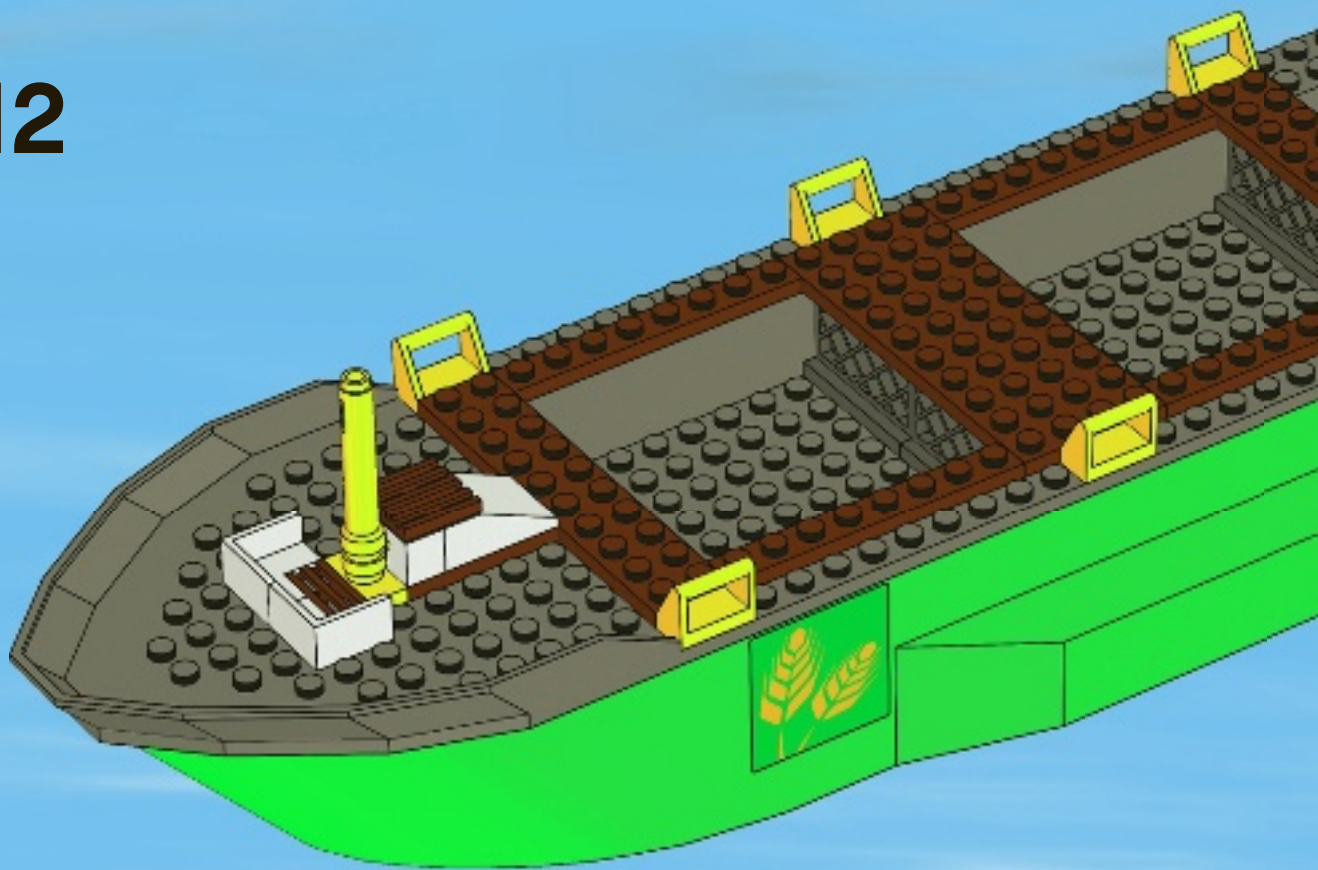

13

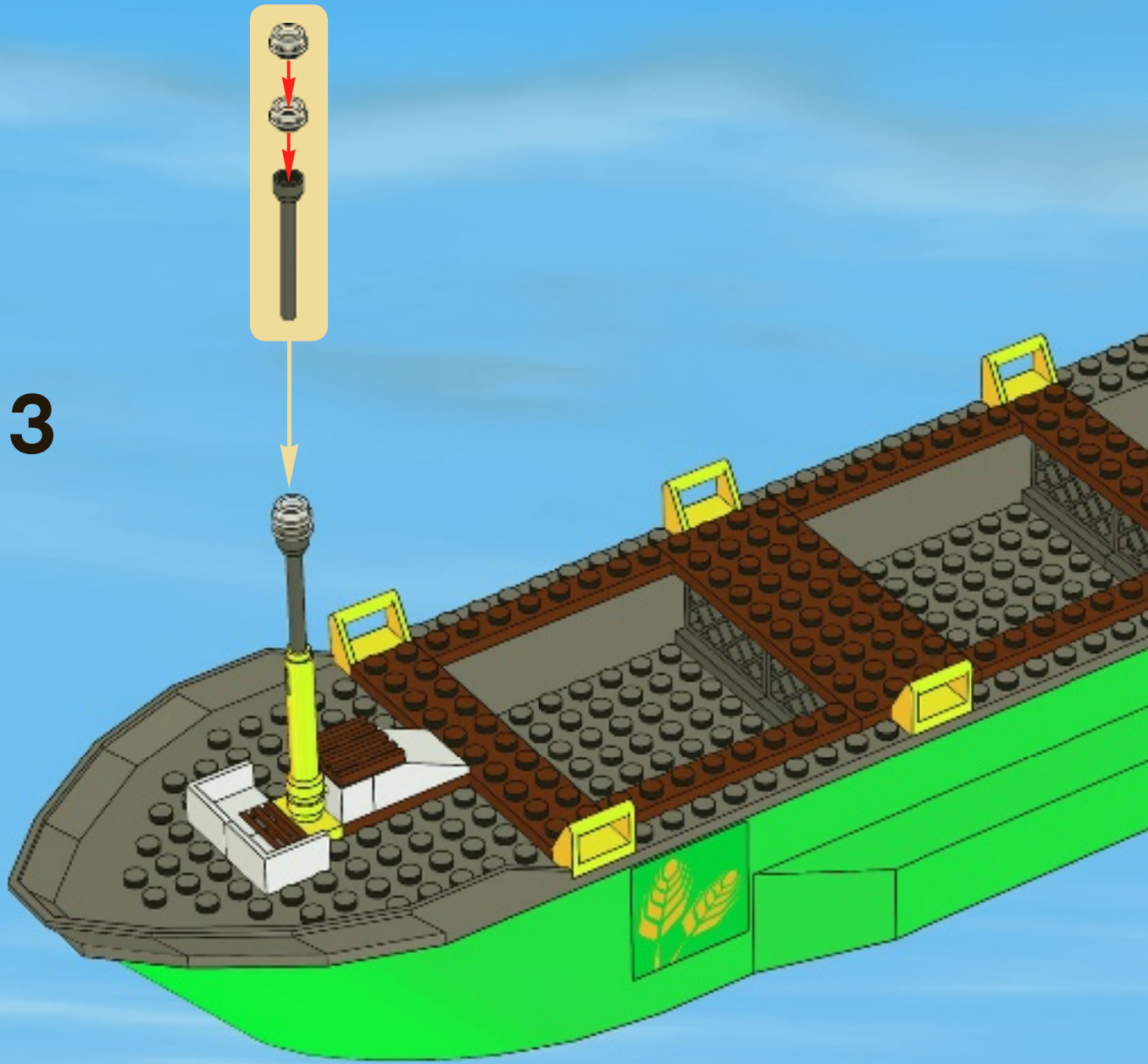

14

  
36x

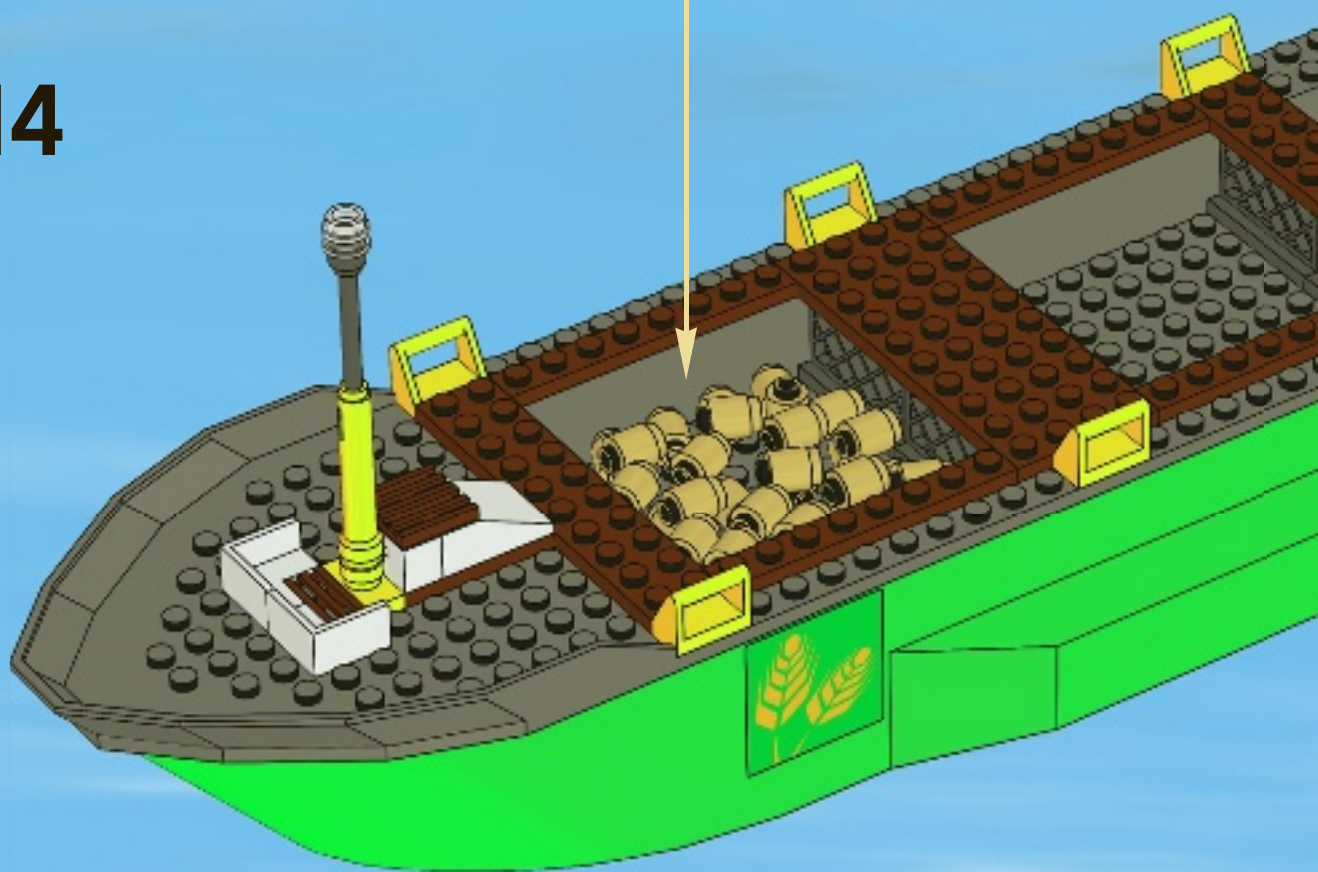



1

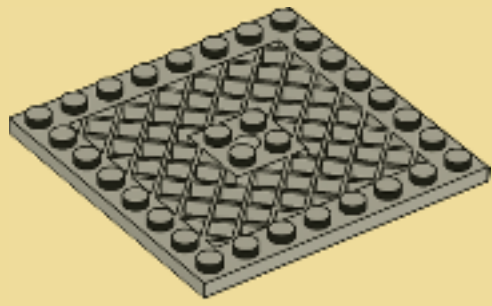

2

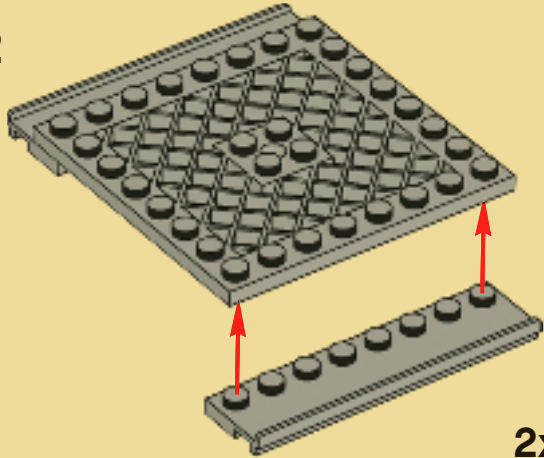

2x

15

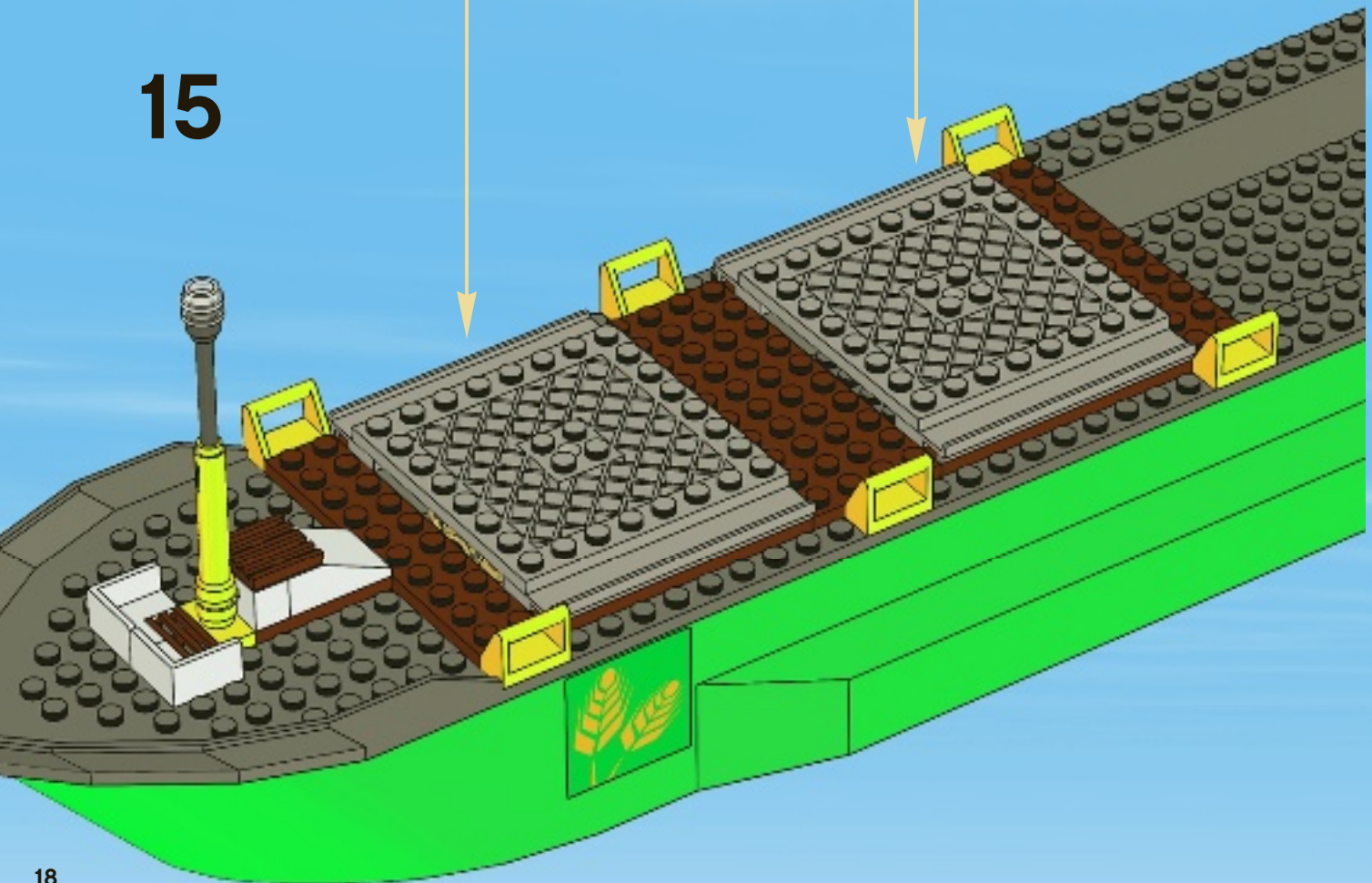

16

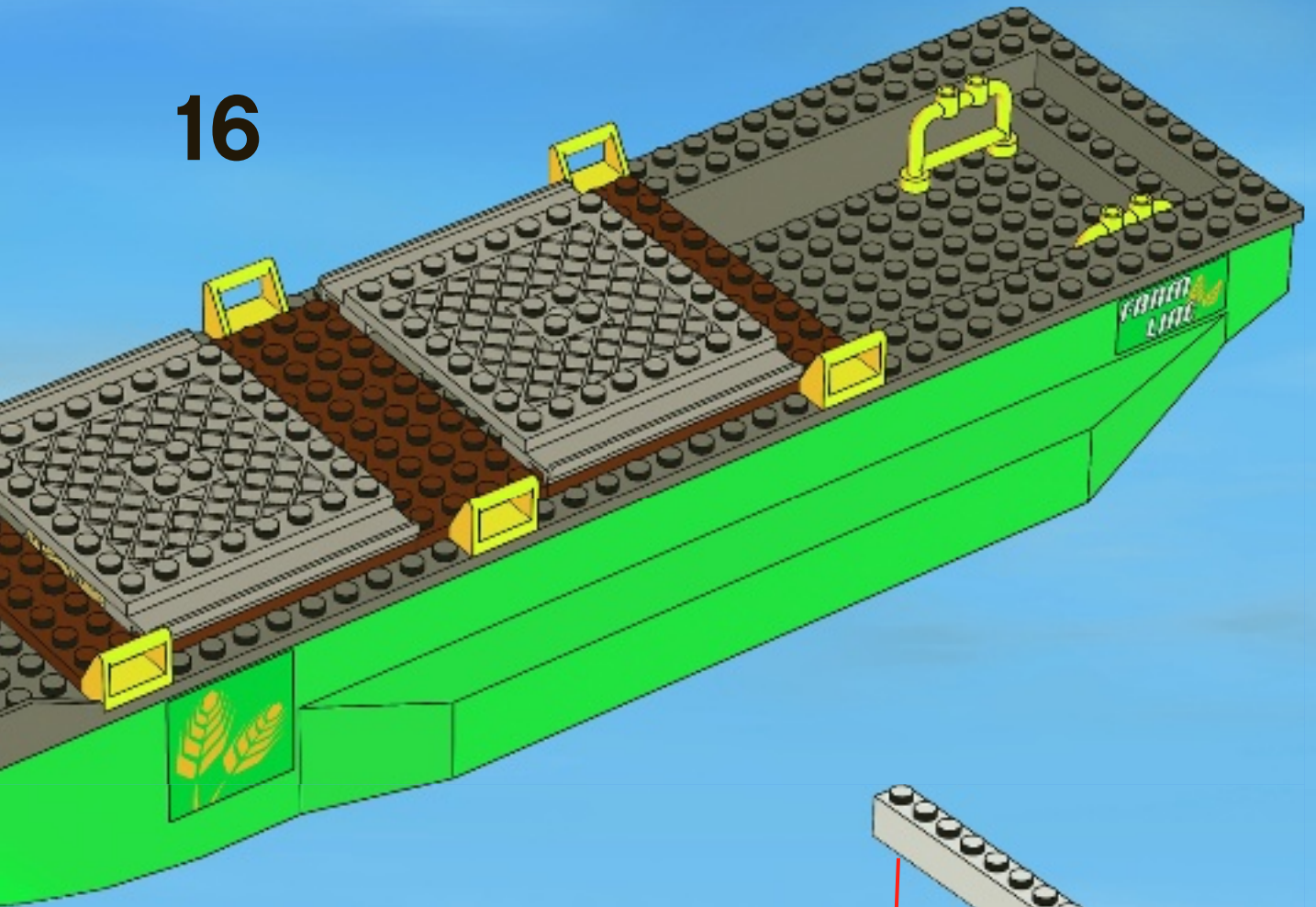

17

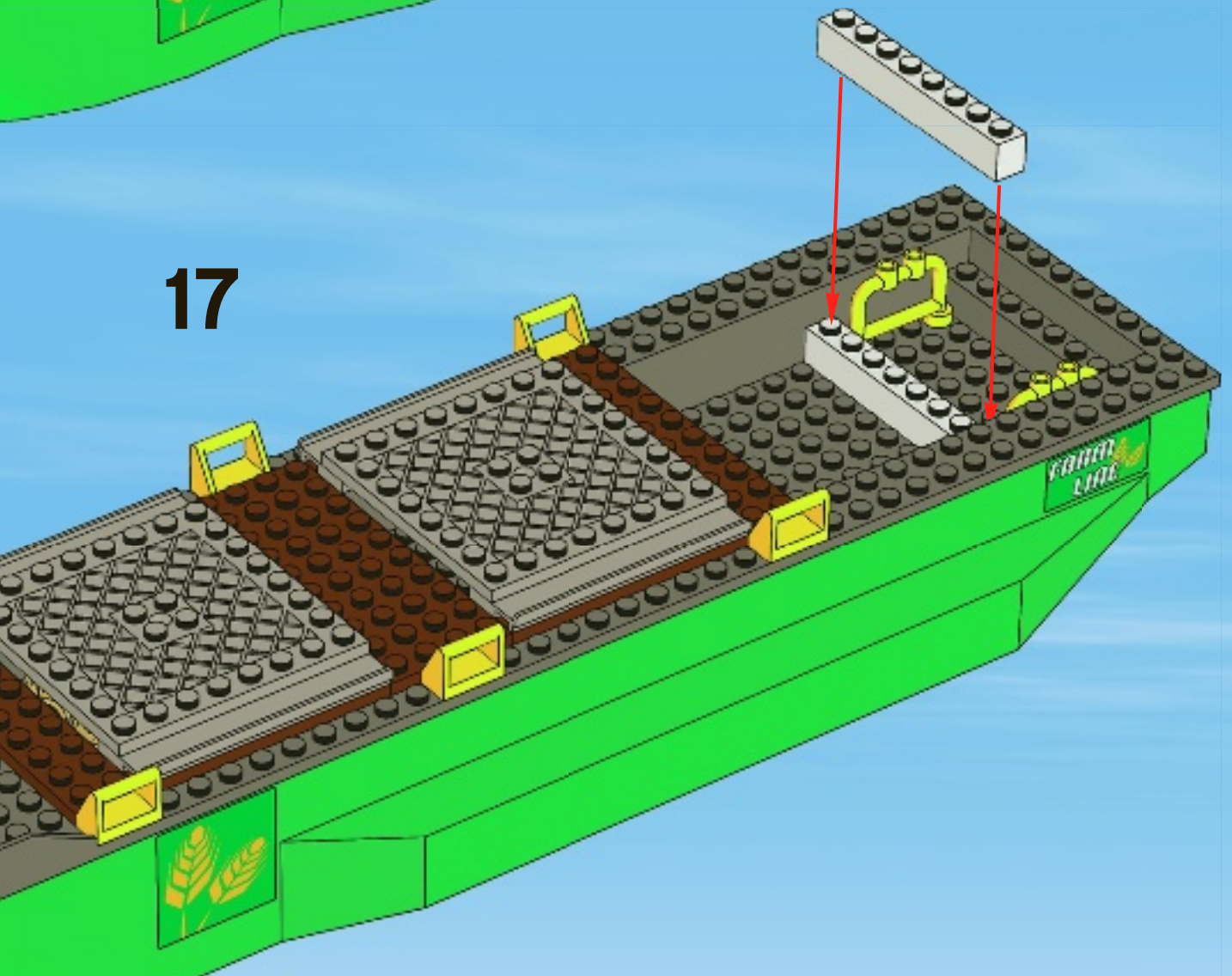





1

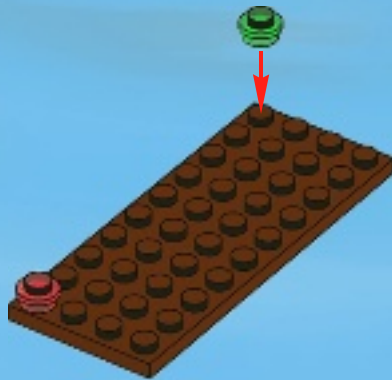

2

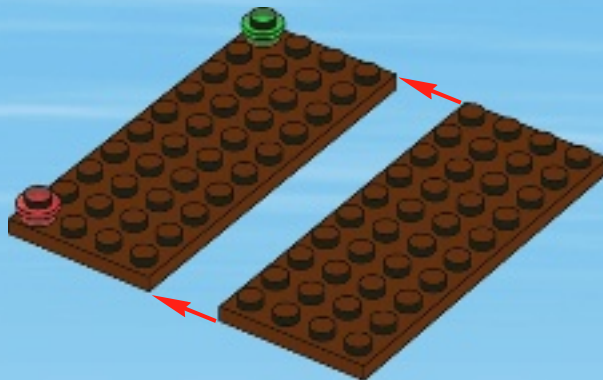



3



4

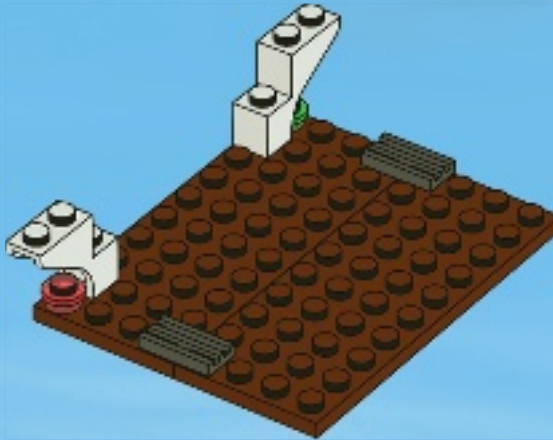

5

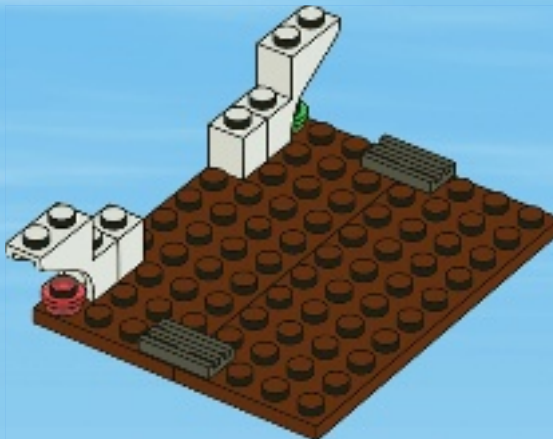

6



7

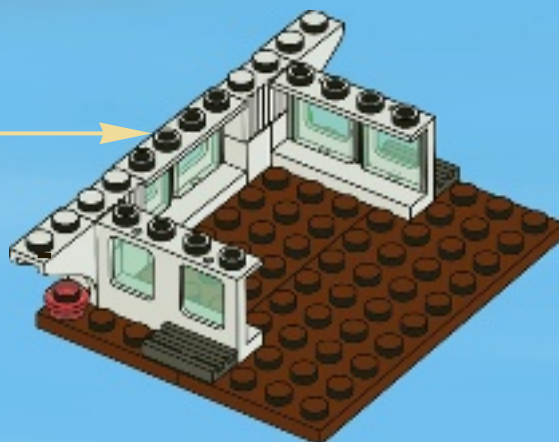
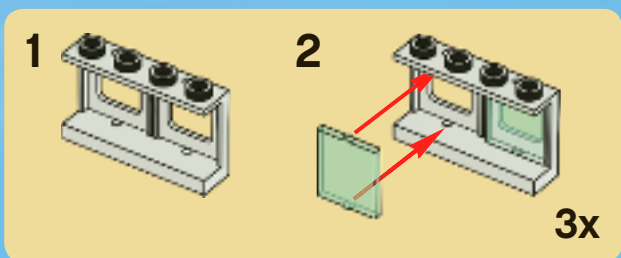

8



9



10

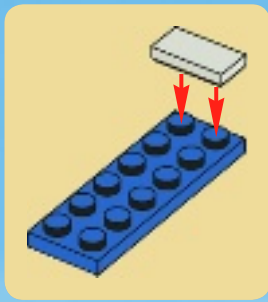

11

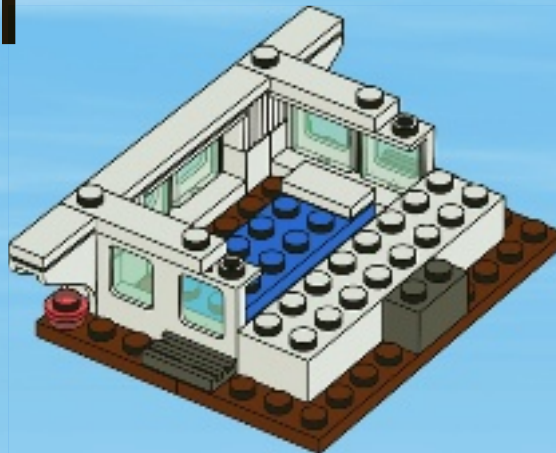



12

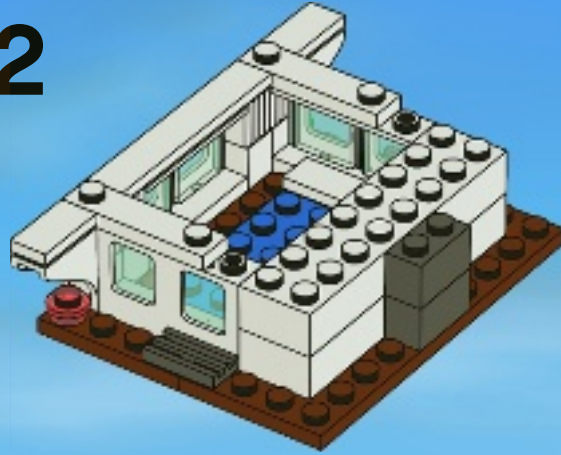

13

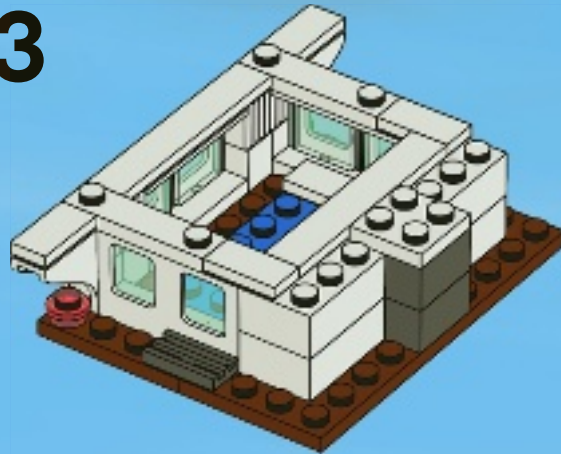

14

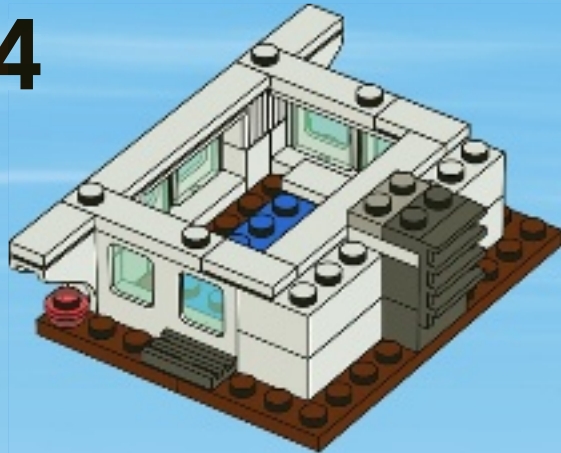

15

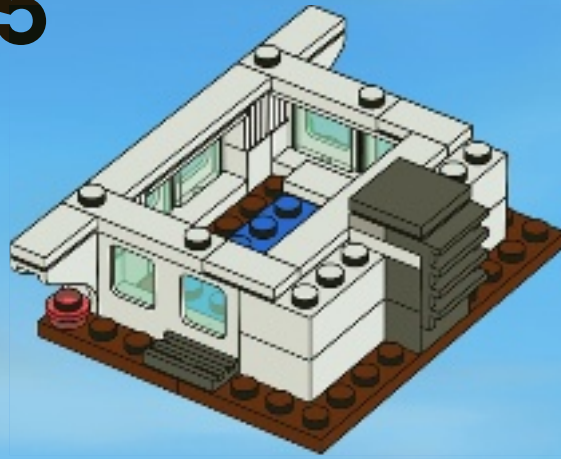

16

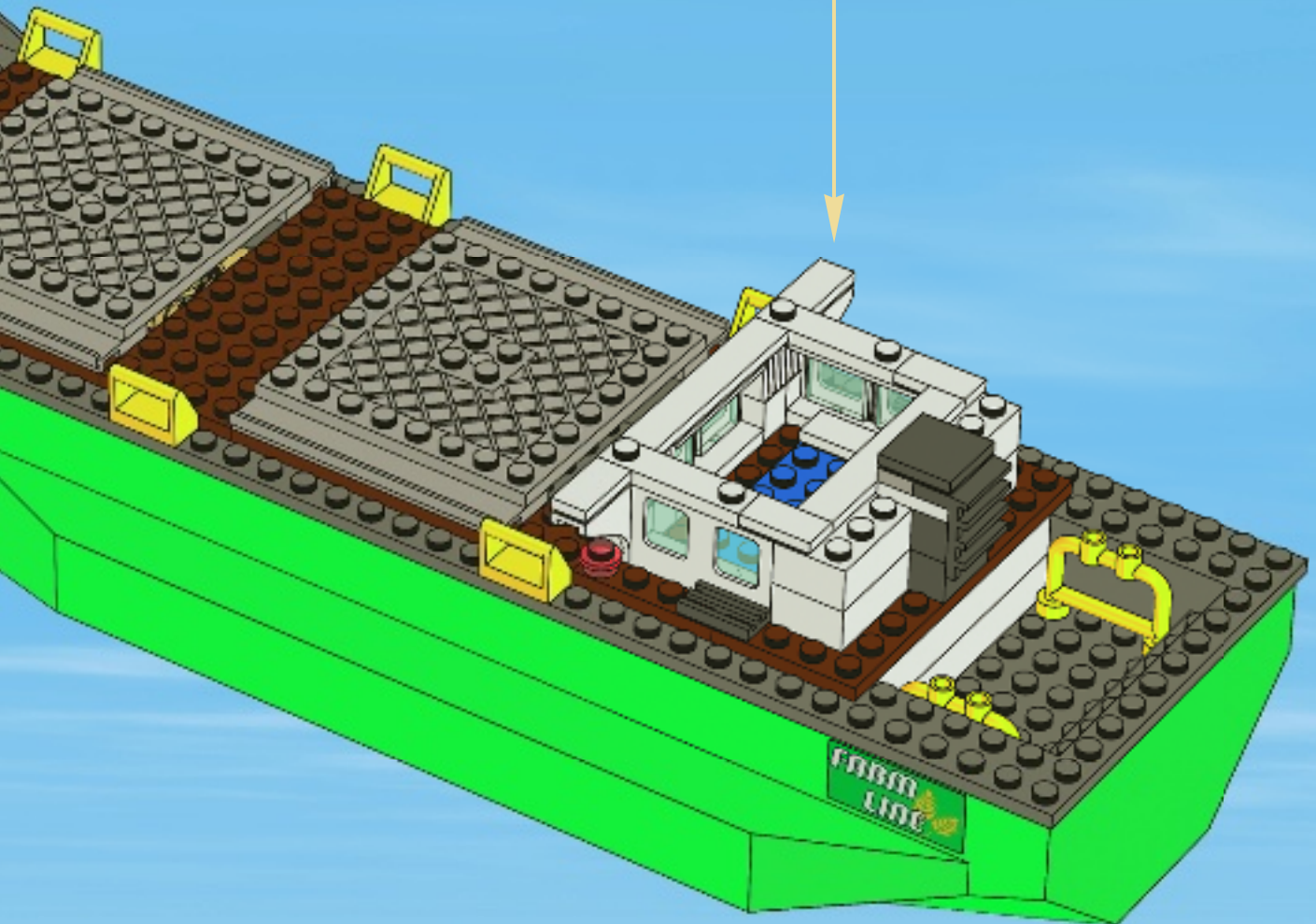



**1**

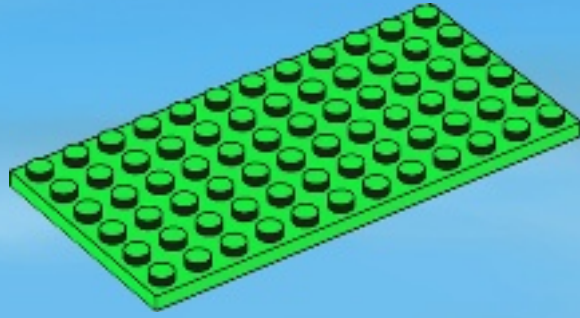

**2**

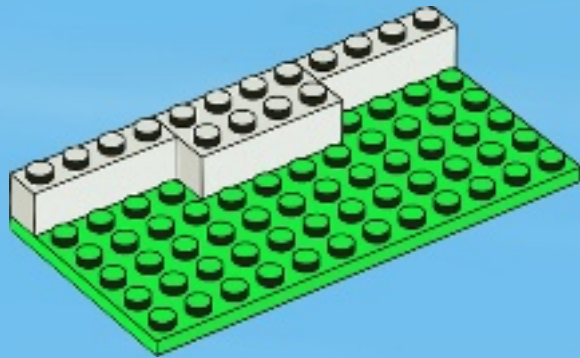

**3**

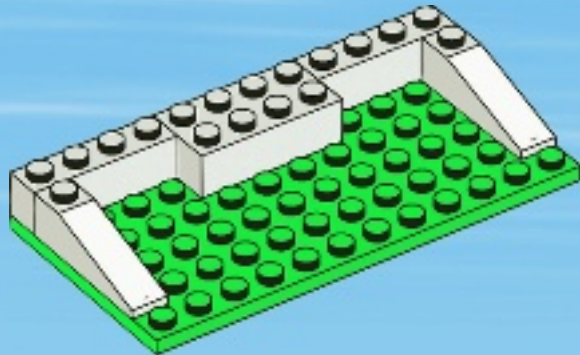



4

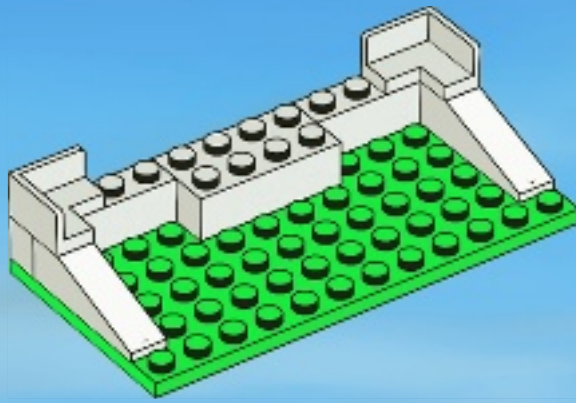

5

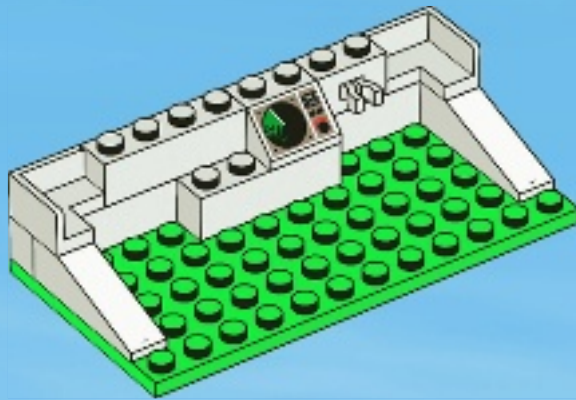

6

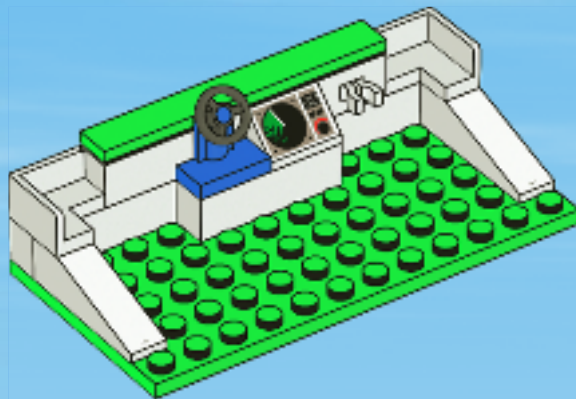



10

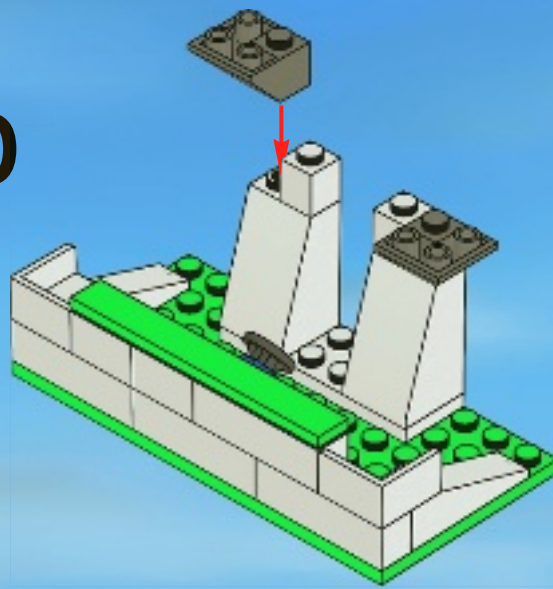

11

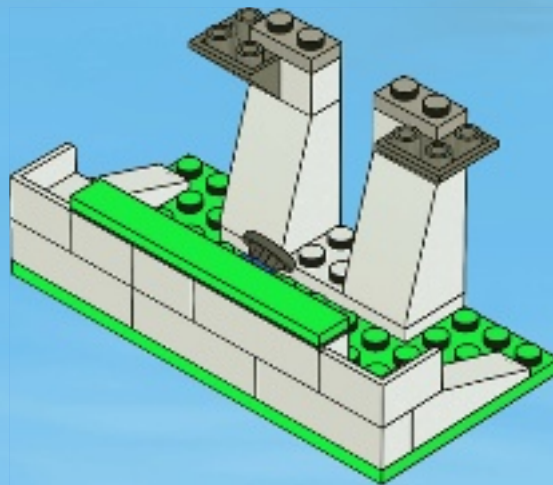

12

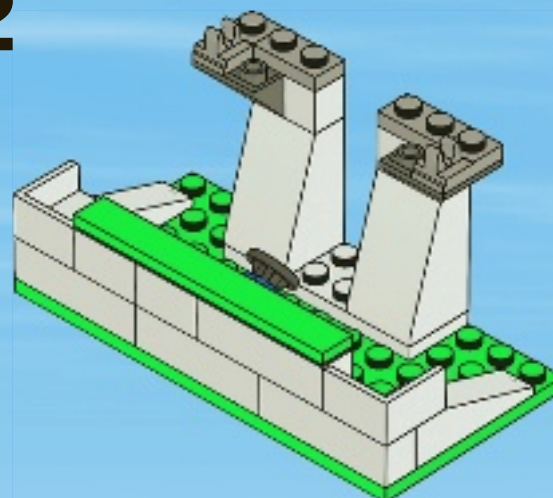



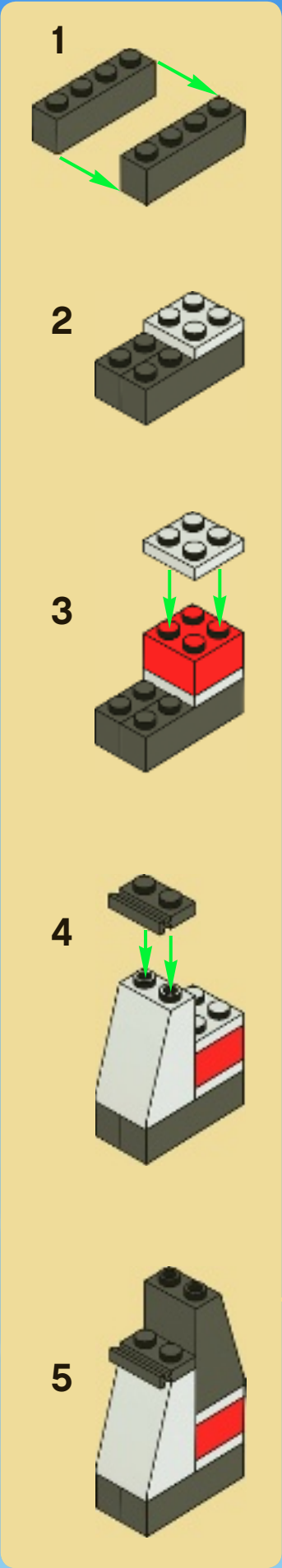

13

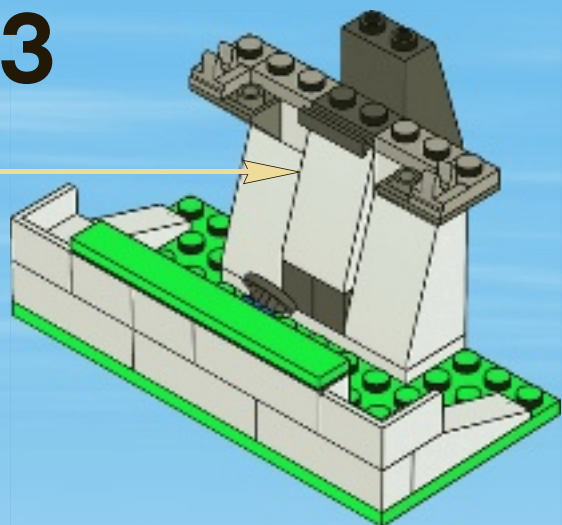

14

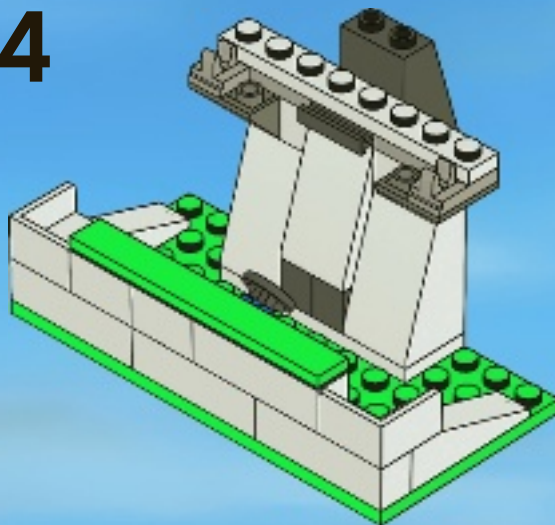

15

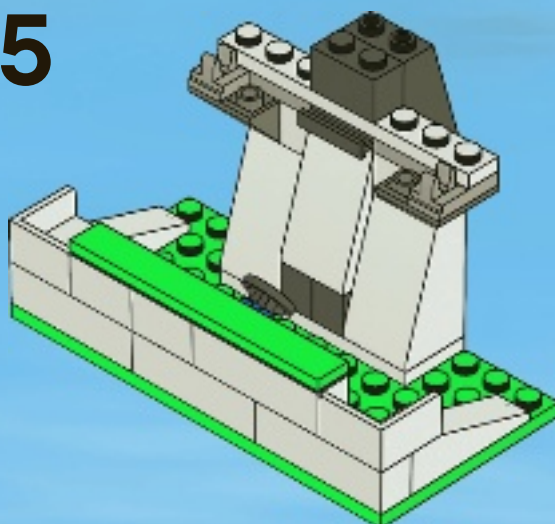

16

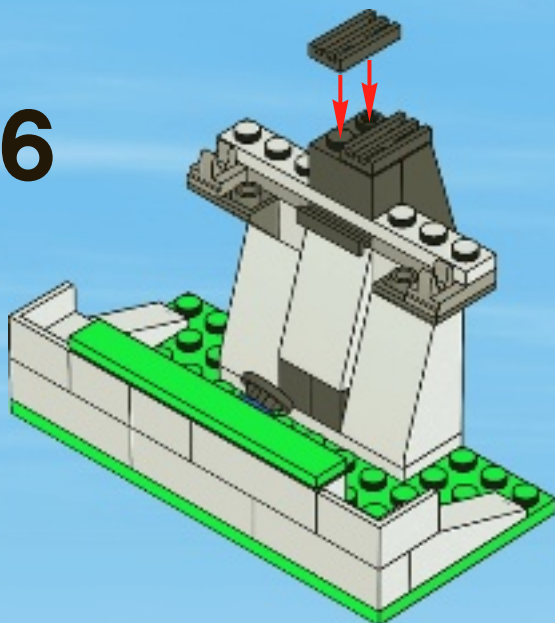

1

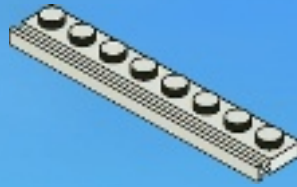

2

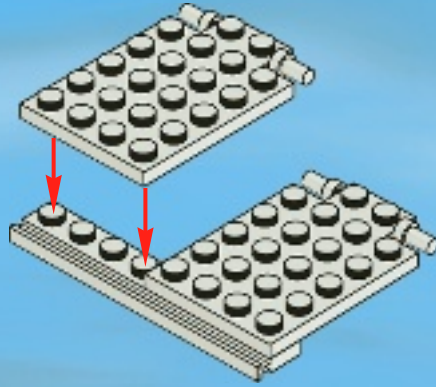

3



4

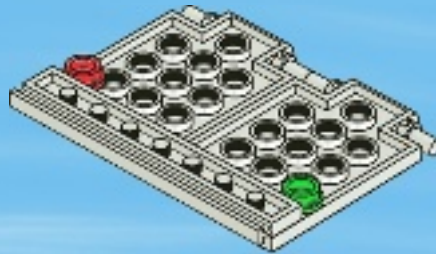

5

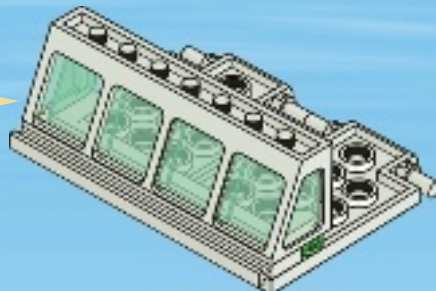
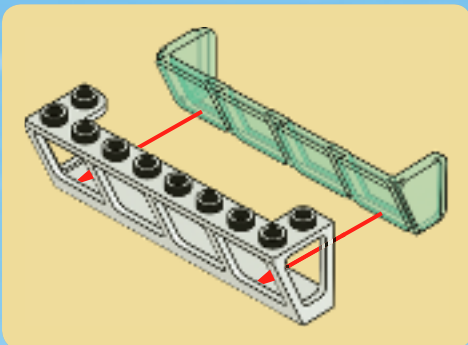



17

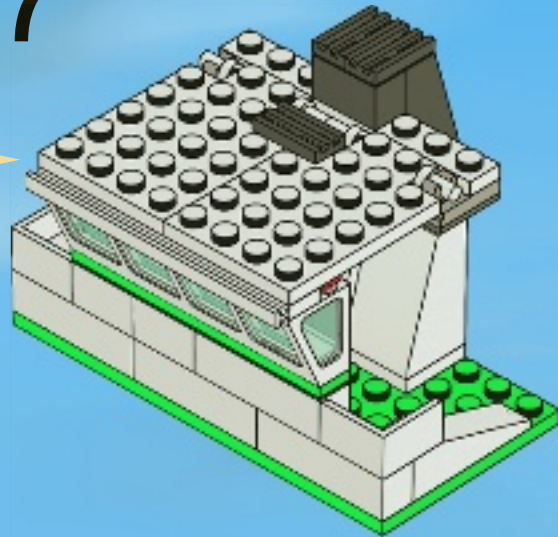

1



2



18

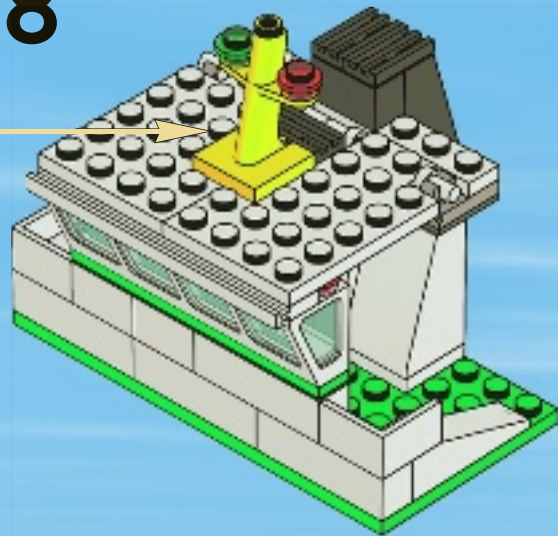

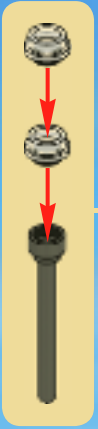

19

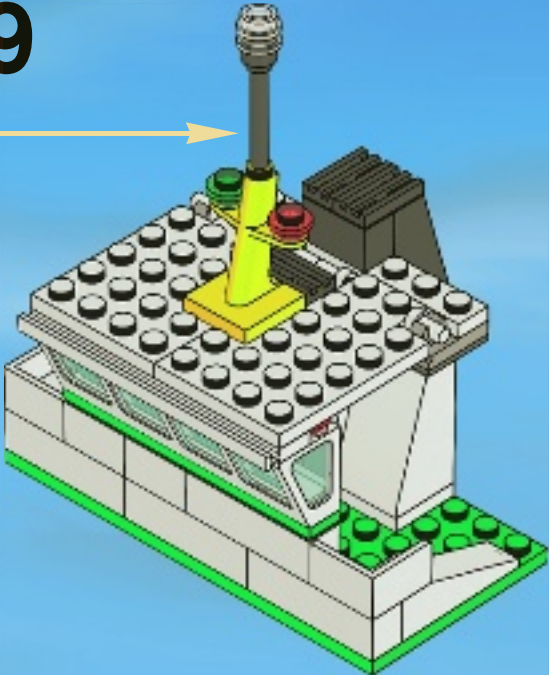

20

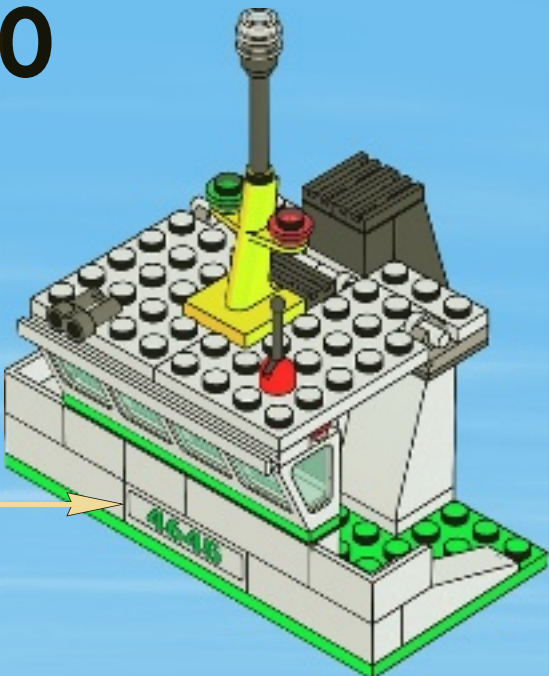

21

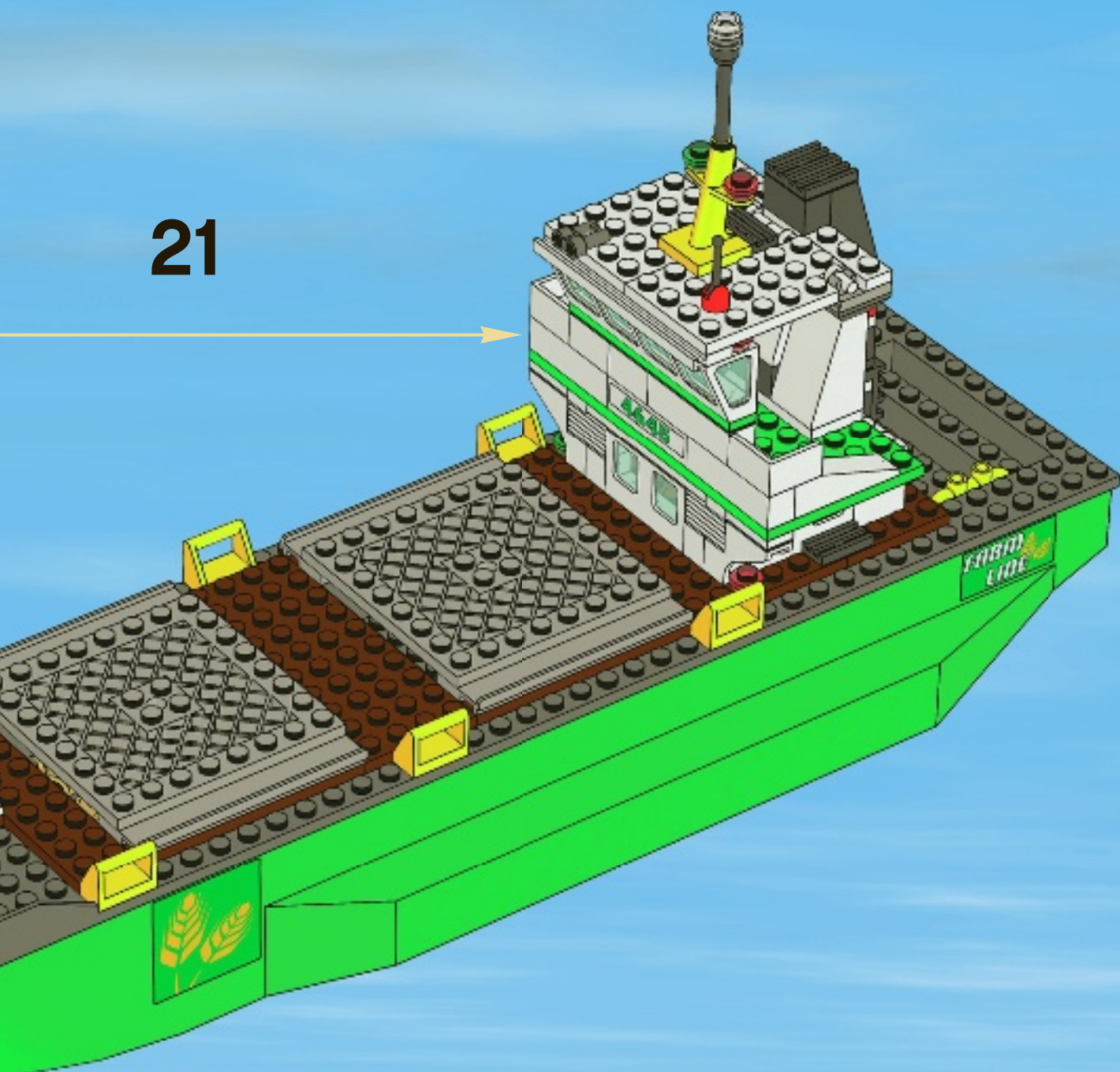



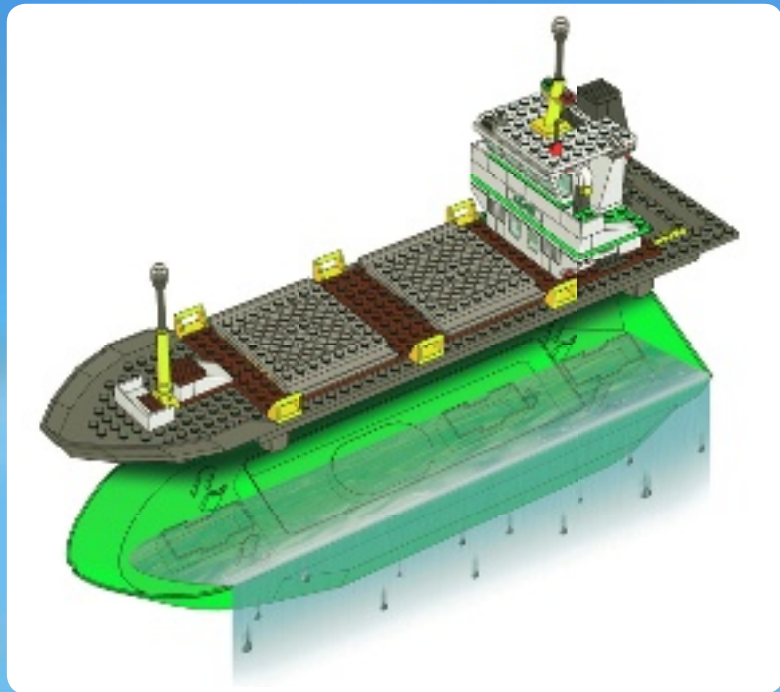

22

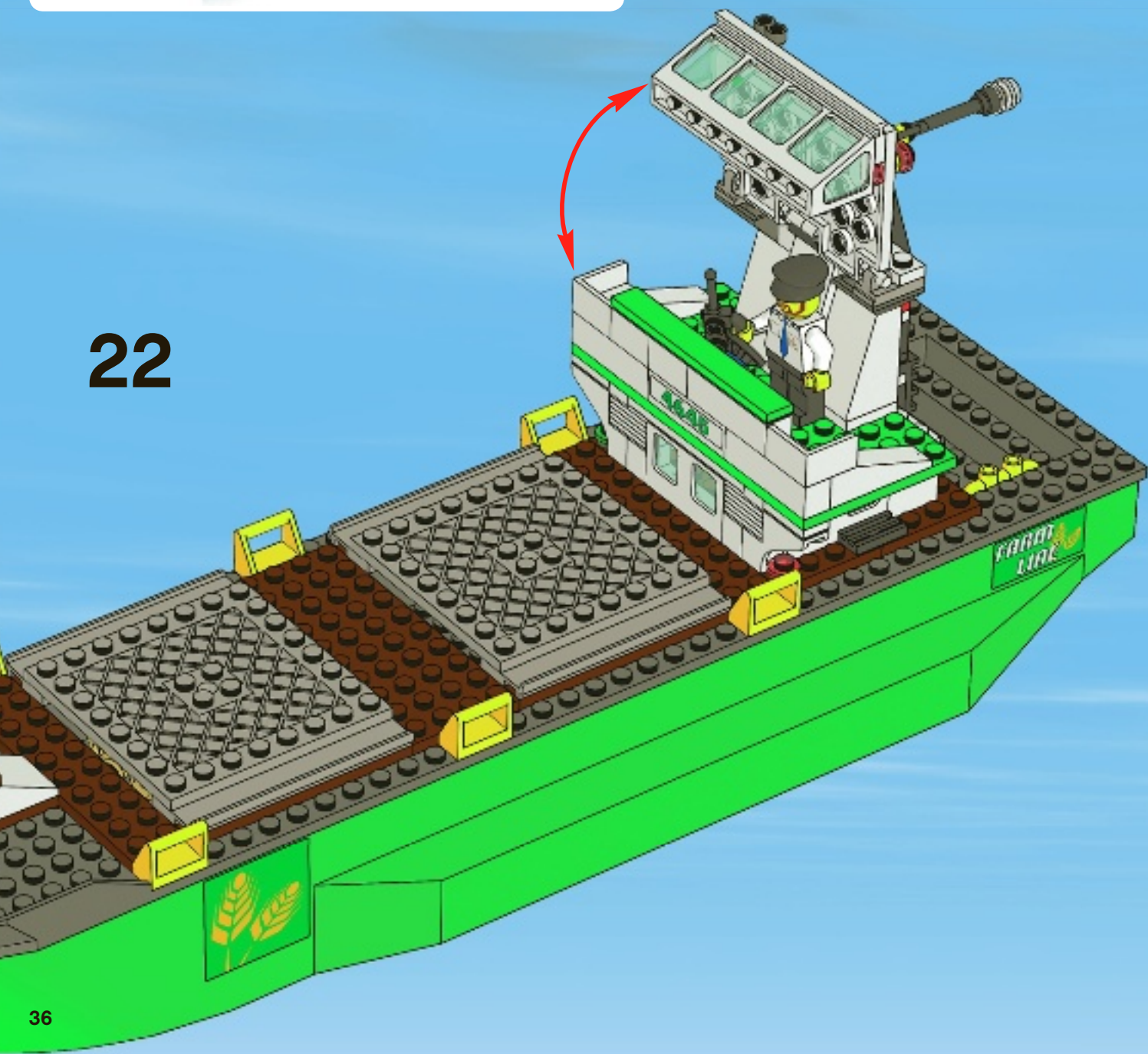







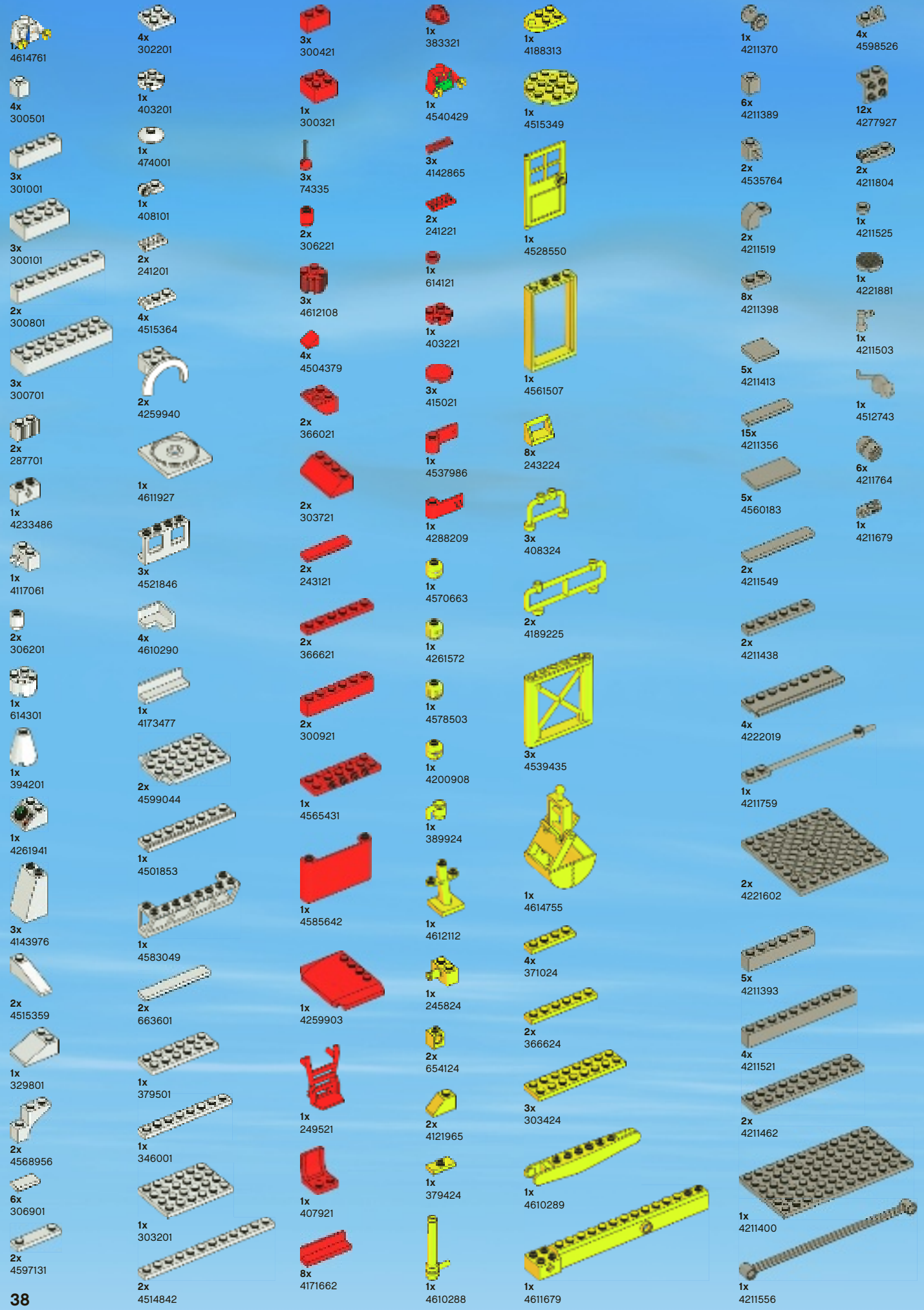

1x 4614761  
4x 300501  
3x 301001  
3x 300101  
2x 300801  
3x 300701  
2x 287701  
1x 4233486  
1x 4117061  
2x 306201  
1x 614301  
1x 394201  
1x 4261941  
3x 4143976  
2x 4515359  
1x 329801  
2x 4568956  
6x 306901  
2x 4597131

4x 302201  
1x 403201  
1x 474001  
1x 408101  
2x 241201  
4x 4515364  
2x 4259940  
1x 4611927  
3x 4521846  
4x 4610290  
1x 4173477  
2x 4599044  
1x 4501853  
1x 4583049  
2x 663601  
1x 379501  
1x 346001  
1x 303201  
2x 4514842

3x 300421  
1x 300321  
3x 74335  
2x 306221  
3x 4612108  
4x 4504379  
2x 366021  
2x 303721  
2x 243121  
2x 366621  
2x 300921  
1x 4565431  
1x 4585642  
1x 4259903  
1x 249521  
1x 407921  
8x 4171662

1x 383321  
1x 4540429  
3x 4142865  
2x 241221  
1x 614121  
1x 403221  
3x 415021  
1x 4537986  
1x 4288209  
1x 4570663  
1x 4261572  
1x 4578503  
1x 4200908  
1x 389924  
1x 4612112  
1x 245824  
2x 654124  
2x 4121965  
1x 379424  
1x 4610288

1x 4188313  
1x 4515349  
1x 4528550  
1x 4561507  
8x 243224  
3x 408324  
2x 4189225  
3x 4539435  
1x 4614755  
4x 371024  
2x 366624  
3x 303424  
1x 4610289  
1x 4611679

1x 4211370  
6x 4211389  
2x 4535764  
2x 4211519  
8x 4211398  
5x 4211413  
15x 4211356  
5x 4560183  
2x 4211549  
2x 4211438  
4x 4222019  
1x 4211759  
2x 4221602  
5x 4211393  
4x 4211521  
2x 4211462  
1x 4211400  
1x 4211556

4x 4598526  
12x 4277927  
2x 4211804  
1x 4211525  
1x 4221881  
1x 4211503  
1x 4512743  
6x 4211764  
1x 4211679  
1x 4211759  
2x 4221602  
5x 4211393  
4x 4211521  
2x 4211462  
1x 4211400  
1x 4211556



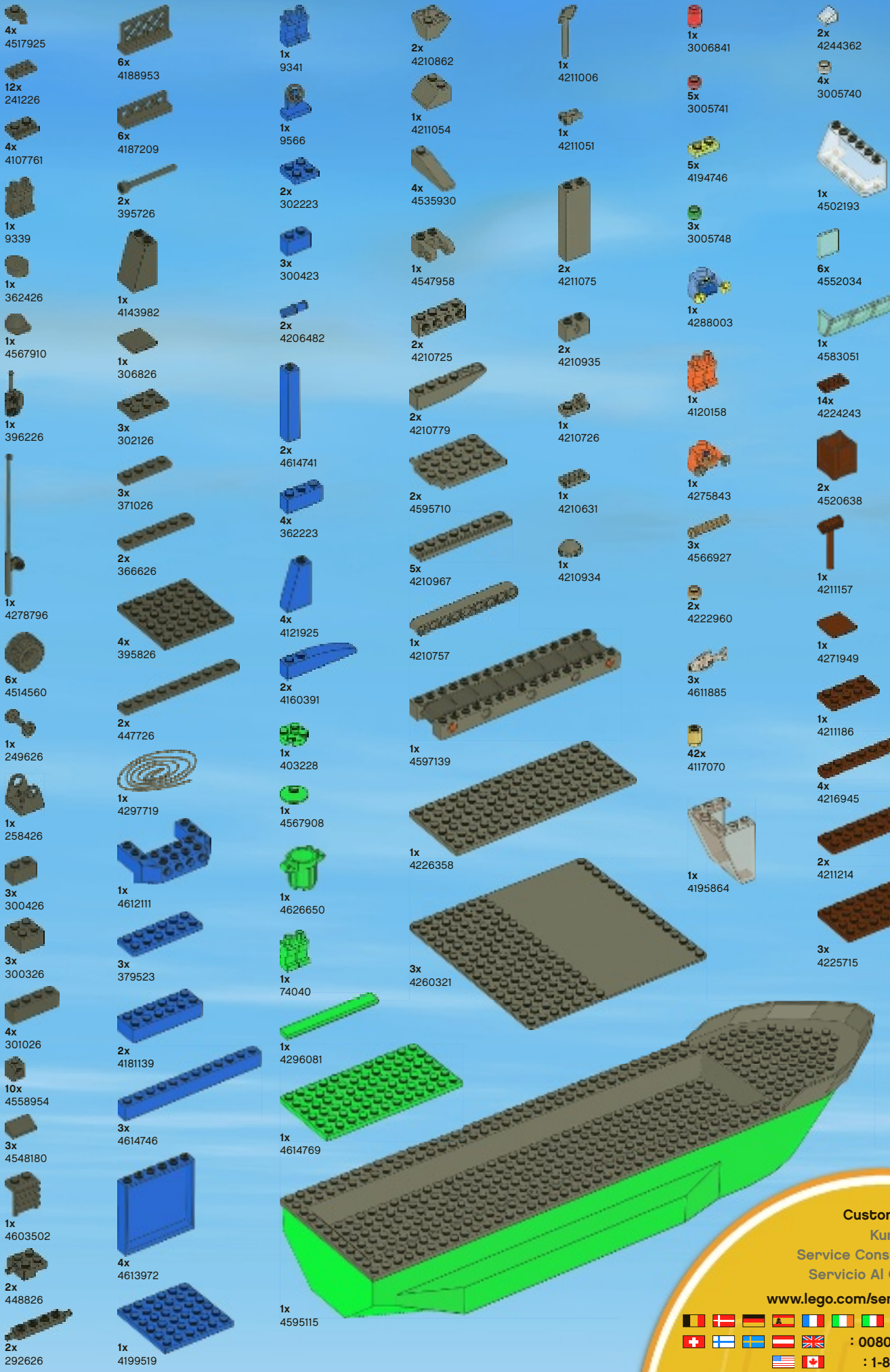

4x 4517925  
12x 241226  
4x 4107761  
1x 9339  
1x 362426  
1x 4567910  
1x 396226  
1x 4278796  
6x 4514560  
1x 249626  
1x 258426  
3x 300426  
3x 300326  
4x 301026  
10x 4558954  
3x 4548180  
1x 4603502  
2x 448826  
2x 292626

6x 4188953  
6x 4187209  
2x 395726  
1x 4143982  
1x 306826  
3x 302126  
3x 371026  
2x 366626  
4x 395826  
2x 447726  
1x 4297719  
1x 4612111  
3x 379523  
2x 4181139  
3x 4614746  
4x 4613972  
1x 4199519

1x 9341  
1x 9566  
2x 302223  
3x 300423  
2x 4206482  
2x 4614741  
4x 362223  
4x 4121925  
2x 4160391  
1x 403228  
1x 4567908  
1x 4626650  
1x 74040  
1x 4296081  
1x 4614769  
1x 4595115

2x 4210862  
1x 4211054  
4x 4535930  
1x 4547958  
2x 4210725  
2x 4210779  
2x 4595710  
5x 4210967  
1x 4210757  
1x 4597139  
1x 4226358  
3x 4260321

1x 4211006  
1x 4211051  
2x 4211075  
2x 4210935  
1x 4210726  
1x 4210631  
1x 4210934  
1x 4195864

1x 3006841  
5x 3005741  
5x 4194746  
3x 3005748  
1x 4288003  
1x 4120158  
1x 4275843  
3x 4566927  
2x 4222960  
3x 4611885  
42x 4117070  
1x 4195864

2x 4244362  
4x 3005740  
1x 4502193  
6x 4552034  
1x 4583051  
14x 4224243  
2x 4520638  
1x 4211157  
1x 4271949  
1x 4211186  
4x 4216945  
2x 4211214  
3x 4225715

Customer Service  
Kundenservice  
Service Consommateurs  
Servicio Al Consumidor

[www.lego.com/service](http://www.lego.com/service) or dial



: 00800 5346 5555  
: 1-800-422-5346

# WIN!

Go to [www.LEGOsurvey.com/product](http://www.LEGOsurvey.com/product) to fill out a survey for a chance to win a cool LEGO® Product. No purchase necessary. Open to all residents where not prohibited.



## [www.LEGOsurvey.com/product](http://www.LEGOsurvey.com/product)

### GEWINNE!

Nimm an der Umfrage auf [www.LEGOsurvey.com/product](http://www.LEGOsurvey.com/product) teil und hab die Chance ein cooles LEGO® Produkt zu gewinnen!

Die Teilnahme am Gewinnspiel führt zu keinerlei Kaufverpflichtungen. Teilnahme in allen nicht ausgeschlossenen Ländern möglich.

### WIN!

Ga naar [www.LEGOsurvey.com/product](http://www.LEGOsurvey.com/product), vul een enquêteformulier in en maak kans op een cool LEGO® product.

Geen aankoopverplichting, iedereen mag deelnemen, uitgezonderd ingezetenden van landen waar een enquêteverbod geldt.

### GAGNE !

Visite [www.LEGOsurvey.com/product](http://www.LEGOsurvey.com/product) pour répondre à un questionnaire et avoir une chance de gagner un produit LEGO® très cool !

Aucune obligation d'achat. Ouvert à tous les résidents des pays autorisés.

### 当てよう!

[www.LEGOsurvey.com/product](http://www.LEGOsurvey.com/product) にアクセスして、アンケートにご記入ください。当選者にはレゴ®製品を差し上げます。

お買い上げの必要はありません。禁止されていない限り、すべての皆様にご利用いただけます。