



# CITY

4644



1

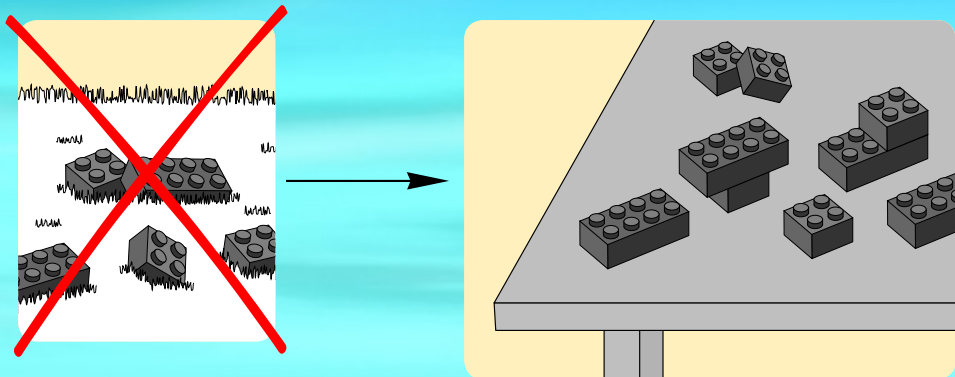

2

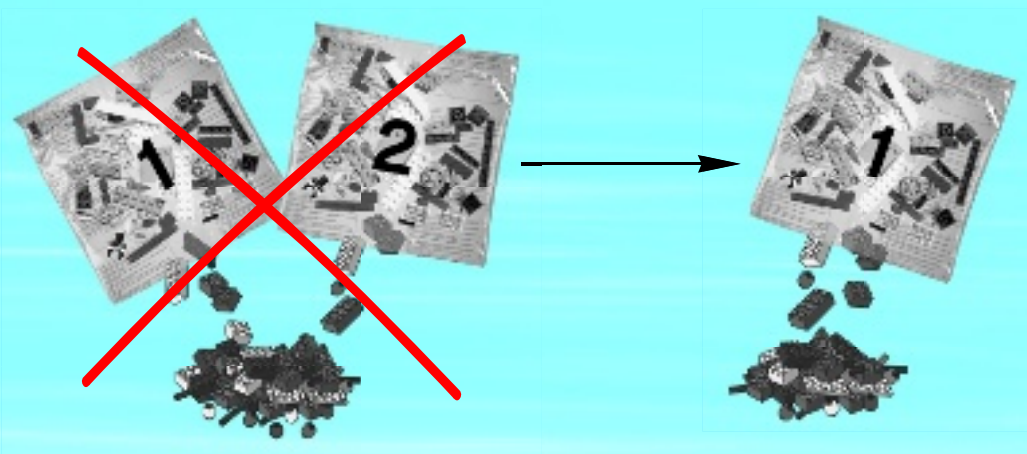

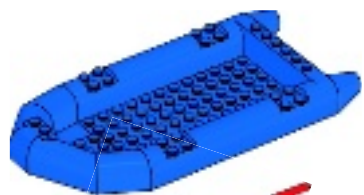

+



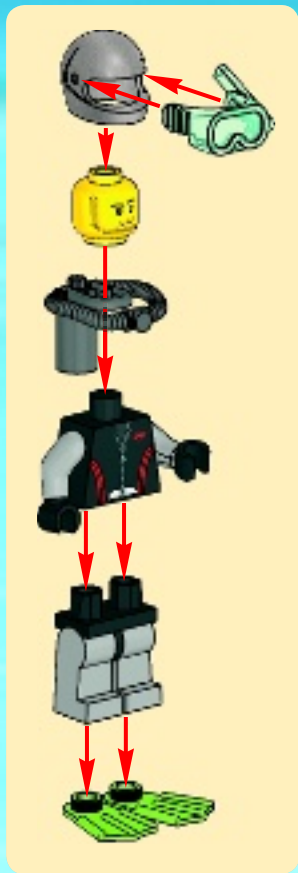

1



2

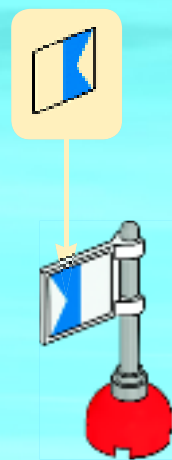

**1**

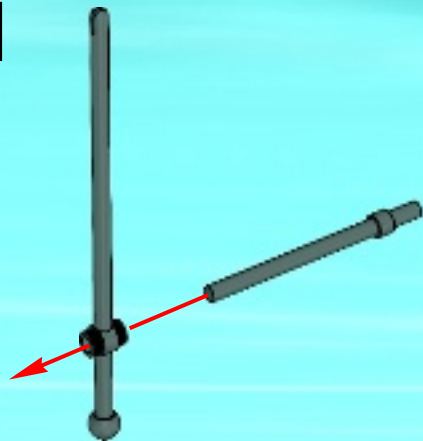

**2**



**3**

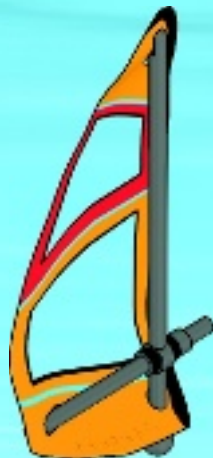

4



5





1

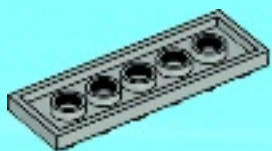

2





3

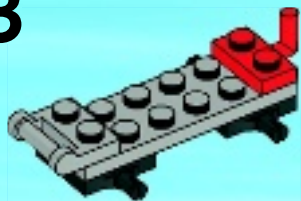

4



5

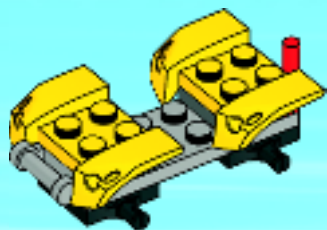

6



7

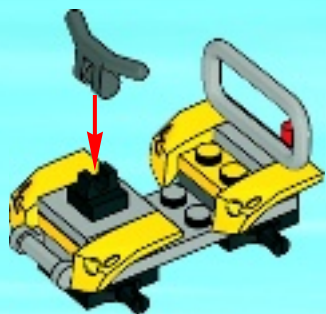

8





**1**

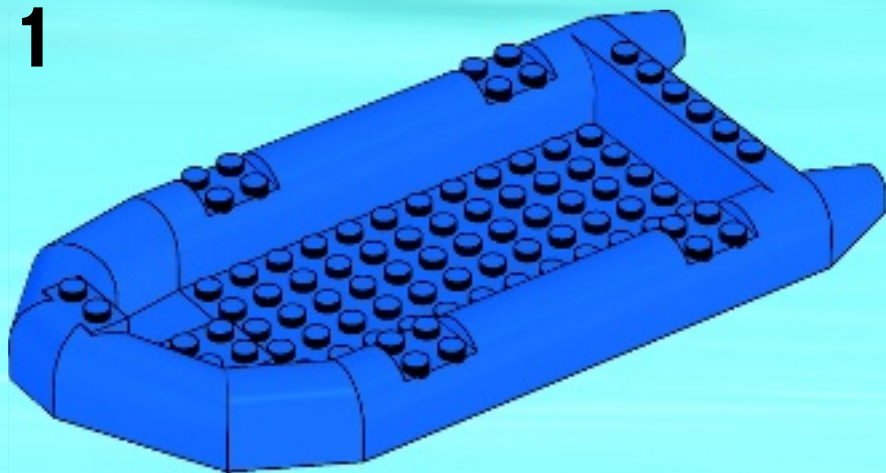

2

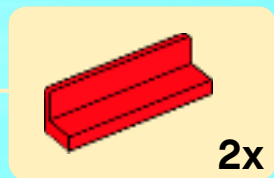
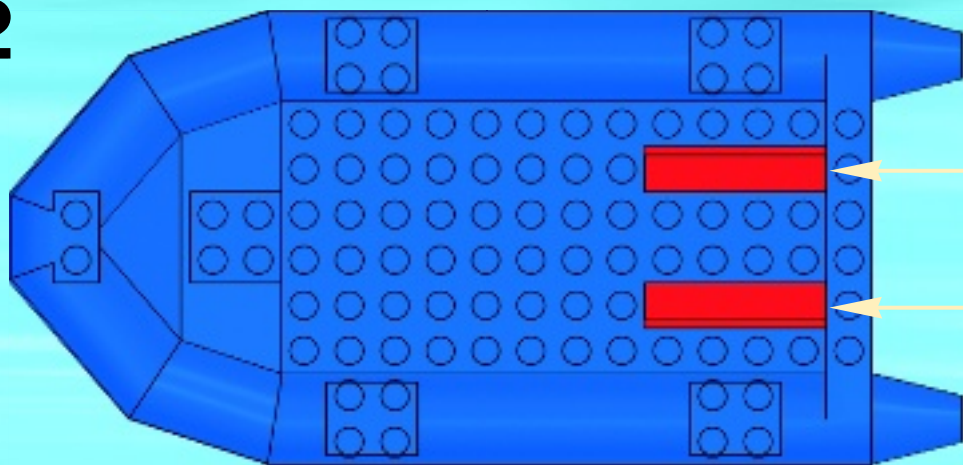

3



4

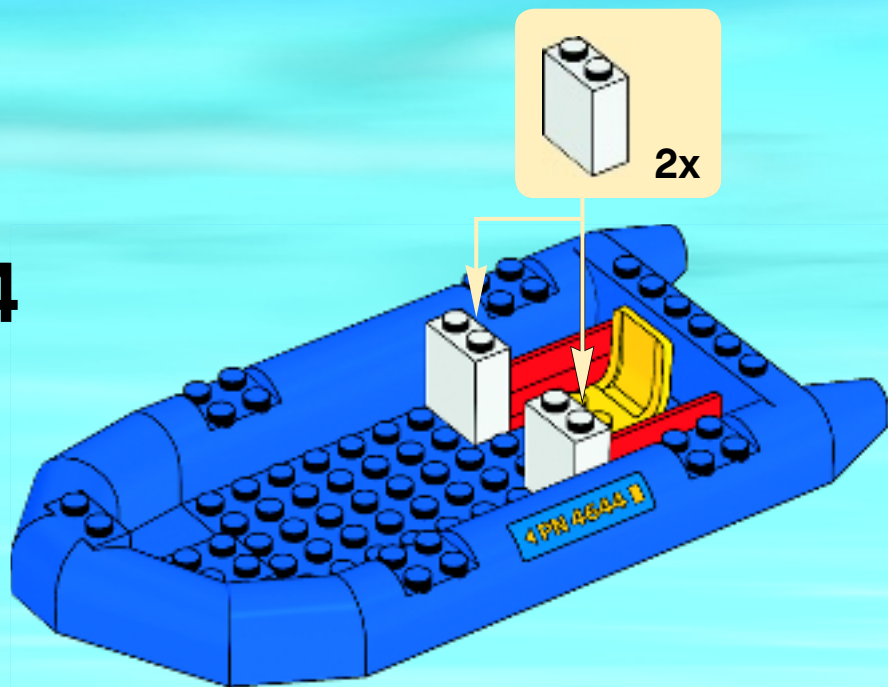

1

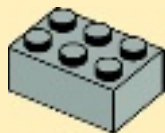

2



3



5

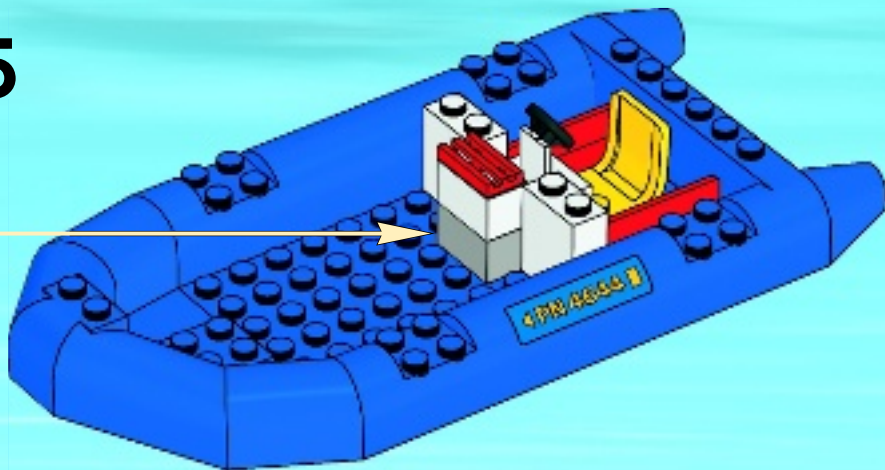



6

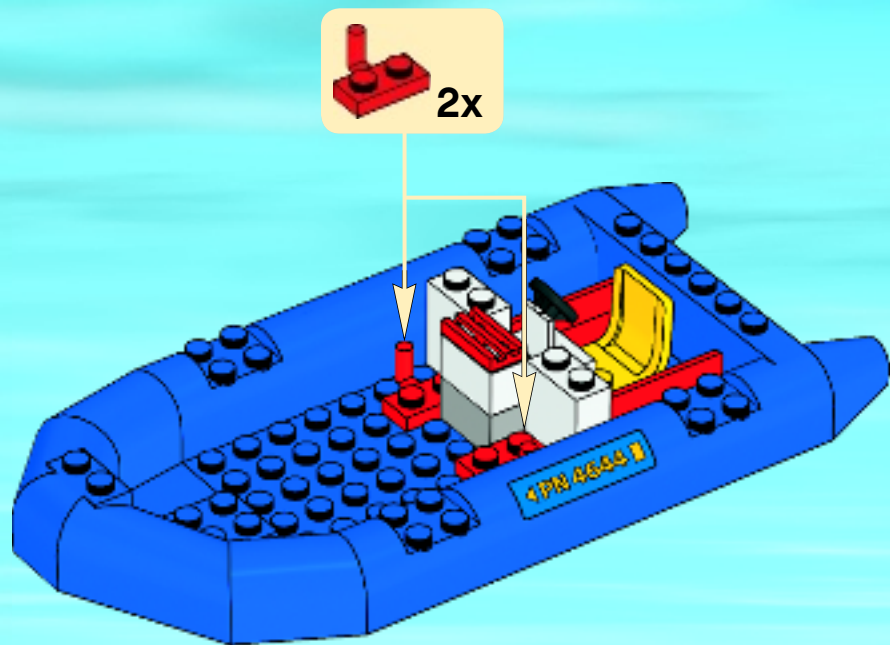

7

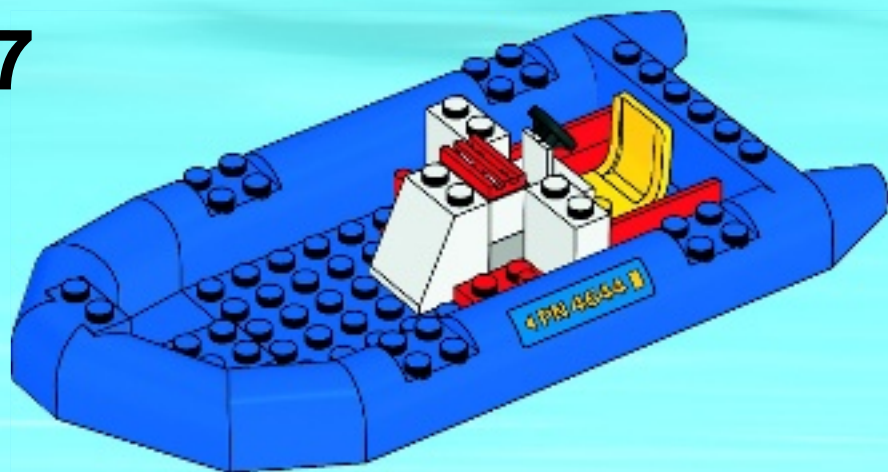

8

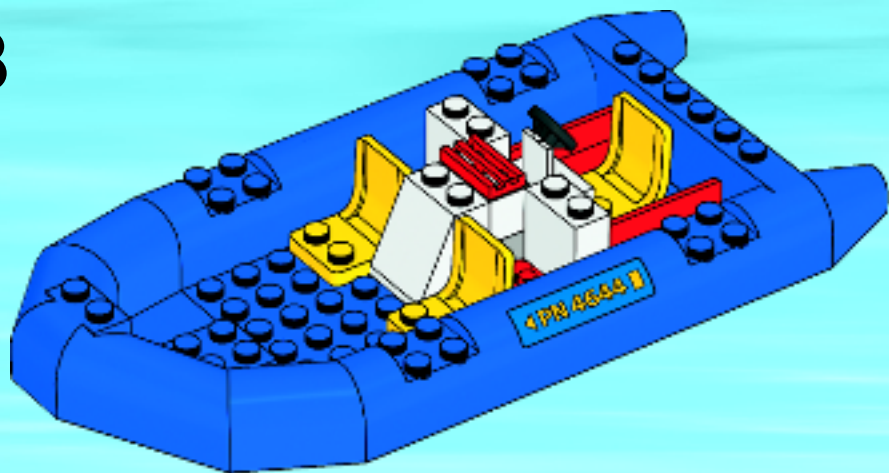

9

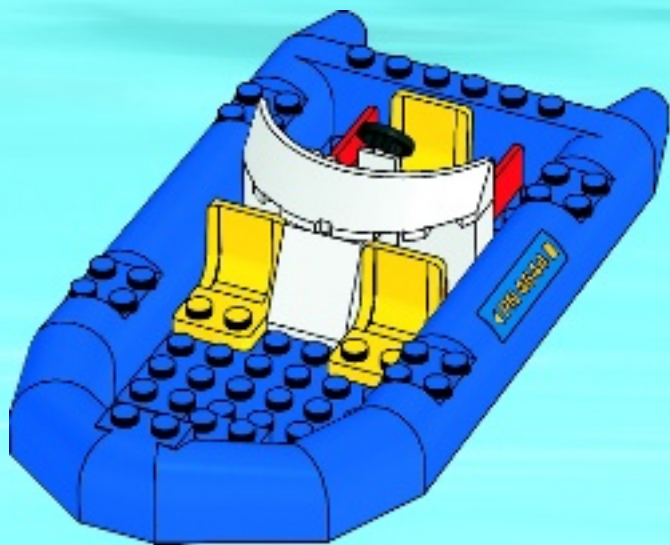

10

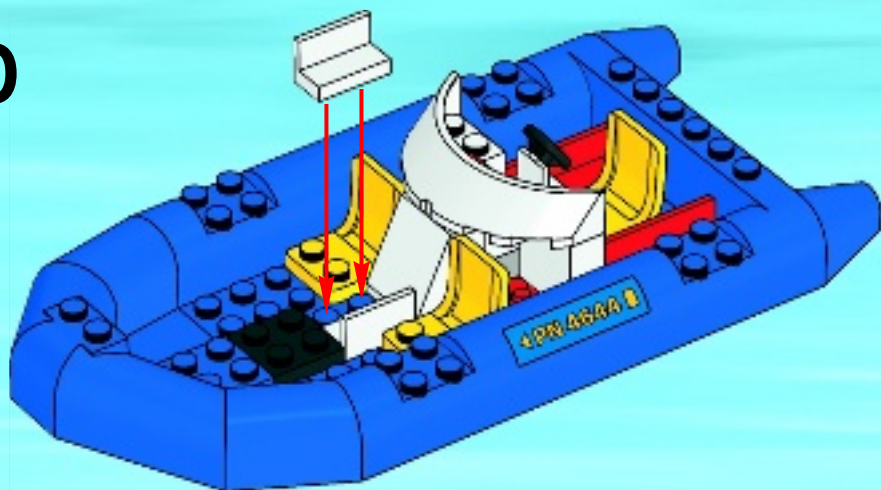

11

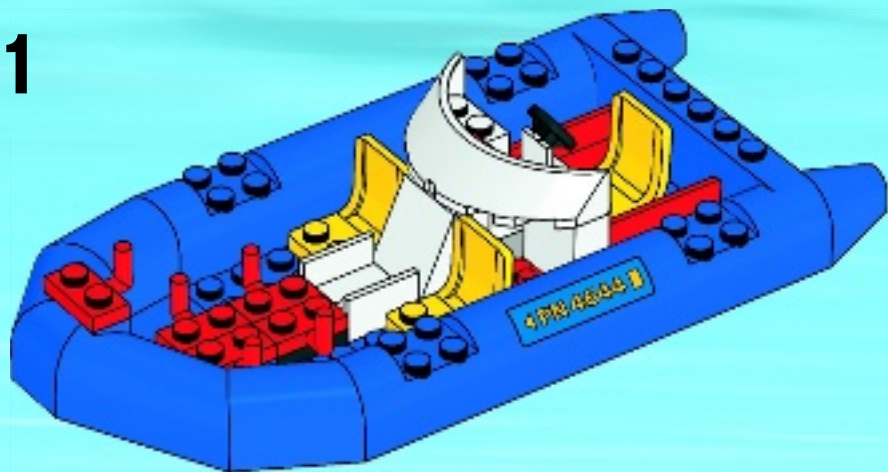

12

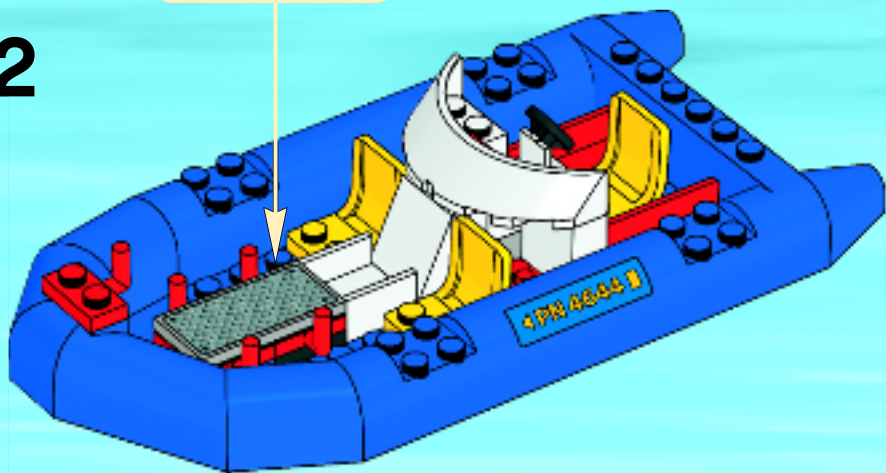
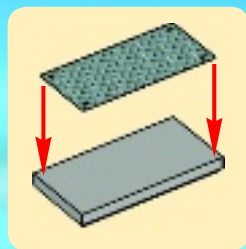

13

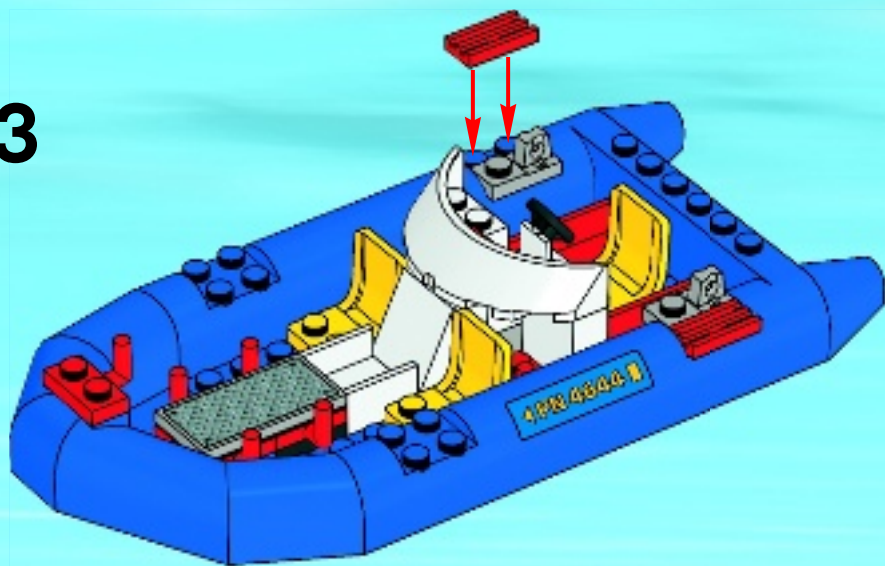



14

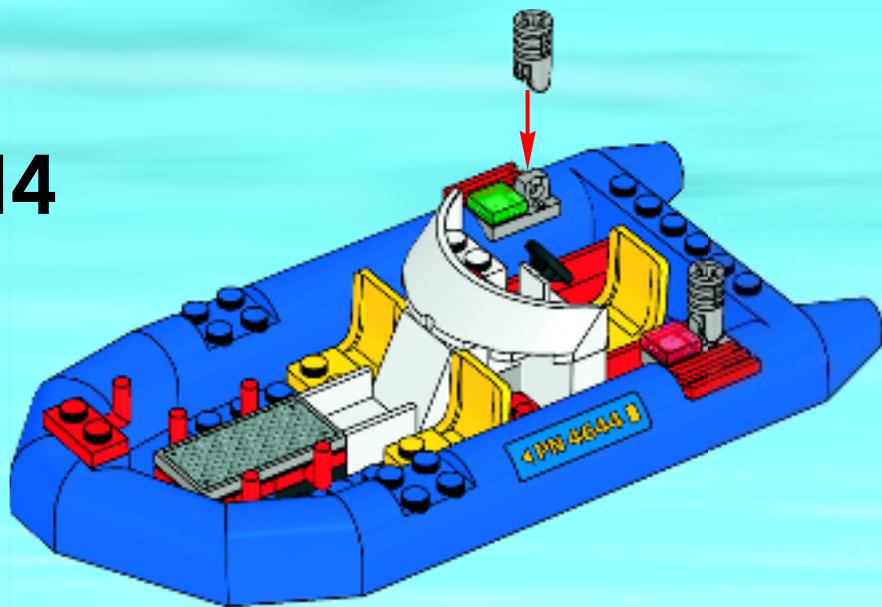

15

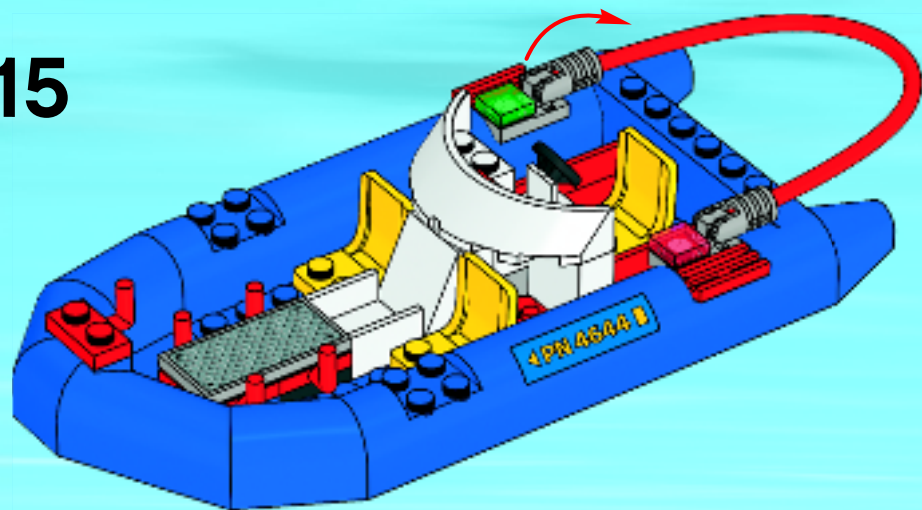

16

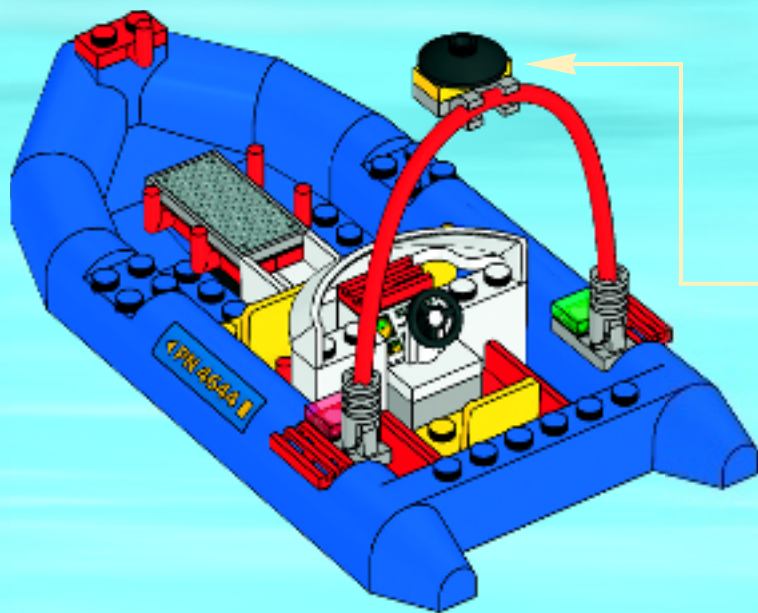

1

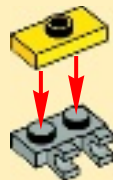

2



# 17

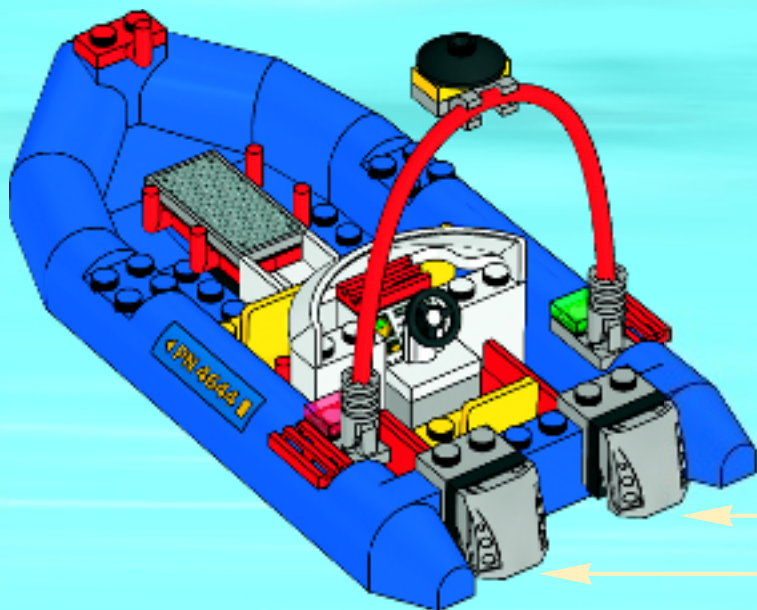

1



2

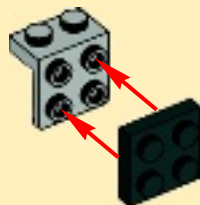

3



2x

18

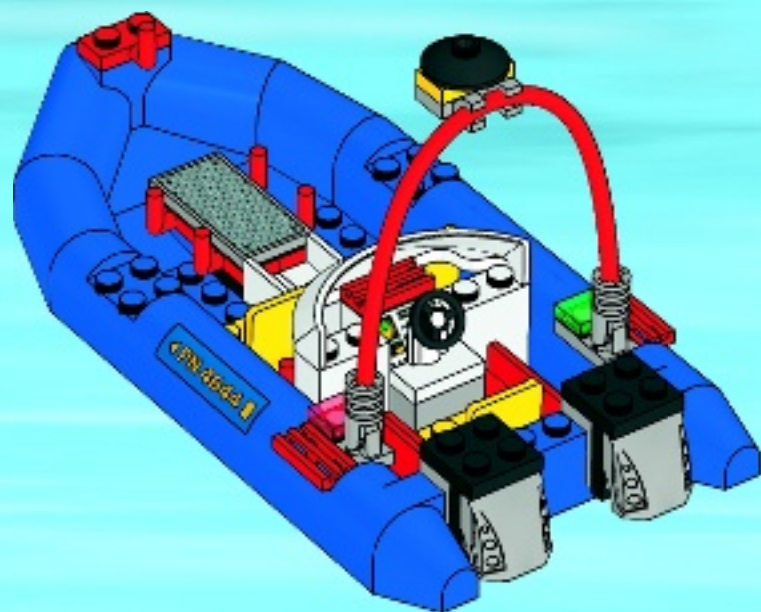

19

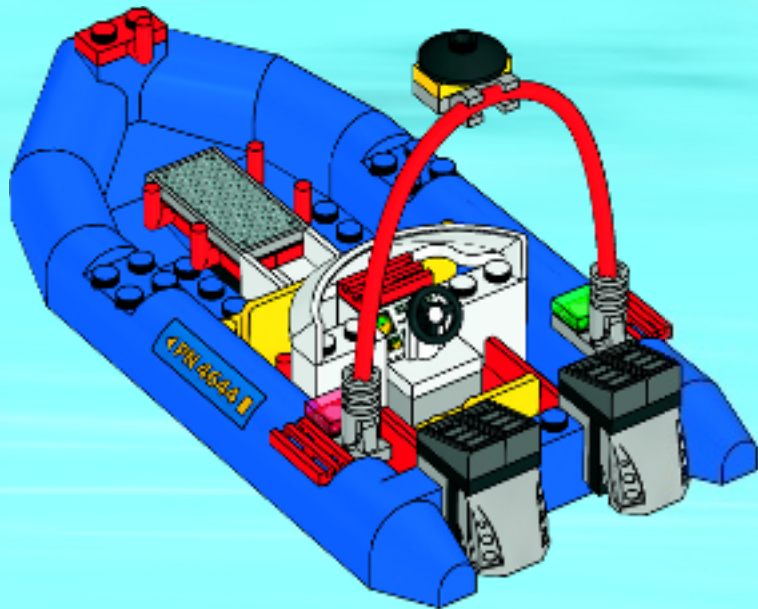

20

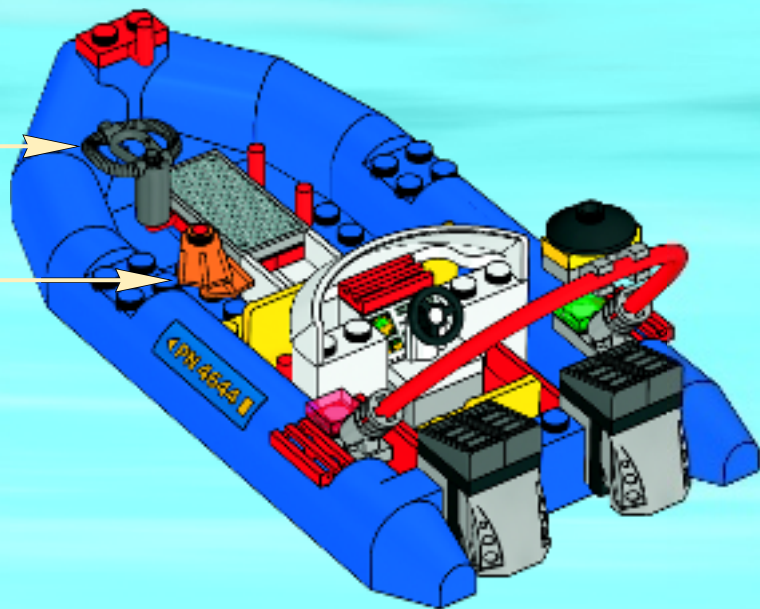

21

