



4441

CITY



**WARNING:** CHOKING HAZARD.  
Toy contains small parts and a small ball.  
Not for children under 3 years.

1

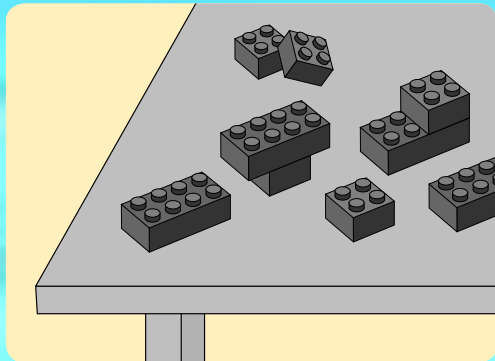
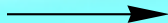
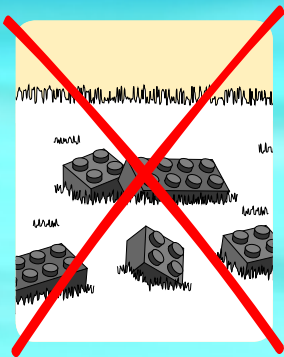

2



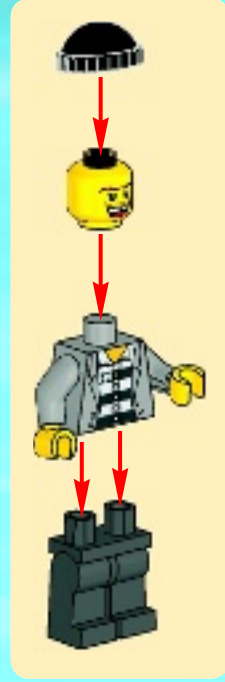
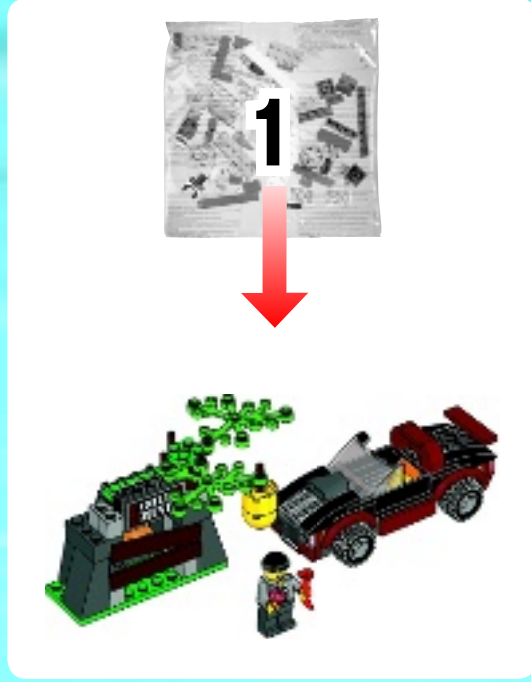

**AVERTISSEMENT** : RISQUE D'ÉTOUFFEMENT.  
Le jouet contient des petites pièces ainsi qu'une petite boule.  
Il ne convient pas aux enfants de moins de 3 ans.



**ADVERTENCIA**: PELIGRO DE ASFIXIA.  
Juguete que contiene partes pequeñas y una pelota pequeña.  
No recomendado para niños menores de 3 años.

1

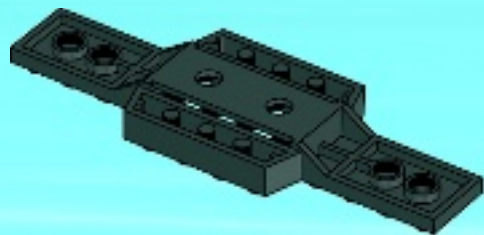

2

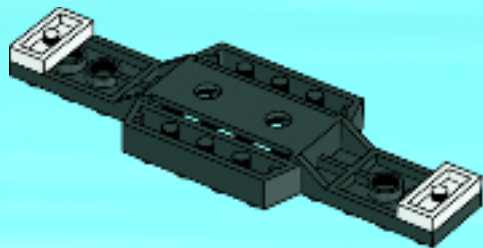

3

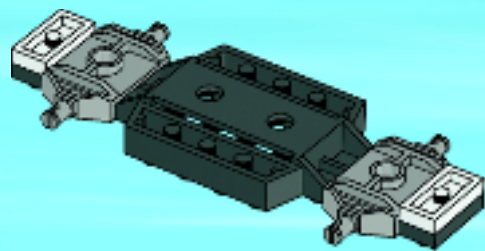

4



5



6

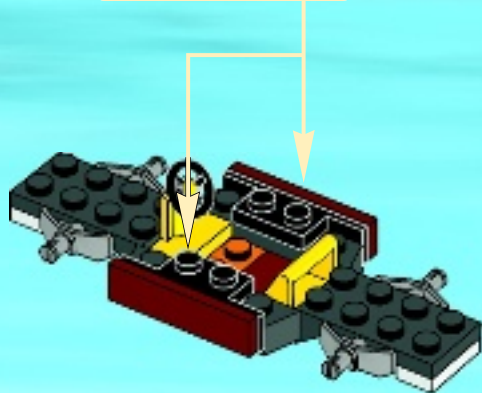
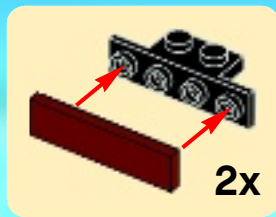

7



8

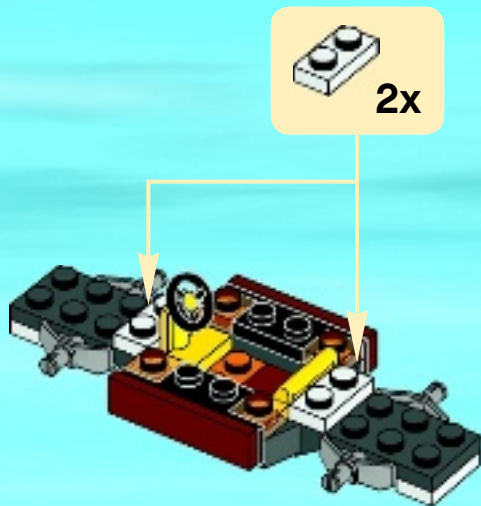

9



10





11

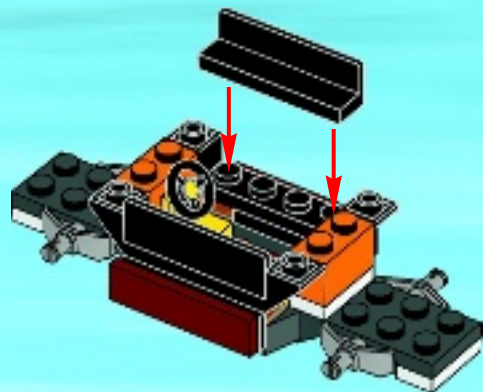

12

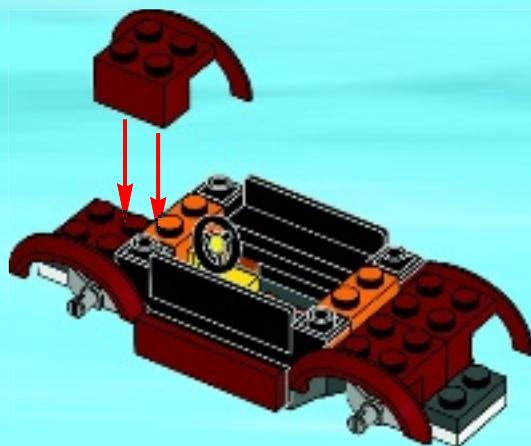

13

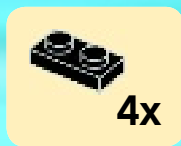

14

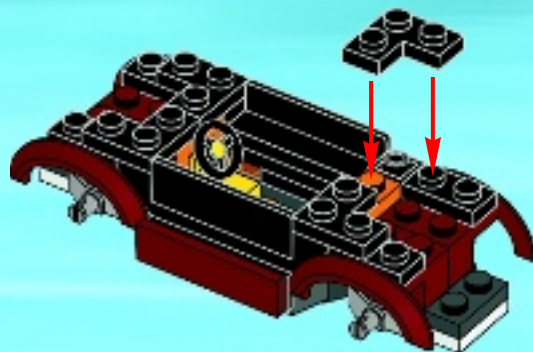

1

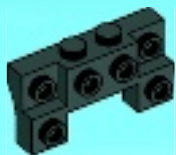

2



3



4

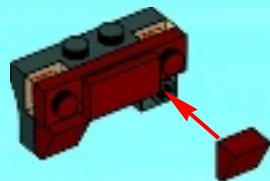

5



15



16



17

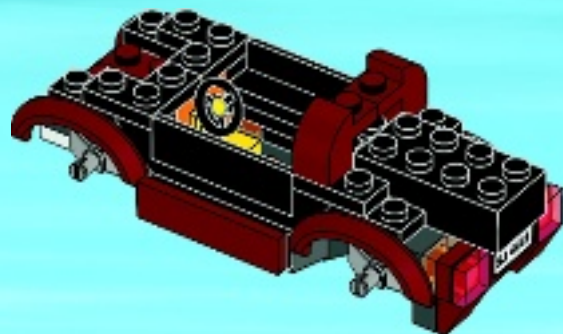

18

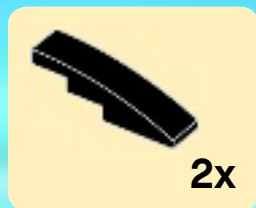
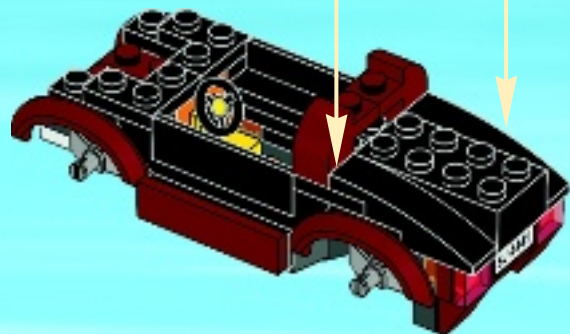

19



1



2



3



4

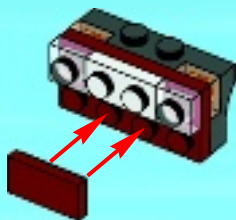



5

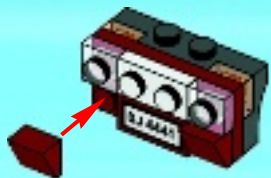

6



20

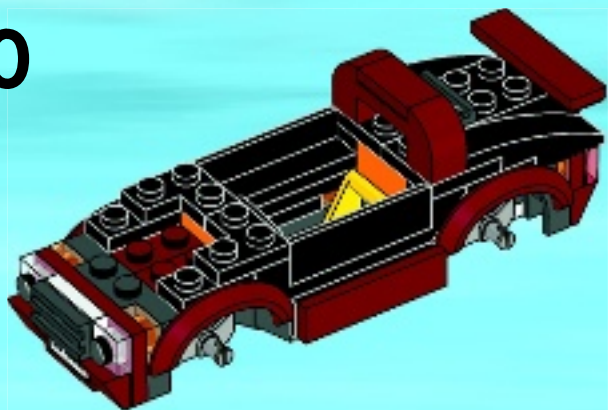

21

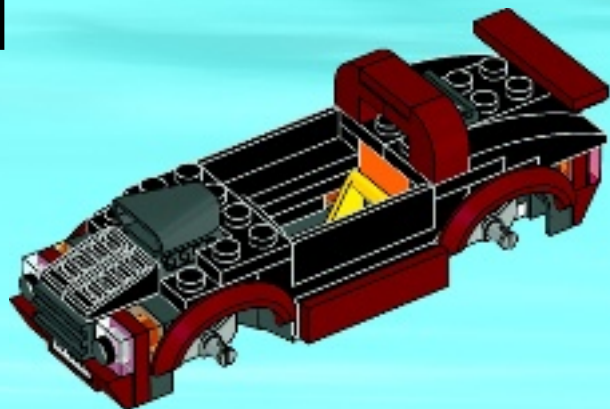

22

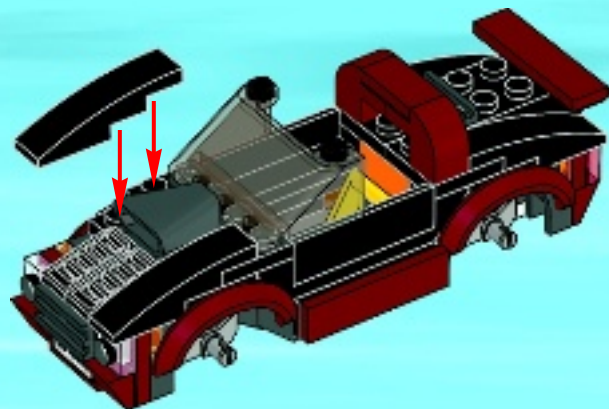

23

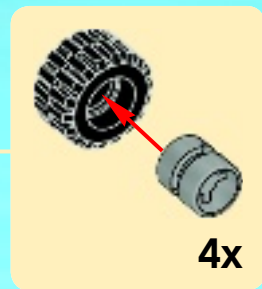
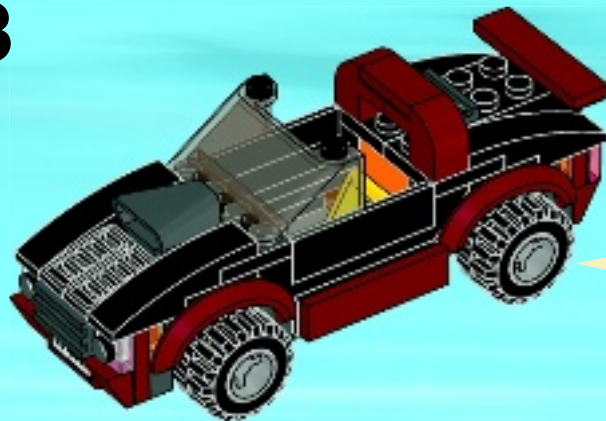



1

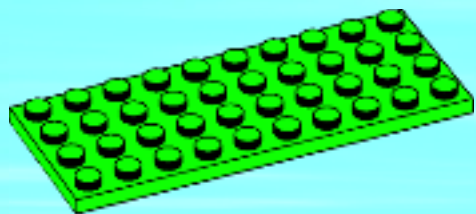

2

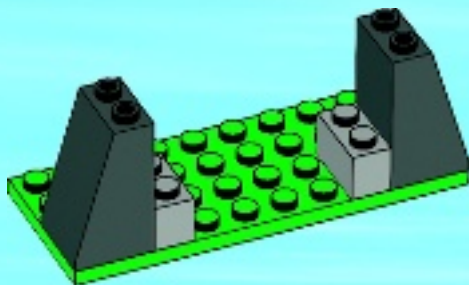

3

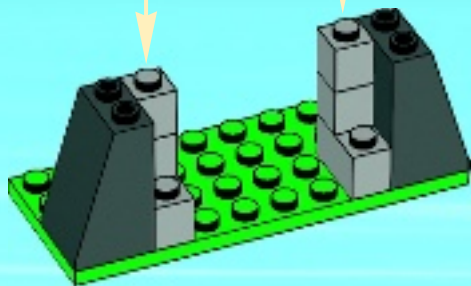
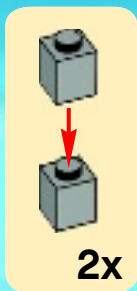

4

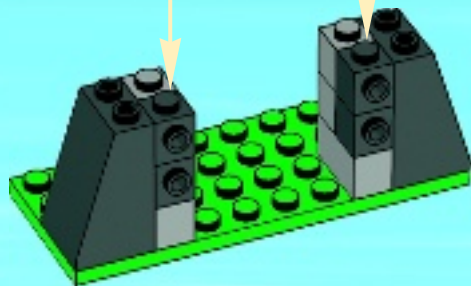
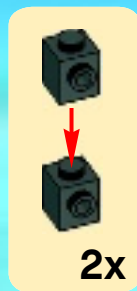

5

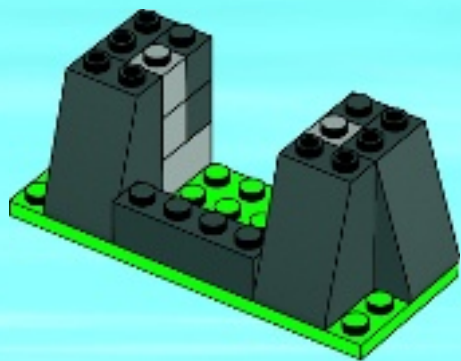

6

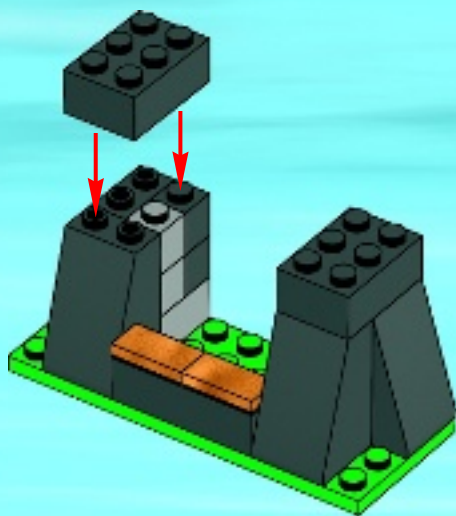

7

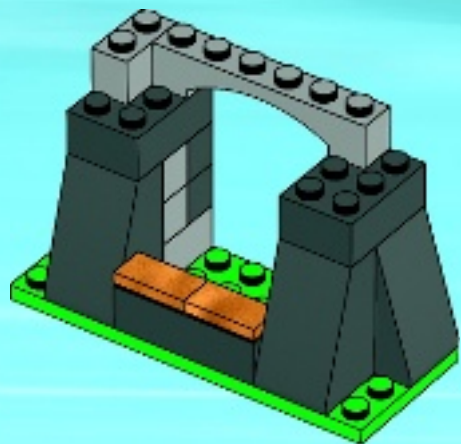

8

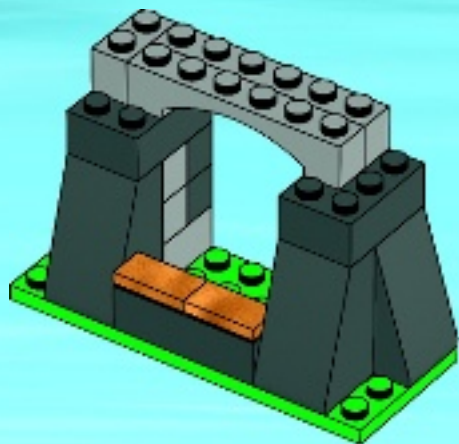



9

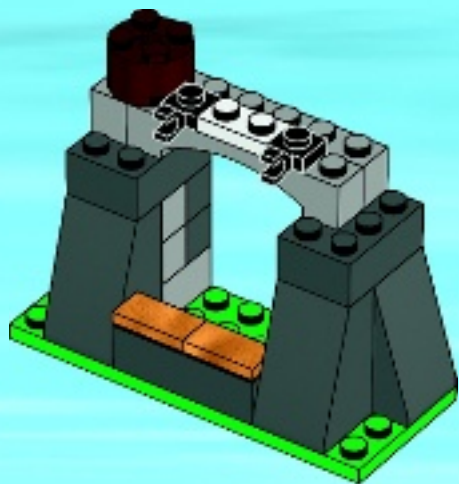

10

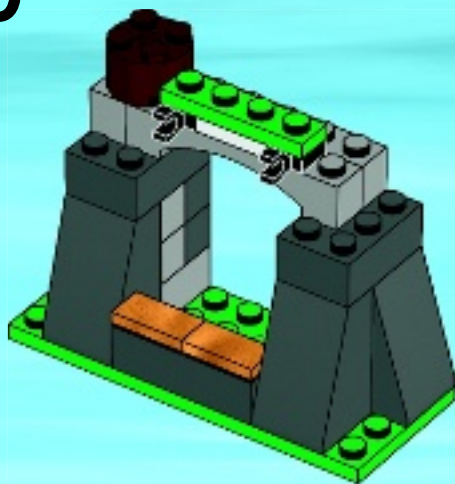

11

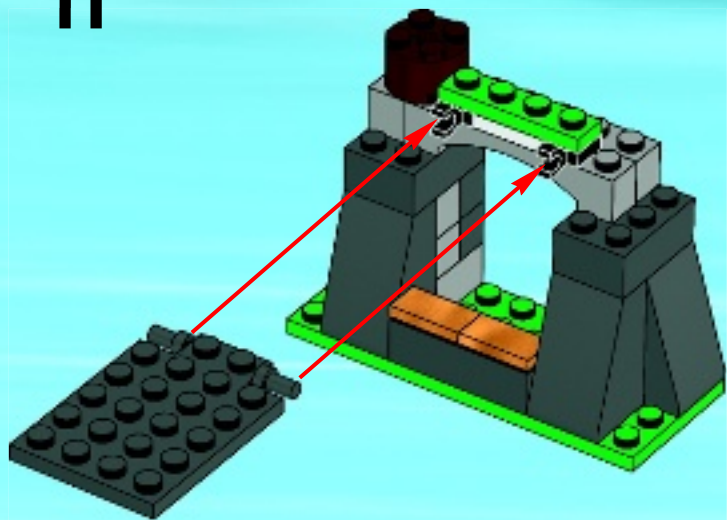

12

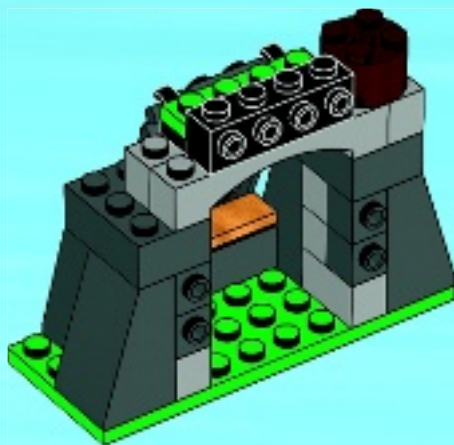

13

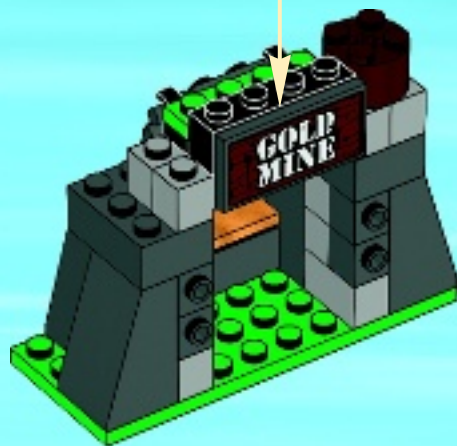

14

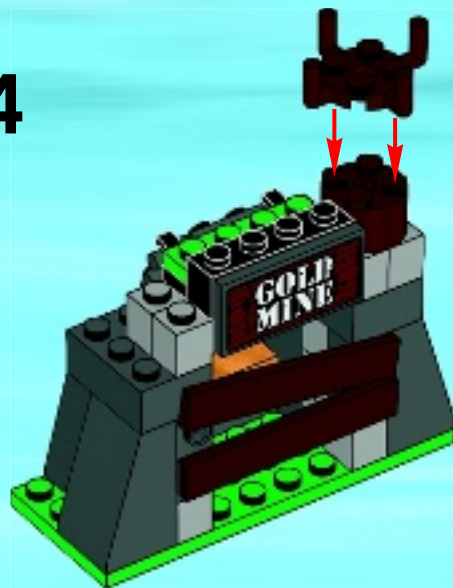

15



16

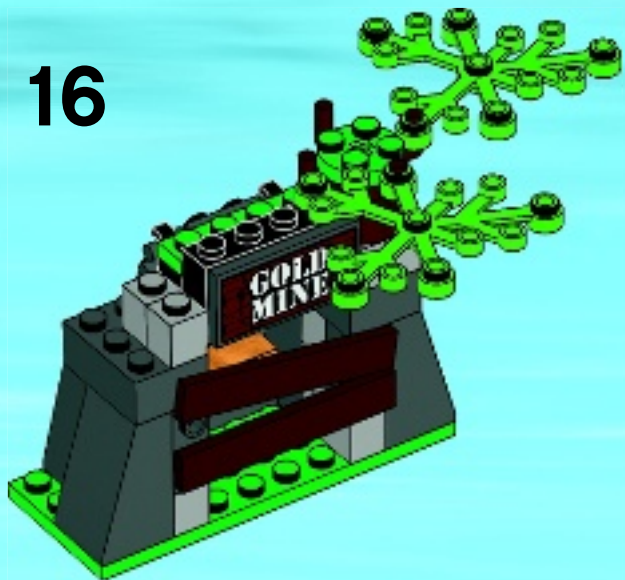

17

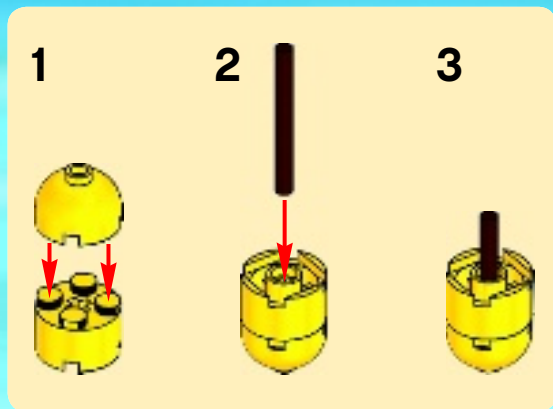

18



**LEGO** CITY



4440



4439



4441



4437



4436



CITY



4209



4208



4427





www.LEGOclub.com



LEGO Club Email

**LEGO club**

**FREE! GRATIS! GRATUIT!**



LEGO Club Magazine

**SIGN UP ONLINE!**

**www.LEGOclub.com**



**00800 5346 5555\***



































































**1-866-534-6258 • 1-877-518-5346**

US & Canada only

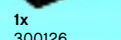
Canada seulement

- \* Freephone. Mobile charges may apply.
- \* Numéro sans frais. Des frais peuvent s'appliquer avec les téléphones cellulaires.
- \* Gebührenfrei, Kosten für Anrufe aus Mobilfunknetzen können abweichen.
- \* Gratis telefoonnummer vanaf vaste lijn.
- \* Det er et gratis nummer, når du ringer fra fasttelefon.
- \* Det är gratis, när du ringer från en fast telefon.
- \* Numéro sans frais. Des frais peuvent s'appliquer avec les téléphones portables.

|   |  |  |  |  |   |  |  |
|---|--|--|--|--|---|--|--|
| <br>2x<br>4129836   | <br>2x<br>4260649   | <br>3x<br>4114084   | <br>1x<br>301023    | <br>1x<br>4259916   | <br>1x<br>4496442  | <br>1x<br>4157108   | <br>2x<br>4282746   |
| <br>6x<br>241201  | <br>1x<br>303701  | <br>4x<br>4114026 | <br>5x<br>300923  | <br>1x<br>4609076 | <br>4x<br>4552034 | <br>2x<br>4541191 | <br>2x<br>4228063 |
| <br>4x<br>4222017 | <br>2x<br>4558208 | <br>1x<br>4648681 | <br>5x<br>371023  | <br>2x<br>9553    | <br>1x<br>4599455 | <br>4x<br>302326  | <br>4x<br>448826  |
| <br>6x<br>302301  | <br>2x<br>458208  | <br>2x<br>4121936 | <br>1x<br>366623  | <br>1x<br>4164073 | <br>1x<br>4599455 | <br>2x<br>4517925 | <br>4x<br>4522034 |
| <br>2x<br>302101  | <br>1x<br>4530590 | <br>1x<br>4586547 | <br>1x<br>379523  | <br>1x<br>4216656 | <br>1x<br>403228  | <br>3x<br>241226  | <br>4x<br>4568644 |
| <br>1x<br>302001  | <br>1x<br>4587272 | <br>1x<br>4586544 | <br>1x<br>4199519 | <br>1x<br>614324  | <br>1x<br>371028  | <br>1x<br>300126  | <br>4x<br>4498340 |
| <br>4x<br>371001  | <br>1x<br>4261565 | <br>4x<br>300523  | <br>1x<br>4199519 | <br>1x<br>407924  | <br>2x<br>4129872 | <br>1x<br>4162443 | <br>2x<br>4121739 |
| <br>8x<br>366601  | <br>3x<br>243101  | <br>6x<br>300423  | <br>2x<br>4651869 | <br>1x<br>243224  | <br>1x<br>4223986 | <br>2x<br>4260862 | <br>1x<br>4159007 |
| <br>2x<br>4651885 | <br>1x<br>416201  |  |  |  |   |  |  |



**Customer Service**  
**Kundenservice**  
**Service Consommateurs**  
**Servicio Al Consumidor**

[www.lego.com/service](http://www.lego.com/service) or dial



: 00800 5346 5555  
 : 1-800-422-5346



# WIN!

Go to [www.LEGOsurvey.com/product](http://www.LEGOsurvey.com/product) to fill out a survey for a chance to win a cool LEGO® Product.

No purchase necessary.

Open to all residents where not prohibited.



## [www.LEGOsurvey.com/product](http://www.LEGOsurvey.com/product)

### GEWINNE!

Nimm an der Umfrage auf [www.LEGOsurvey.com/product](http://www.LEGOsurvey.com/product) teil und hab die Chance ein cooles LEGO® Produkt zu gewinnen!

Die Teilnahme am Gewinnspiel führt zu keinerlei Kaufverpflichtungen. Teilnahme in allen nicht ausgeschlossenen Ländern möglich.

### WIN!

Ga naar [www.LEGOsurvey.com/product](http://www.LEGOsurvey.com/product), vul een enquêteformulier in en maak kans op een cool LEGO® product.

Geen aankoopverplichting. Iedereen mag deelnemen, uitgezonderd ingezetenden van landen waar een enquêteverbod geldt.

### GAGNE!

Visite [www.LEGOsurvey.com/product](http://www.LEGOsurvey.com/product) pour répondre à un questionnaire et avoir une chance de gagner un produit LEGO® très cool!

Aucune obligation d'achat. Ouvert à tous les résidents des pays autorisés.

### 当てよう!

[www.LEGOsurvey.com/product](http://www.LEGOsurvey.com/product) にアクセスして、アンケートにご記入ください。当選者にはレゴ®製品を差し上げます。

お買い上げの必要はありません。禁止されていない限り、すべての皆様にご利用いただけます。



[www.LEGO.com](http://www.LEGO.com)

6013618

LEGO and the LEGO logo are trademarks of the/son des marques de commerce de/son marcas registradas de LEGO Group. ©2012 The LEGO Group.