



Friends™

41726





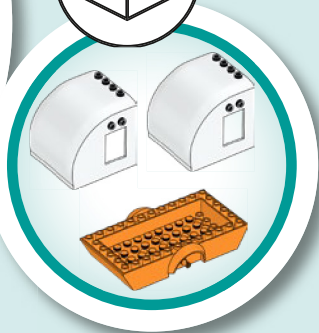



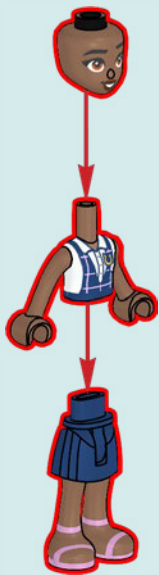

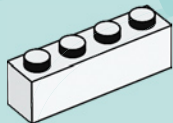
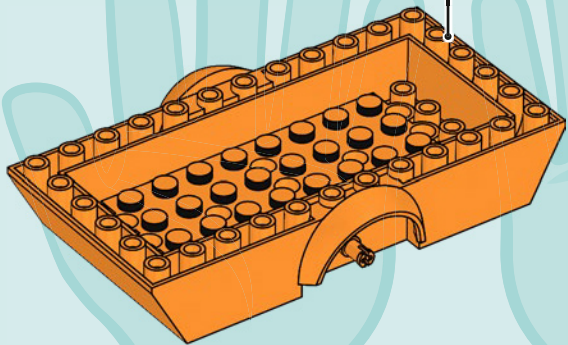
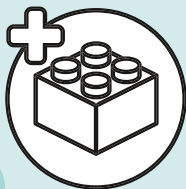

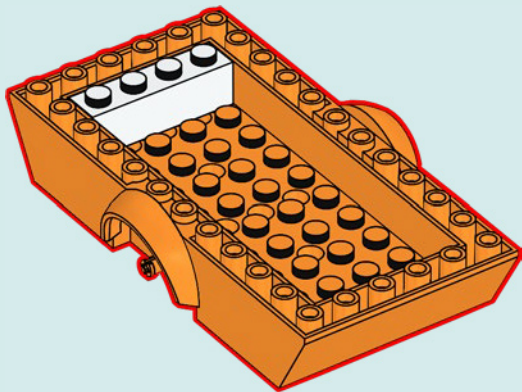

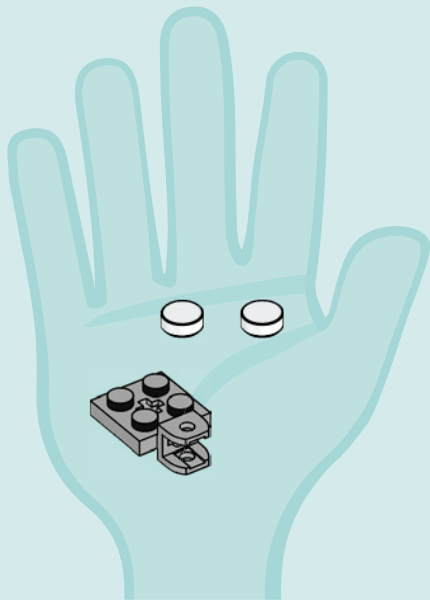

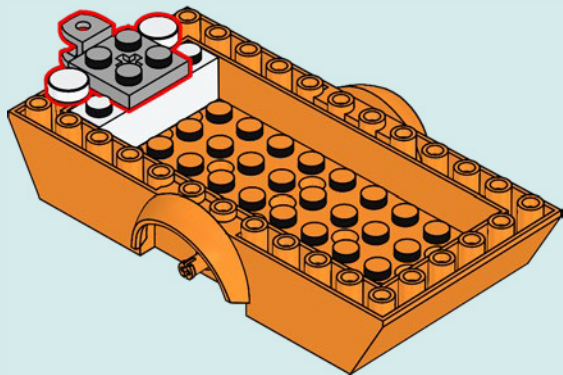

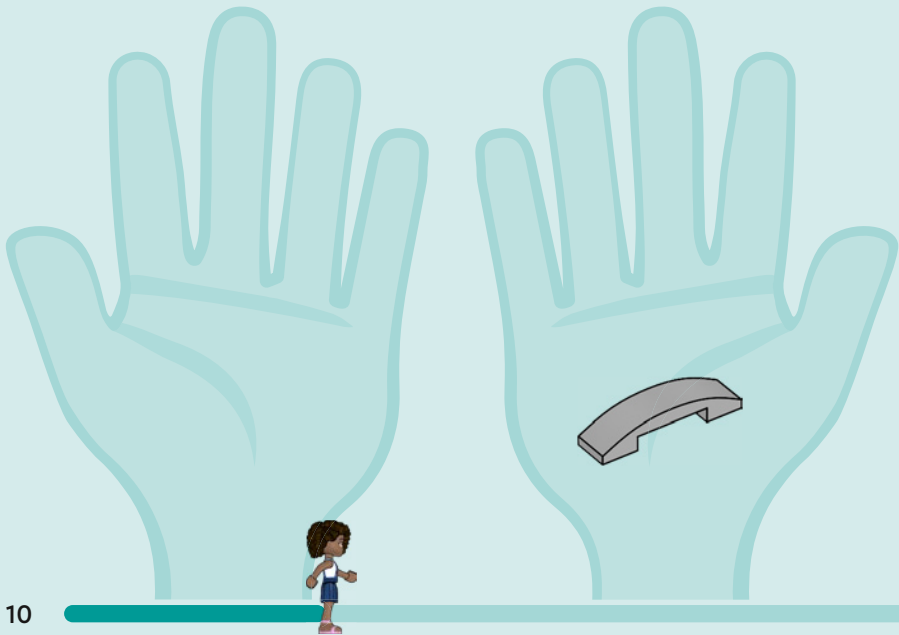

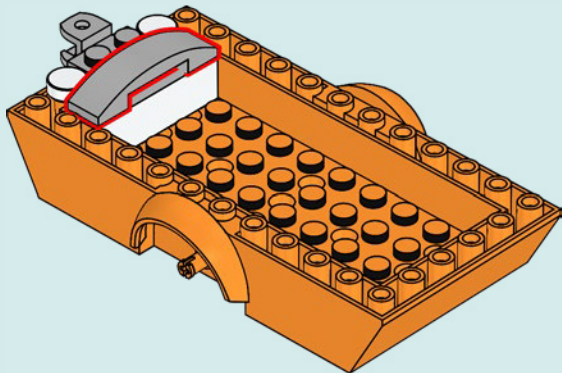

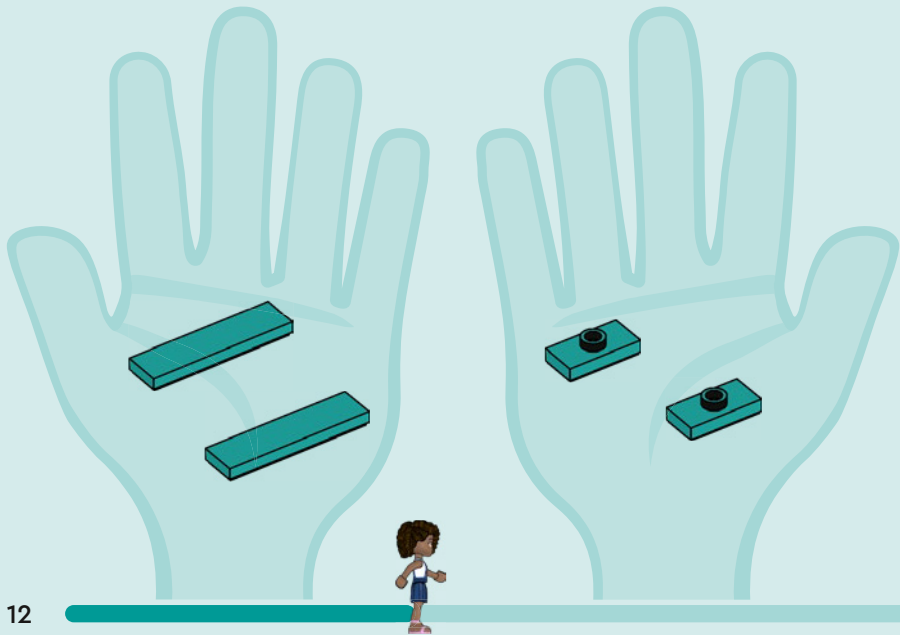

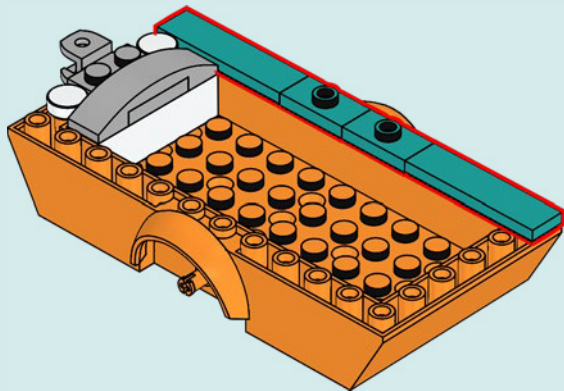

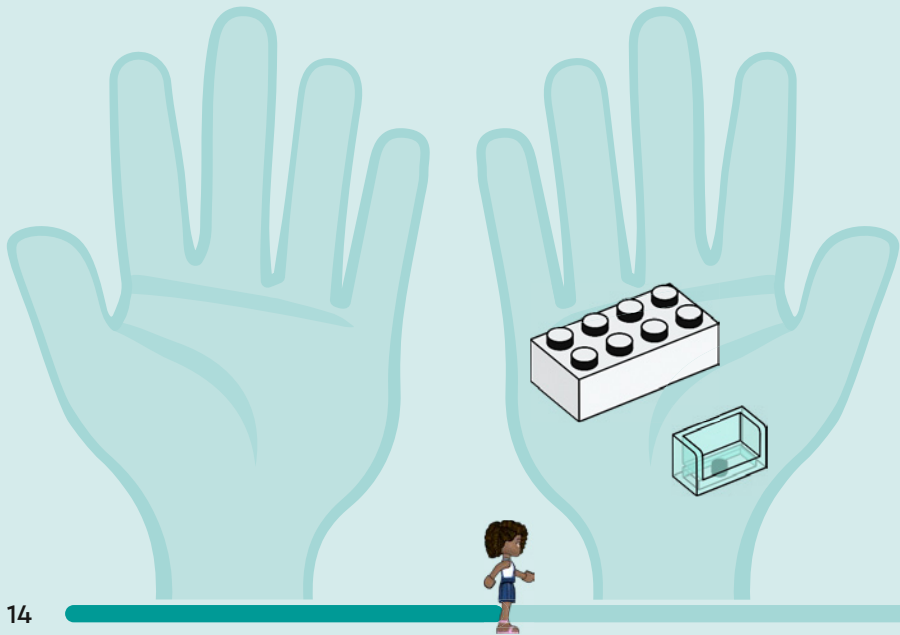

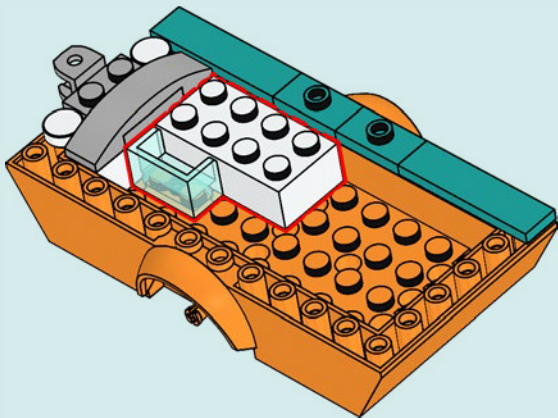

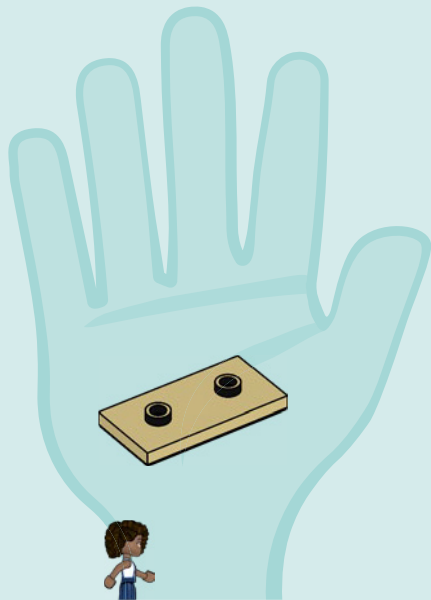

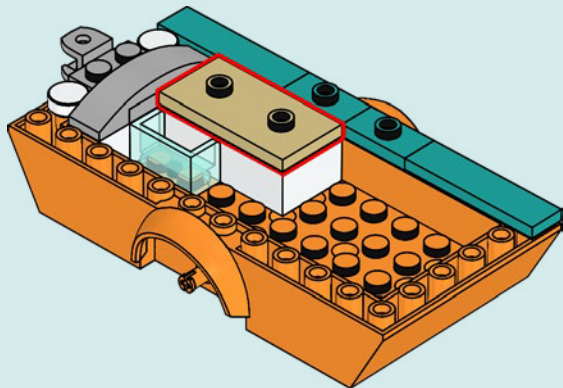

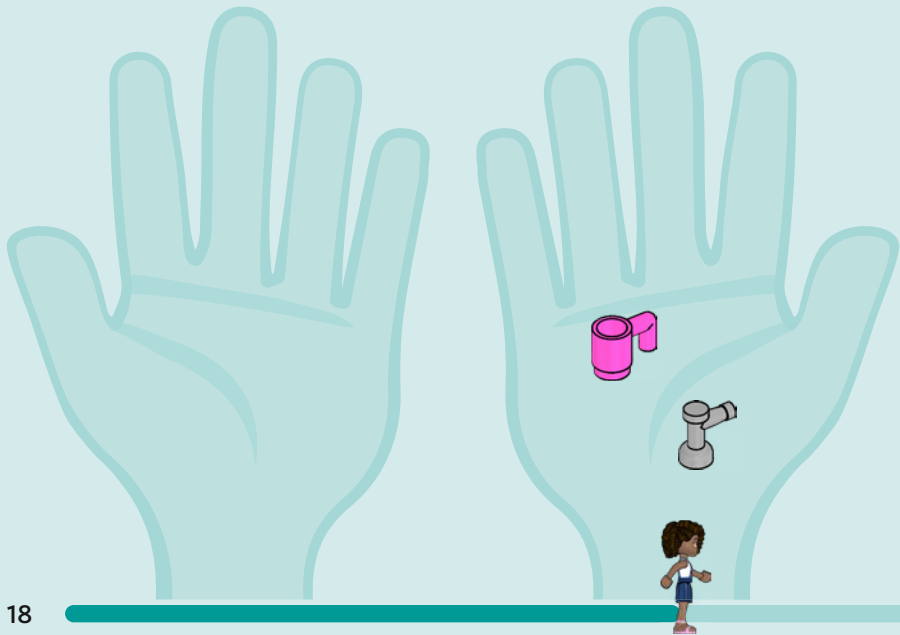

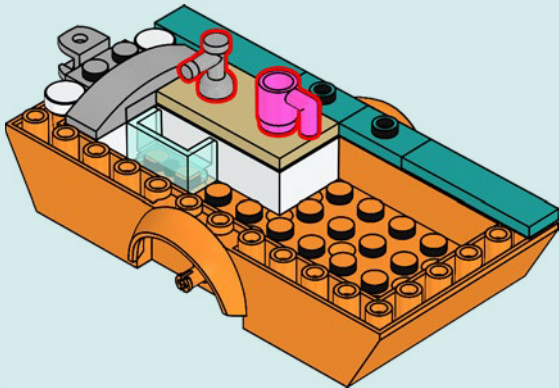

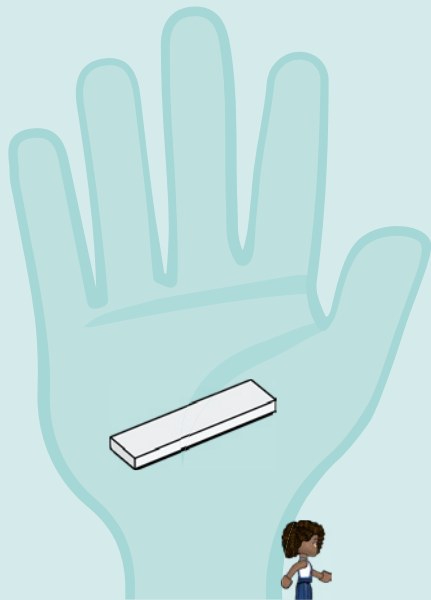

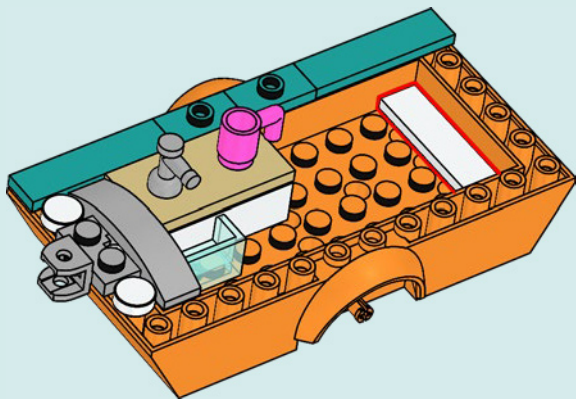

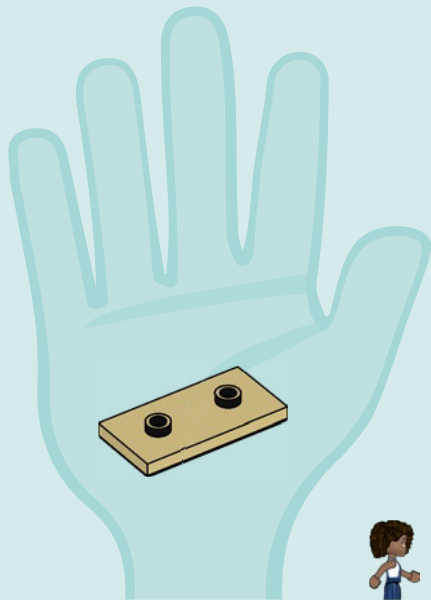

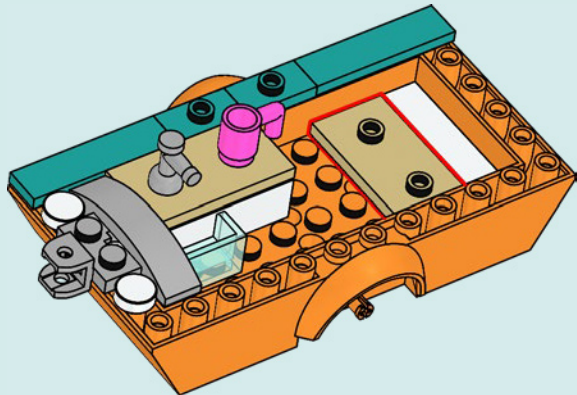

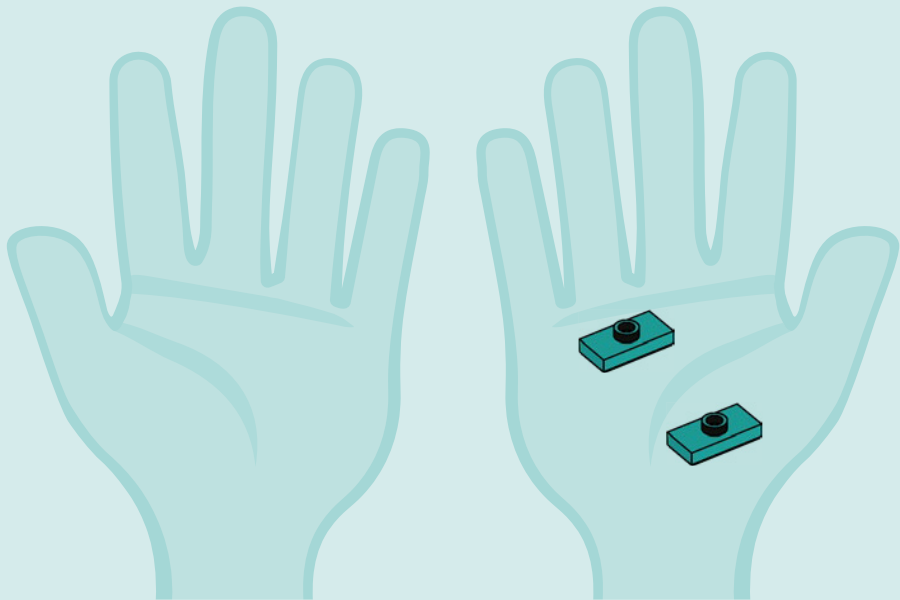

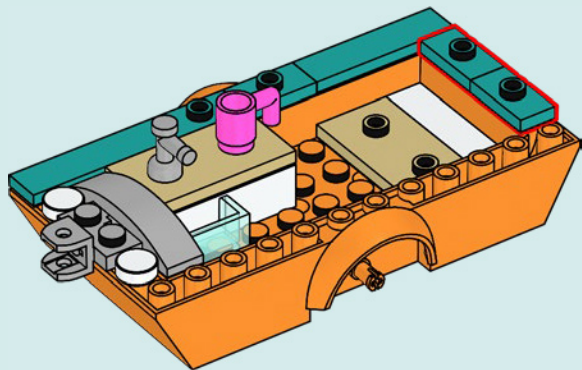

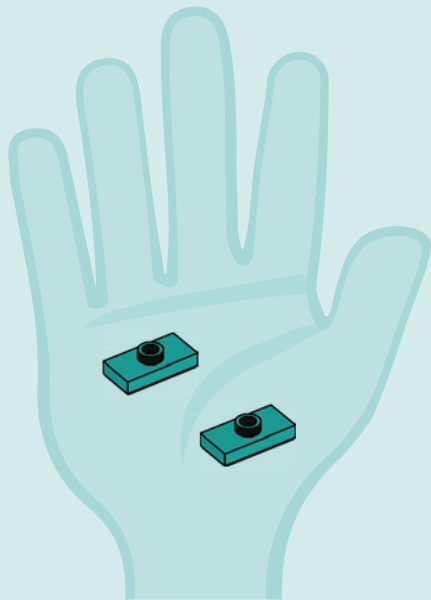
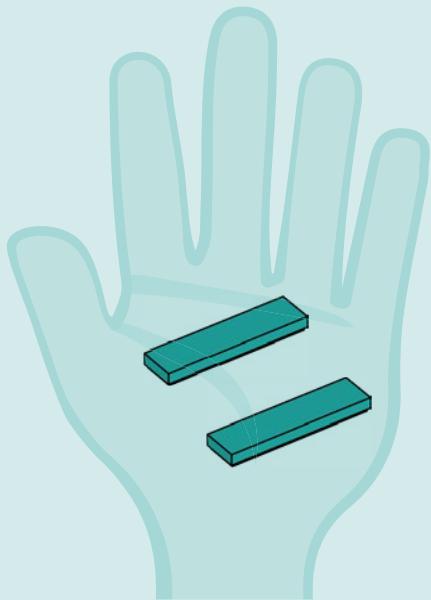

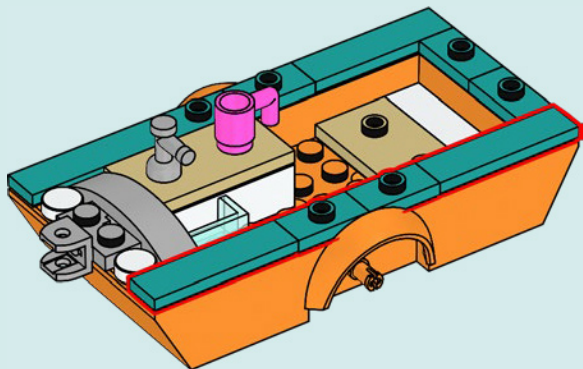

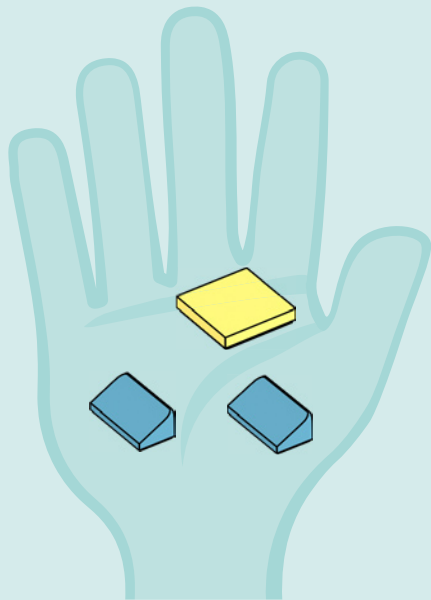
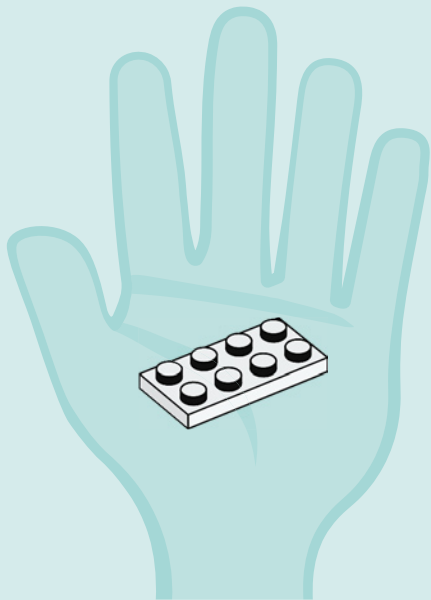



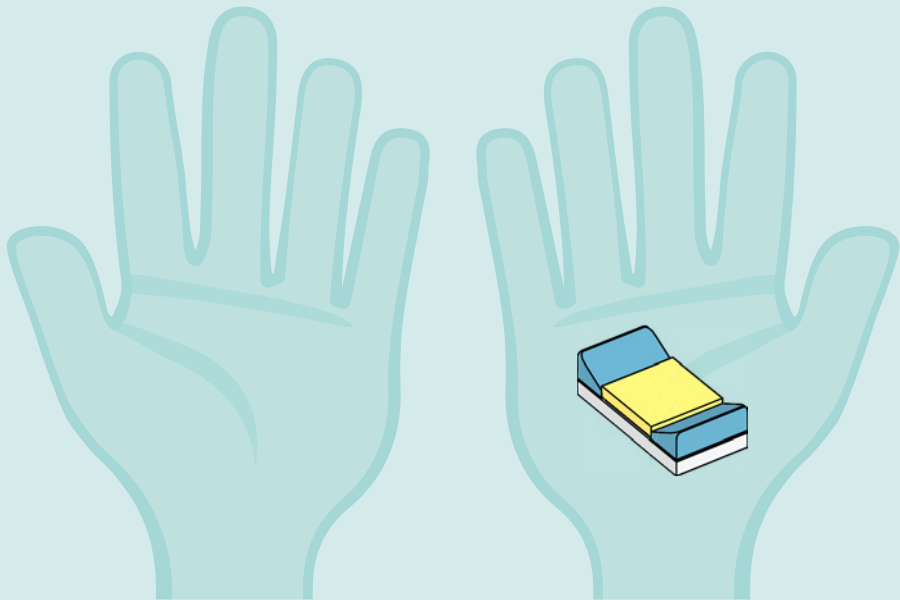

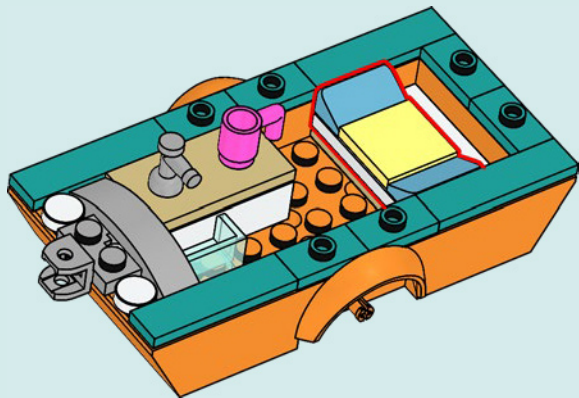

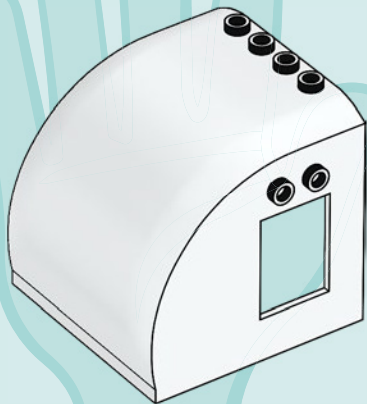
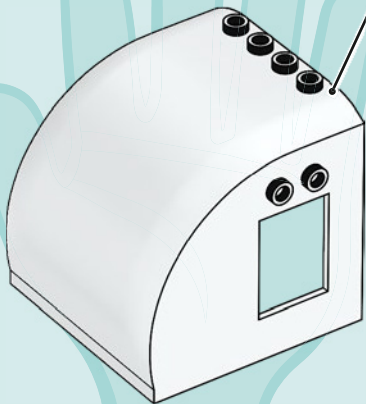
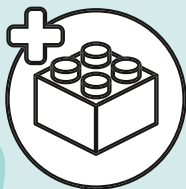

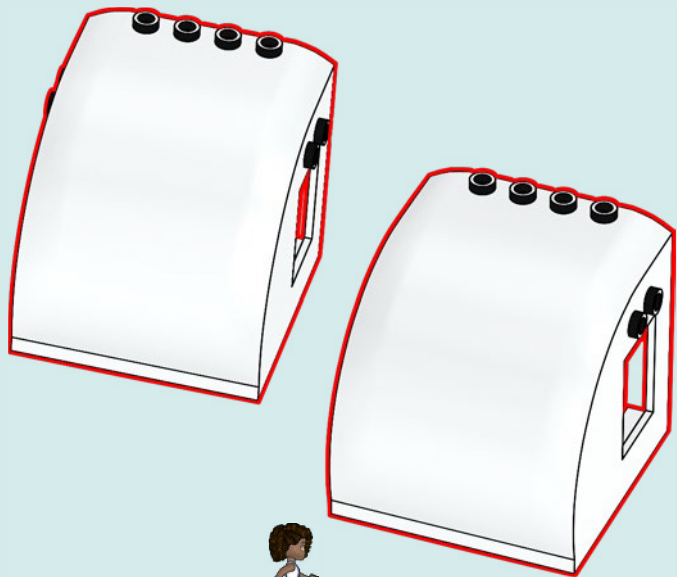

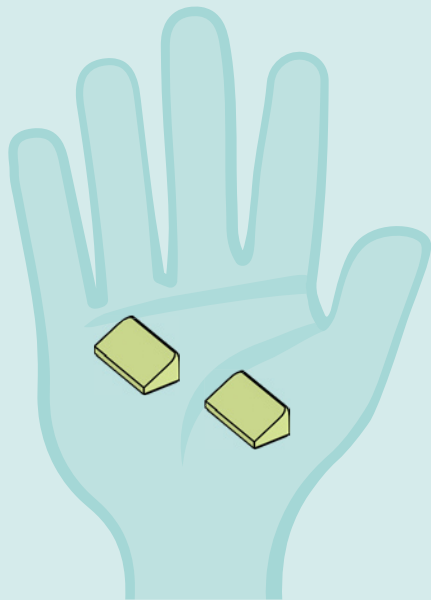
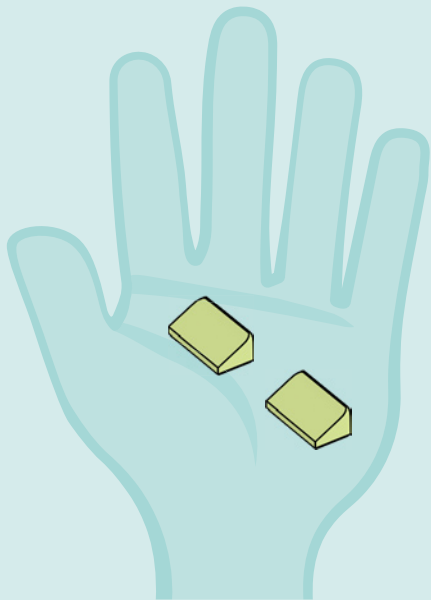

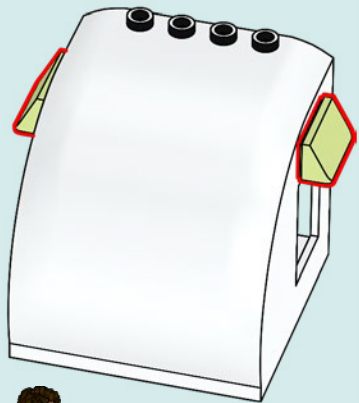
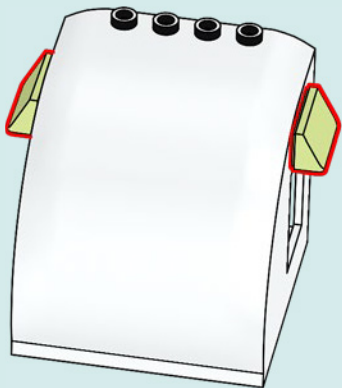

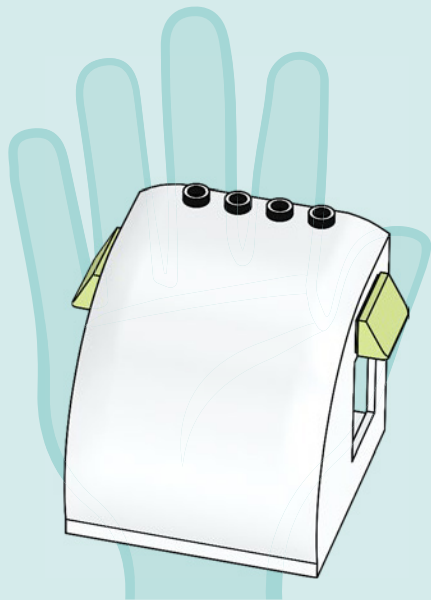
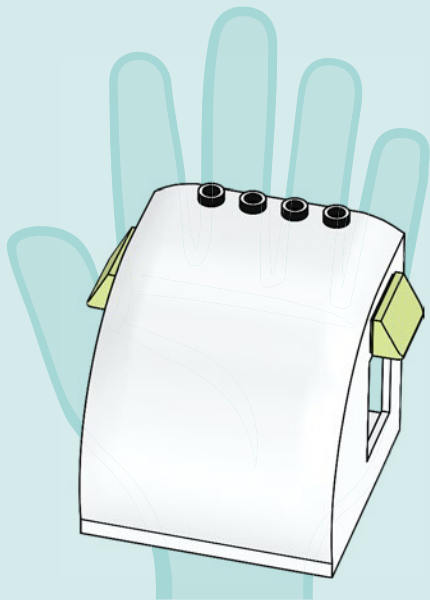

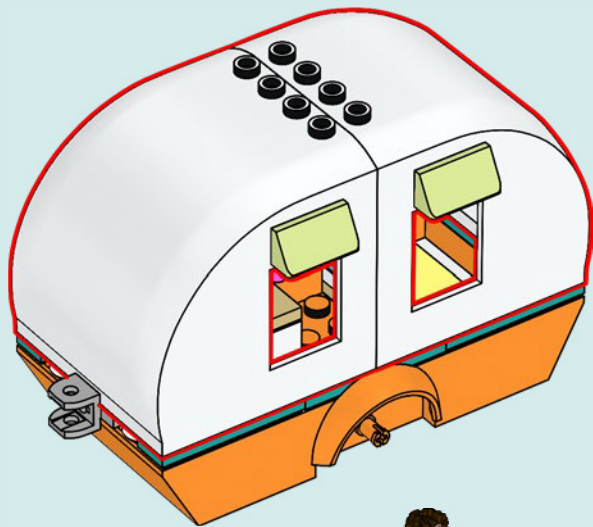

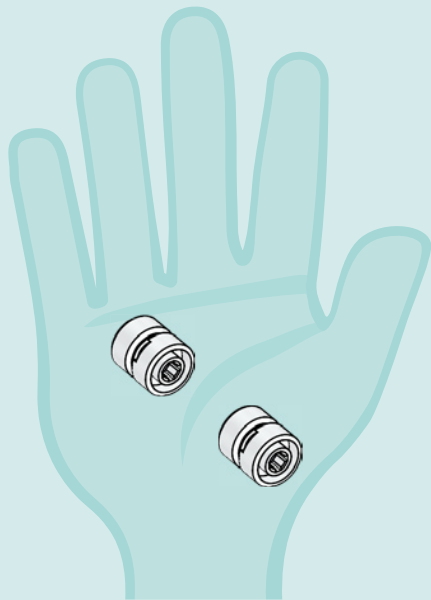
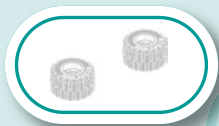

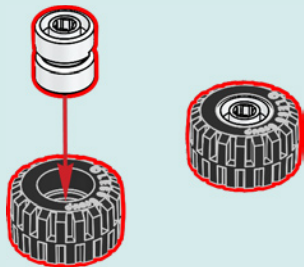

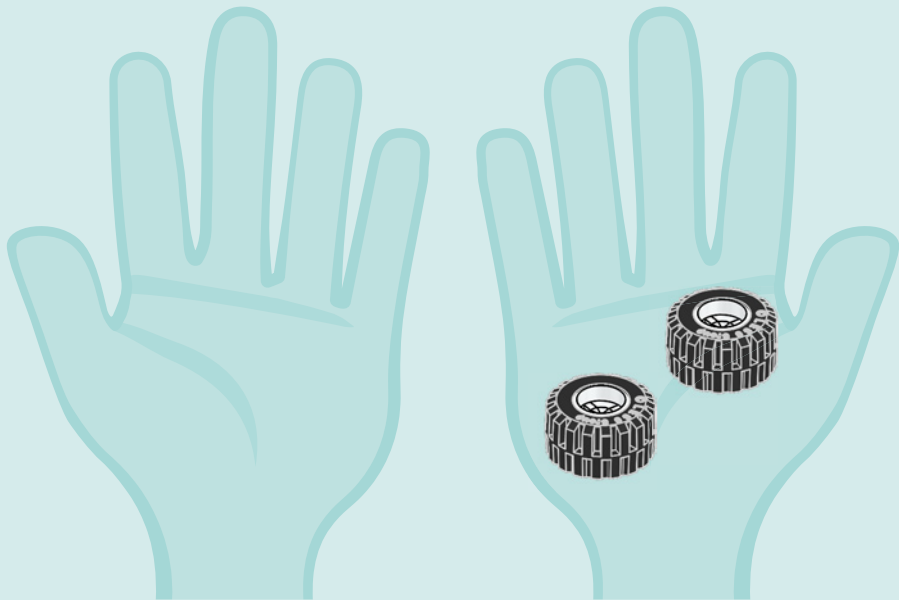

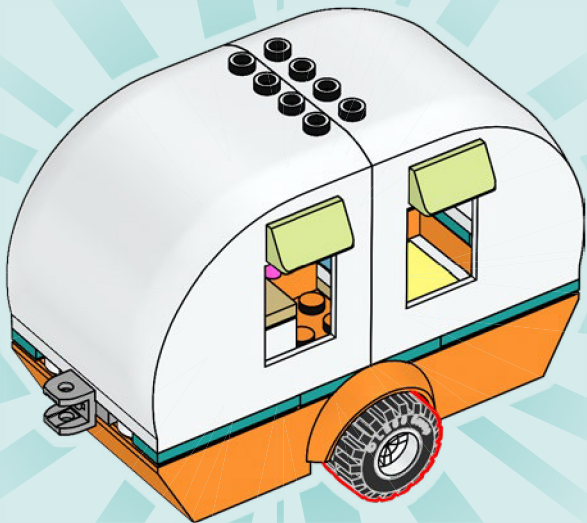

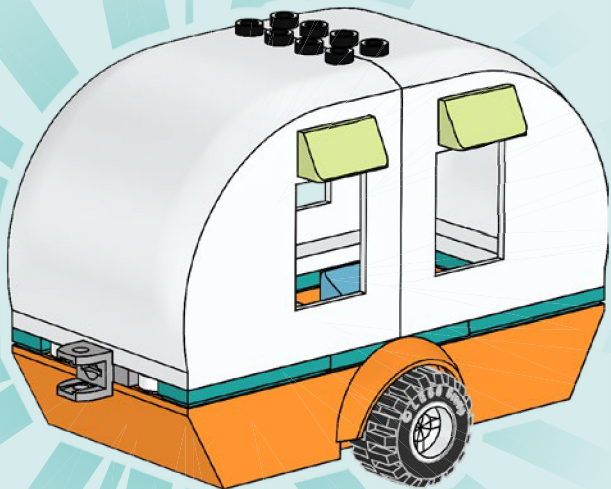

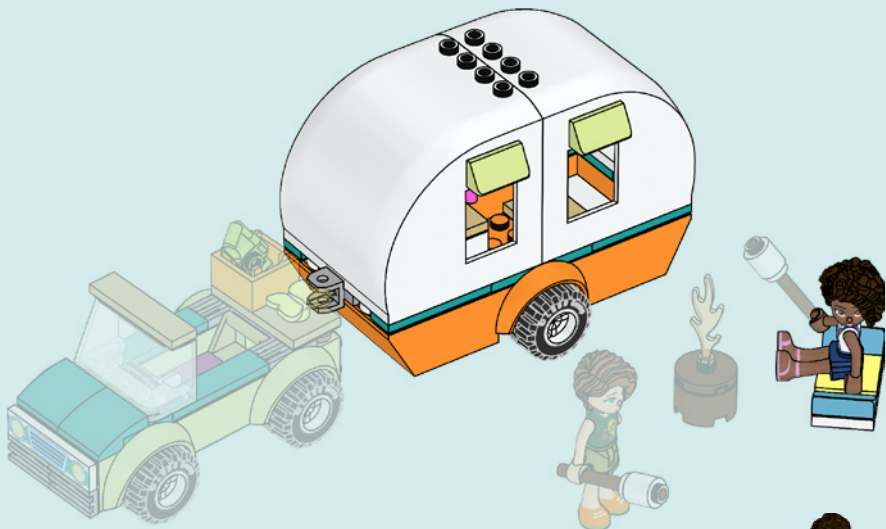



Rebuild
the
world™



LEGO, the LEGO logo and the FRIENDS logo are trademarks of the LEGO Group. 6444342
©2023 The LEGO Group.