

3432



# SPORTS













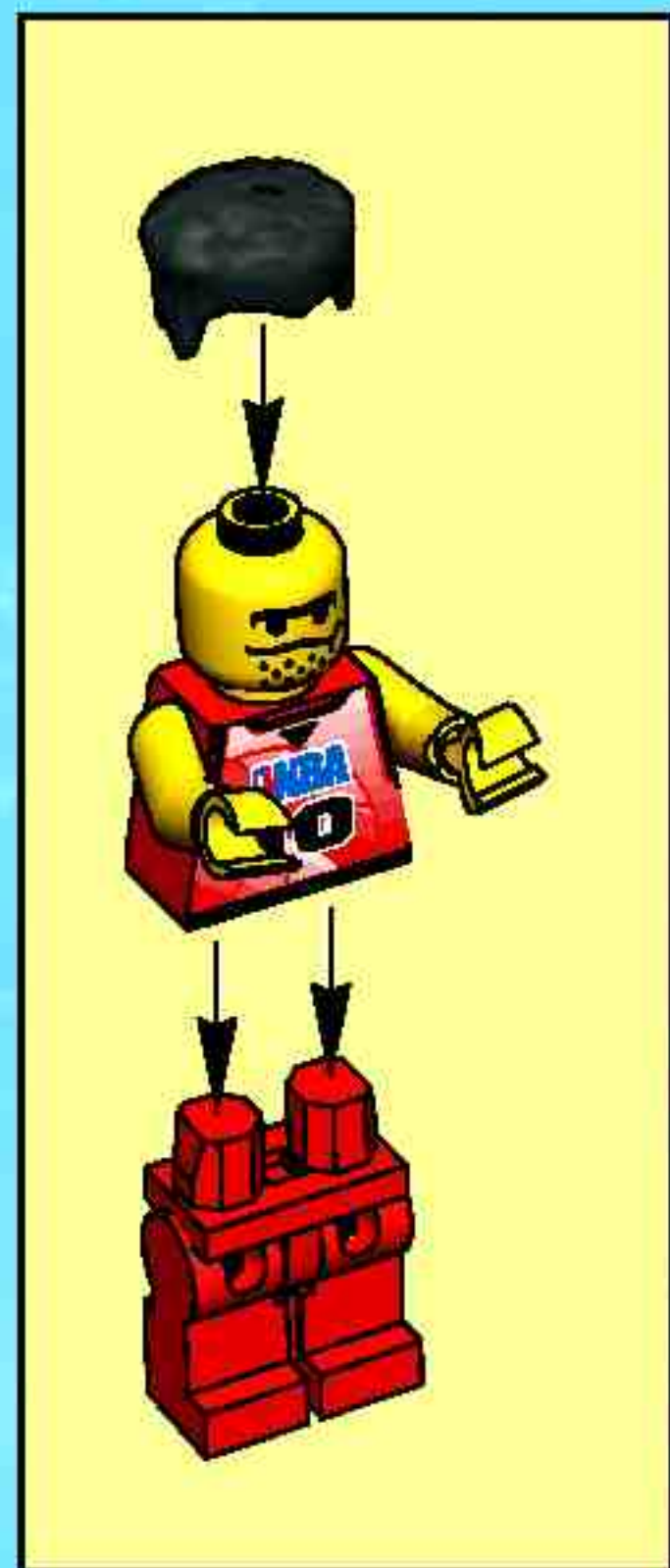



1

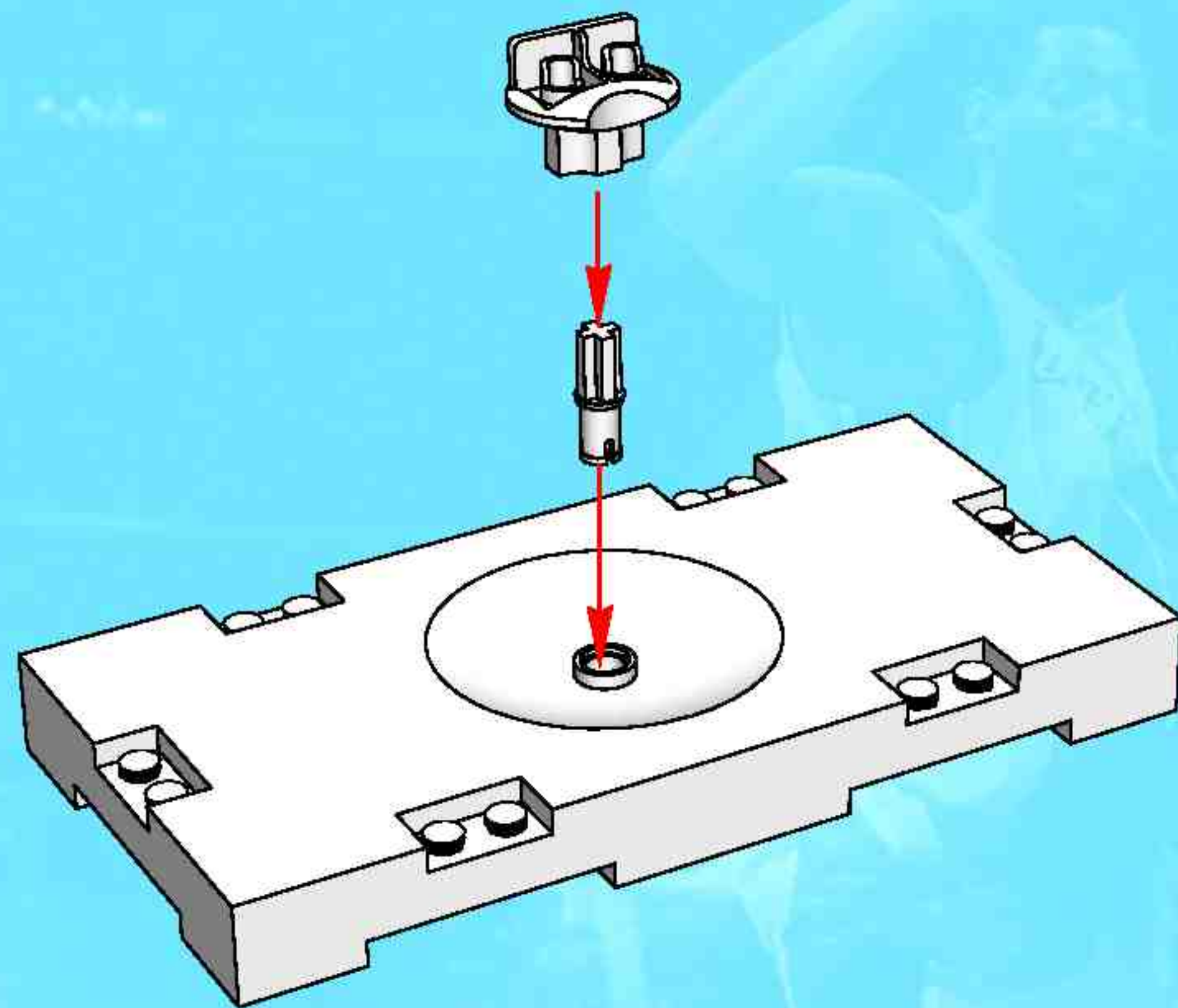

2

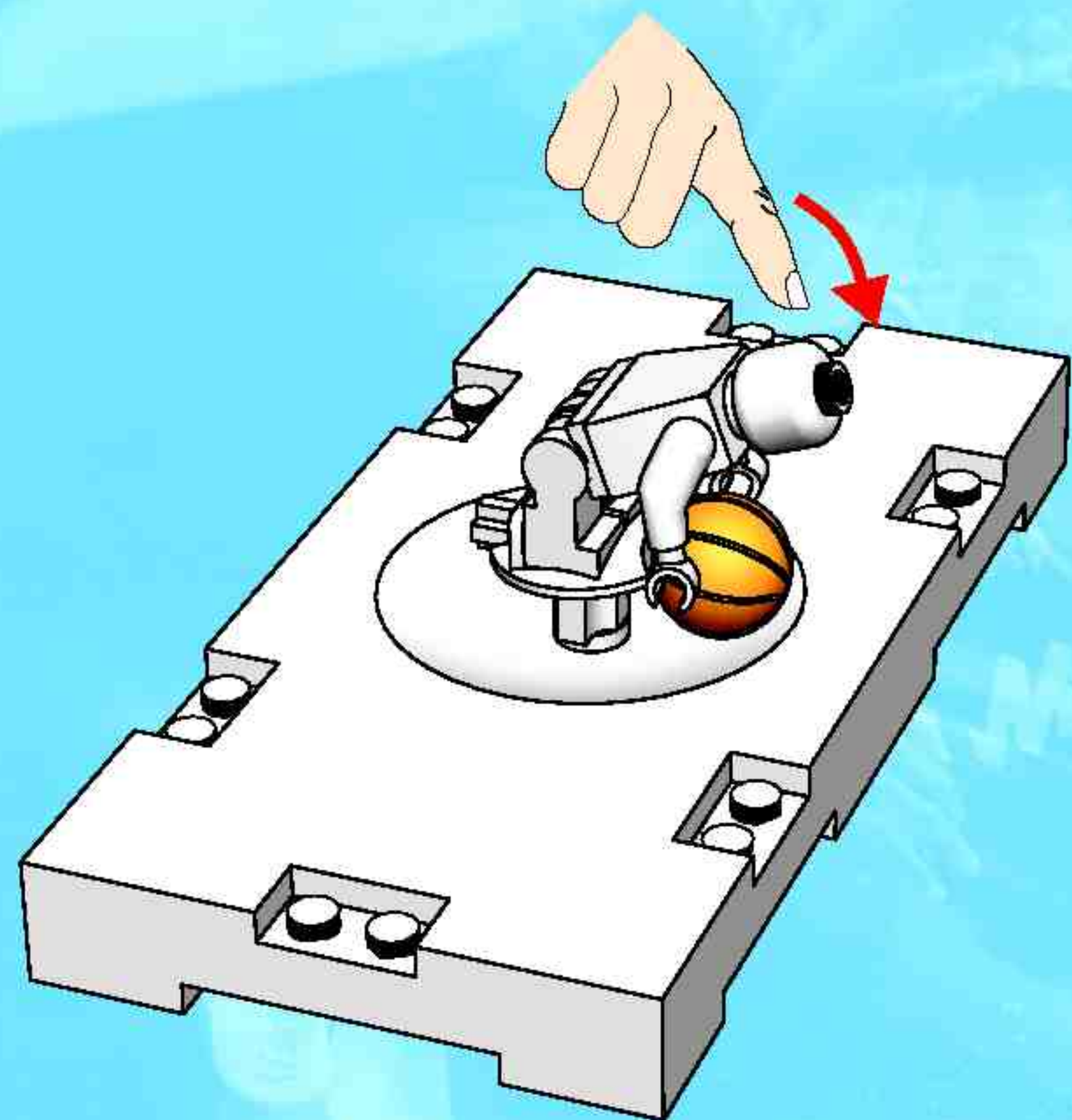

3

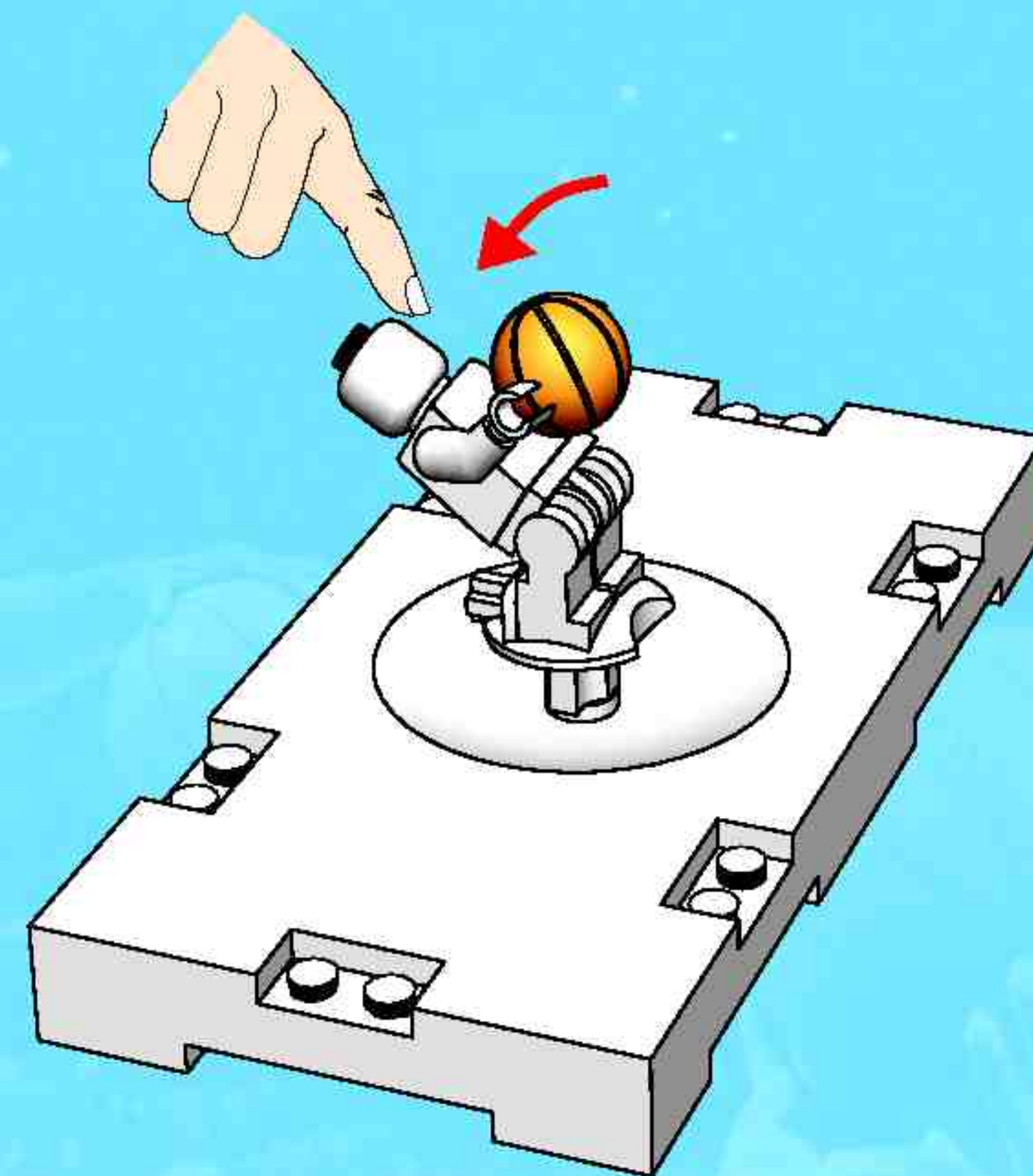

4

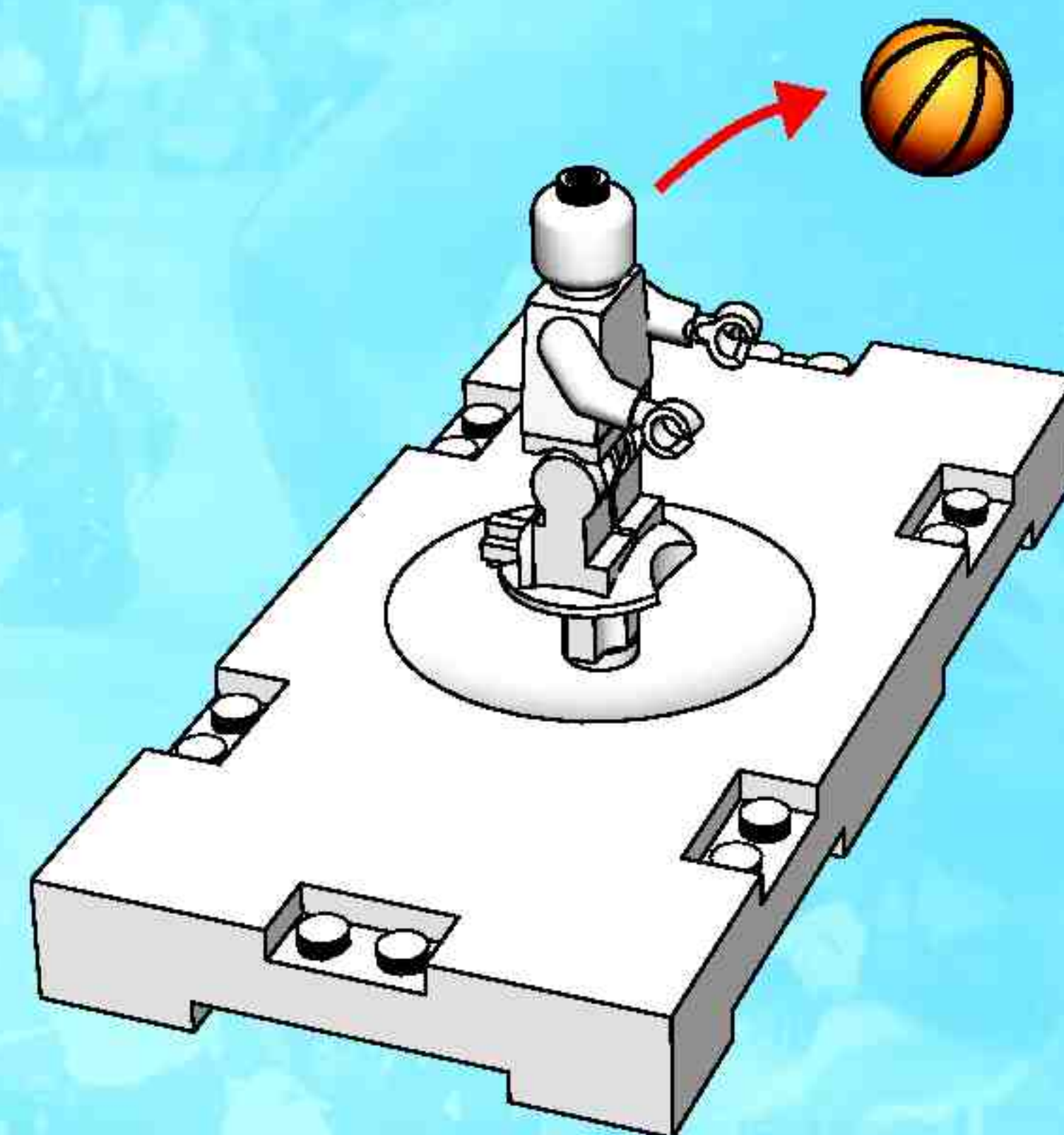



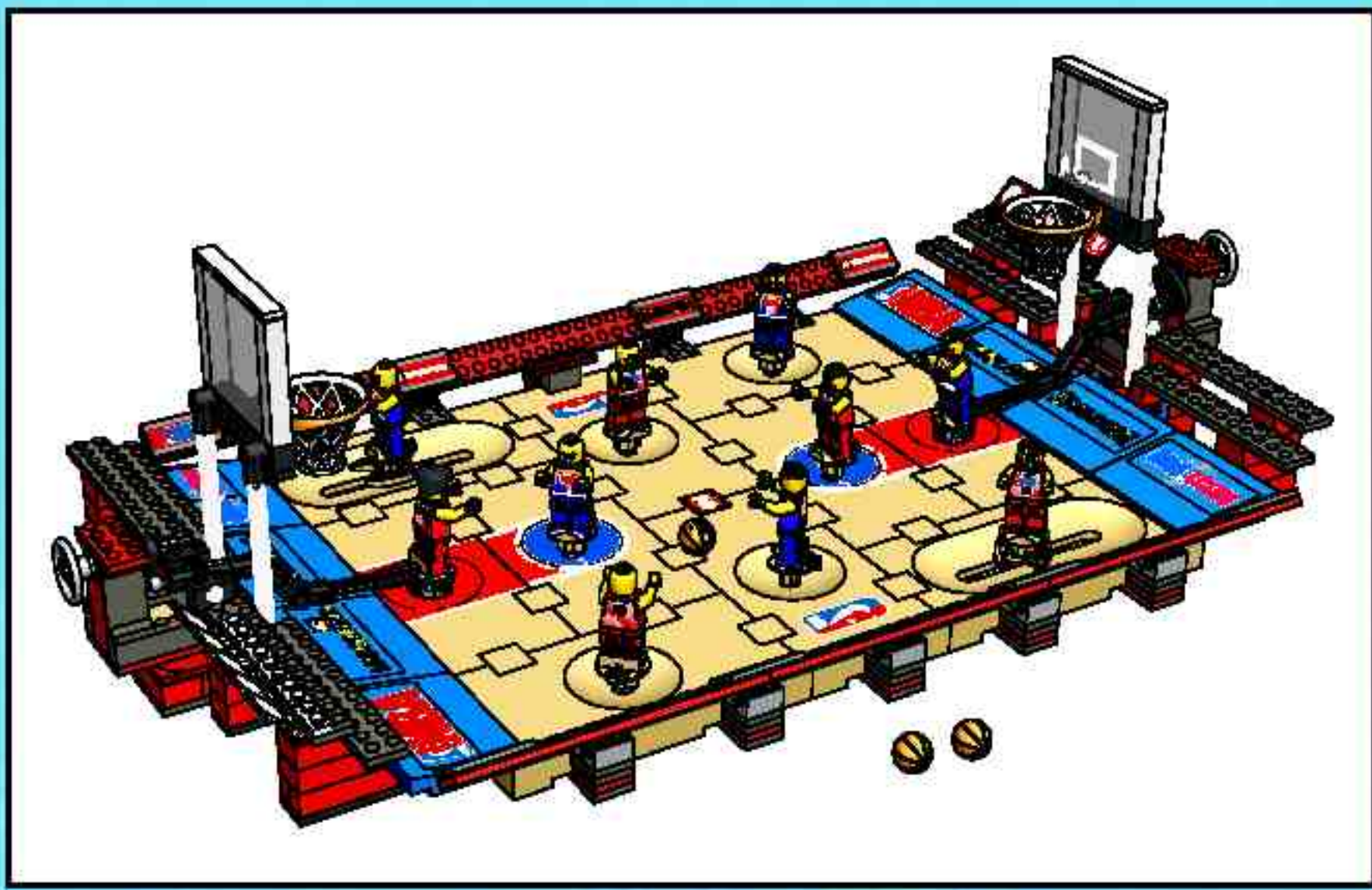

1

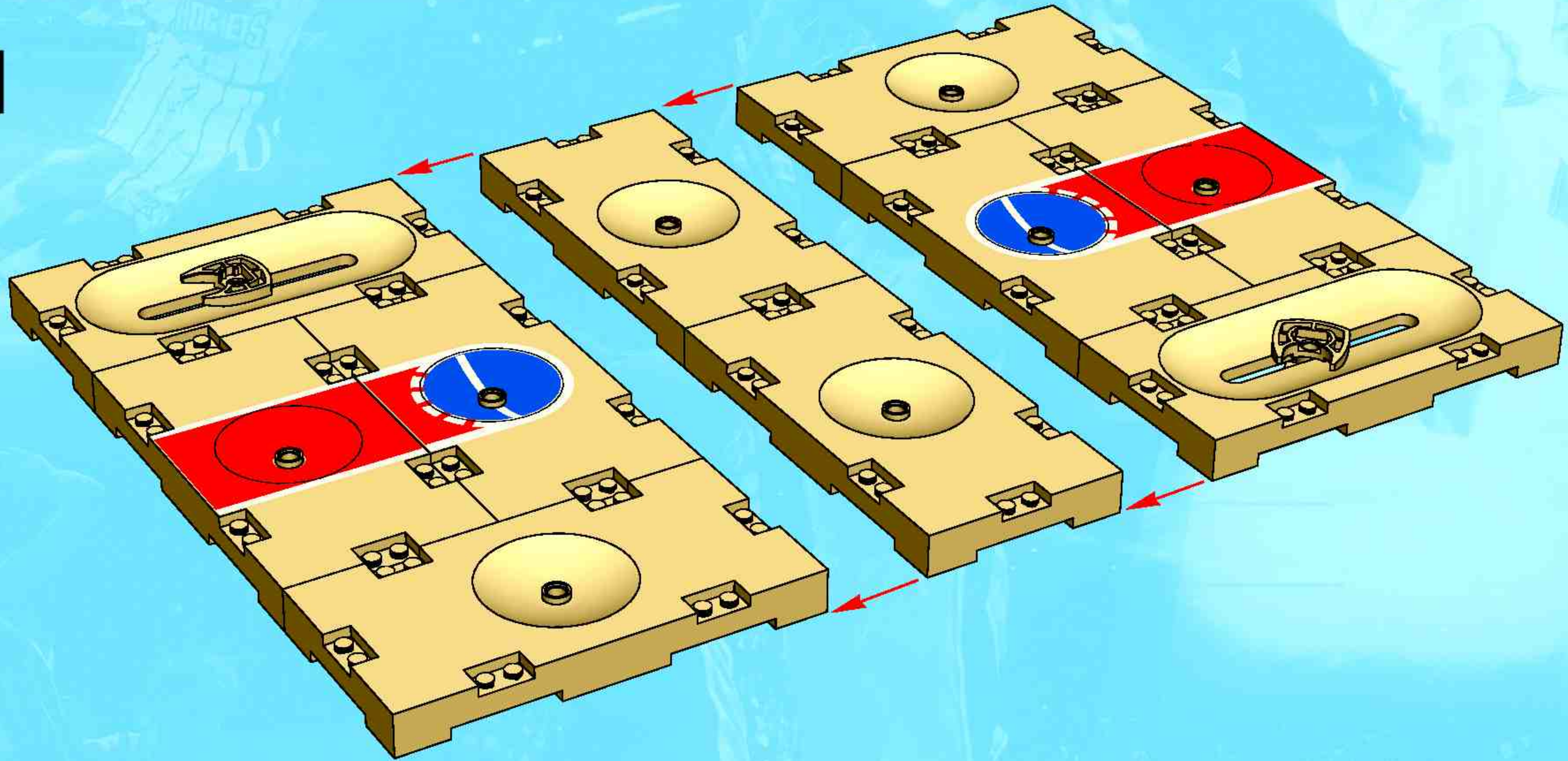



2

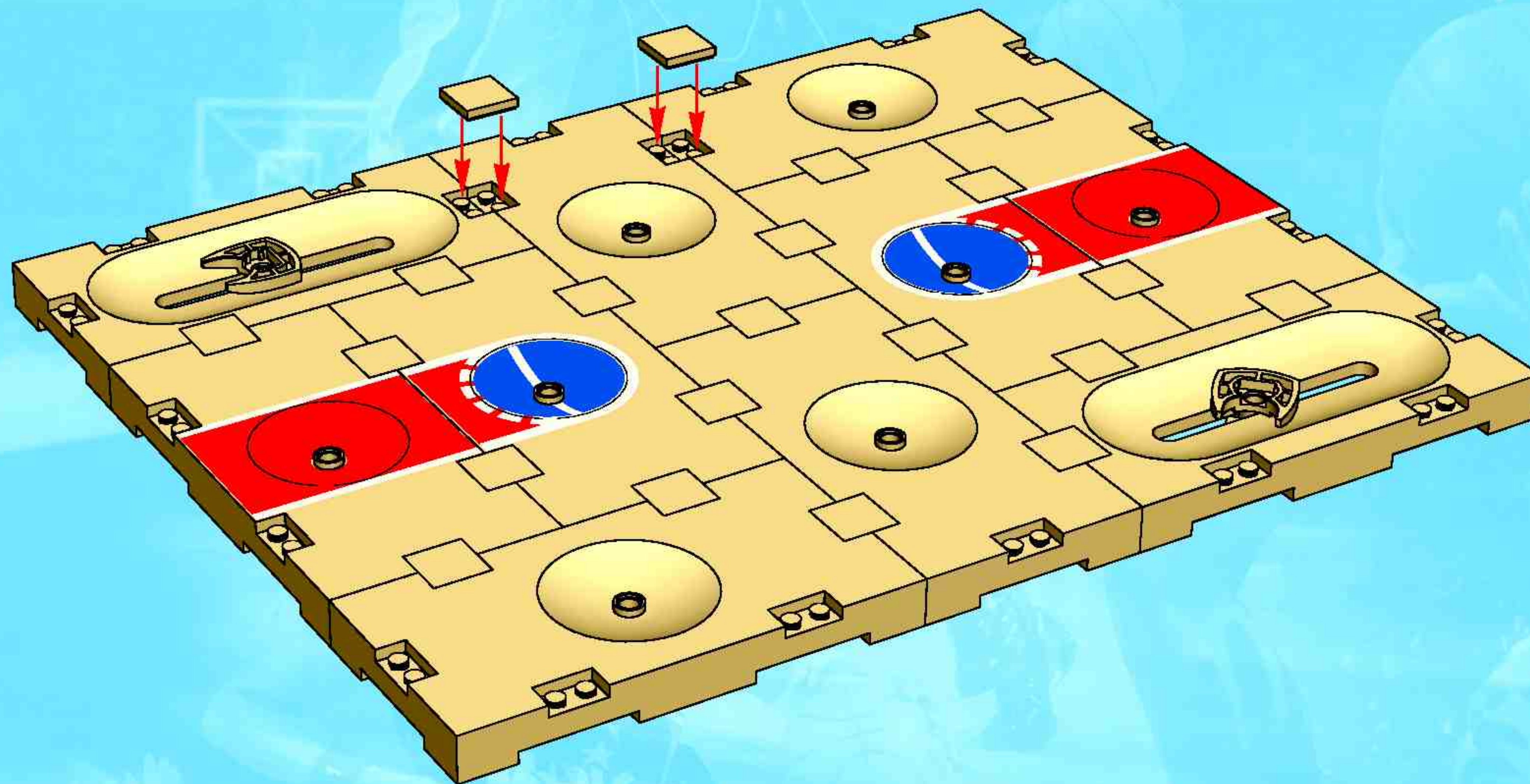



3

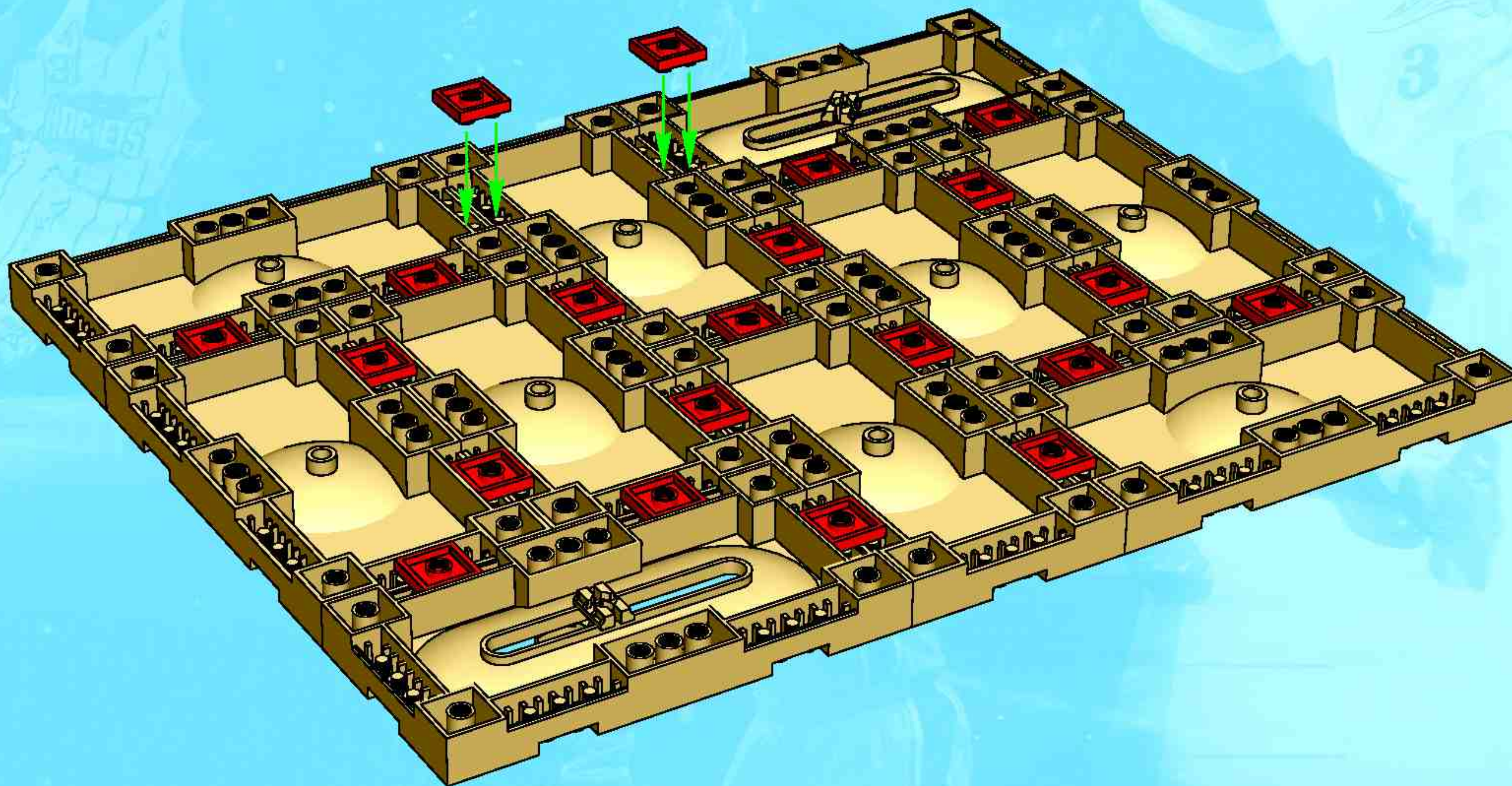



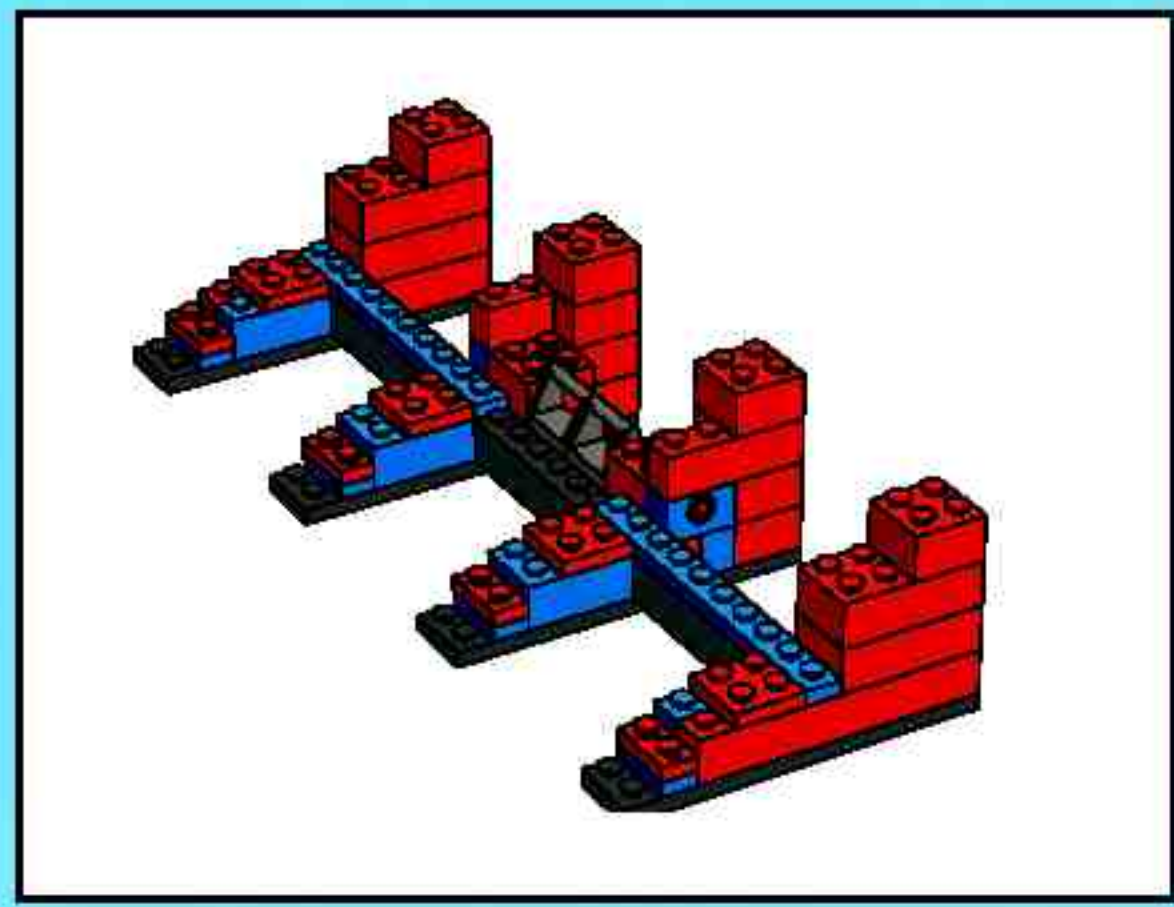

1

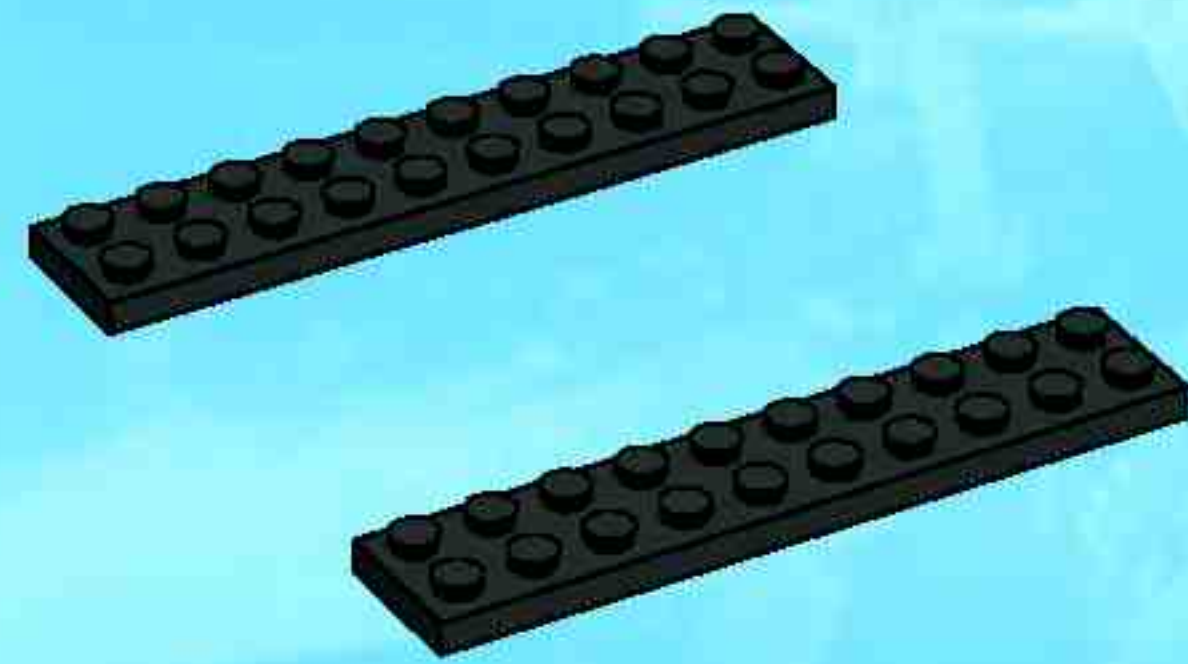

2

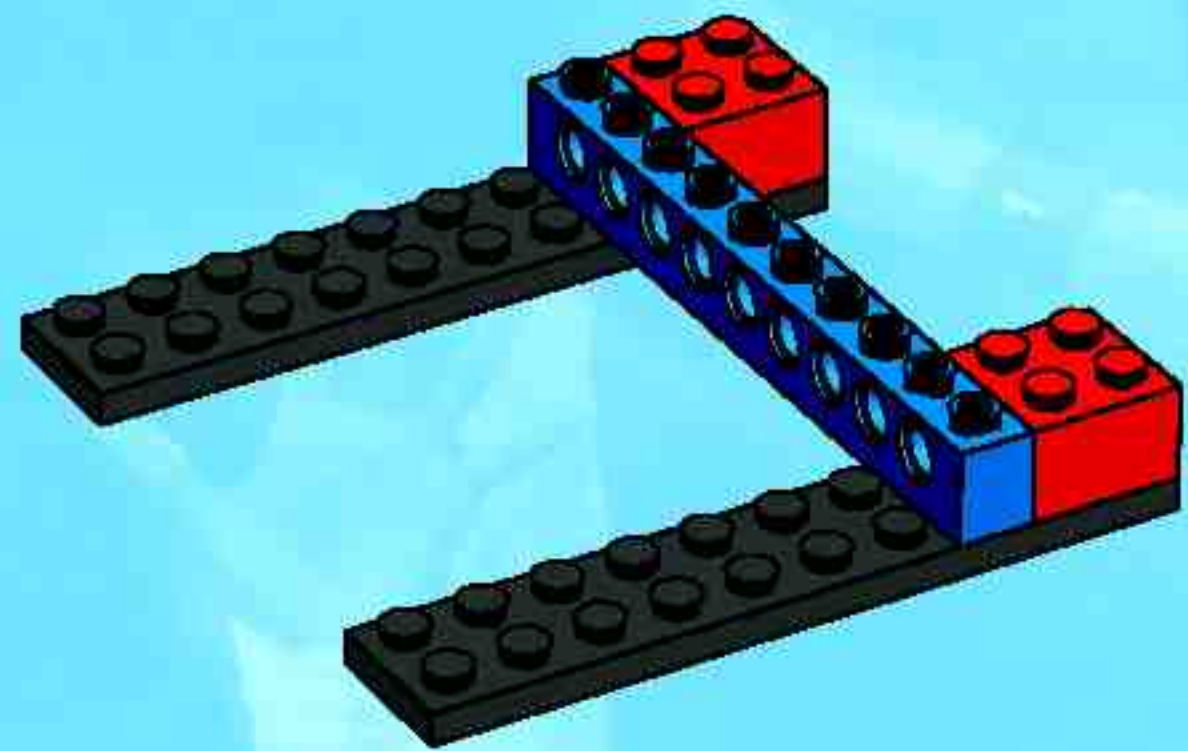

3

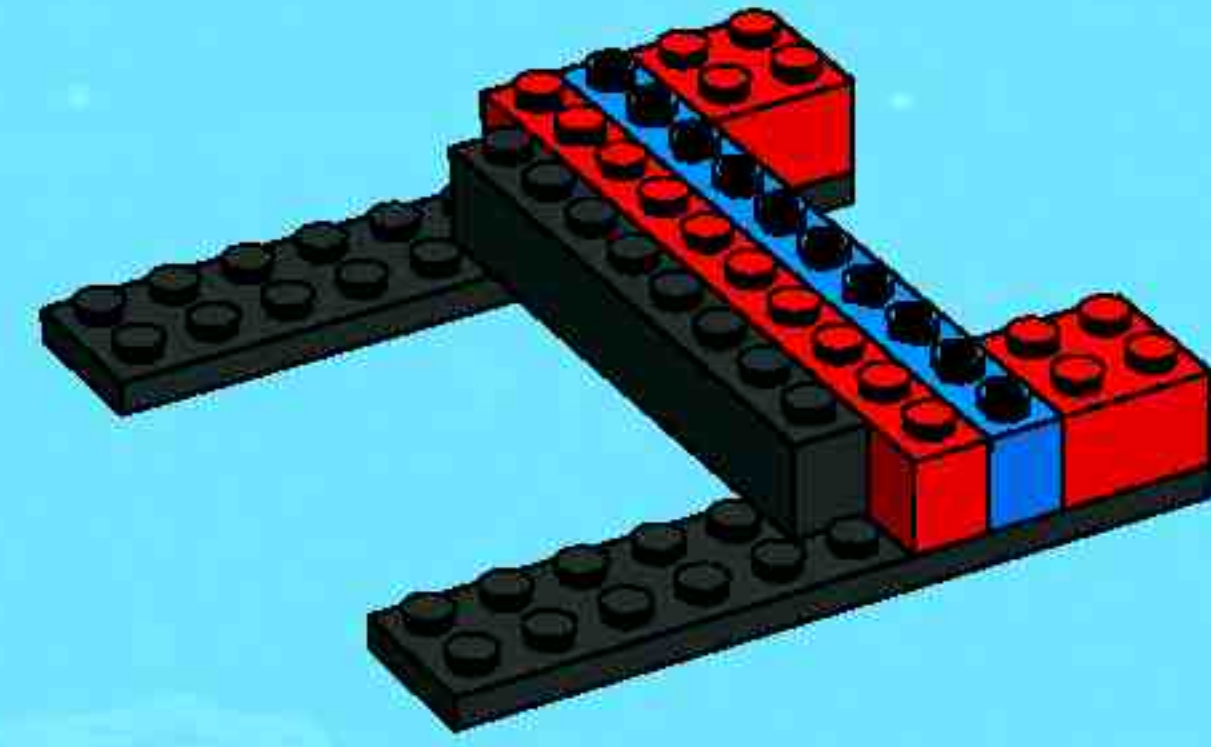

4

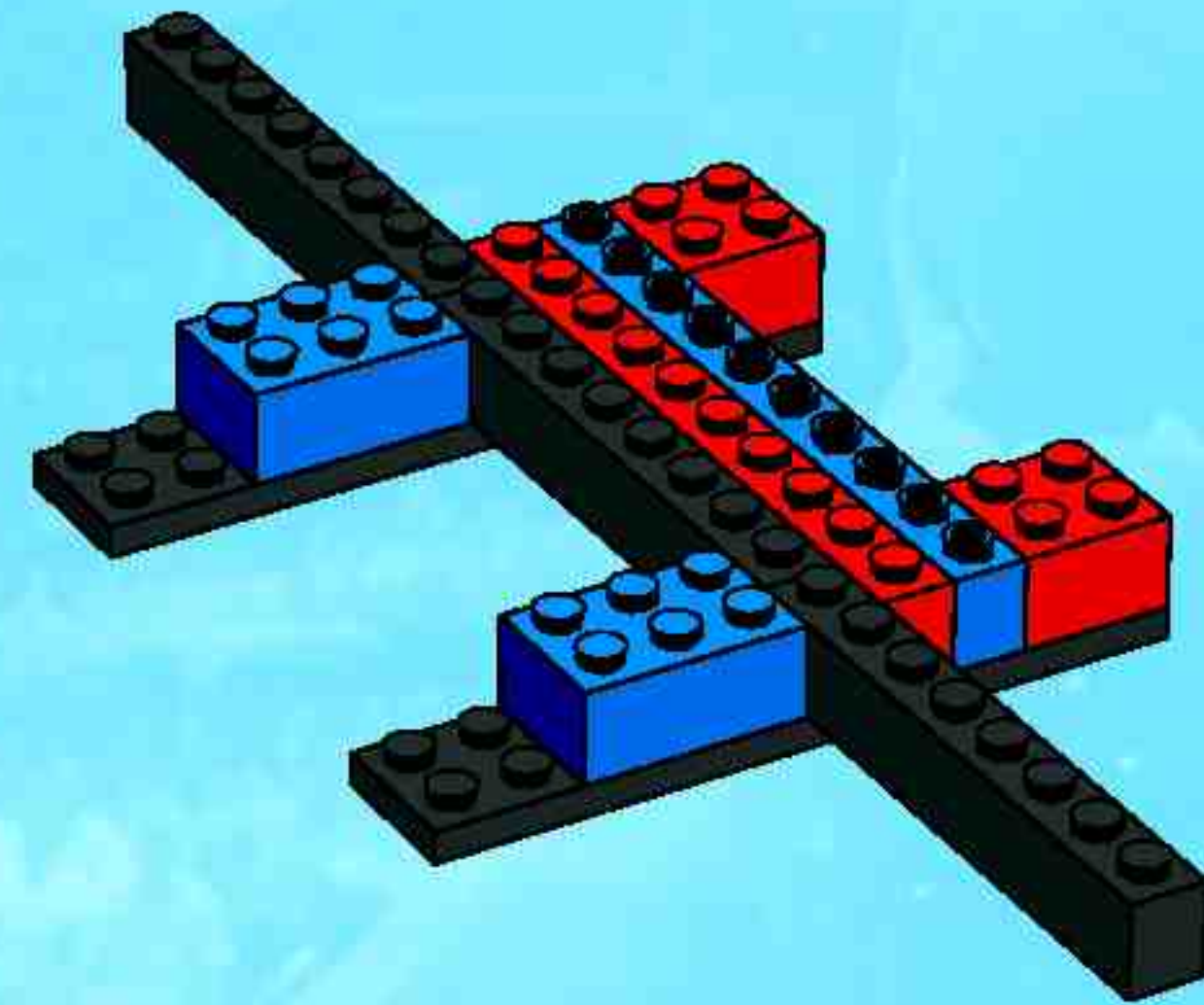

5

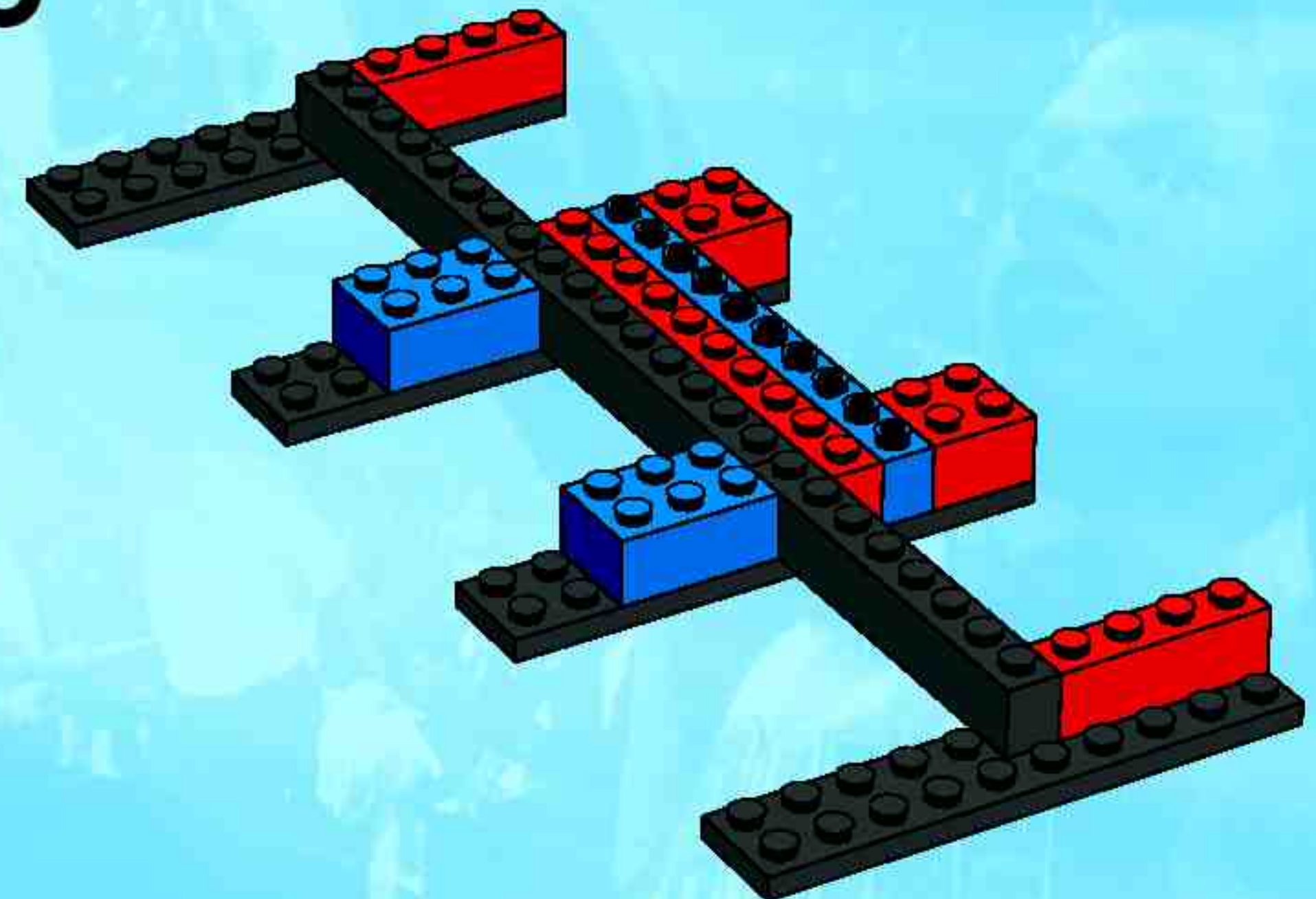



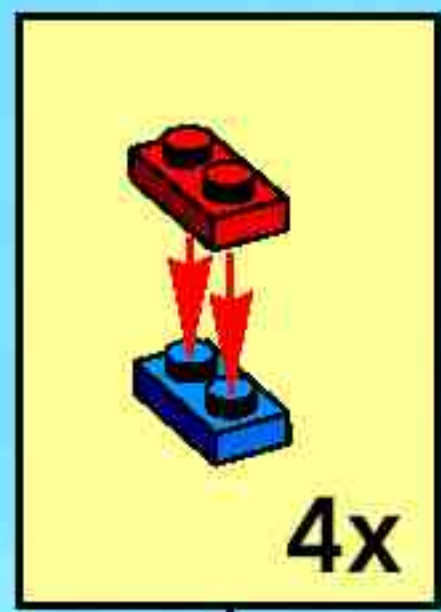

6

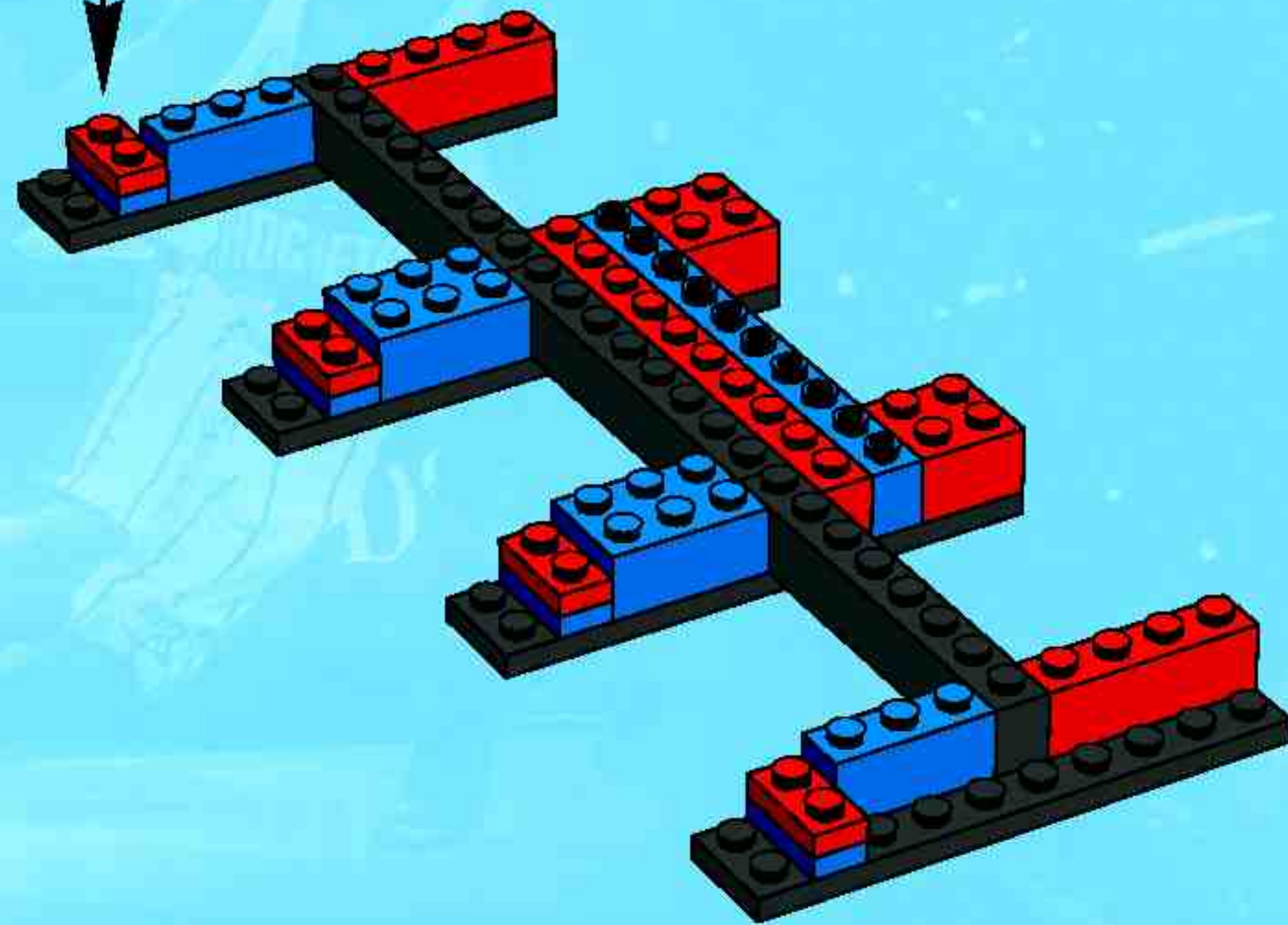

7

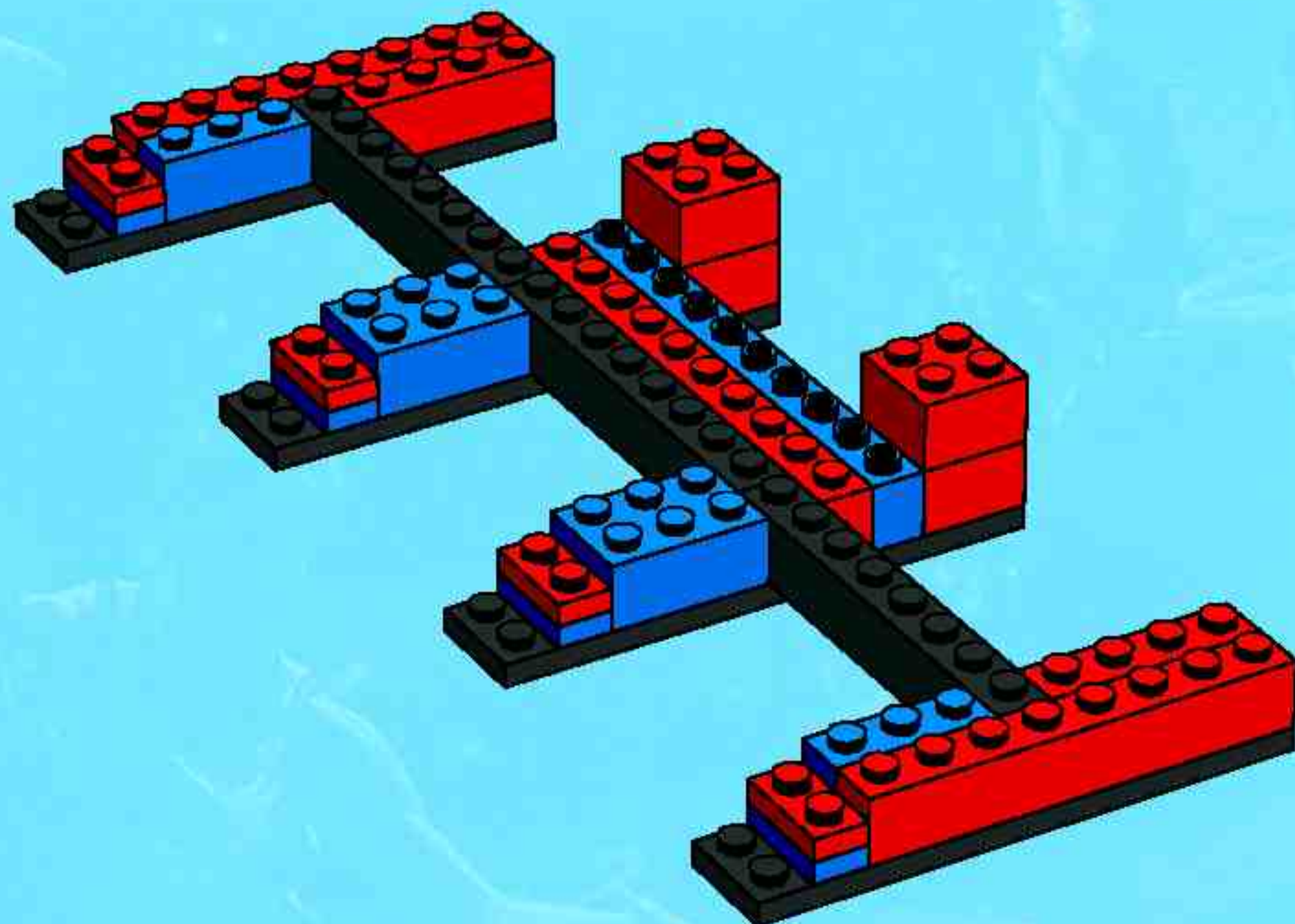

8

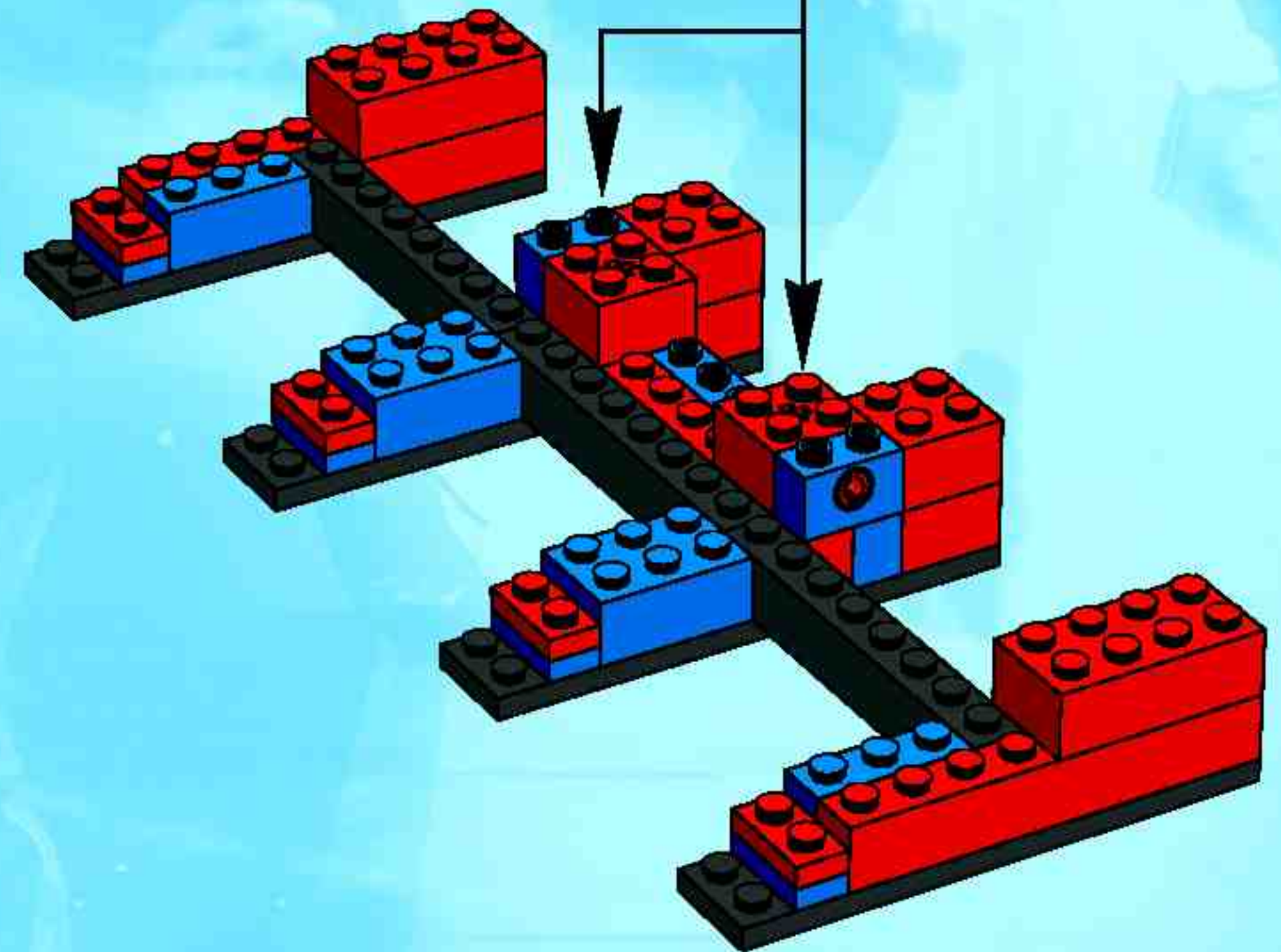
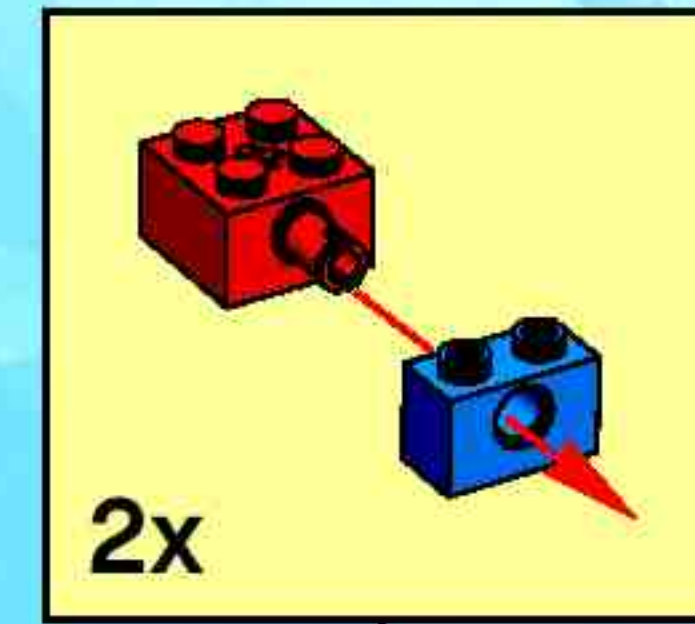



9

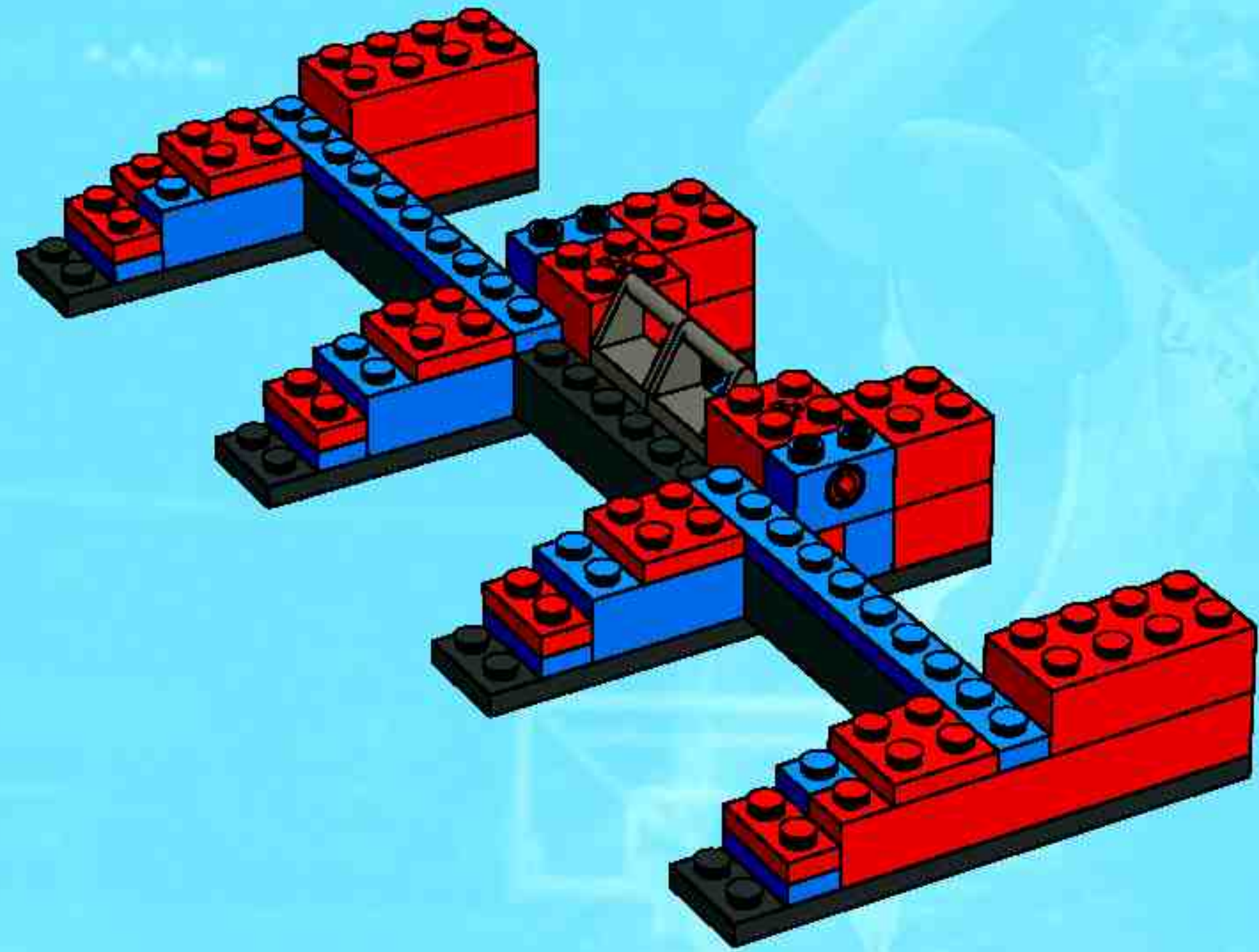

10

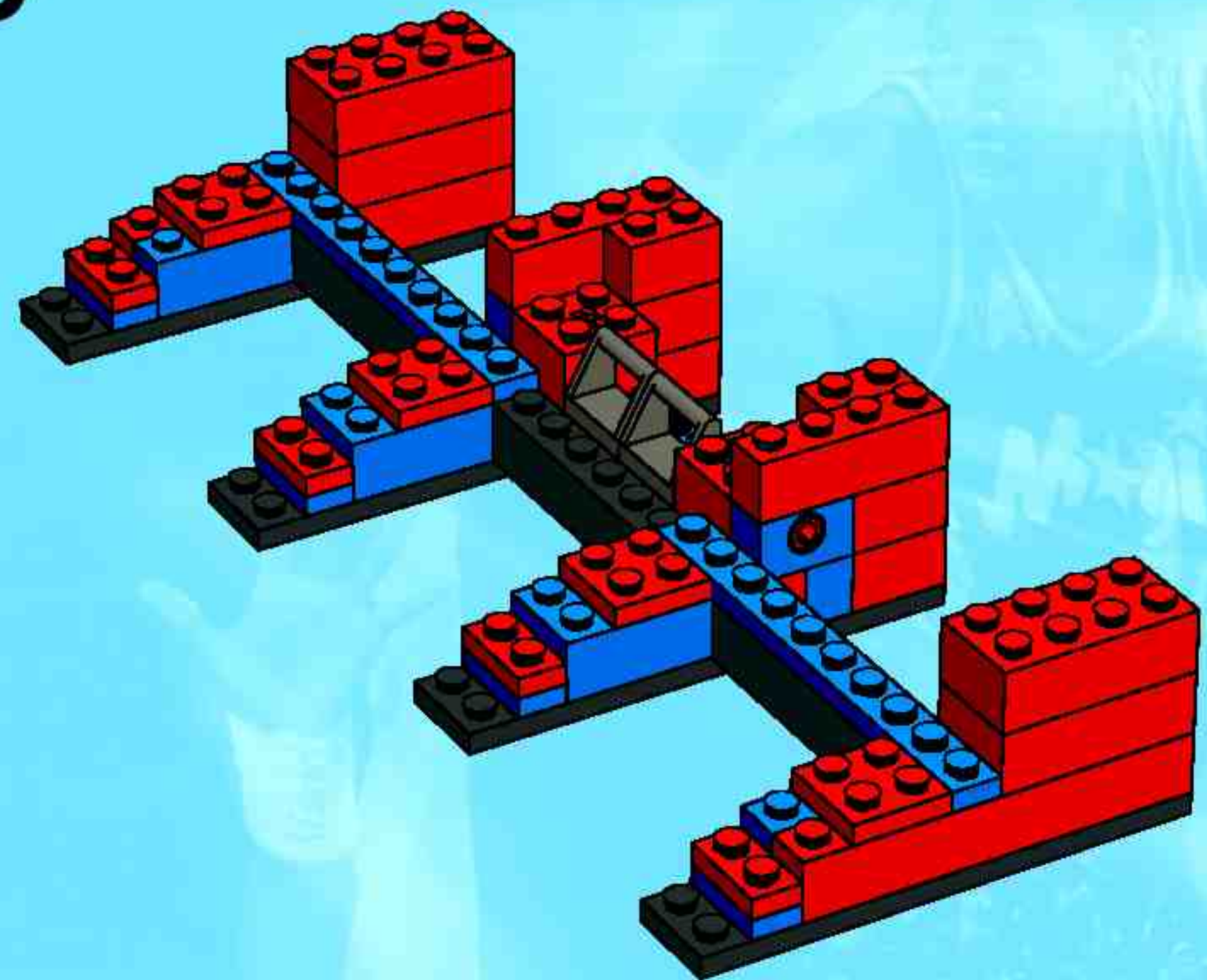

11

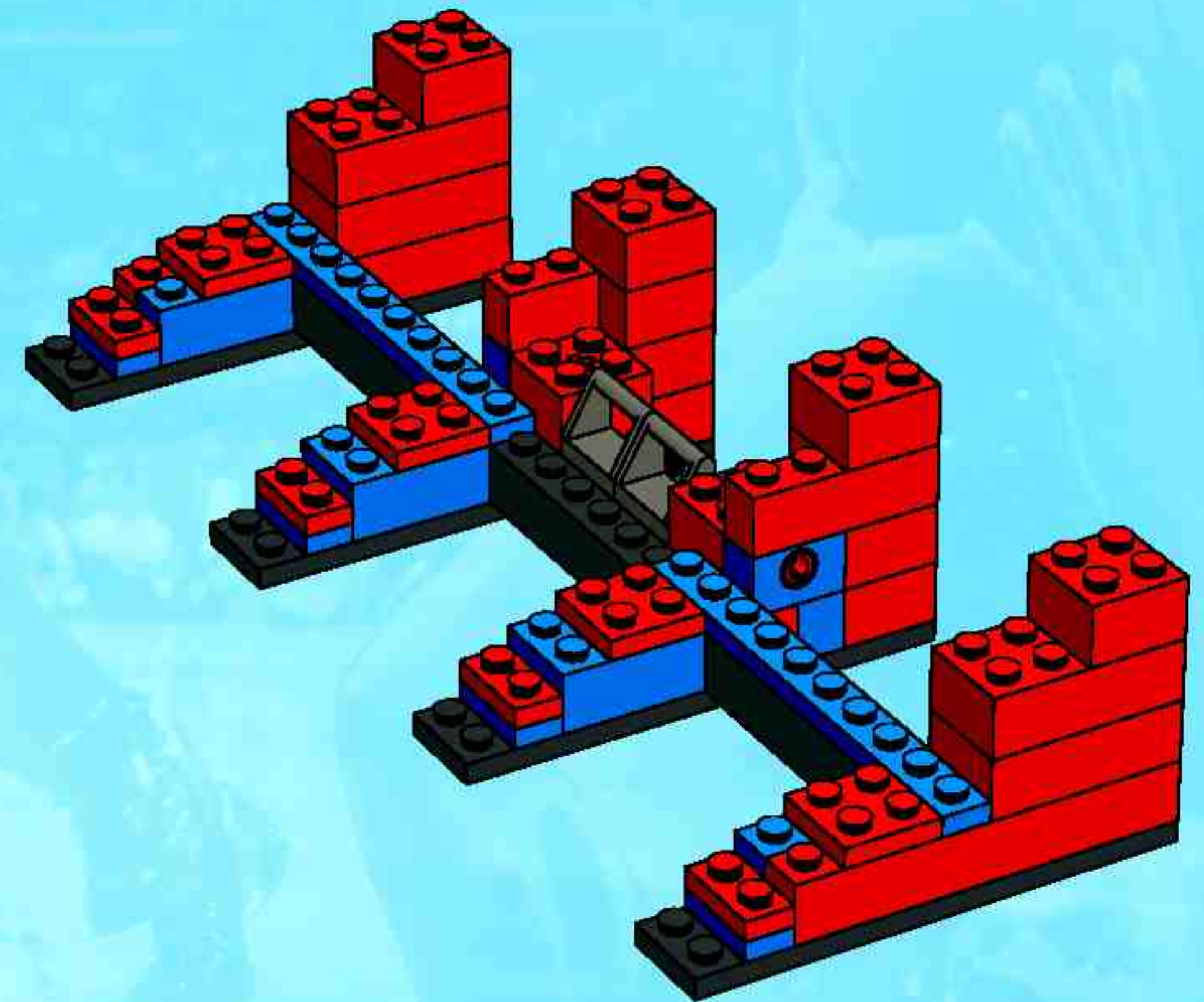

2x



4

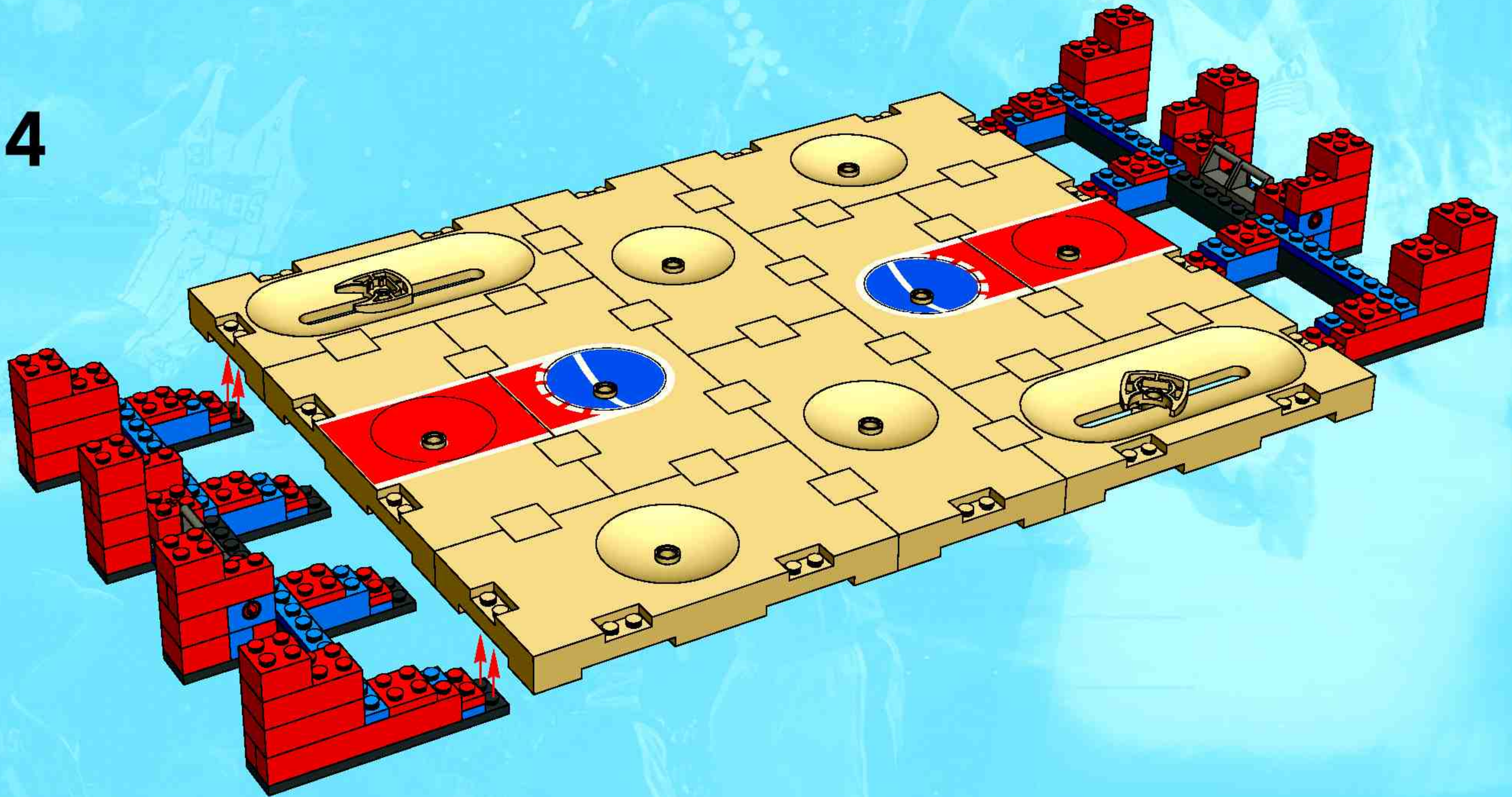



5

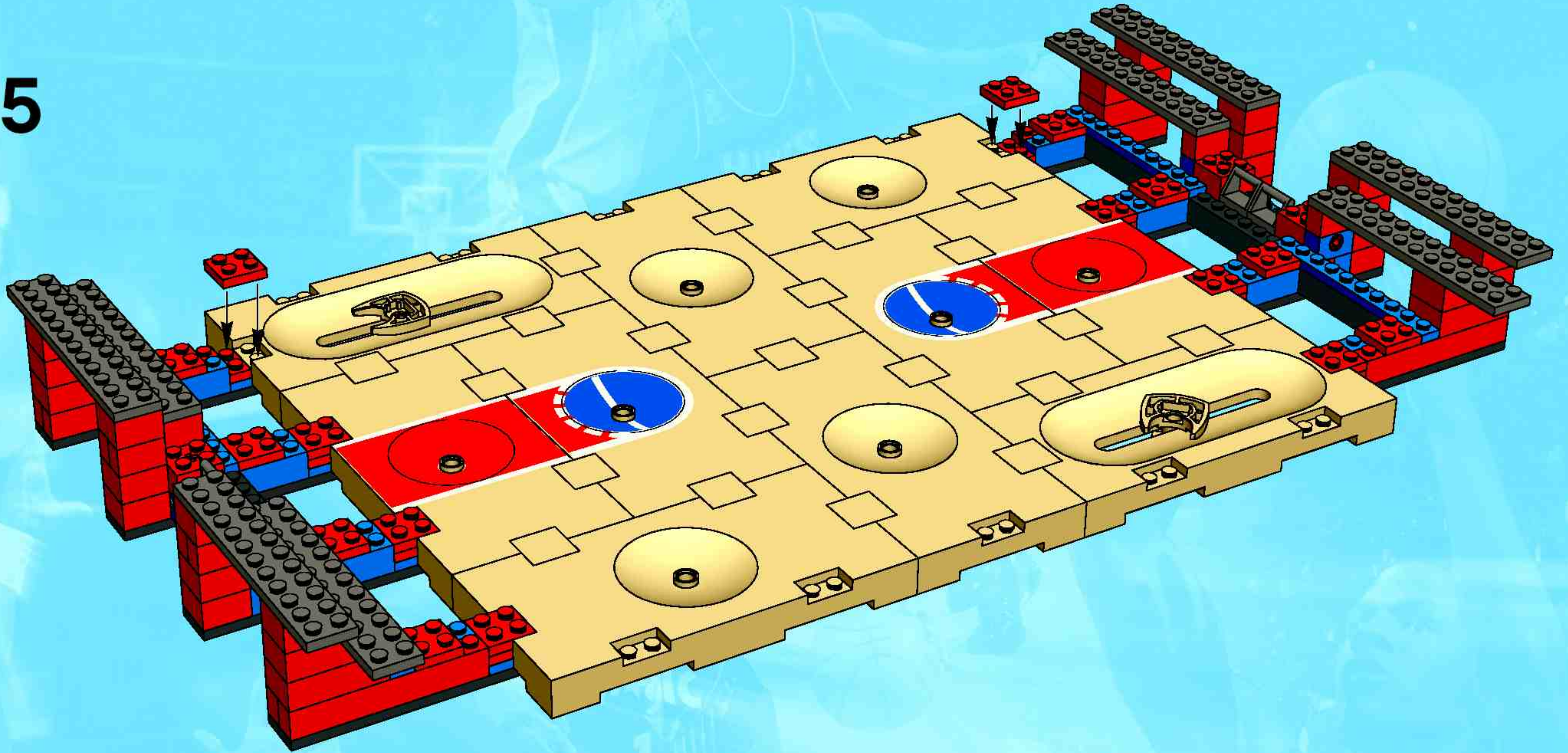



6

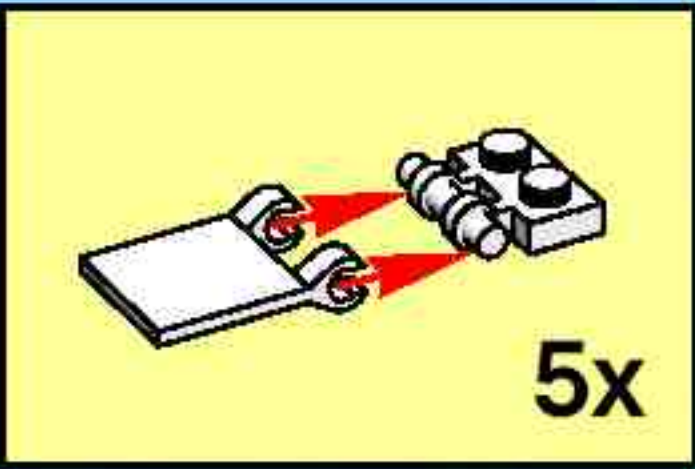
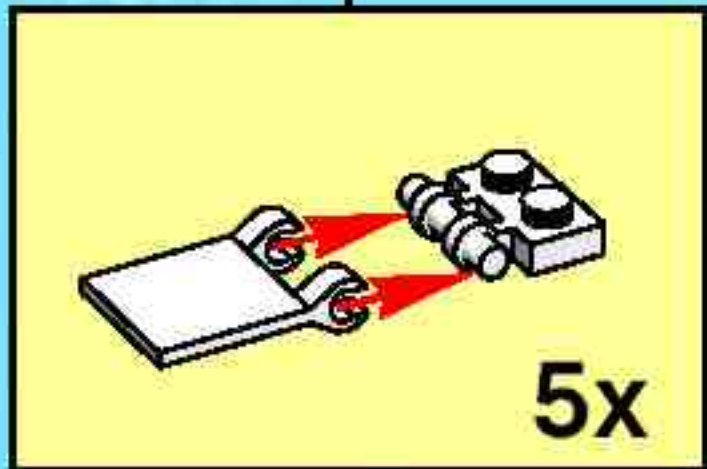
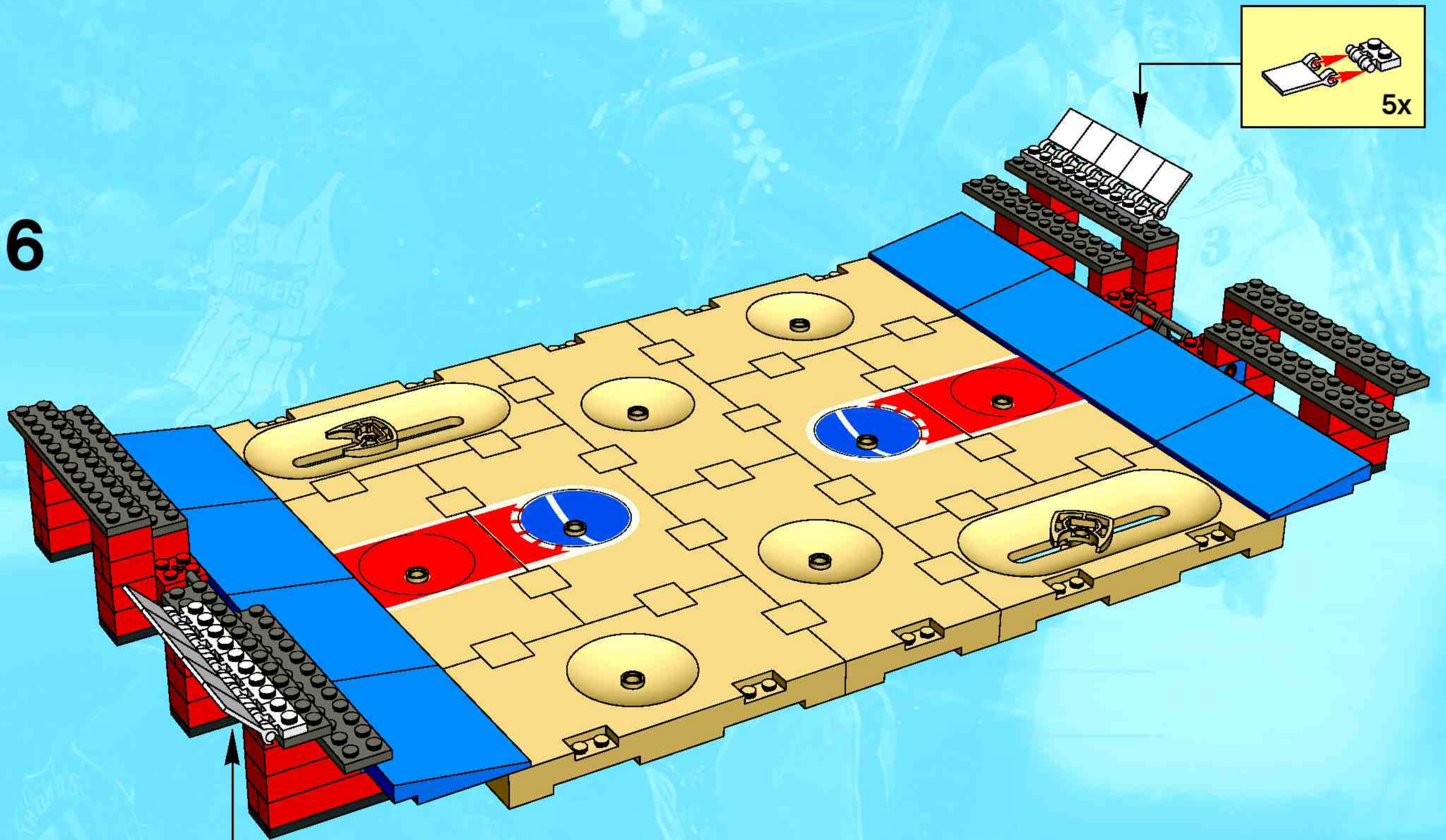



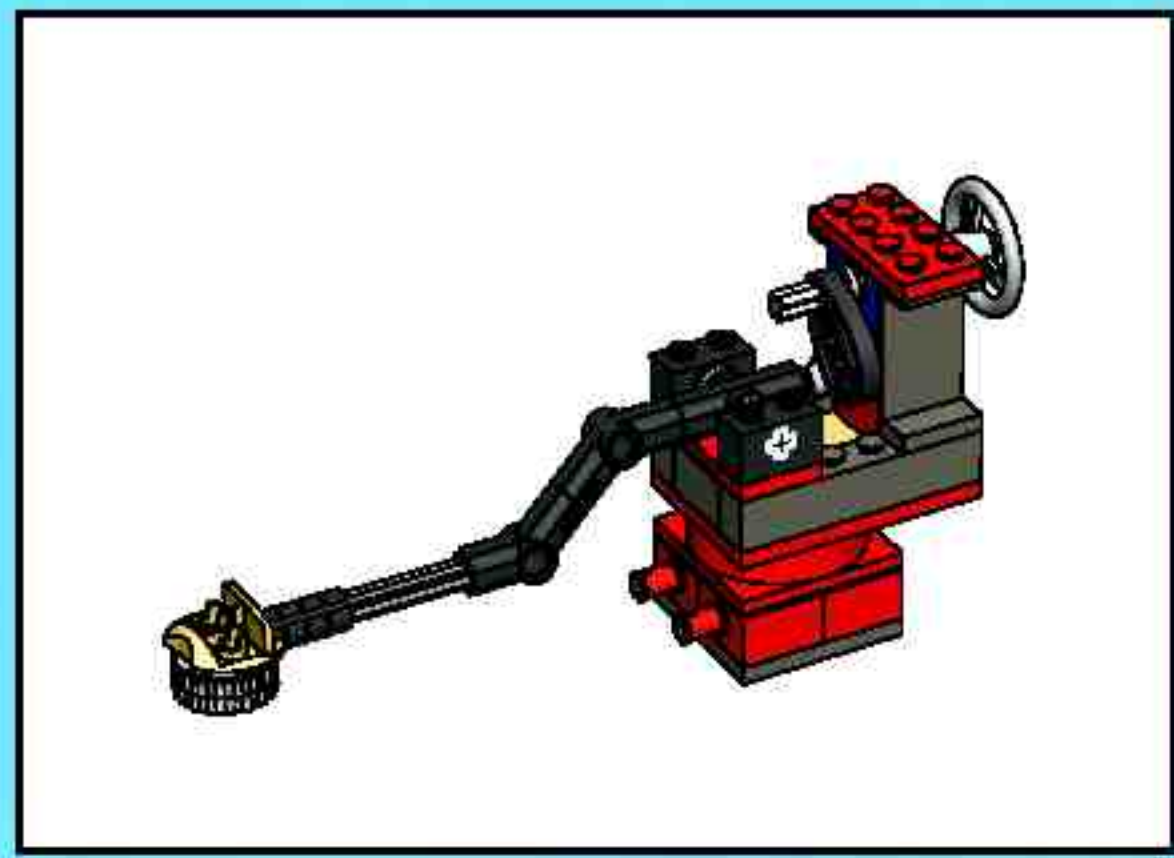

1

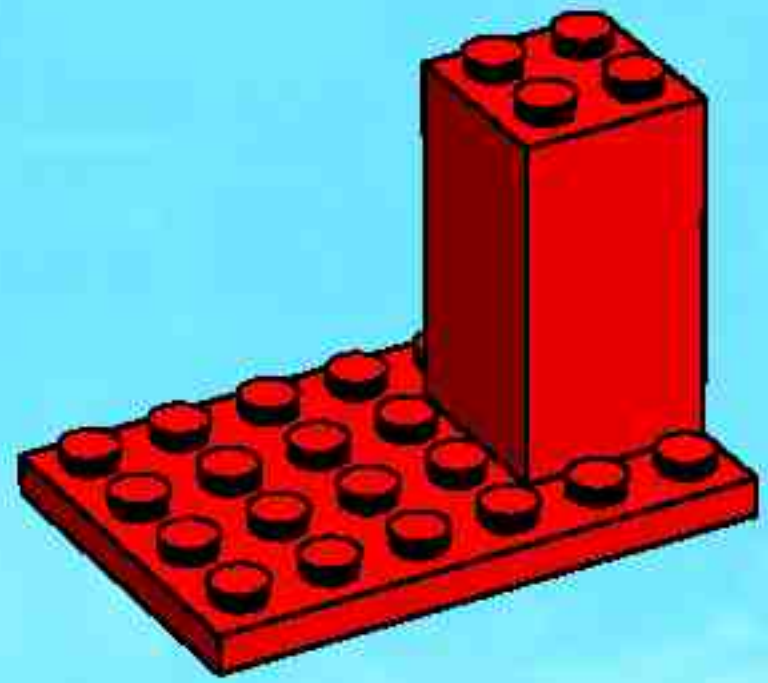

2

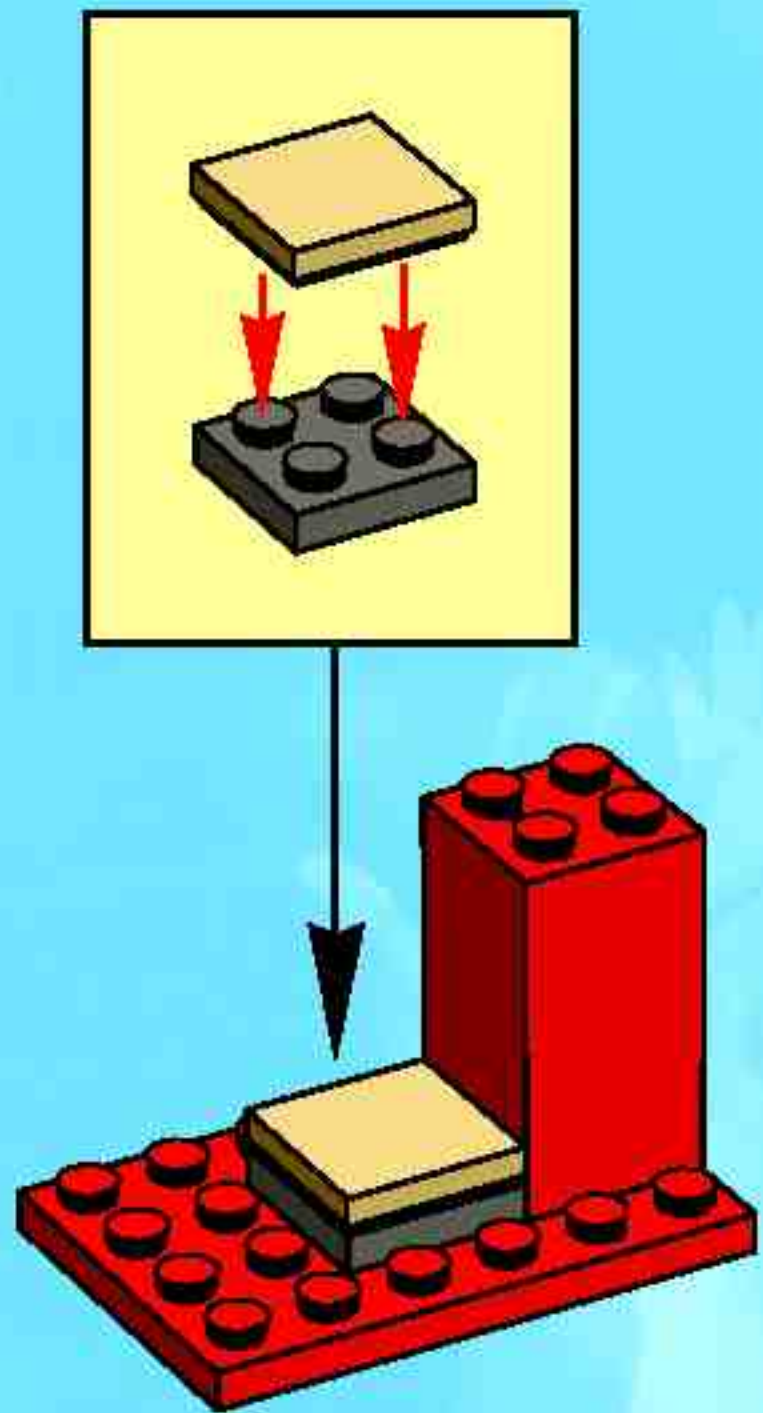

3

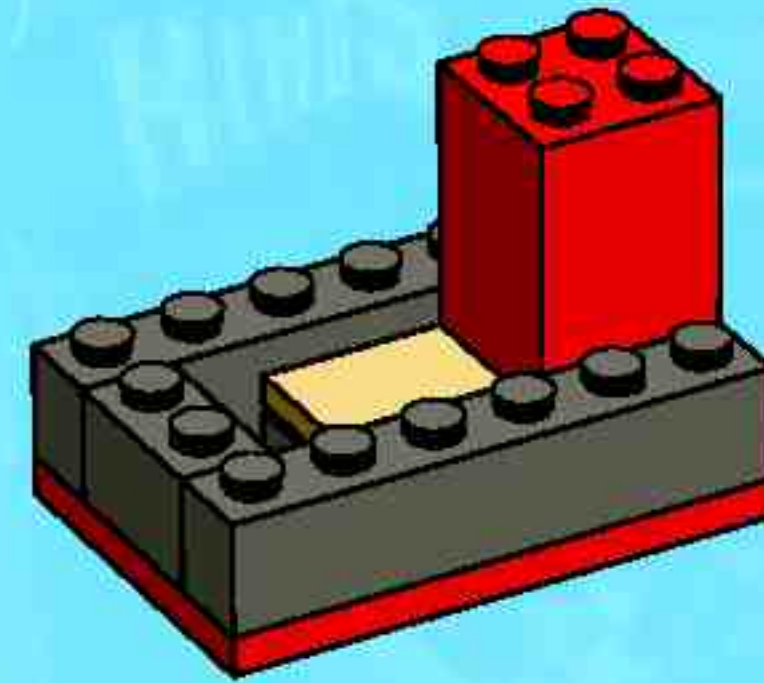

4

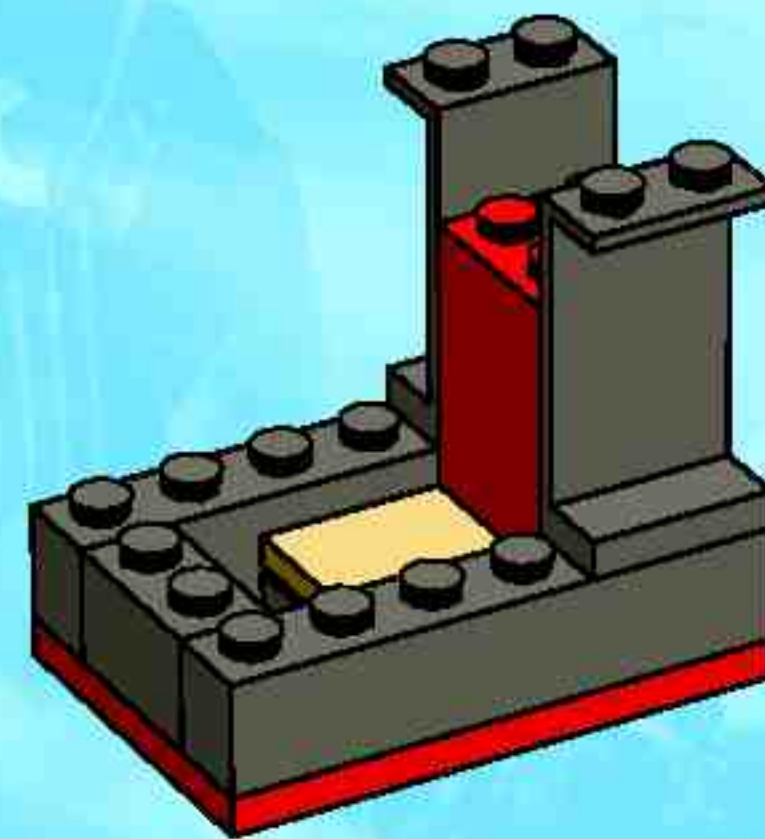

5

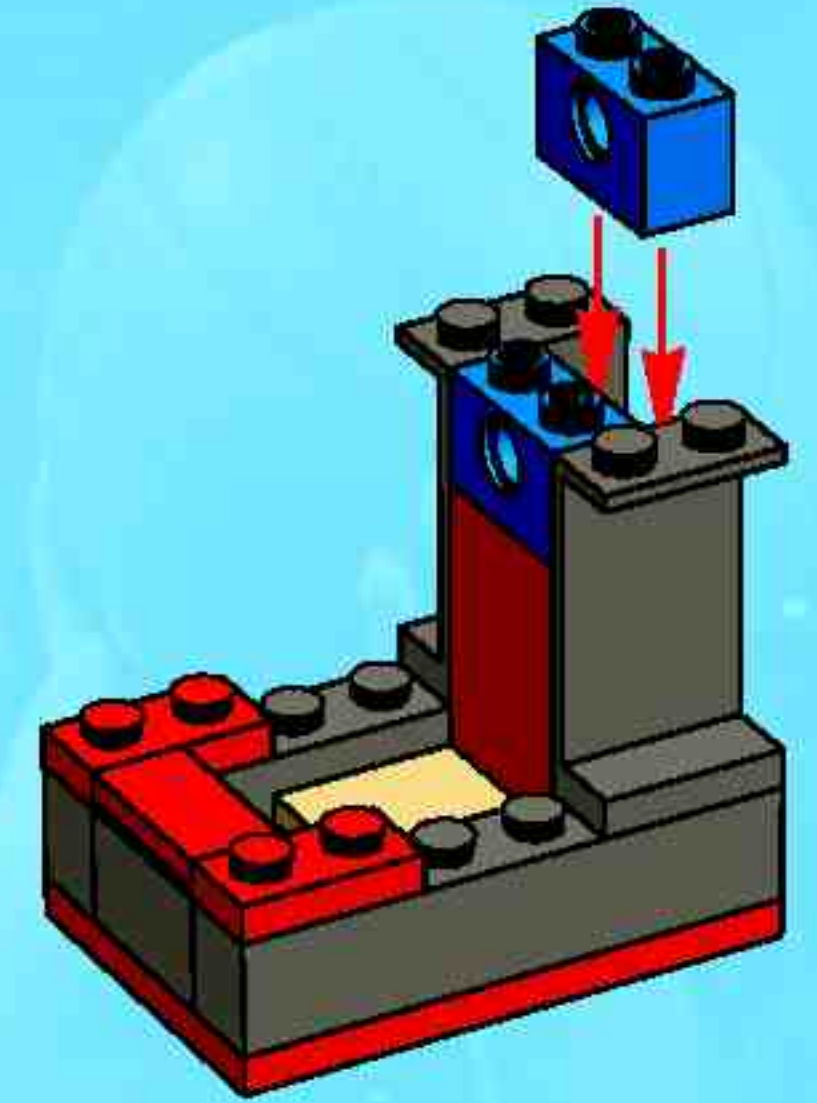

6

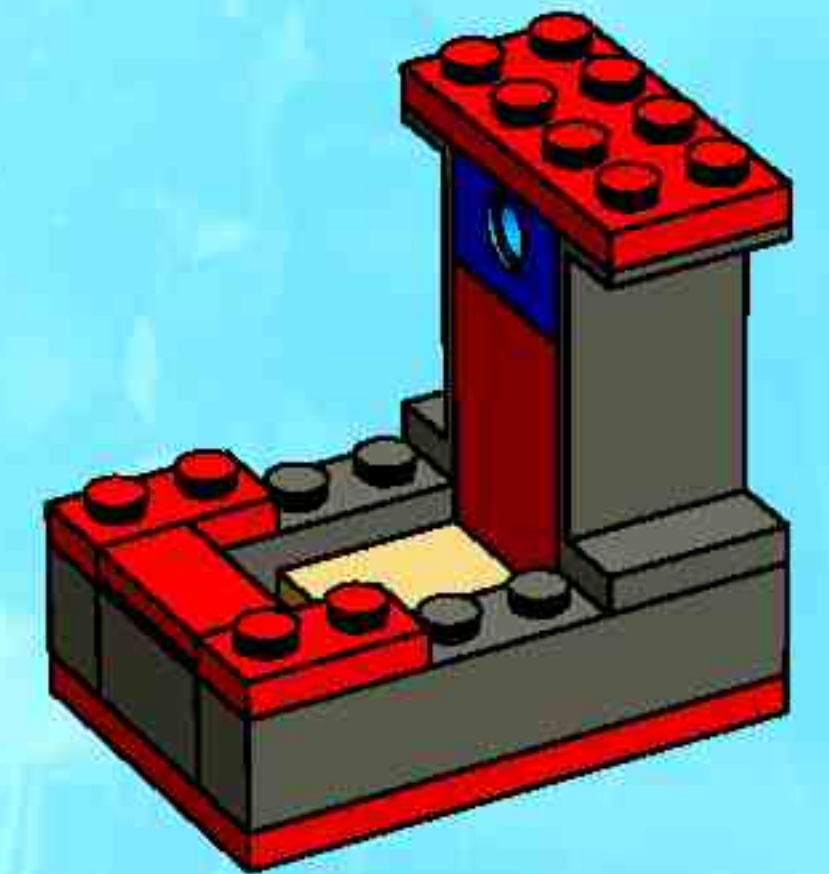



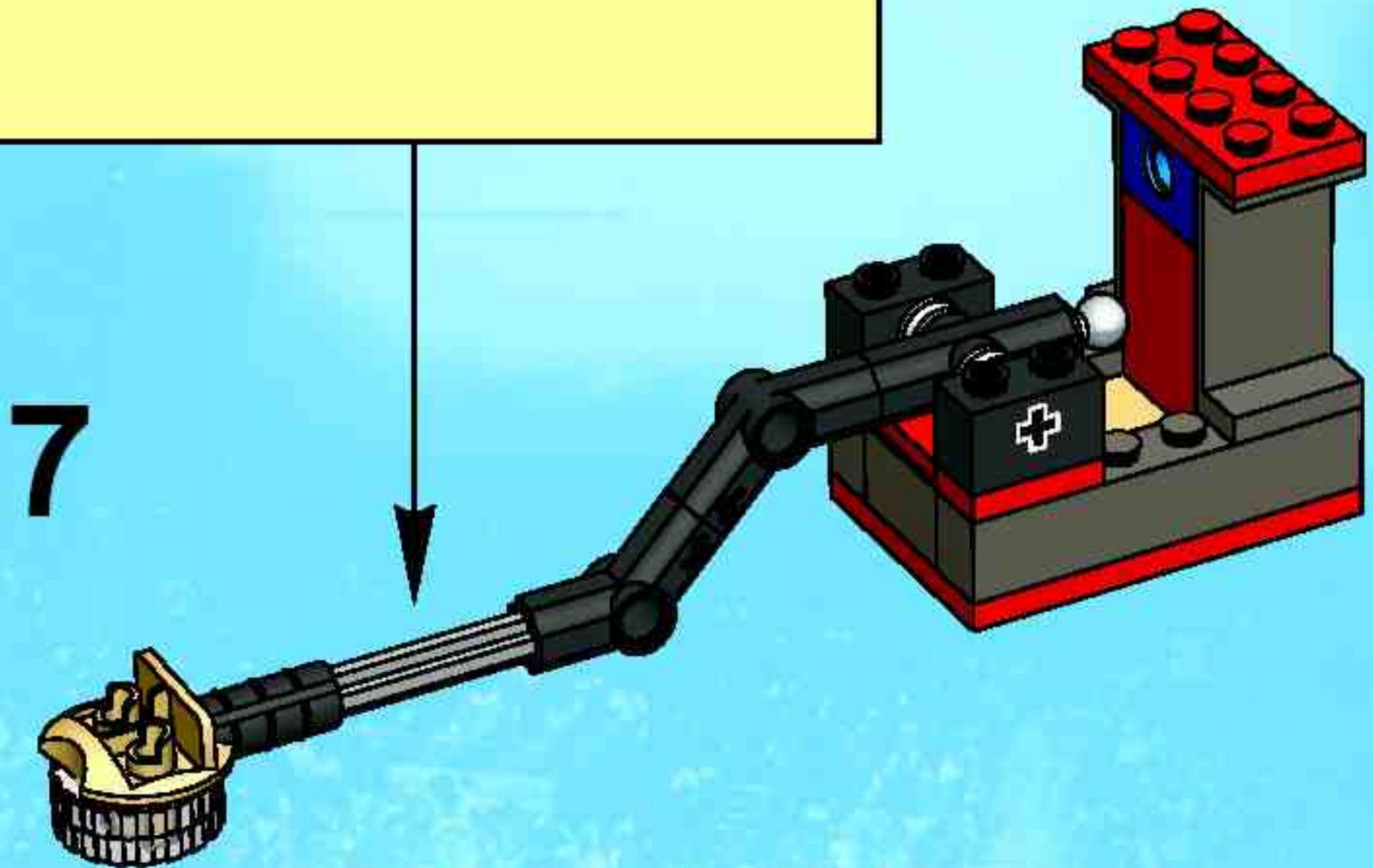
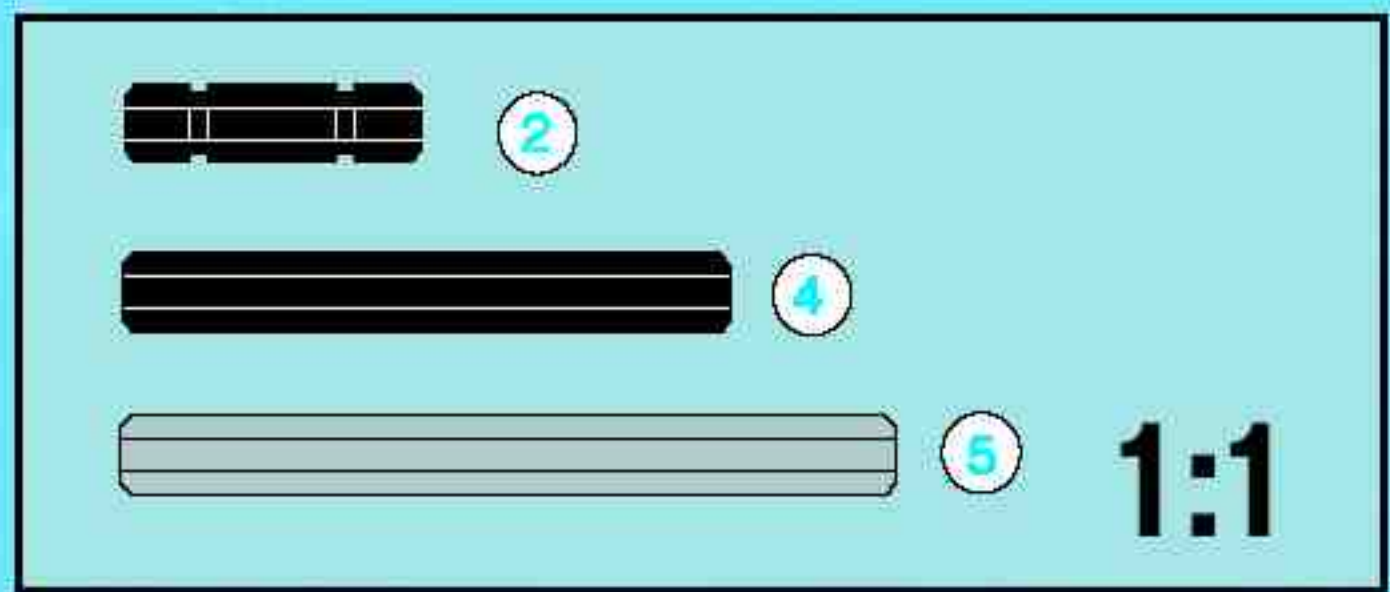
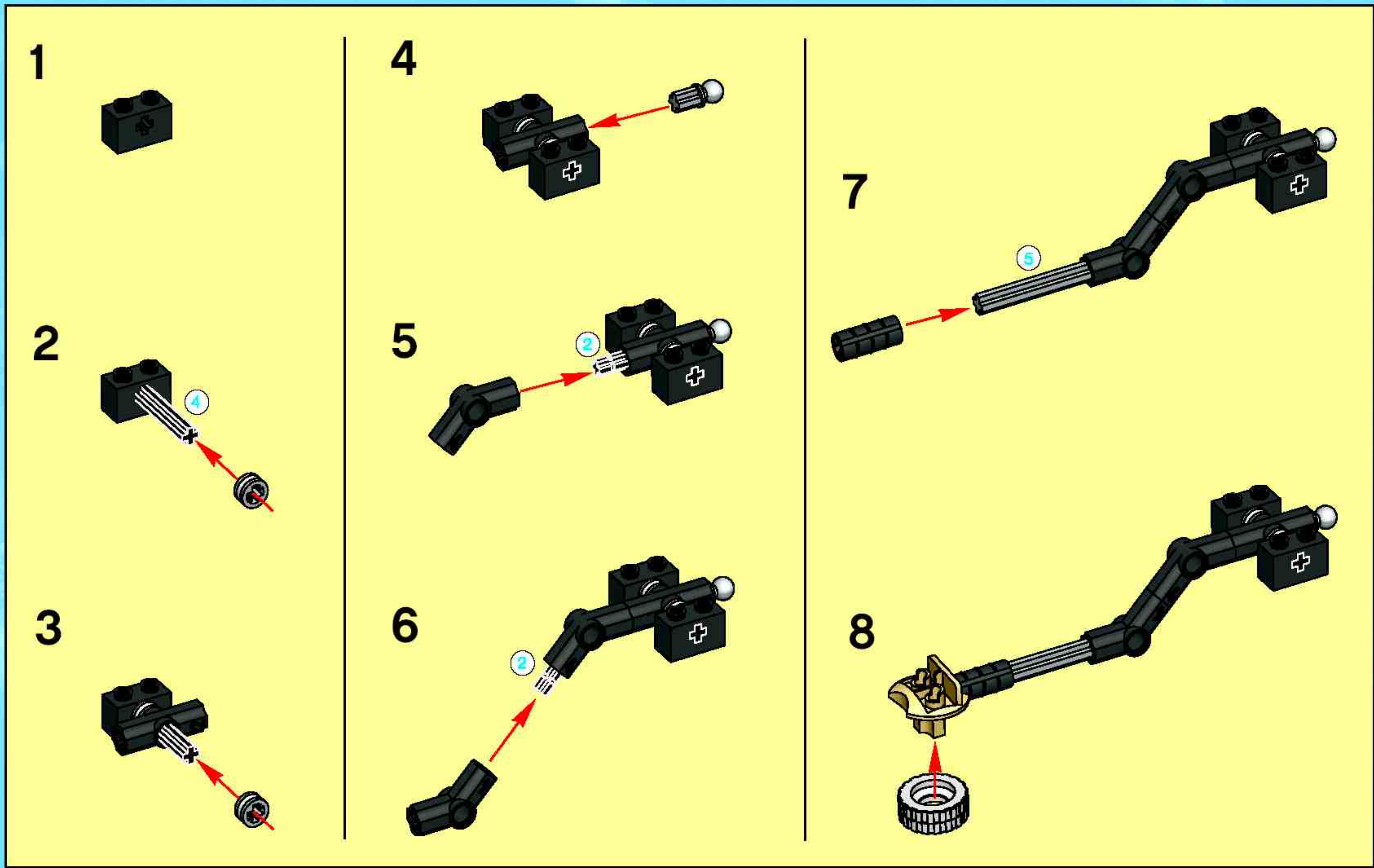



8

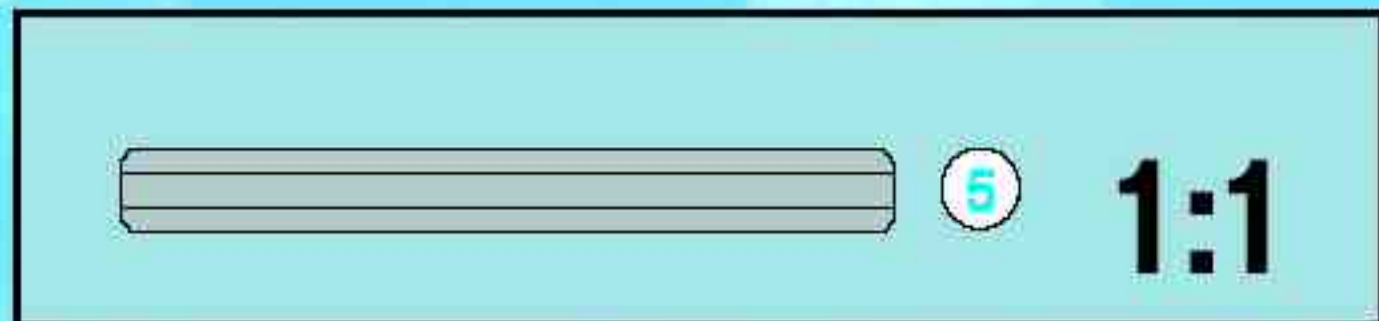
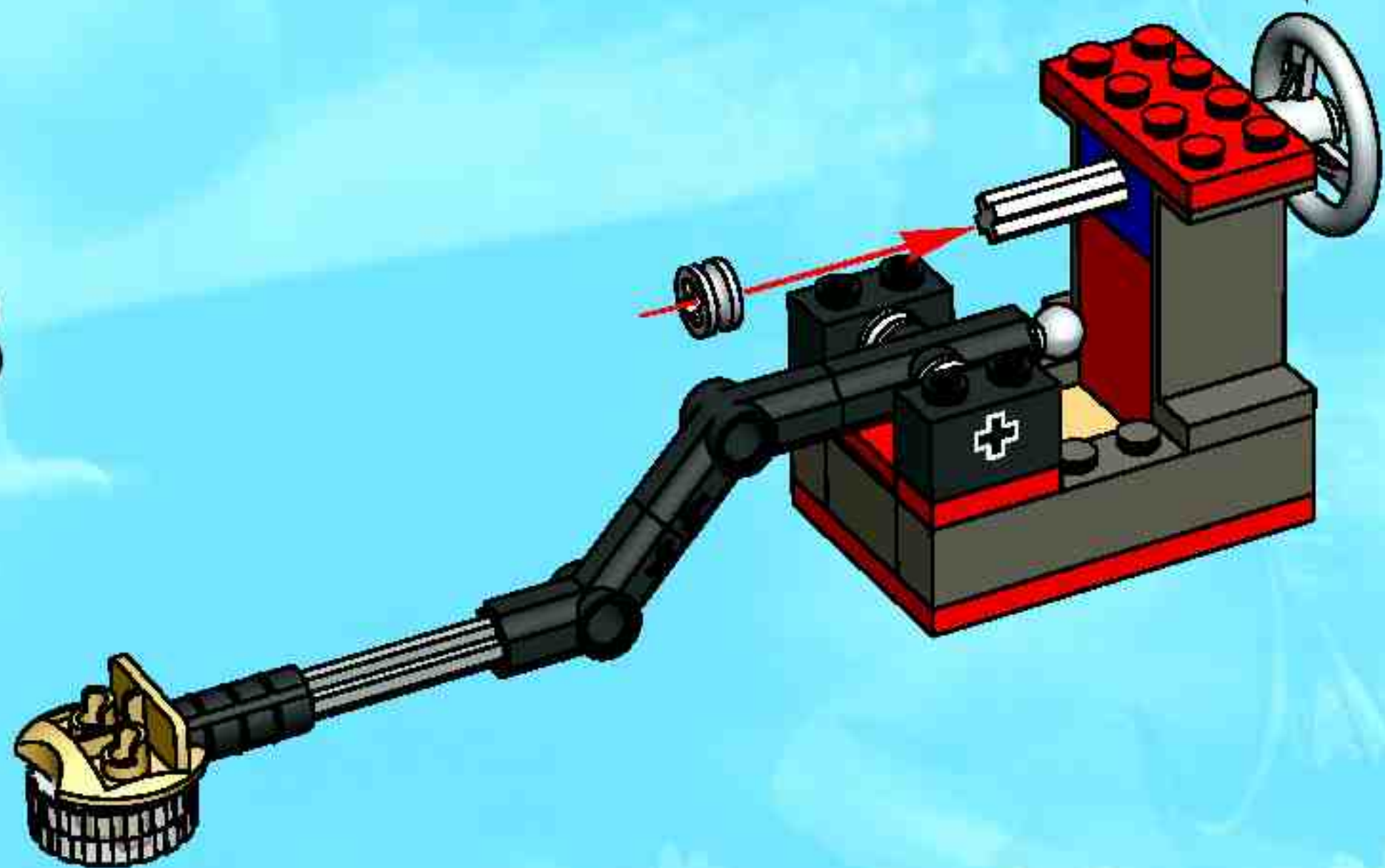
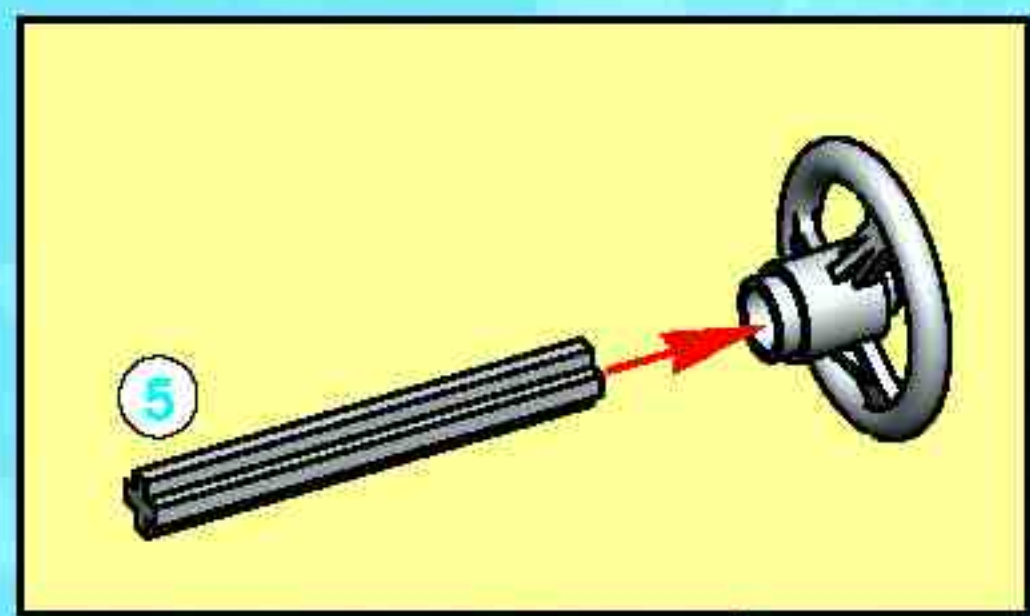

9

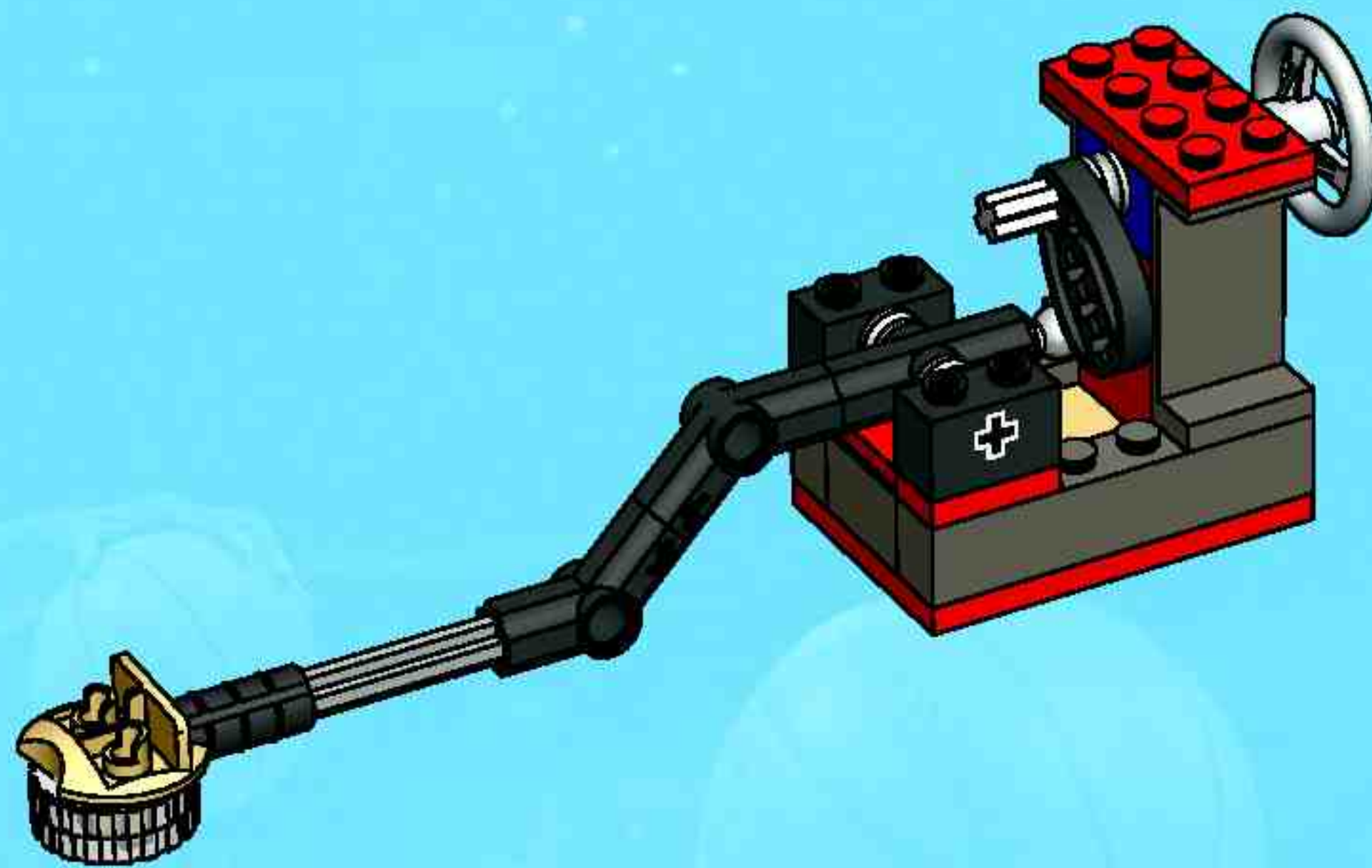

10

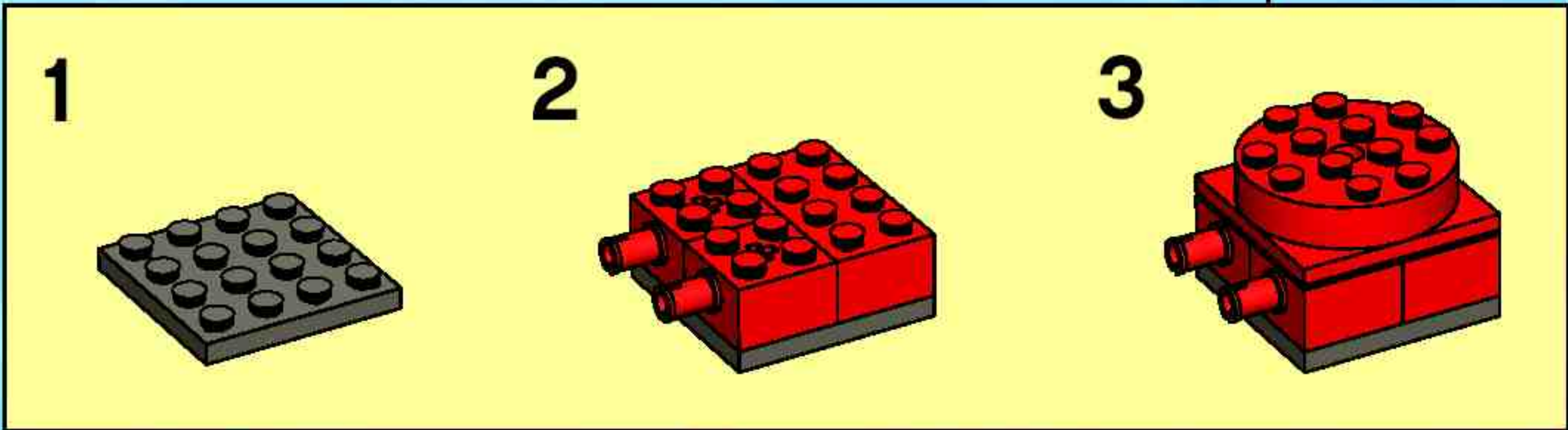
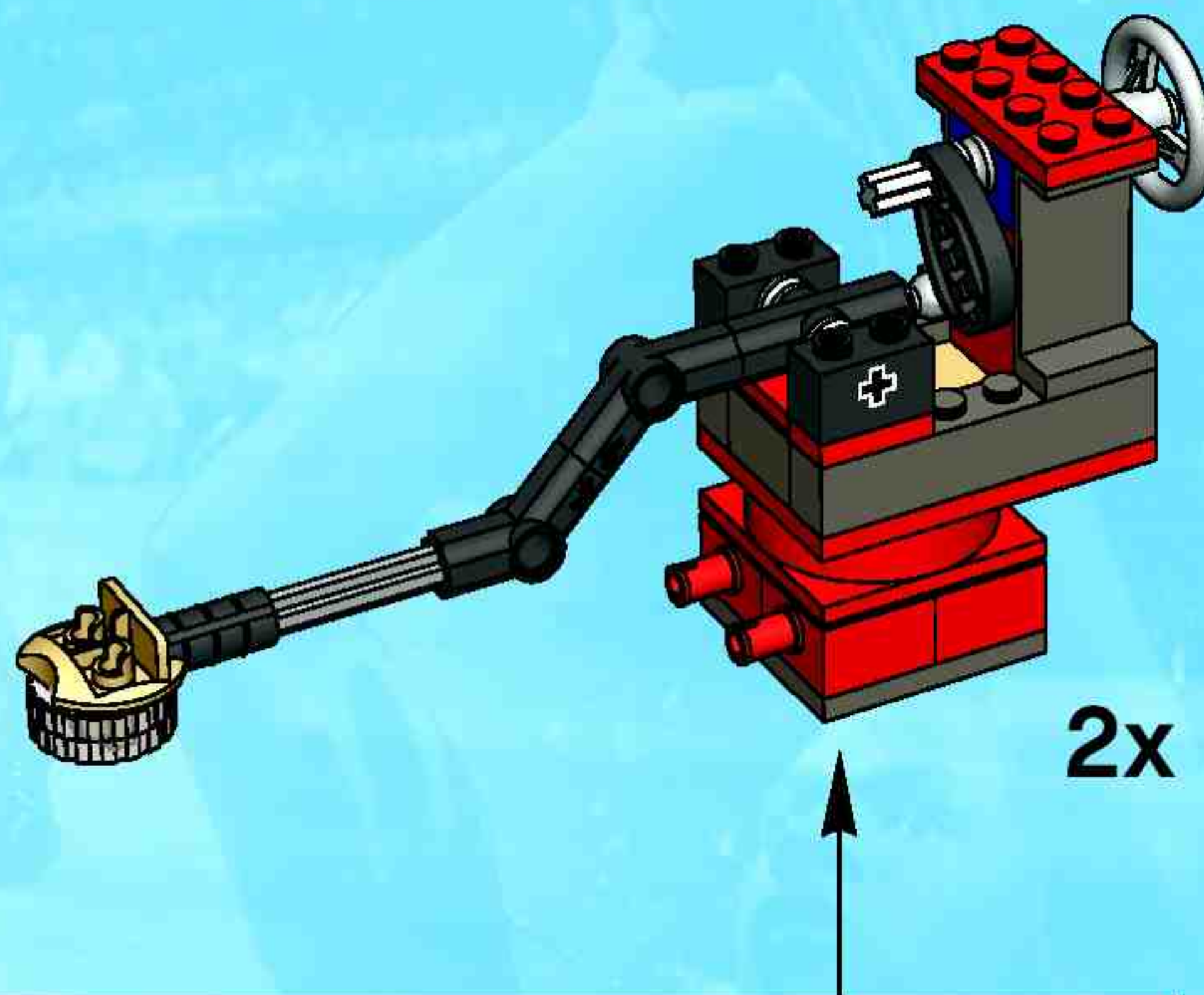



7

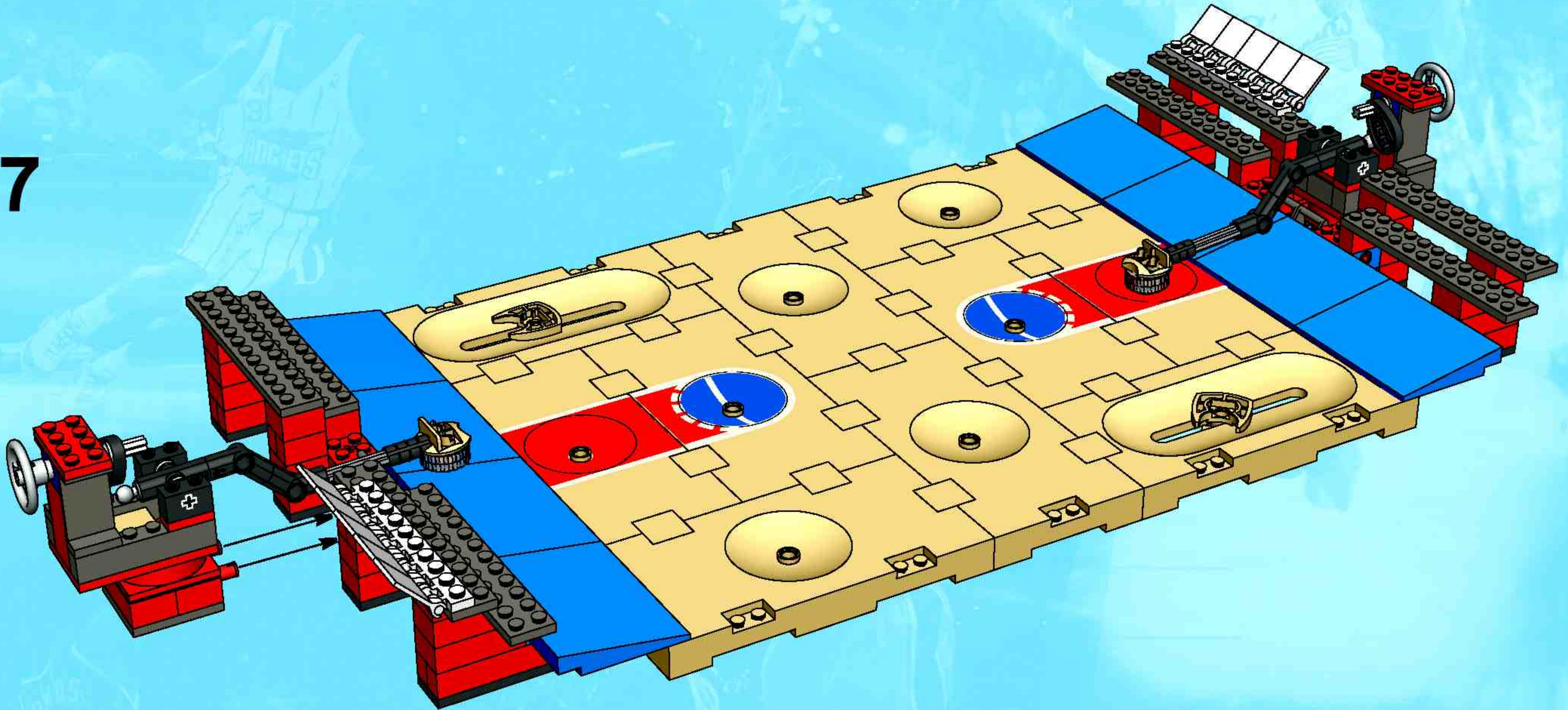



8

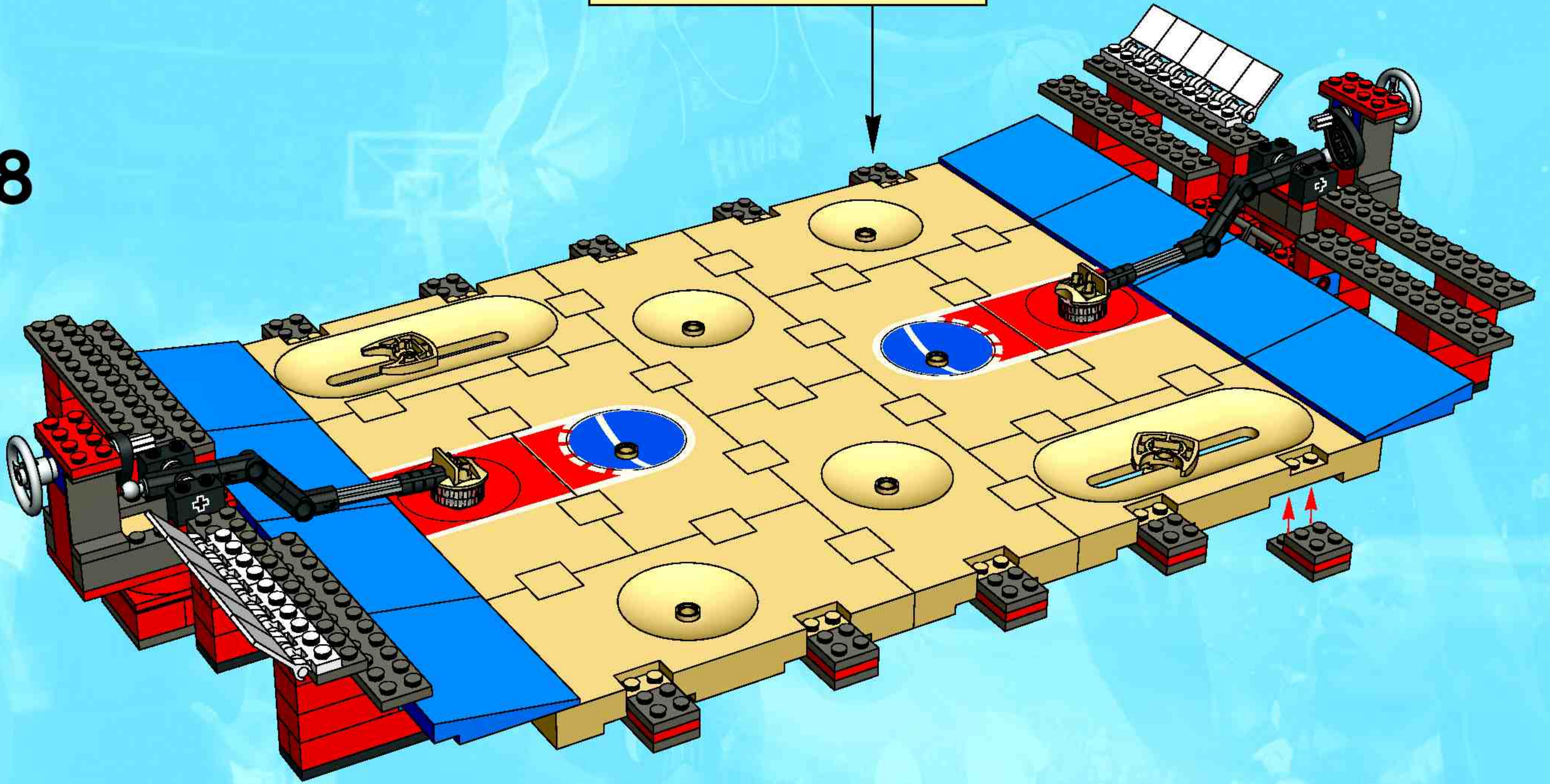
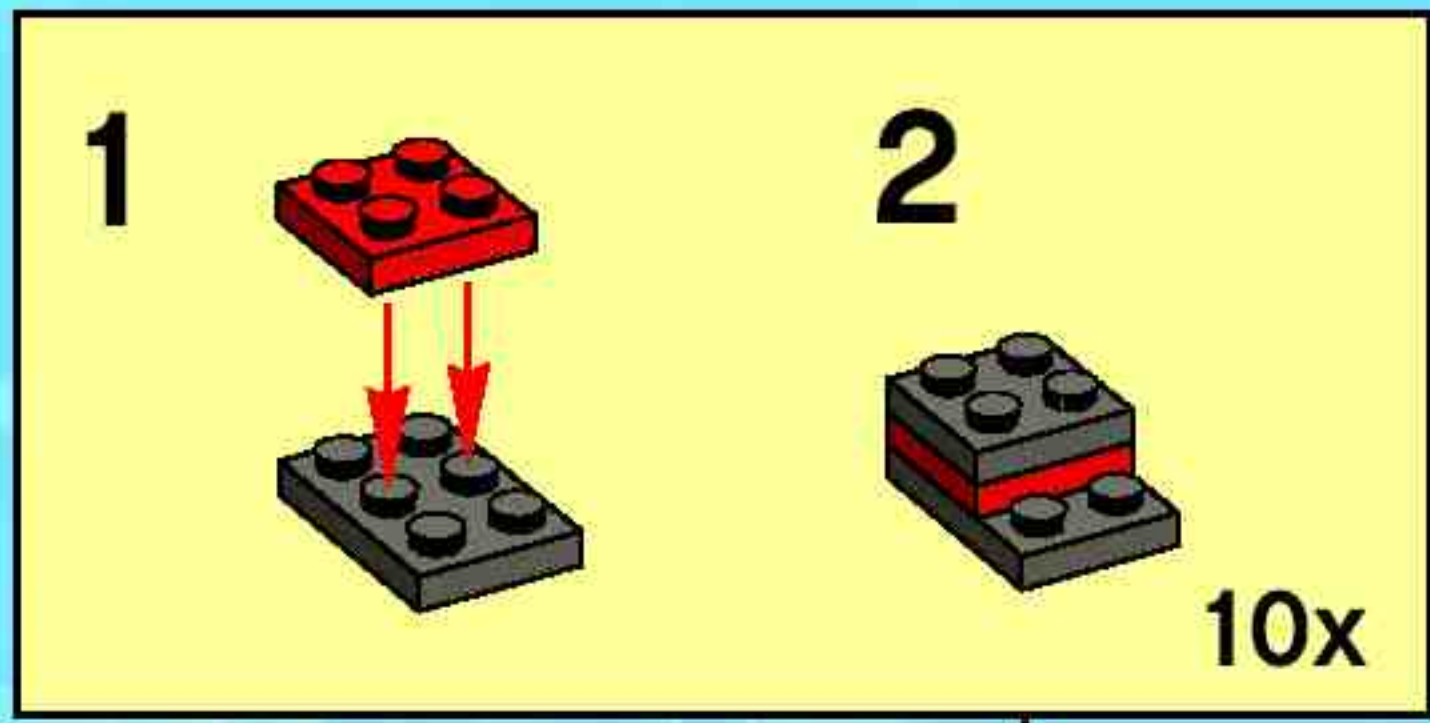



9

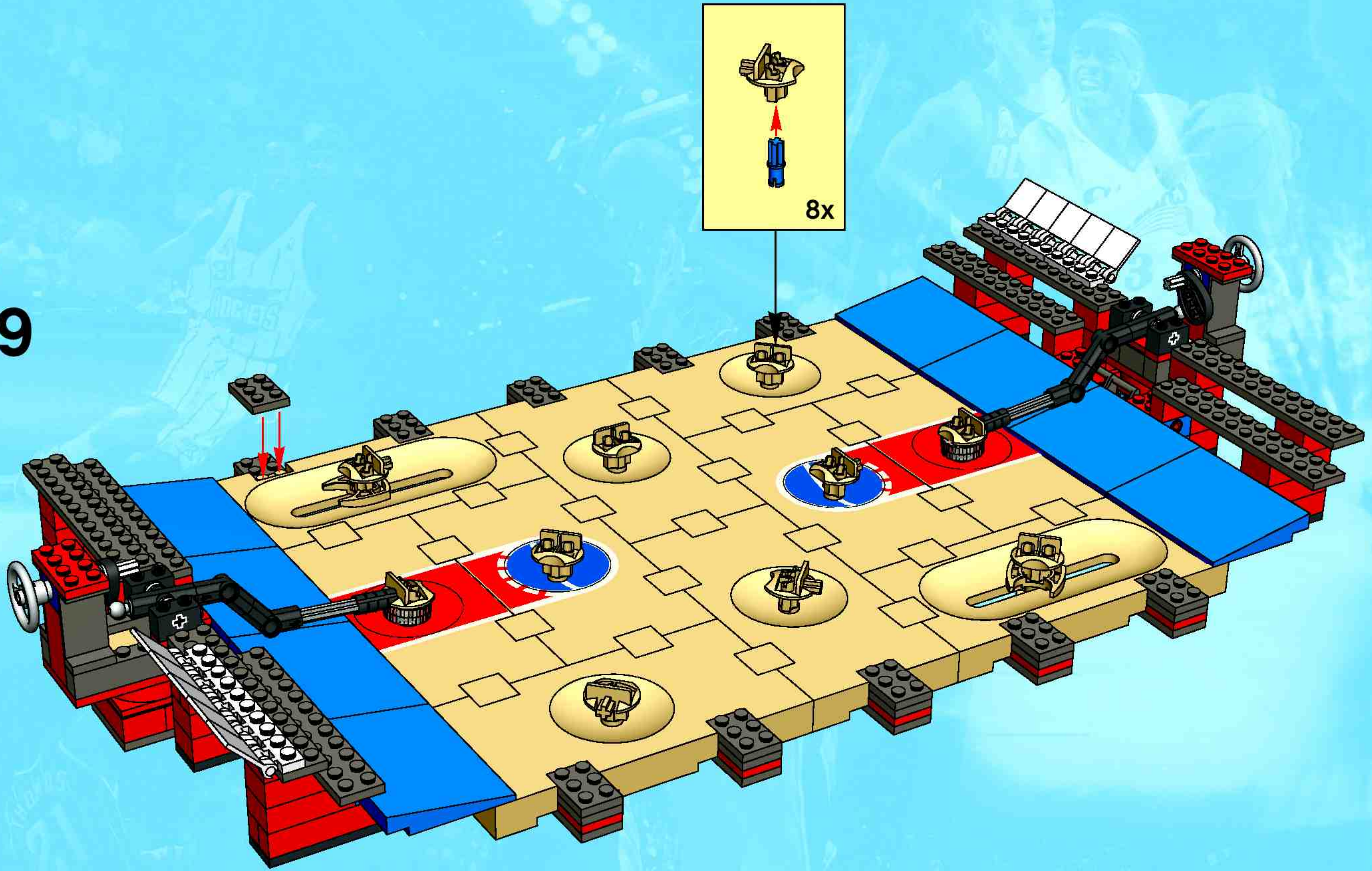



10

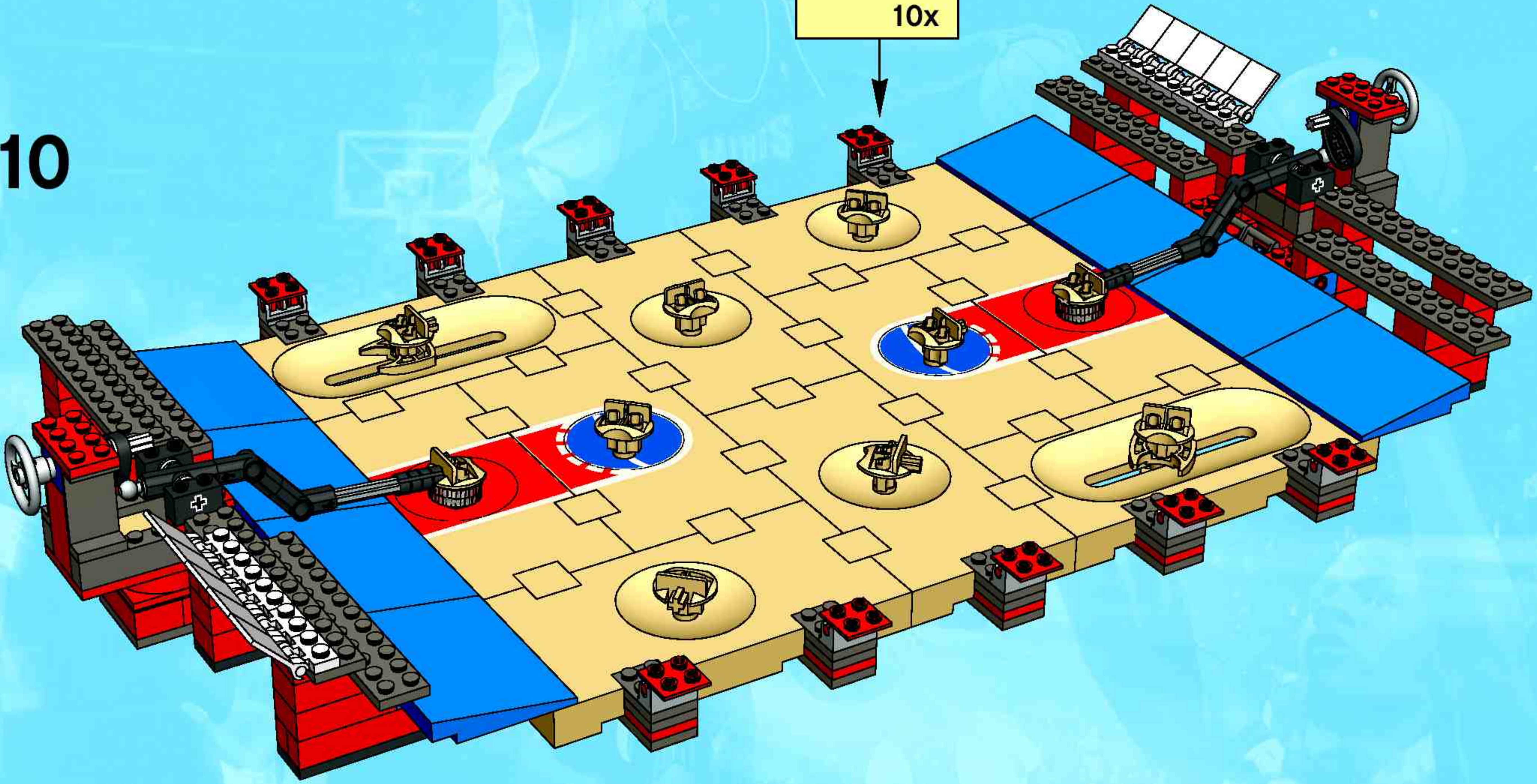
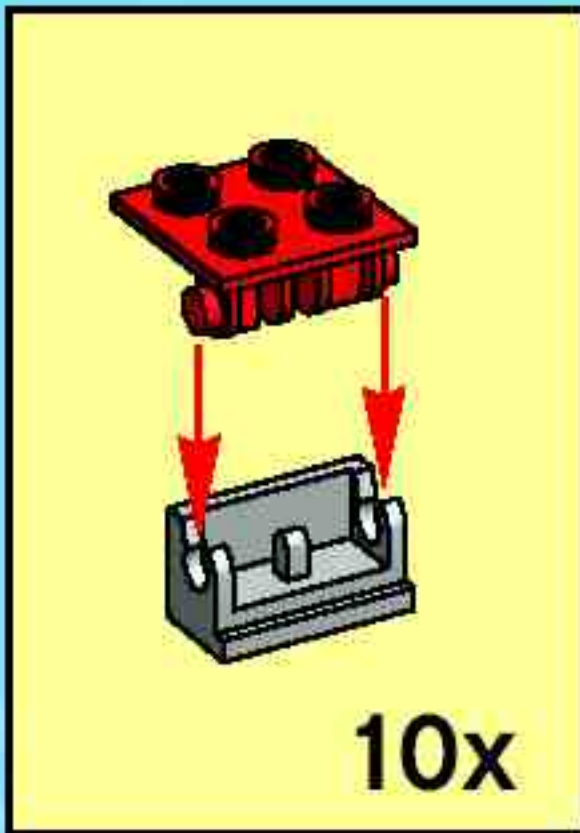



11

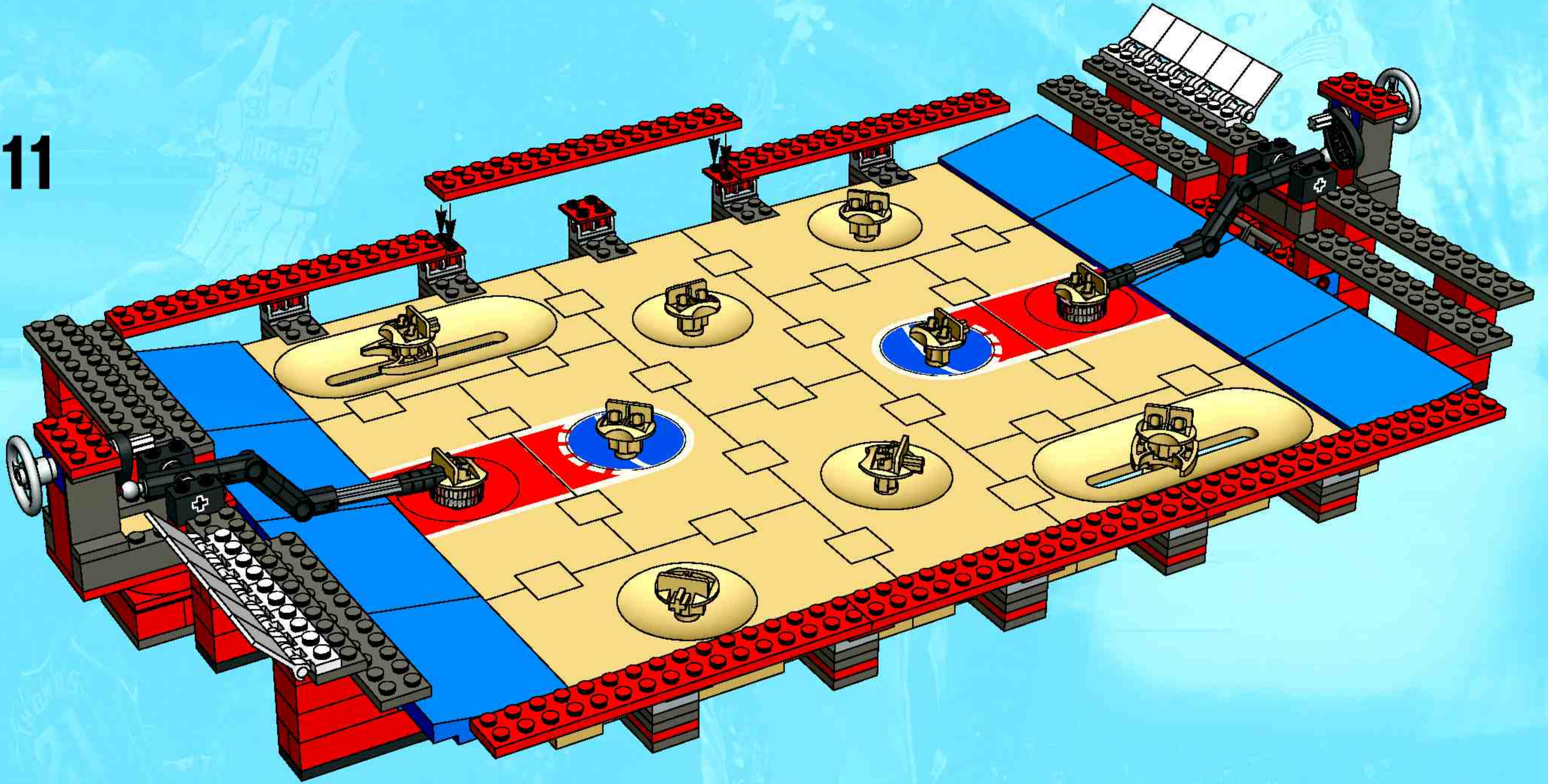



12

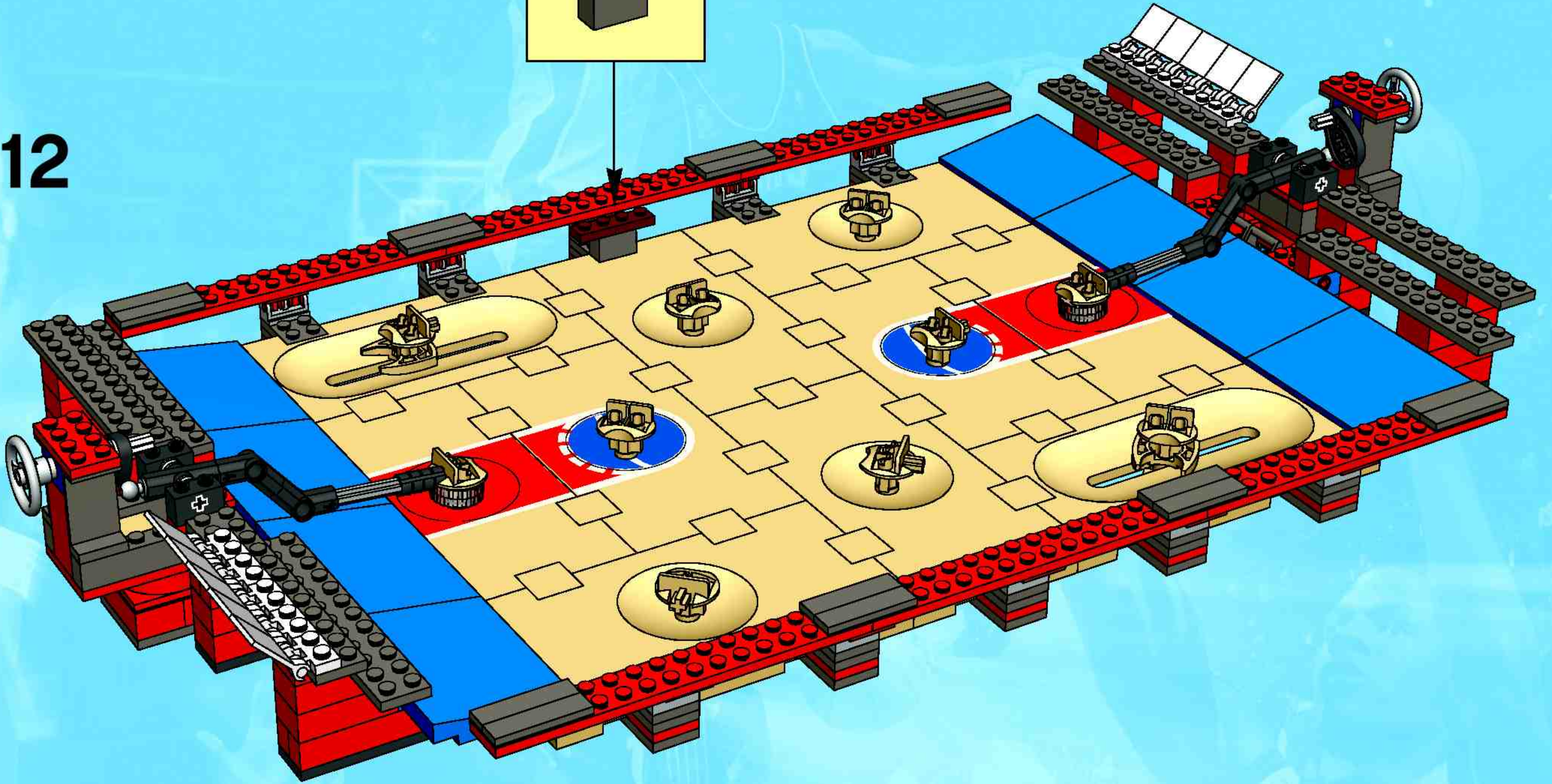
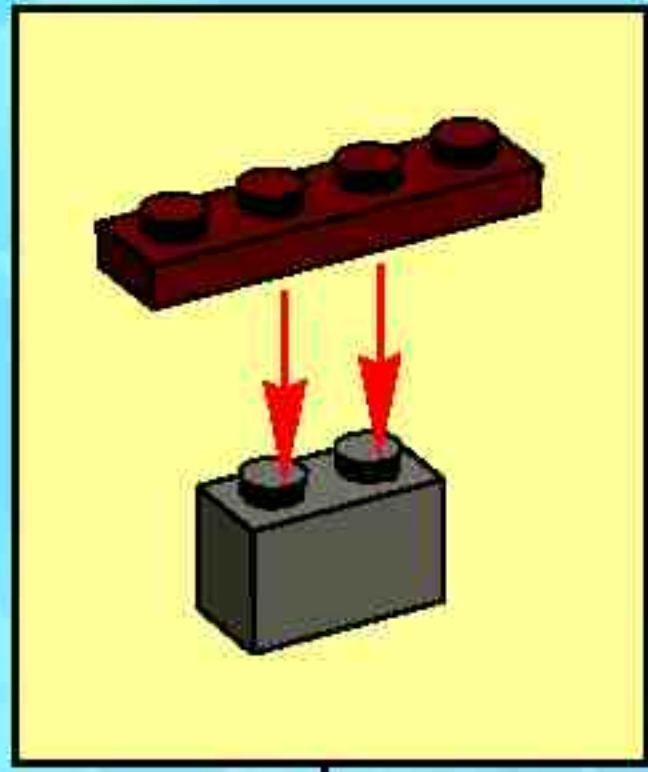



1



2

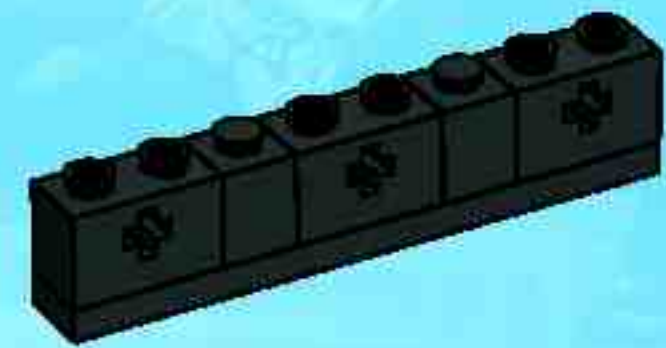

3

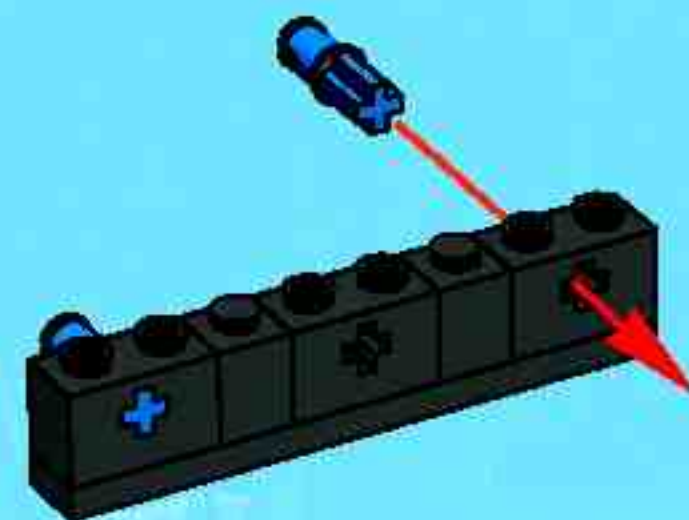

4

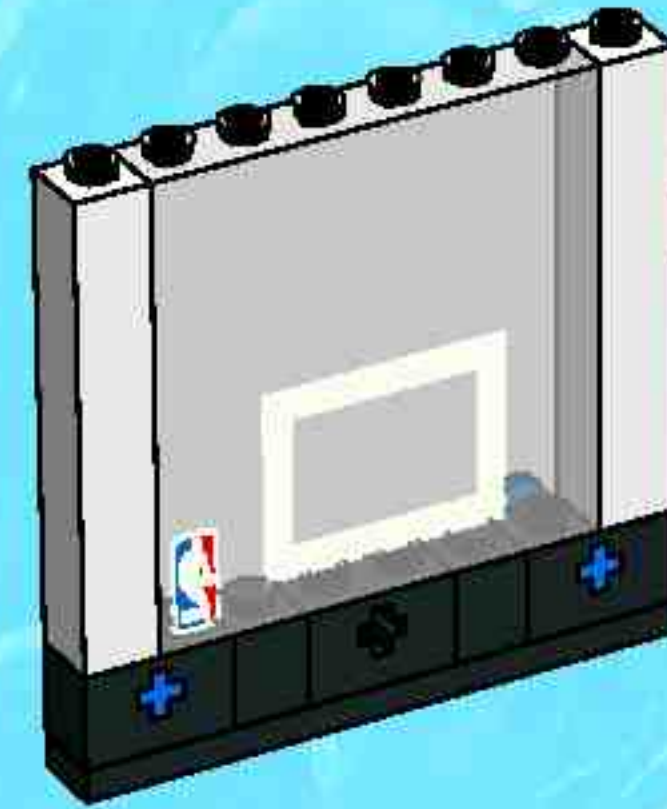

5

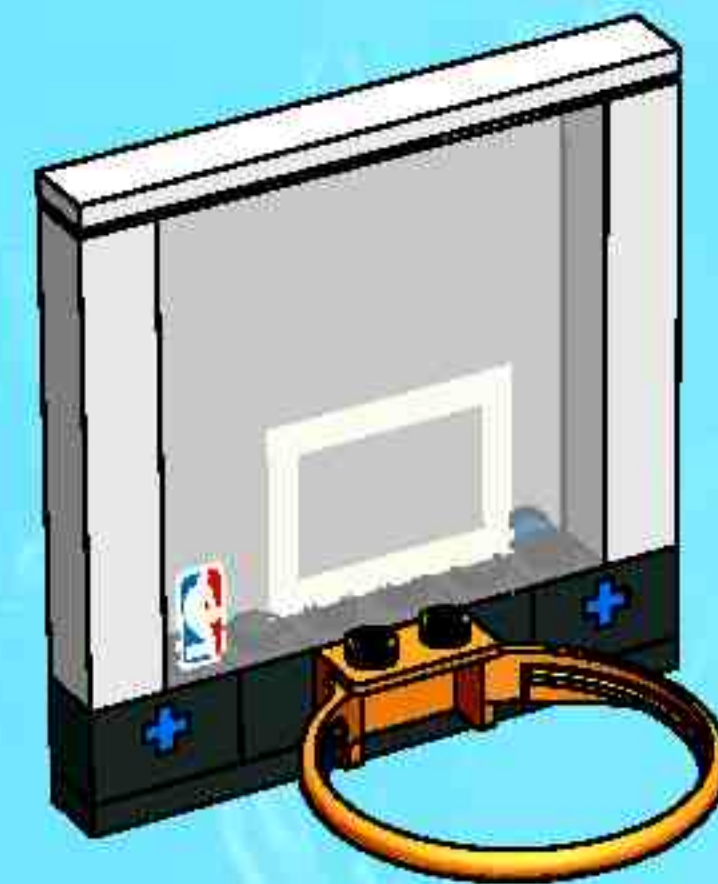

6

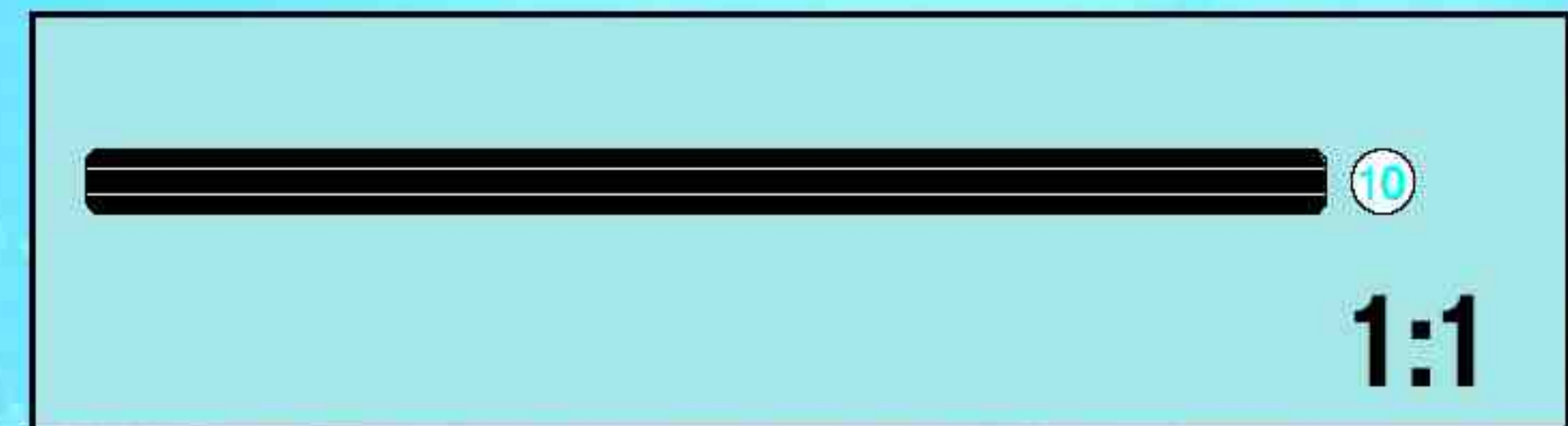
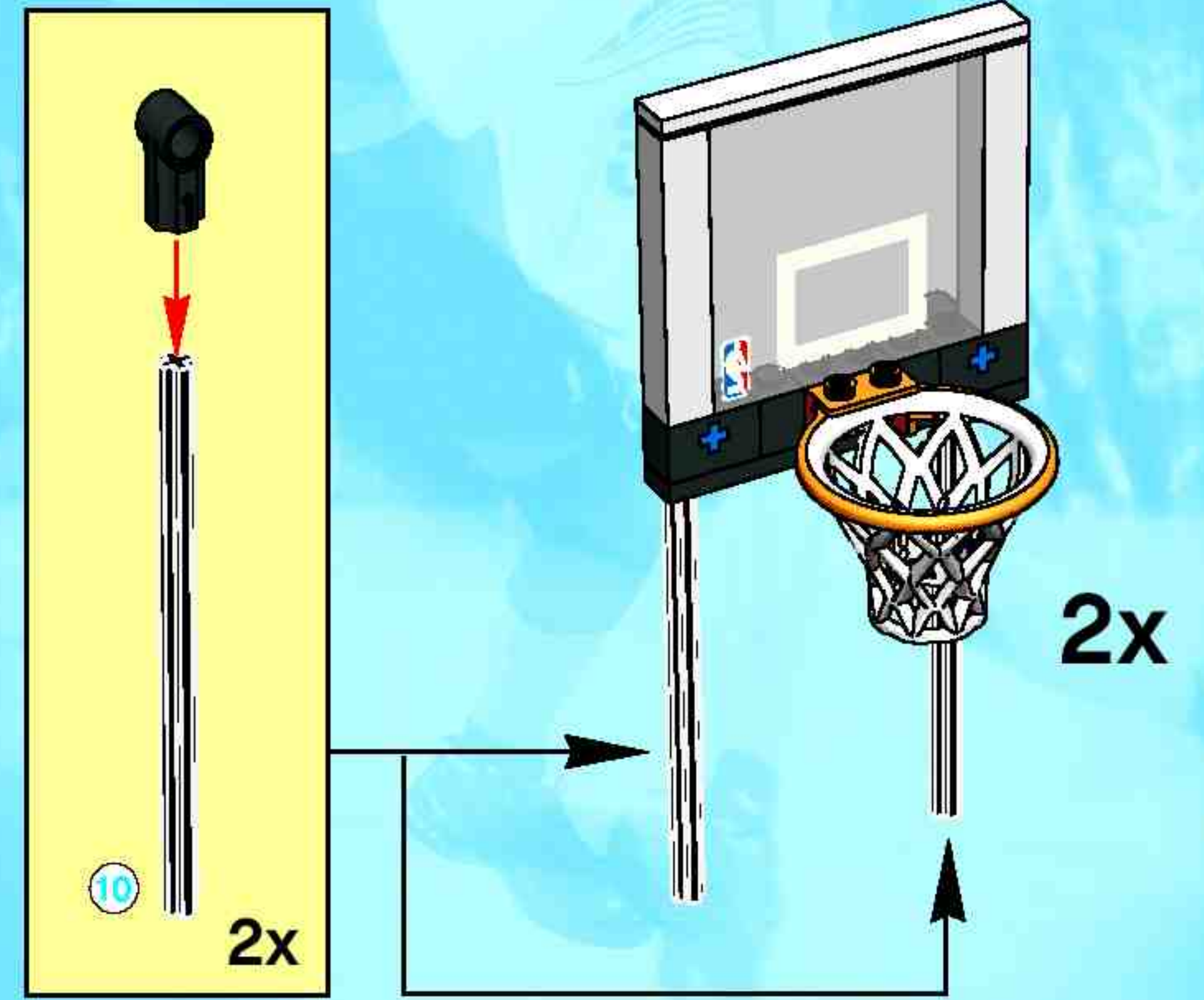



13

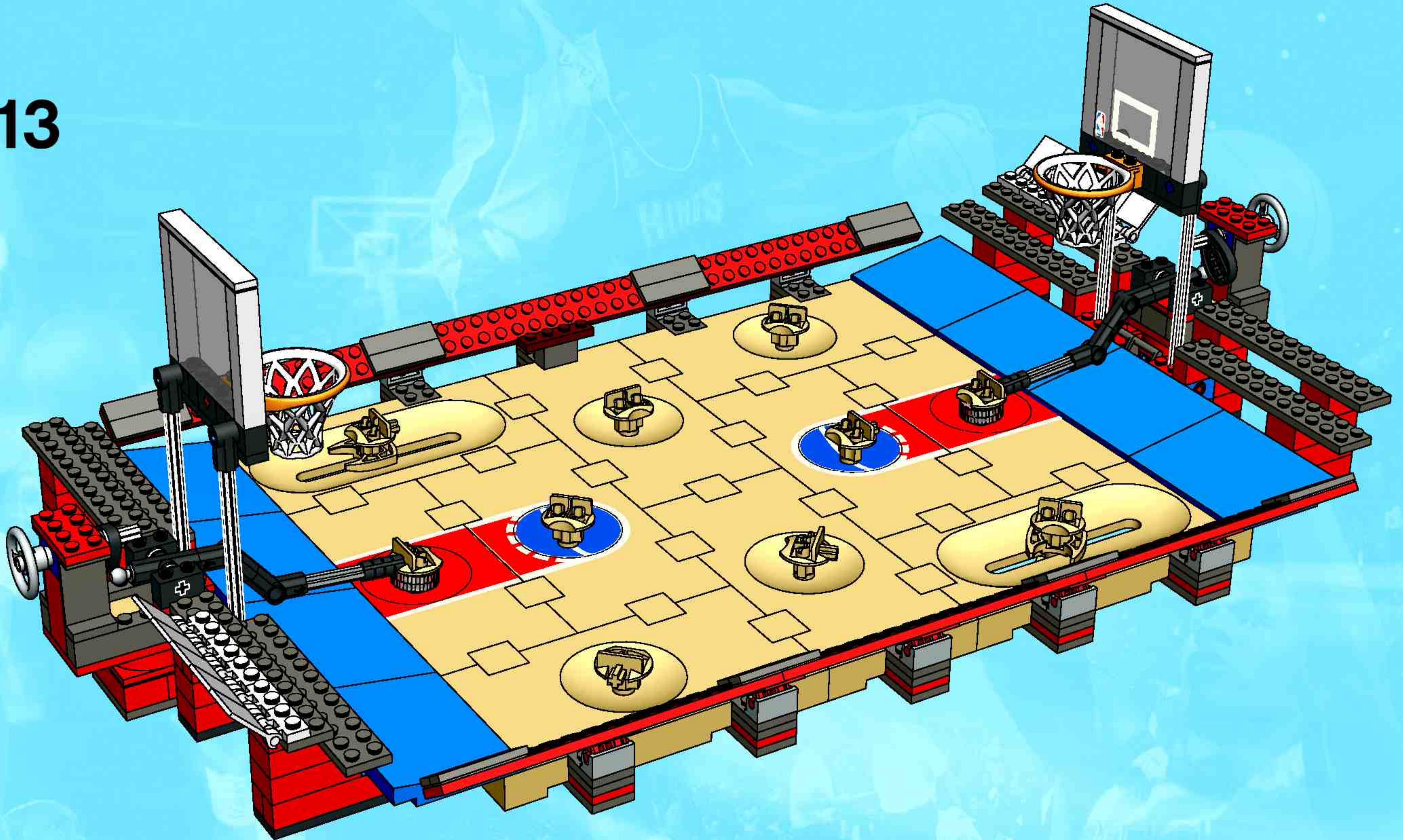









[www.LEGO.com](http://www.LEGO.com)

**NBA.COM**







#3428



#3428

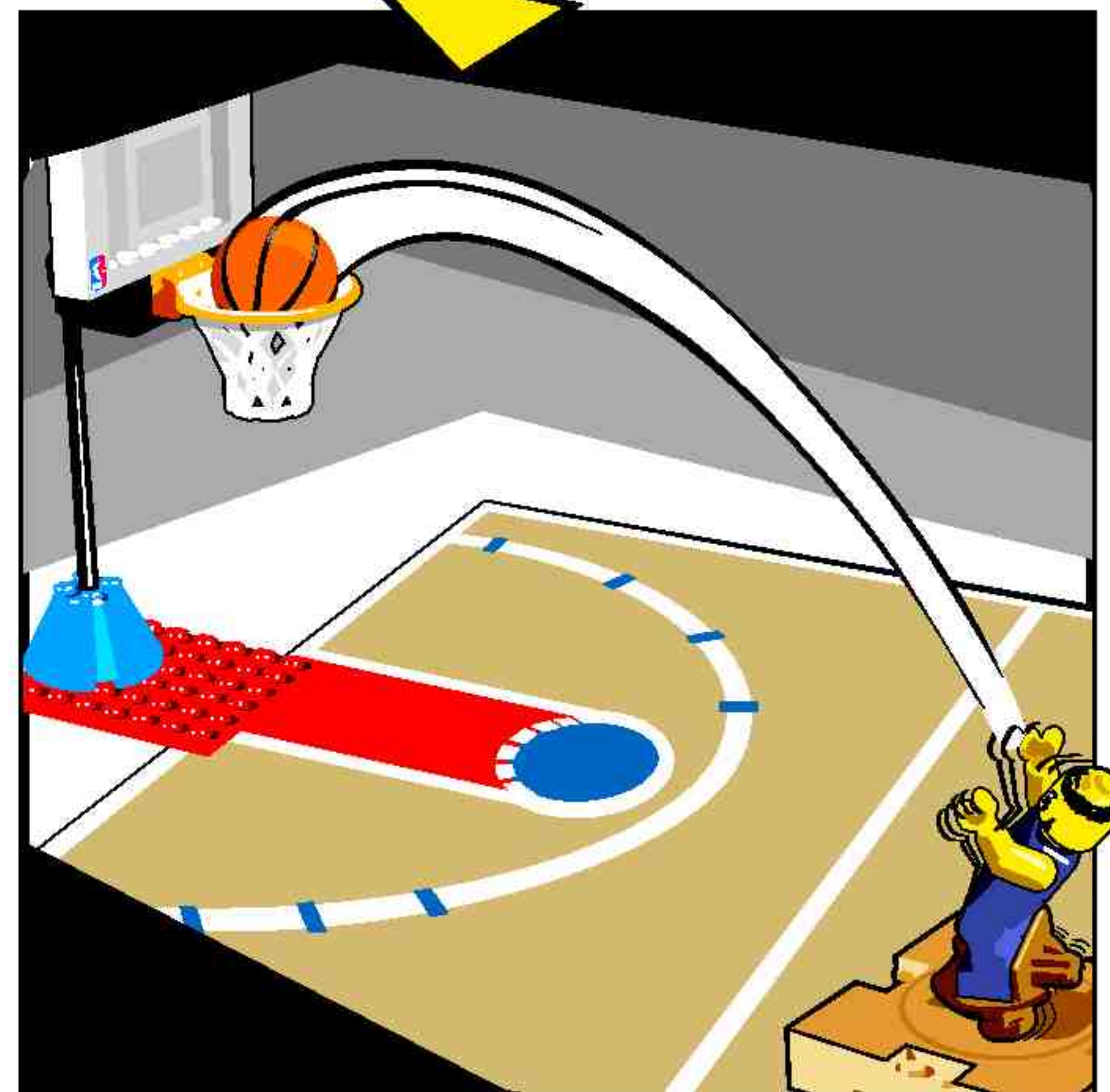



#3427 + #3428





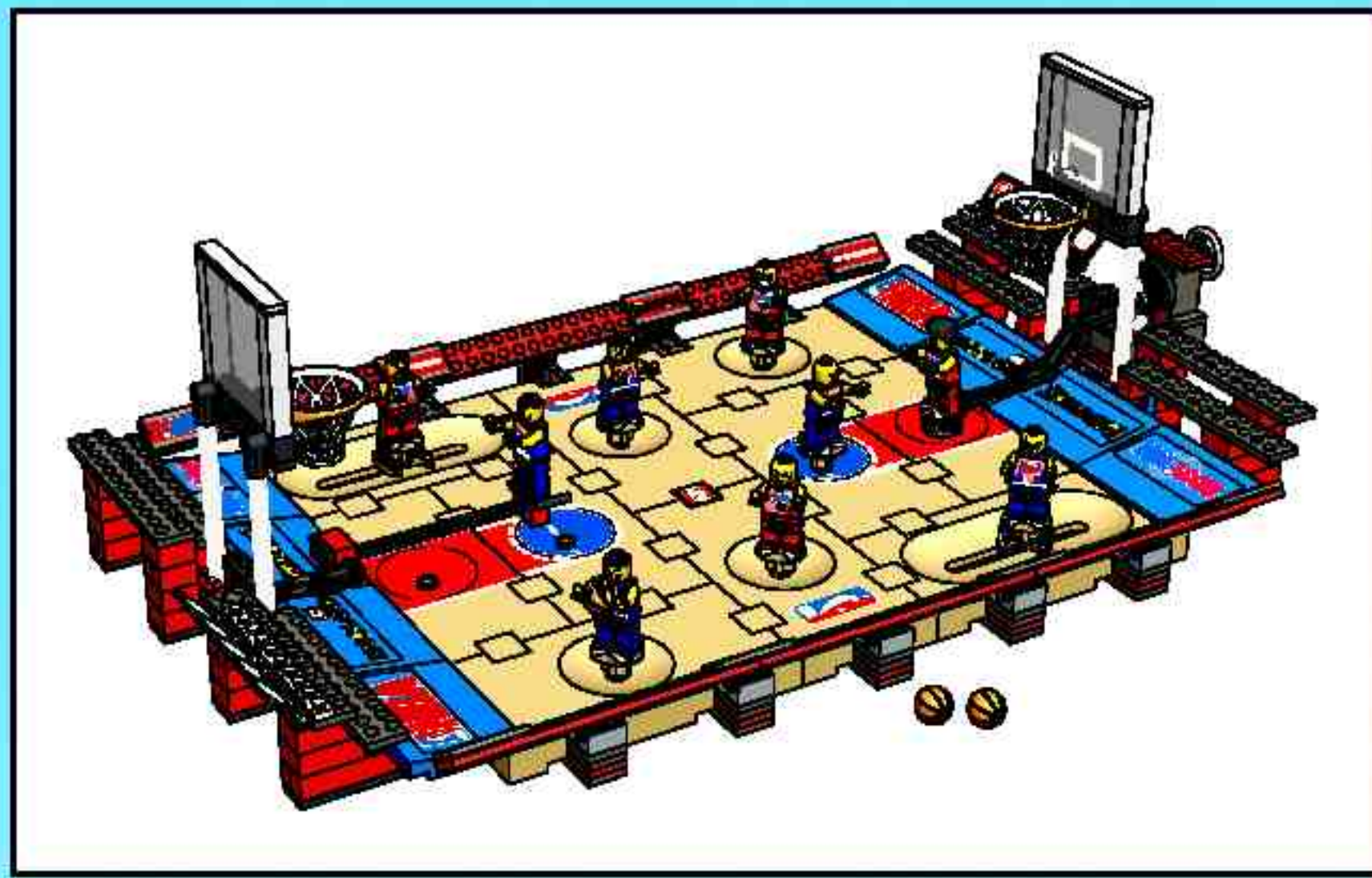

3427 + 3432

1

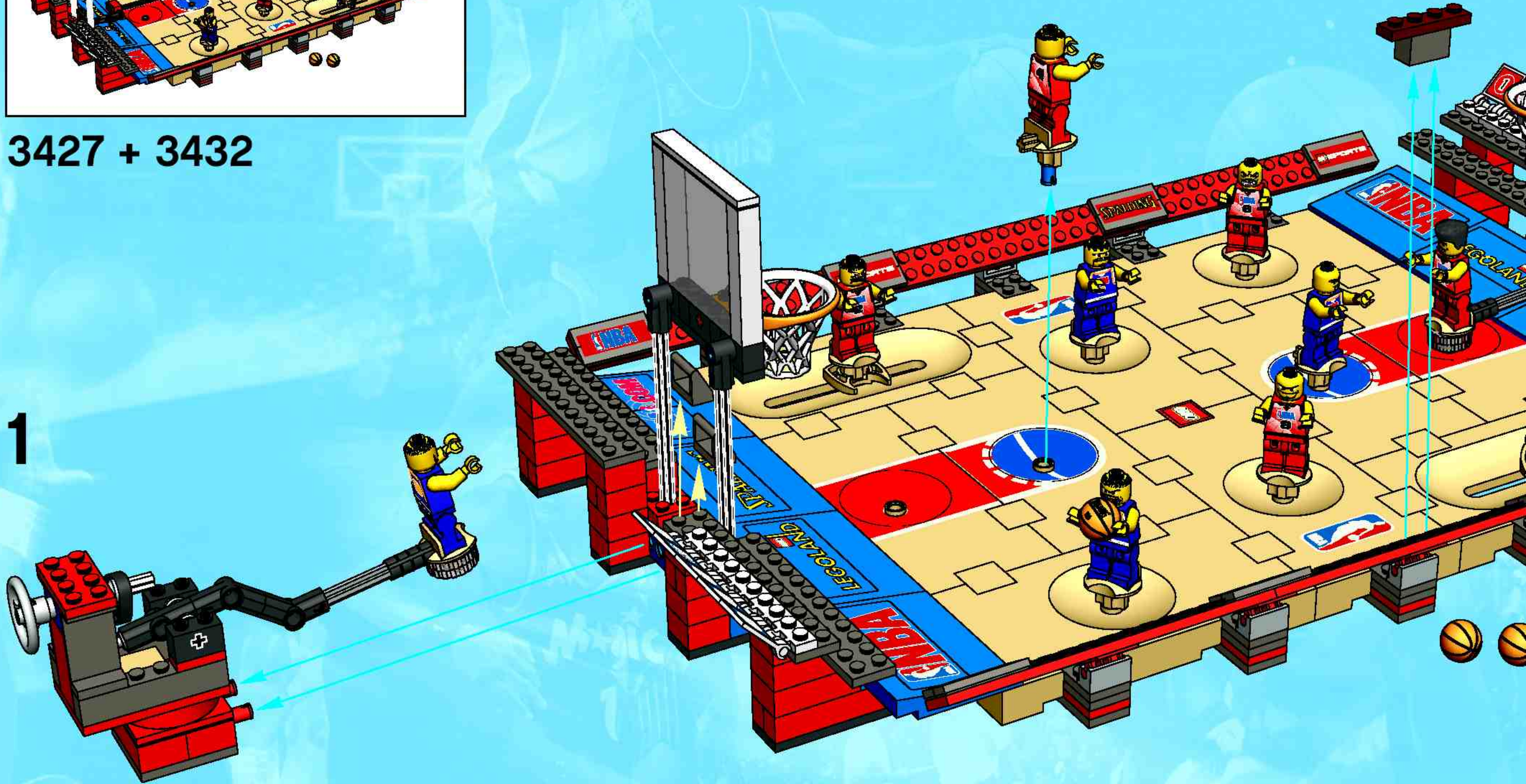



2

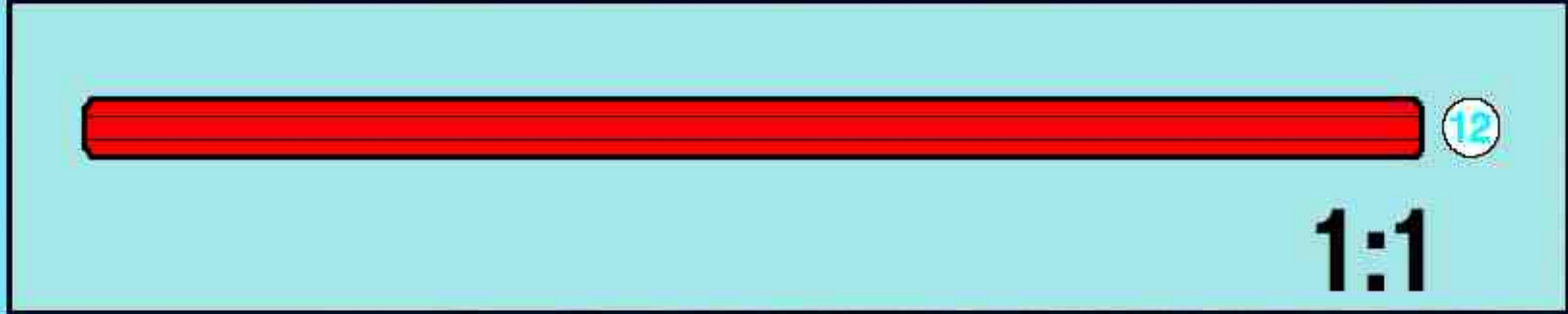
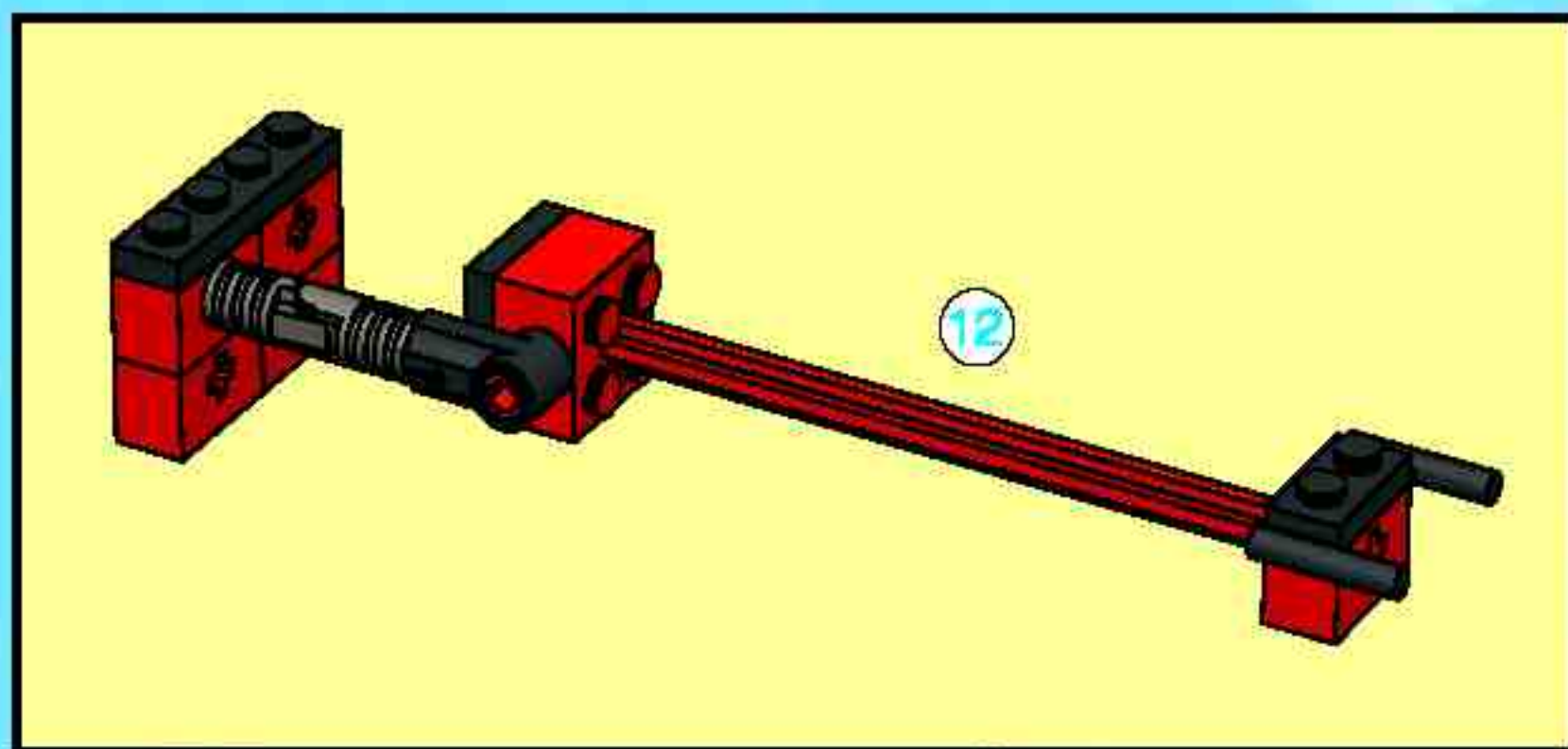



3429 + 3432

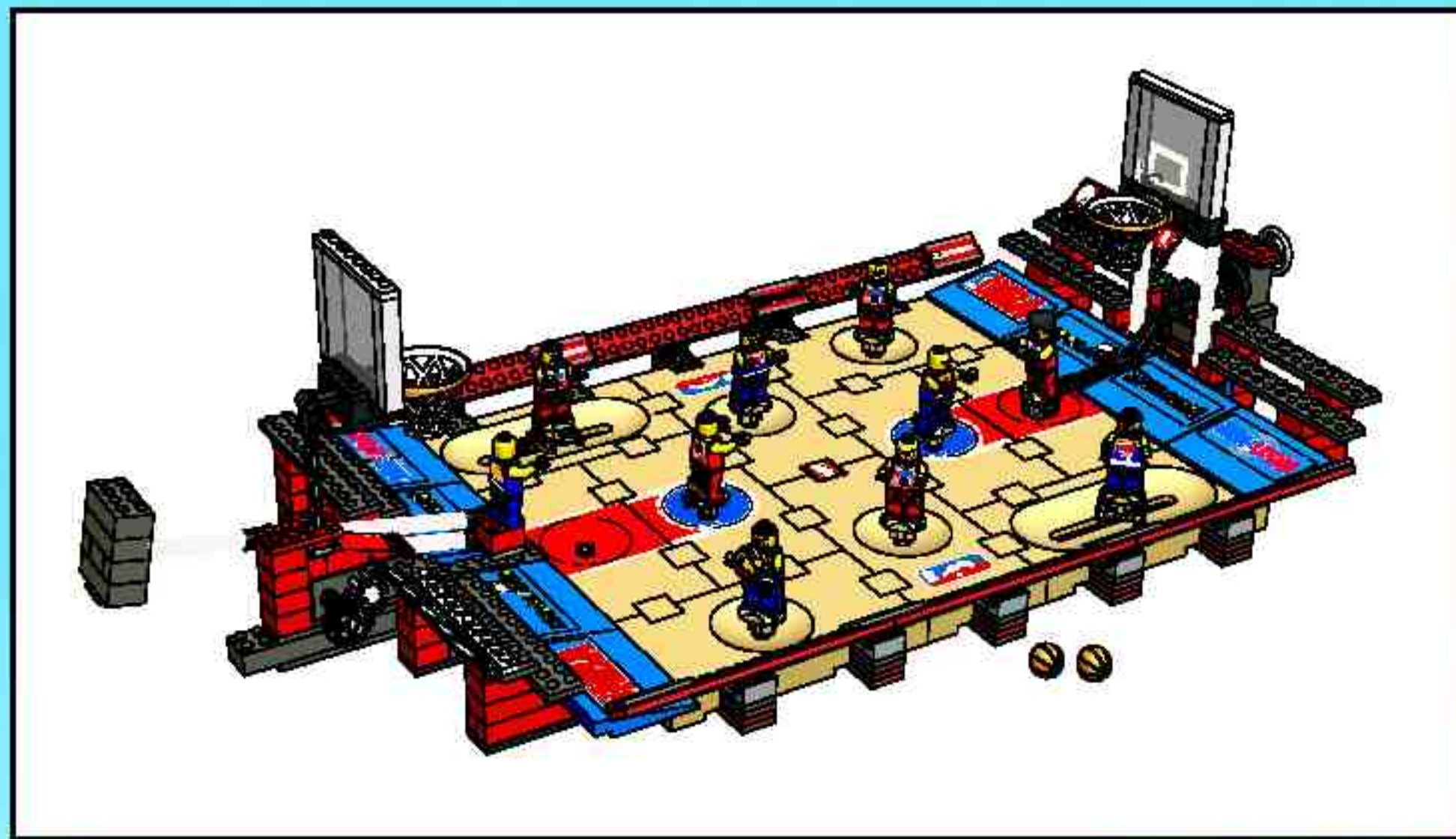

1

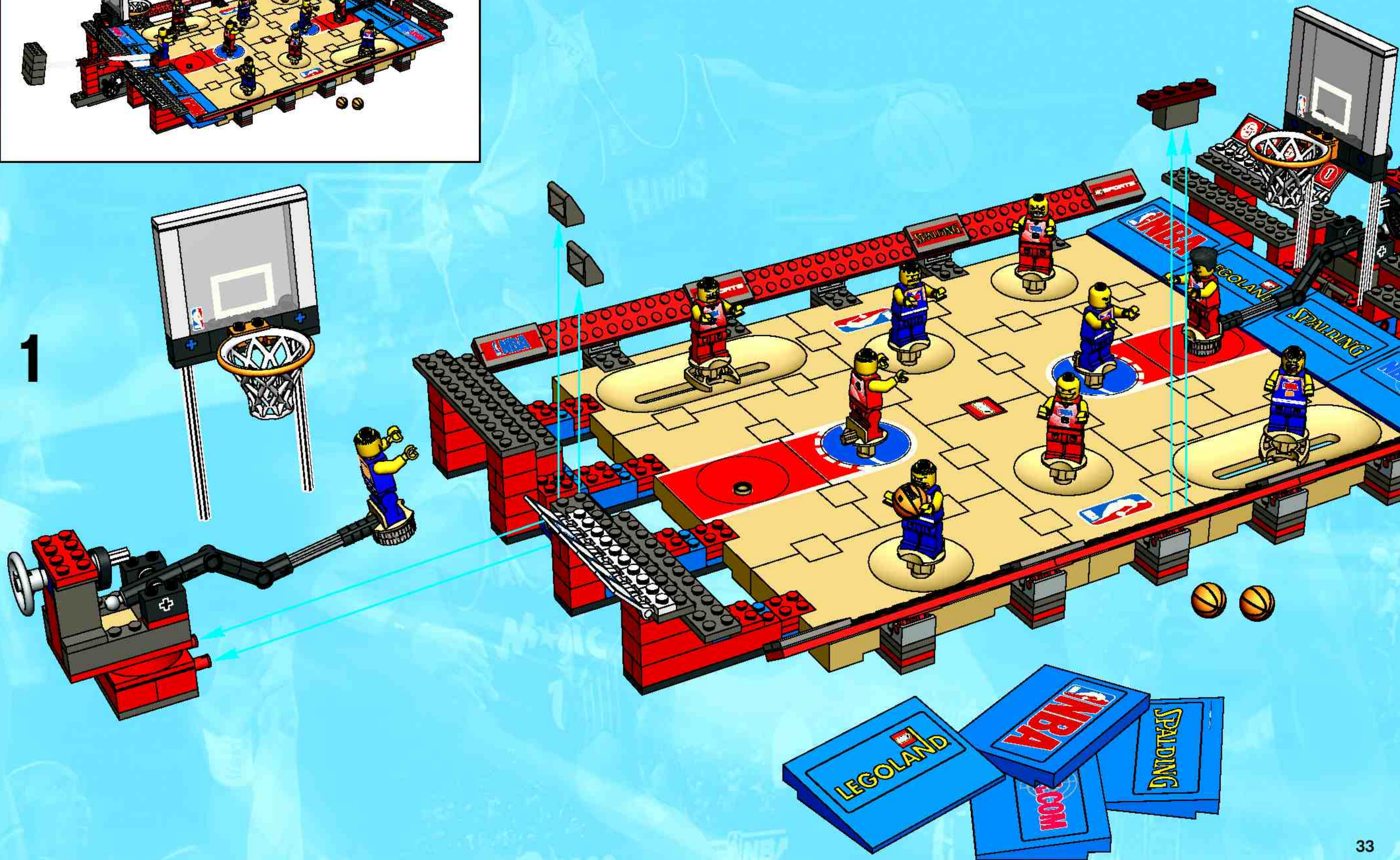



1

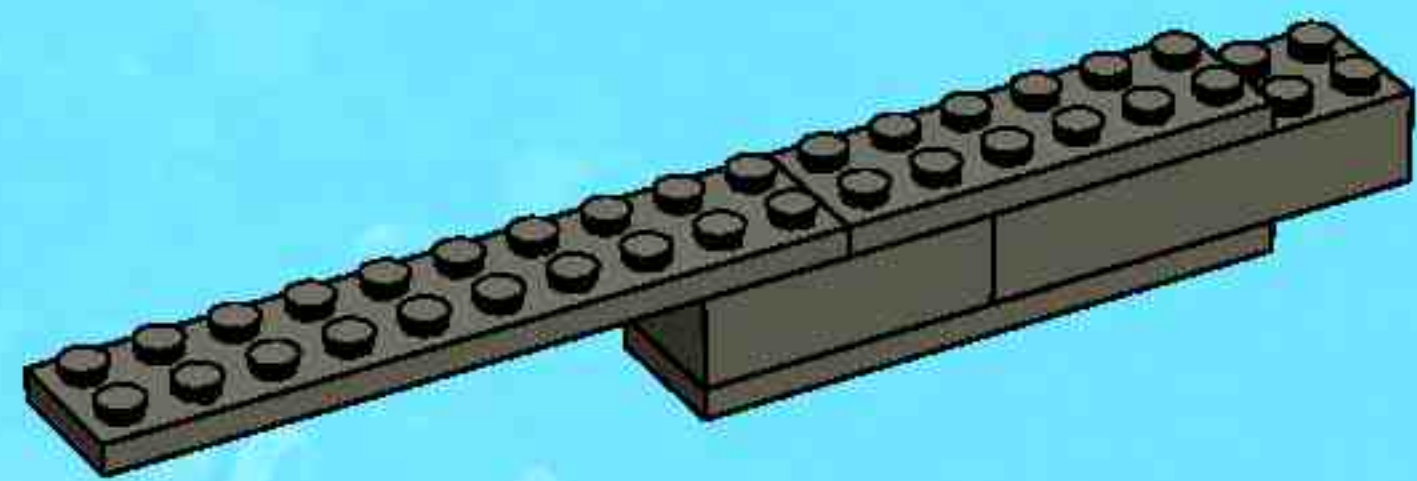

2

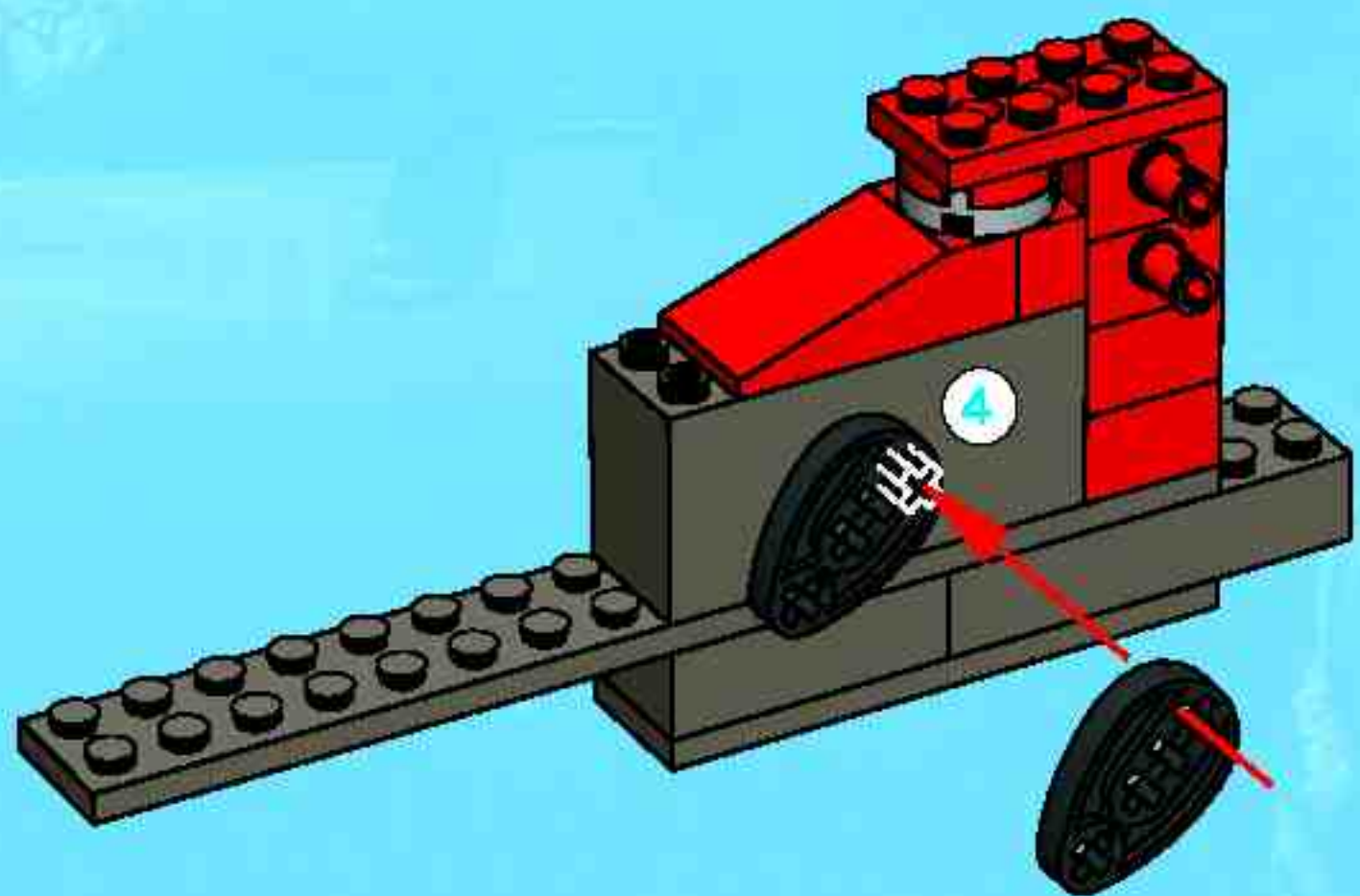

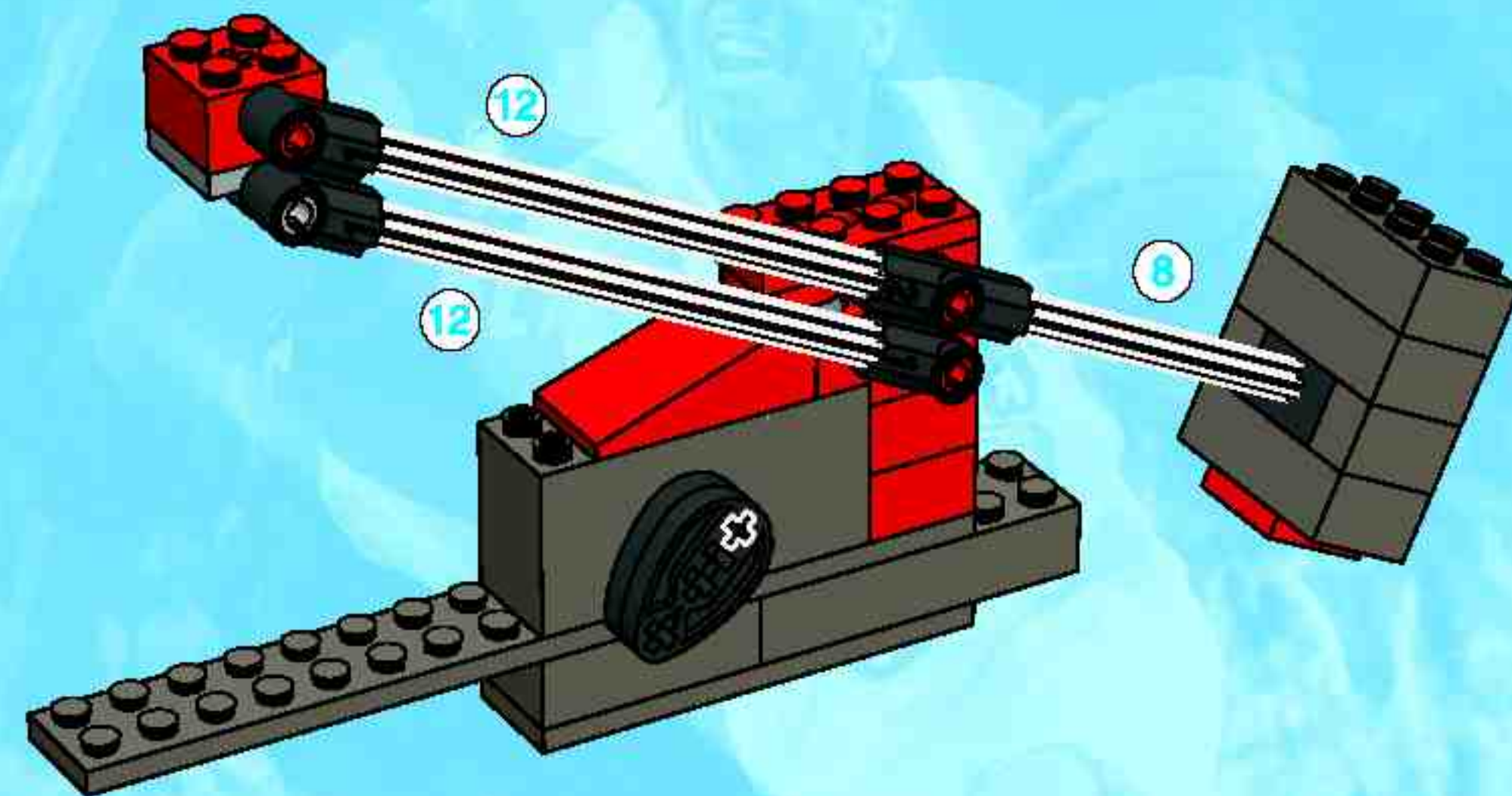

3

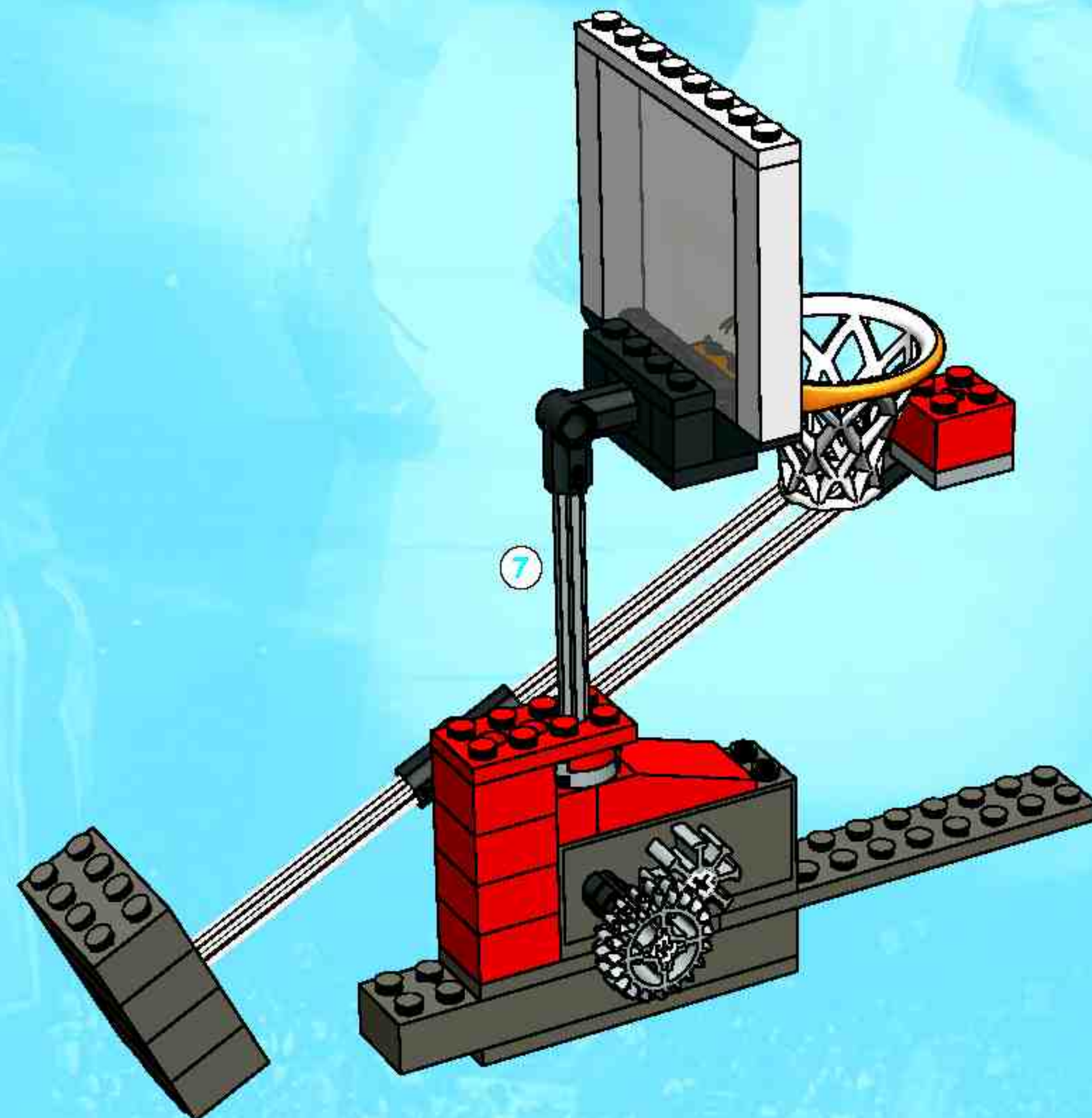

4

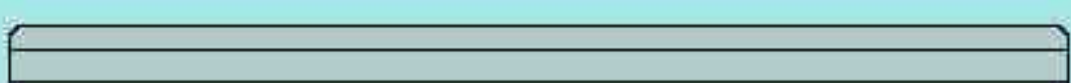

	4
	7
	8
	12

1:1



2

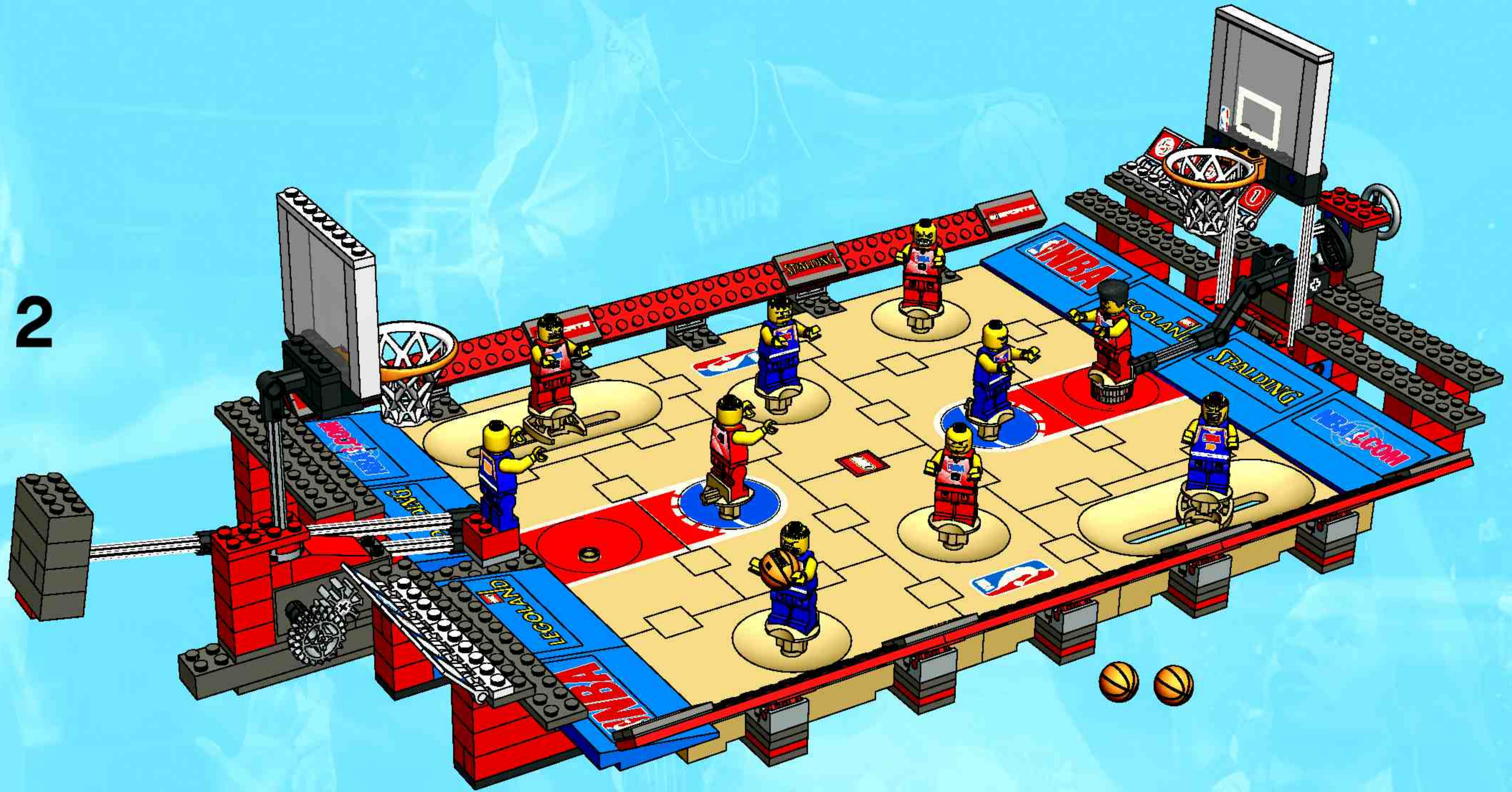





# SPORTS

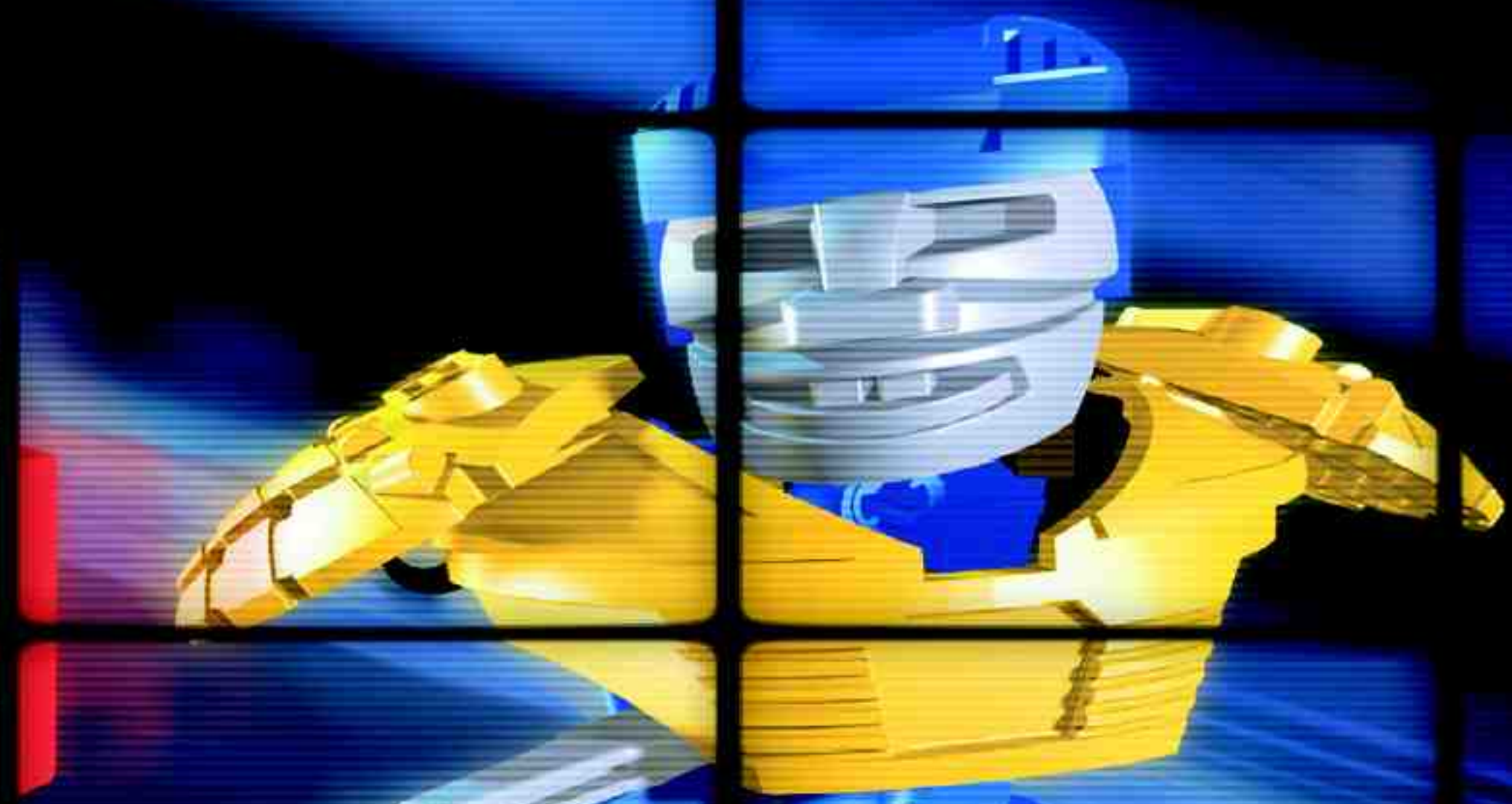
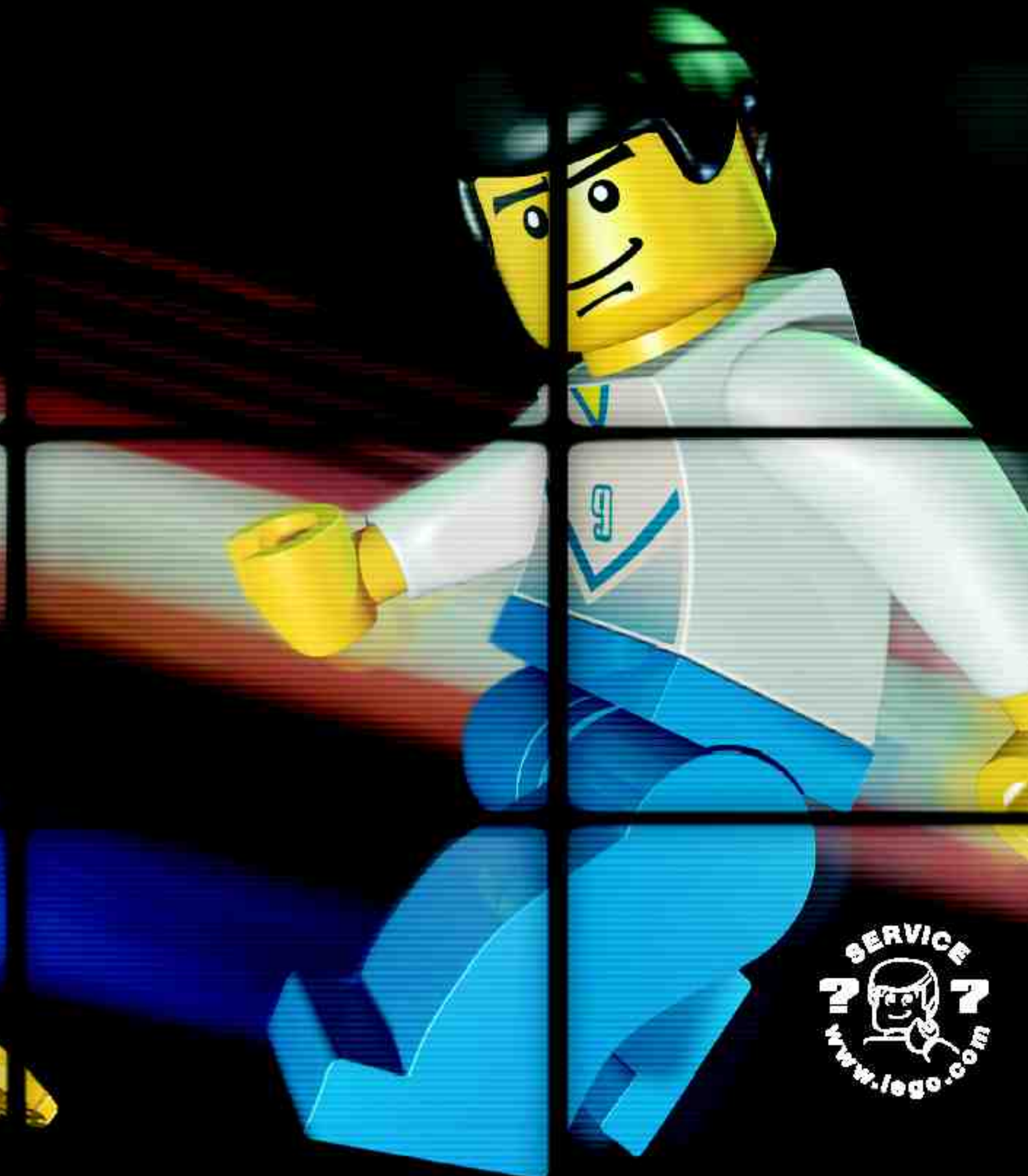

SPALDING is a trademark of Spalding Sports Worldwide, Inc. or Lisco Sports, Inc., a Spalding affiliate. © Spalding Sports Worldwide, Inc. 2002

adidas, the adidas logo and the three stripe trademark are registered trademarks of the adidas-Salomon group, used with permission. Fevernova and the Trigon logo are trademarks of the adidas-Salomon group, used with permission.

LEGO and the LEGO logo are trademarks of the LEGO Group. ©2002 The LEGO Group.

NBA identifications depicted are the exclusive property of NBA Properties, Inc. and/or the NBA Member Teams, and are used with permission.

 [www.LEGO.com](http://www.LEGO.com)