



CREATOR

31033



LEGO.com/creator



2x



1x

1

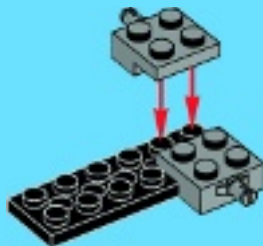

2



2x

2





1x

3

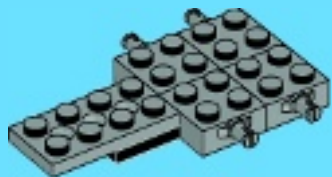

2x



2x

4



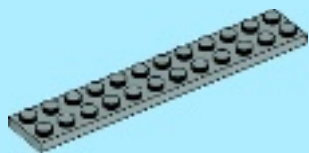

1x

5

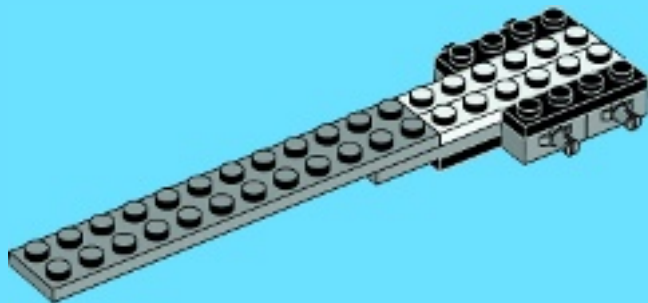



2x



3x

6

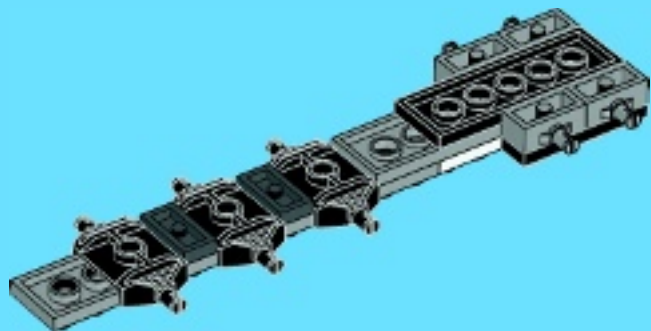

2x

7

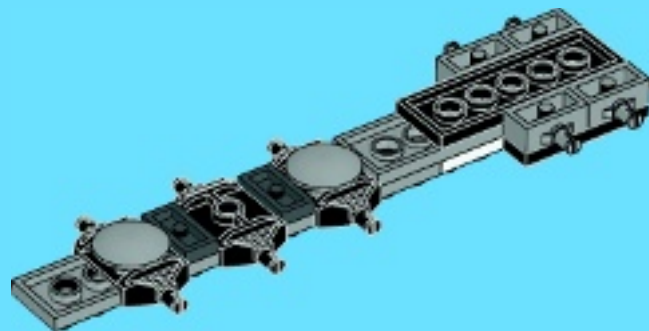



1x



1x



1x

8

1



2

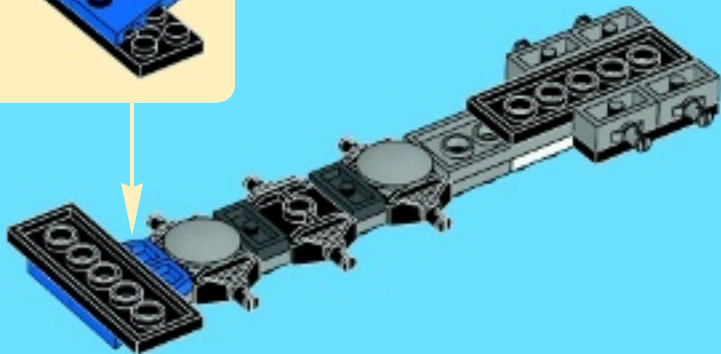



2x

9

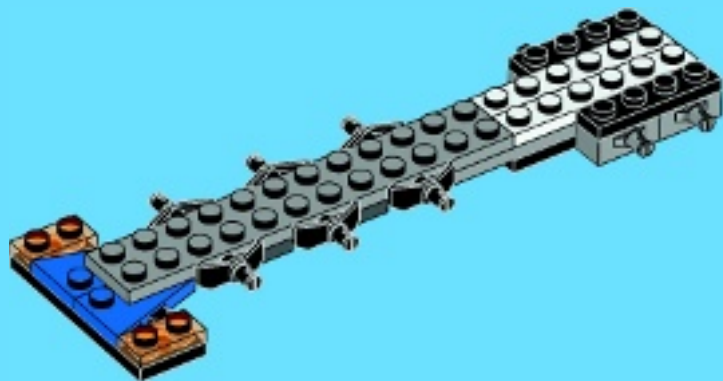



2x



2x

10

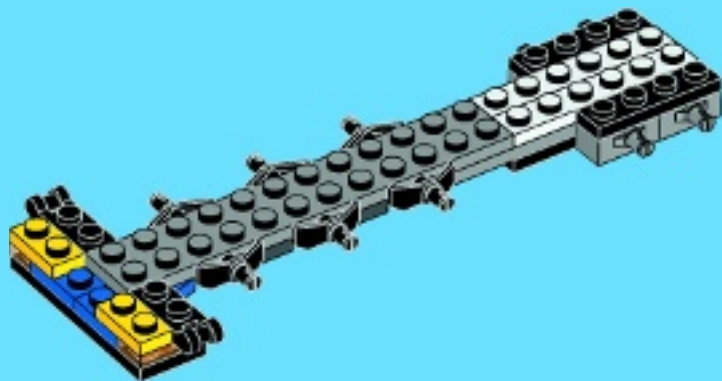



2x



1x

11

1

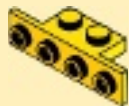

2

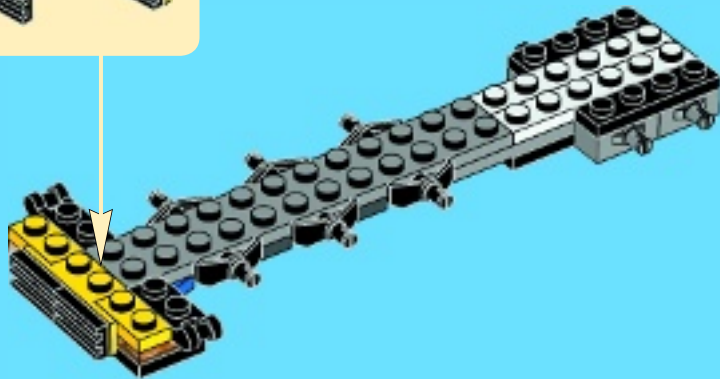
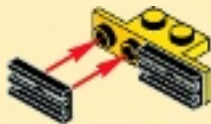

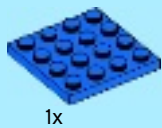

12

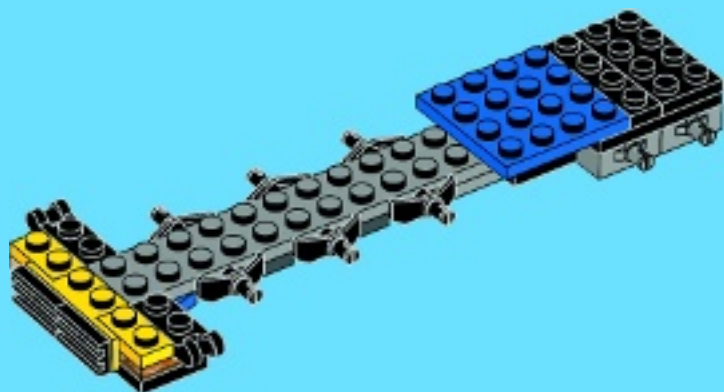

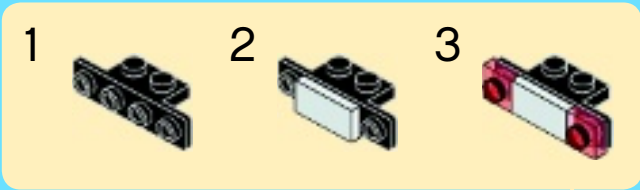
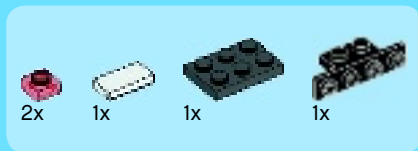

13

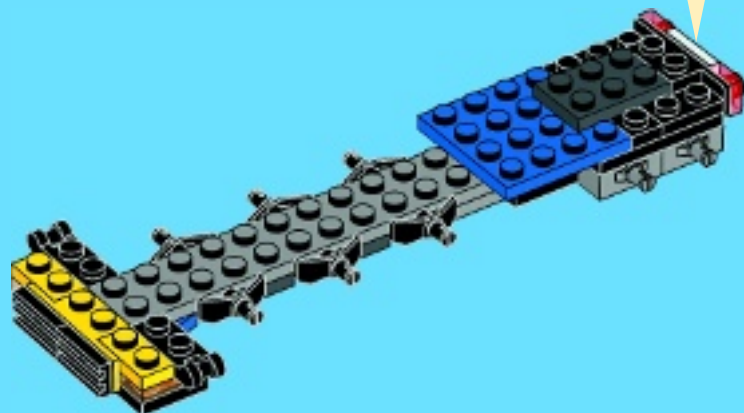



1x



1x

14

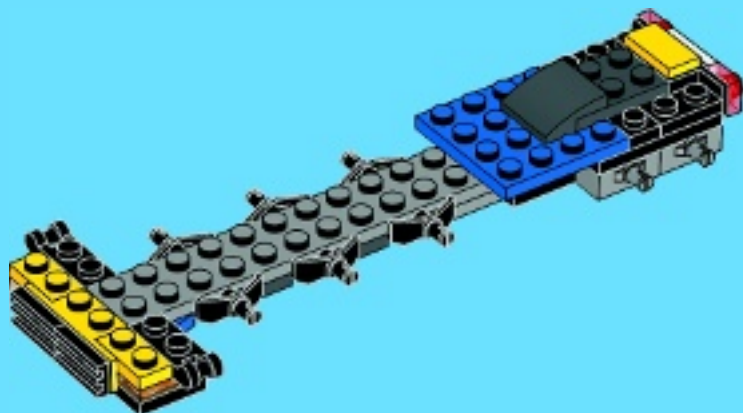



2x

15

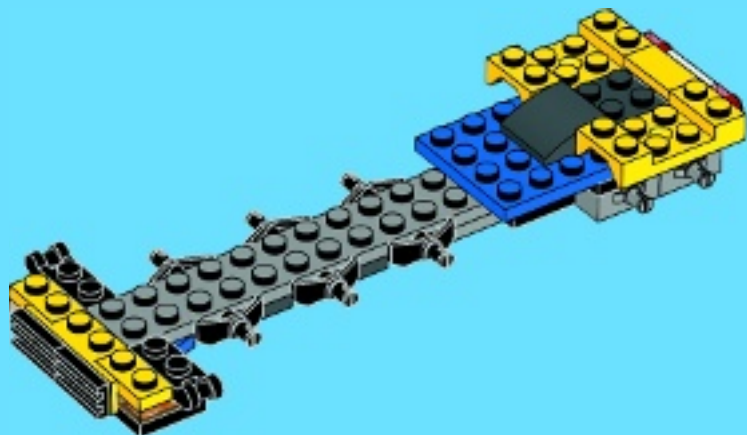



1x



1x

16

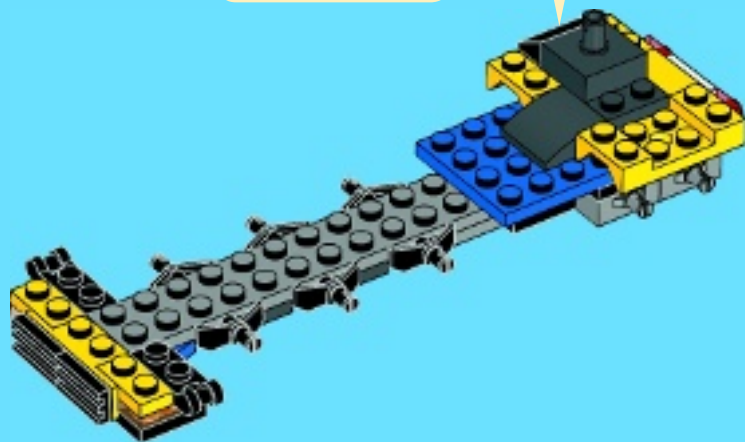
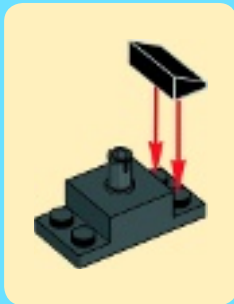



2x

17

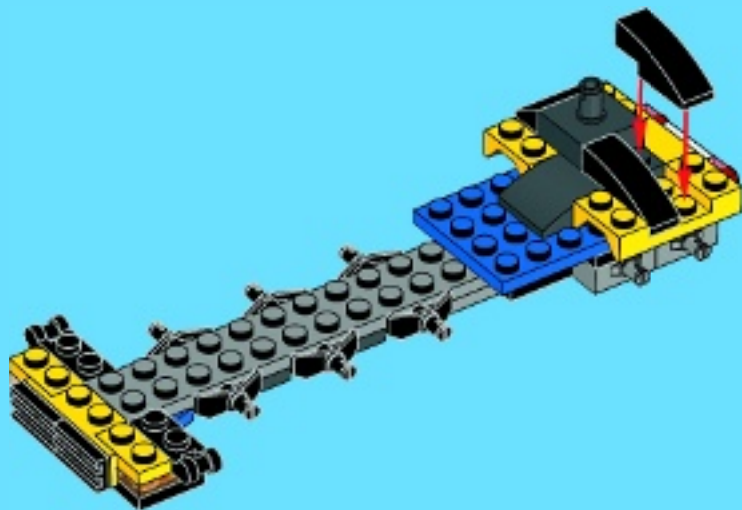



2x



2x

18





4x

19



2x





3x



2x

20

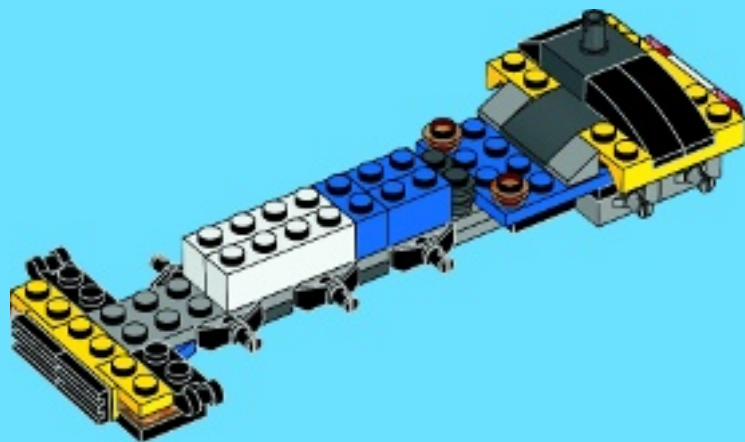



2x



1x

21

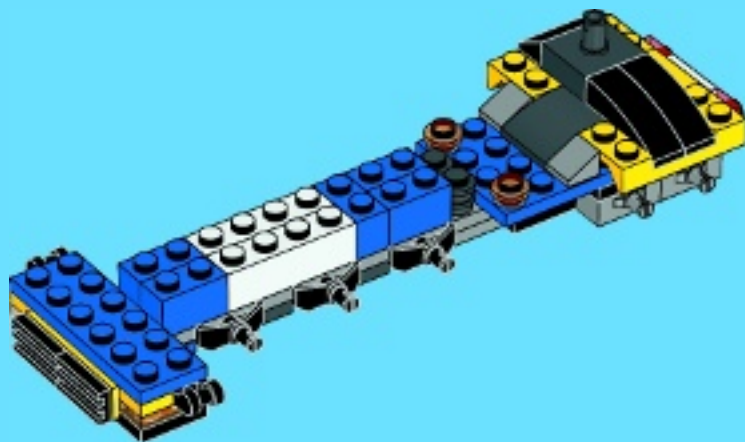



2x



2x

22

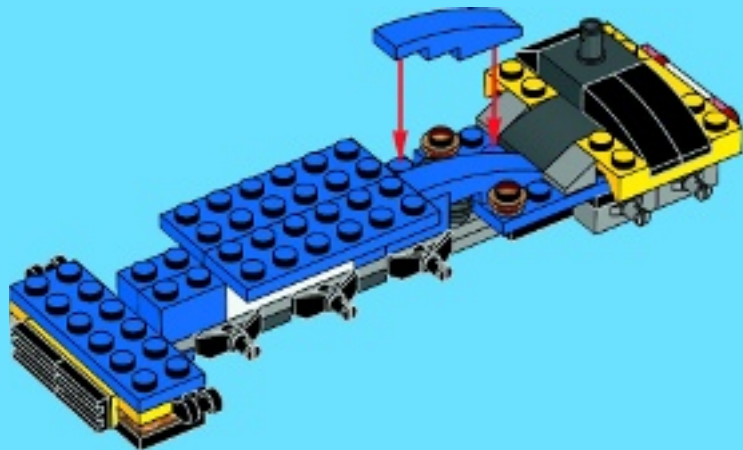

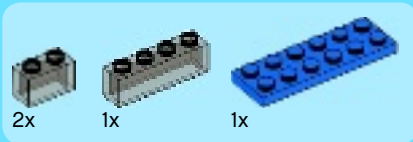

23

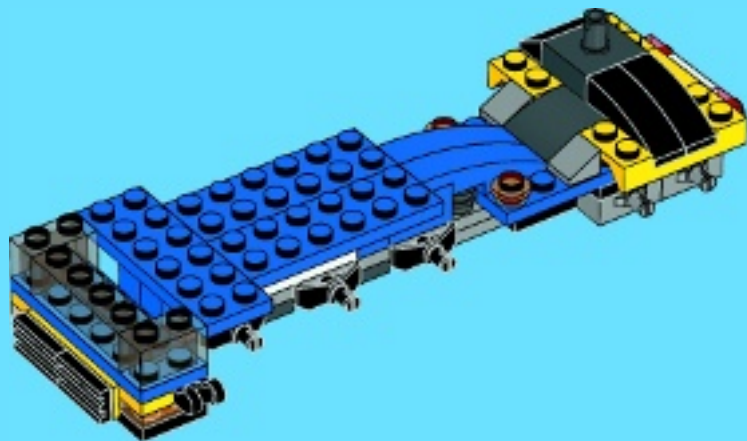



2x



1x



1x

24





1x



1x



1x



1x



1x

25





3x



2x



1x



1x

26

1



2



3





1x



2x

27





2x

28





1x



1x



2x

29





1x



1x

30





1x



2x

31

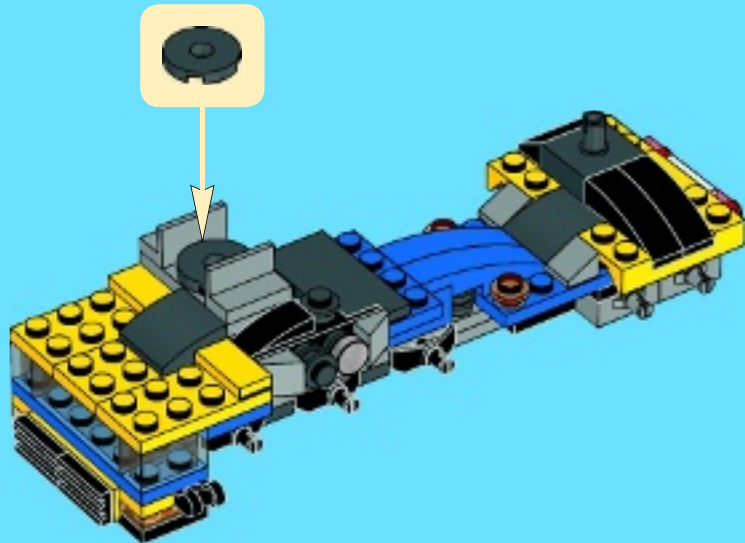



4x



4x

32

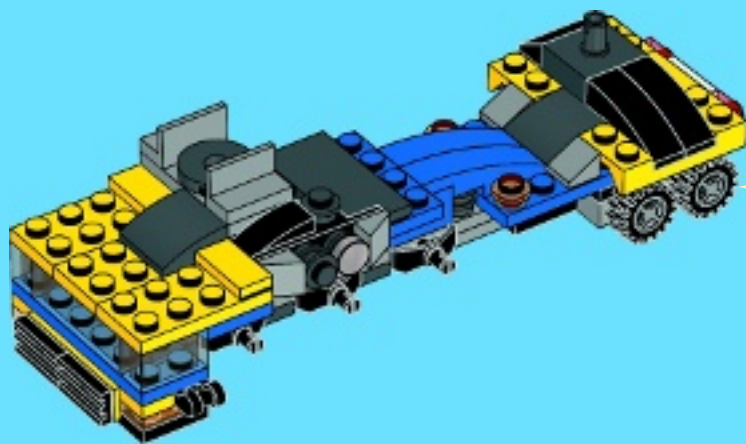

4x



6x



6x

33

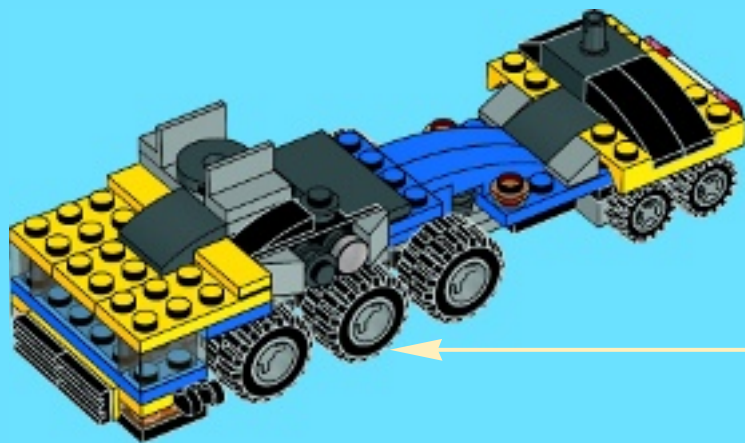

6x

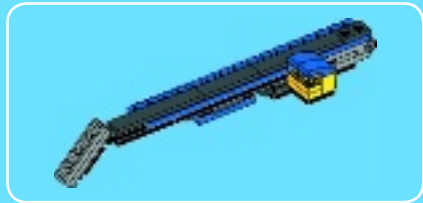

1x

1

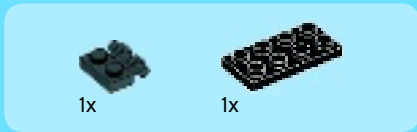

1x

1x

2





1x

3



1x



1x

4

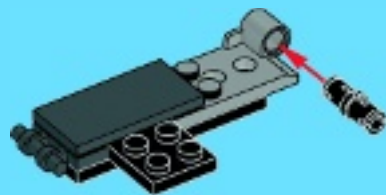

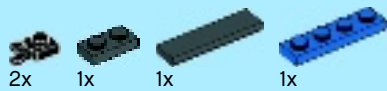

5

1



2



3

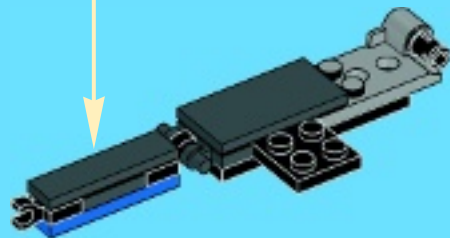

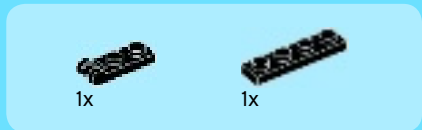
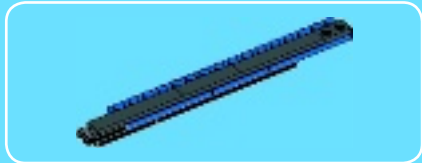

1

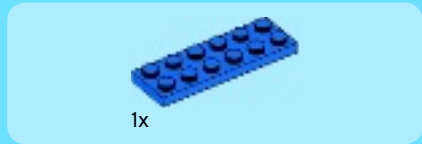
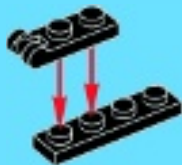

2



3



1x



4



2x

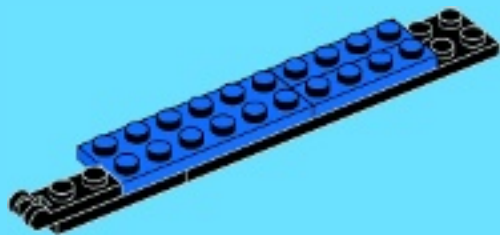



1x

5

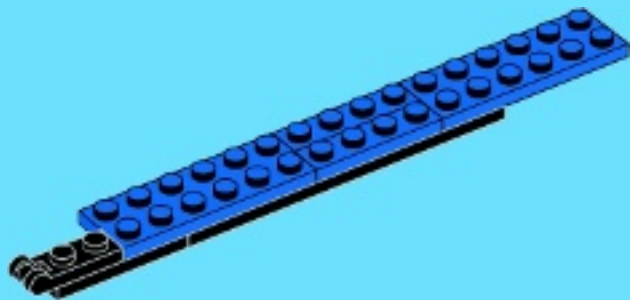

1x



1x

6

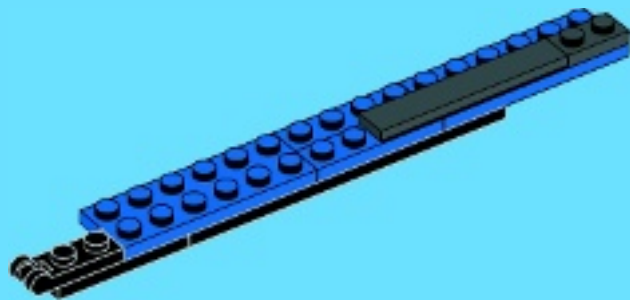



1x



1x

7

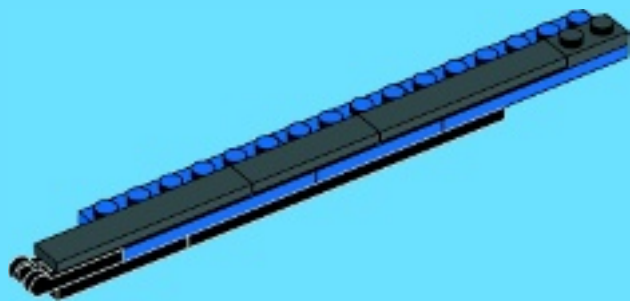

38



1x

8



6

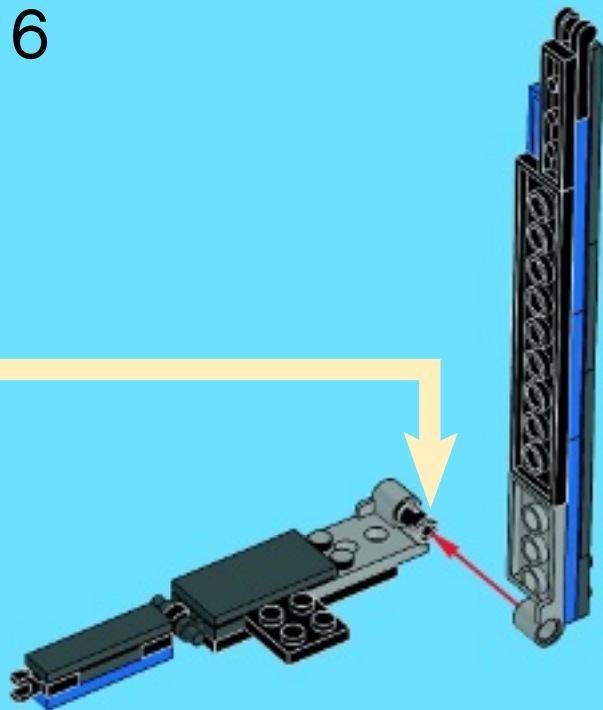



2x

7

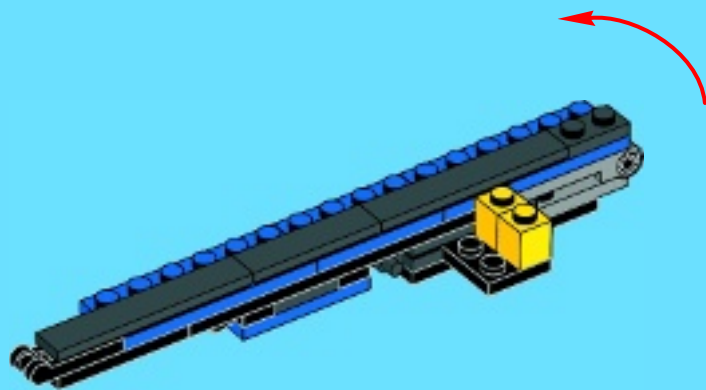



2x



2x

8

1



2



3

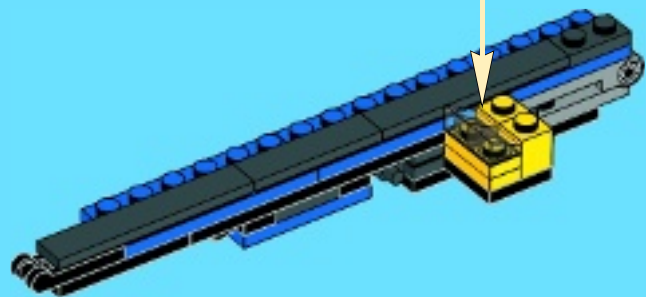

2x

9

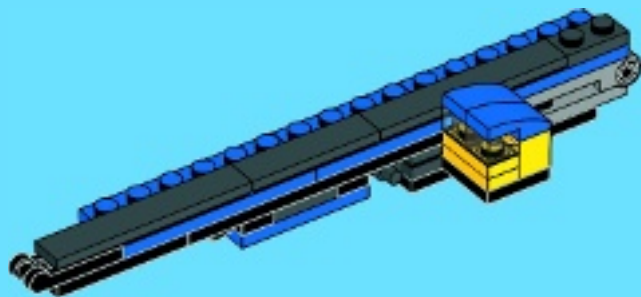



1x



2x



1x

10

1

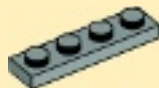

2

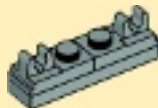

3

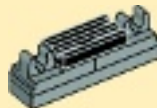

34

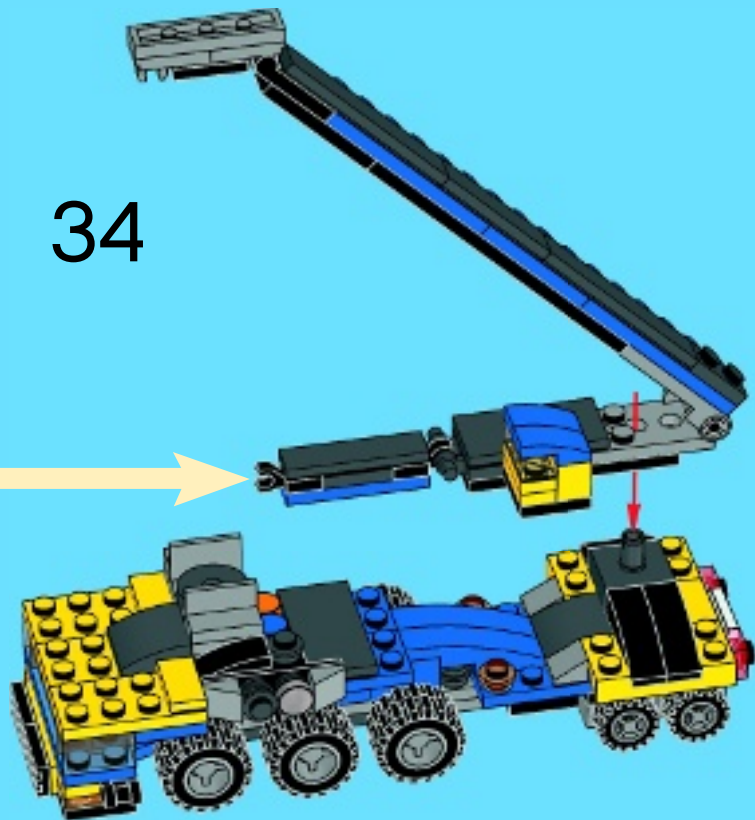



3x



2x



1x



2x

35

1



2



3



4

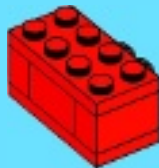

36

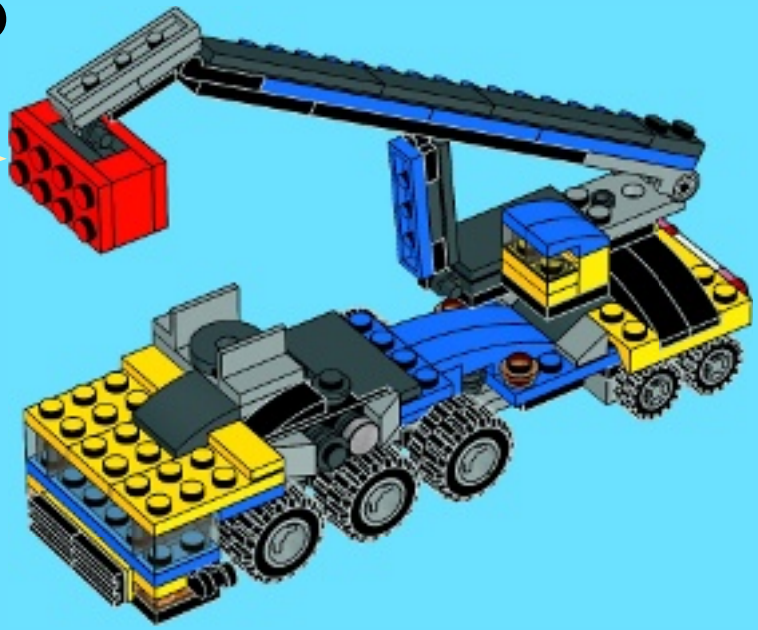



club

TM

1



LEGO.com/club

2

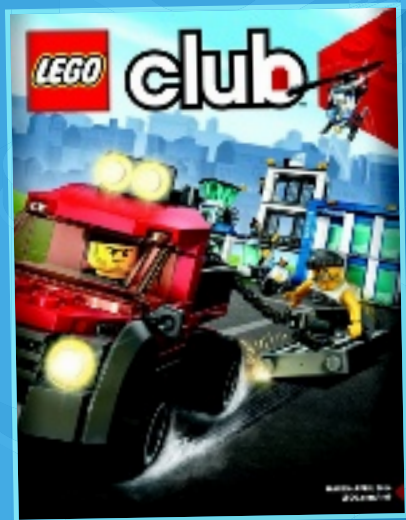

3





CREATOR

31033

3 IN 1



LEGO.com/creator



CREATOR

LEGO and the LEGO logo are trademarks of the/son des marques de commerce du/son marcas registradas de LEGO Group. ©2015 The LEGO Group. 6112392 / 6112394



31029



31027



31033



31033



31029



31027



LEGO.com/creator