

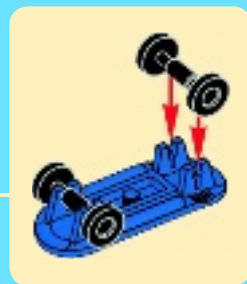

CREATOR

31009

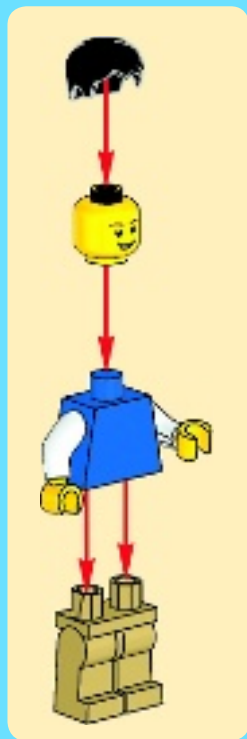





1x

1

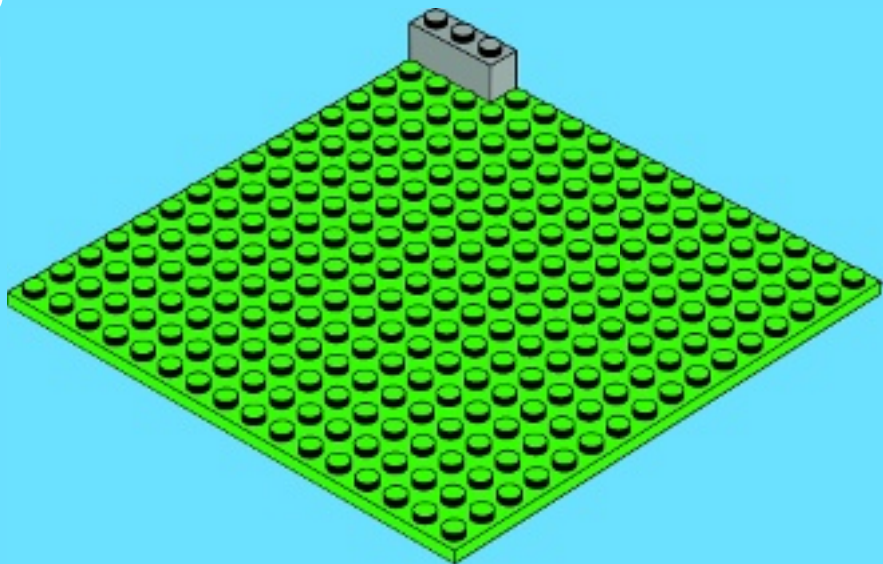



1x



2x

2

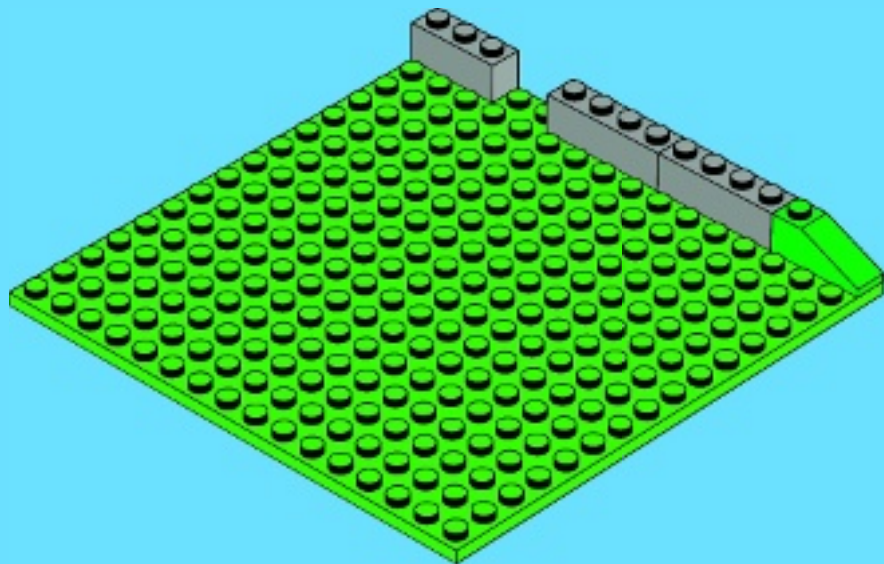



1x



2x



1x

3

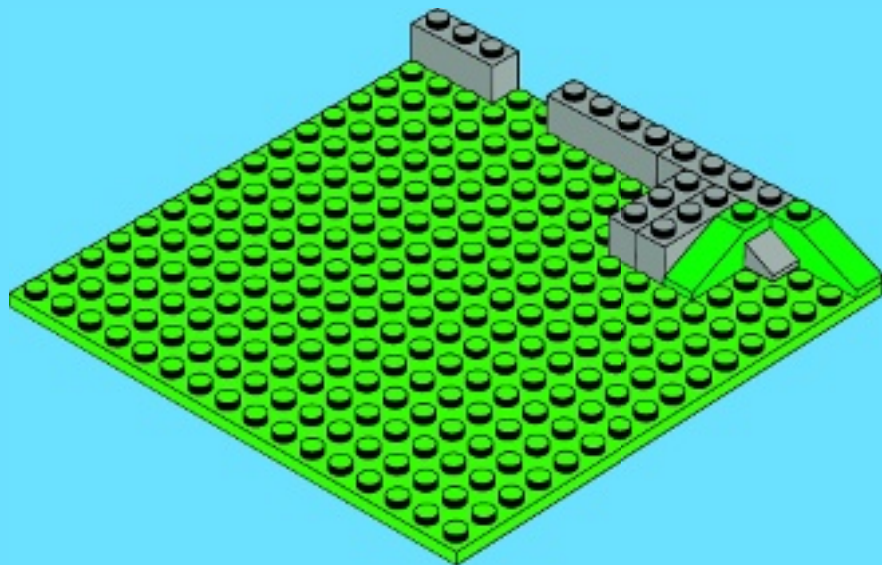



1x



2x

4

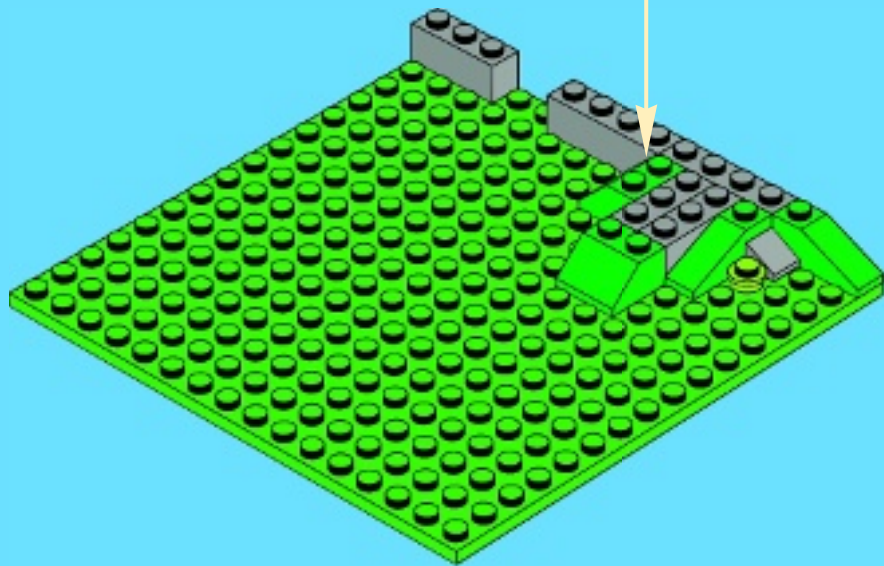

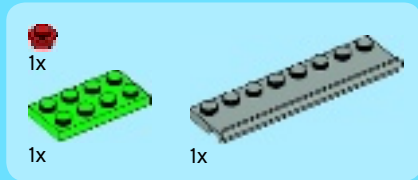

5

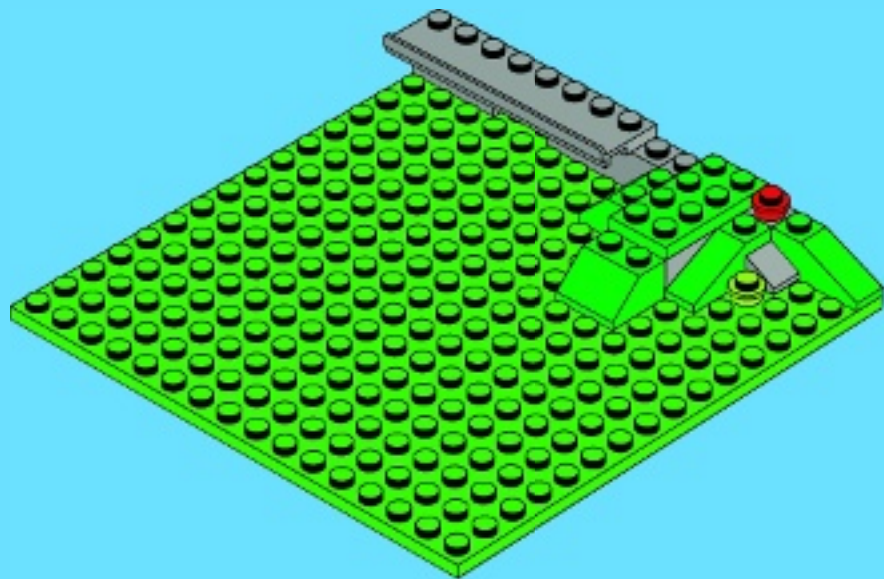



1x

6

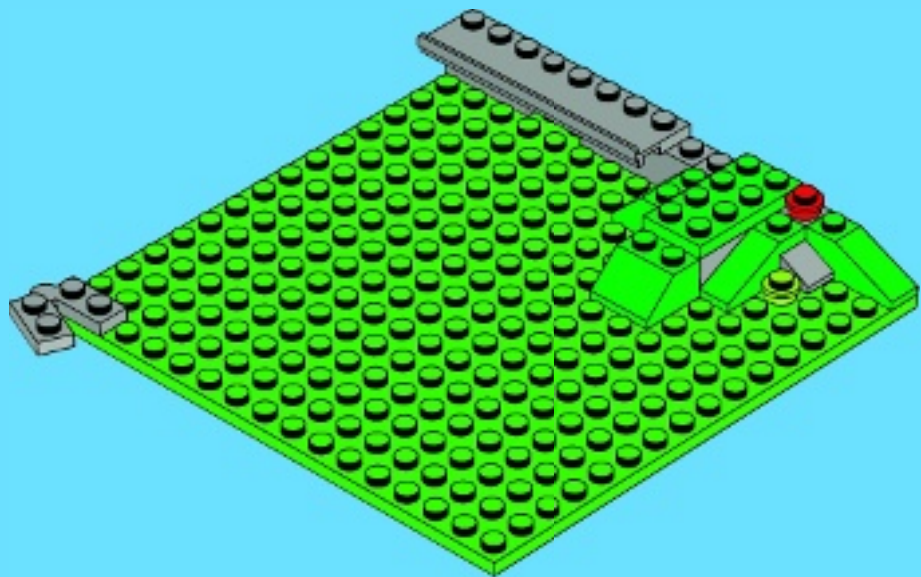

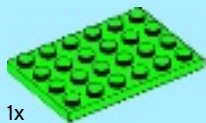

1x

7

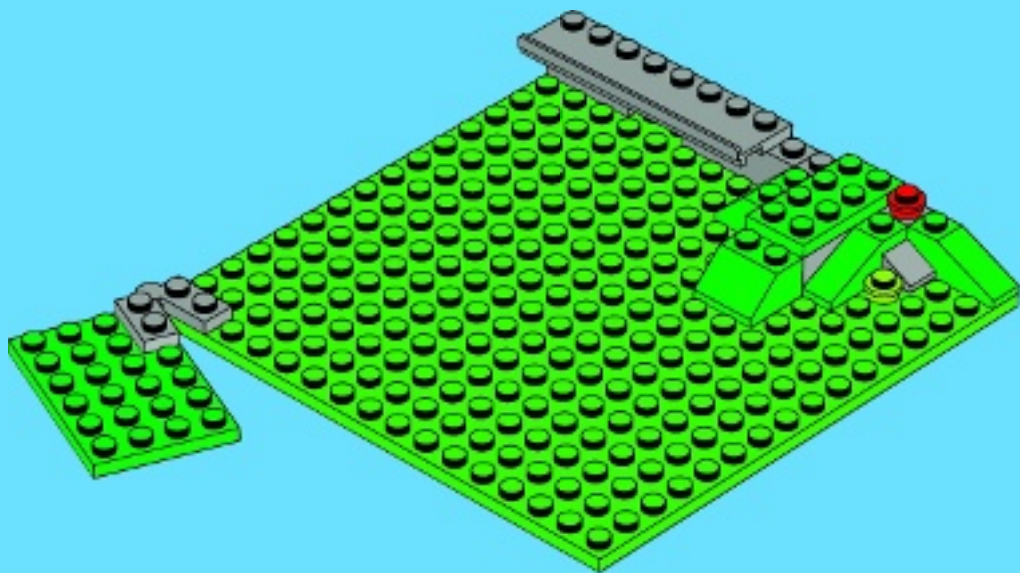



4x

8

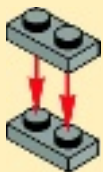

2x

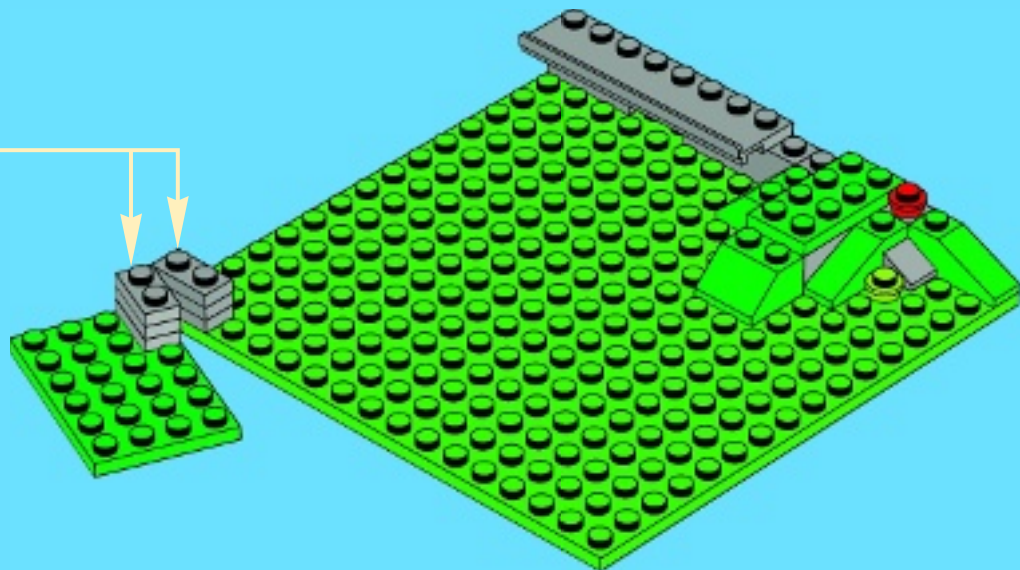



2x



1x

9

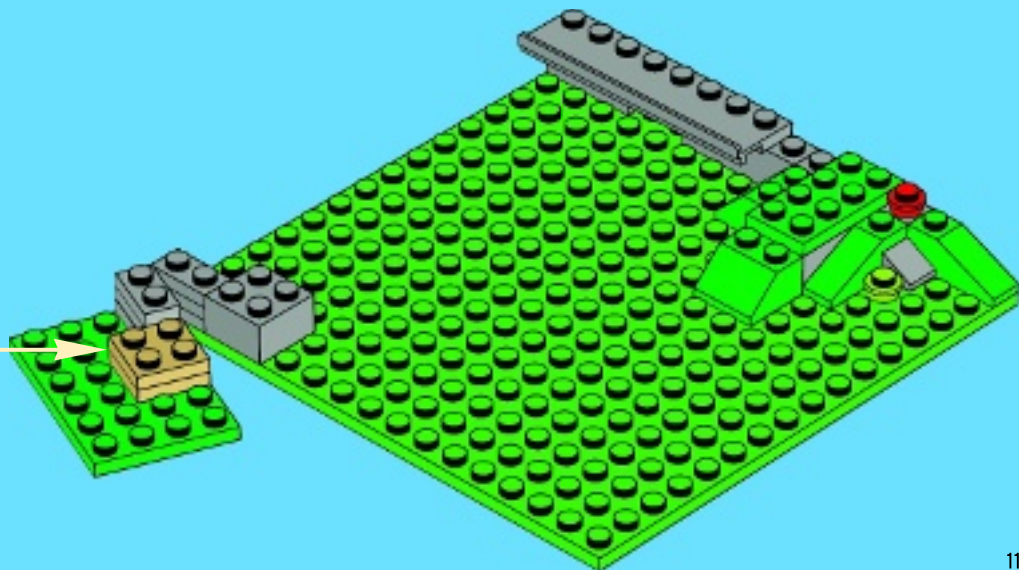
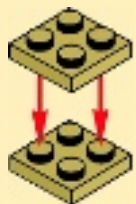



2x



1x



2x

10

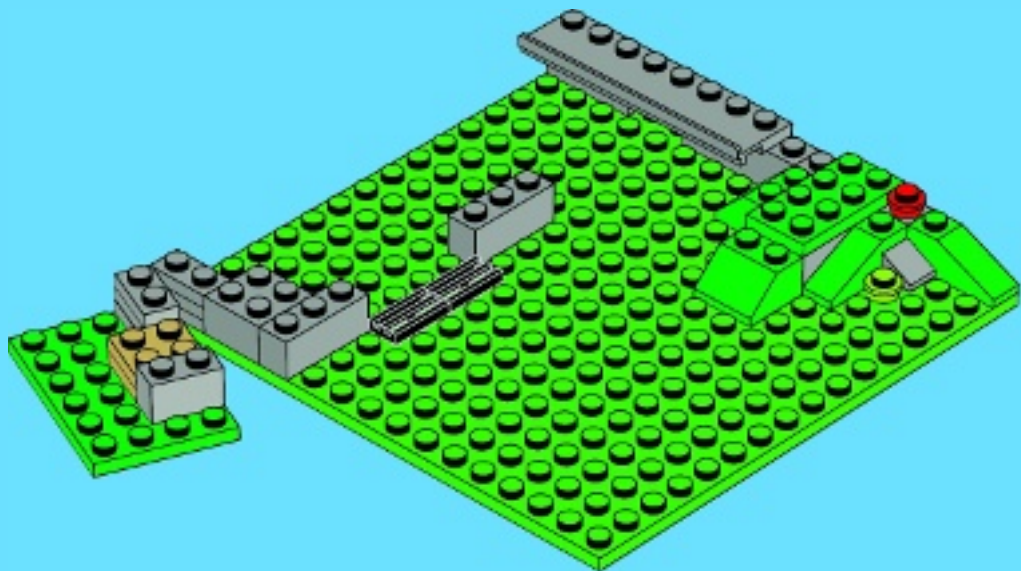



2x

12

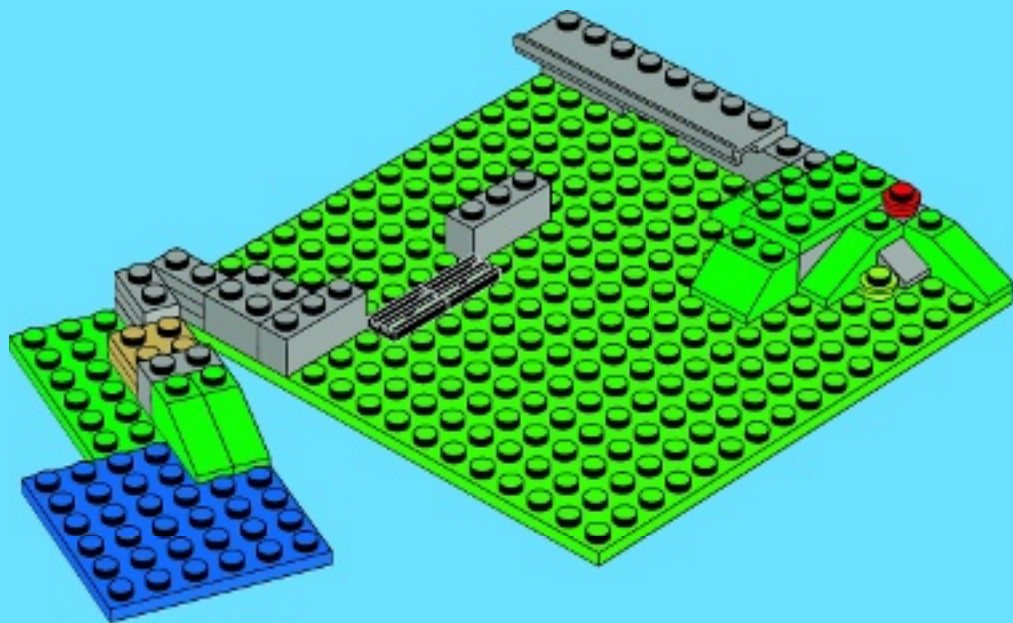



2x

13

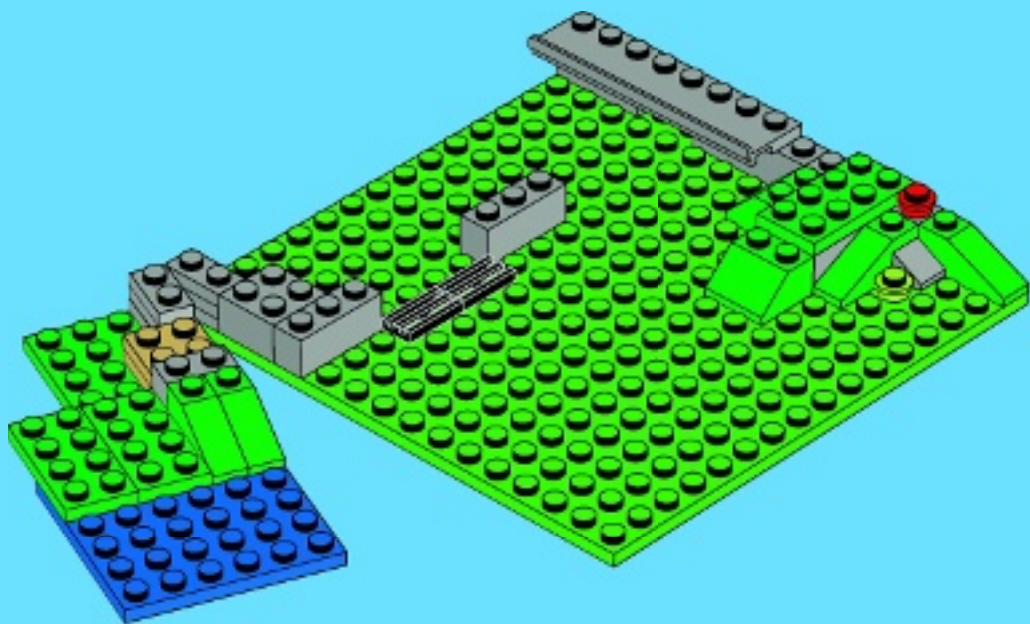



1x



1x



1x

15

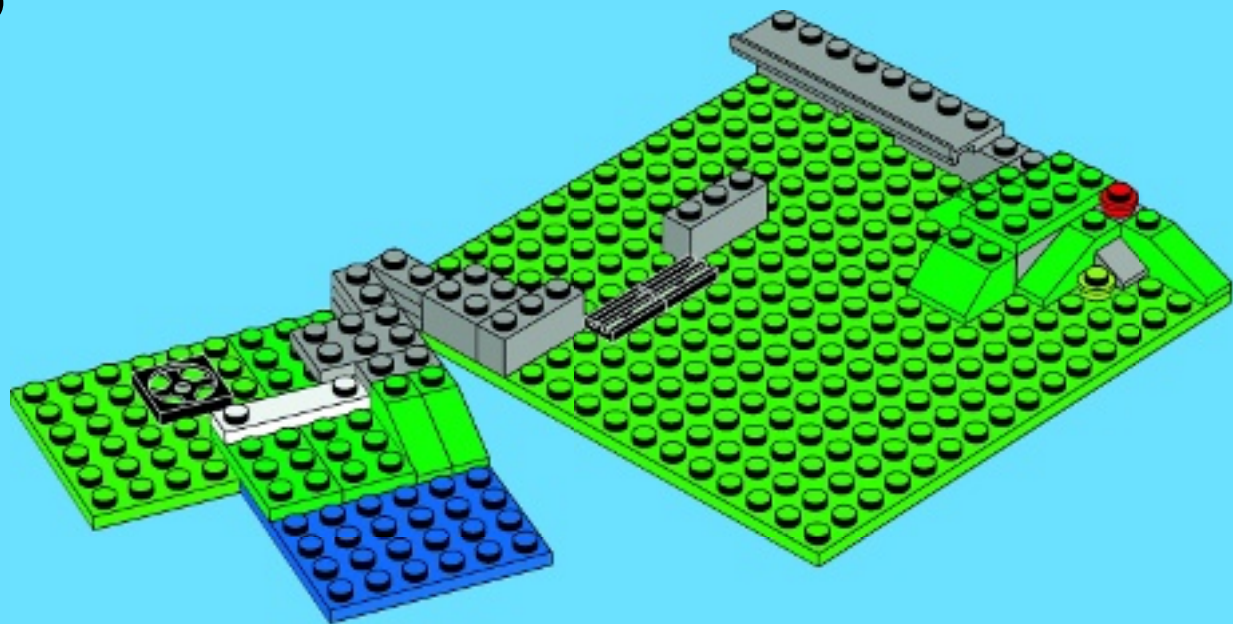



1x



2x



3x



5x



1x

17

1



2



3





1x



1x



1x



2x

21

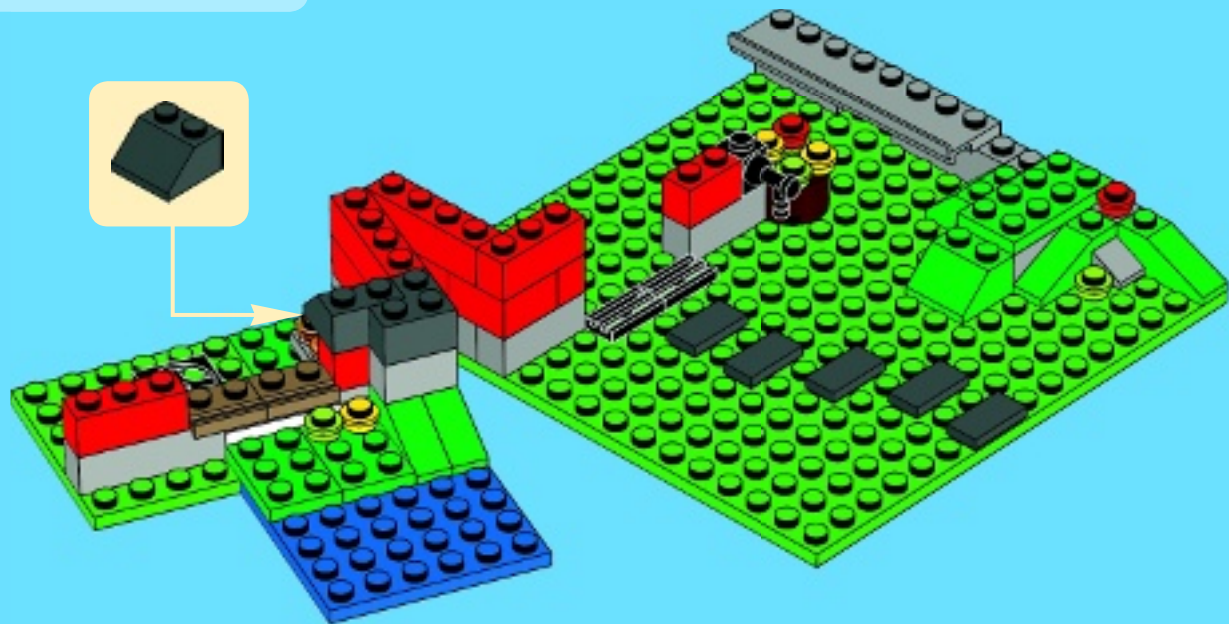

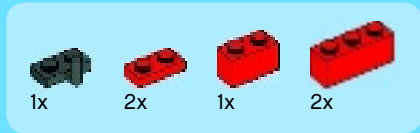

22

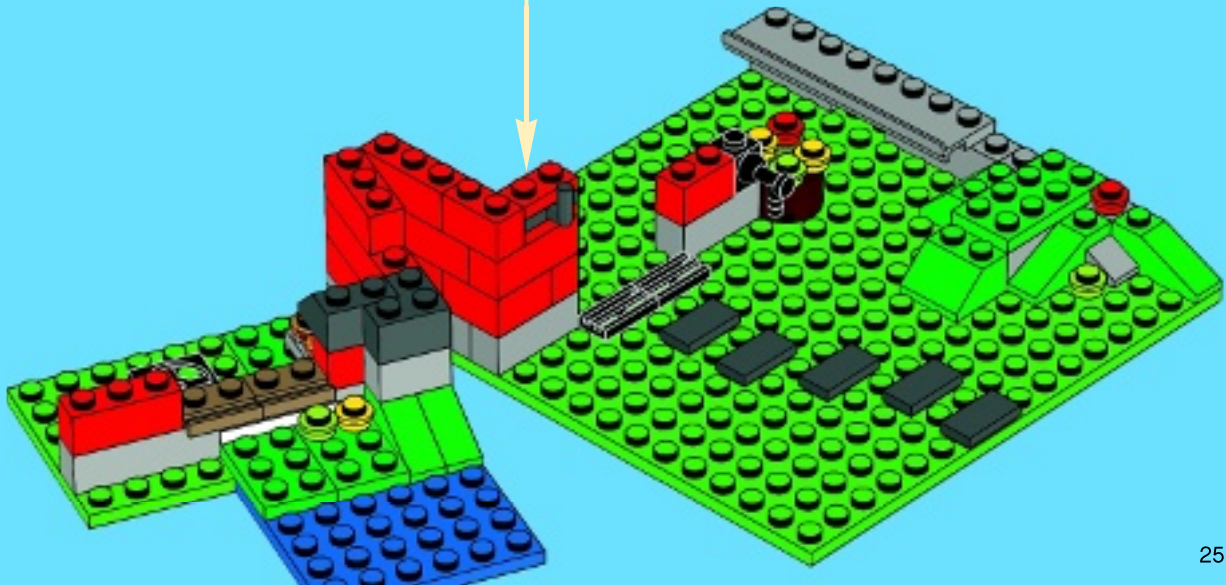



4x



4x

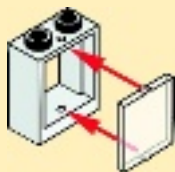

4x

27

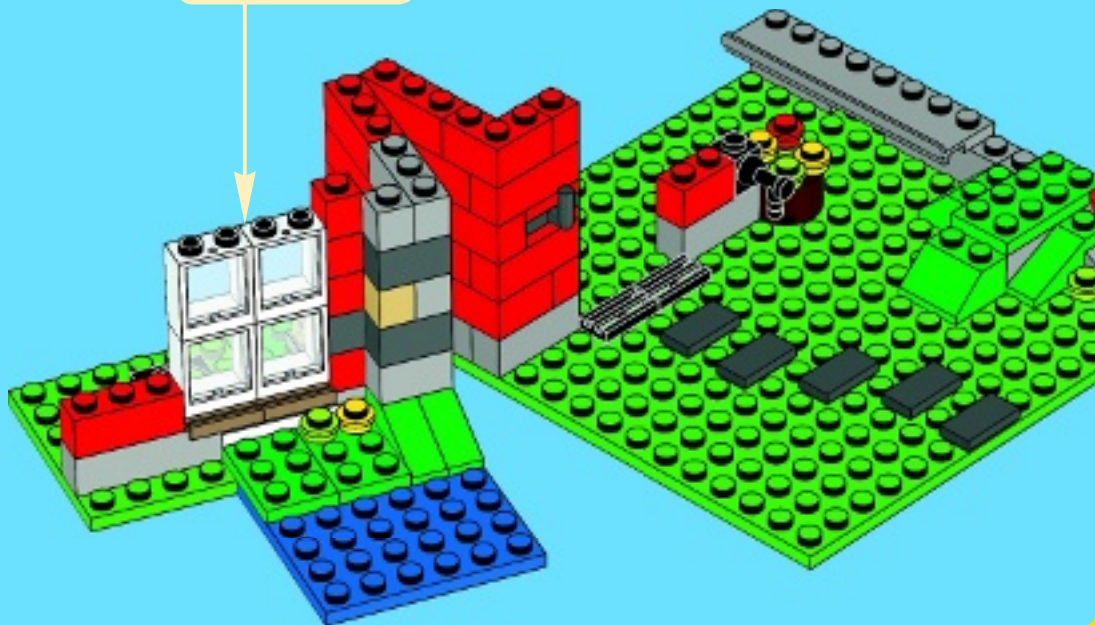



2x

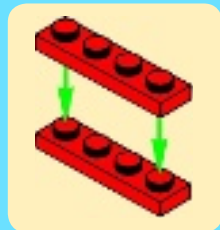

28

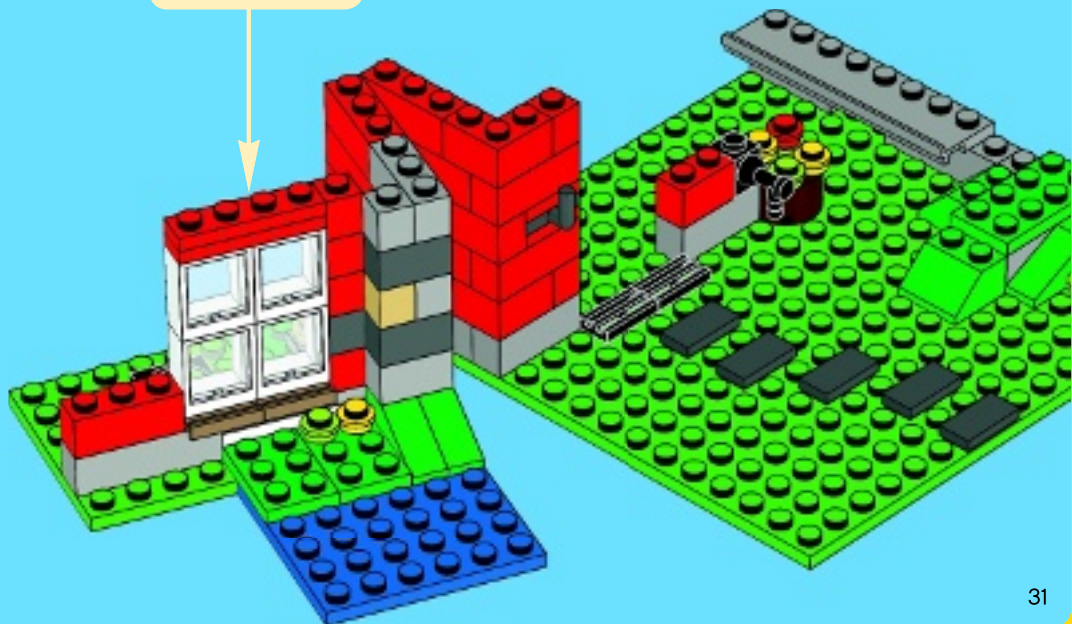



8x

29

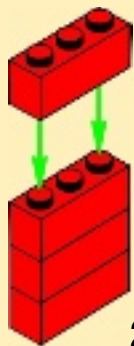

2x

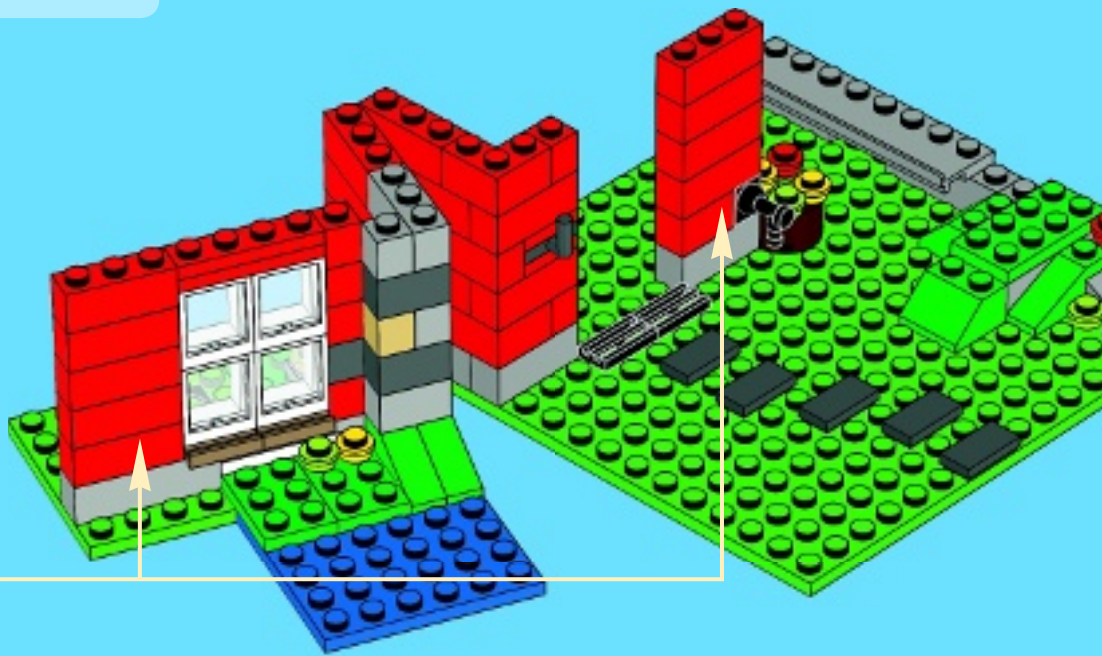

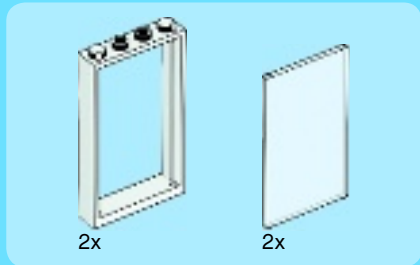

30

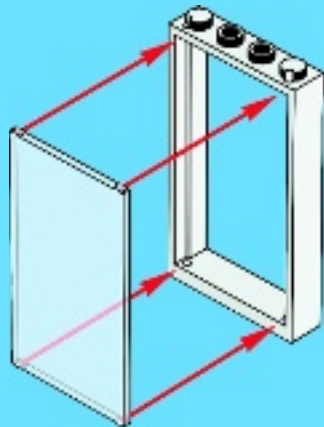

2x

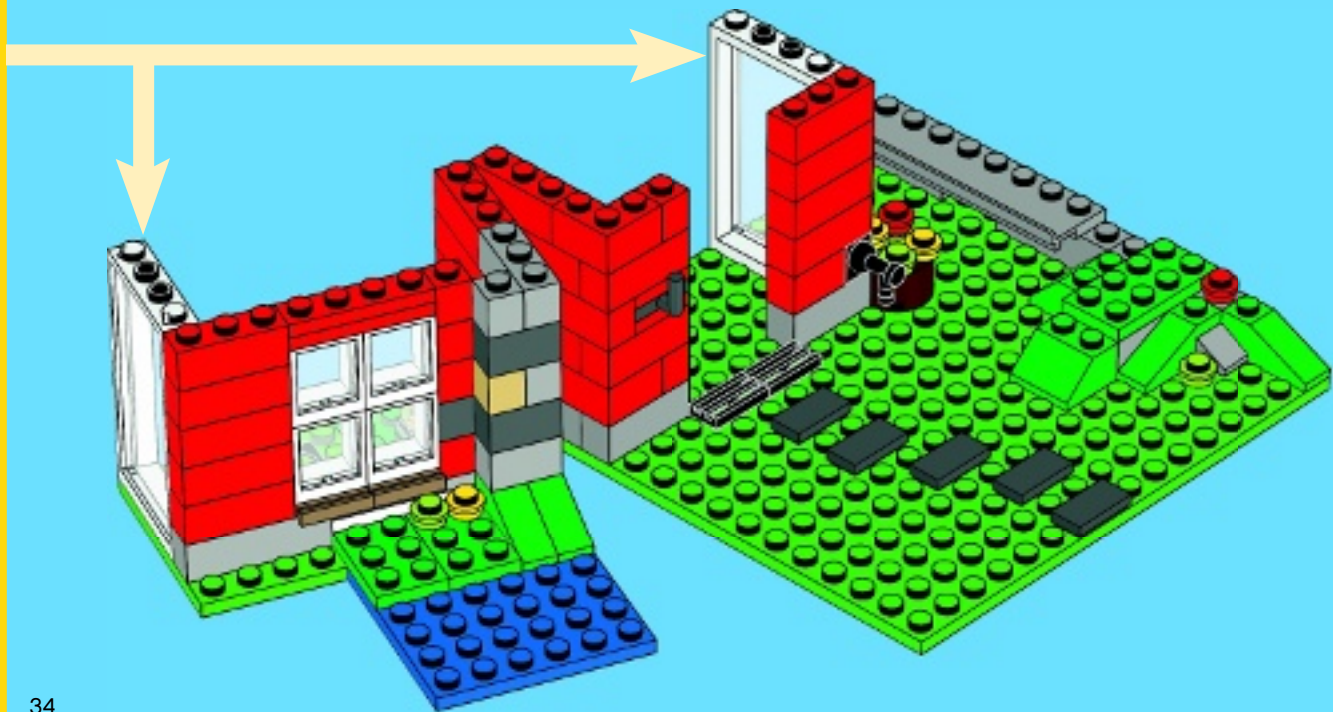

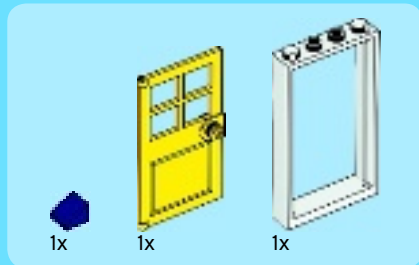

31

1

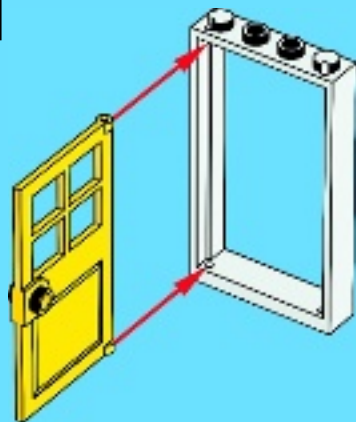

2



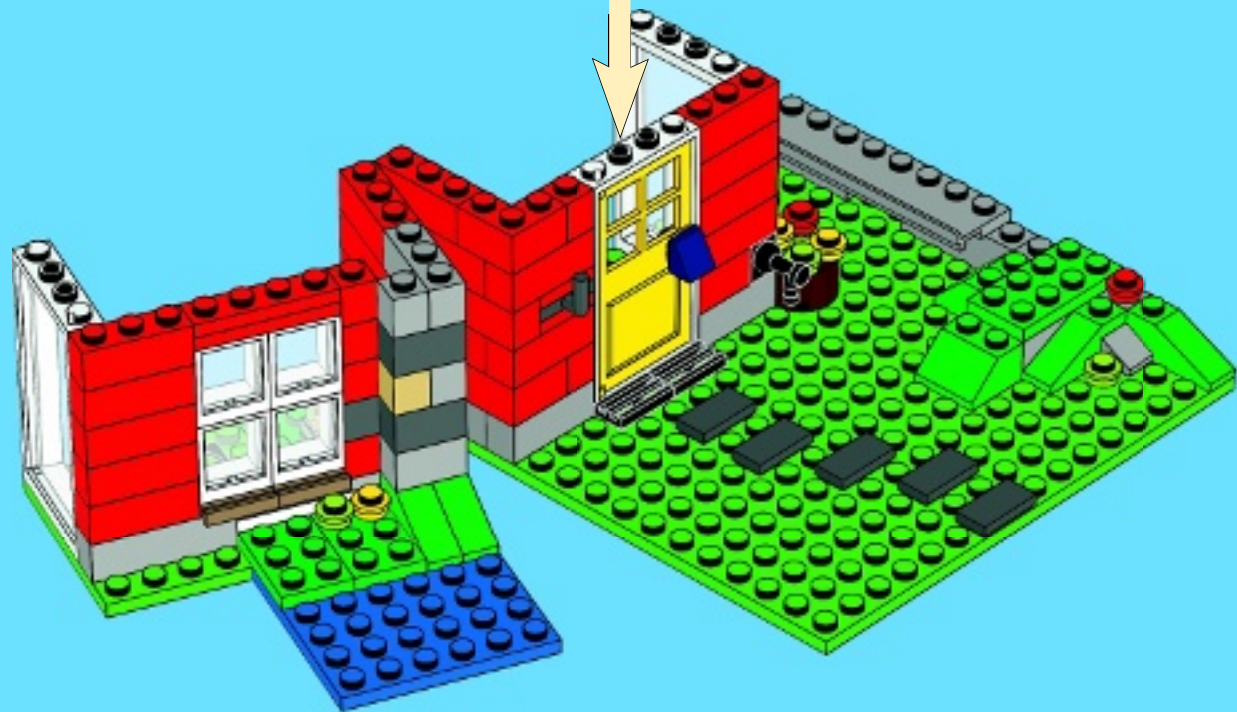

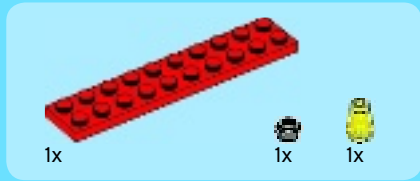

32





1x



1x



1x



1x

33



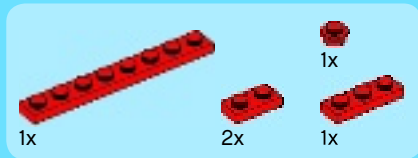

34

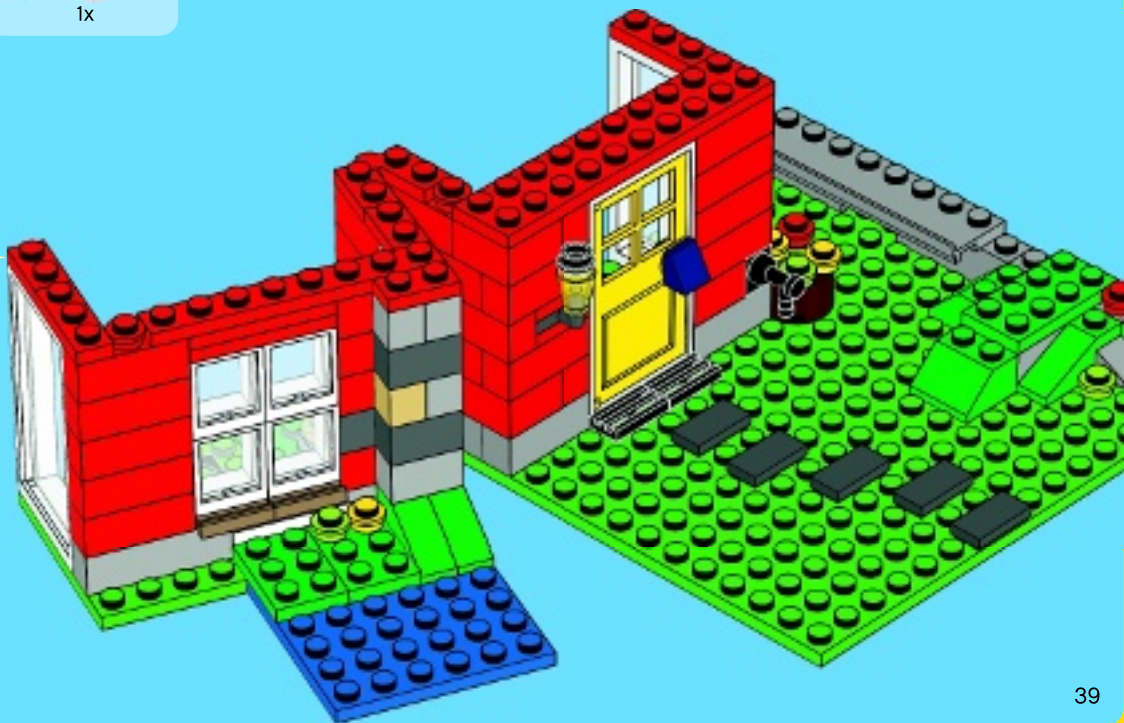



1x



2x



1x



1x



1x

35

1



2



3



4

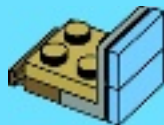

5

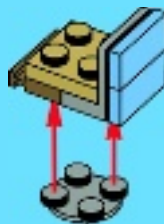

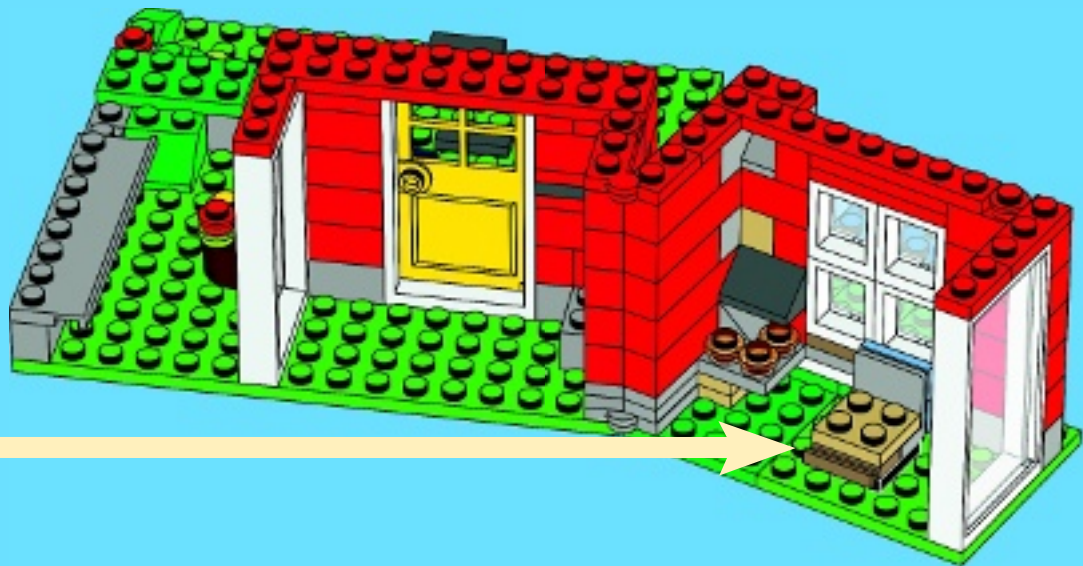



1x



1x



1x

36

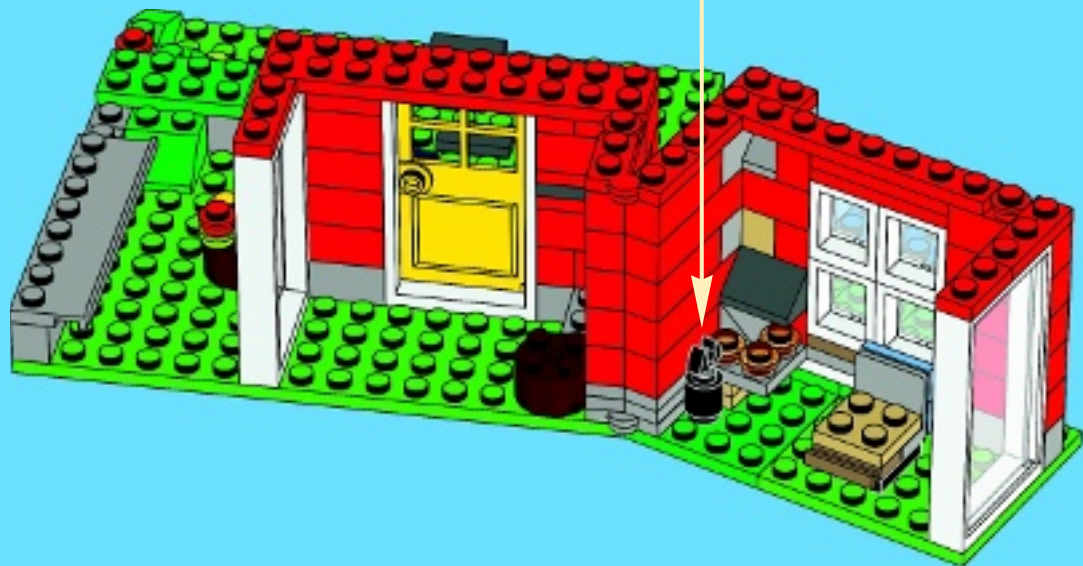



1x



1x



1x



1x



1x



1x



2x



1x

1



2



37

3



4



5



6



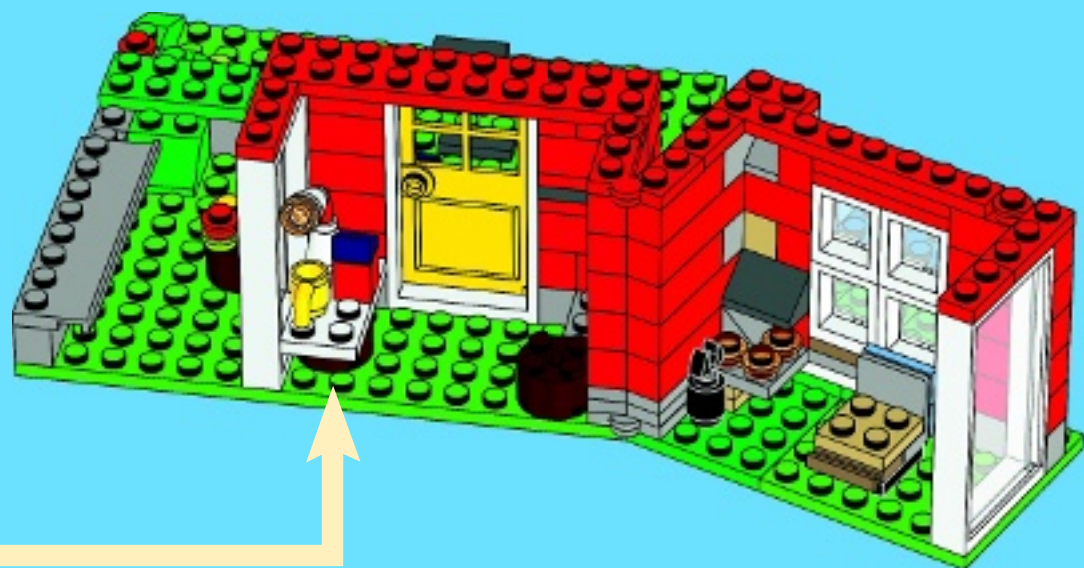



2x



2x

40

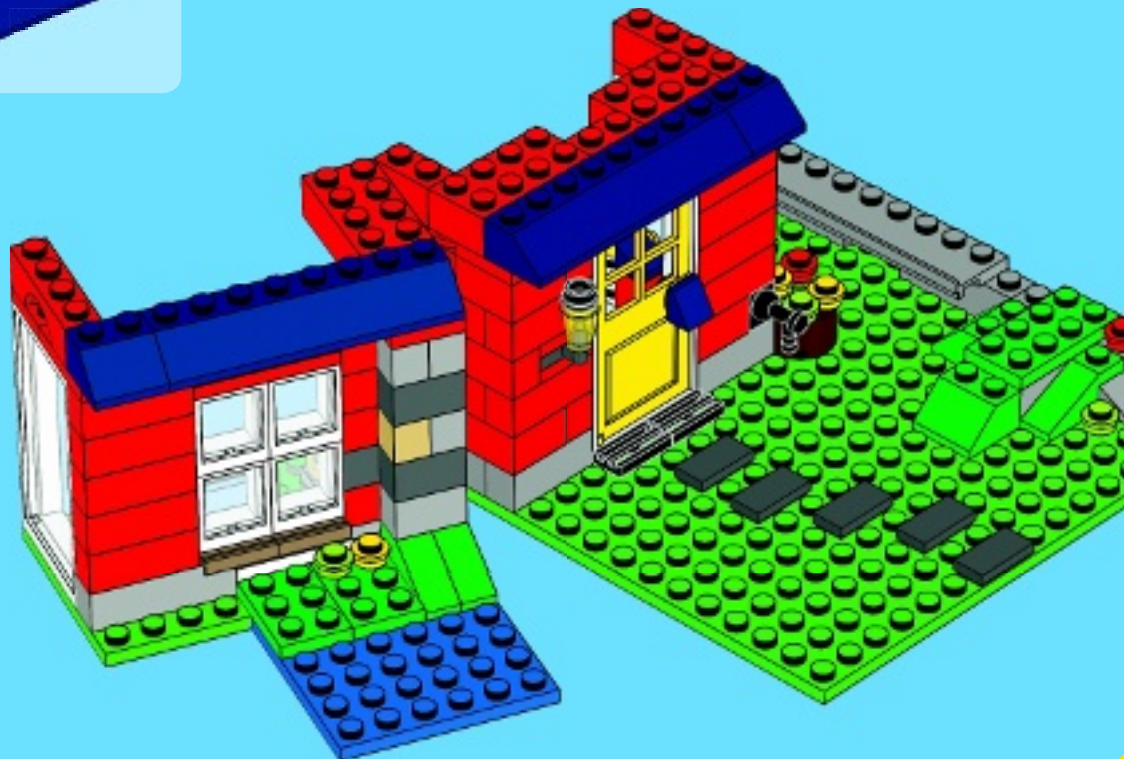



1x



1x



2x



2x

41

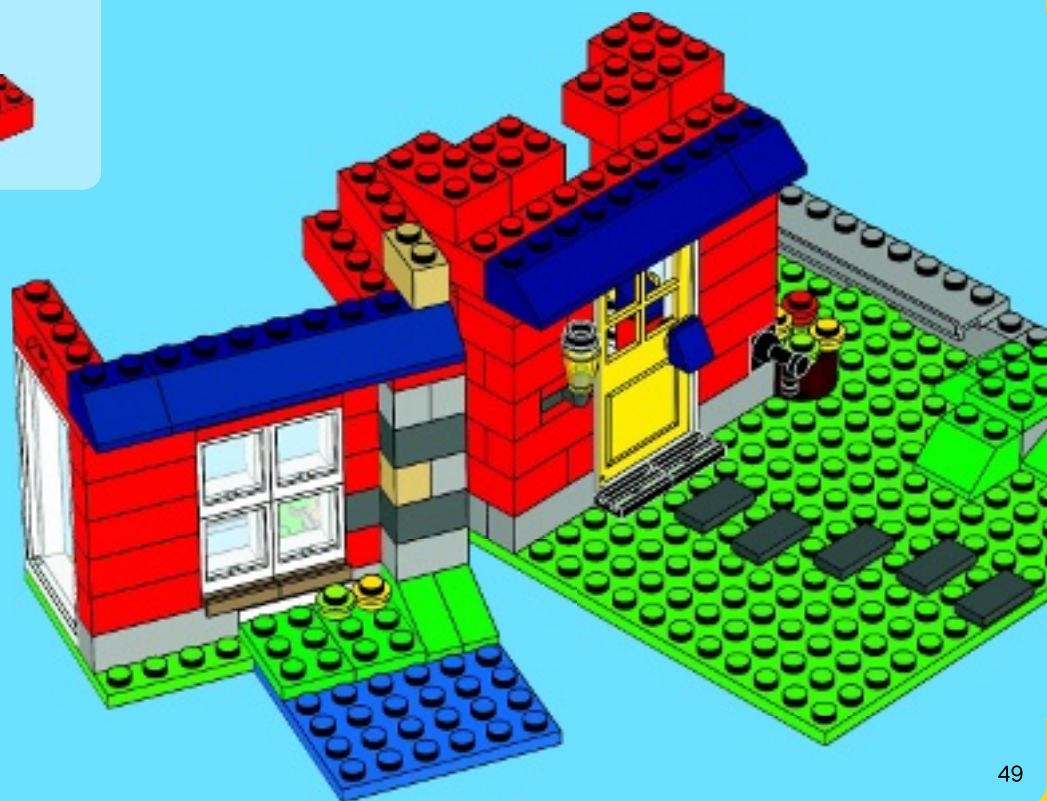



1x



1x

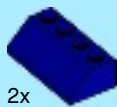

2x

42



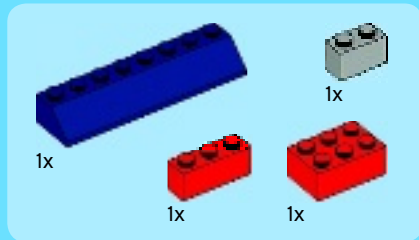

43

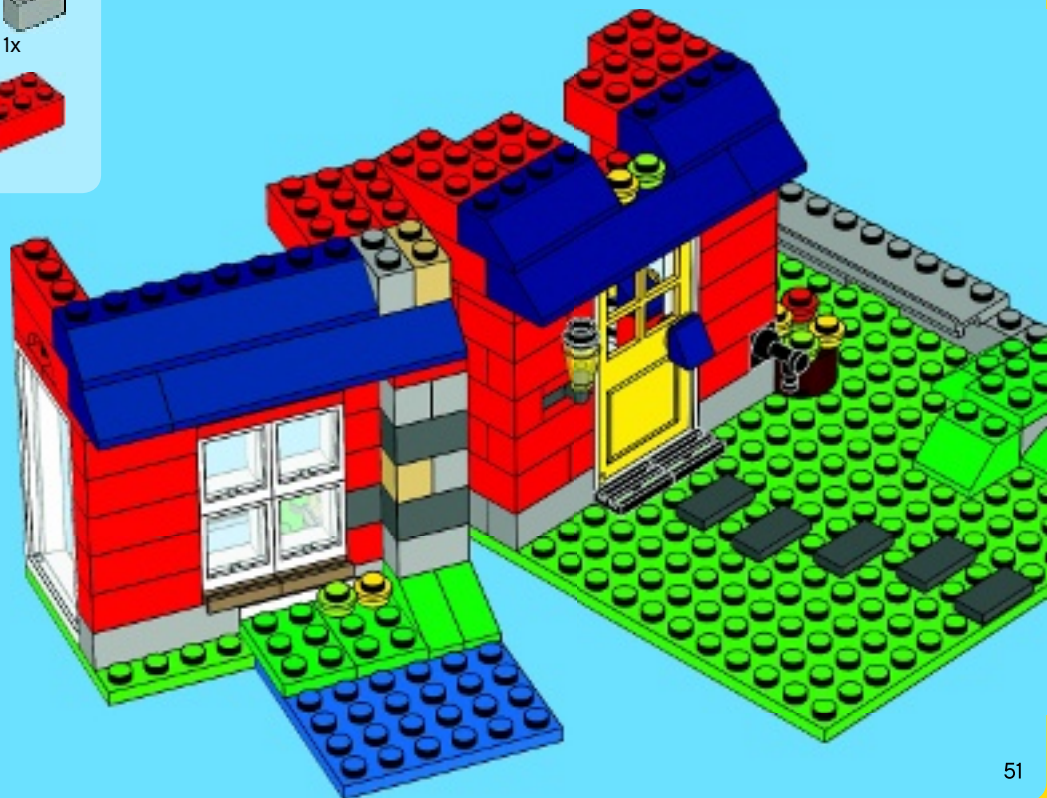



1x



1x



1x



1x

44





1x



1x



2x

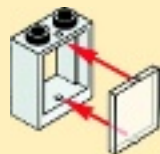

46

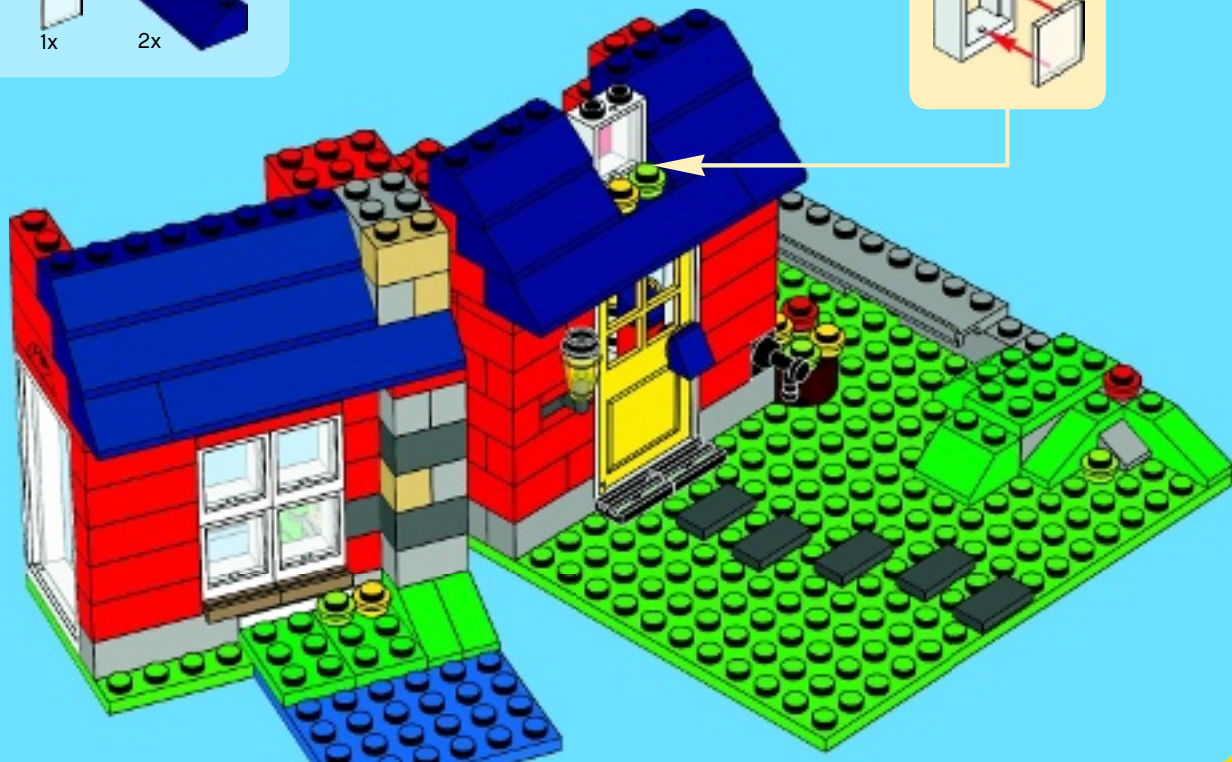



1x



1x



1x



47

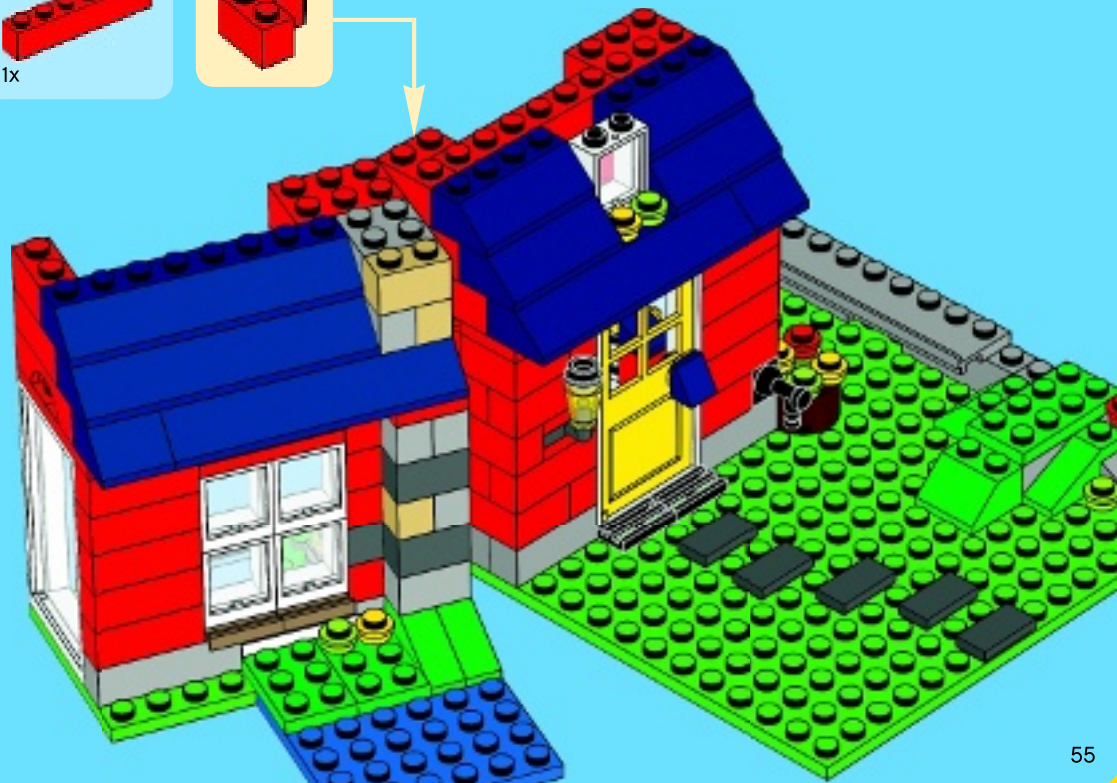



2x



1x



2x

49





3x

50



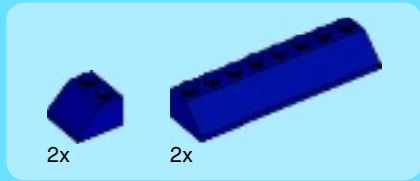

51





1x



1x

52





1x



1x

53

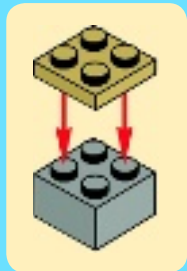



2x



2x

54

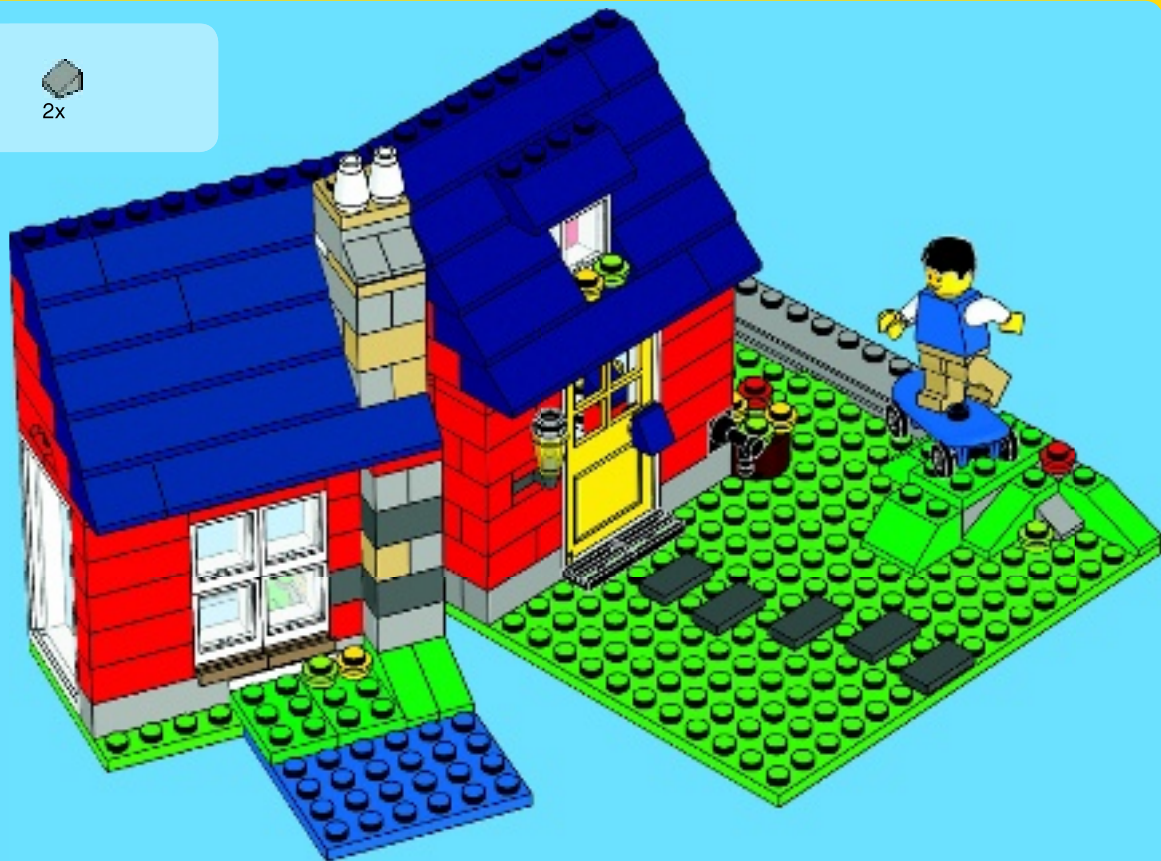



3



www.LEGOclub.com/Max

LEGO club™

FREE*! GRATIS! GRATUIT!

*Paid subscription in Australia and New Zealand.
*Abonnement payant en Australie et Nouvelle-Zélande.

©2013 The LEGO Group.





CREATOR

31008



LEGO and the LEGO logo are trademarks of the/son des marques de commerce de/
son marcas registradas de LEGO Group. ©2013 The LEGO Group. 6038252 / 6038253

LEGO.com/creator

