



IDEAS

21310



GONE BUILDING!

When I was young, I loved to play with LEGO® bricks. I remember that my first set was the 336 Fire Truck. After getting my two sons, my interest was rekindled and we enjoyed building LEGO models together. Especially the Super Heroes sets are a favorite of my sons. Our storage room has been turned into a LEGO room for the boys. Don't ask my wife...

Fishing has always been my hobby. From fishing in the Caribbean, where I lived for a while, to fishing in Holland. So you could say that my interest in fishing and my job as an architectural draughtsman came together in this model.

Inspiration is very important, and so was finding a theme that could help develop the model. I got my initial inspiration from the LEGO Christmas houses and sea villages. I started by doing some sketching on paper, then created a mood board to determine the details and color schemes. Especially the use of the right colors was important in my design.

After submitting the model on LEGO Ideas, people commented and asked about the inside of the building. This was the moment where I decided I could really get creative designing something special for inside. It was a lot of fun. And it also got me thinking that the building could have a seasonal design with different faces for the winter and summer.

It turned out to be a fairly complicated model and it took some time to design the initial house and do the adjustments. It probably took me a couple of months to get it completely as I wanted it to be.

It only took six weeks for the model to reach the 10,000 votes on LEGO Ideas, which was very exciting. It was a lot of fun to read the comments and see that people were really interested in my model.

My tip for people who are considering uploading an idea is to just do it! Use your creativity and have fun. Even the simpler models get lots of votes. And you never know what might happen!

When you start out, the fun part is the idea that your model might be chosen to be developed as a LEGO set. But after submitting my model on the platform, the waiting, the comments from other LEGO Ideas community members and checking out how your model is doing are all very exciting. It all makes you want to check regularly on how things are going, but also to see what other cool designs are uploaded to the platform.



Robert Bontenbal
Fan designer

LEGO® DESIGNER

My task is to make sure that the model lives up to LEGO® quality. It can be quite challenging as I have to respect someone else's design, but at the same time alter it so it fits our guidelines. As a LEGO designer I have to be aware of the many rules and restrictions that a fan designer like Robert doesn't have to worry about. This could be small things like changing elements that are no longer available, or bigger stuff like changing measurements, building techniques or even whole sections of a build.

I tried to stay very true to the original design. That's what got 10,000 votes and is what the people want. I didn't want to change much of the original look and there was no reason to do so. As for the build though, probably not a single brick was left untouched.

It took quite a while to fine tune the measurements so that all the walls could be built with only 1x1, 1x2 and 1x4 bricks. This meant they could interlock and be covered with sand green tiles at the same time. Also the tiles simulating boards on the outside should ideally lock the bricks underneath. There are many ways to do this, but only one really works.

Even with all these structural changes, you would probably be hard pressed to find any major differences between the winning design and the actual product. It was therefore easy for me to discuss the necessary adjustments with Robert.

It was great to be able to bring back certain elements like the seagull, and use others like the lobster that were only previously available in other sets. We also have two new prints and a sticker sheet. I think we did a great job deciding what should be printed and what could be a sticker – and the model doesn't lose much of its appeal if the stickers aren't applied.

It was actually me who suggested the name "Anton's Bait Shop". He's my son and even though he's only seven months old right now, someday he'll be old enough to build the set and to understand the joke.



Adam Grabowski
LEGO designer



PARTI CONSTRUIRE!

Lorsque j'étais jeune, j'adorais jouer avec les briques LEGO®. Je me souviens que mon premier ensemble était le camion de pompiers 336. Après avoir eu mes deux fils, mon intérêt a été ravivé et on aimait construire ensemble des modèles LEGO. Surtout les ensembles de super héros, qui sont les préférés de mes fils. La pièce qui nous servait de débarras a été transformée en une pièce LEGO pour les garçons. N'en parlez pas à ma femme...

La pêche a toujours été une passion. De la pêche dans les Caraïbes, où j'ai vécu pendant un certain temps, à la pêche en Hollande. On peut donc dire que mon intérêt pour la pêche et mon travail de dessinateur en architecture ont été réunis dans ce modèle.

L'inspiration est très importante, tout comme la recherche d'un thème pour mettre au point le modèle. Je me suis tout d'abord inspiré des maisons de Noël et des villages au bord de la mer LEGO. J'ai commencé par faire quelques croquis sur papier et j'ai ensuite créé un tableau d'ambiance pour définir les détails et les palettes de couleurs. L'utilisation des bonnes couleurs a été particulièrement importante dans la conception de mon modèle.



Robert Bontenbal
Fan designer

Après que j'ai publié le modèle sur LEGO Ideas, les gens ont commenté et ont posé des questions sur l'intérieur du bâtiment. C'est à ce moment que je me suis dit que je pouvais vraiment faire preuve de créativité afin d'imaginer quelque chose de spécial pour l'intérieur. Je me suis vraiment amusé. Et j'ai également eu l'idée de donner au bâtiment un style saisonnier grâce à des côtés différents pour l'hiver et pour l'été.

Mon modèle est devenu assez complexe et j'ai pris un certain temps pour concevoir la maison de base et faire les ajustements. Cela m'a pris probablement quelques mois avant d'obtenir exactement ce que je voulais.

Six semaines ont suffi pour que mon modèle atteigne les 10 000 votes sur LEGO Ideas. C'était vraiment excitant. J'ai pris beaucoup de plaisir à lire les commentaires et à découvrir que les gens étaient vraiment intéressés par mon modèle.

Si j'avais un conseil à donner à ceux qui hésitent à publier une idée, ce serait de foncer ! Utilisez votre créativité et amusez-vous. Même les modèles les plus simples peuvent récolter beaucoup de votes. Et on ne sait jamais ce qui pourrait se passer !

Quand vous commencez, le moment amusant est de choisir l'idée qui pourrait permettre à votre modèle d'être sélectionné pour devenir un ensemble LEGO. Mais, après avoir publié mon modèle sur la plateforme, j'étais très enthousiasmé par l'attente, les commentaires des autres membres de la communauté LEGO Ideas et le suivi de l'évolution du modèle. Tout cela vous pousse à suivre régulièrement où en est votre création, mais aussi à découvrir les autres conceptions super cool qui sont publiées sur la plateforme.

LE DESIGNER LEGO®

Mon travail est de m'assurer que le modèle soit à la hauteur de la qualité LEGO®. Cela peut s'avérer délicat parce que je dois respecter la création de quelqu'un tout en la modifiant pour qu'elle corresponde à nos normes. En tant que designer LEGO, je dois prendre en considération de nombreuses règles et restrictions dont un fan designer comme Robert n'a pas à se préoccuper. Il pourrait s'agir de détails subtils comme le remplacement d'éléments qui ne sont plus disponibles ou de modifications plus importantes comme des mesures ou des techniques de construction différentes ou la création de sections entières d'une construction.

J'ai essayé de rester très fidèle à la conception d'origine. C'est ce qui a obtenu 10 000 votes et c'est aussi ce que veulent les gens. Je ne voulais pas beaucoup modifier l'apparence d'origine, et il n'y avait aucune raison de le faire. Toutefois, pour ce qui est de la construction, chacune des briques a été passée en revue.

Cela a pris un certain temps pour ajuster parfaitement les mesures de sorte que tous les murs puissent être construits seulement avec des briques 1x1, 1x2 et 1x4. Cela signifiait qu'ils pouvaient s'assembler et être recouverts de tuiles vert sable en même temps. En outre, il était préférable que les tuiles qui représentent les planches s'emboîtent dans les briques en dessous. Même s'il existe de nombreuses façons de le faire, une seule est vraiment efficace.

Malgré toutes ces modifications relatives à la structure, vous aurez probablement du mal à trouver des différences flagrantes entre le modèle gagnant et le produit fini. J'ai donc pu aisément discuter de ces ajustements nécessaires avec Robert.

C'était génial de pouvoir réintégrer certains éléments comme la mouette, et d'en utiliser d'autres comme le homard qui étaient uniquement disponibles dans d'anciens ensembles. Nous avons également deux nouveaux motifs imprimés et une feuille d'autocollants. Je pense que nous avons fait du bon travail en choisissant ce qu'il était préférable d'imprimer et les éléments qui pouvaient devenir des autocollants, sans pour autant que le modèle perde de son attrait si ceux-ci ne sont pas placés.

En réalité, c'est moi qui ai suggéré le nom « Anton's Bait Shop ». Anton est mon fils et même s'il n'a que sept mois aujourd'hui, il sera un jour assez grand pour construire l'ensemble et comprendre le clin d'œil.



Adam Grabowski
Designer LEGO



¿ME FUI A CONSTRUIR!

Cuando era pequeño, me encantaba jugar con mis bricks LEGO®. Recuerdo que lo primero que construí fue el set Fire Truck (336). Cuando tuve a mis dos hijos, el interés se reavivó en mí y disfrutamos mucho construyendo modelos LEGO juntos. Los favoritos de mis hijos son los sets Super Heroes. La bodega que teníamos en casa se ha convertido en un cuarto específico para que los niños construyan con LEGO. No le pregunten a mi esposa...

Siempre he sido aficionado a la pesca. He pescado en el Caribe, donde viví durante un tiempo, y también en Holanda. Se podría decir que mi interés por la pesca y mi trabajo como dibujante arquitectónico van de la mano en este modelo.

La inspiración era muy importante, casi tanto como encontrar un tema que me ayudara a desarrollar el modelo. Al principio me inspiré en las construcciones navideñas y los pueblos de la costa que representan los sets LEGO. Comencé dibujando un borrador en papel y después creé un tablón para estudiar los detalles y colores. El uso de los colores correctos era particularmente importante para mi diseño.

Luego de enviar el modelo a LEGO Ideas, la gente empezó a comentar y preguntar sobre el interior del edificio. Fue entonces cuando pensé que podría diseñar algo realmente creativo y especial para el interior. Fue muy divertido. Además, eso me llevó a la idea de que el edificio tuviera un diseño estacional, con fachadas diferentes para el invierno y el verano.

Al final resultó ser bastante complicado: me tomó algo de tiempo diseñar la primera casa y llevar a cabo los ajustes necesarios. Es posible que pasaran un par de meses hasta que logré que todo estuviera como yo quería.

Sólo hicieron falta seis semanas para que el modelo recibiera los 10.000 votos en LEGO Ideas, lo cual me pareció increíble. Me divertí mucho leyendo los comentarios y descubriendo que la gente estaba realmente interesada en mi modelo.

Mi consejo para la gente que esté considerando enviar una idea es: ¡háganlo! Usen su creatividad y diviértanse. Incluso los modelos más sencillos reciben muchos votos. ¡Y nunca se sabe lo que puede suceder!

Lo más divertido al principio es pensar que tu modelo podría ser elegido para convertirse en un set LEGO. Sin embargo, luego de enviar mi modelo a la plataforma, la espera, recibir comentarios de otros miembros de la comunidad de LEGO Ideas y consultar qué tal estaba funcionando el modelo fueron experiencias muy emocionantes. Todo te invita a revisar con frecuencia cómo le está yendo a tu modelo, pero también a descubrir otros diseños asombrosos que se envían a la plataforma.



Robert Bontenbal
Fan diseñador

EL DISEÑADOR DE LEGO®

Mi tarea consistió en asegurarme de que el modelo estuviera a la altura de los estándares de calidad de LEGO®. A veces es complicado, porque tienes que respetar el diseño de otra persona y, al mismo tiempo, alterarlo para que se ajuste a nuestras directrices. Como diseñador de LEGO, tengo que tomar en cuenta muchas reglas y restricciones de las que un fan diseñador como Robert no tiene que preocuparse. Pueden ser cosas pequeñas, como cambiar los elementos que ya no están disponibles, u otras más grandes, como alterar las medidas, las técnicas de construcción o incluso partes enteras de un modelo.

En este caso, intenté ser lo más fiel posible al diseño original. Es lo que recibió 10.000 votos y lo que la gente quiere. No quería cambiar mucho del aspecto general y no había razón para hacerlo. En cuanto al modelo en sí, no obstante, es posible que no haya ni un solo brick que no haya recibido algún cambio.

Nos costó bastante ajustar las medidas para que todas las paredes se pudieran construir usando bricks 1x1, 1x2 y 1x4. Era la única manera en que podían embonarse entre sí y se pudieran cubrir con cubiertas verde arena. Además, lo ideal era que las cubiertas exteriores mantuvieran unidos los bricks que había debajo. Hay muchas formas de hacer esto, pero sólo una funciona realmente.

Incluso con todos estos cambios estructurales, todavía es difícil encontrar grandes diferencias entre el diseño ganador y el producto final. Fue fácil, por tanto, discutir los ajustes necesarios con Robert.

Fue fantástico recuperar ciertos elementos, como la gaviota, y usar otros, como la langosta, que antes sólo estaban disponibles en otros sets. También tenemos dos nuevas decoraciones impresas y una hoja de calcomanías. Creo que hicimos un gran trabajo al decidir lo que se tenía que imprimir y lo que podría estar en una calcomanía; y lo cierto es que el modelo no pierde mucho de su atractivo si no se le ponen las calcomanías.

En realidad, fui yo quien sugirió el nombre "Anton's Bait Shop". Anton es el nombre de mi hijo y a pesar de que ahora sólo tiene siete meses, algún día crecerá lo suficiente como para construir el set y comprender el chiste.



Adam Grabowski
Diseñador de LEGO



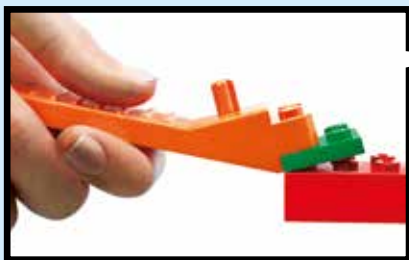

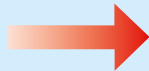

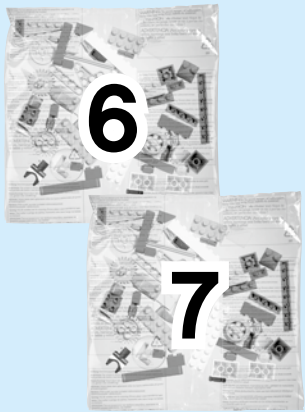

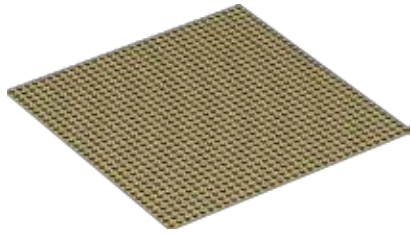

+

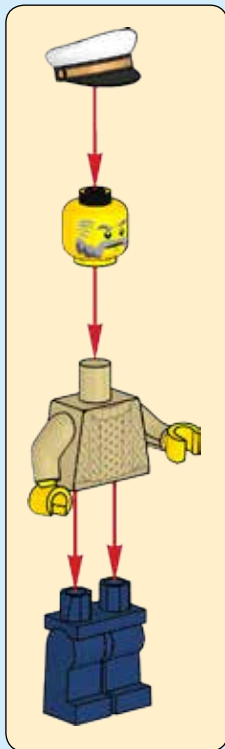
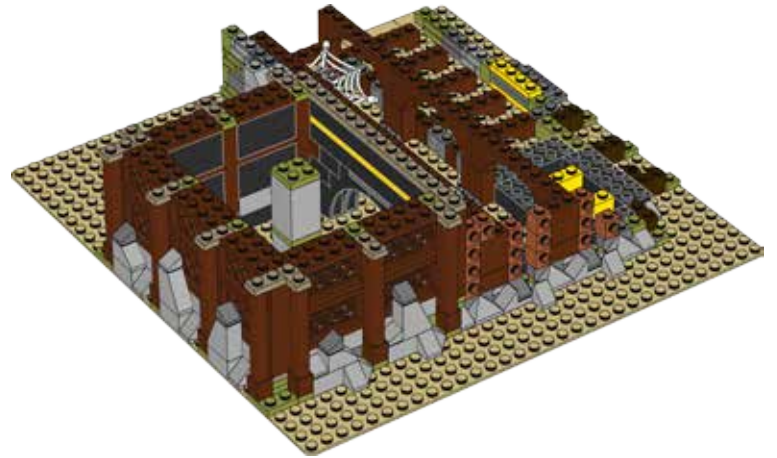

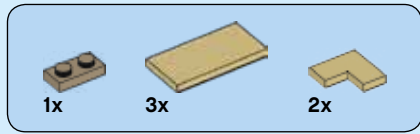

1

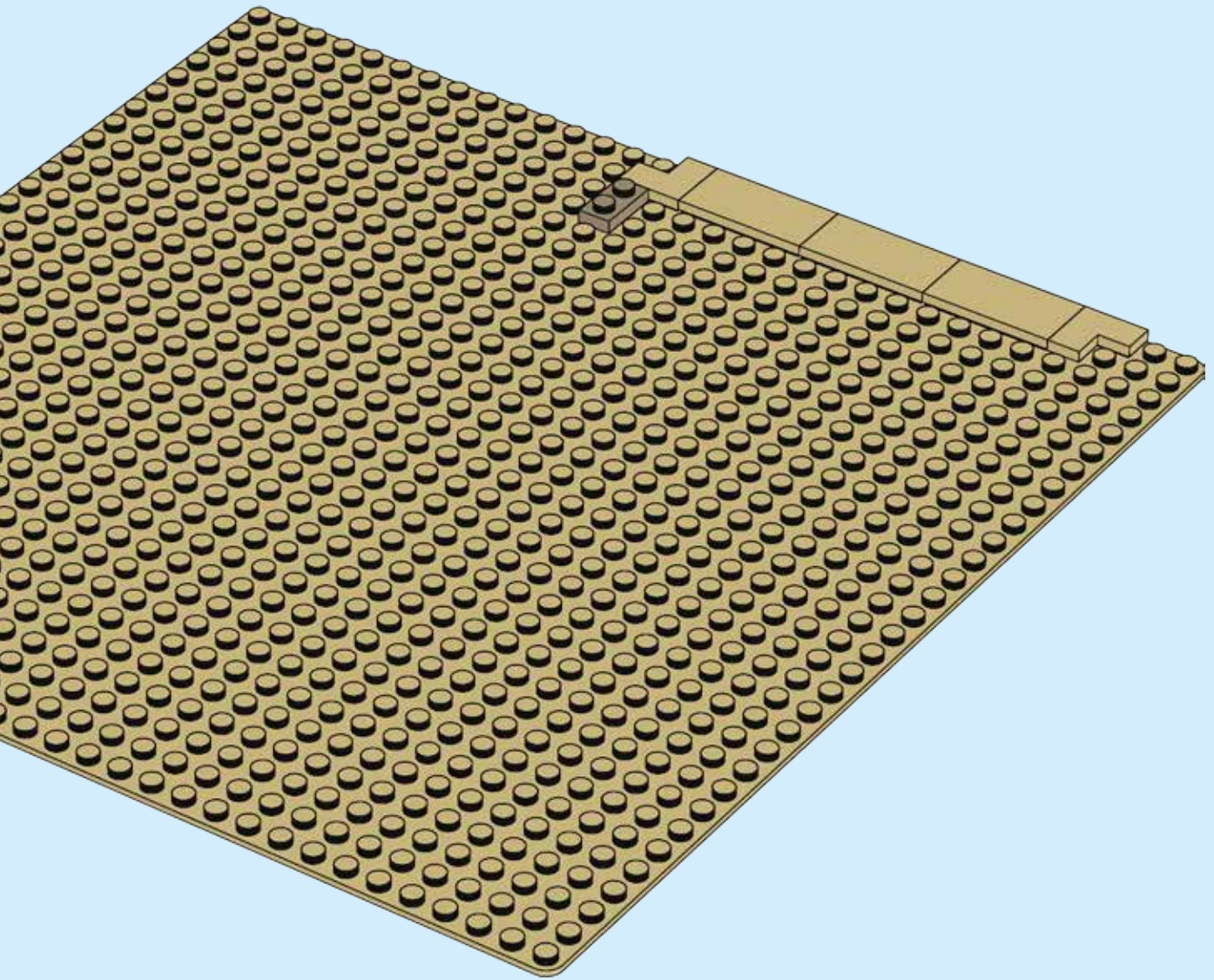

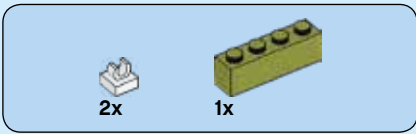

2

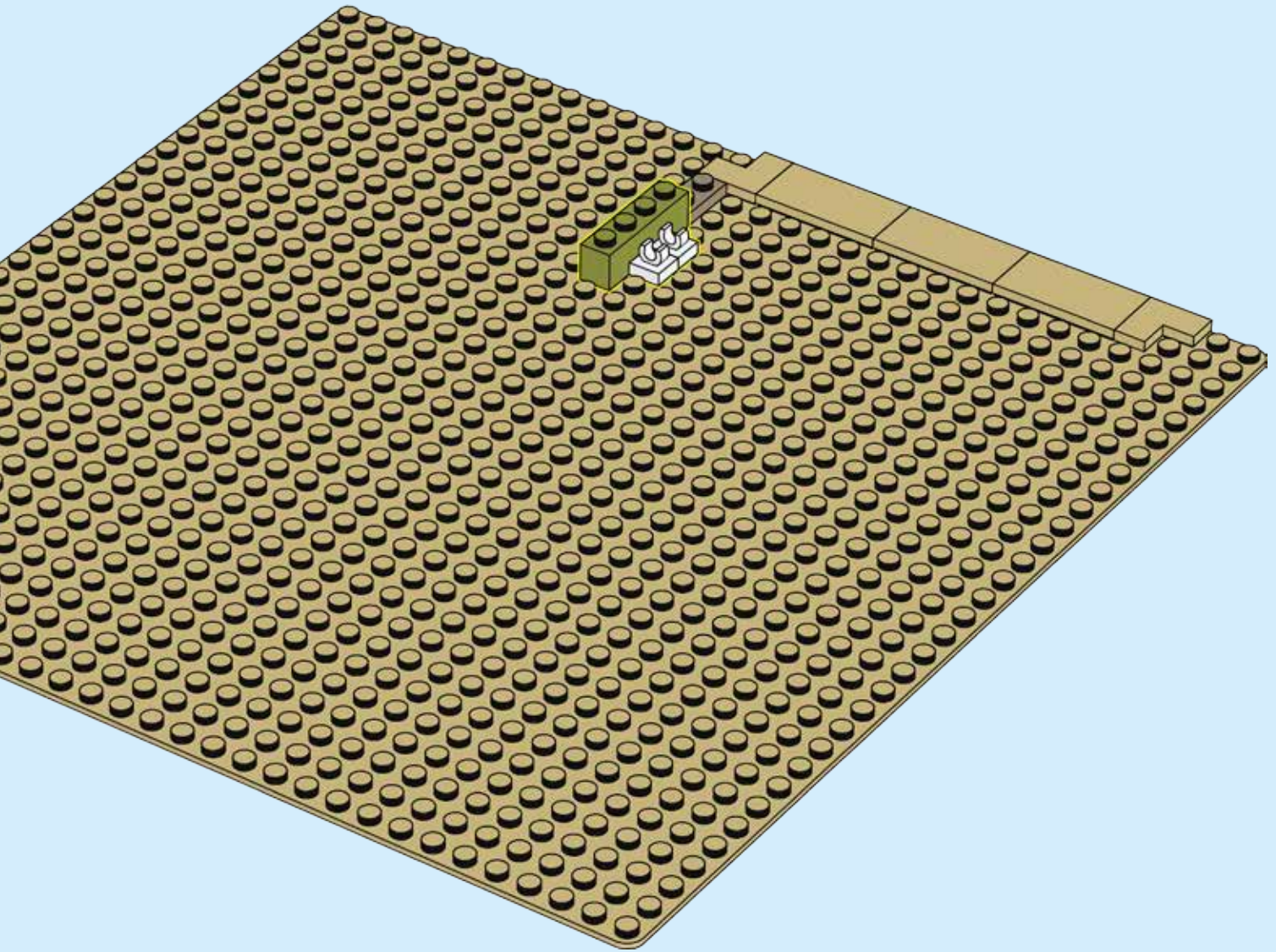

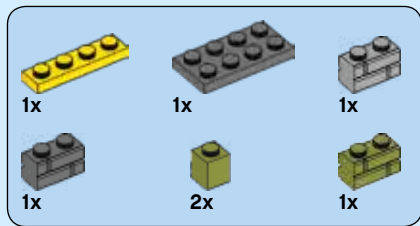

3

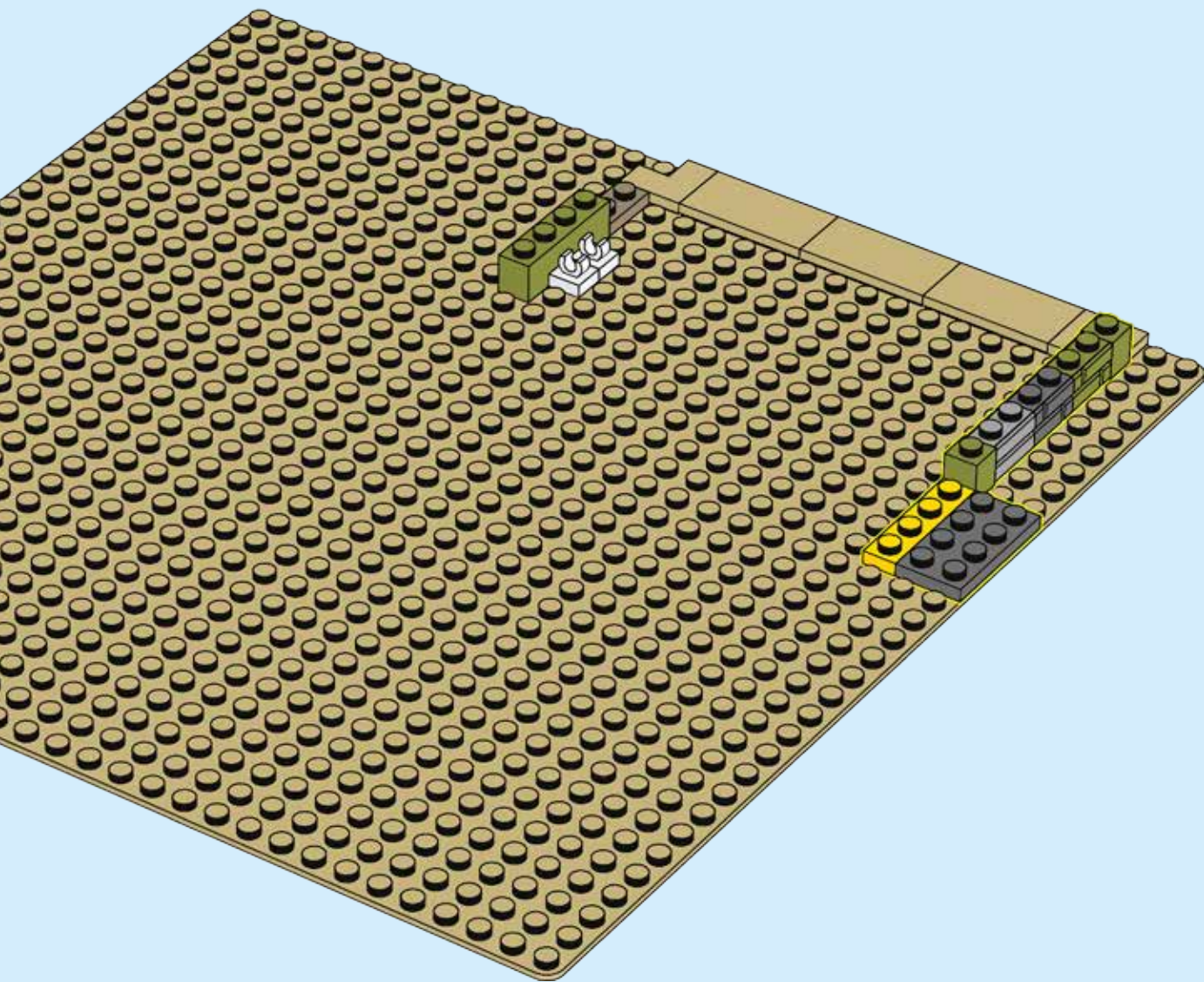

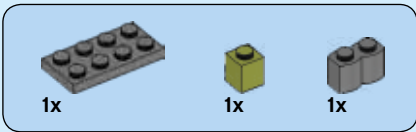

4

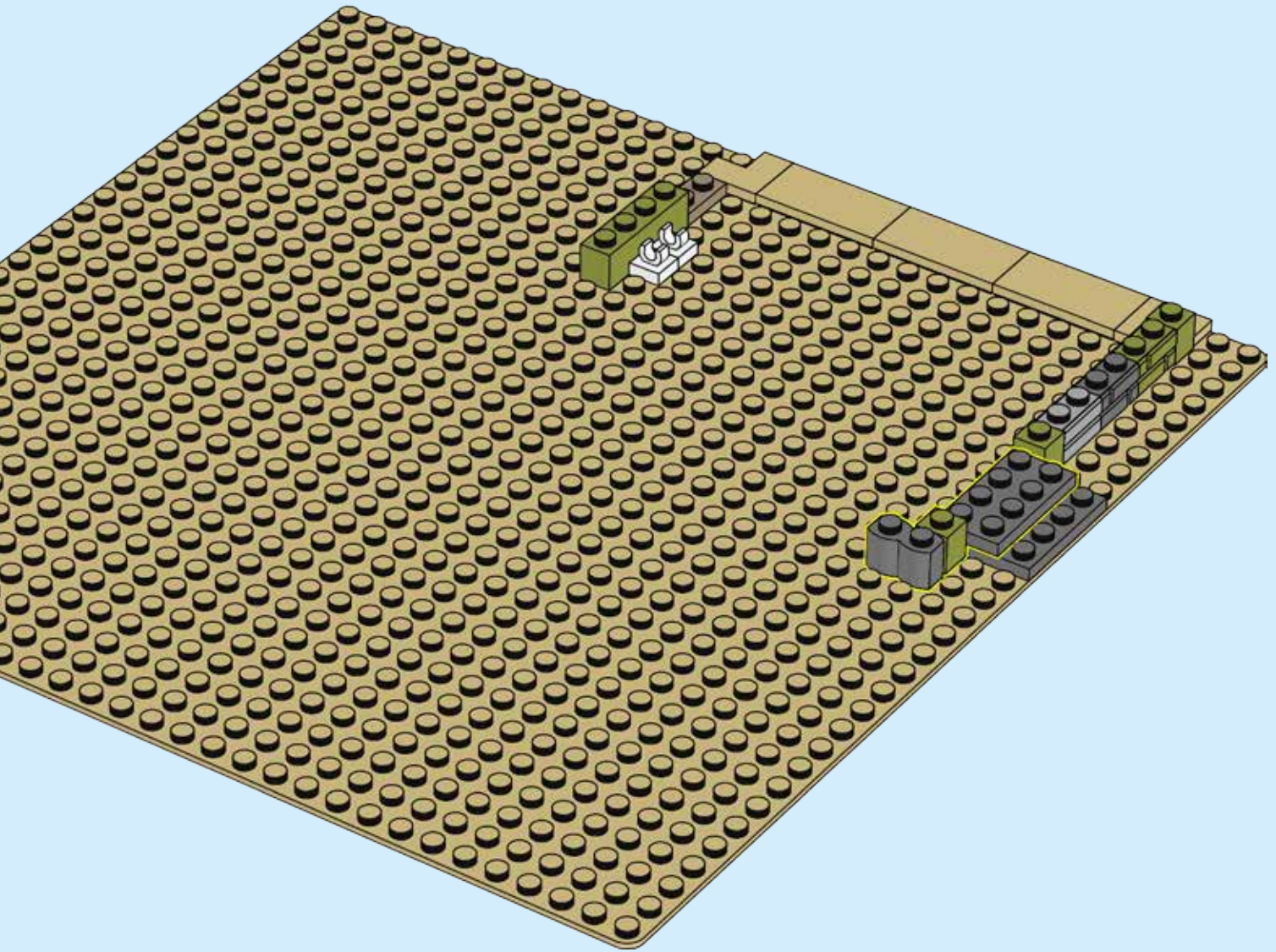

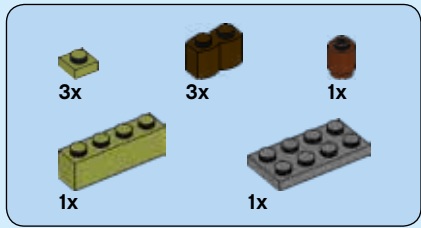

5

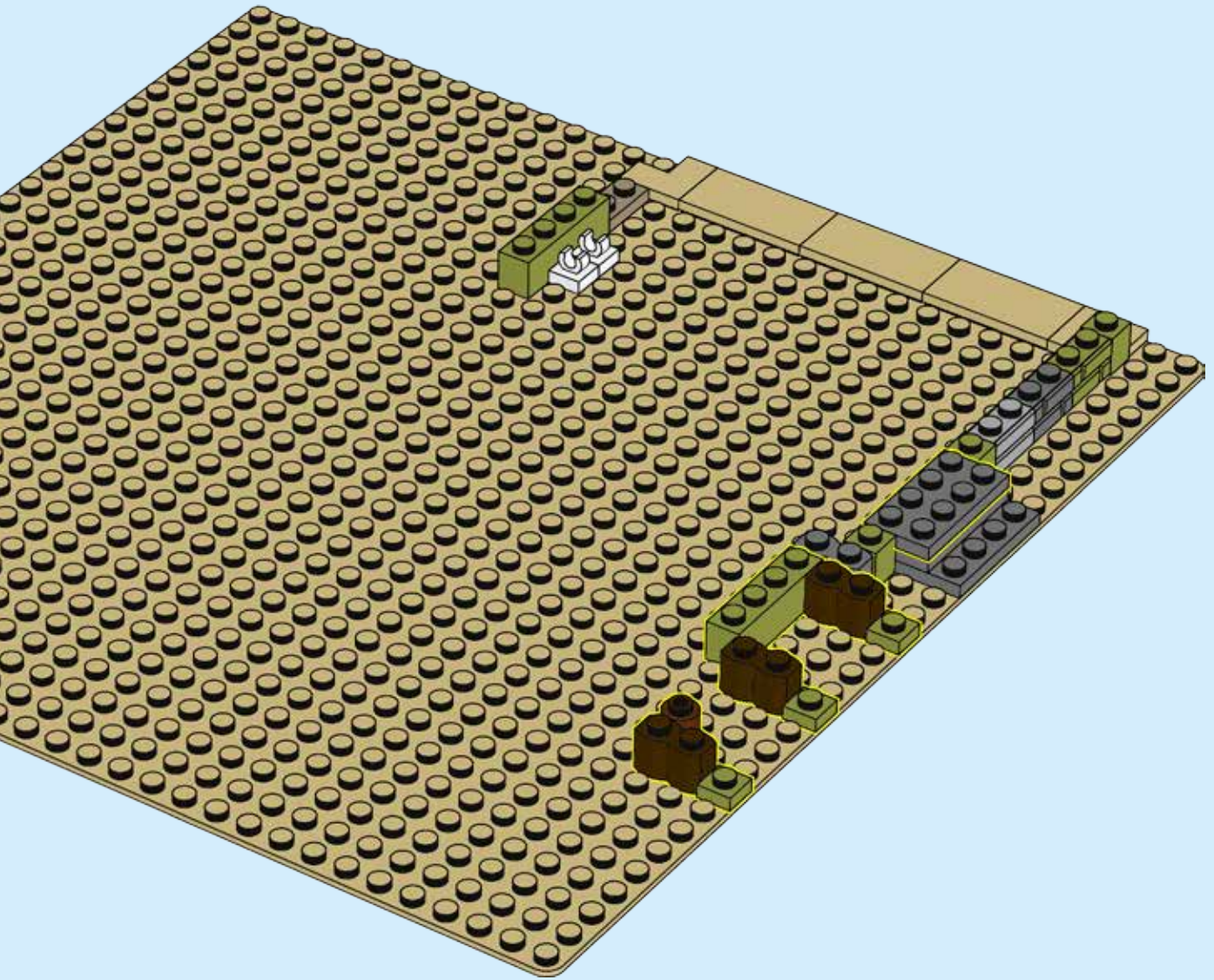

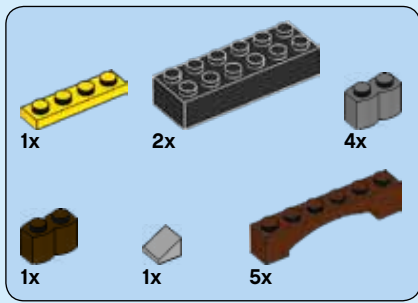

6

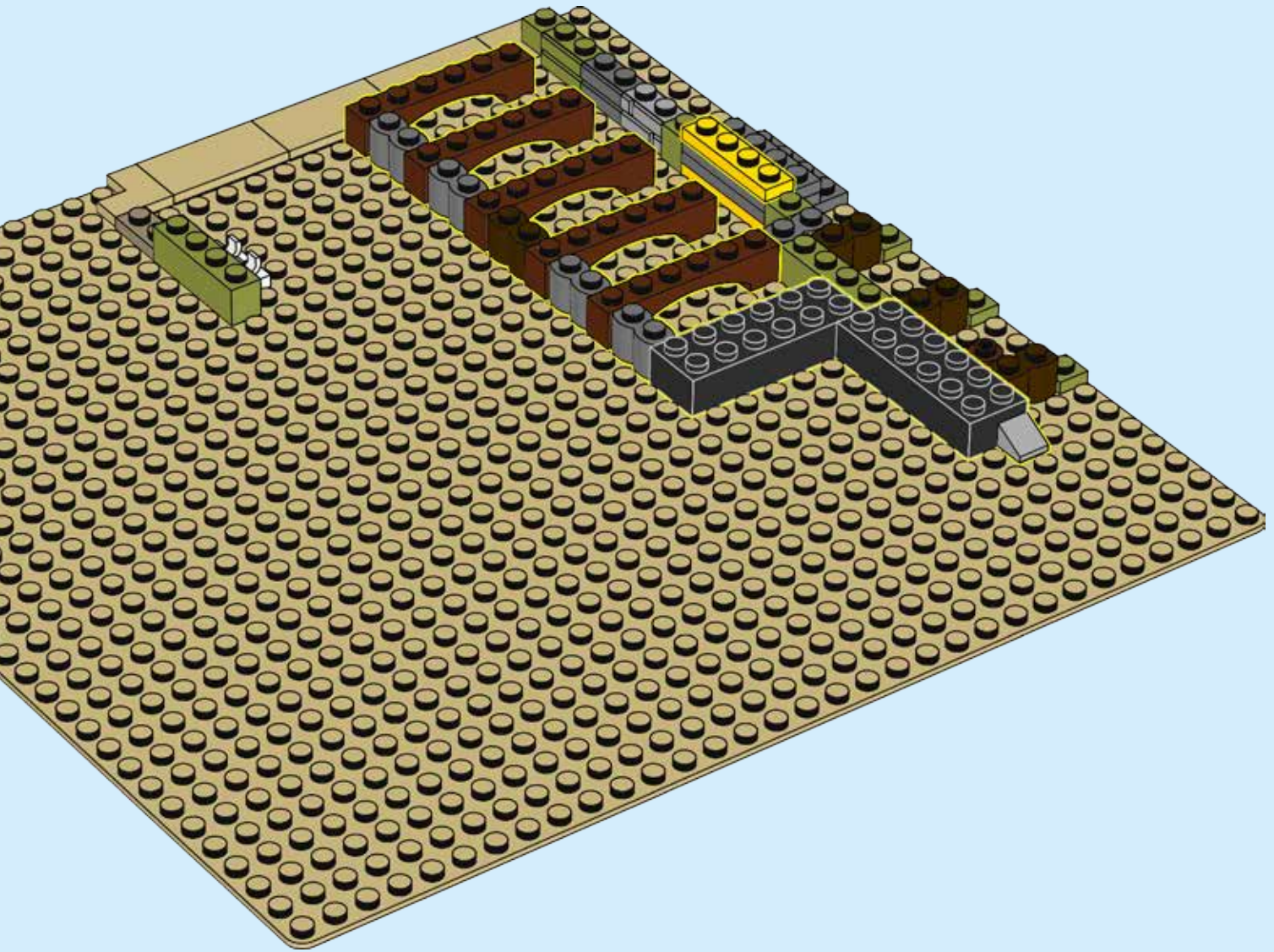

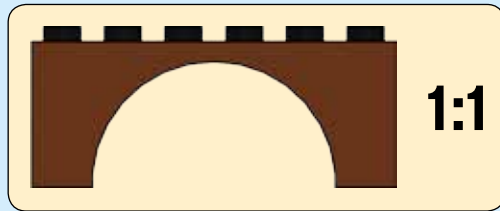
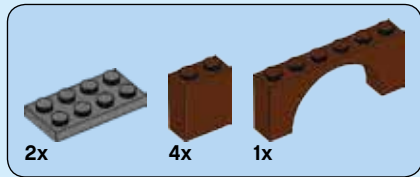

7

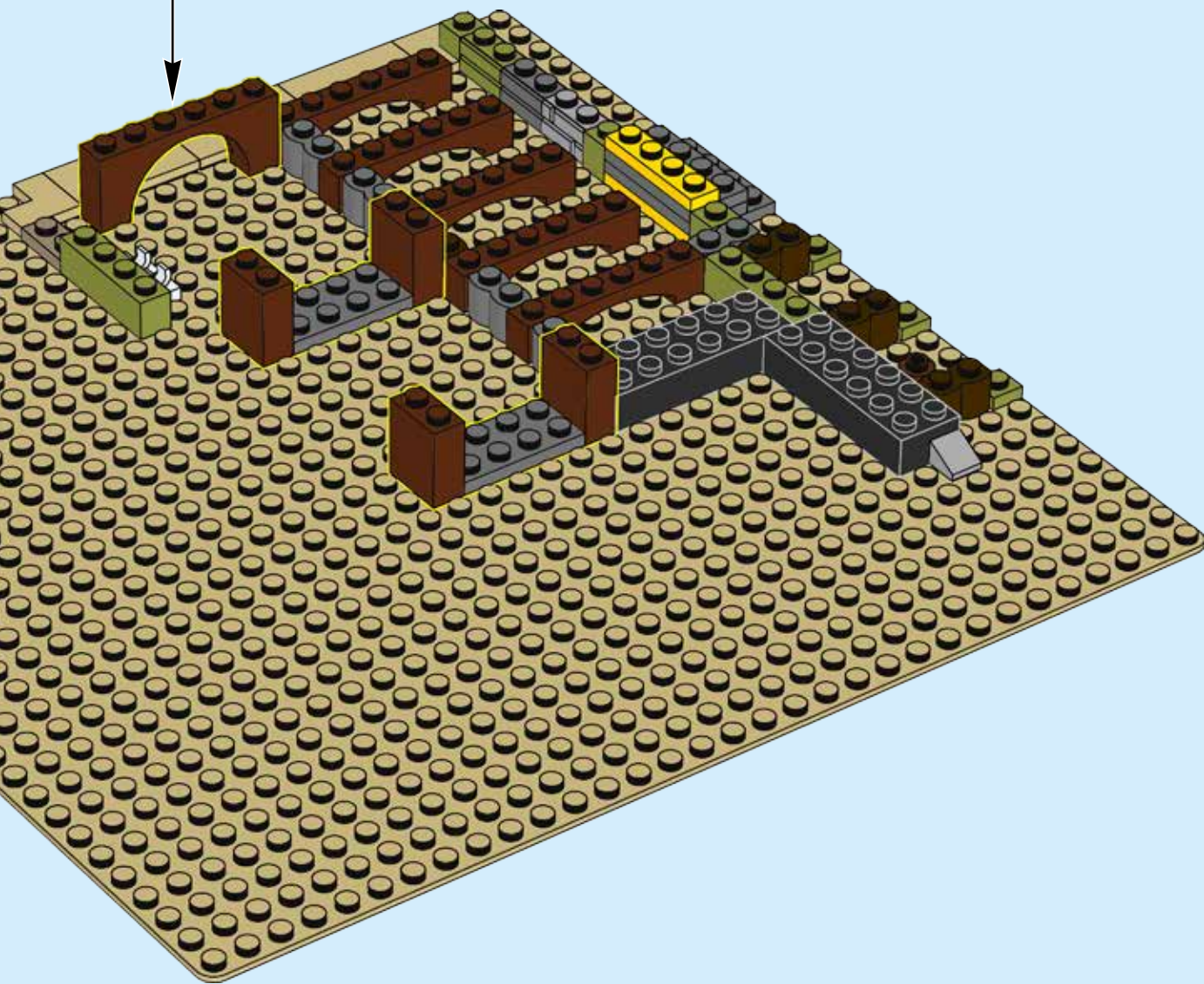

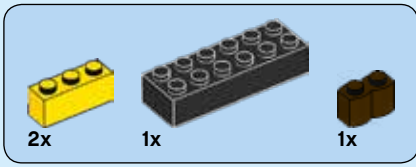

8

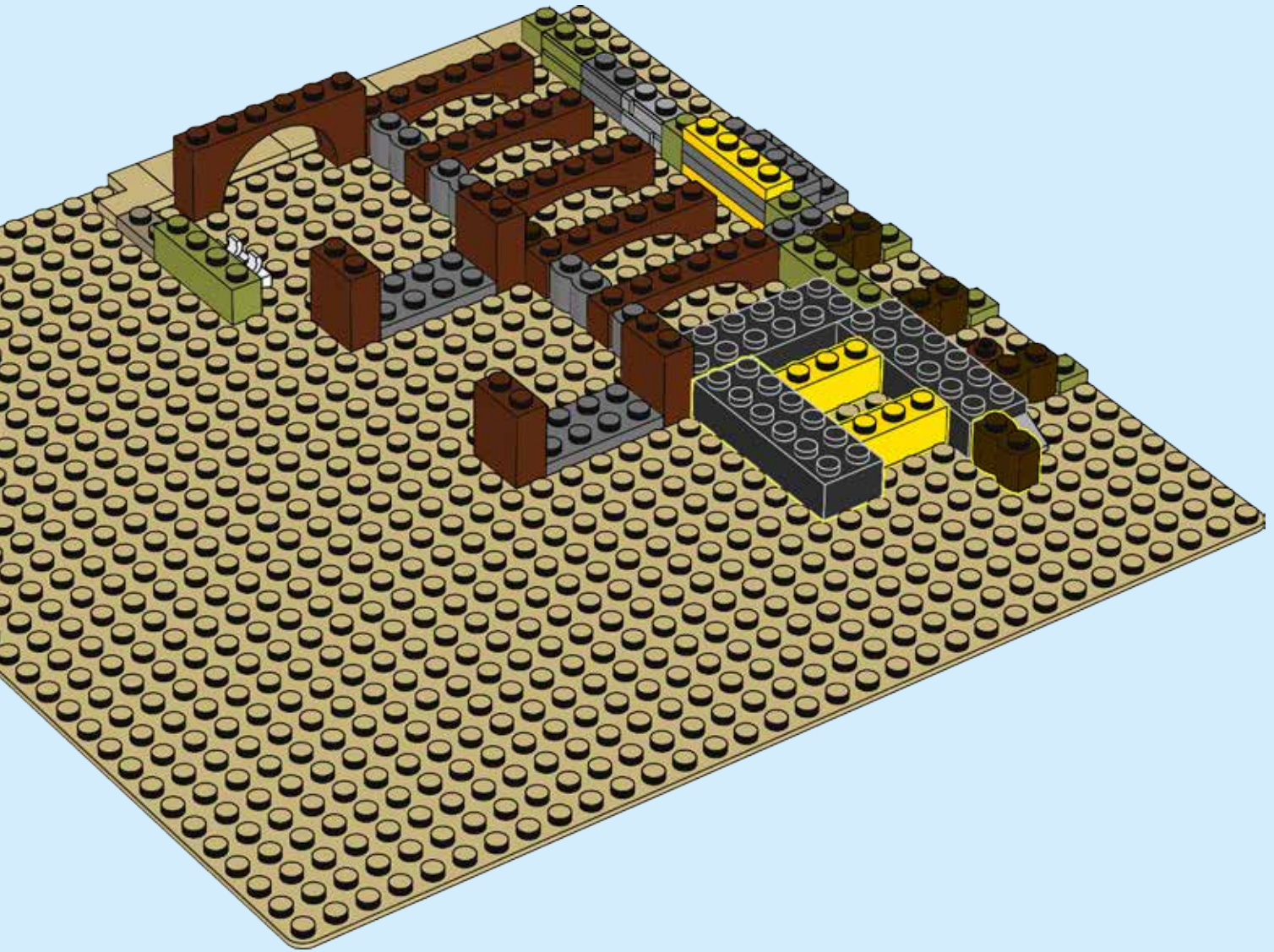

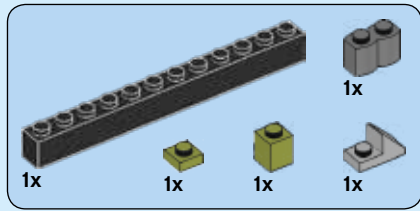

9

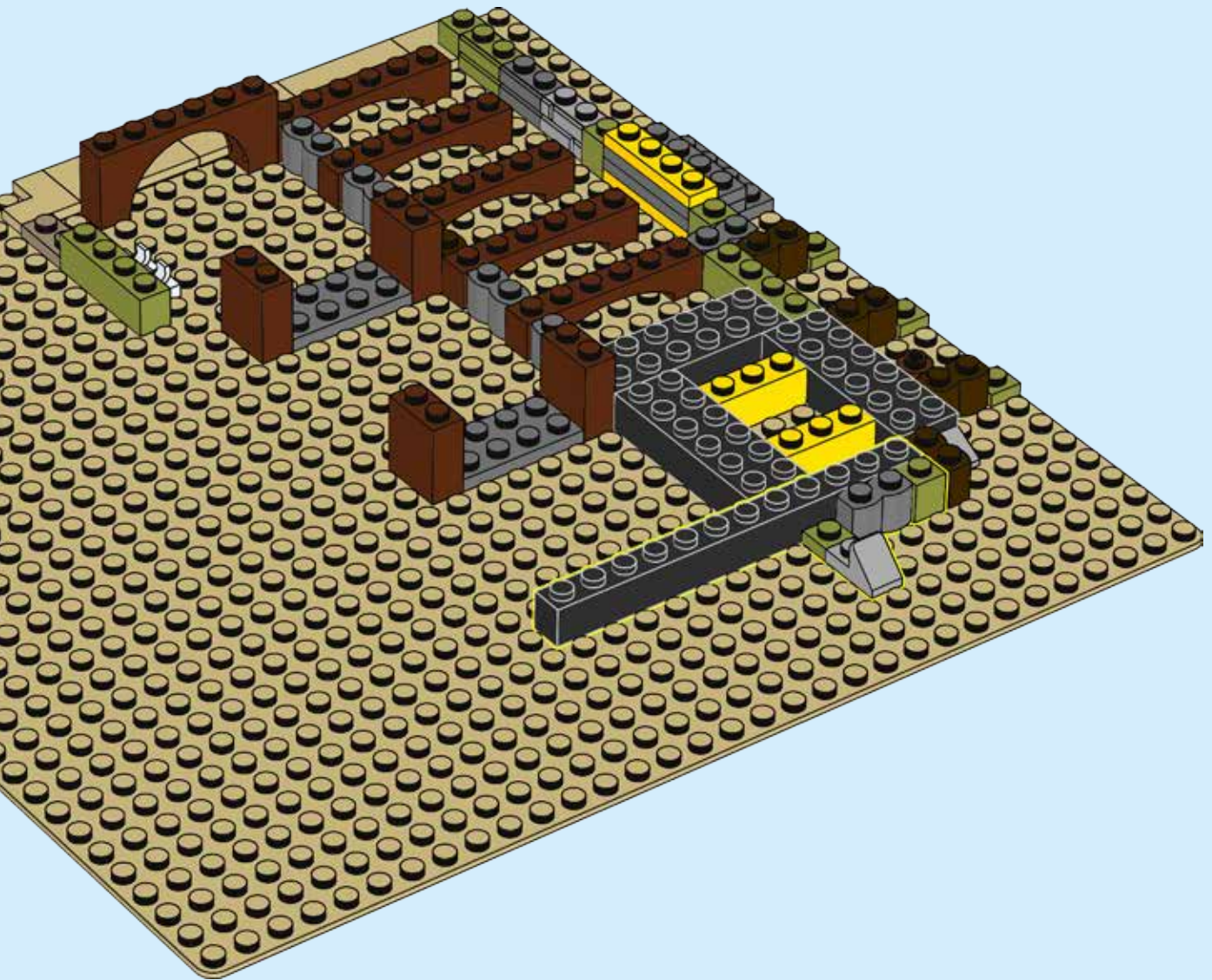

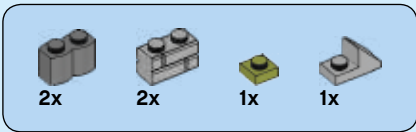

10

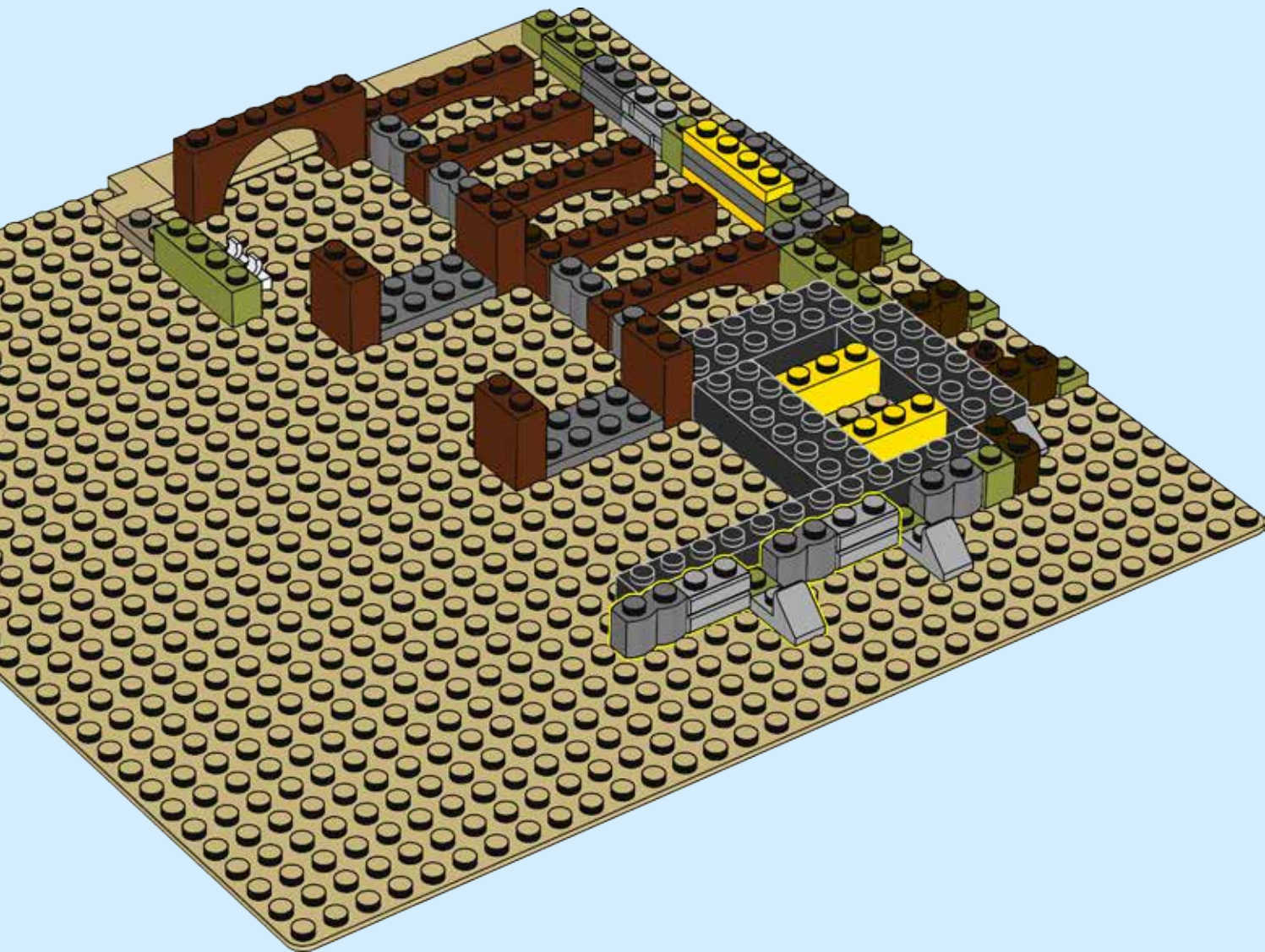

2x 1x 1x 3x 2x

11

2x

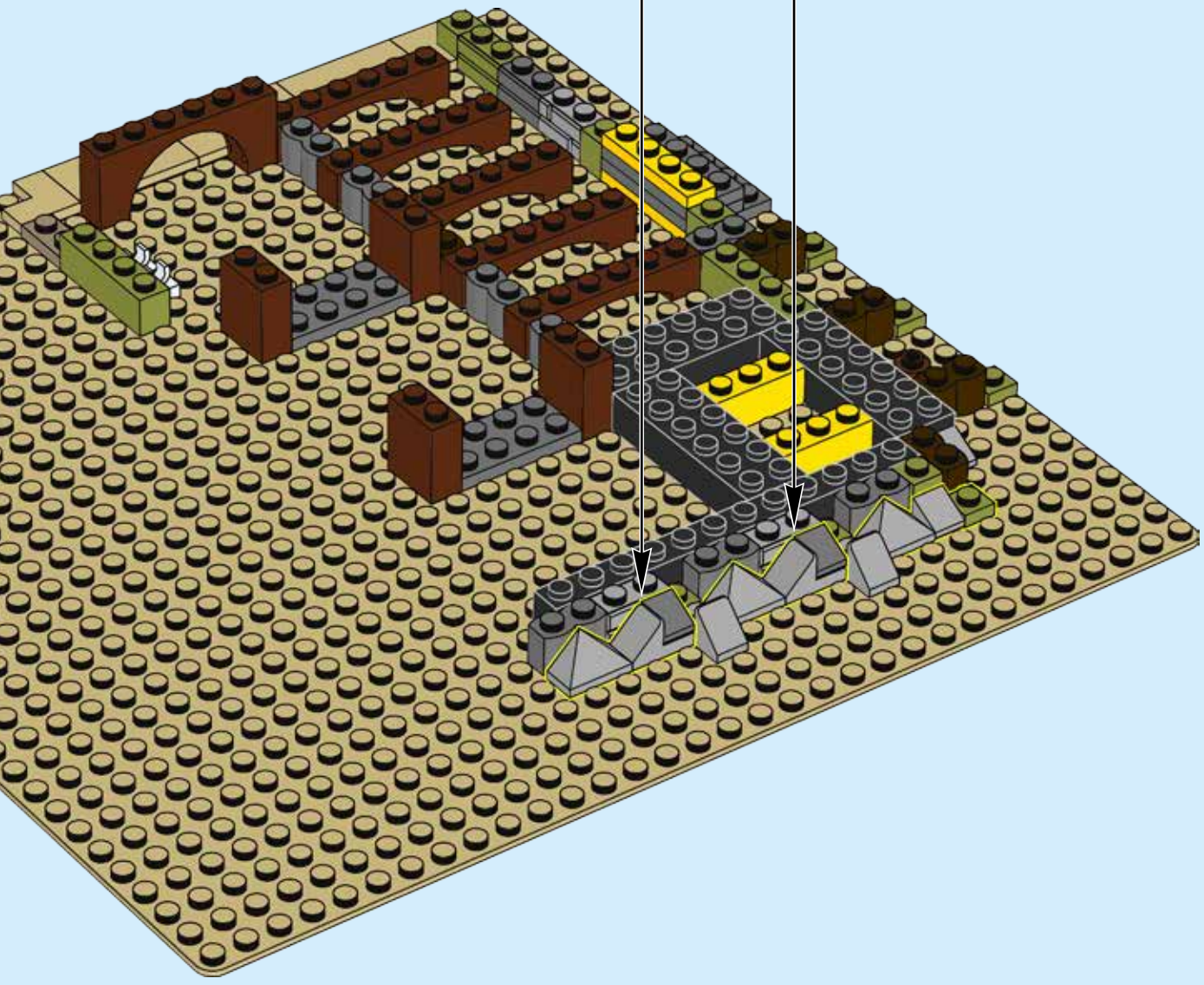

2x 5x

12

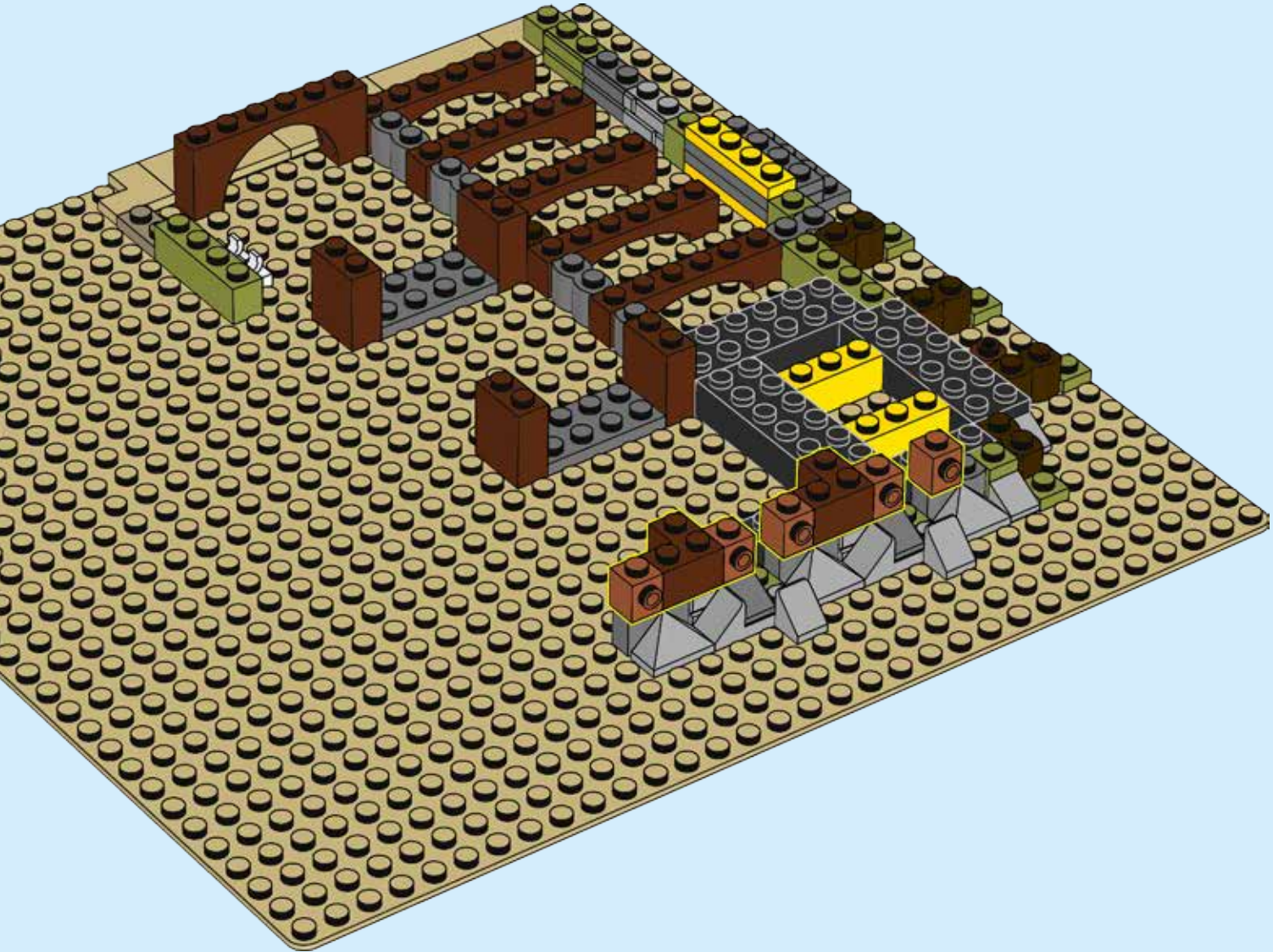

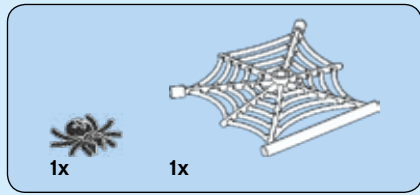

13

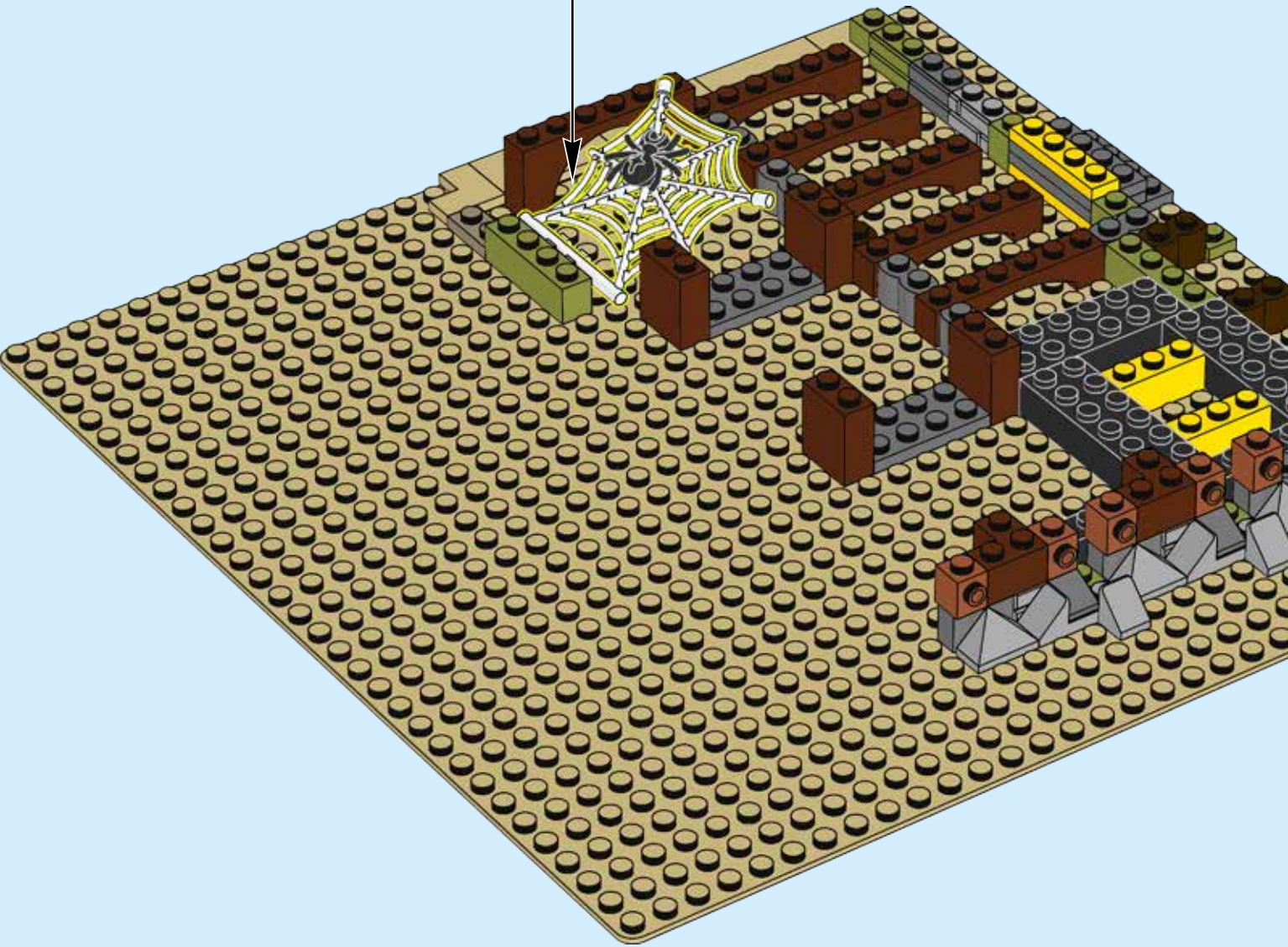
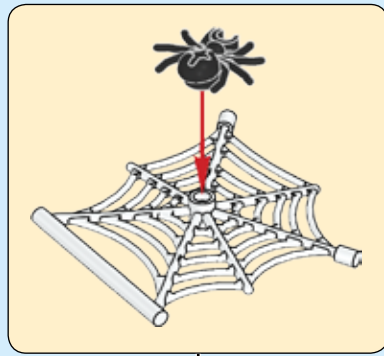

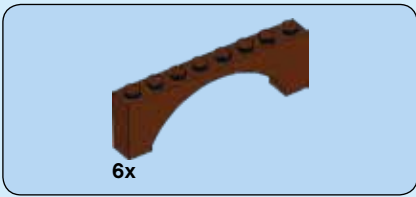

14

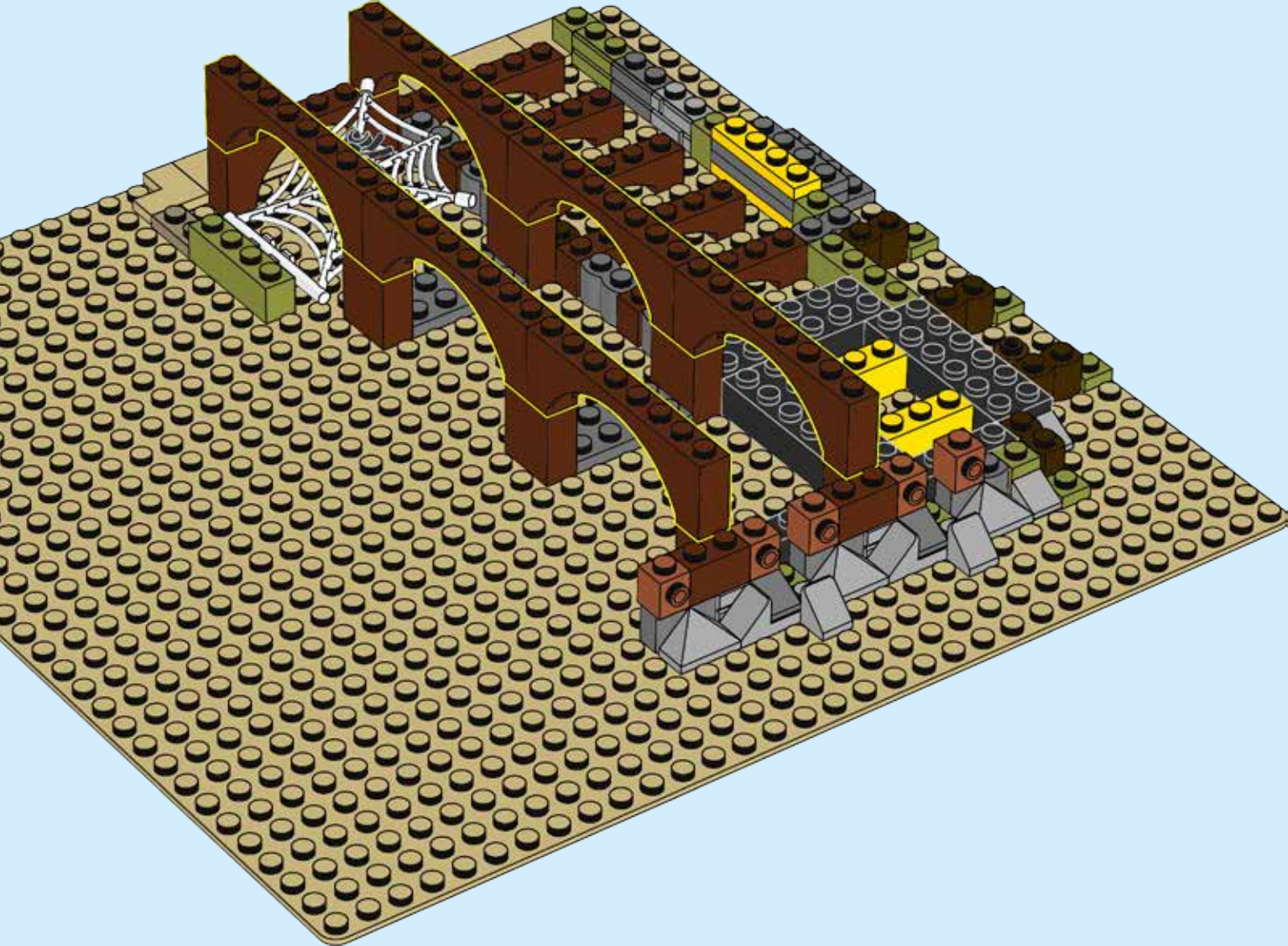

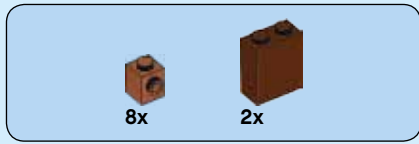

15

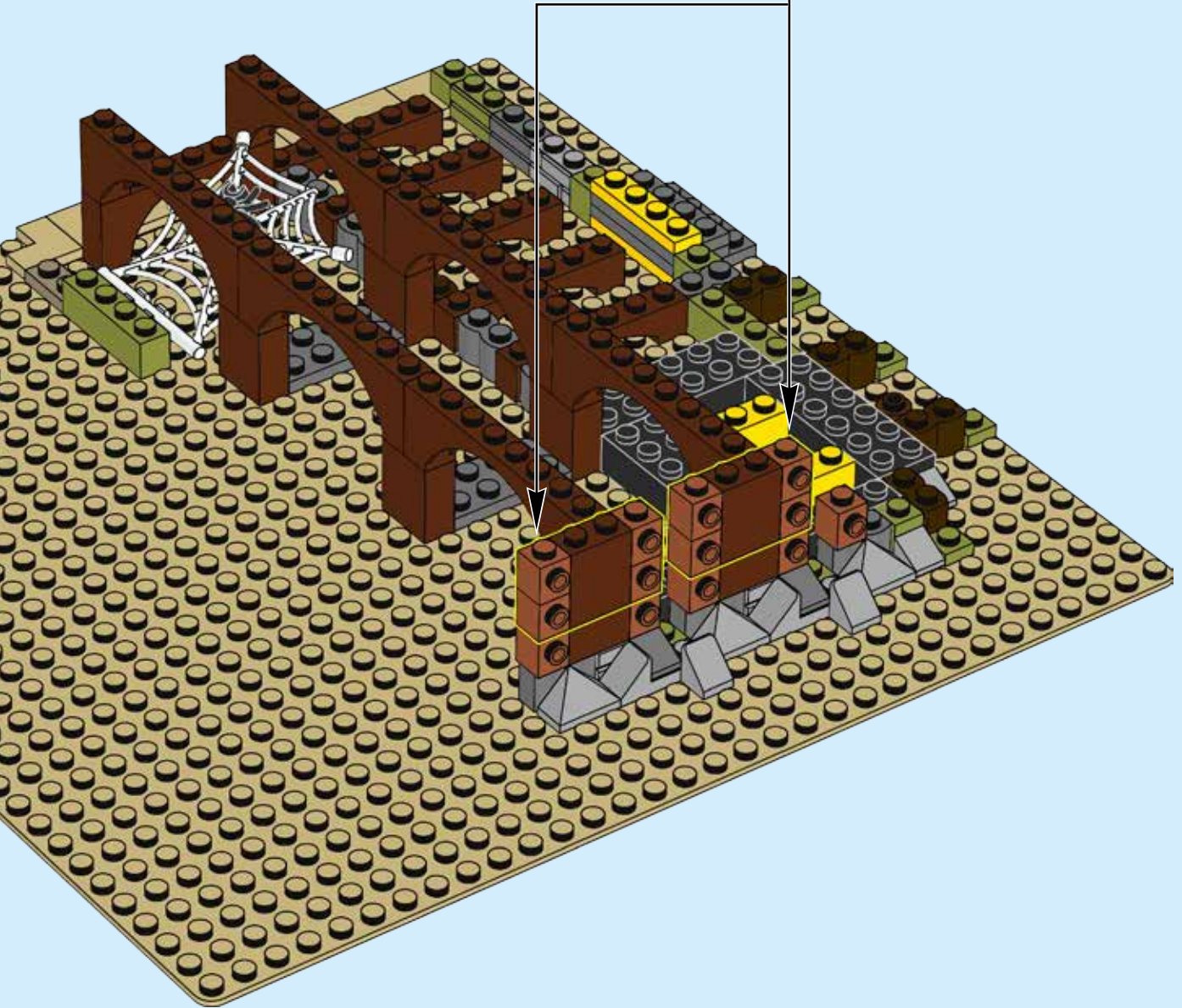
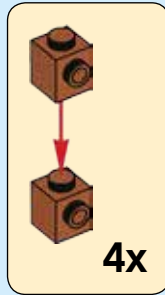

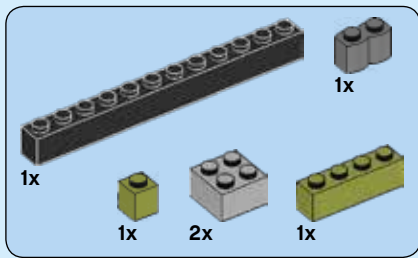

16

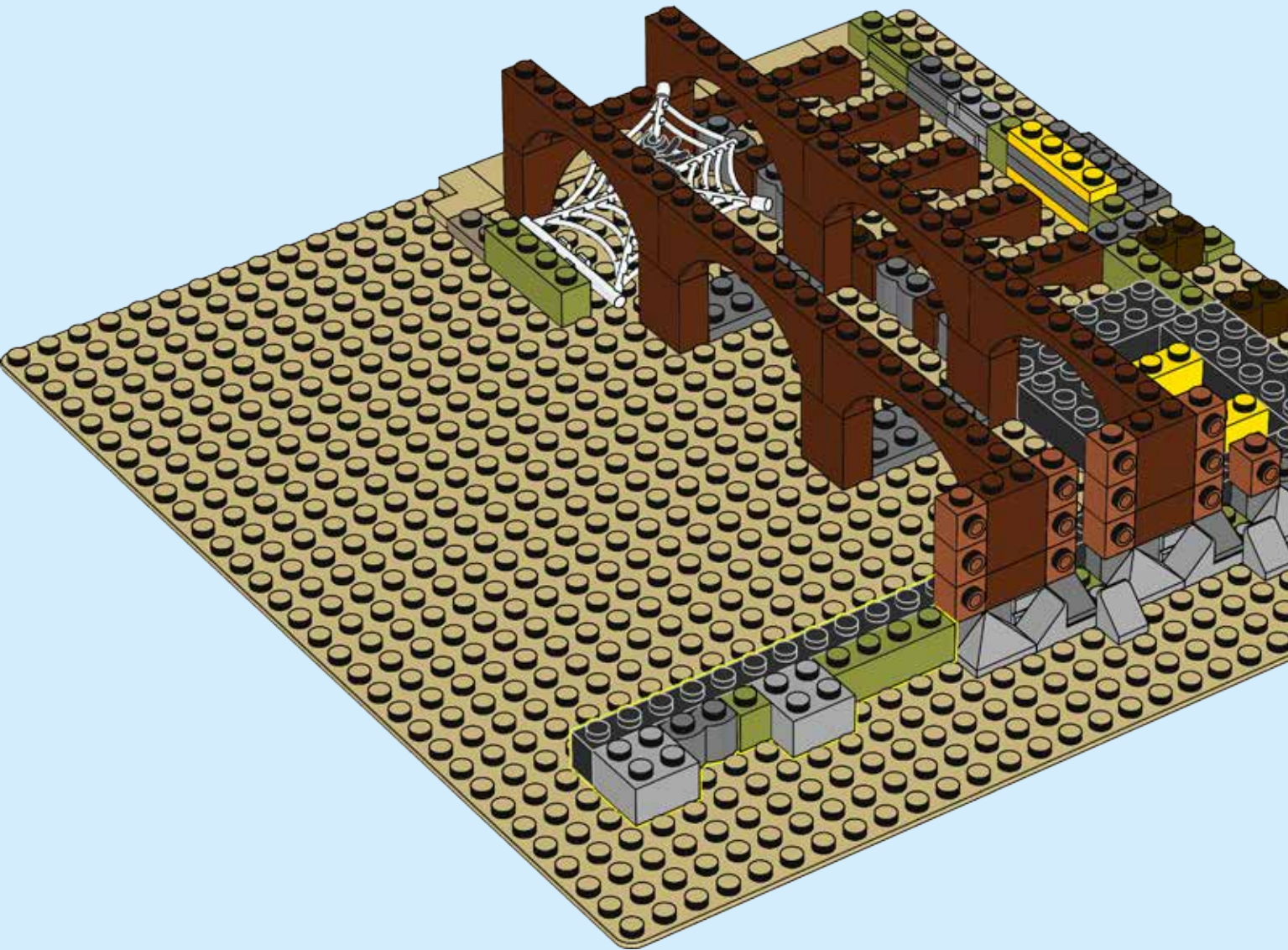

1x 2x 2x

17

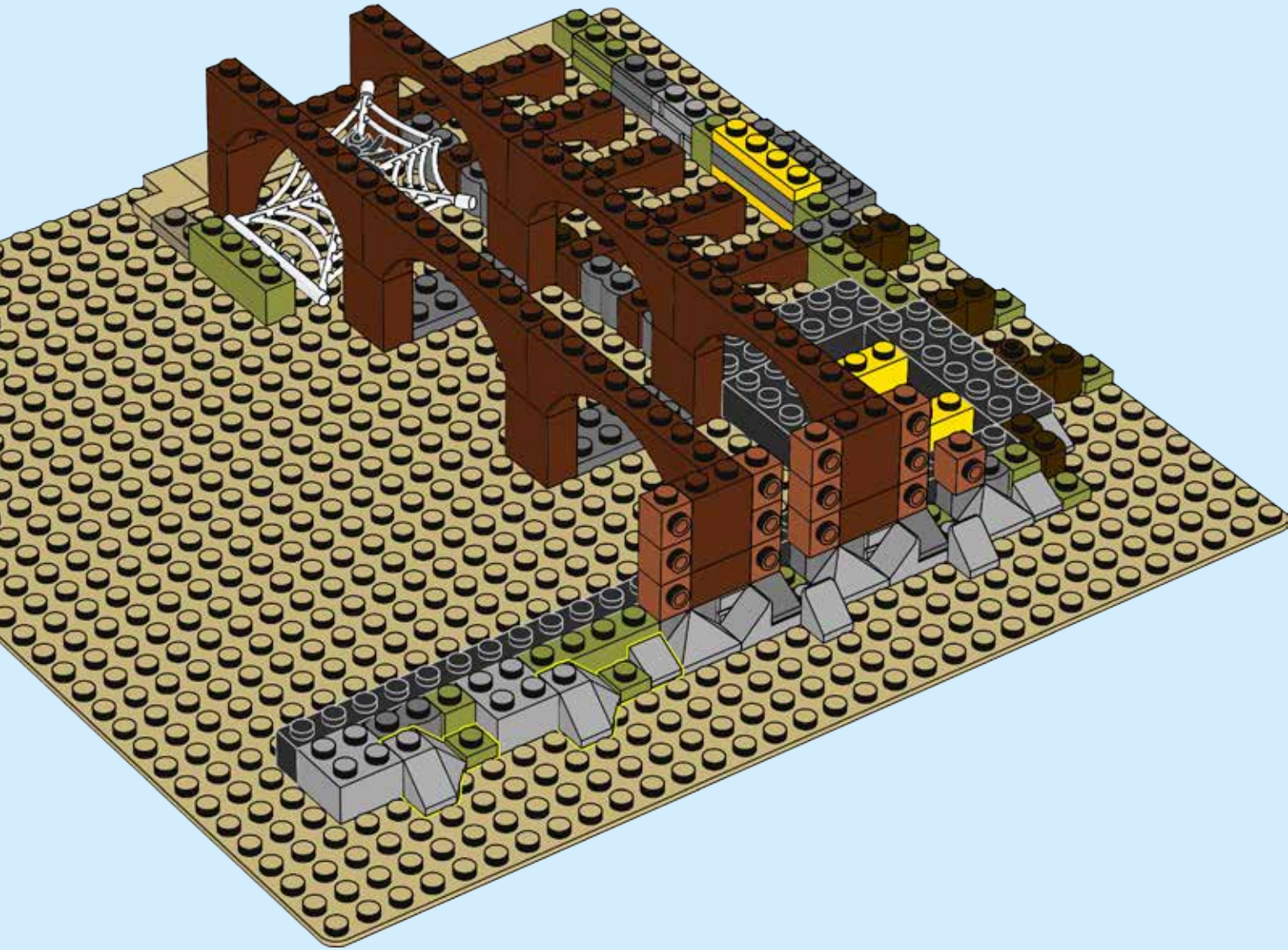

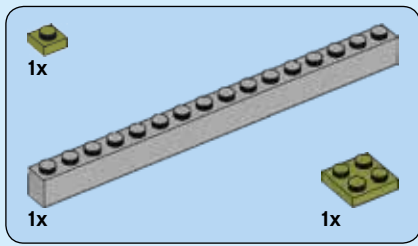

18

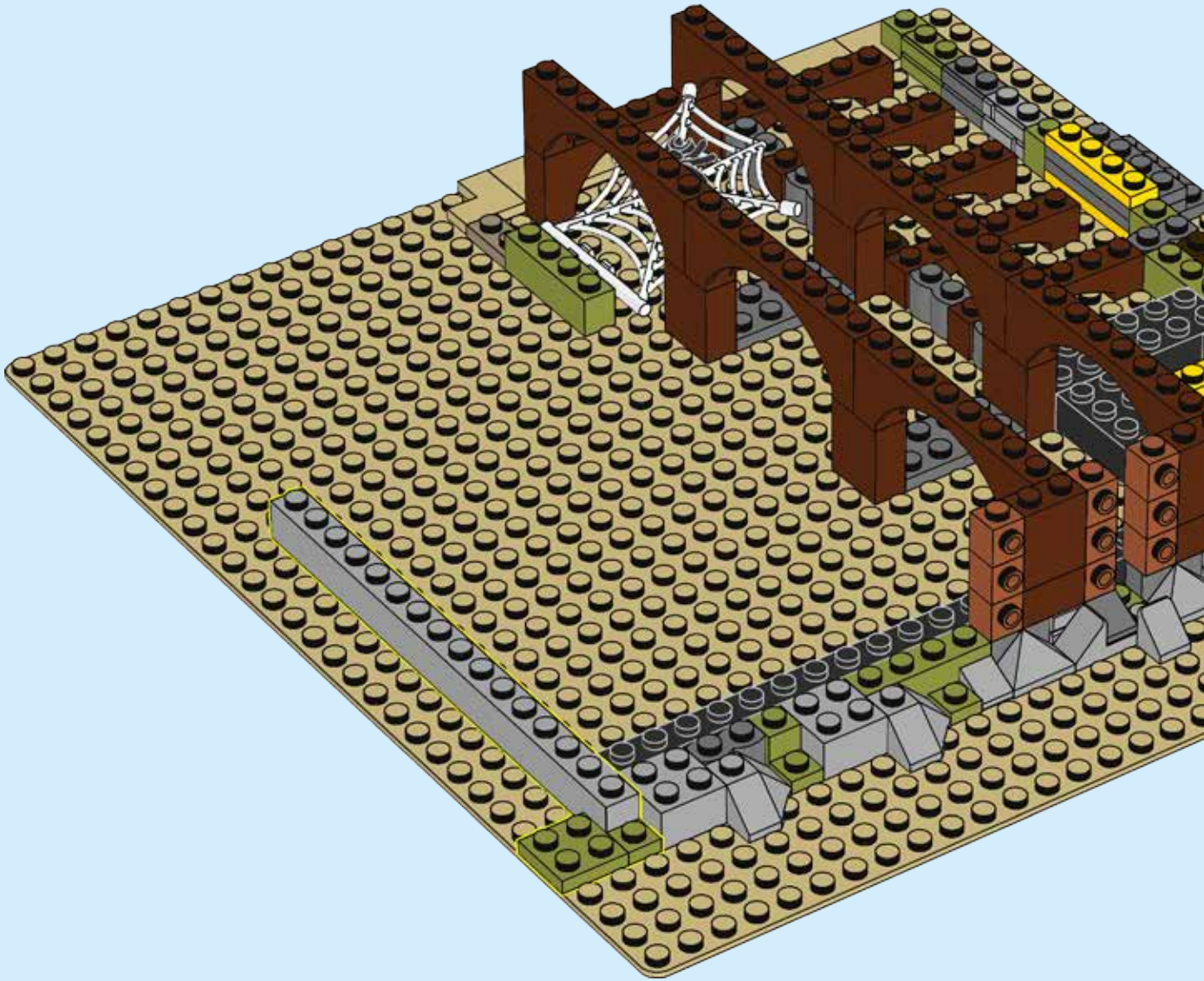

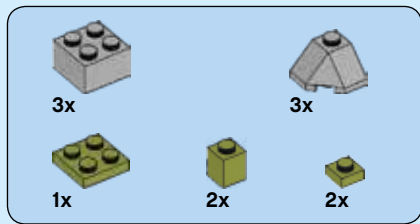

19

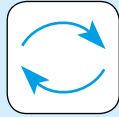



20

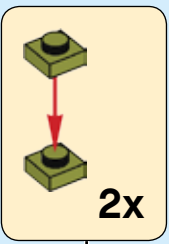

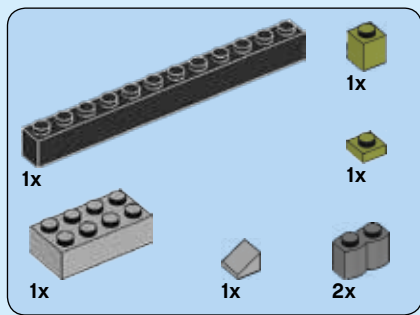

21

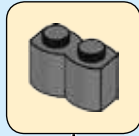

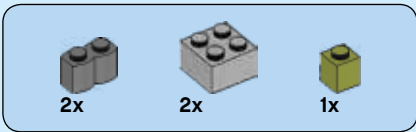

22

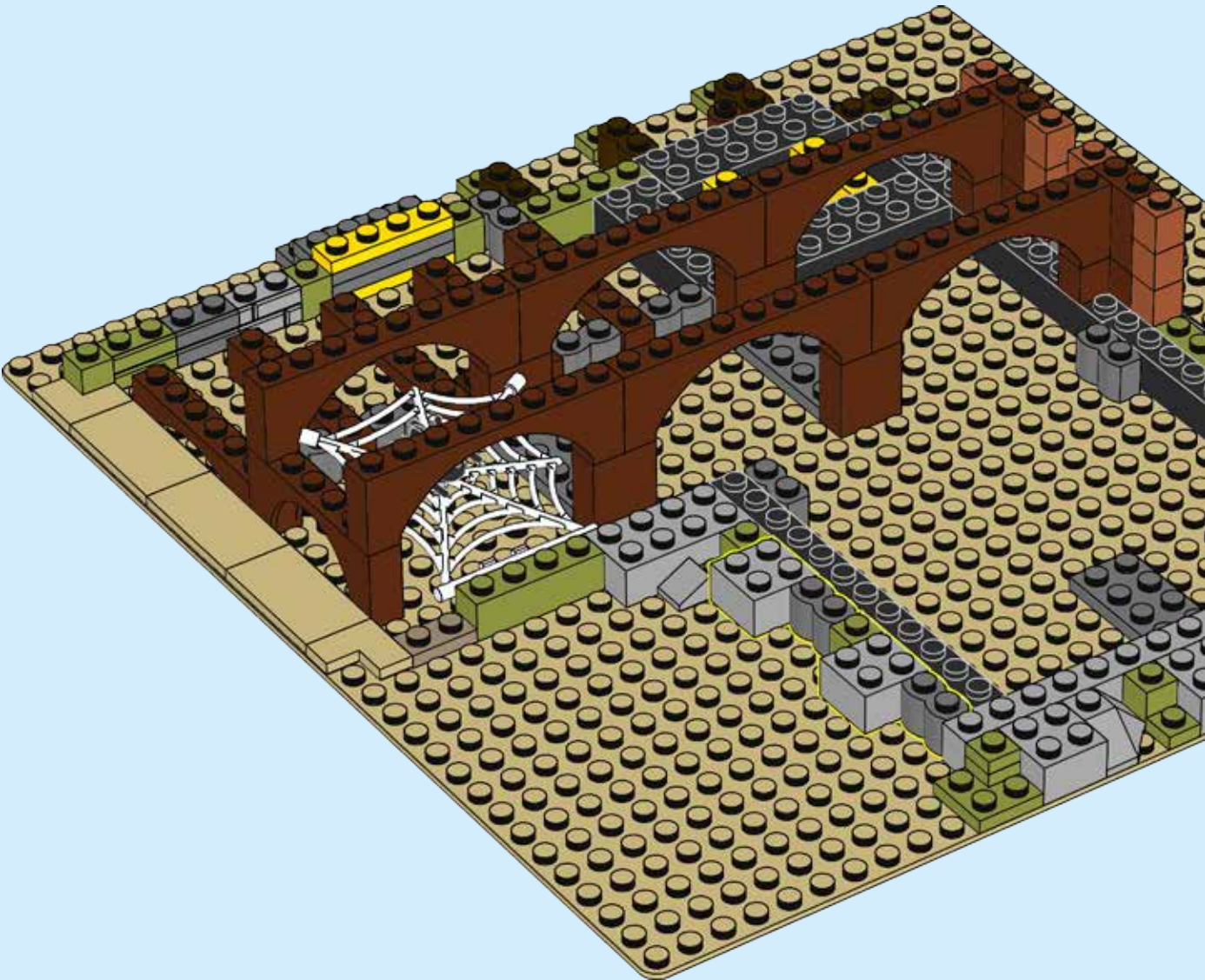

2x  2x 

23

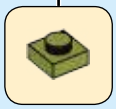

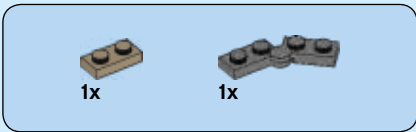

24

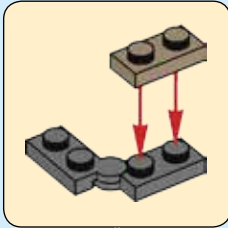

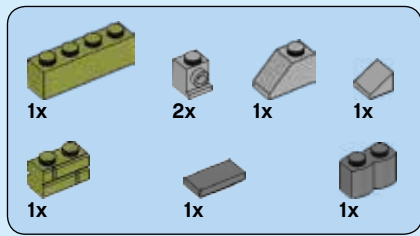

25

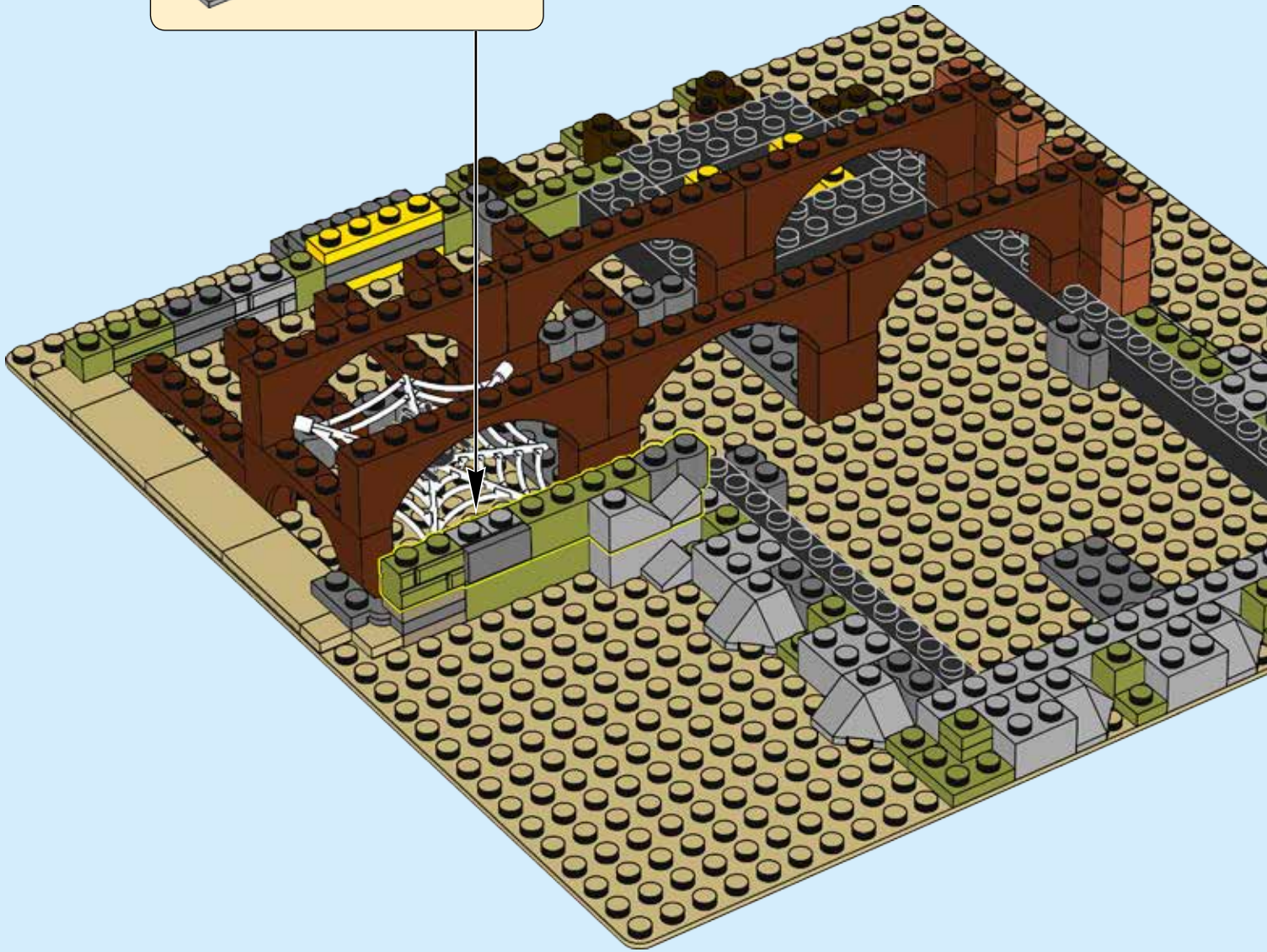
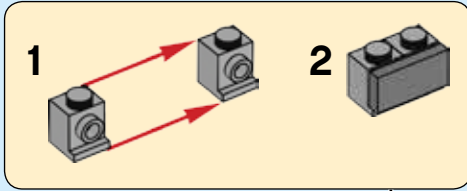

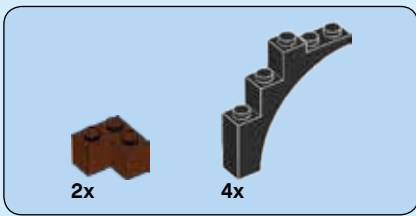

26



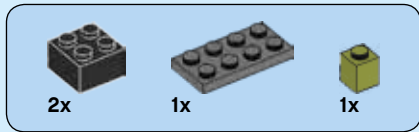

27



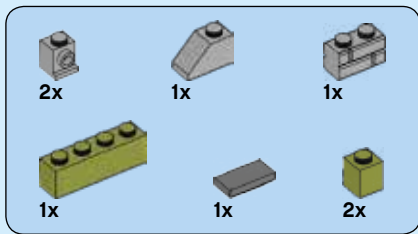

28

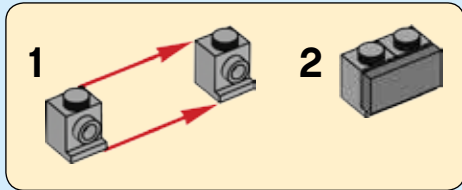

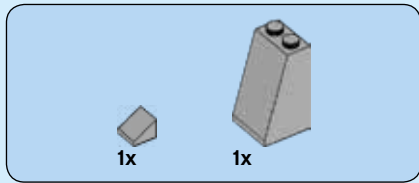

29



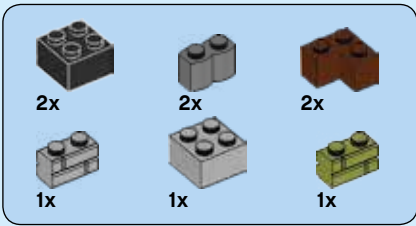

30



2x 1x

31

2x

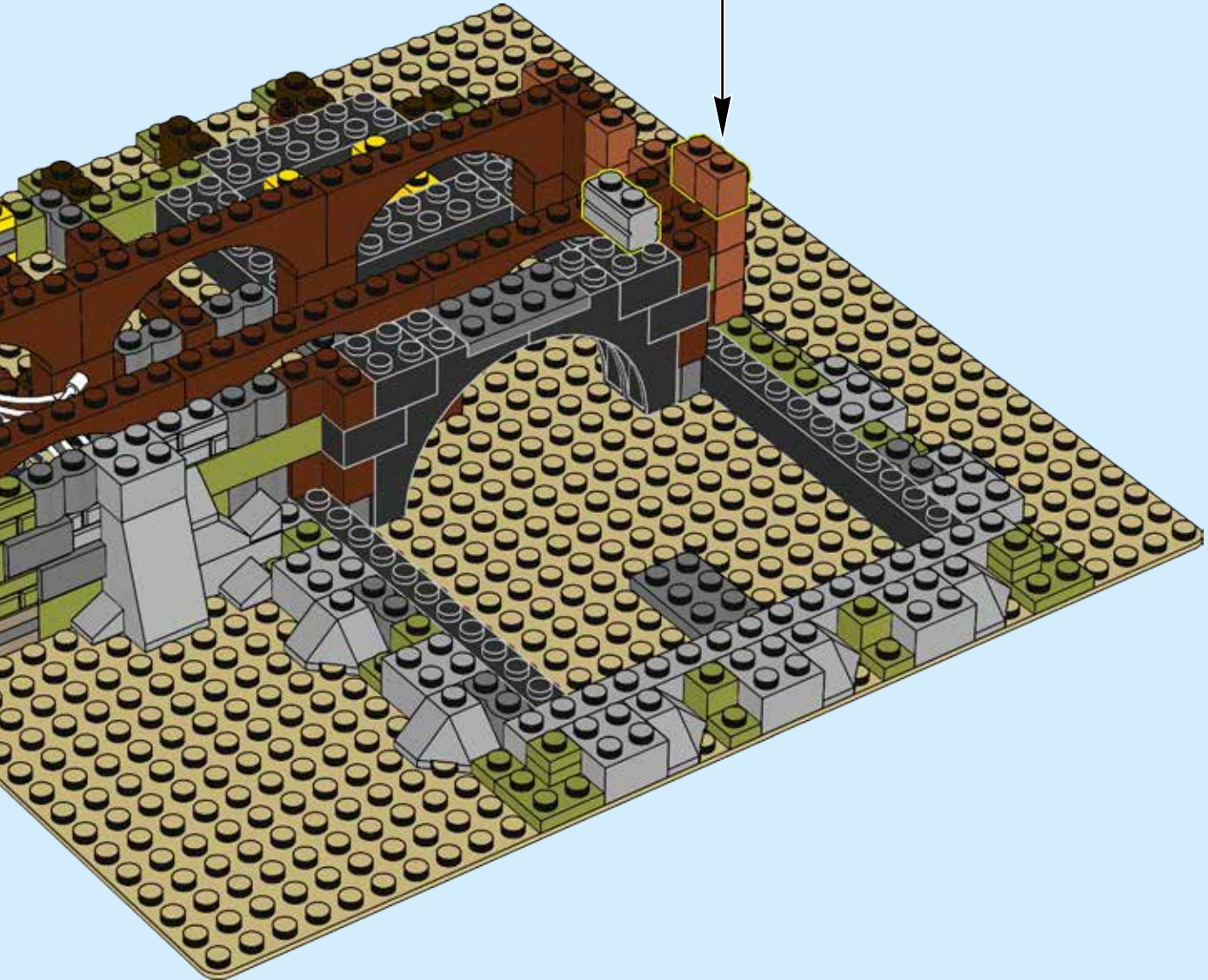

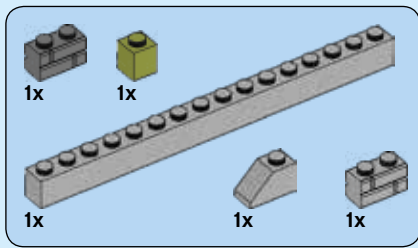

32

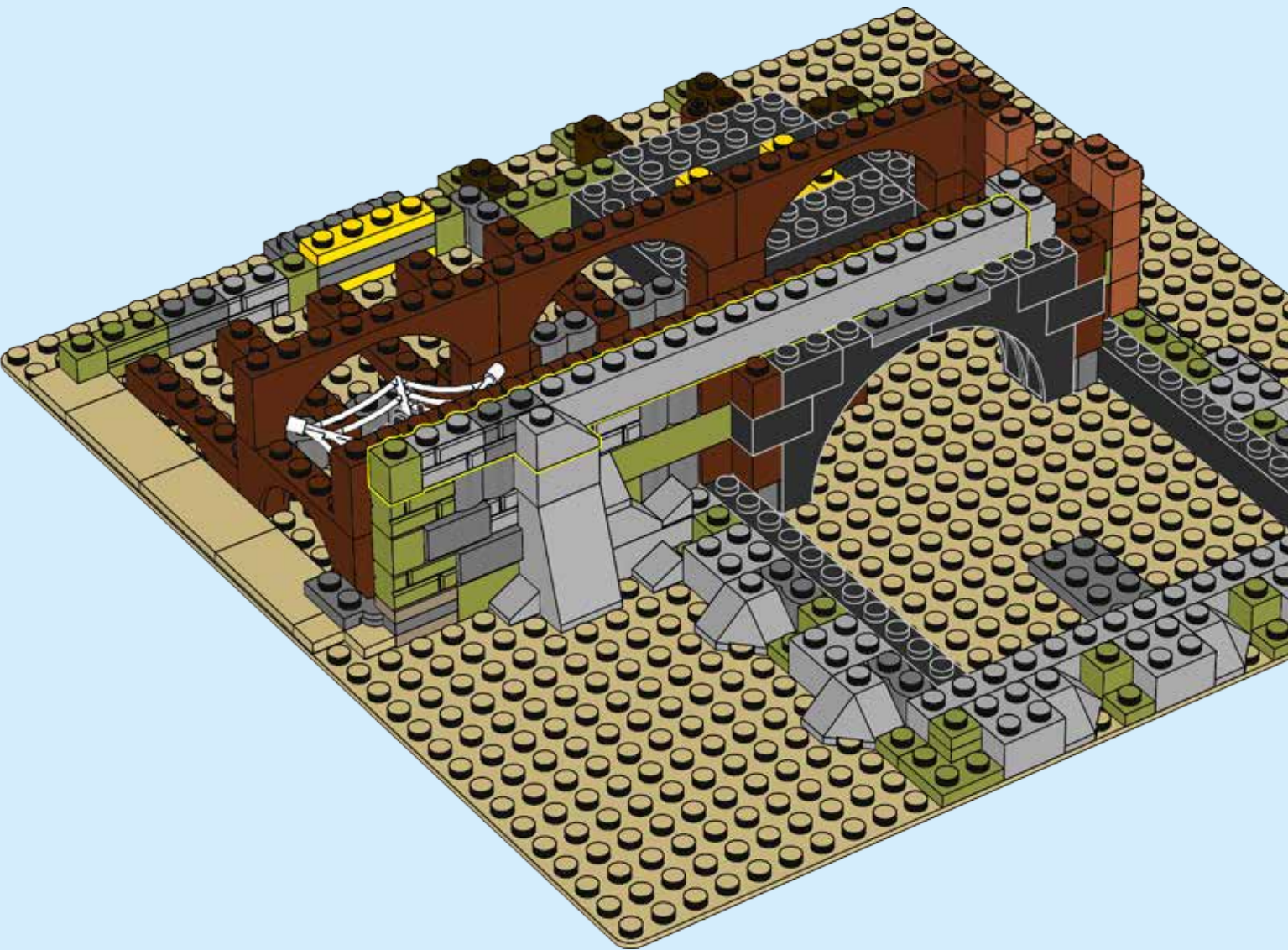

6x 2x

33



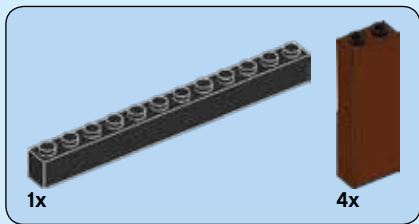

34



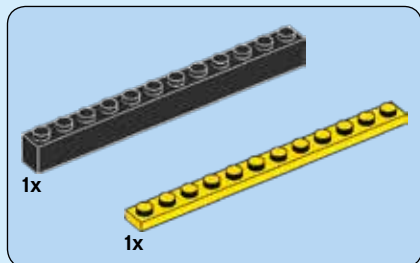

35



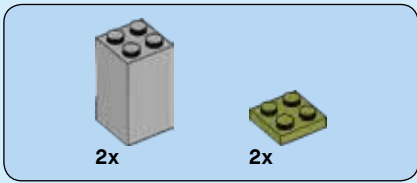

36

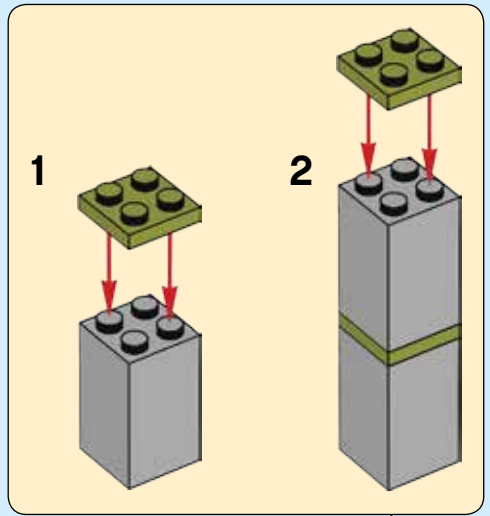

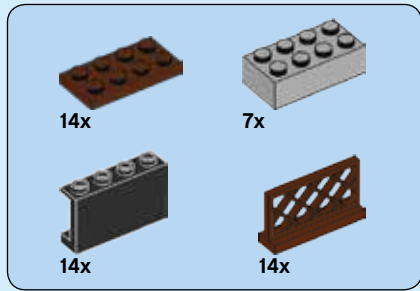

37

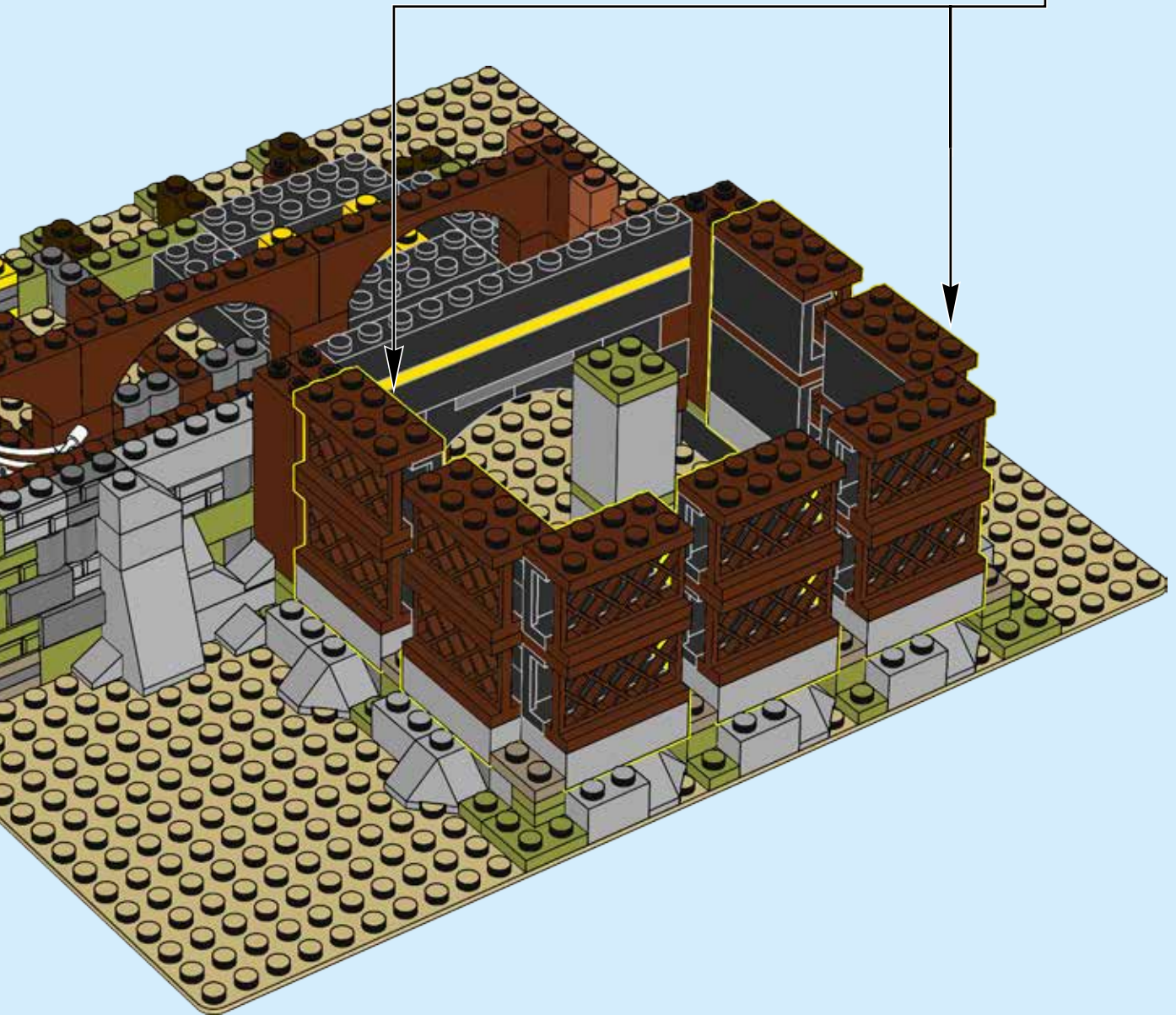
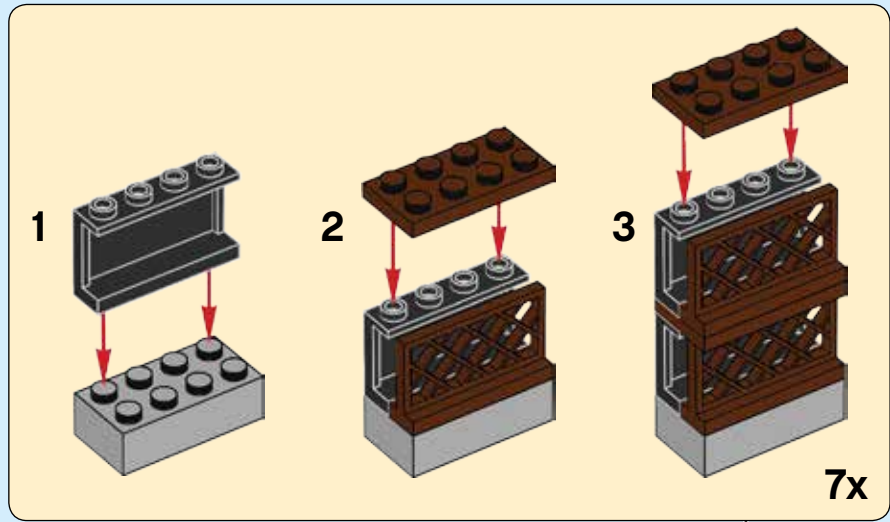

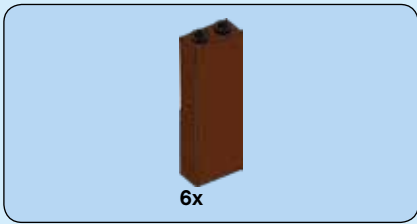

38

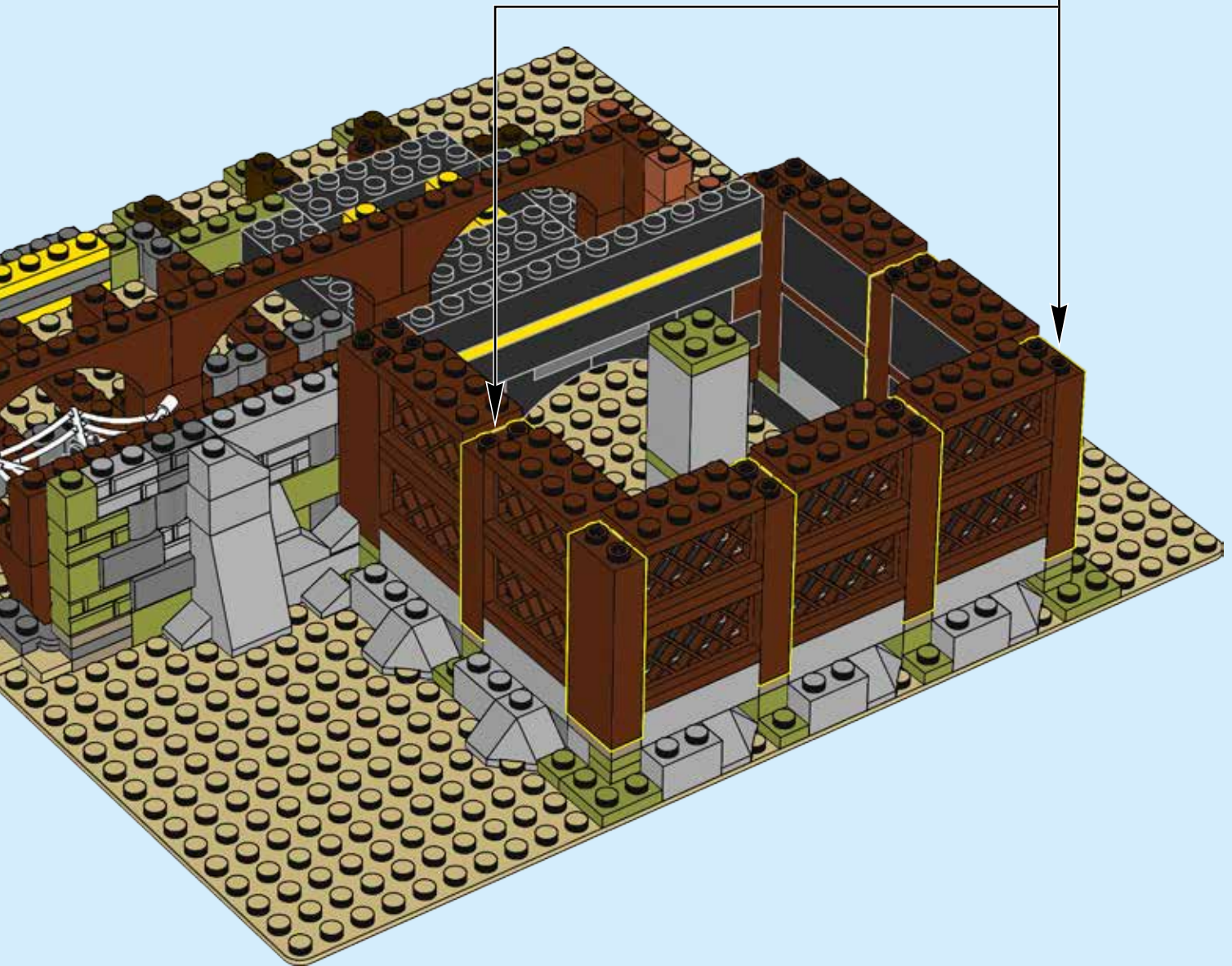
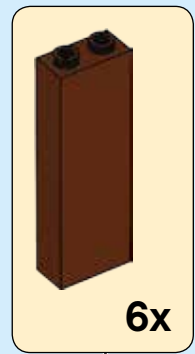

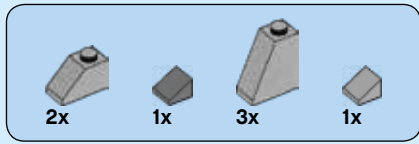

39





3x



2x

40

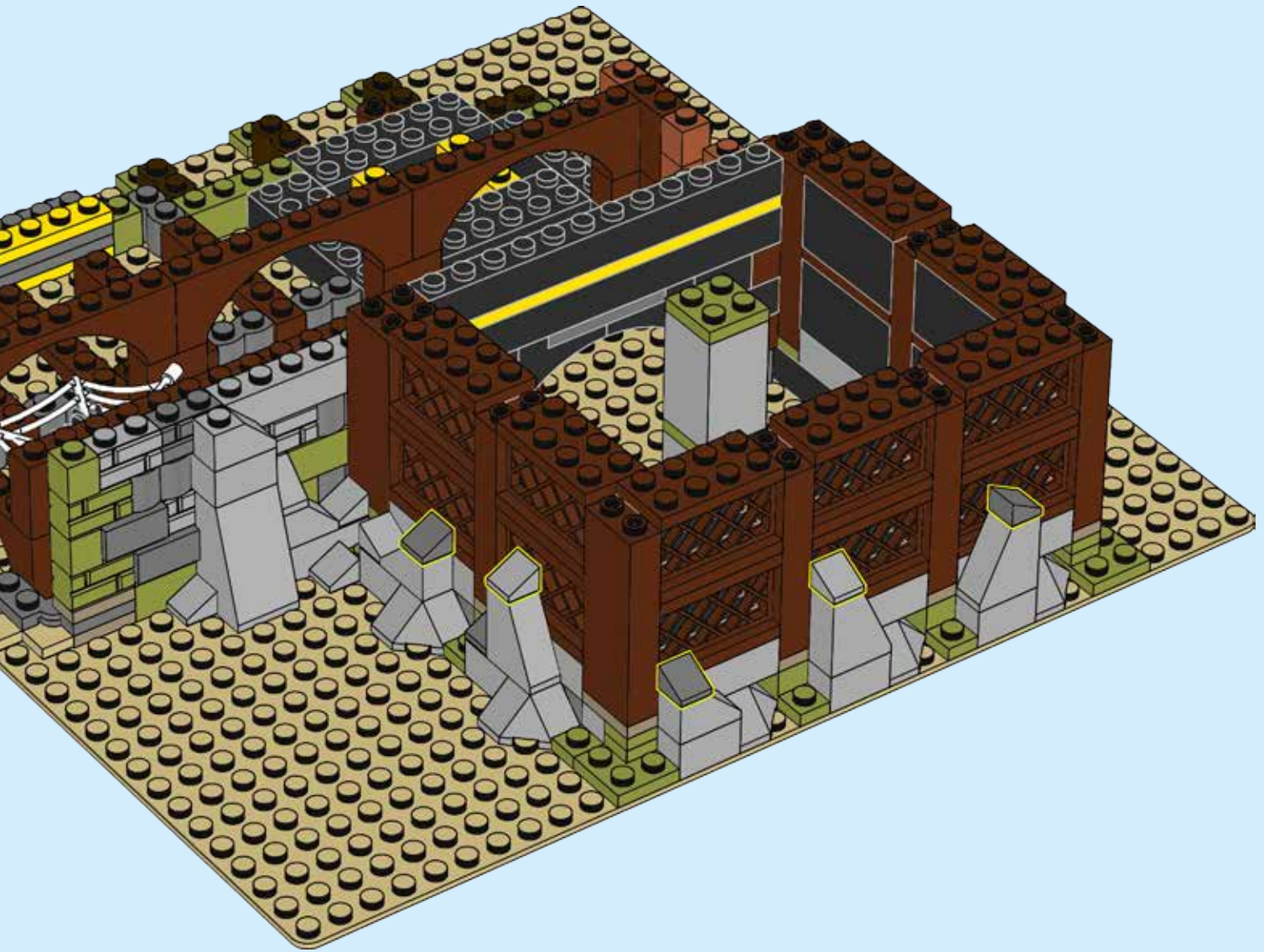

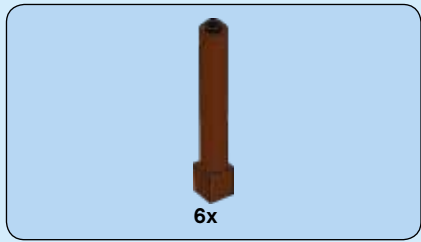

41

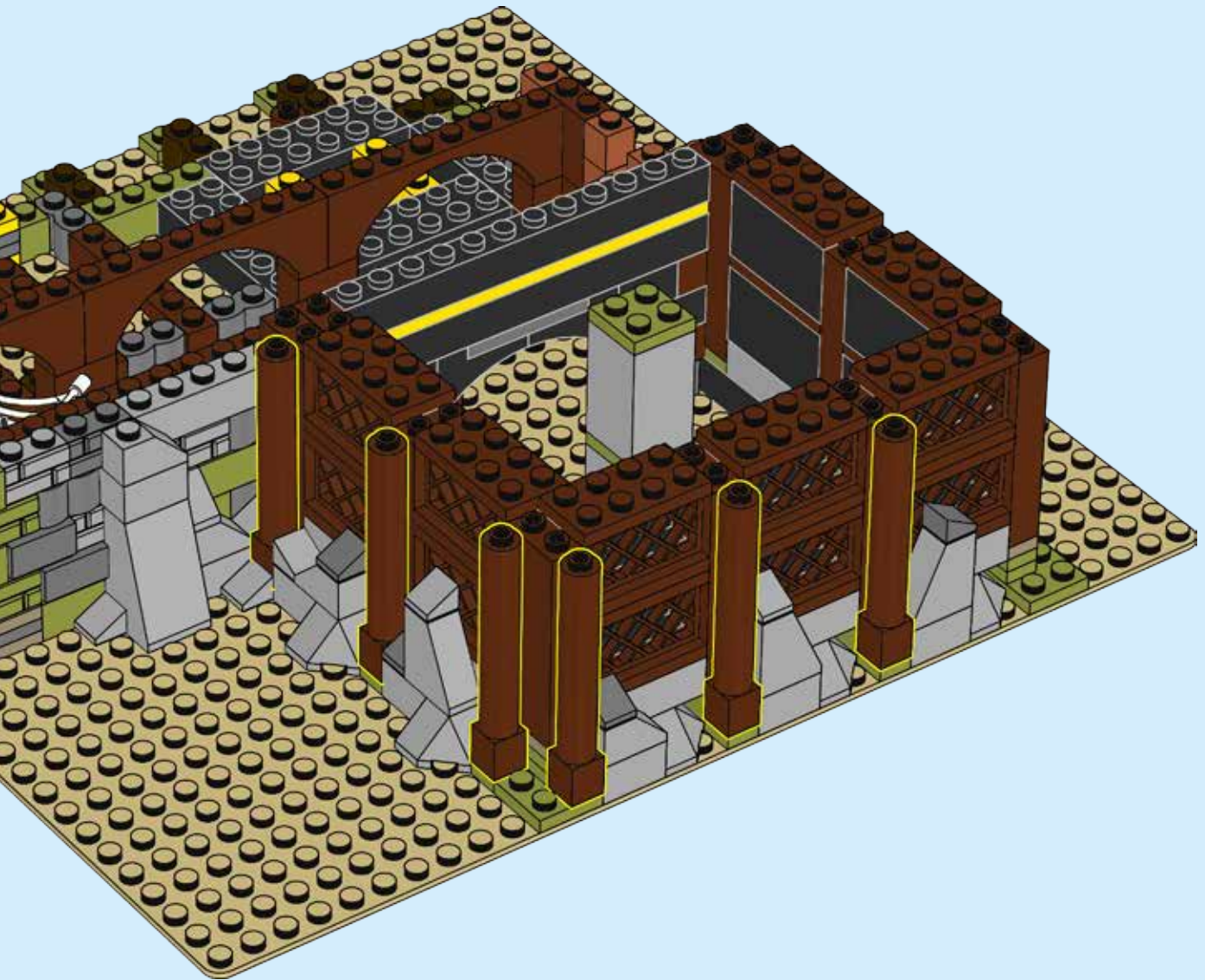

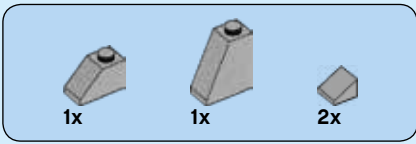

42

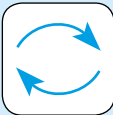

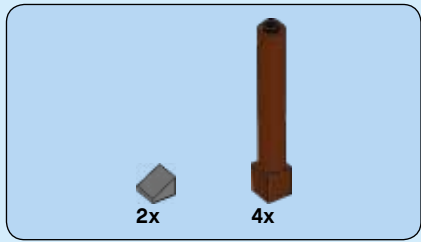

43



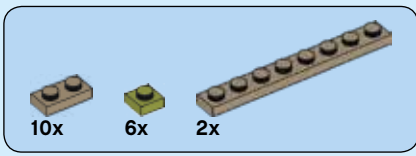

44

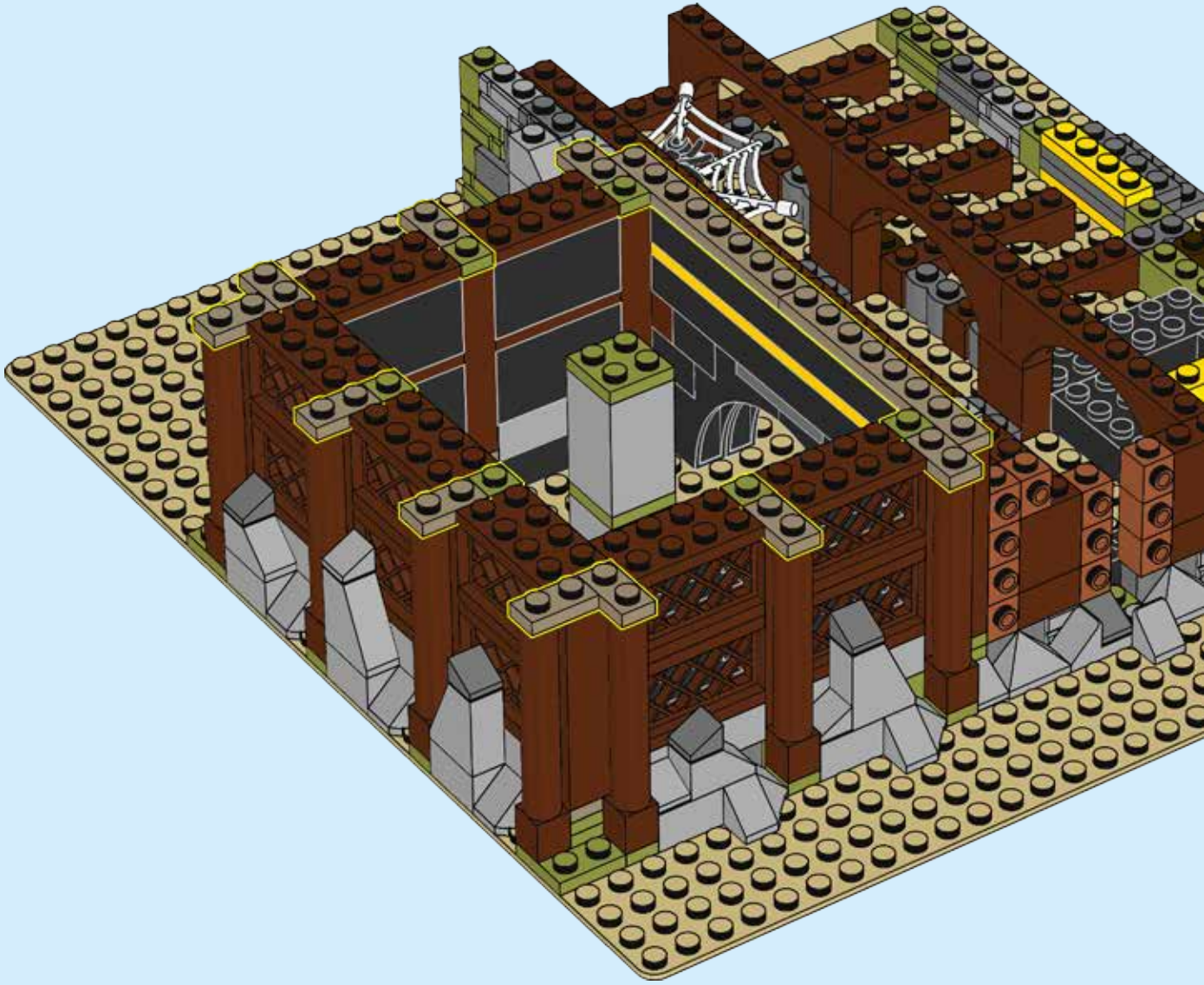



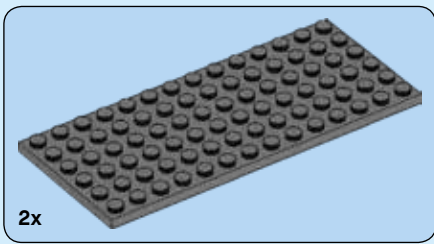

45

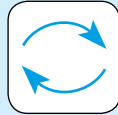

7x 2x

46

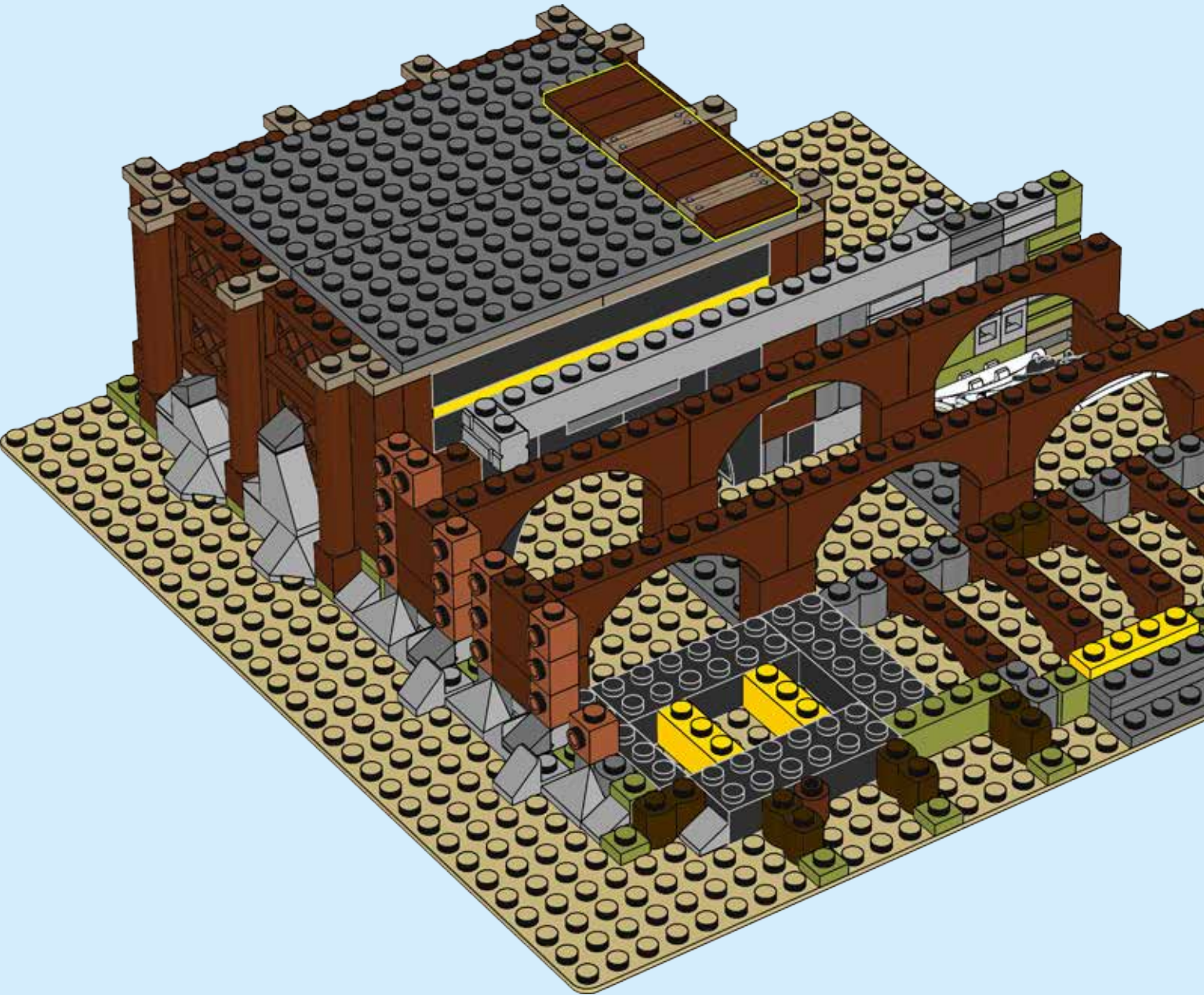

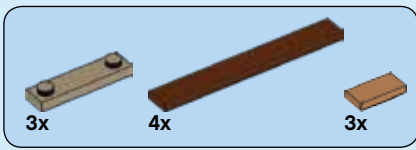

47





48

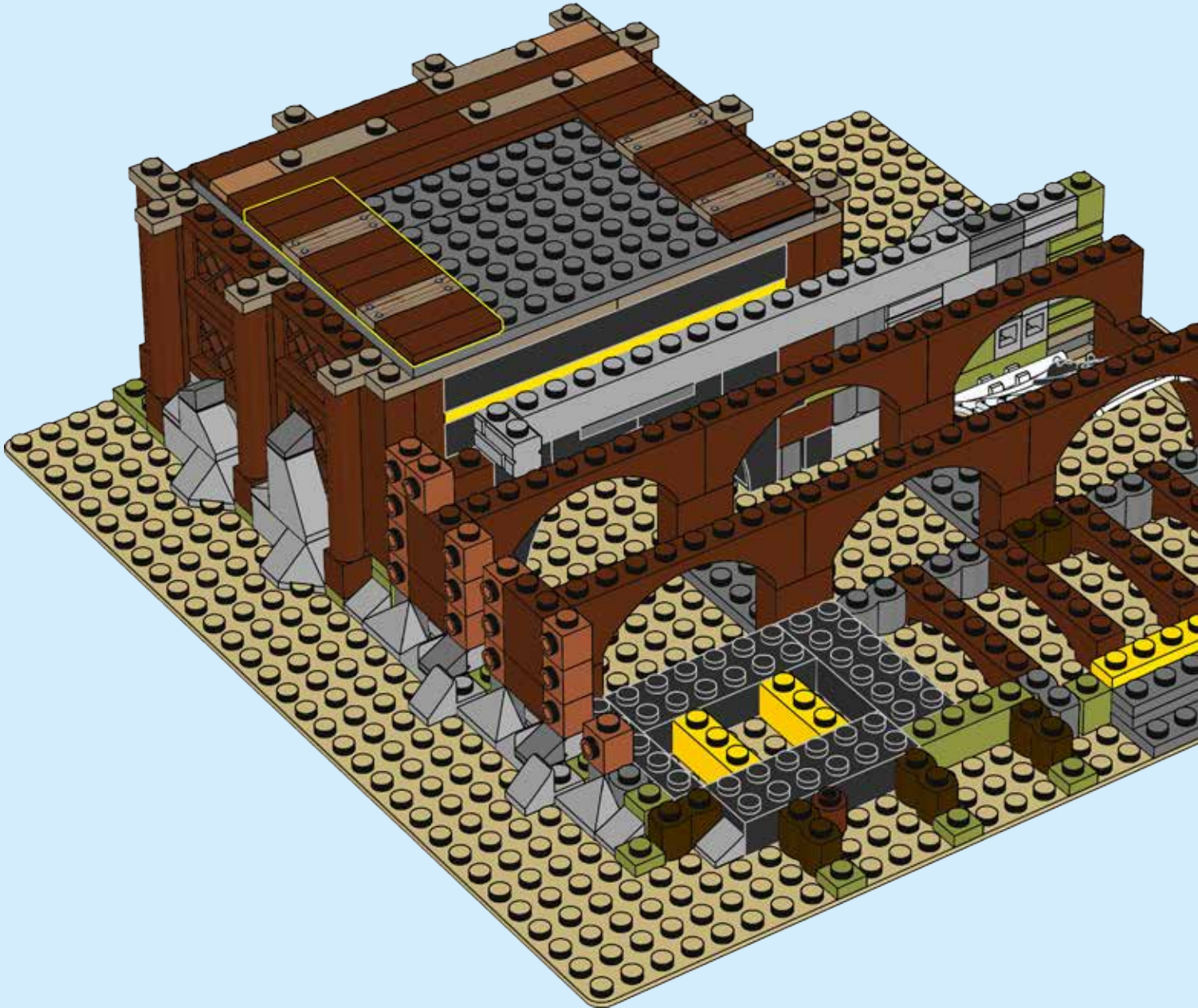



49



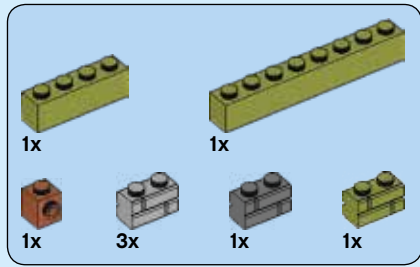

50



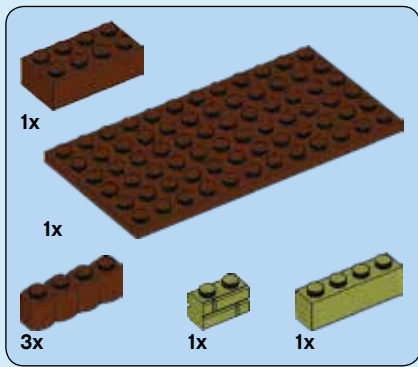

51



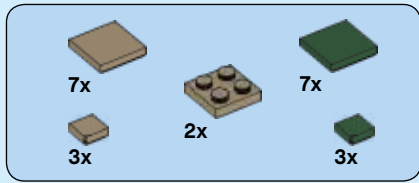

52



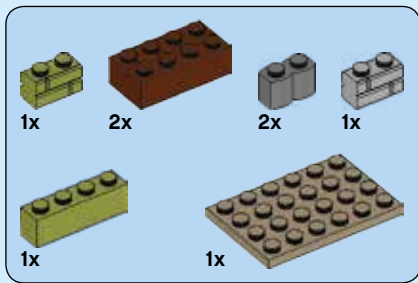

53



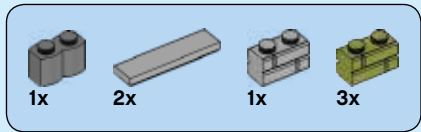

54



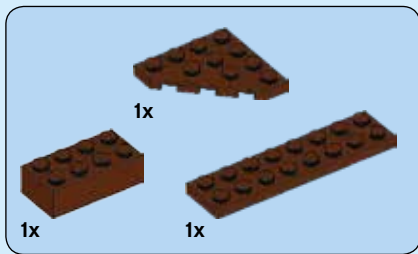

55



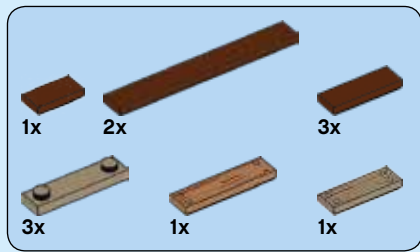

56

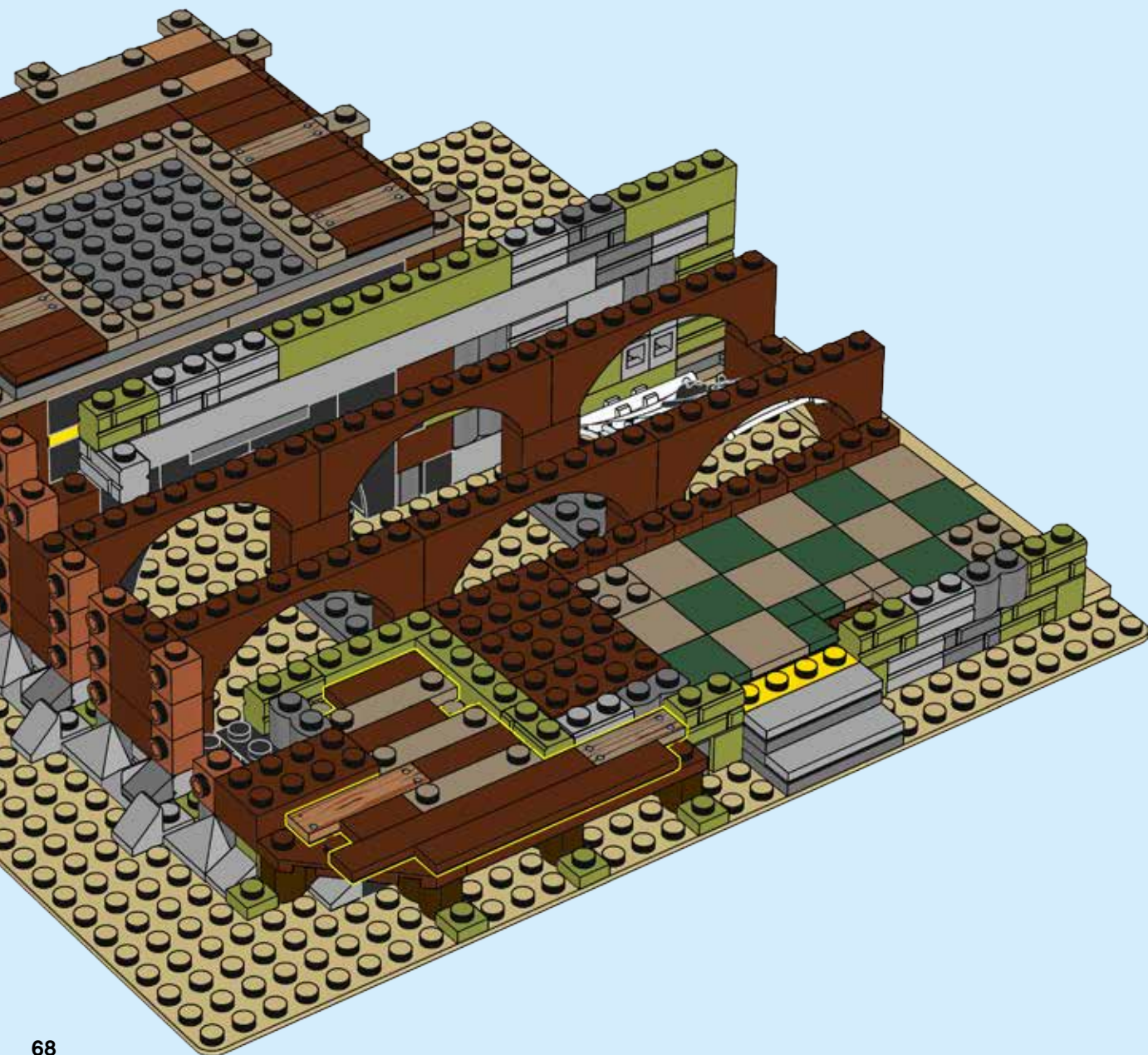

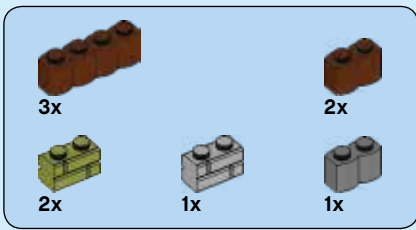

57

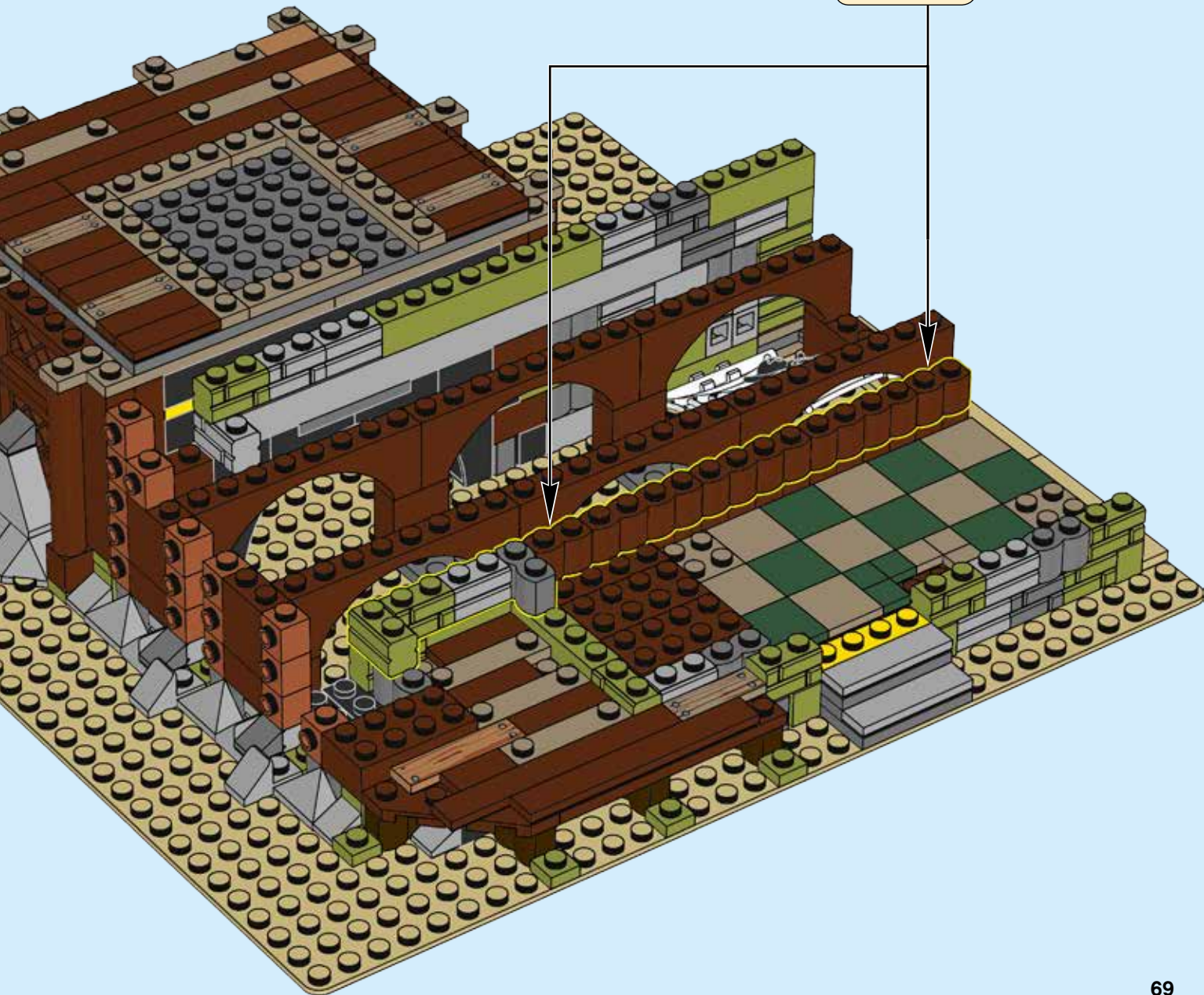
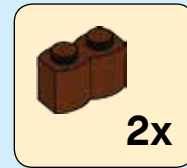

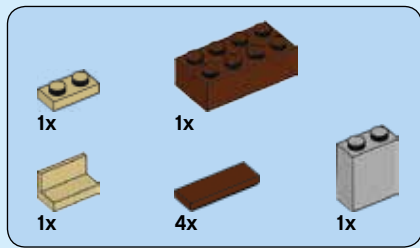

58



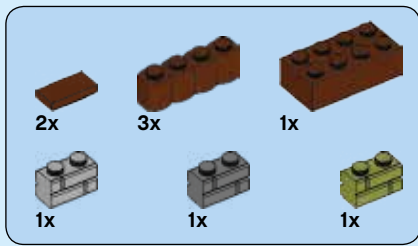

59

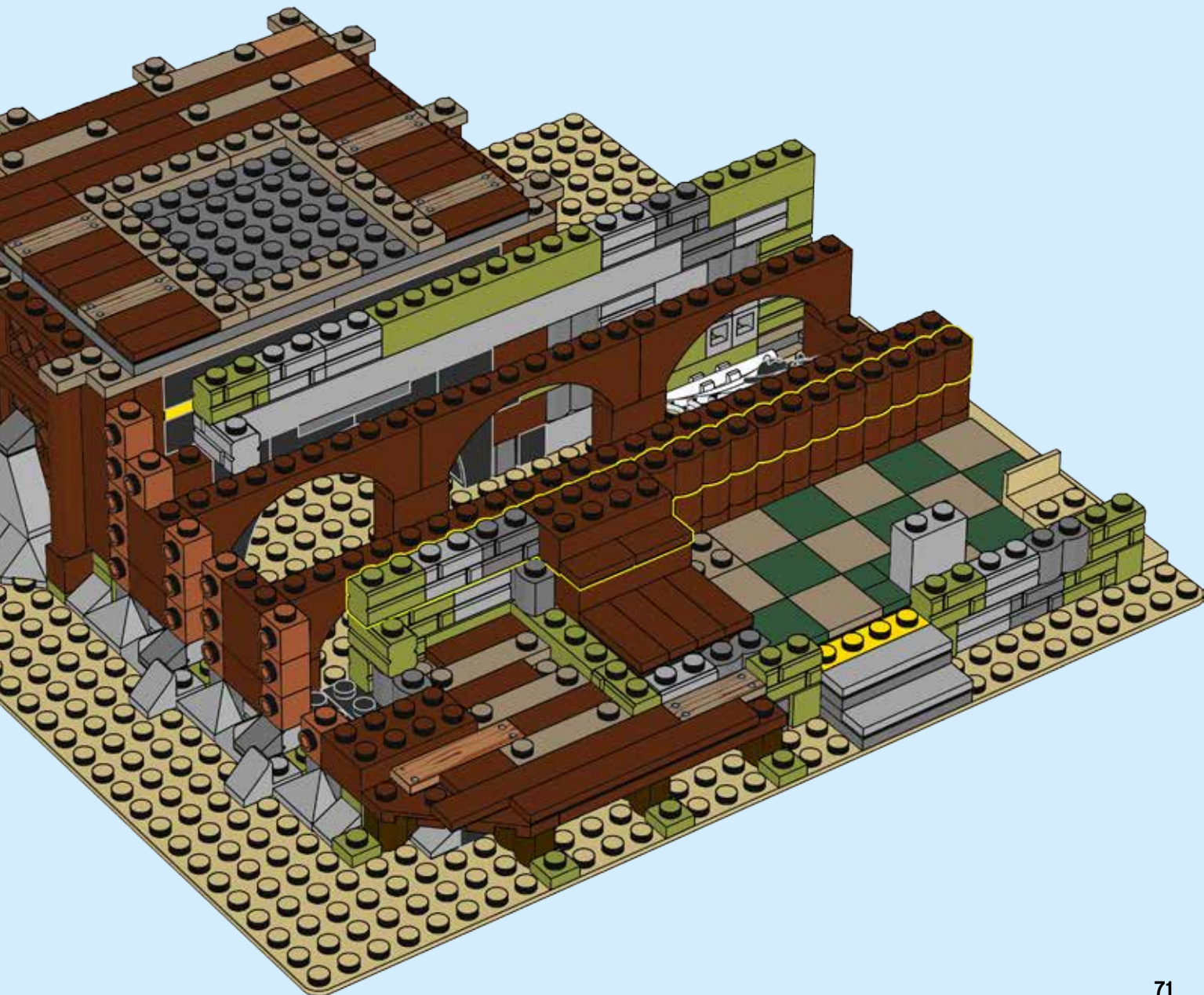

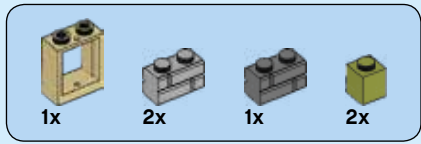

60



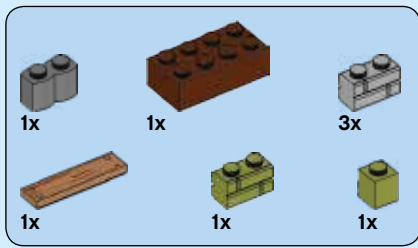

61

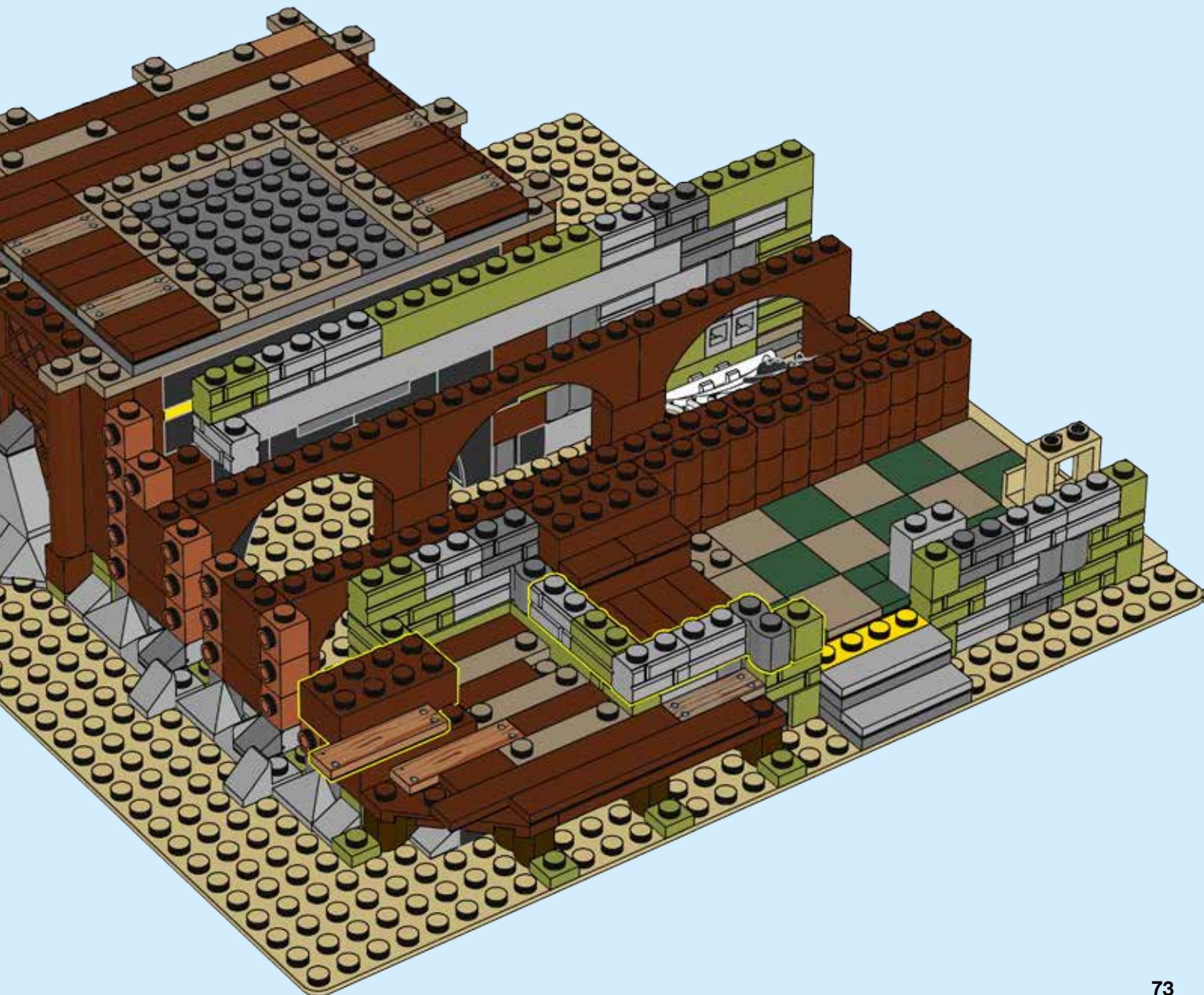

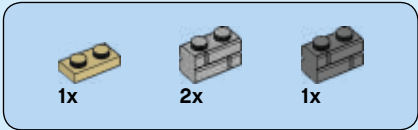

62

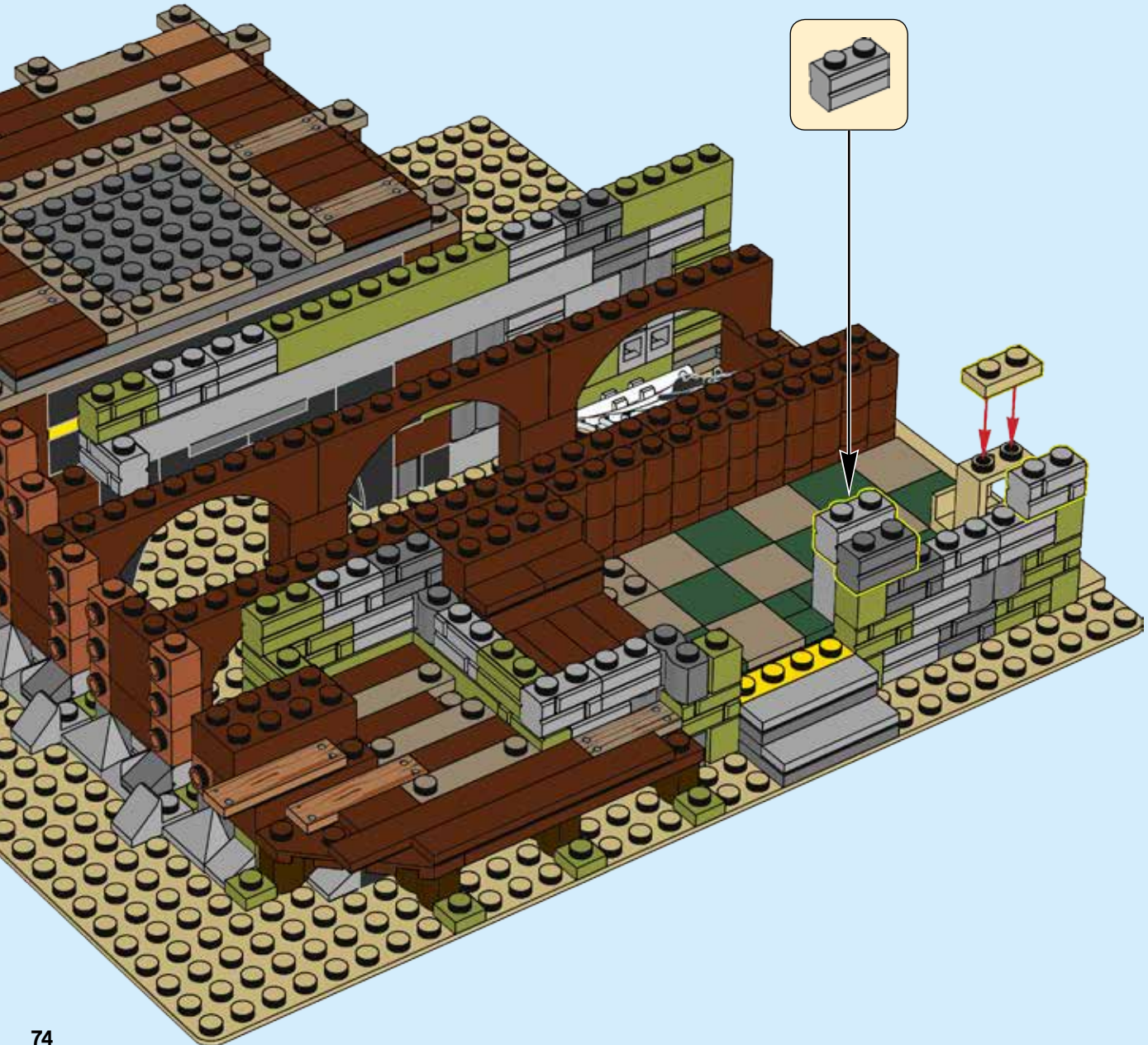

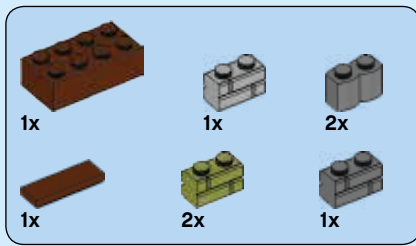



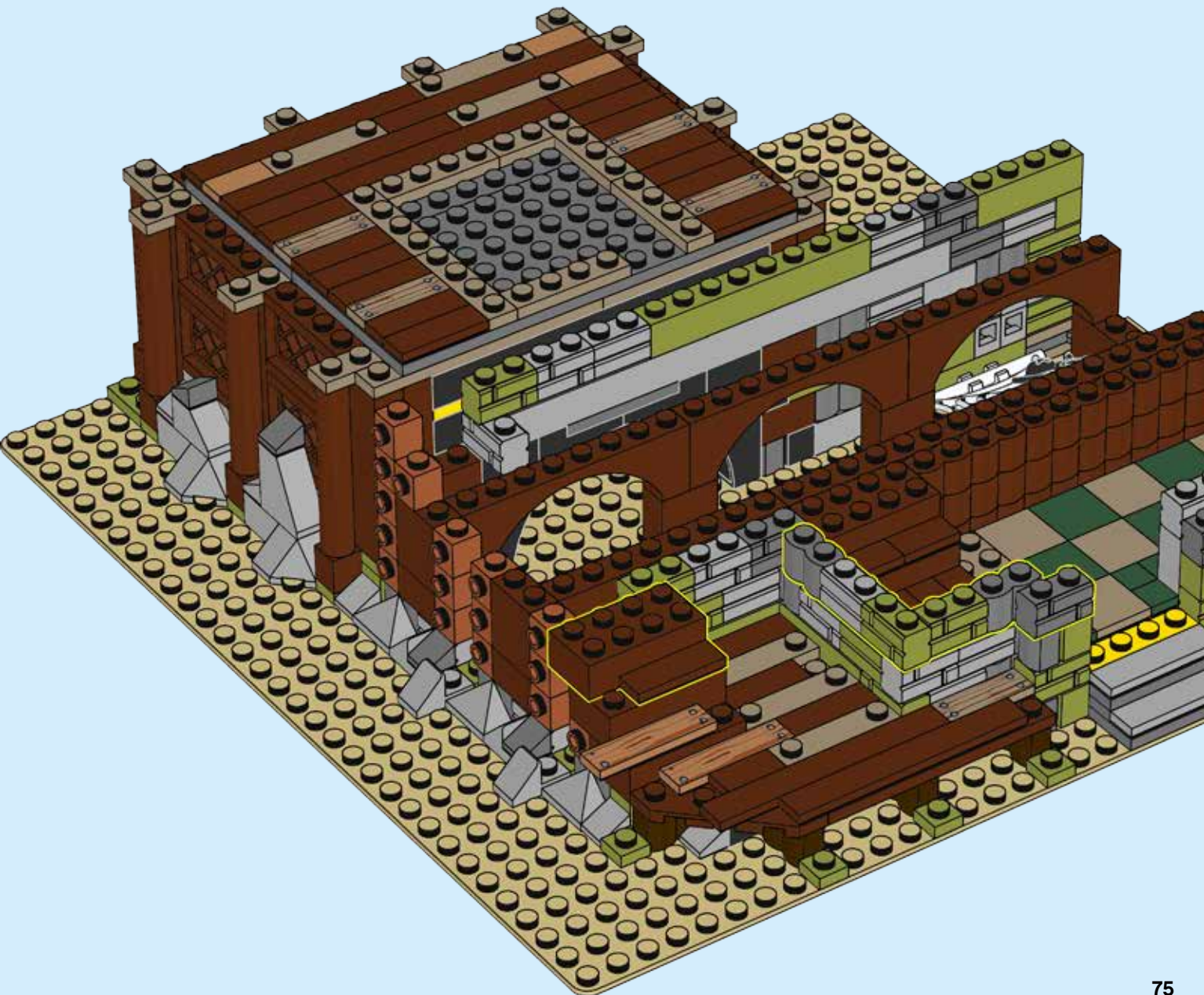

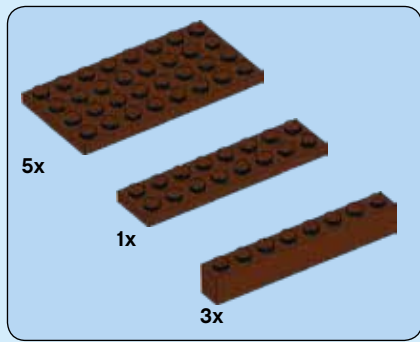

63





64



 2x	 5x	 1x
 2x	 1x	 2x

65

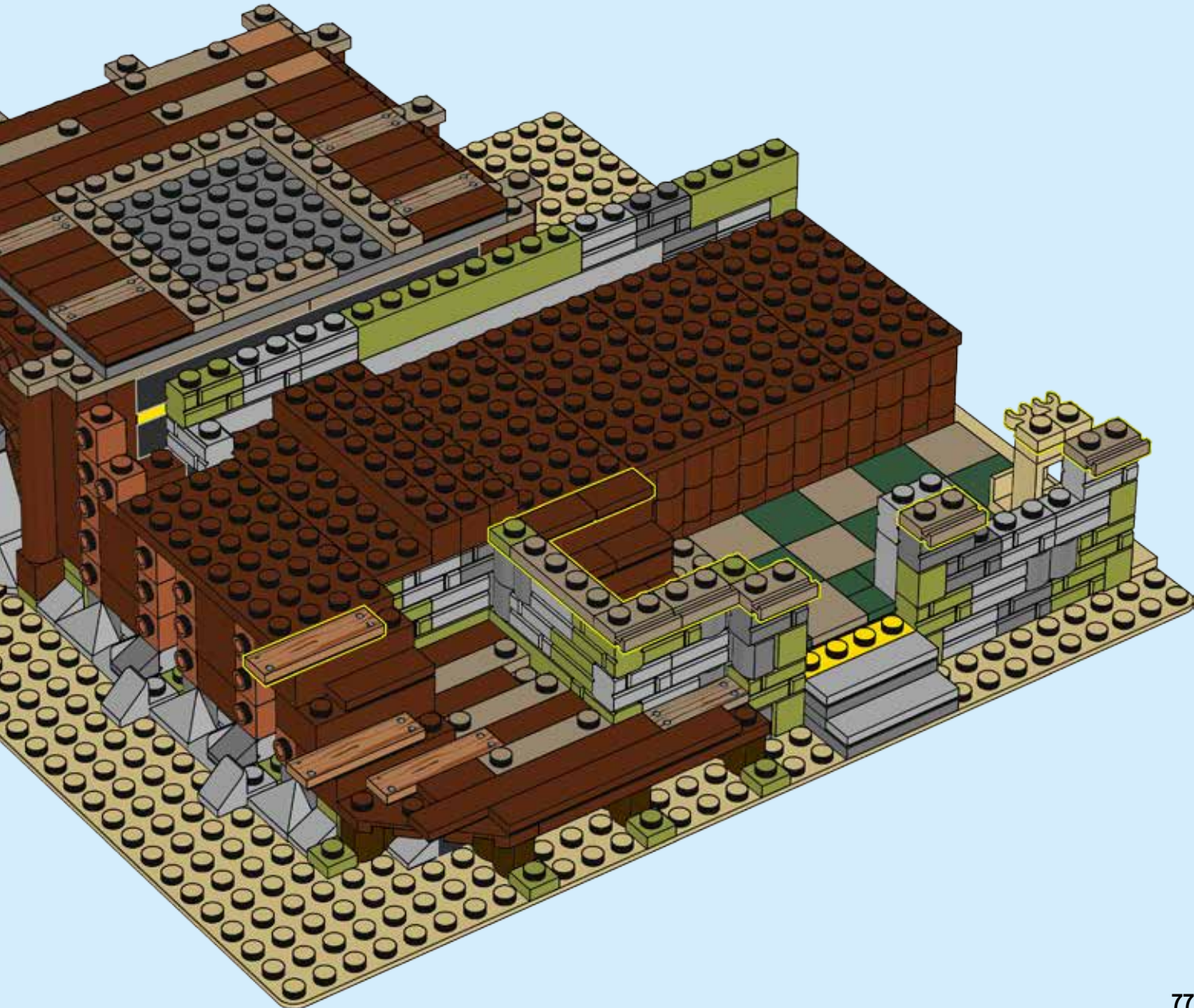

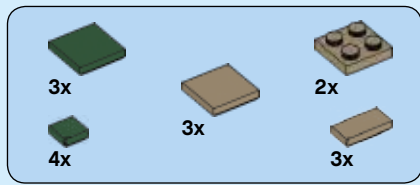

66



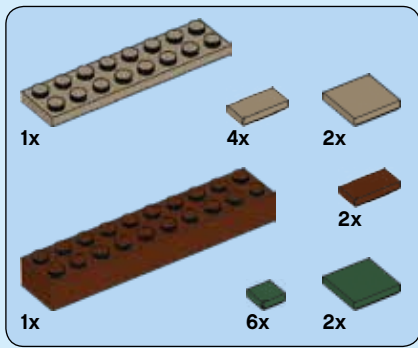

67

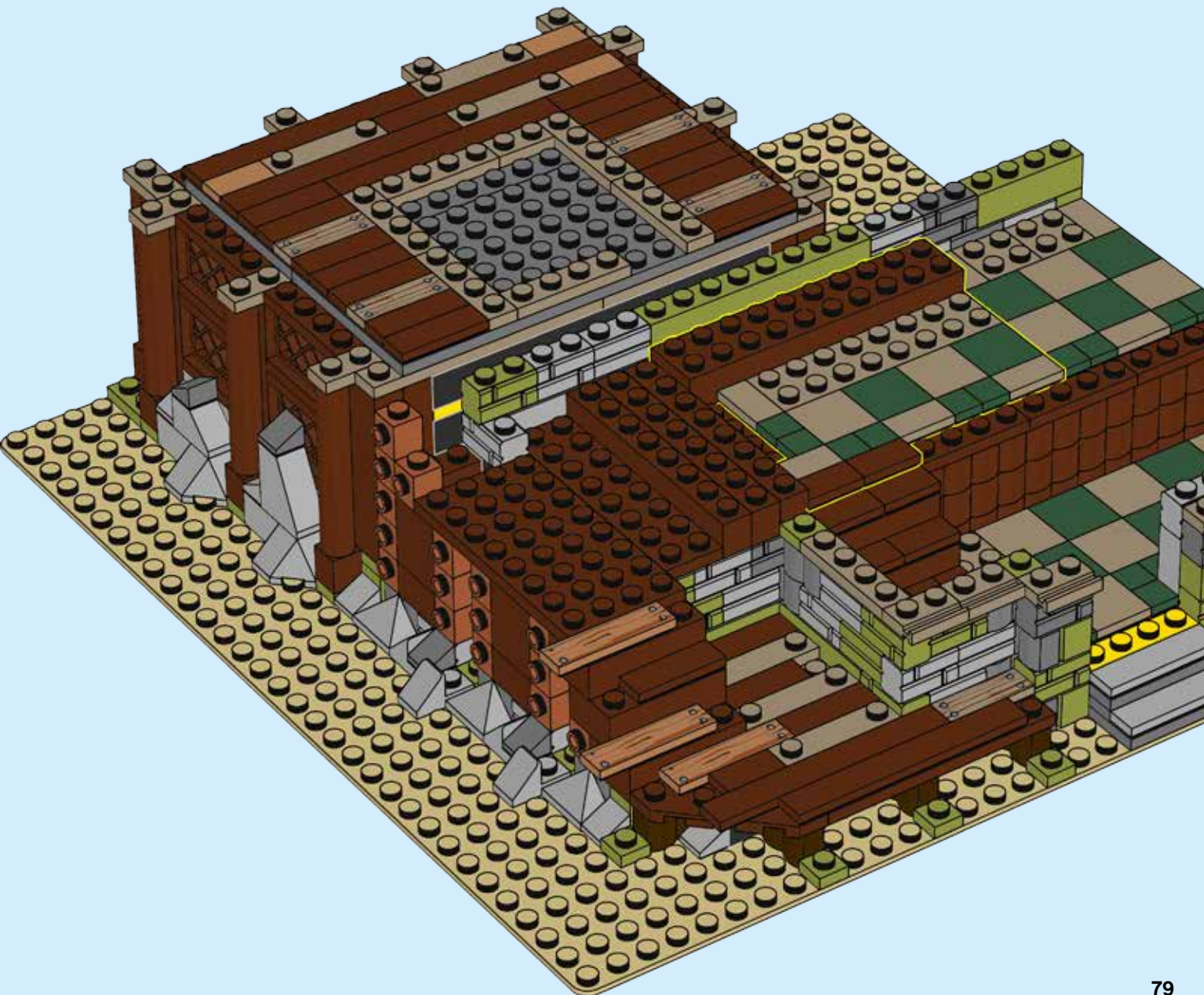

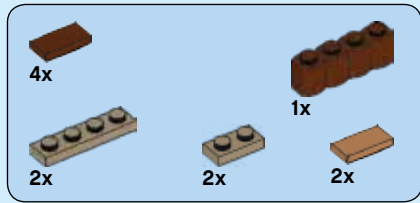

68



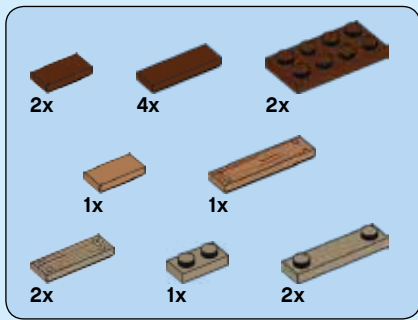

69

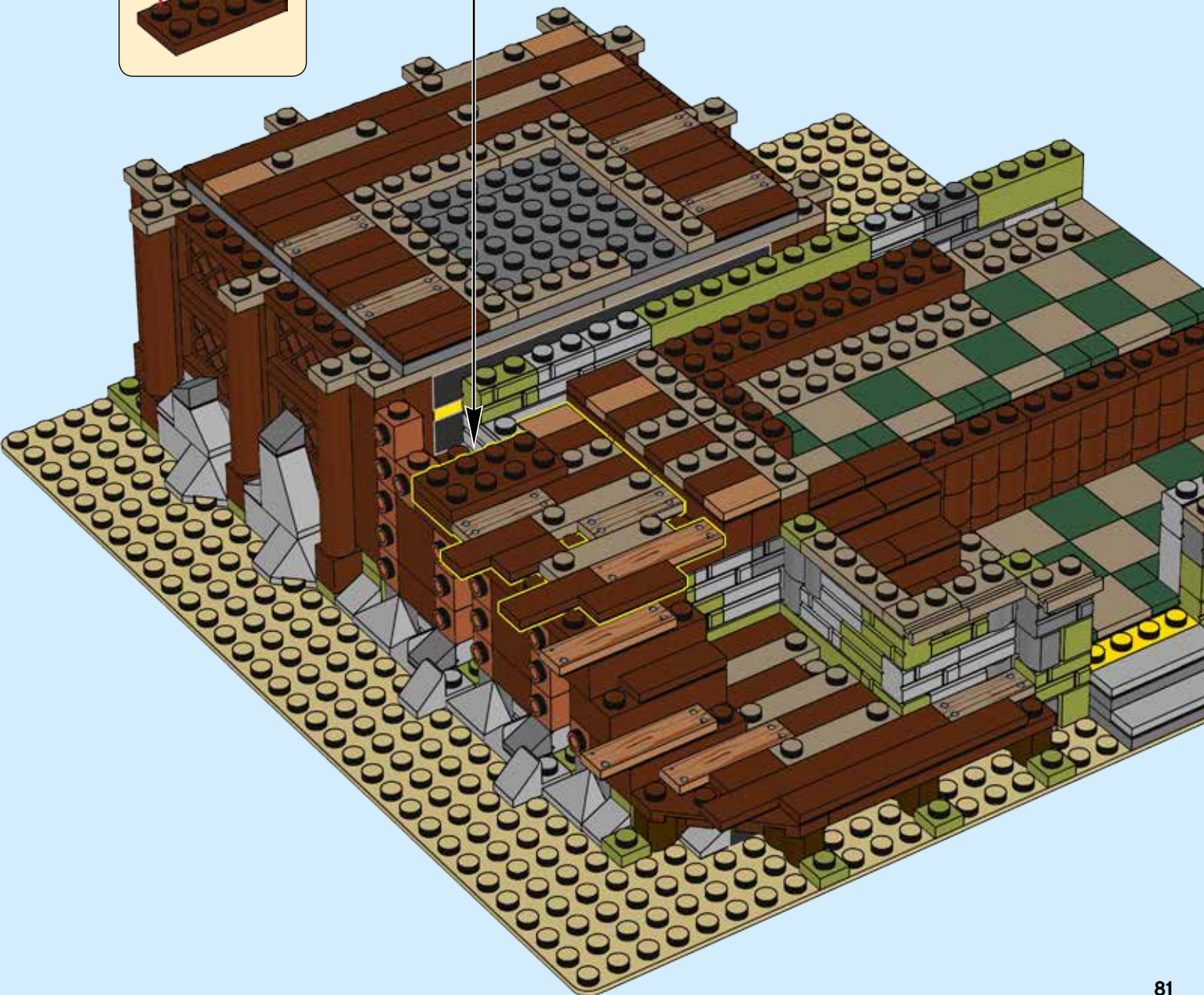
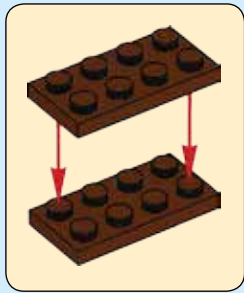

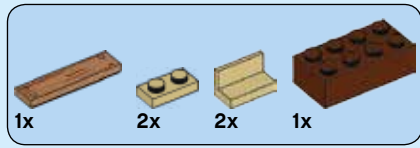

70



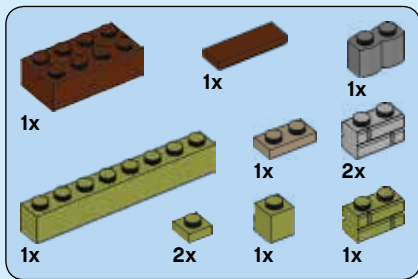

71

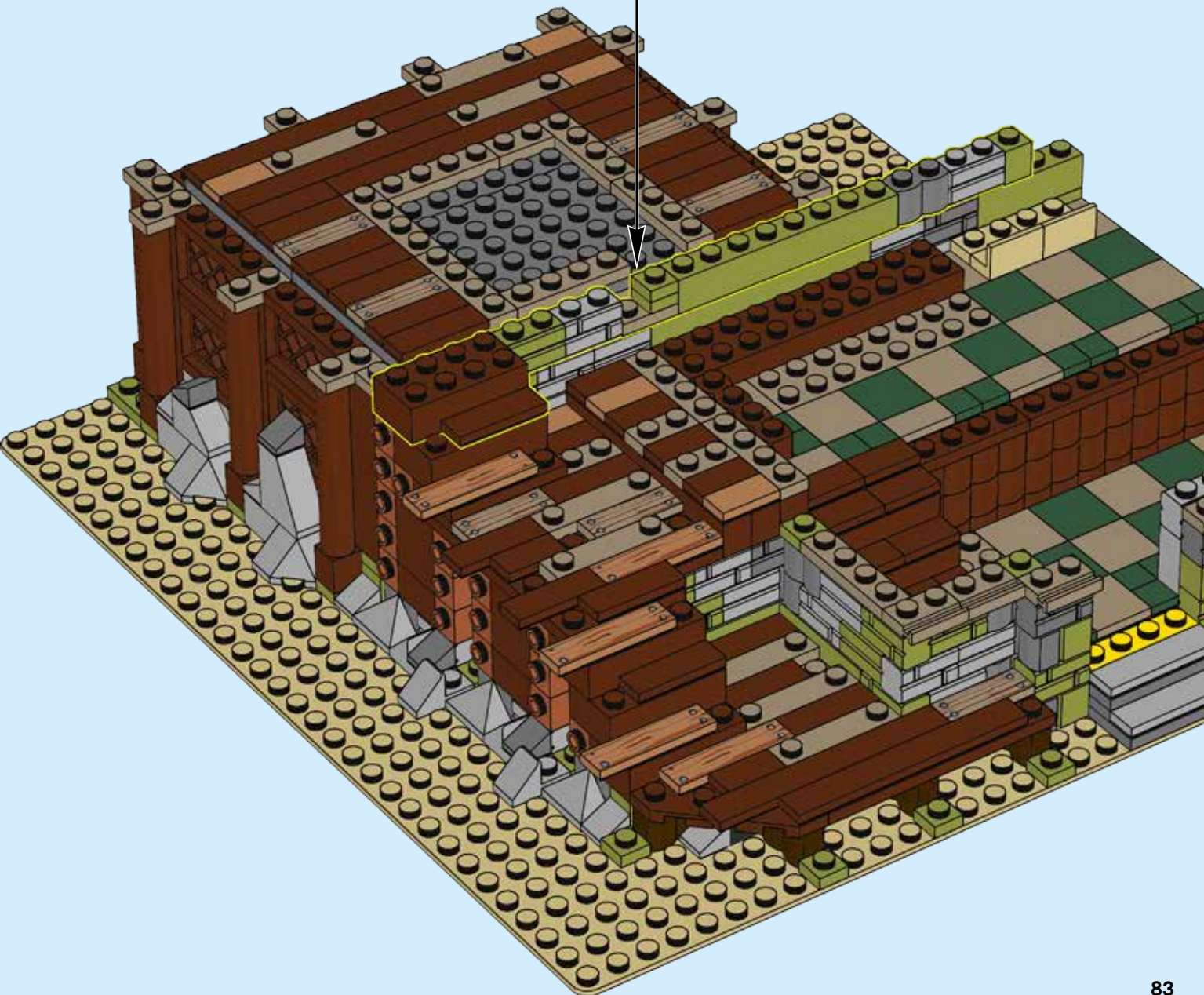
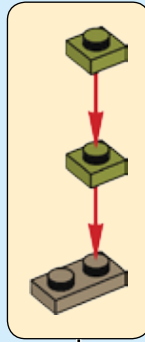

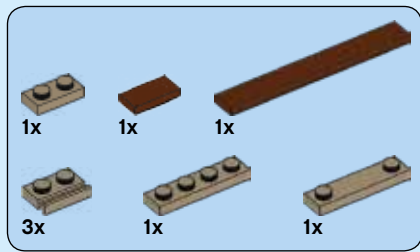

72

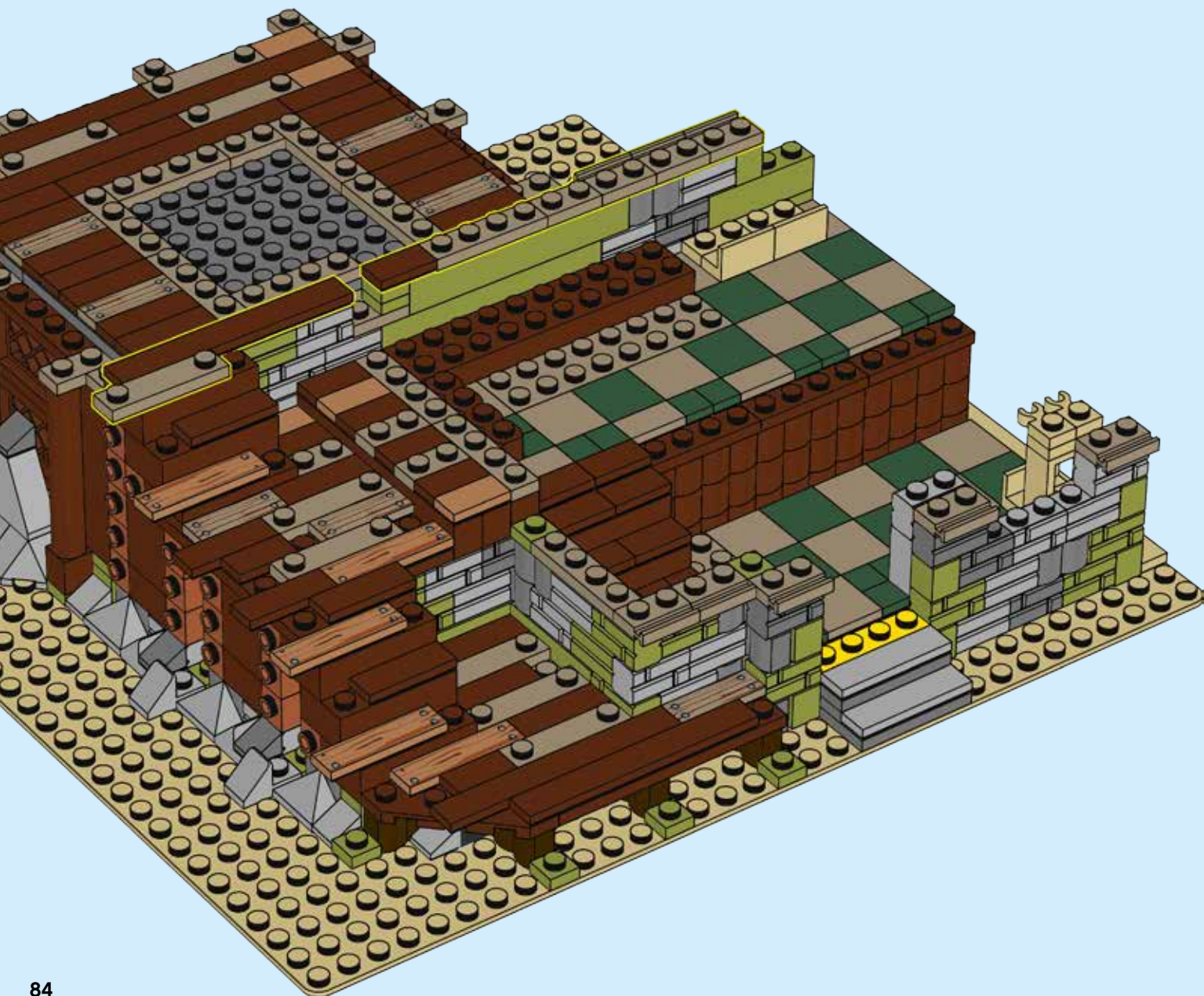



73





4x

74



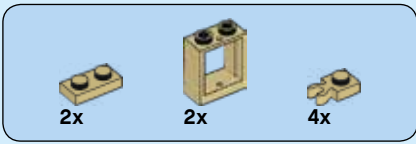

75

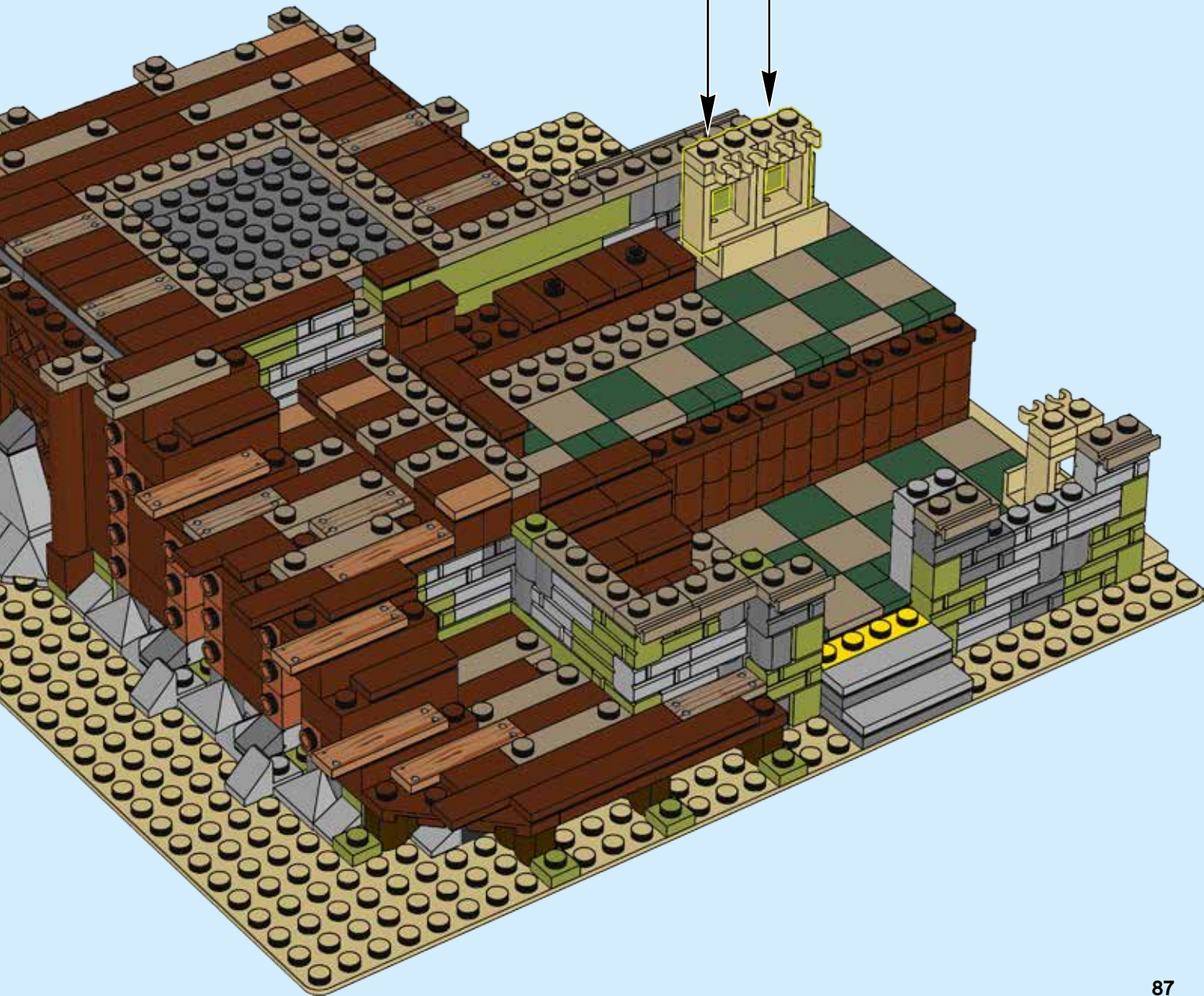
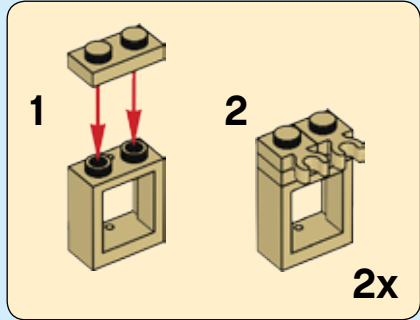

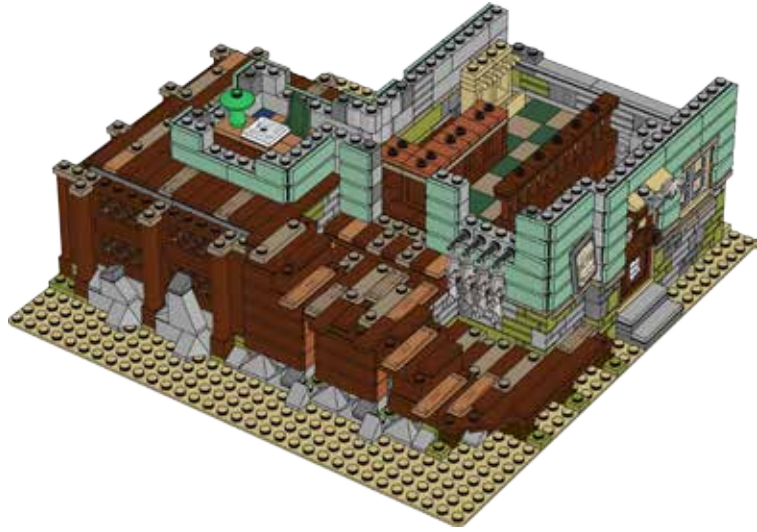
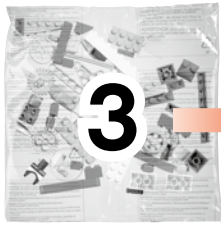





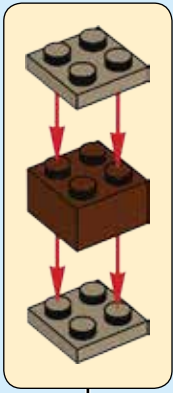

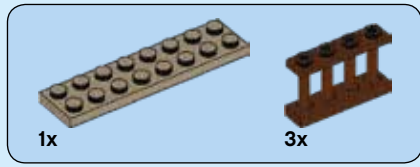
76





77



			
2x	2x	5x	8x

78



1x 1x 8x 8x

79

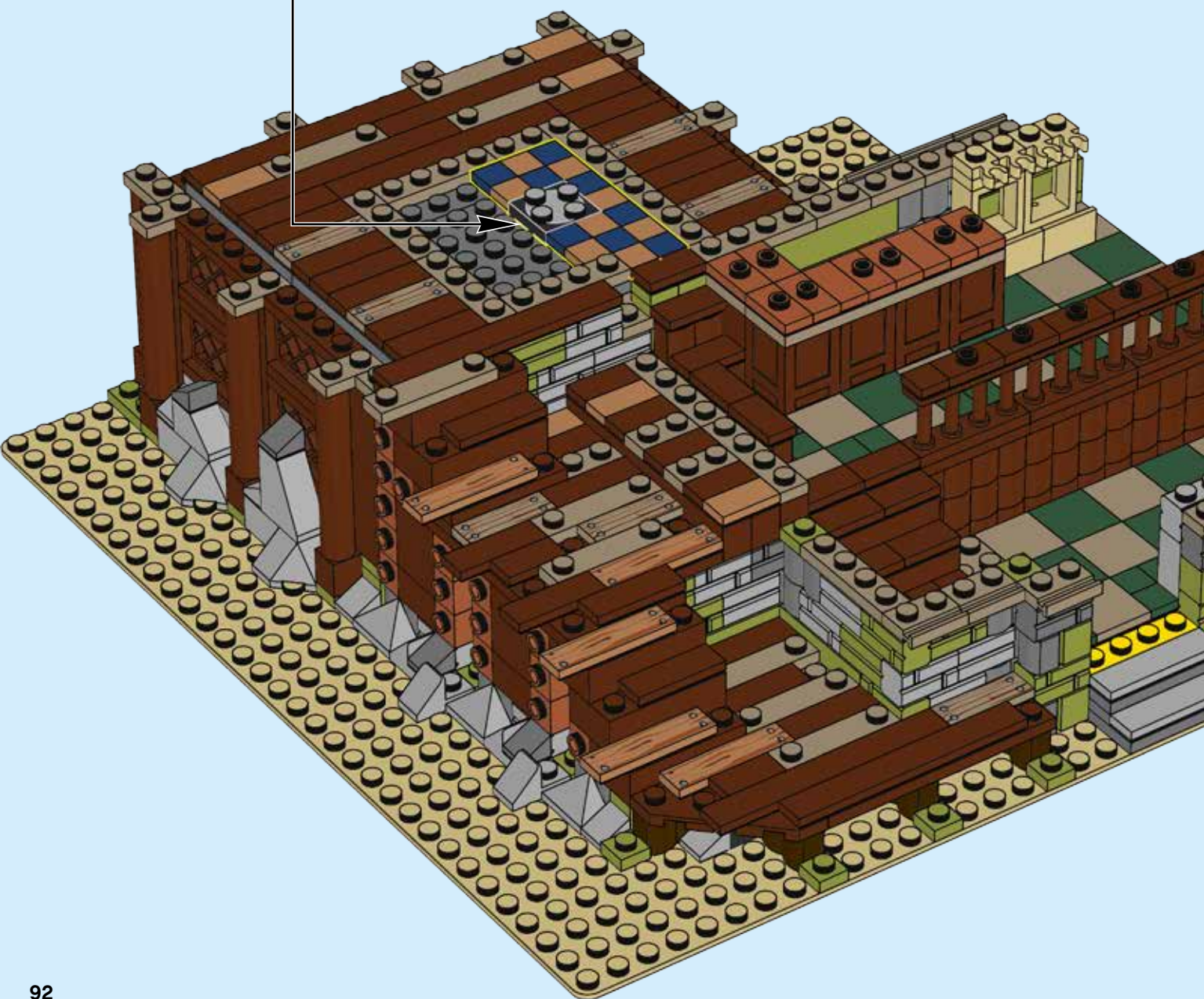



4x



4x

80

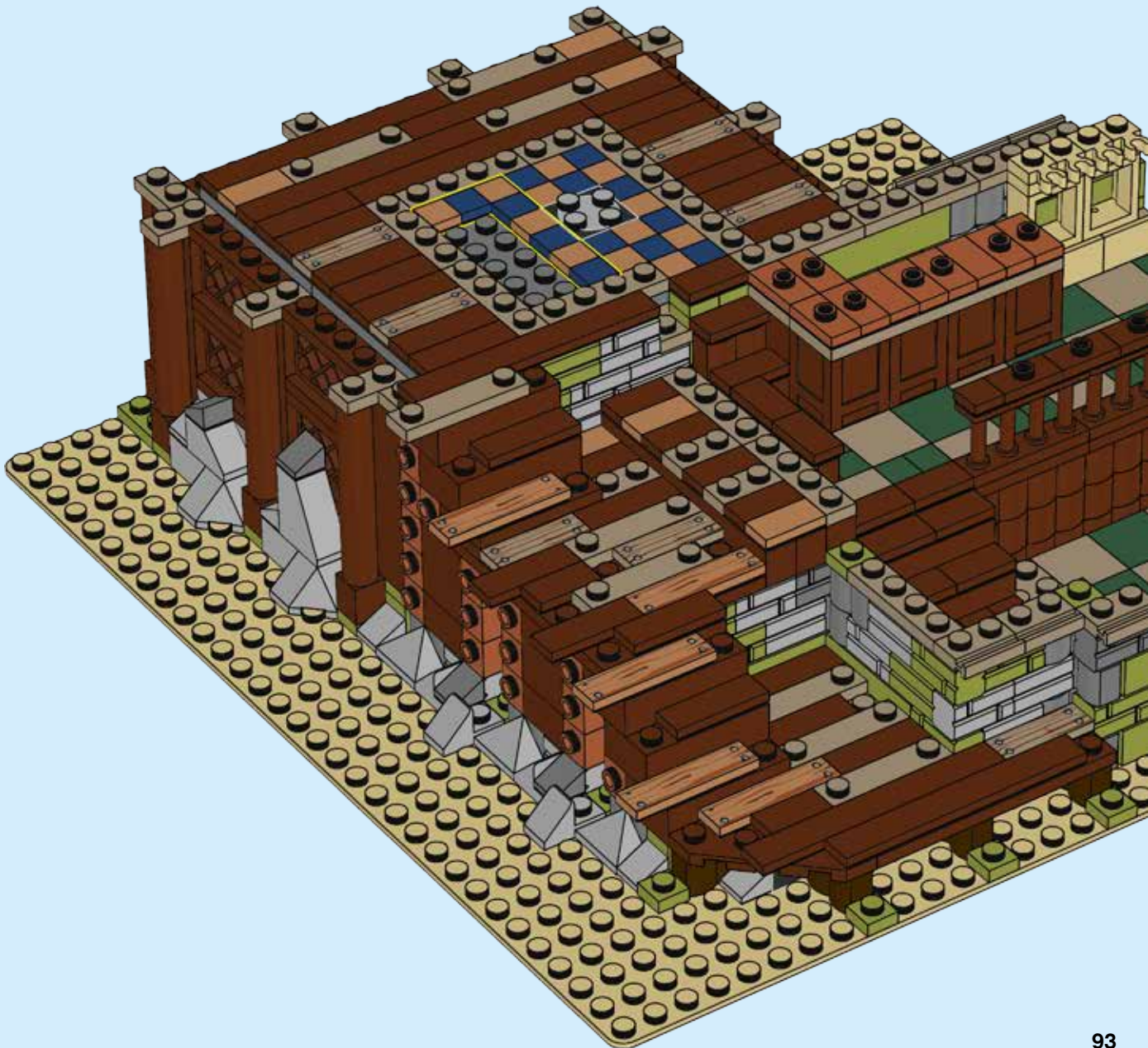

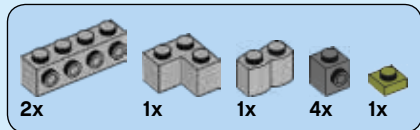

81

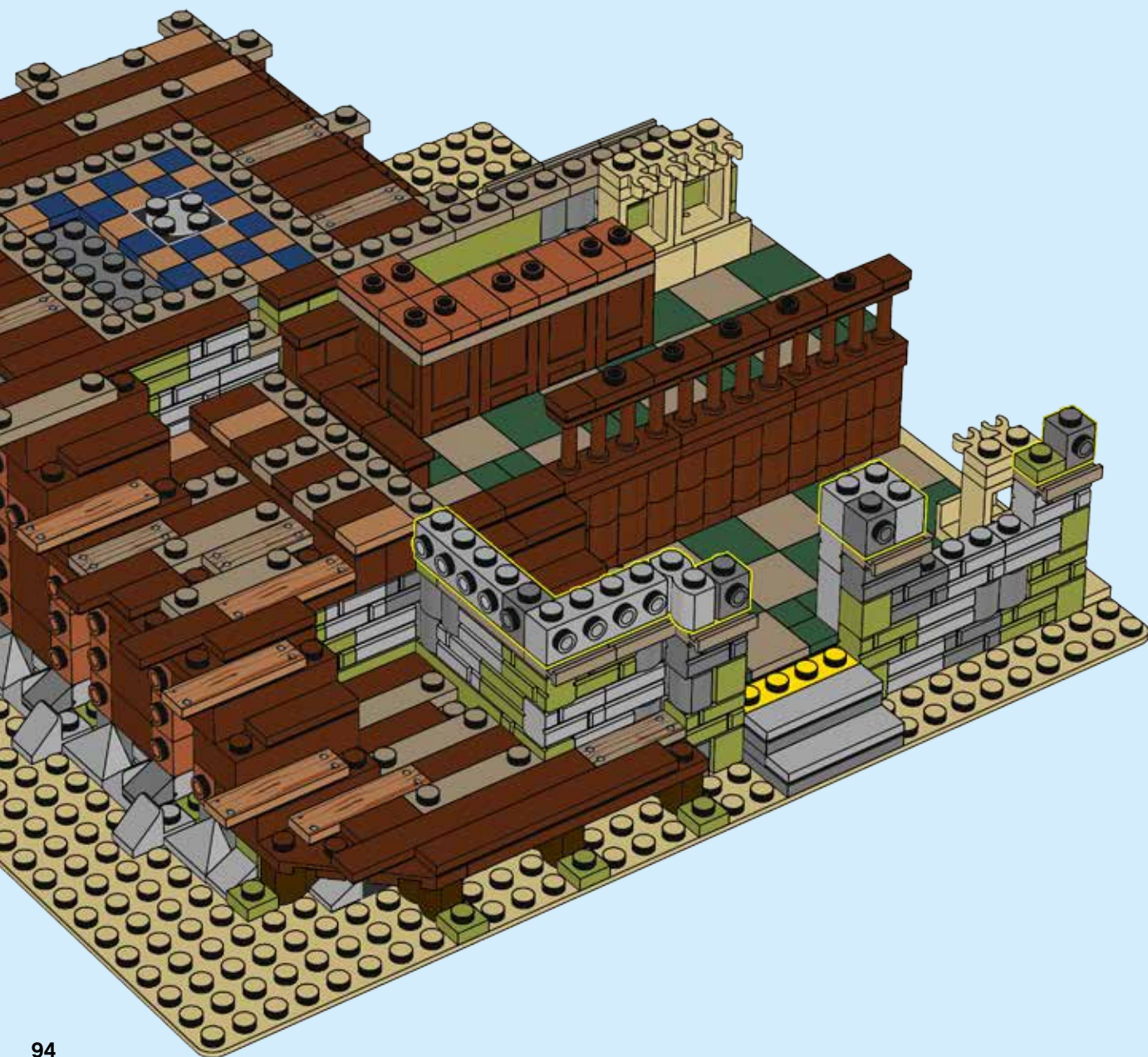

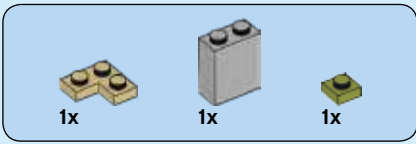

82

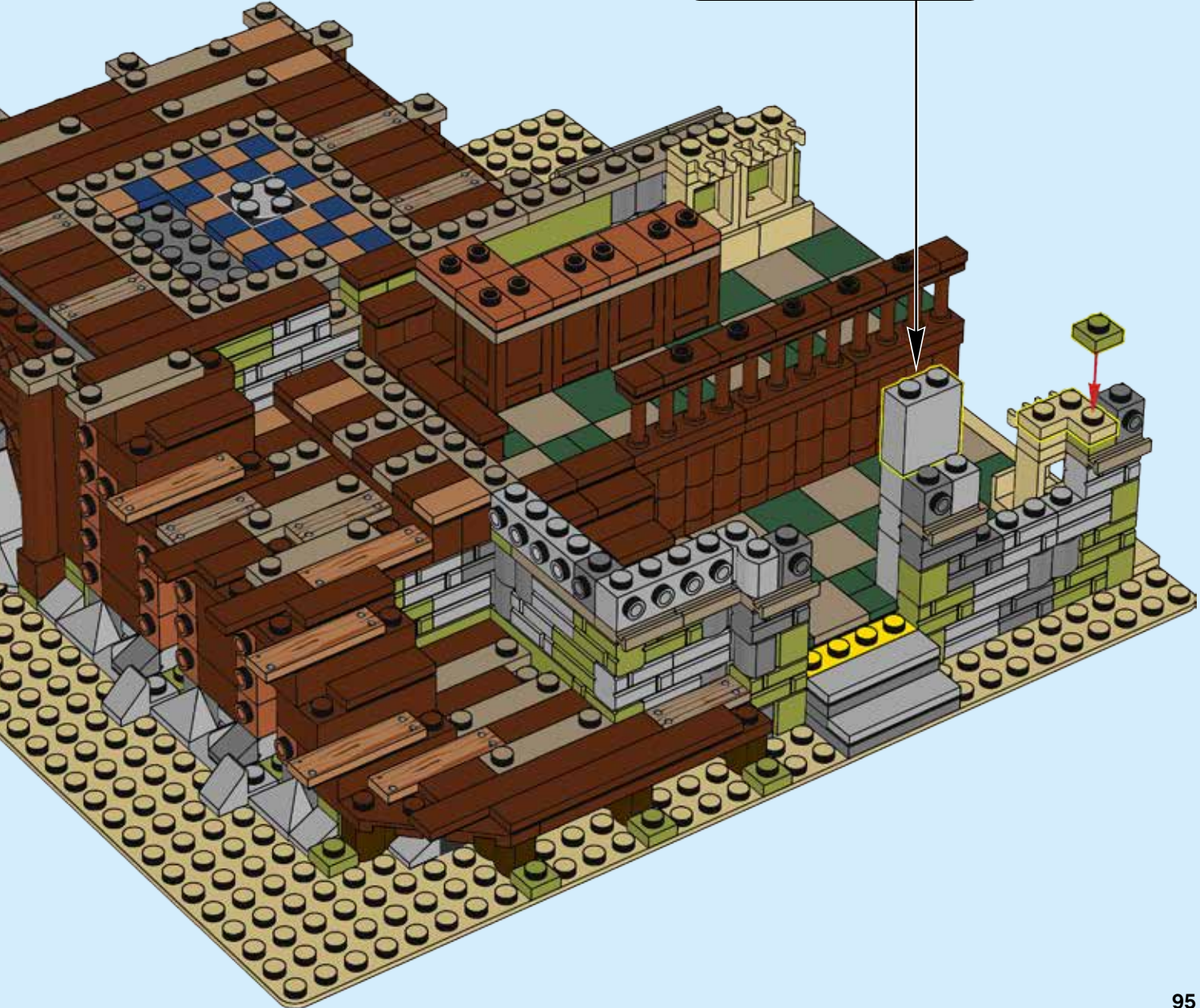
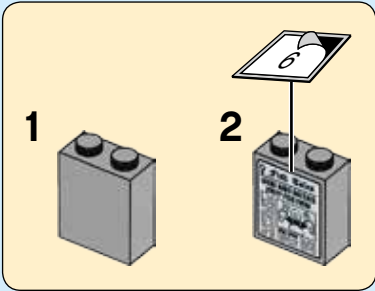

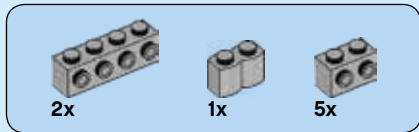

83

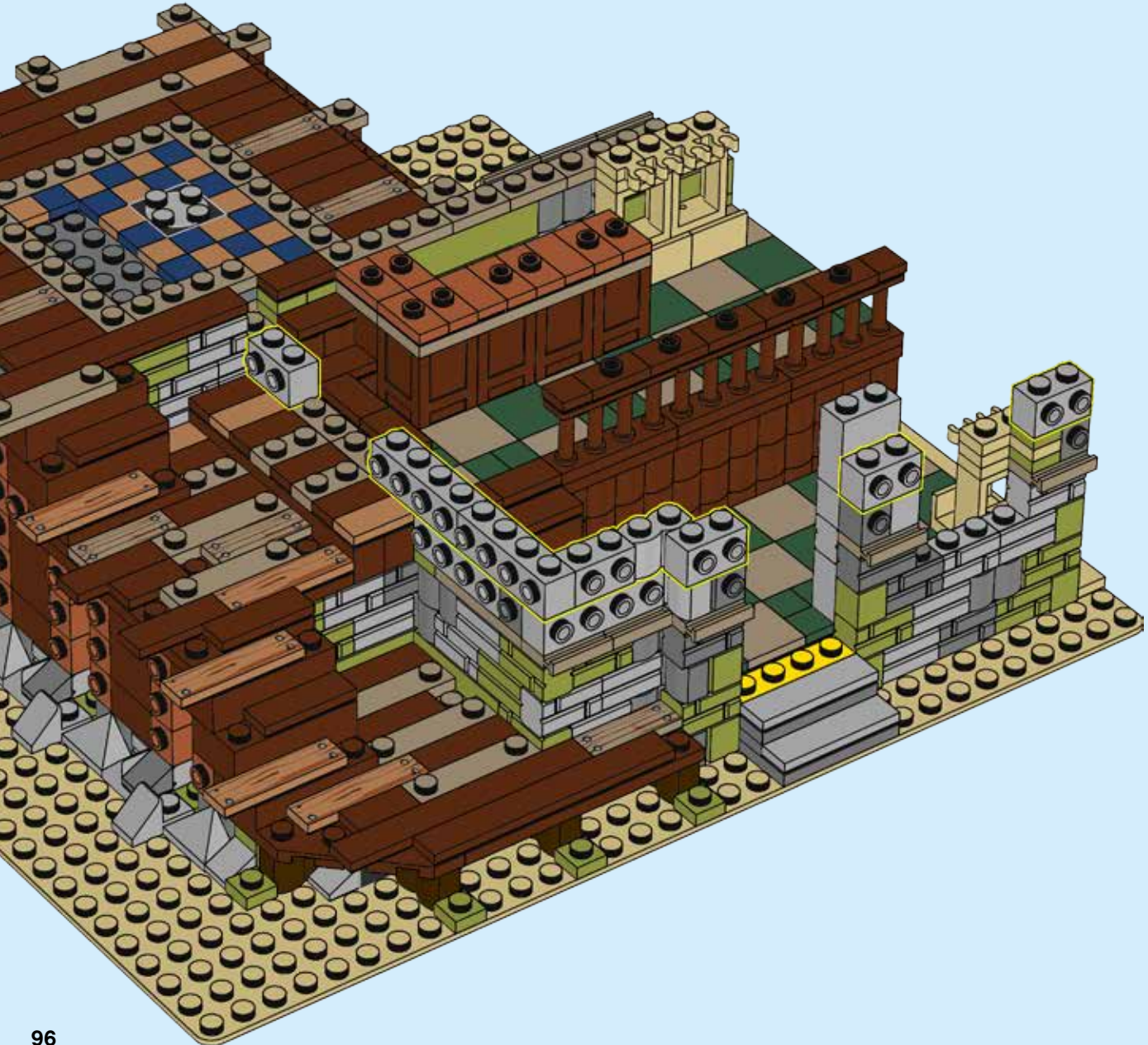

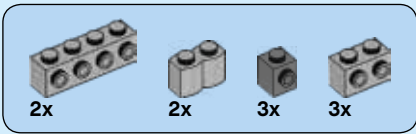

84

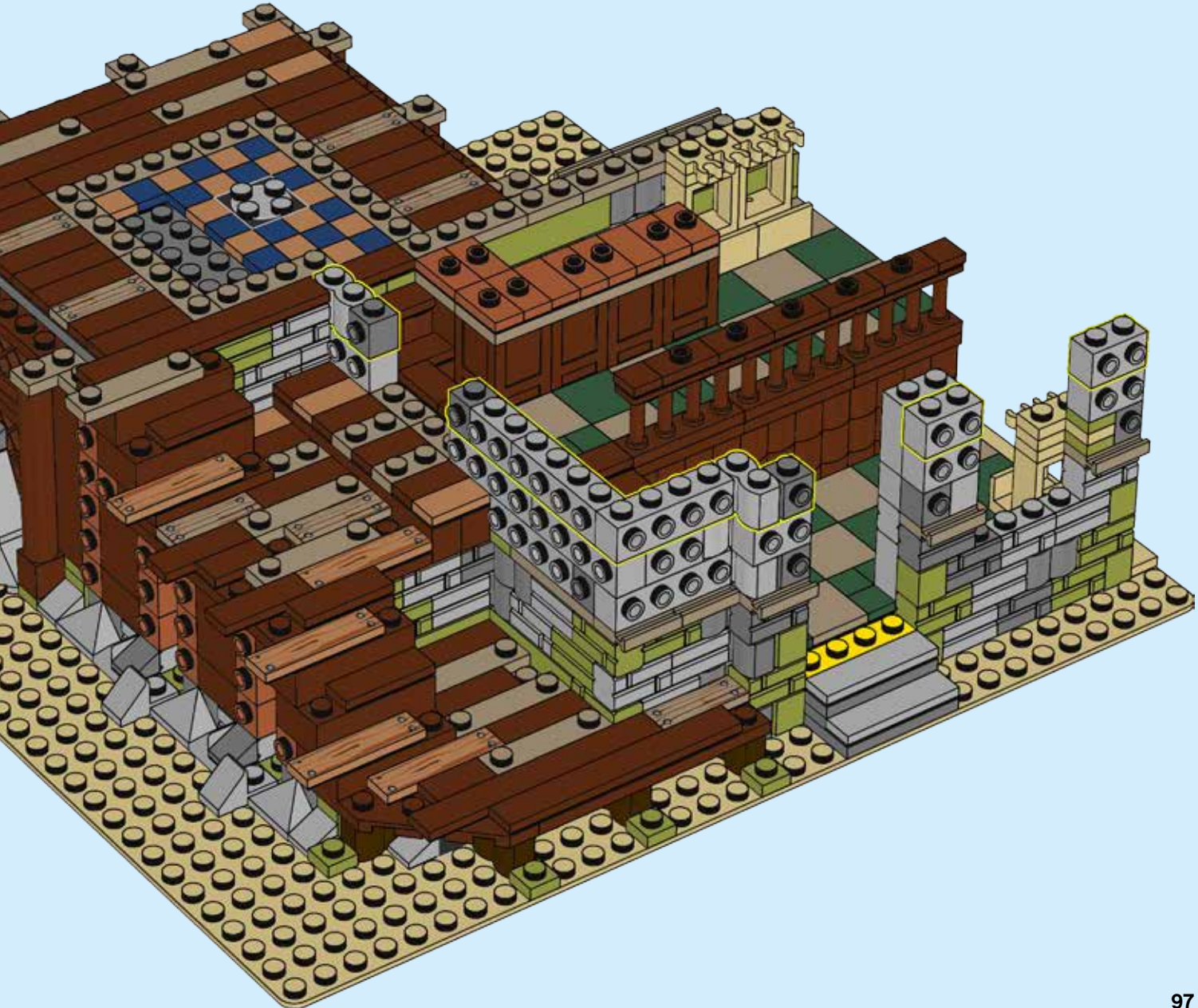

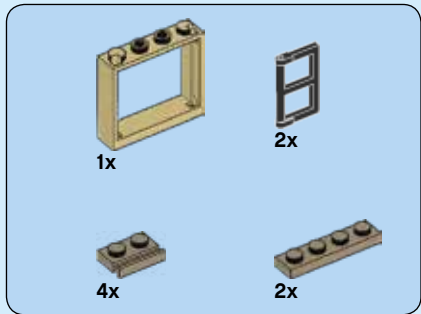

85

1

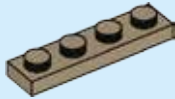

2

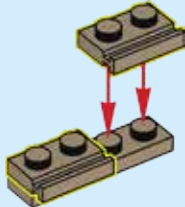

3

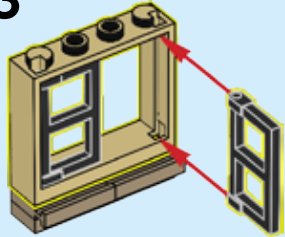

4

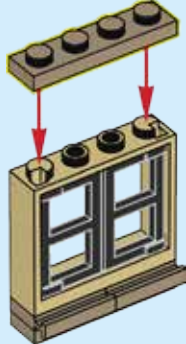

5

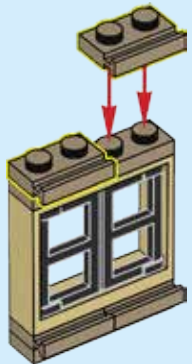

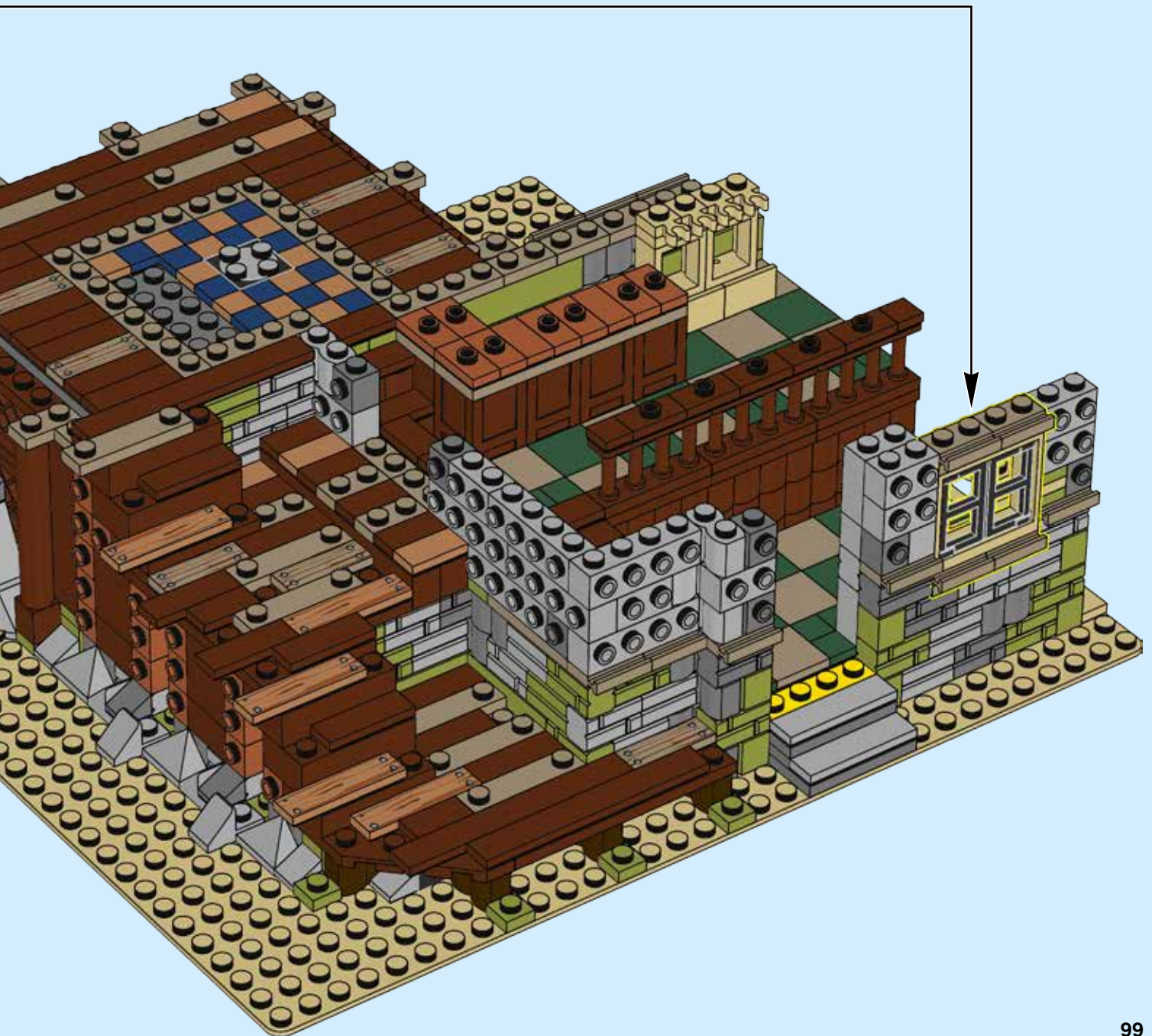

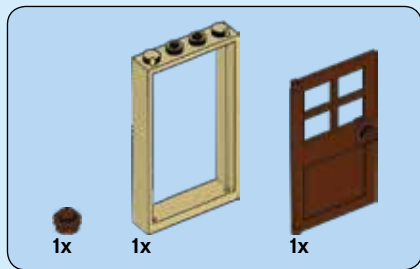

86

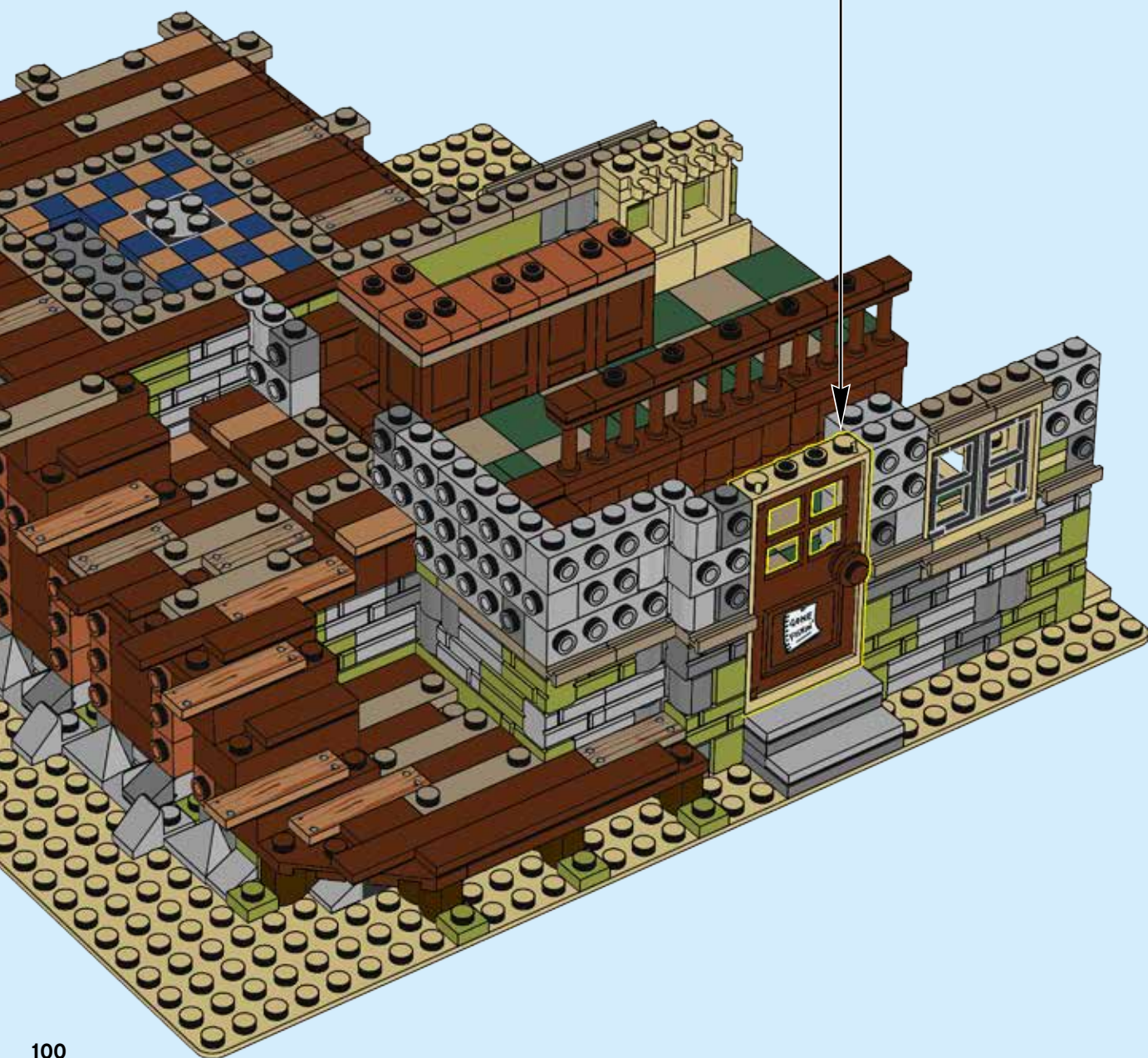
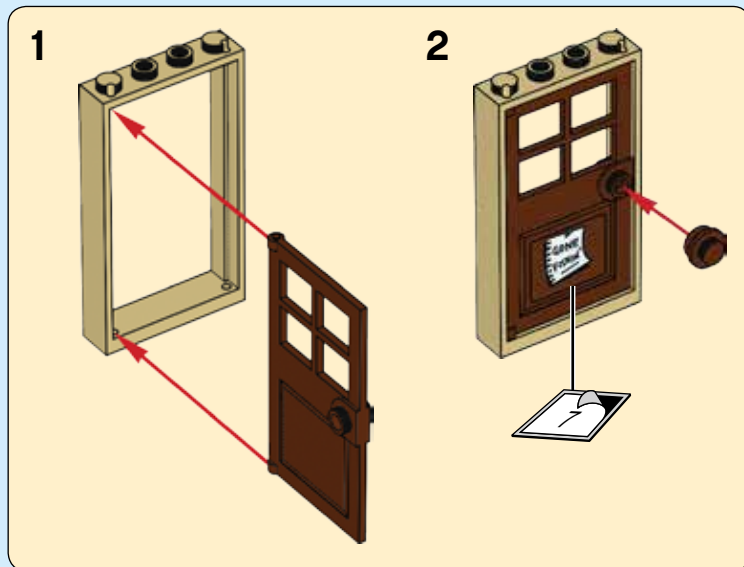

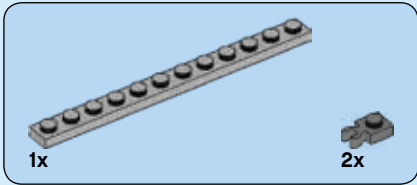
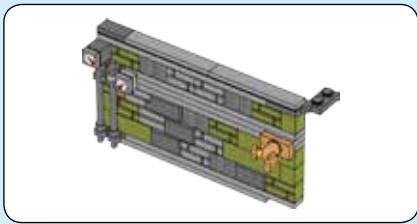

87

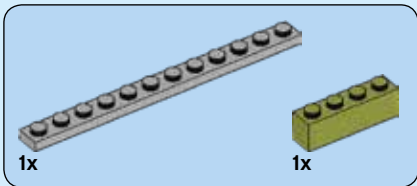
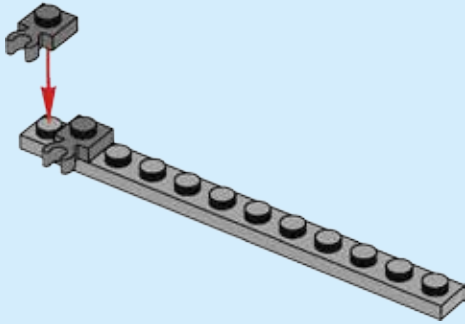

88

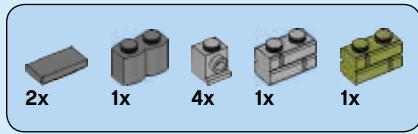
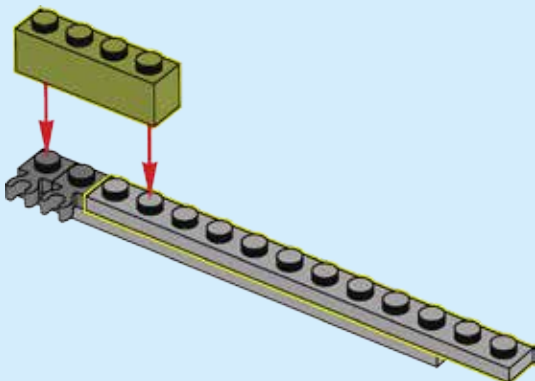

89

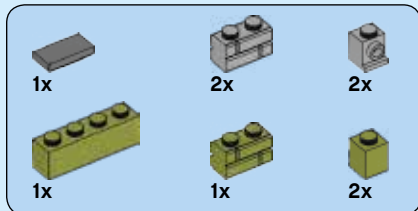
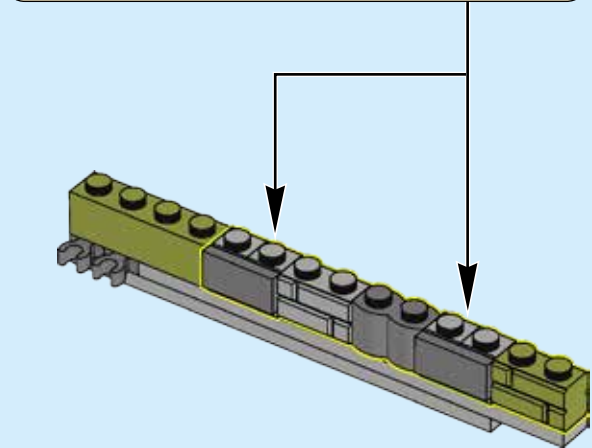
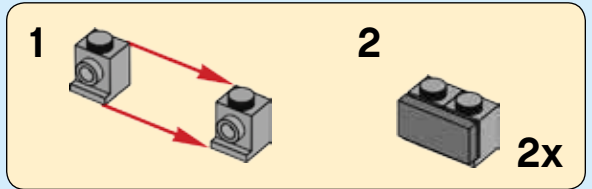

90

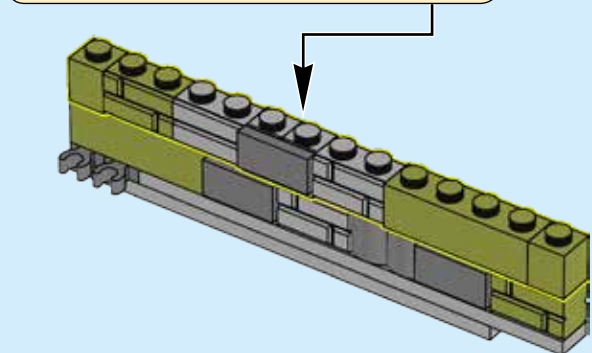
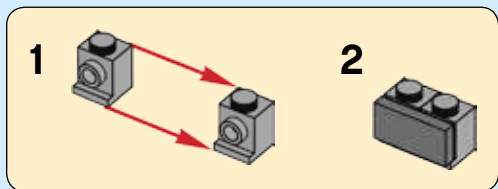

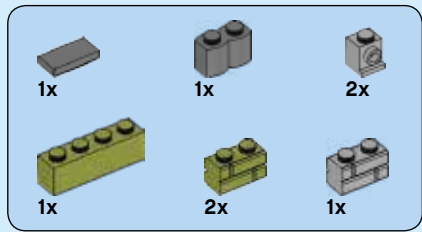

91

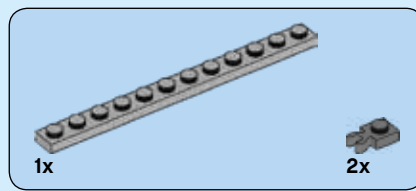
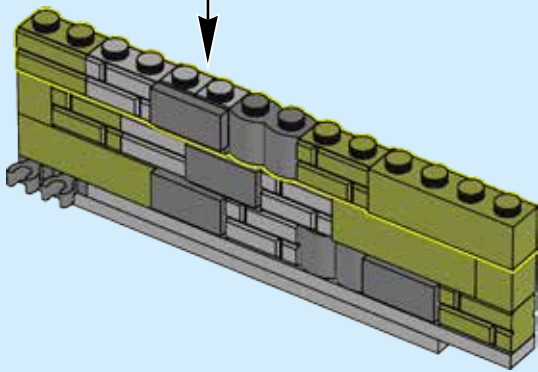
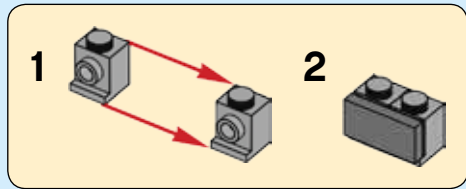

92

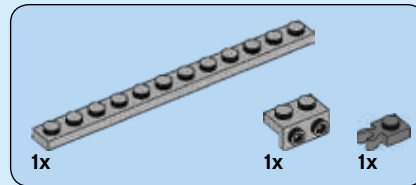
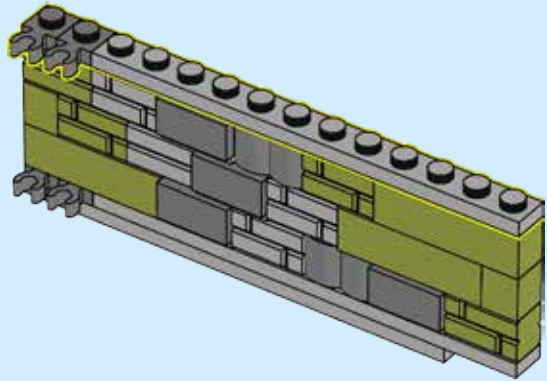

93

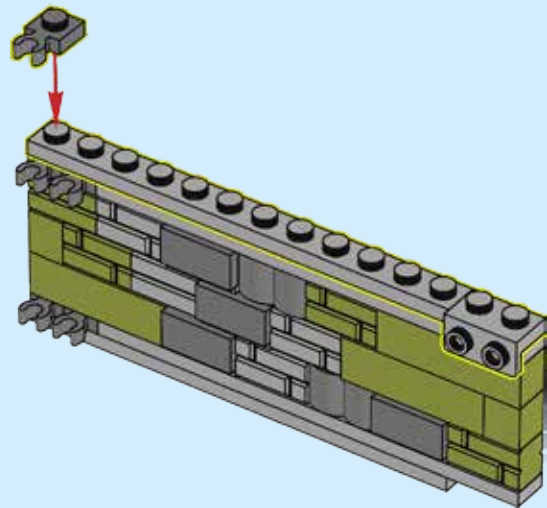

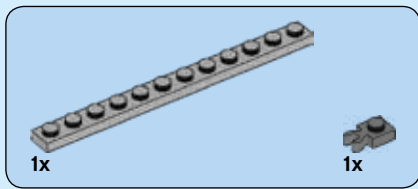

94

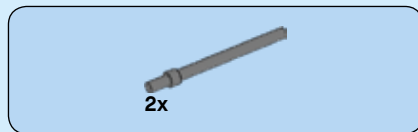
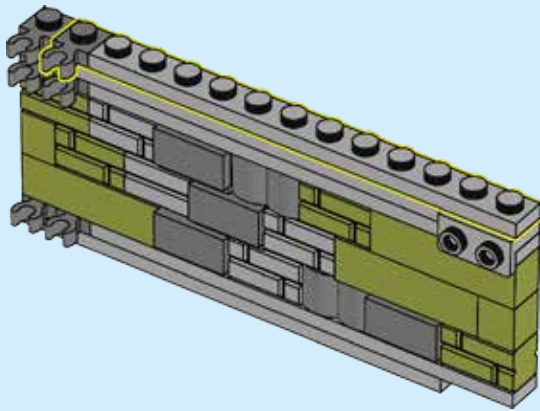

95

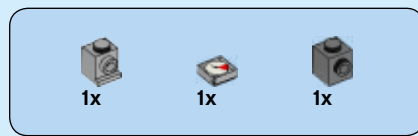
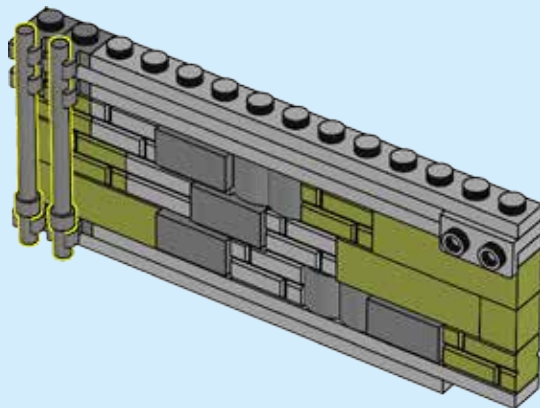

96

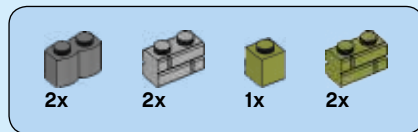
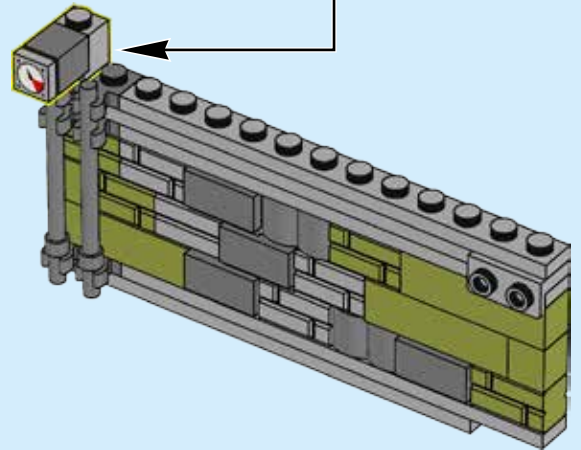
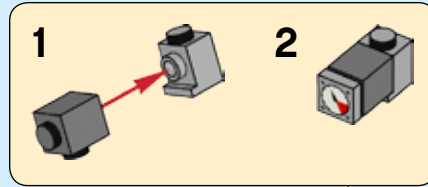

97

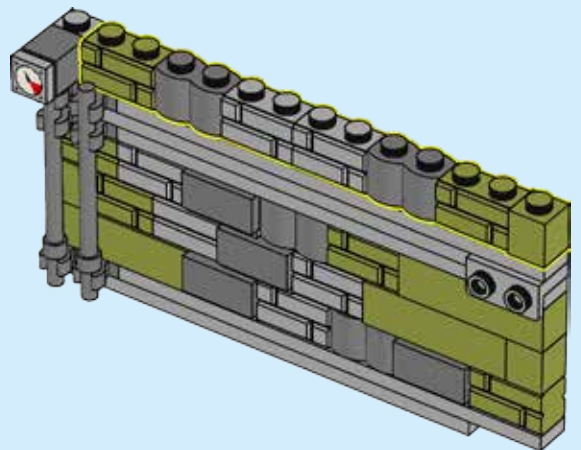

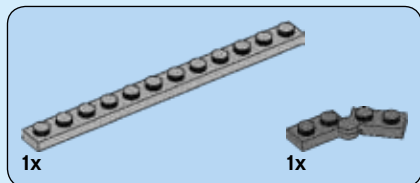

98

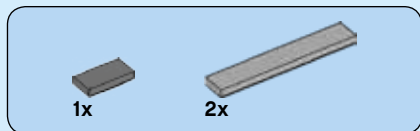
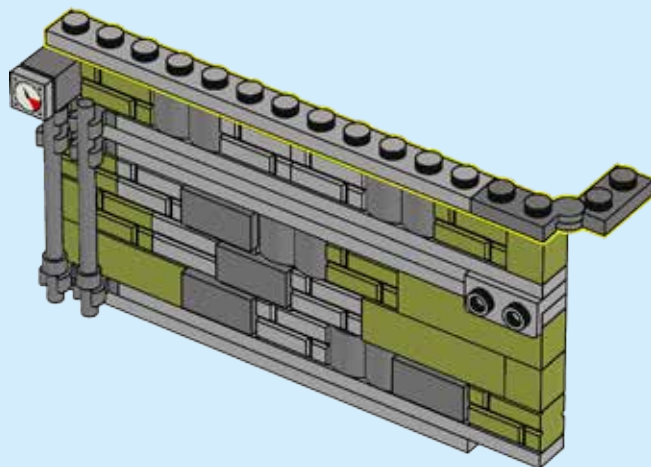

99

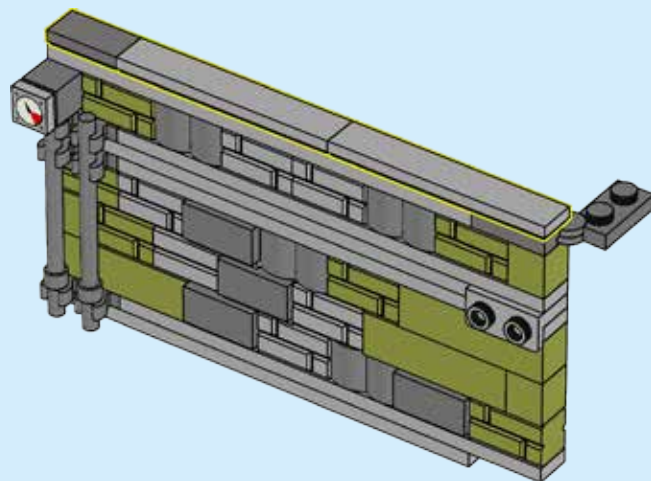



100

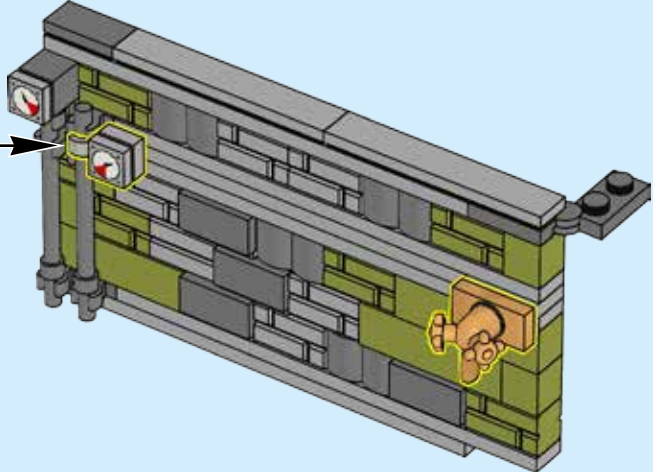
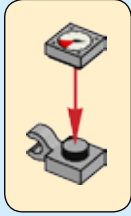

101

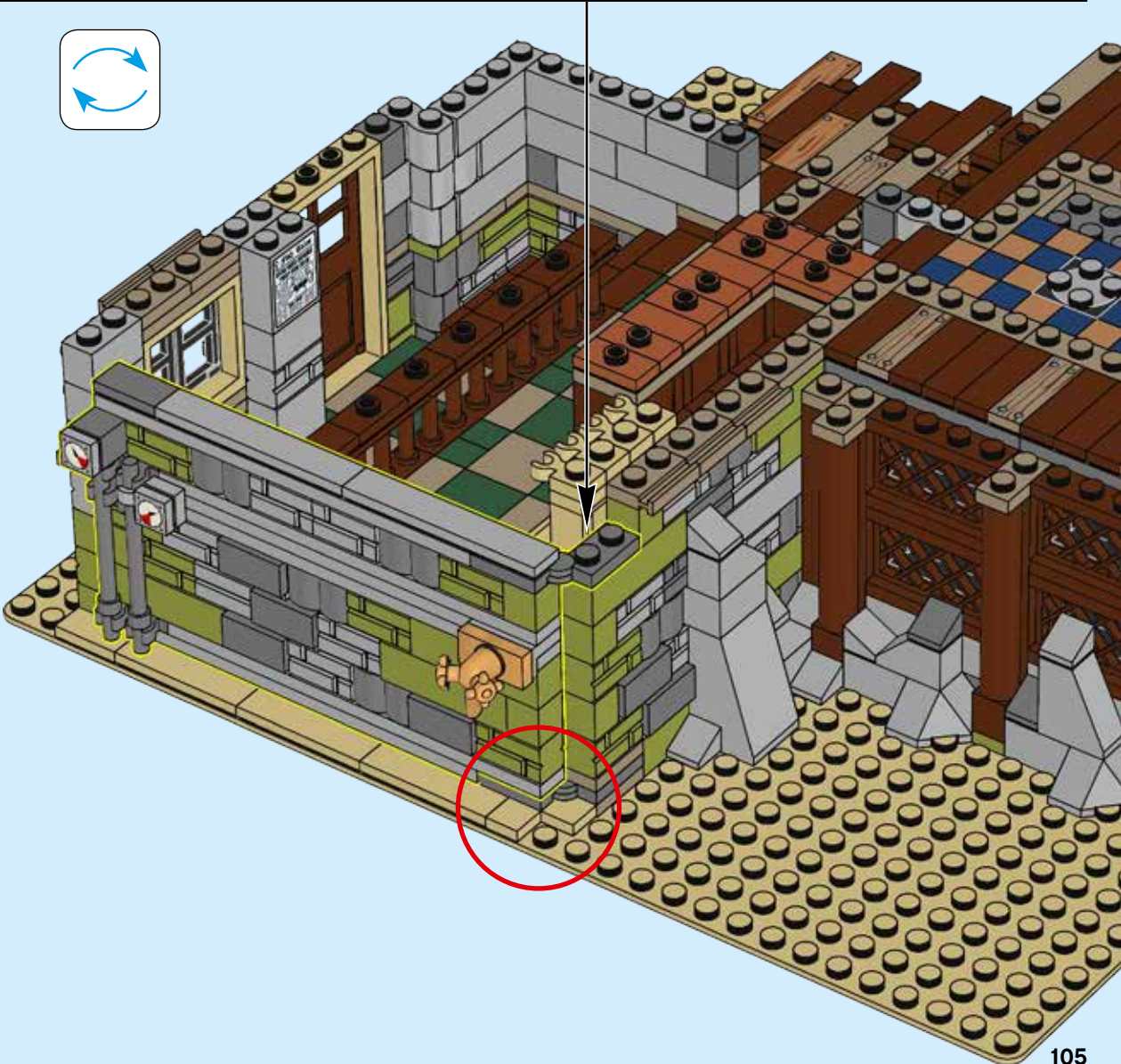
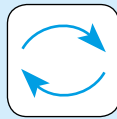

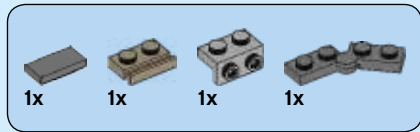

102

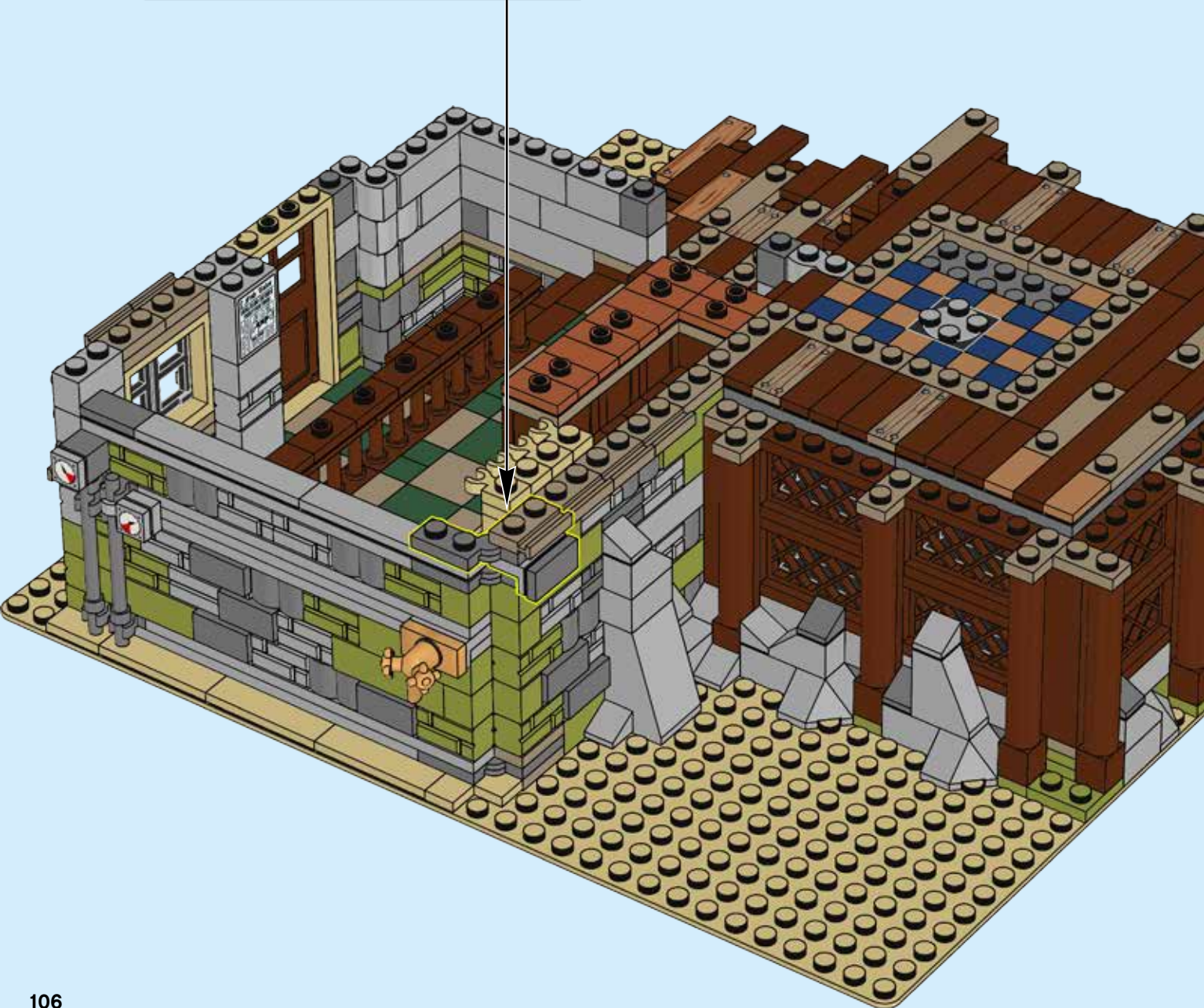
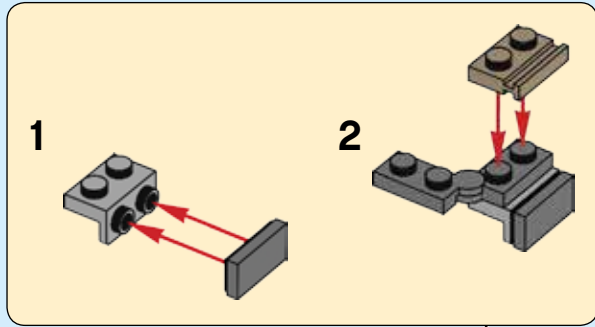



103

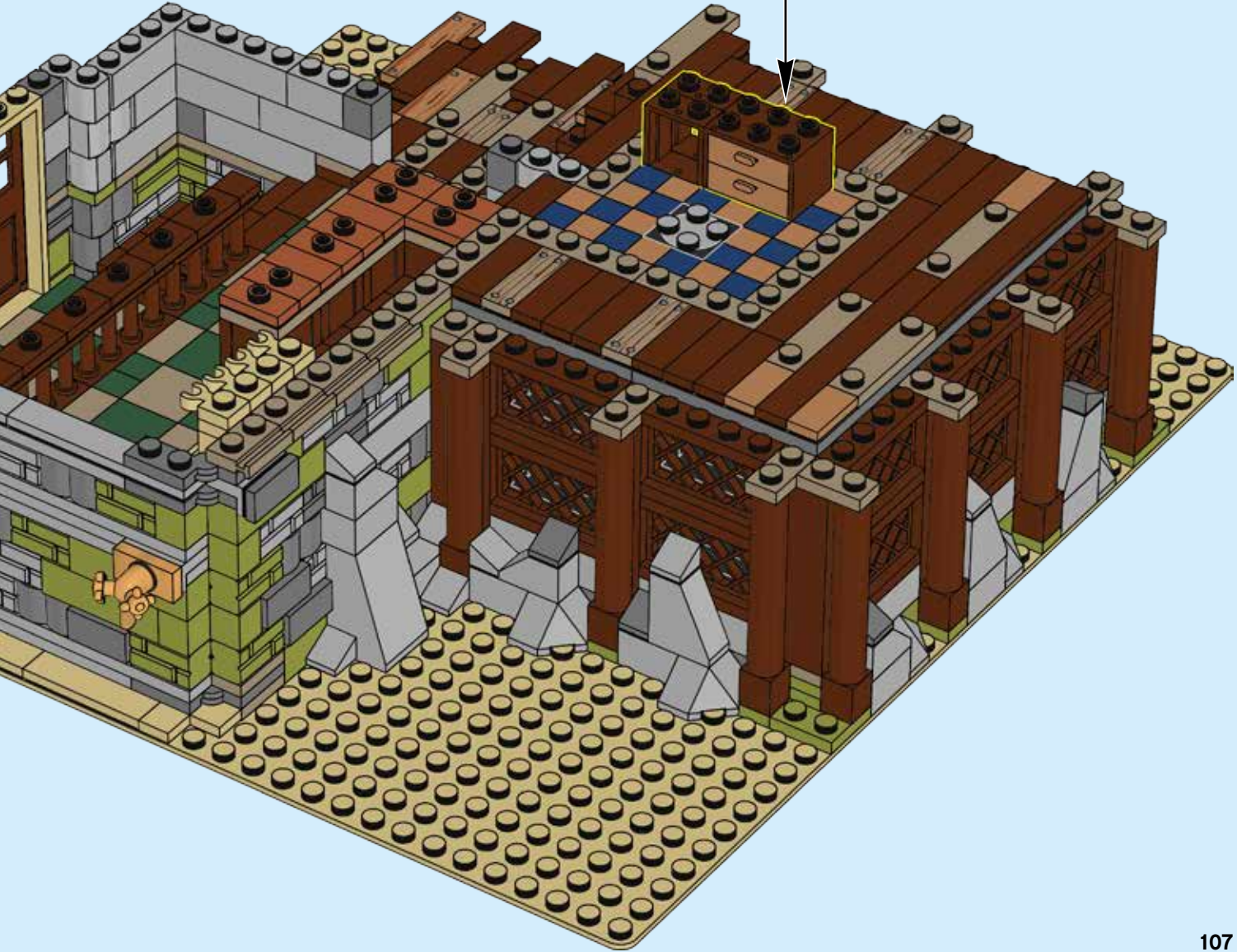
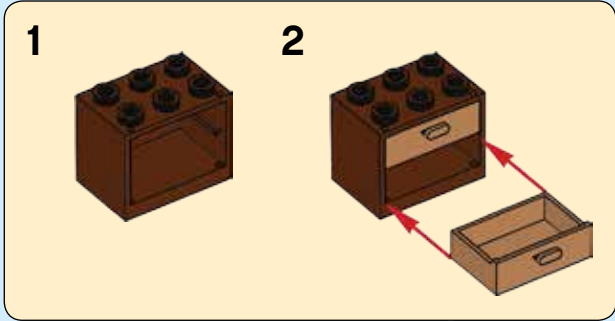



104

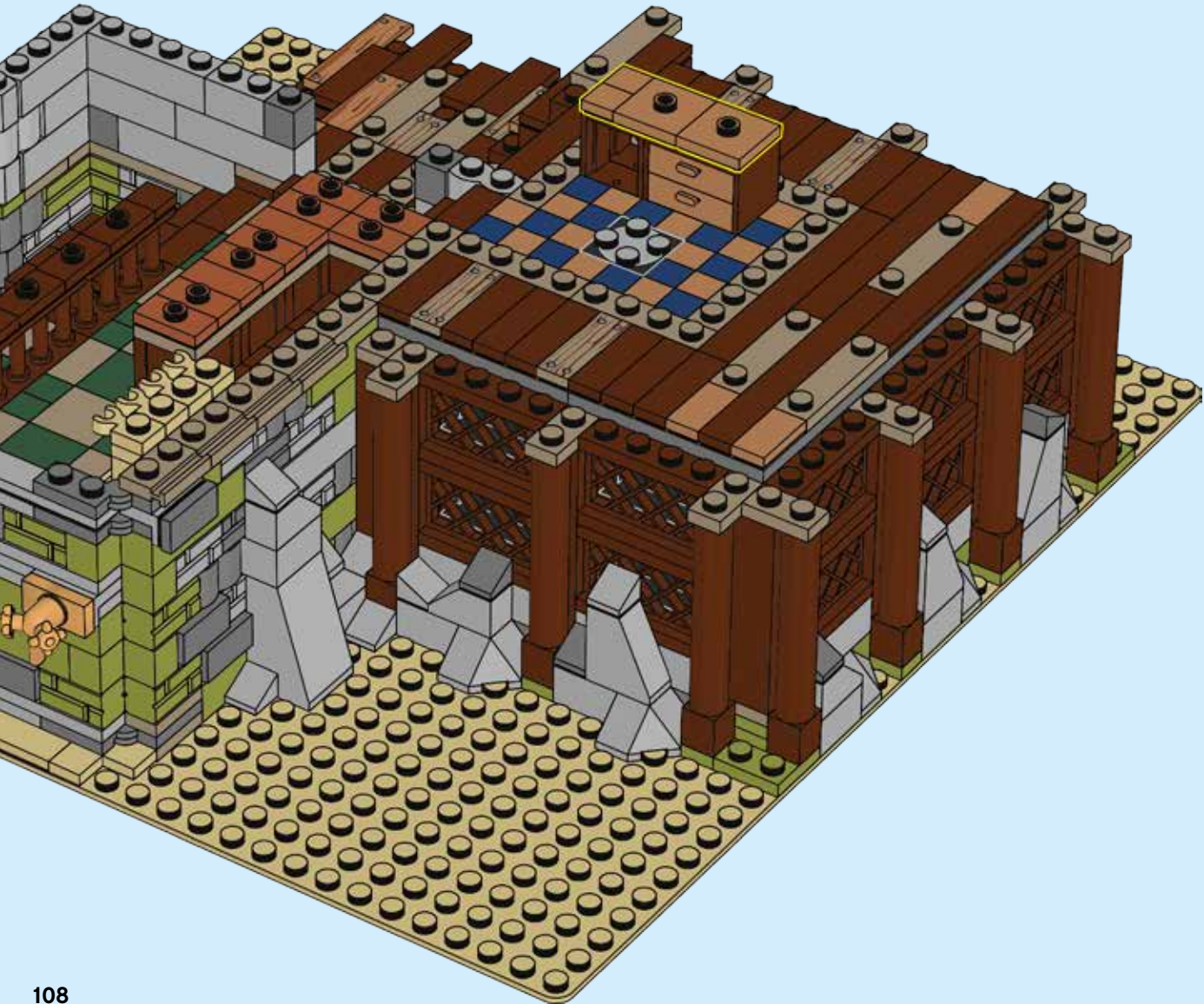

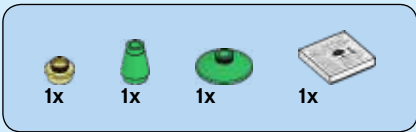

105

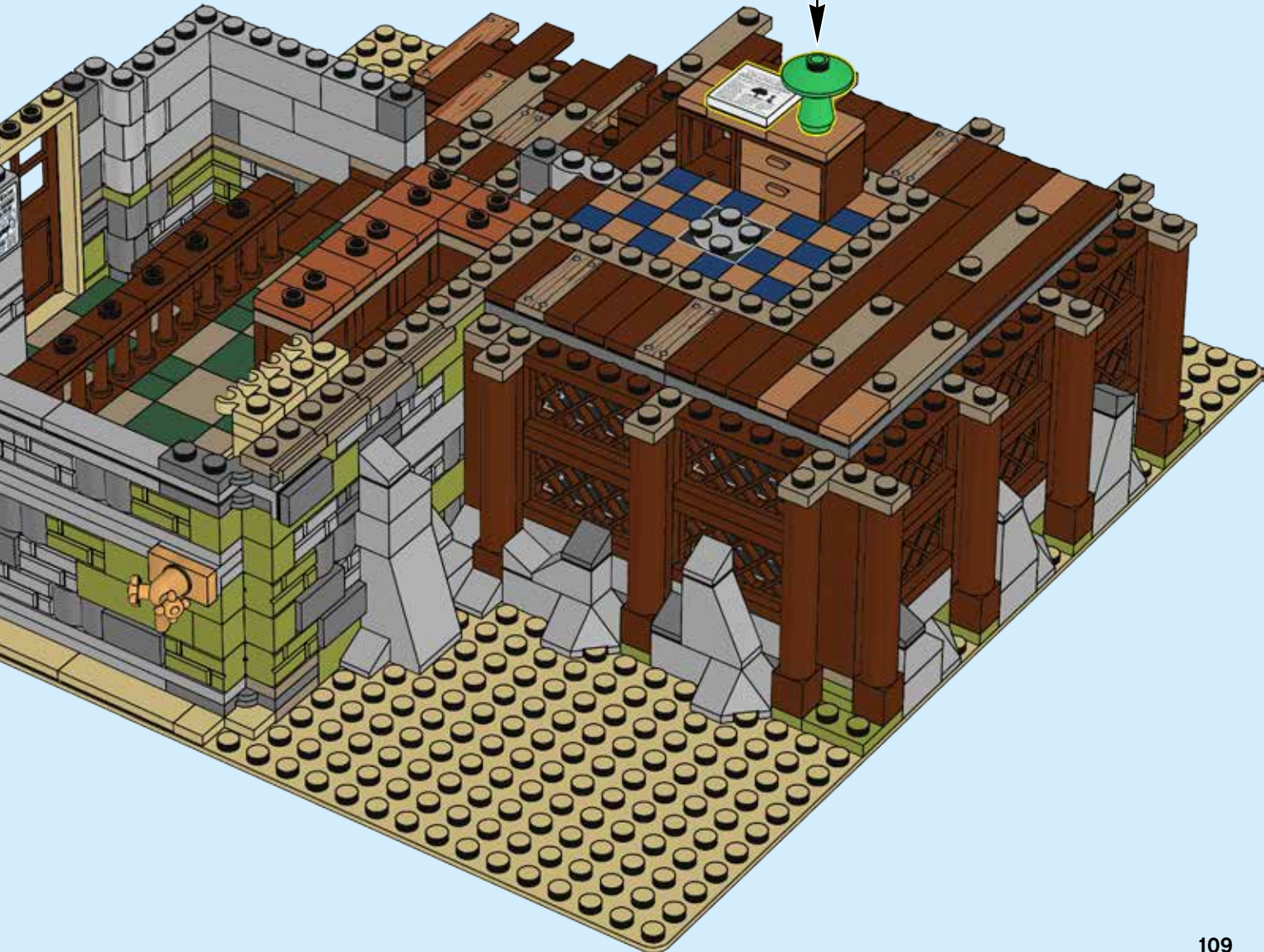
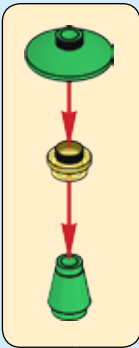

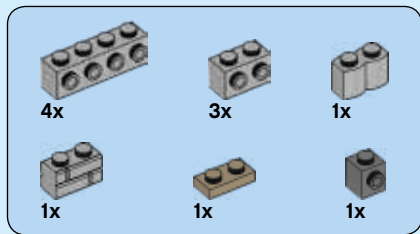

106

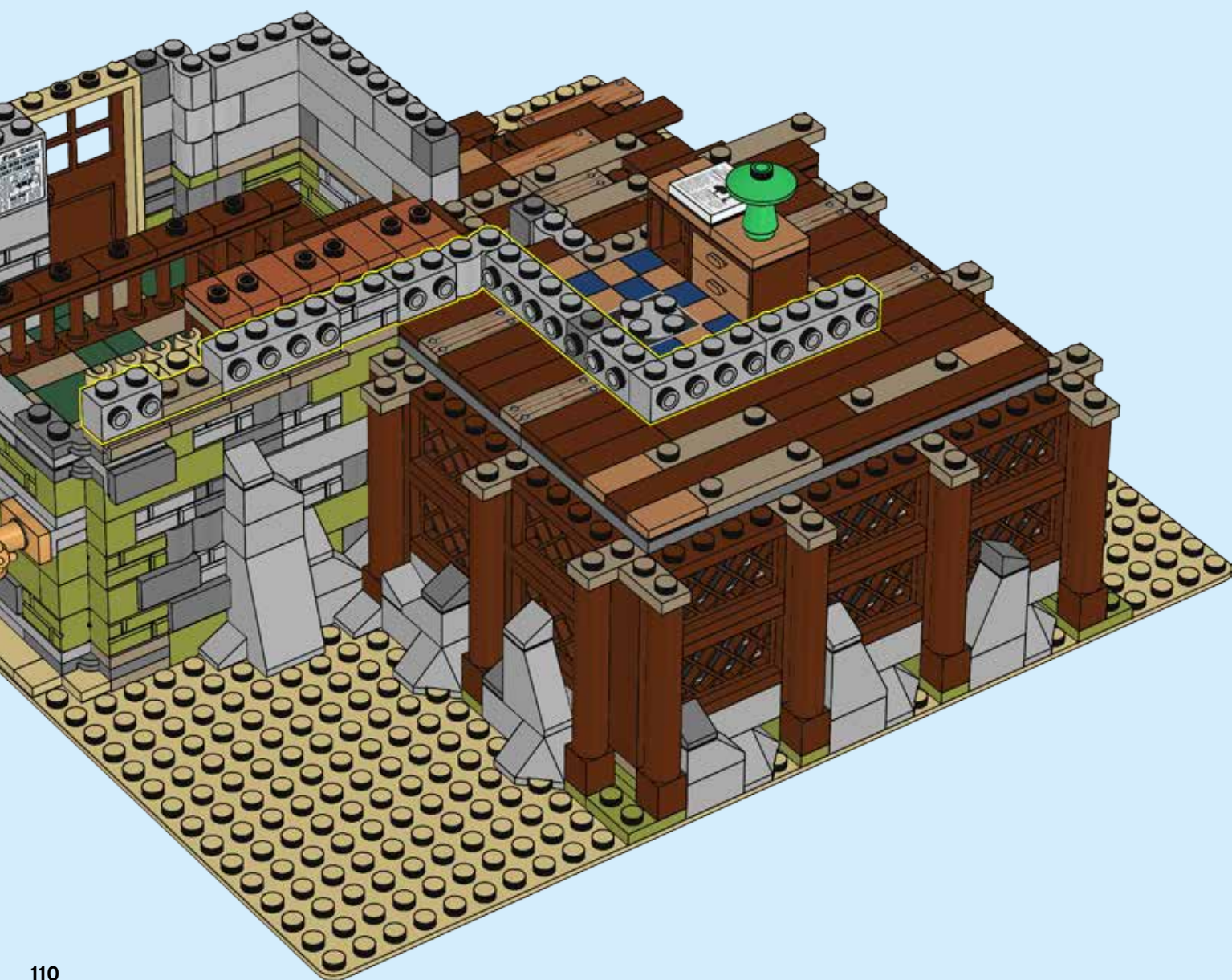

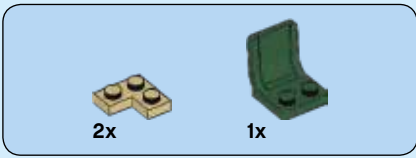

107

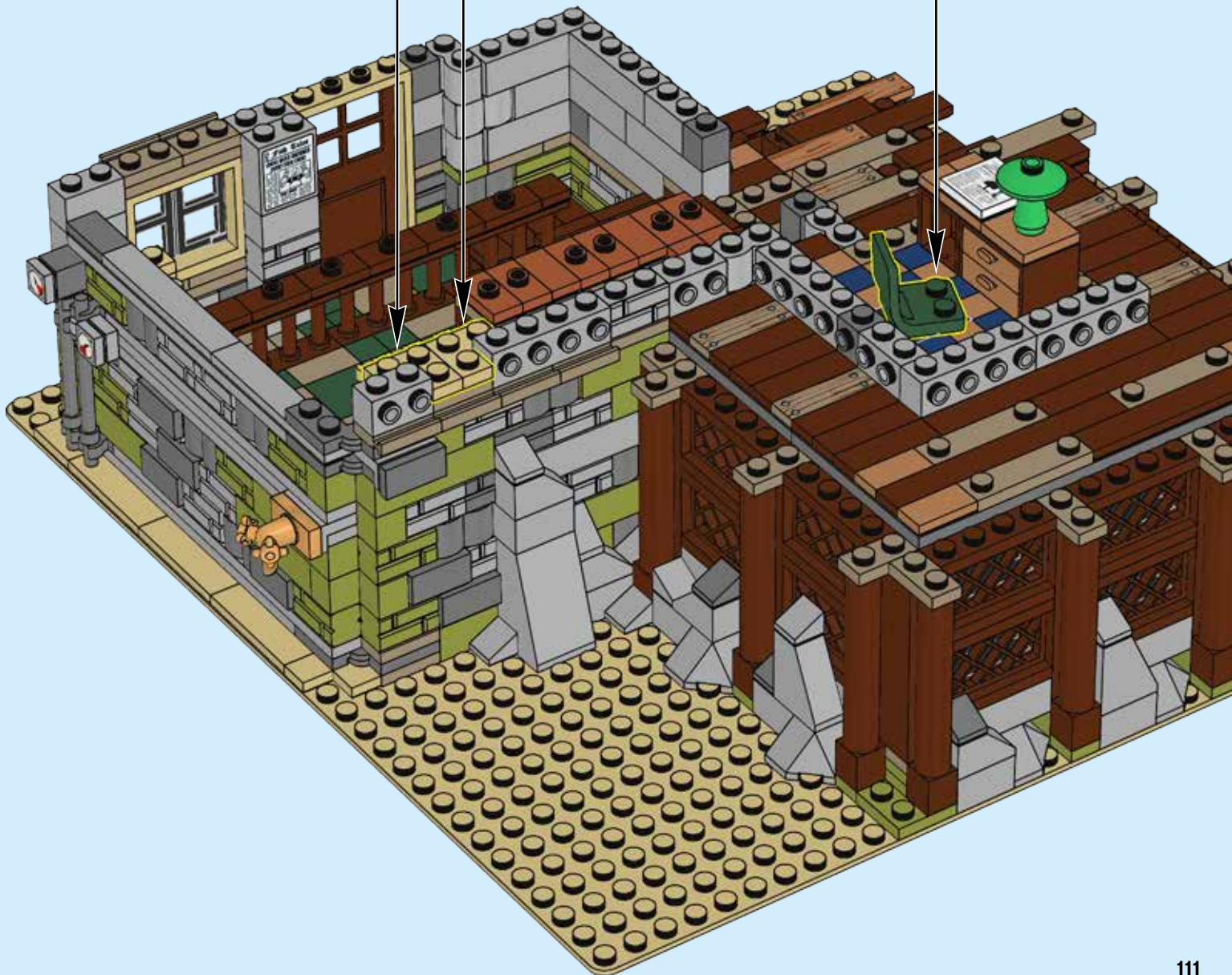
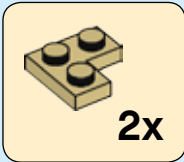

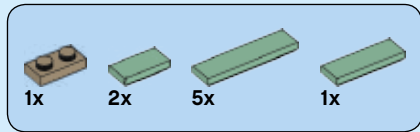

108

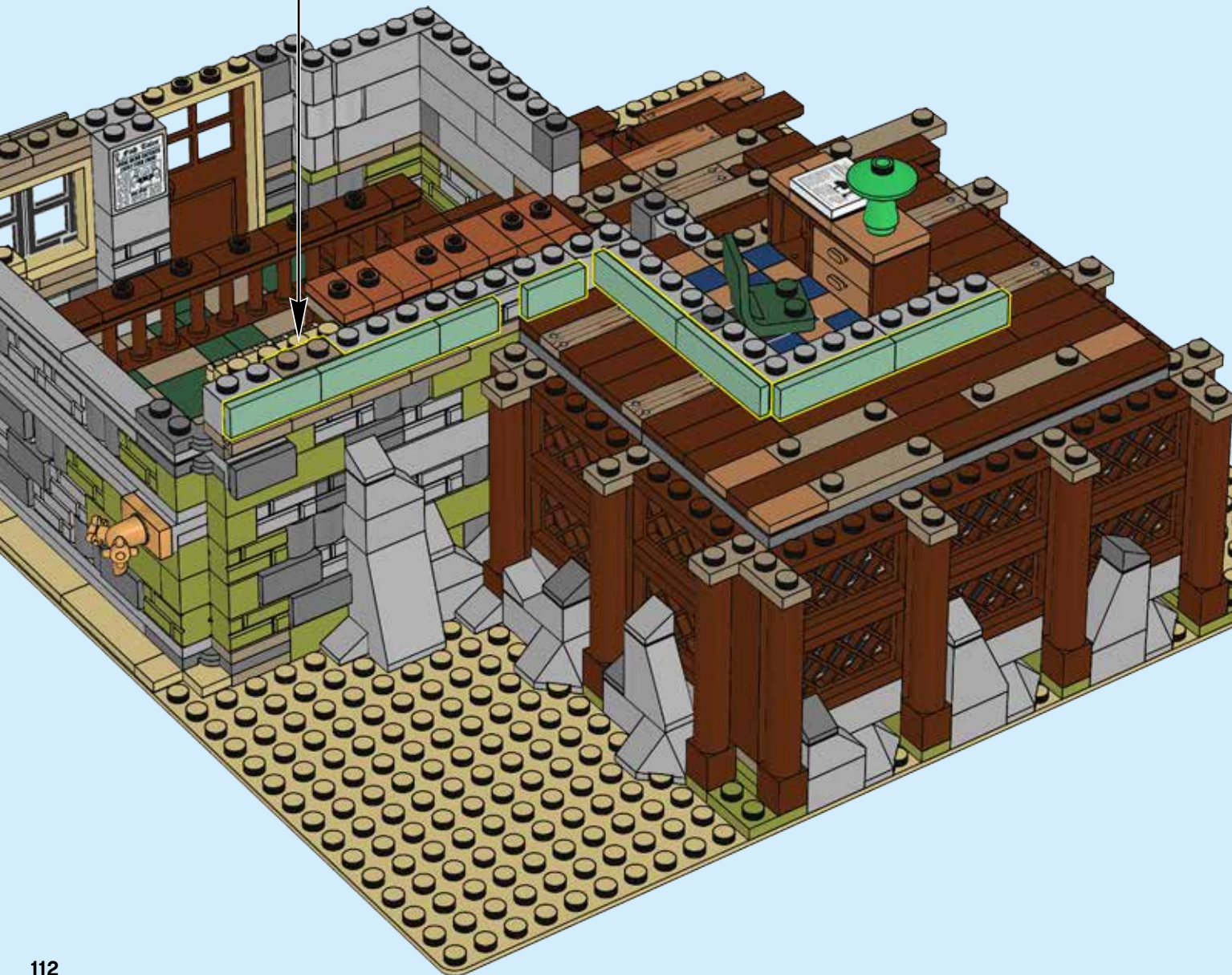

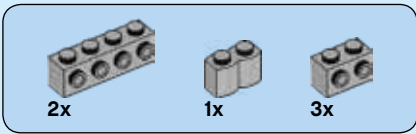

109

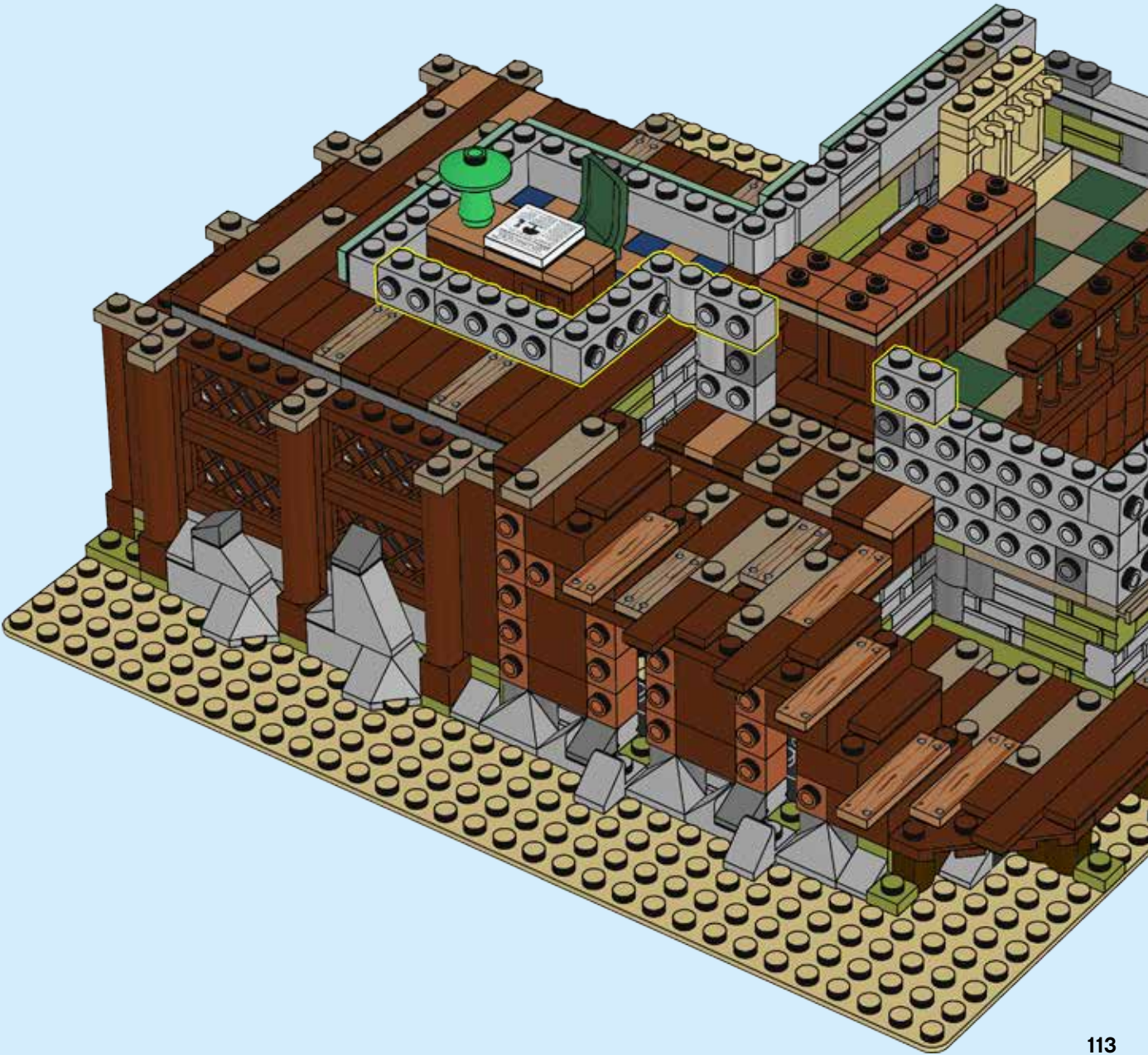
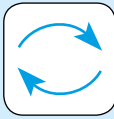

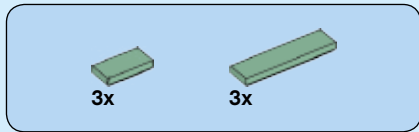

110



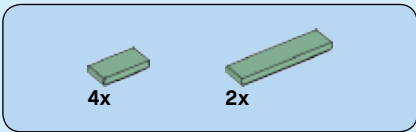

111



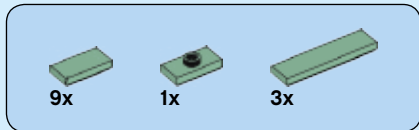

112



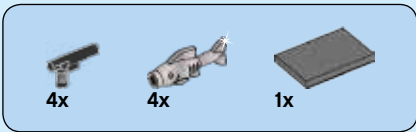

113

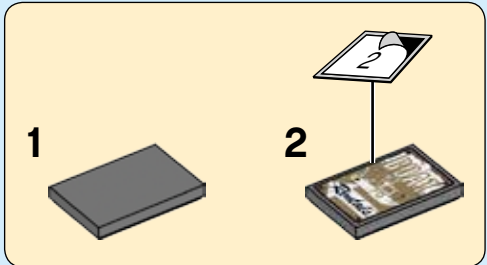
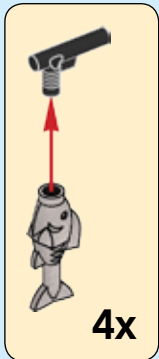

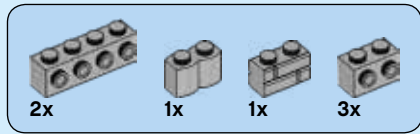

114

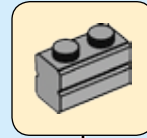

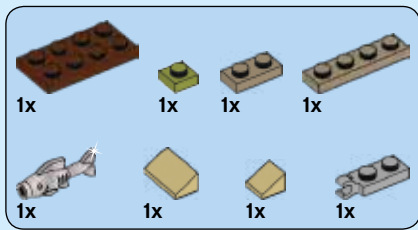

115

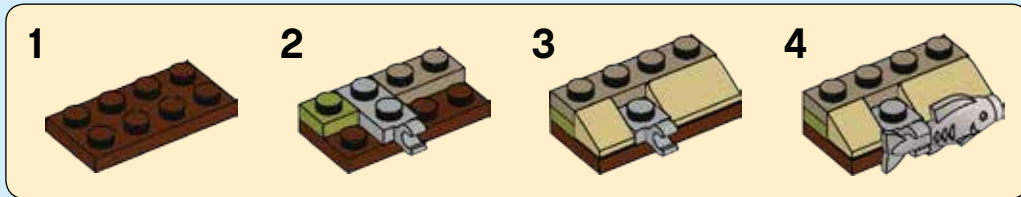

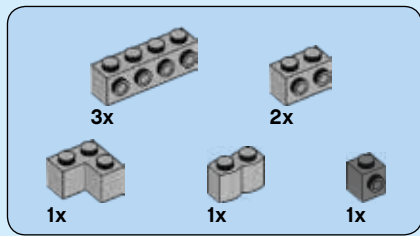

116





2x



1x



4x

117

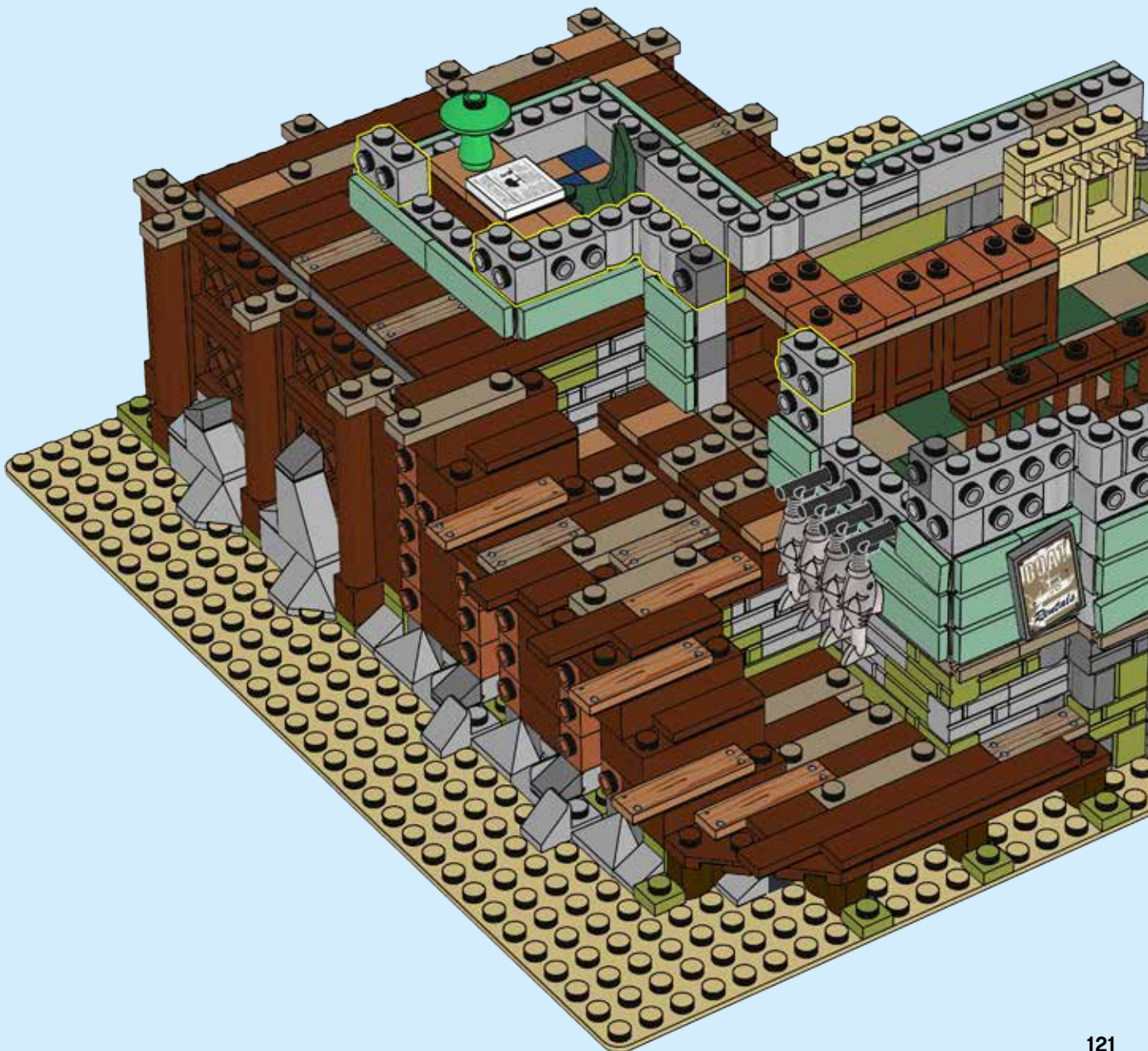

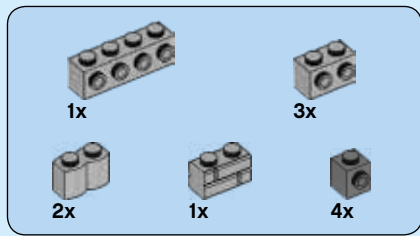

118

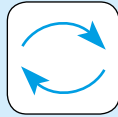

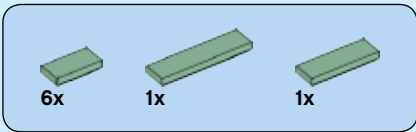

119

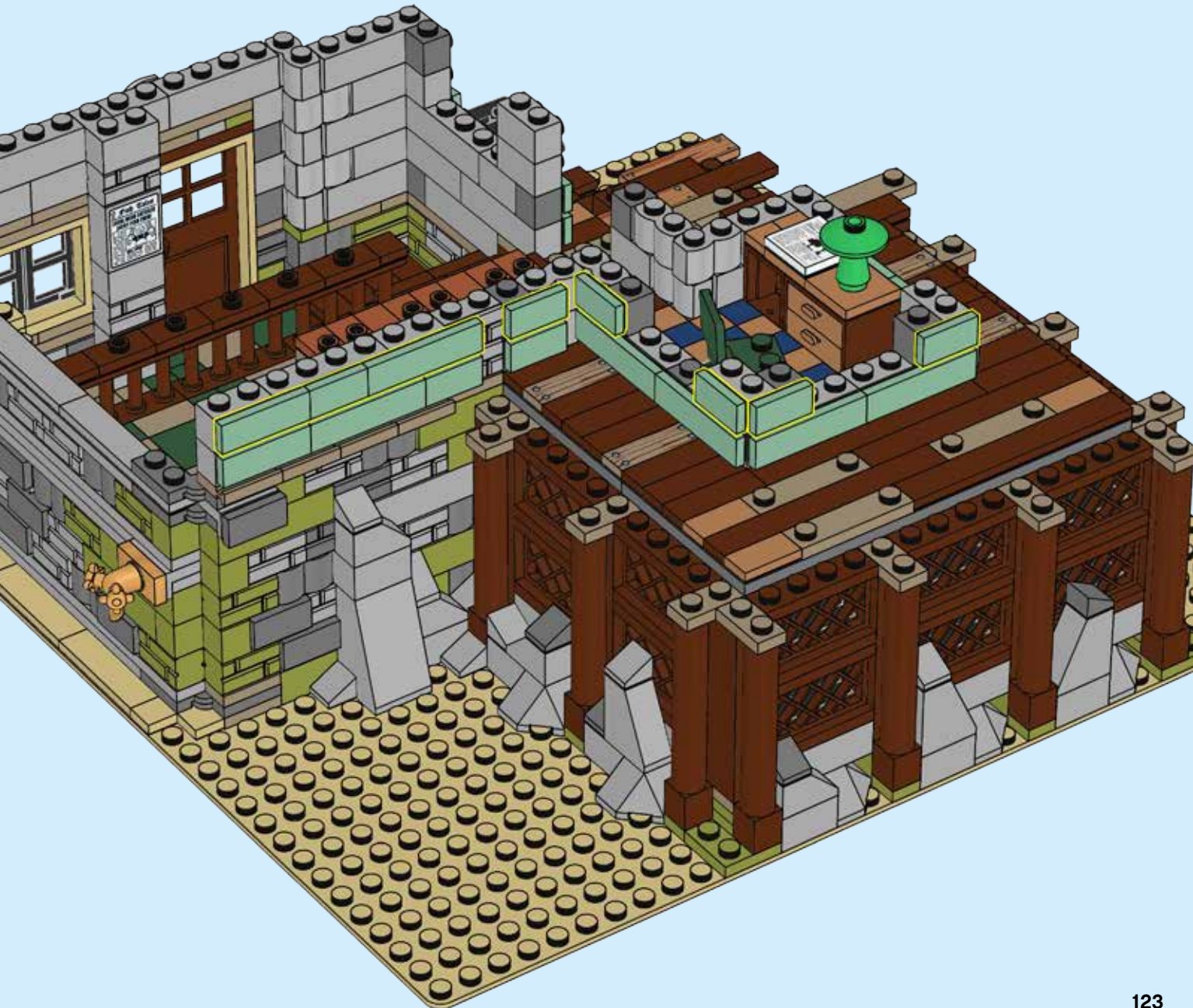

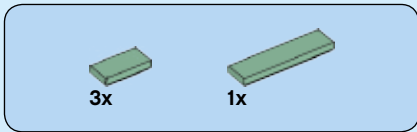

120

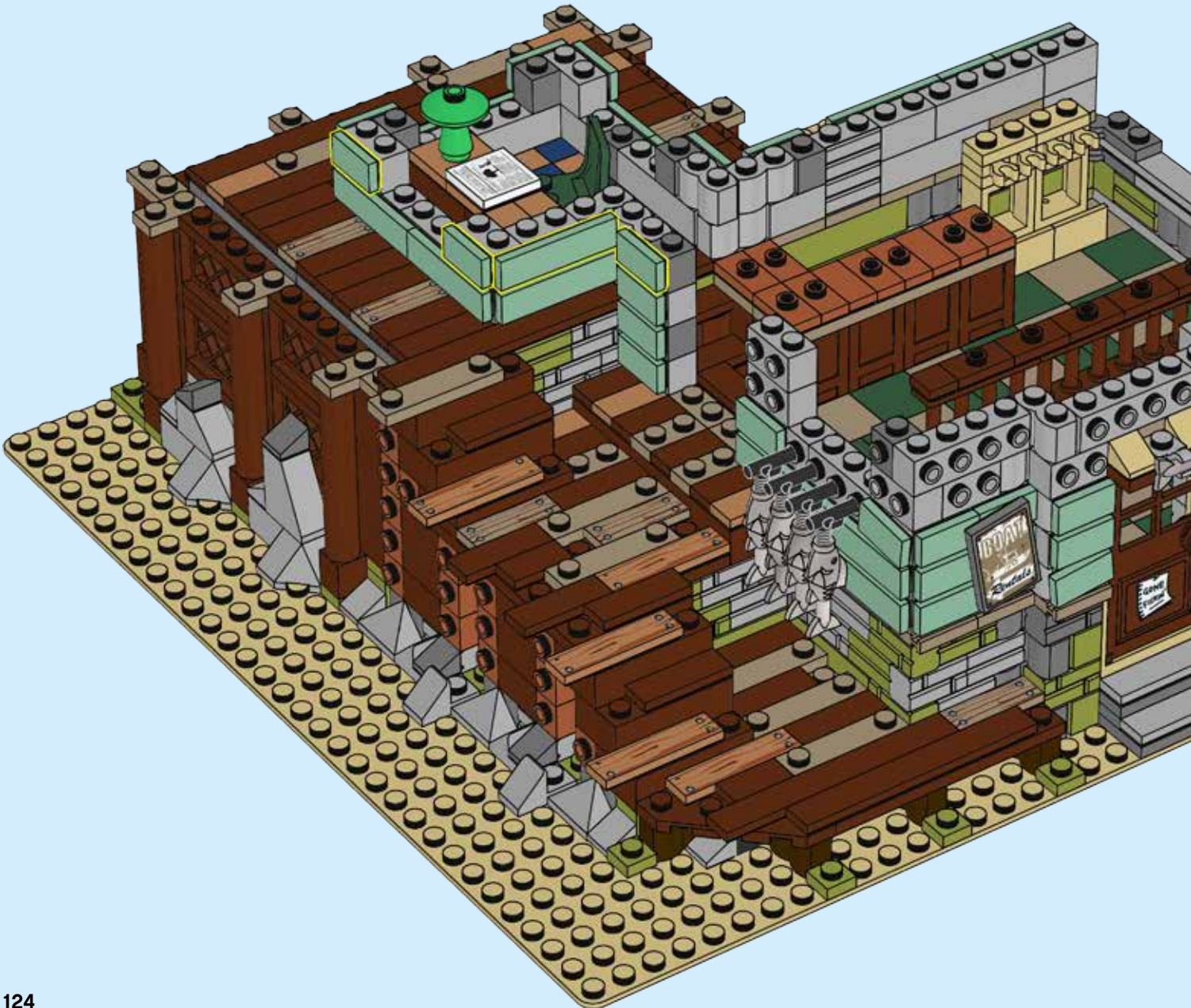
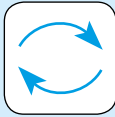

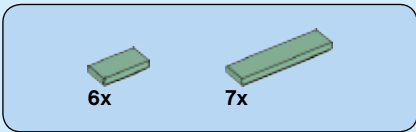

121



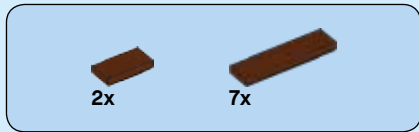

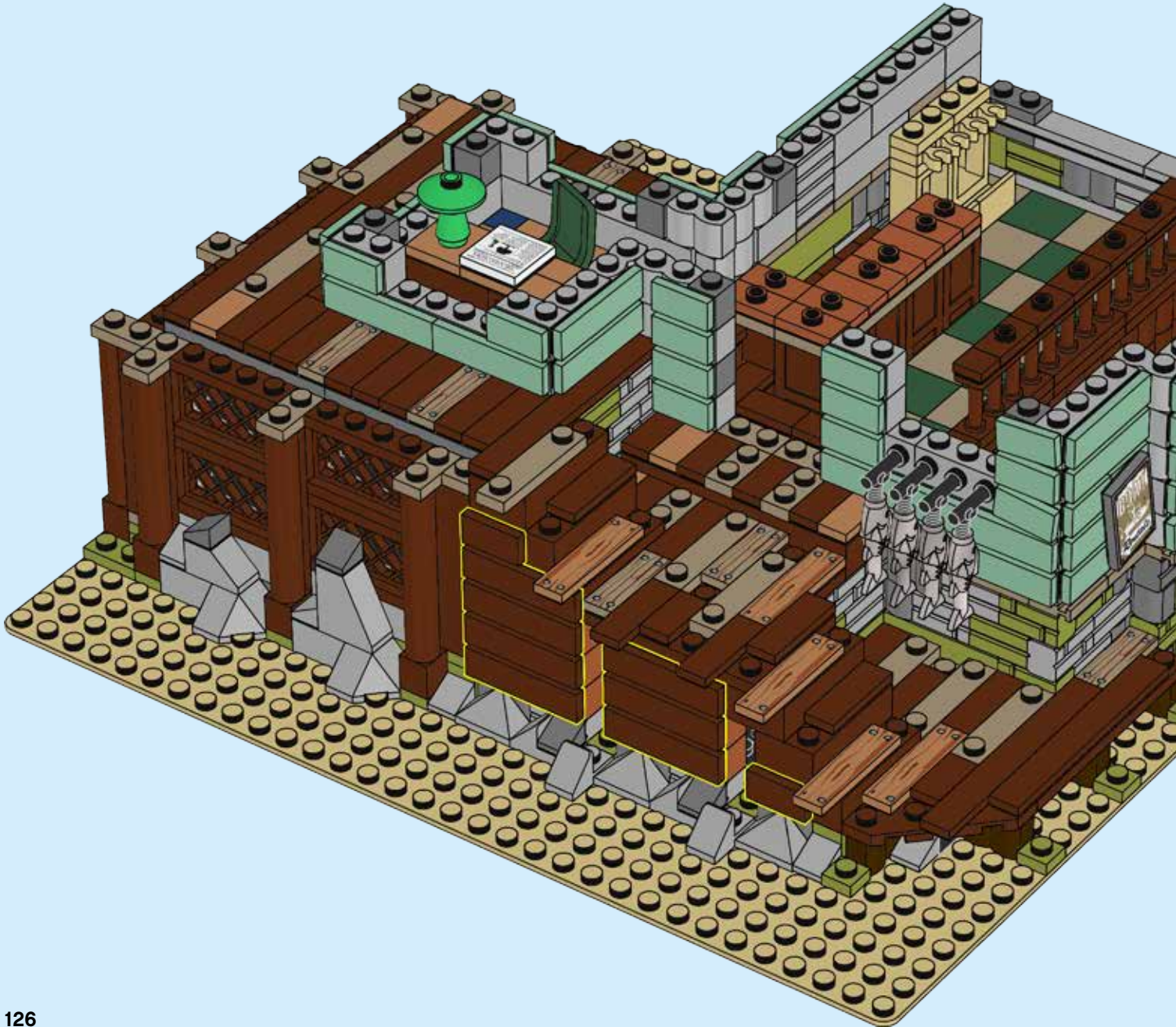

122

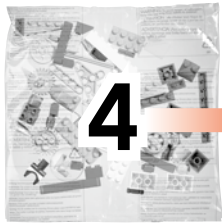



4





		
4x	1x	3x

123

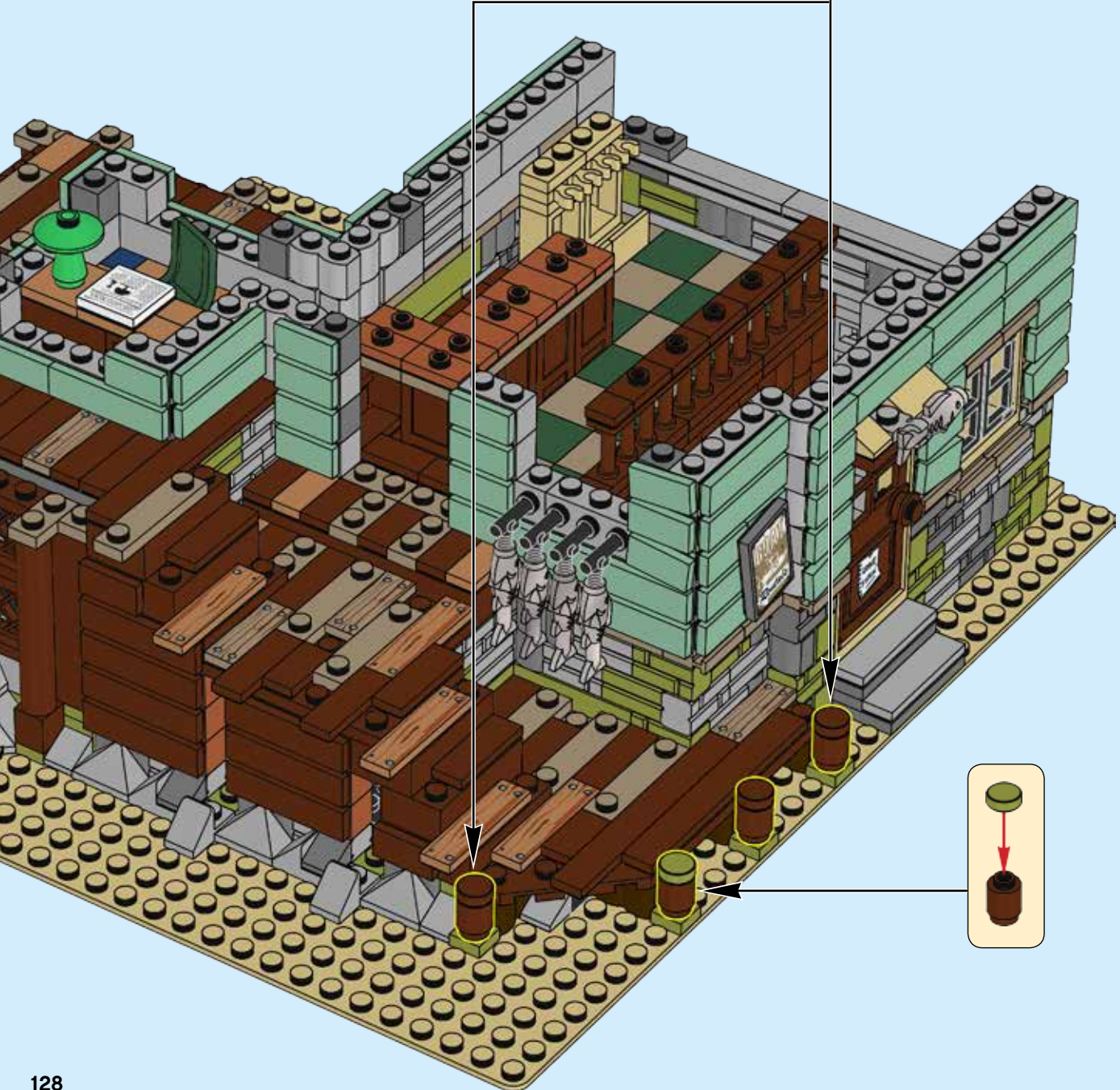

3x

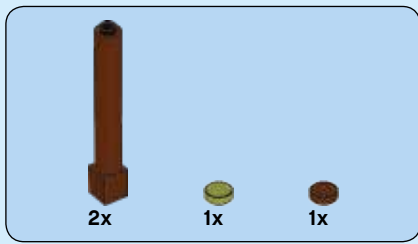

124



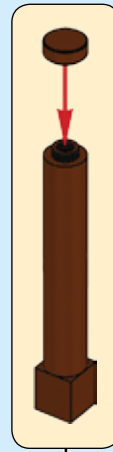
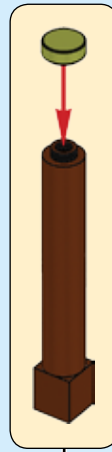

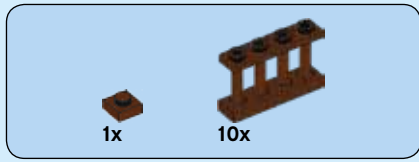
125

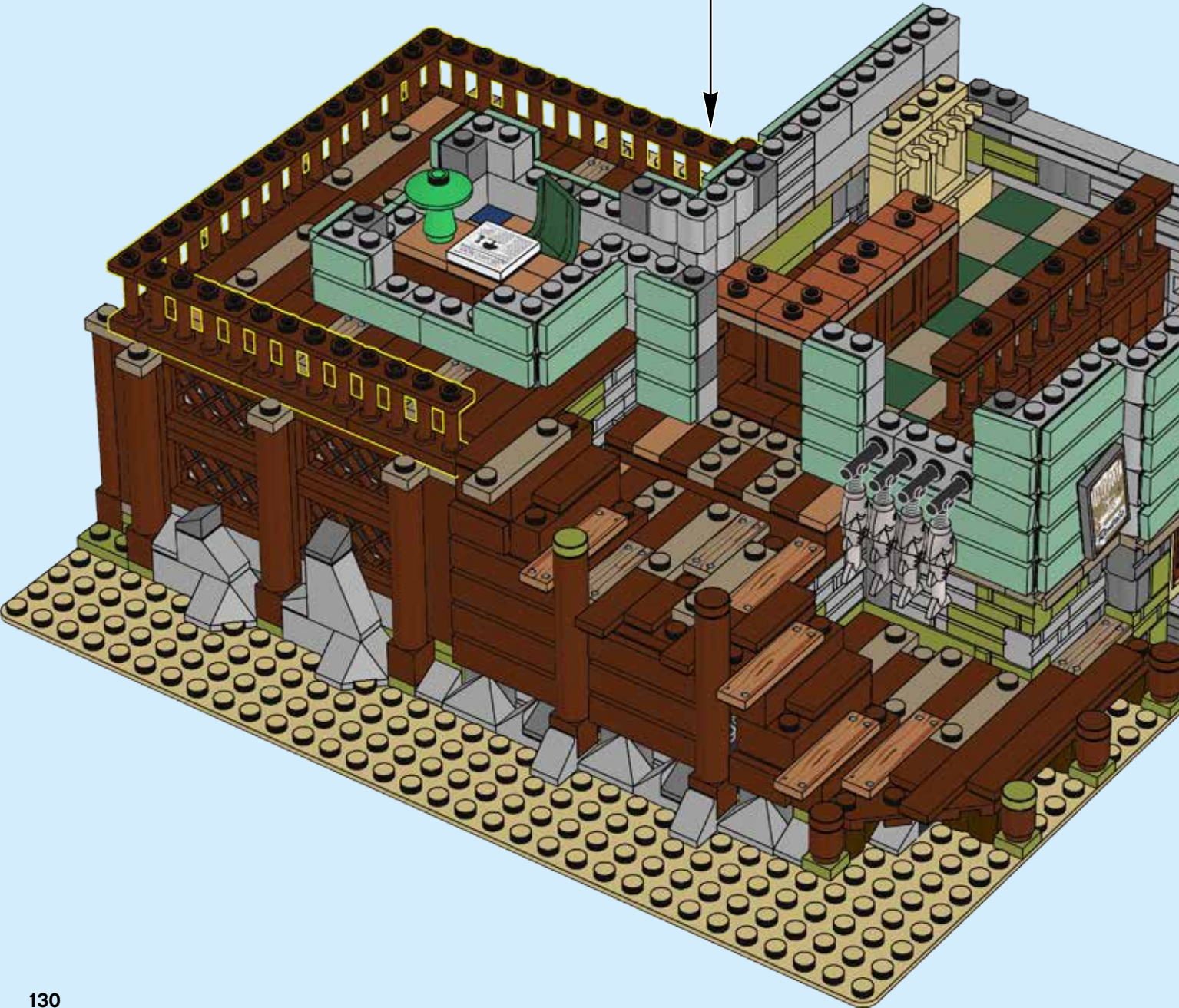
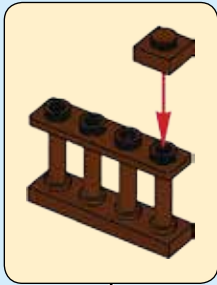



126

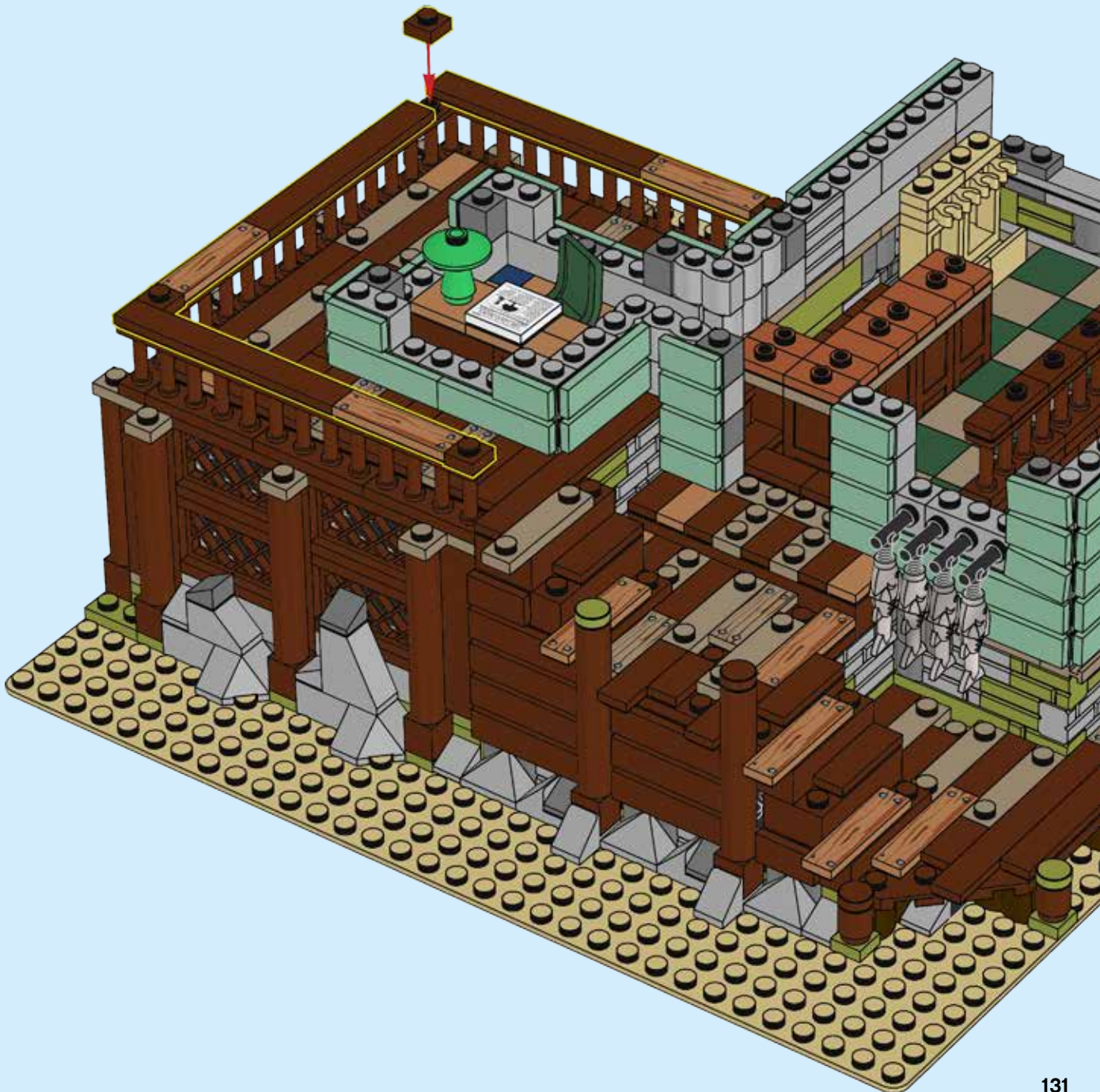

- 4x
- 1x
- 3x

127

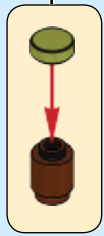
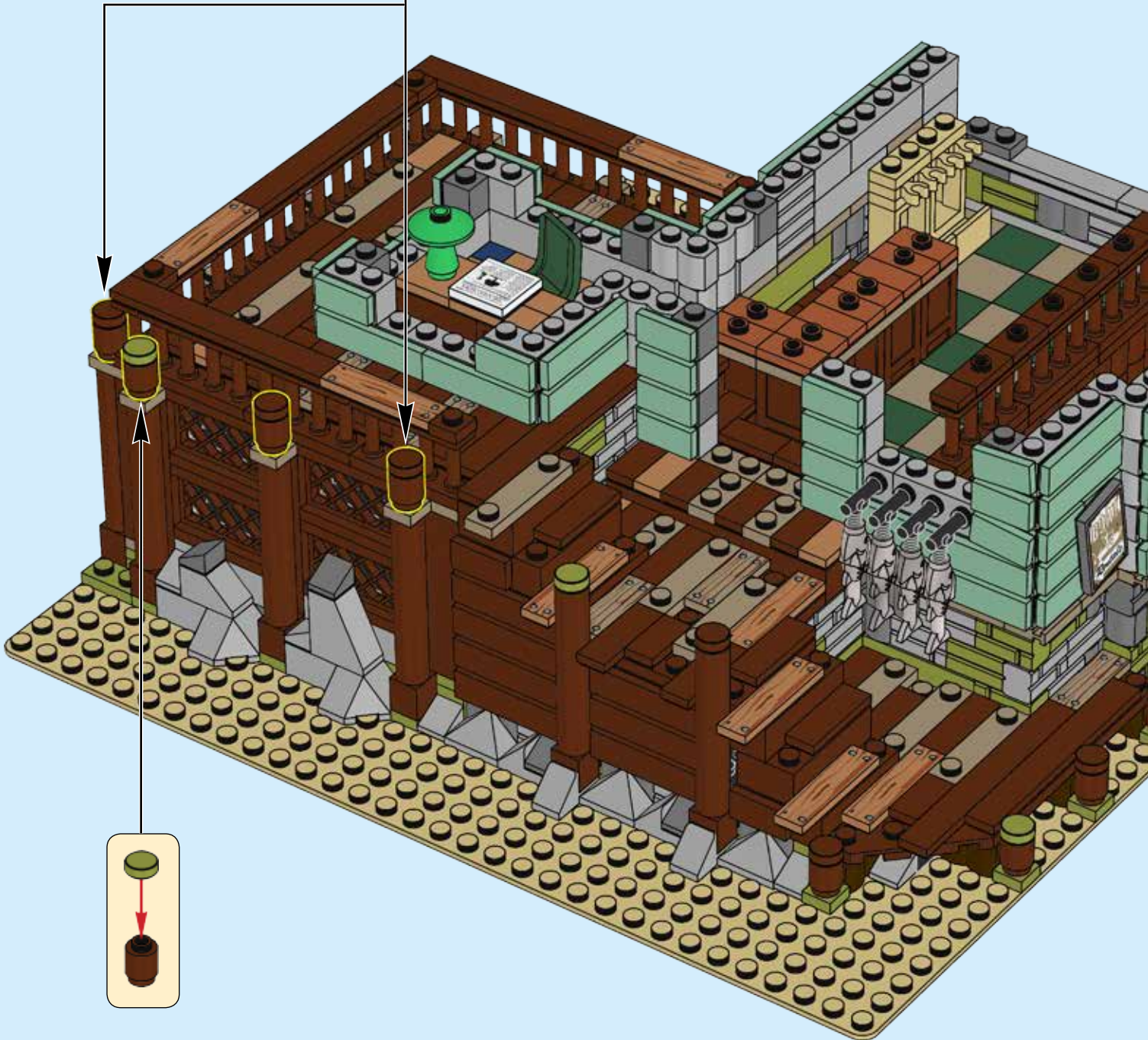
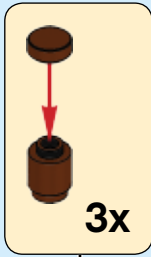

6x 2x 4x

128

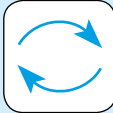

4x

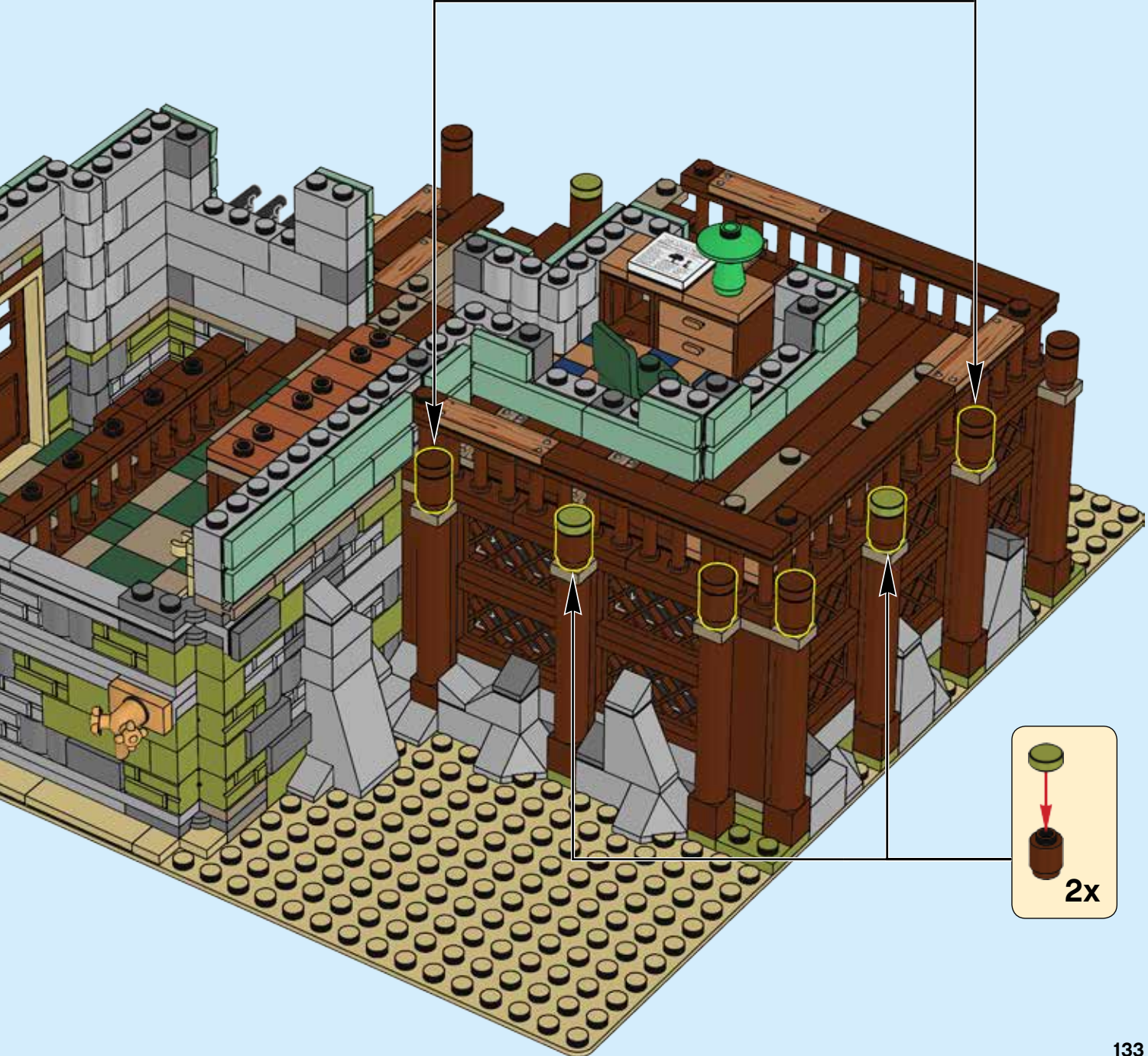

2x

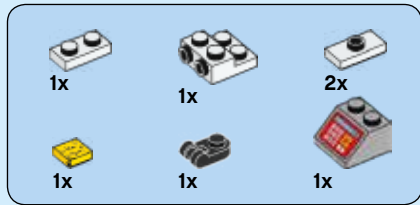

129

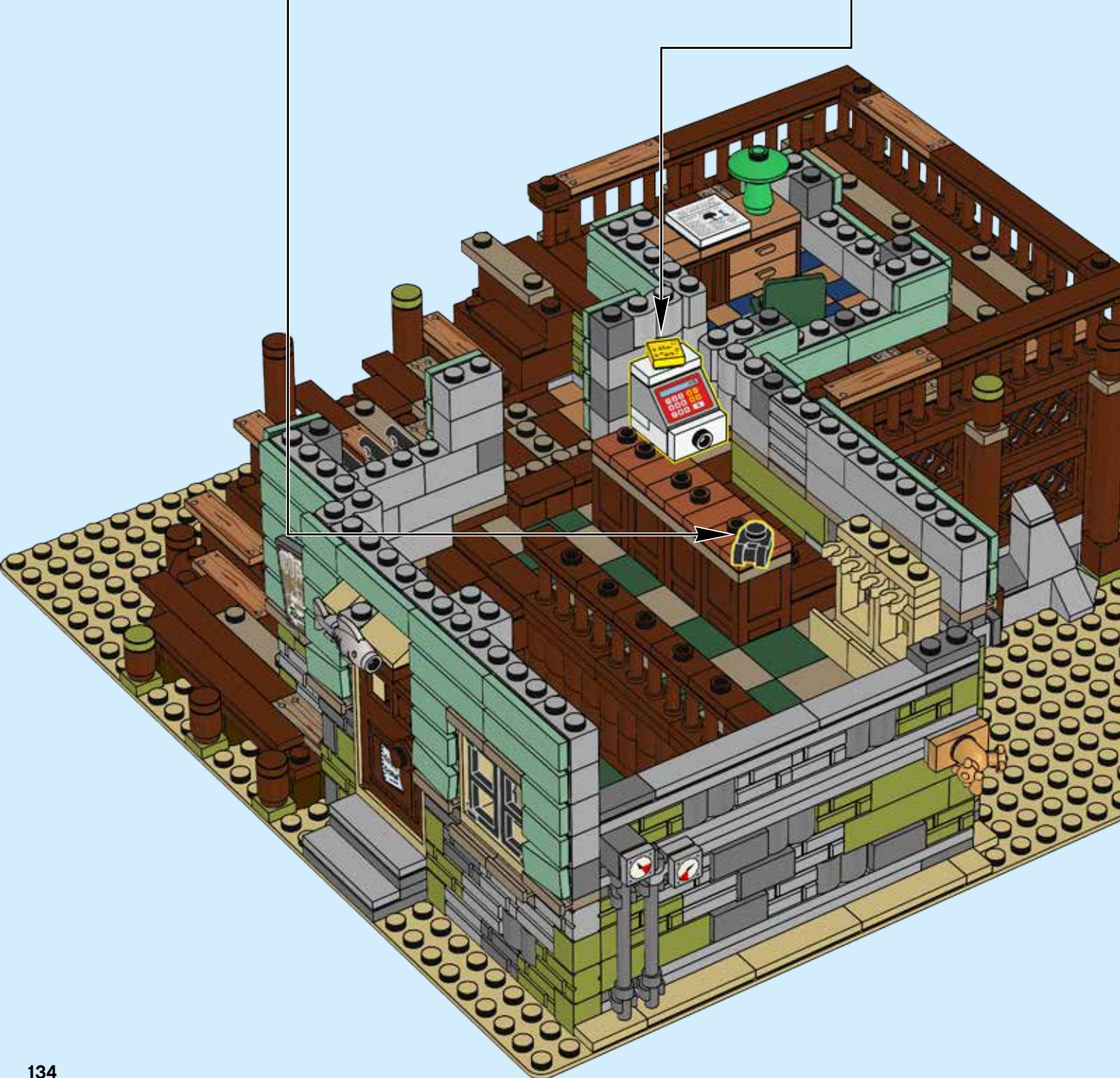
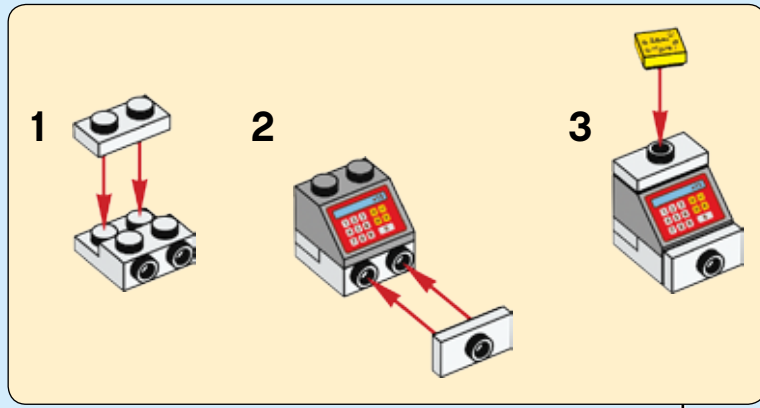
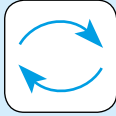

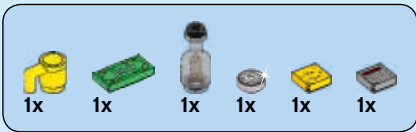

130





131

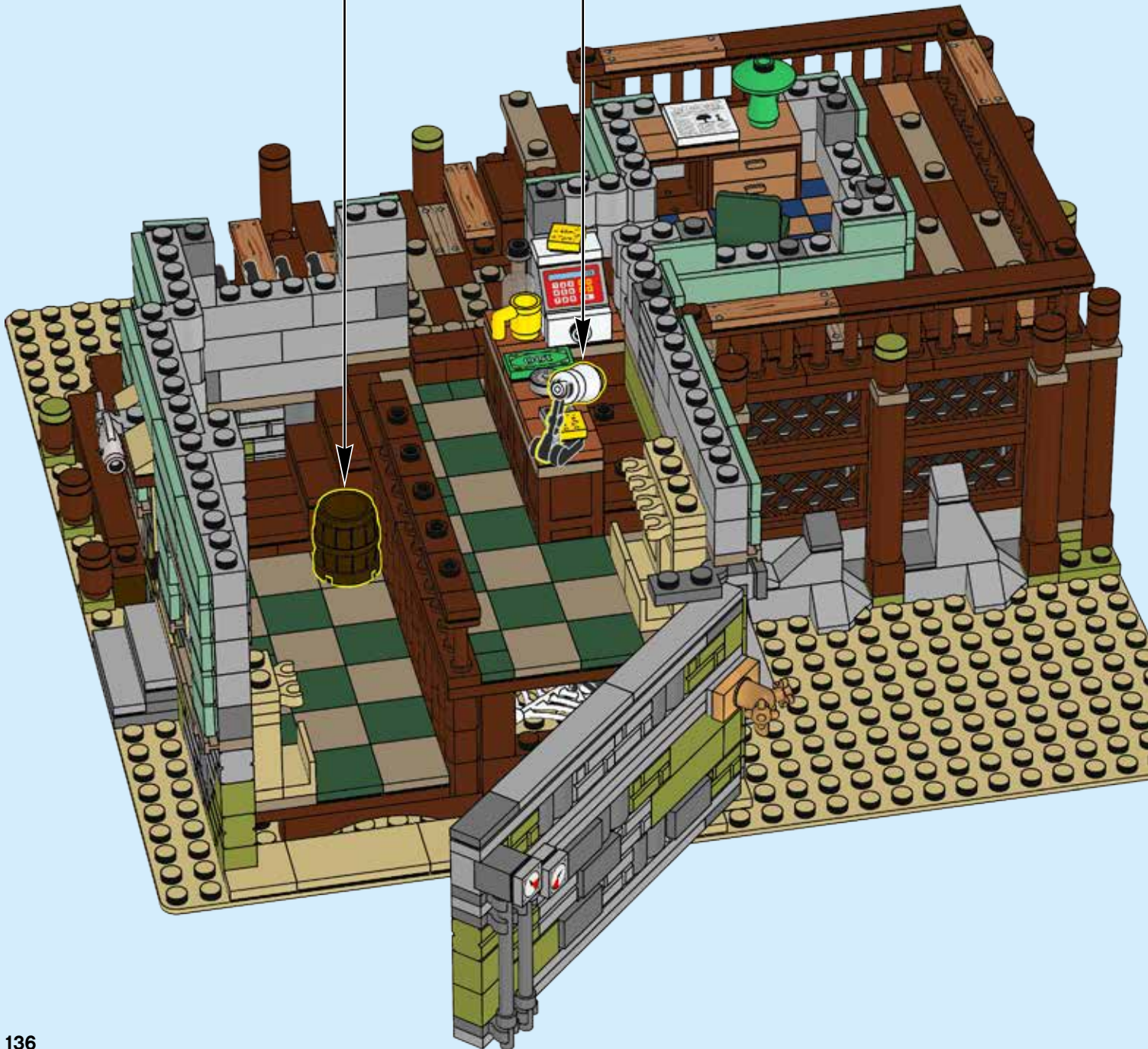
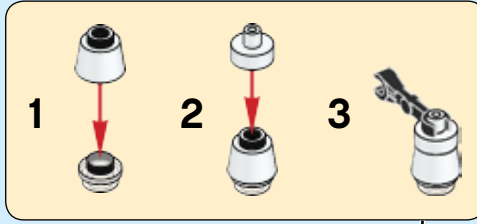

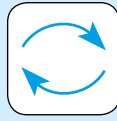
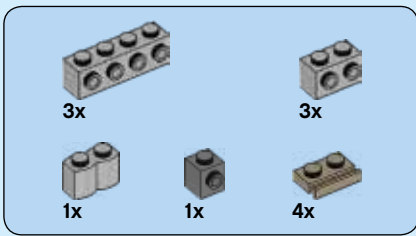

132

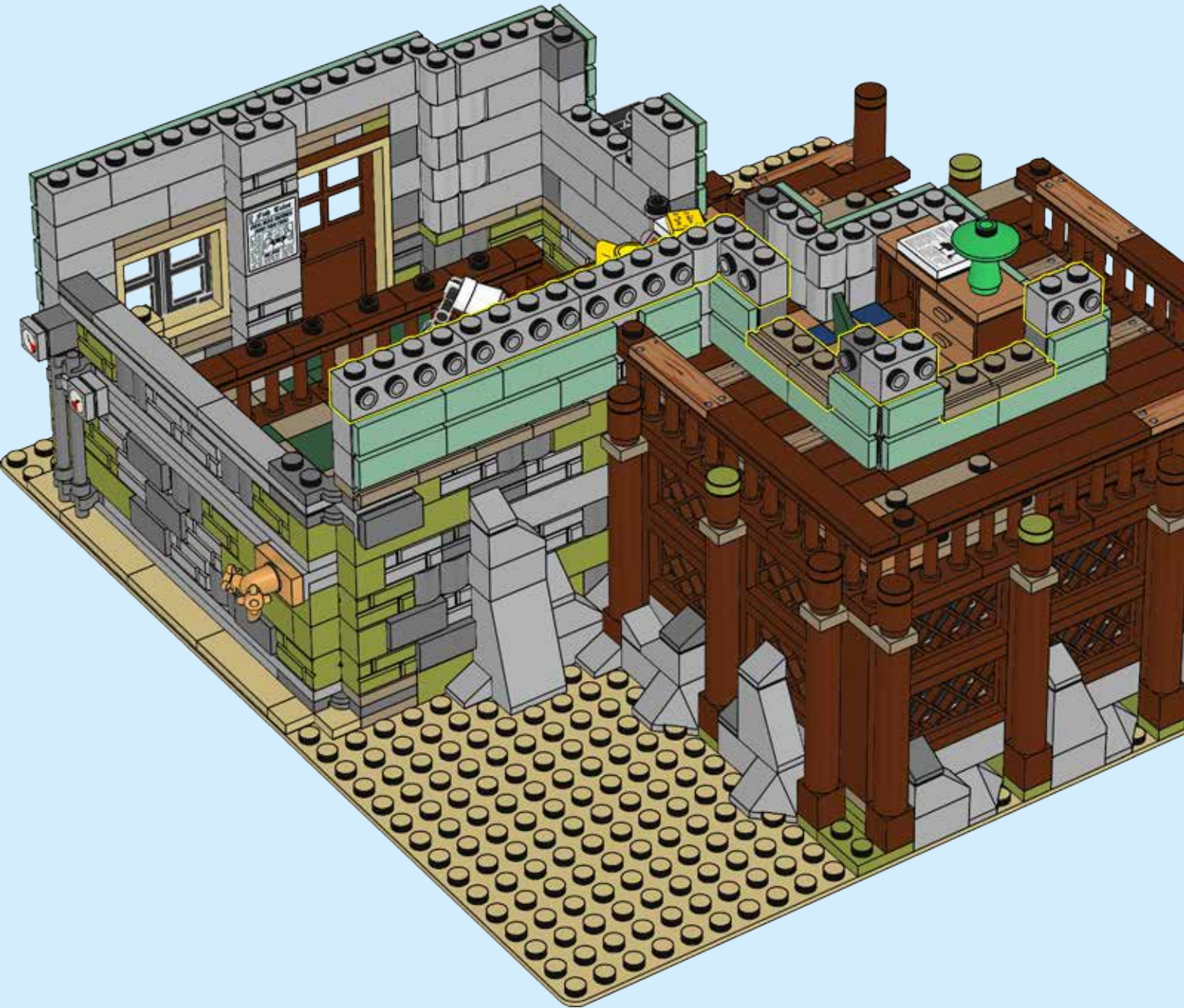

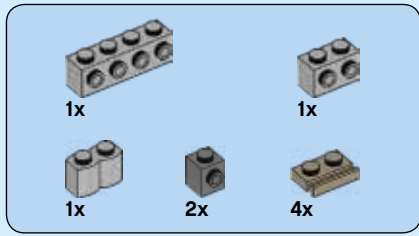

133

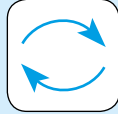

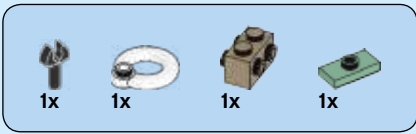

134

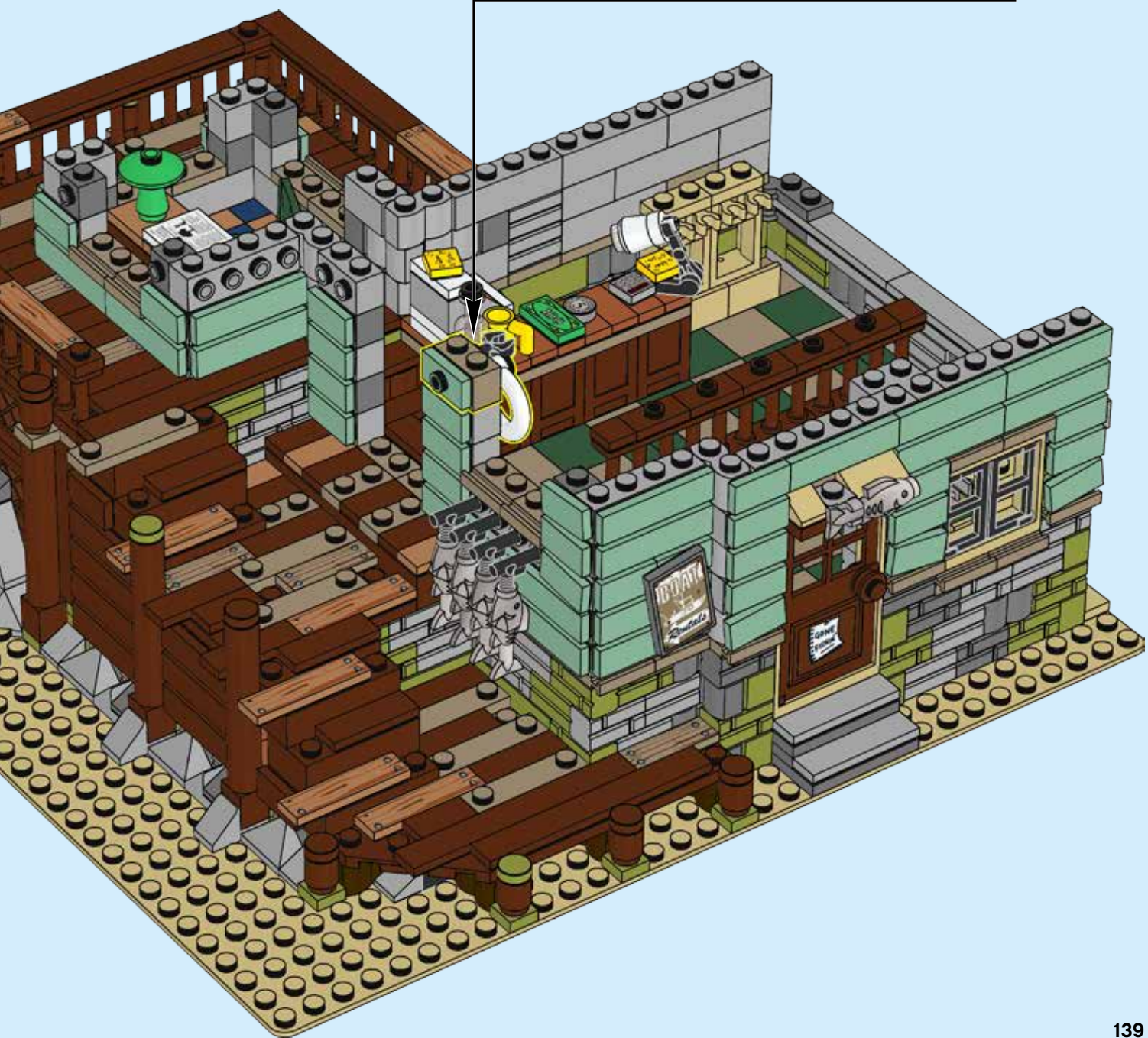
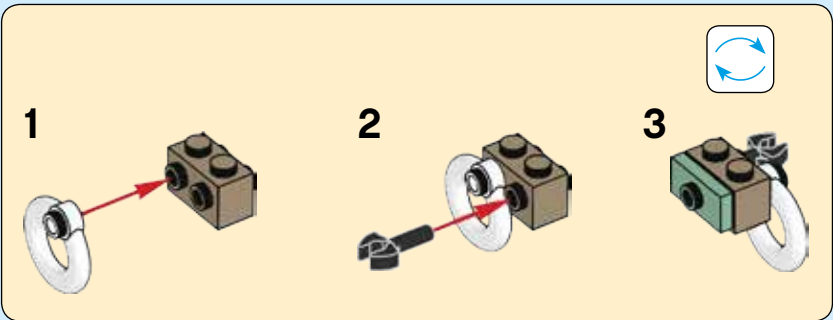

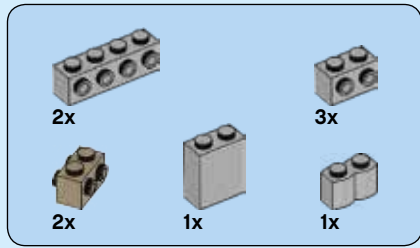

135

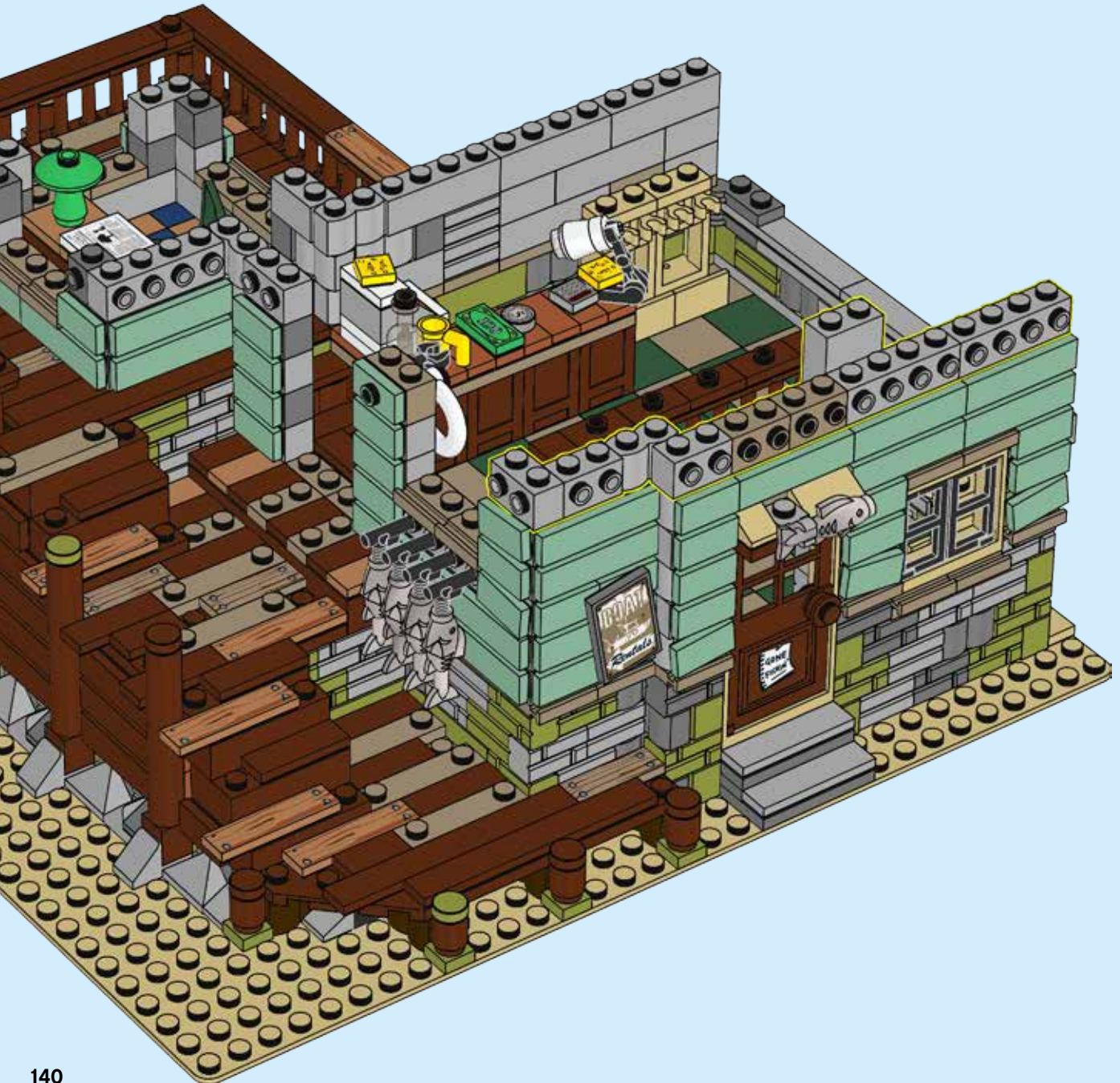

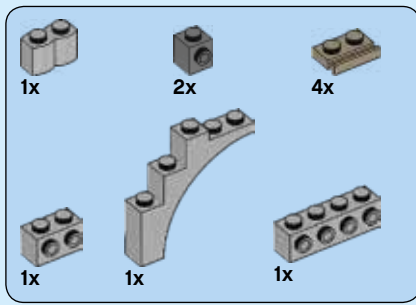

136

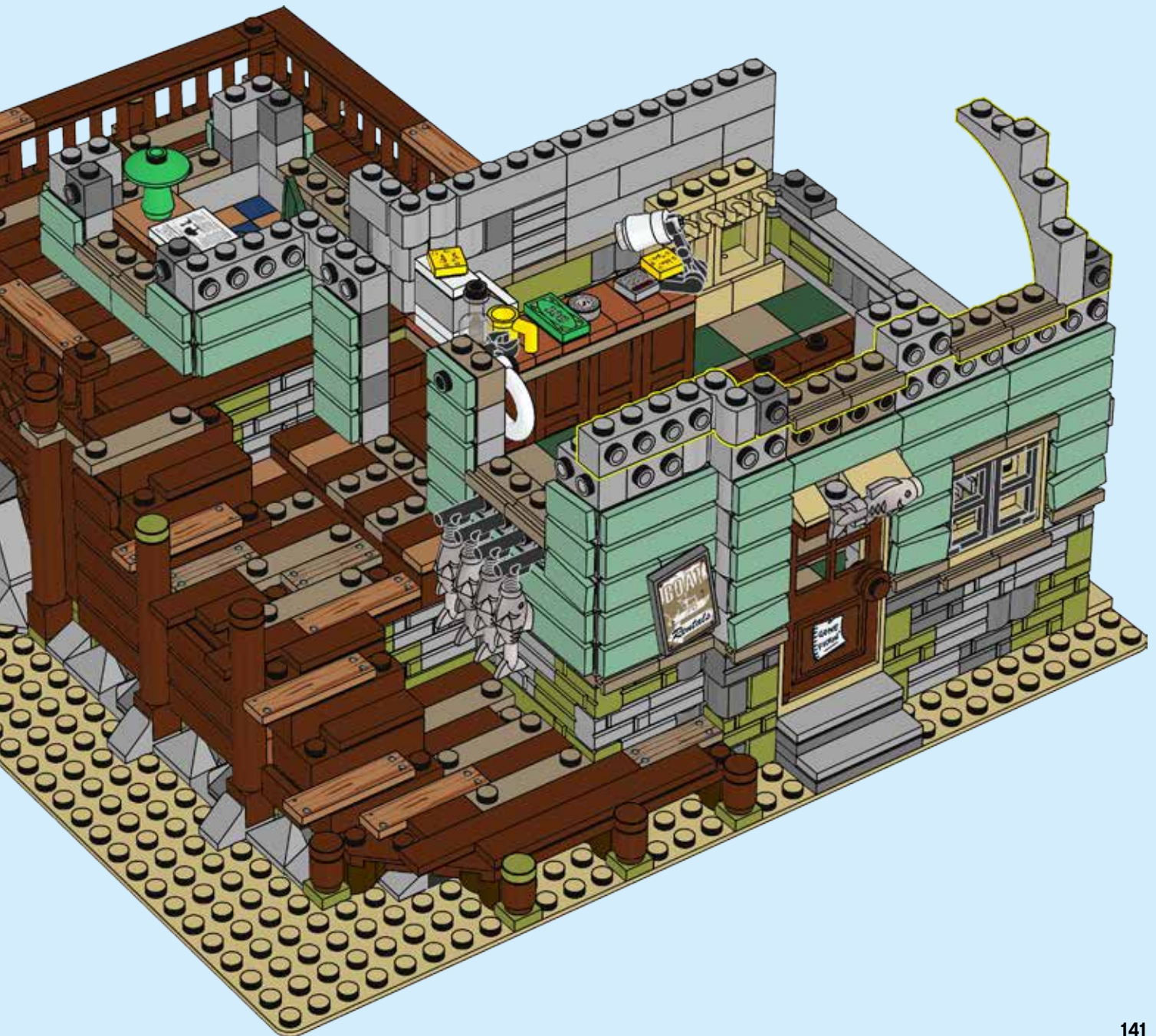



137

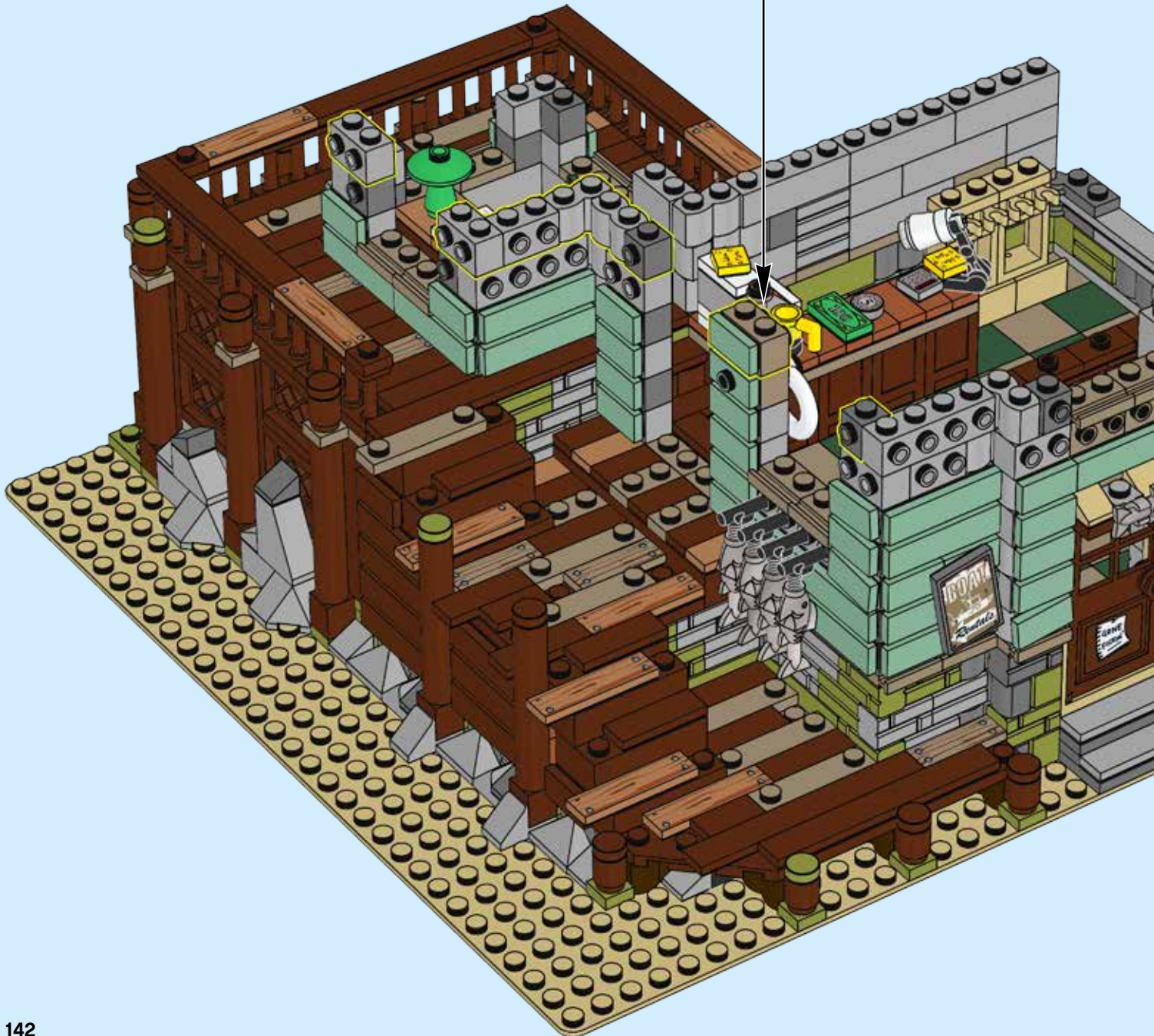
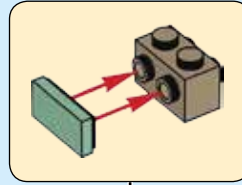

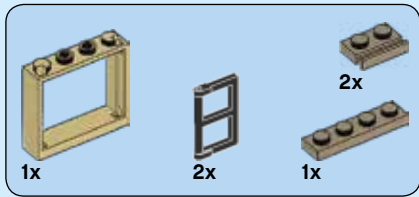

138

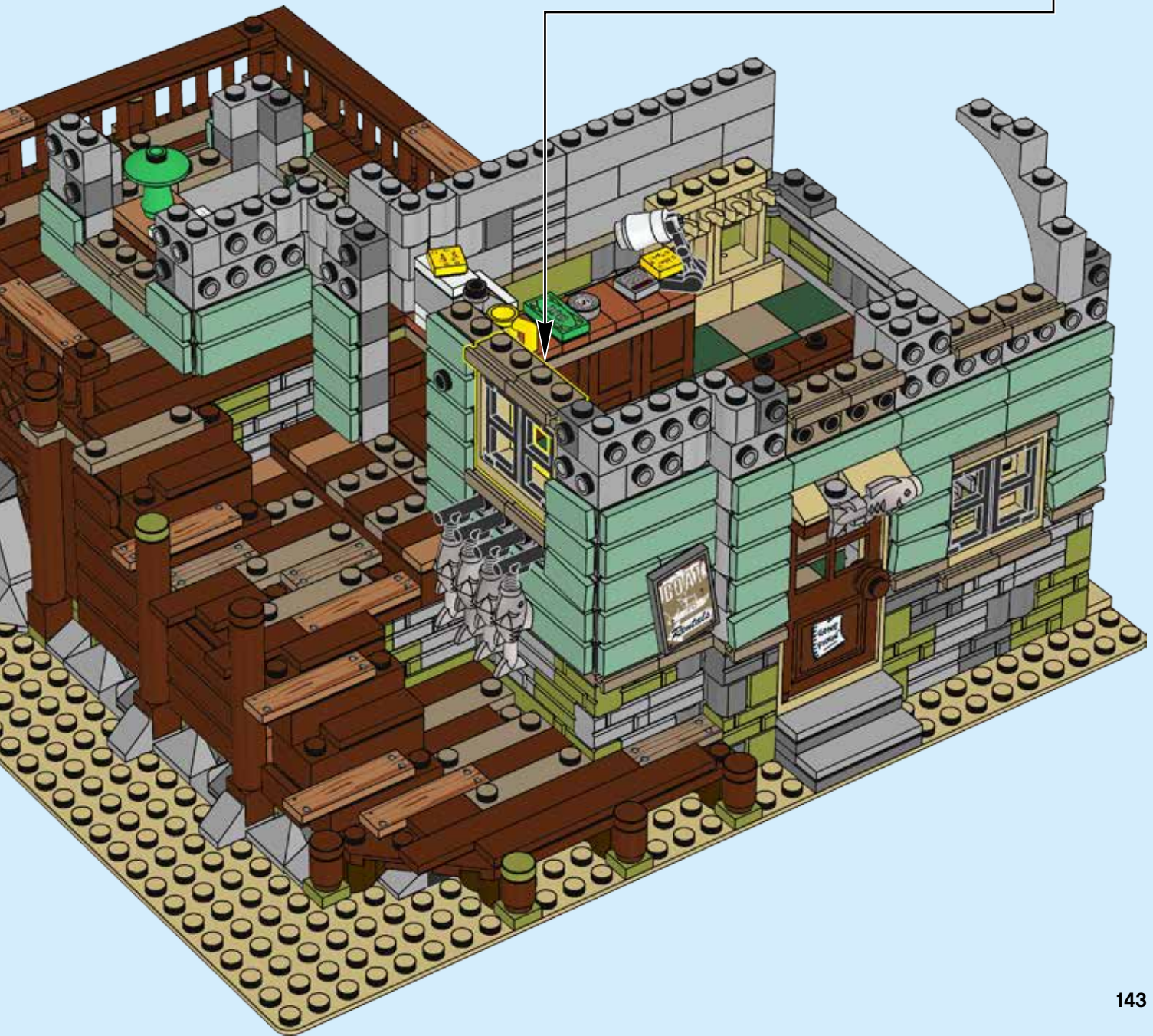
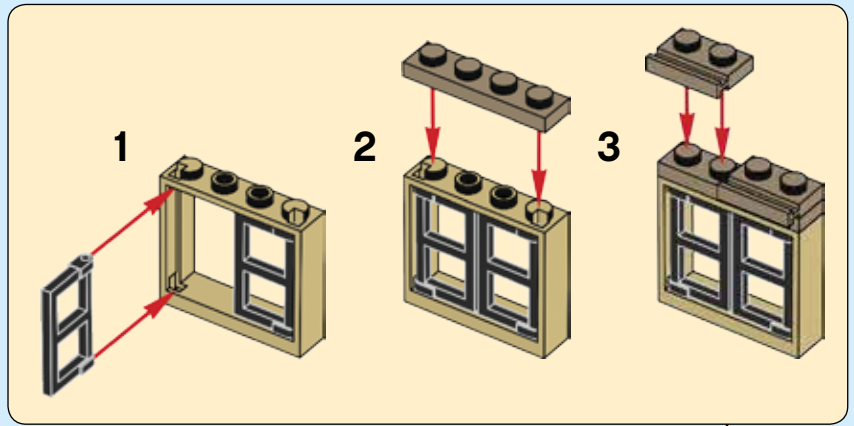

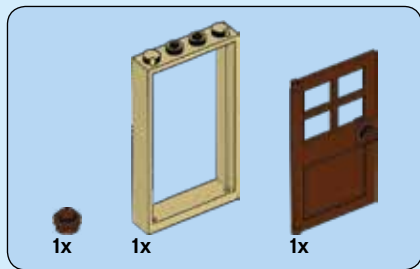

139

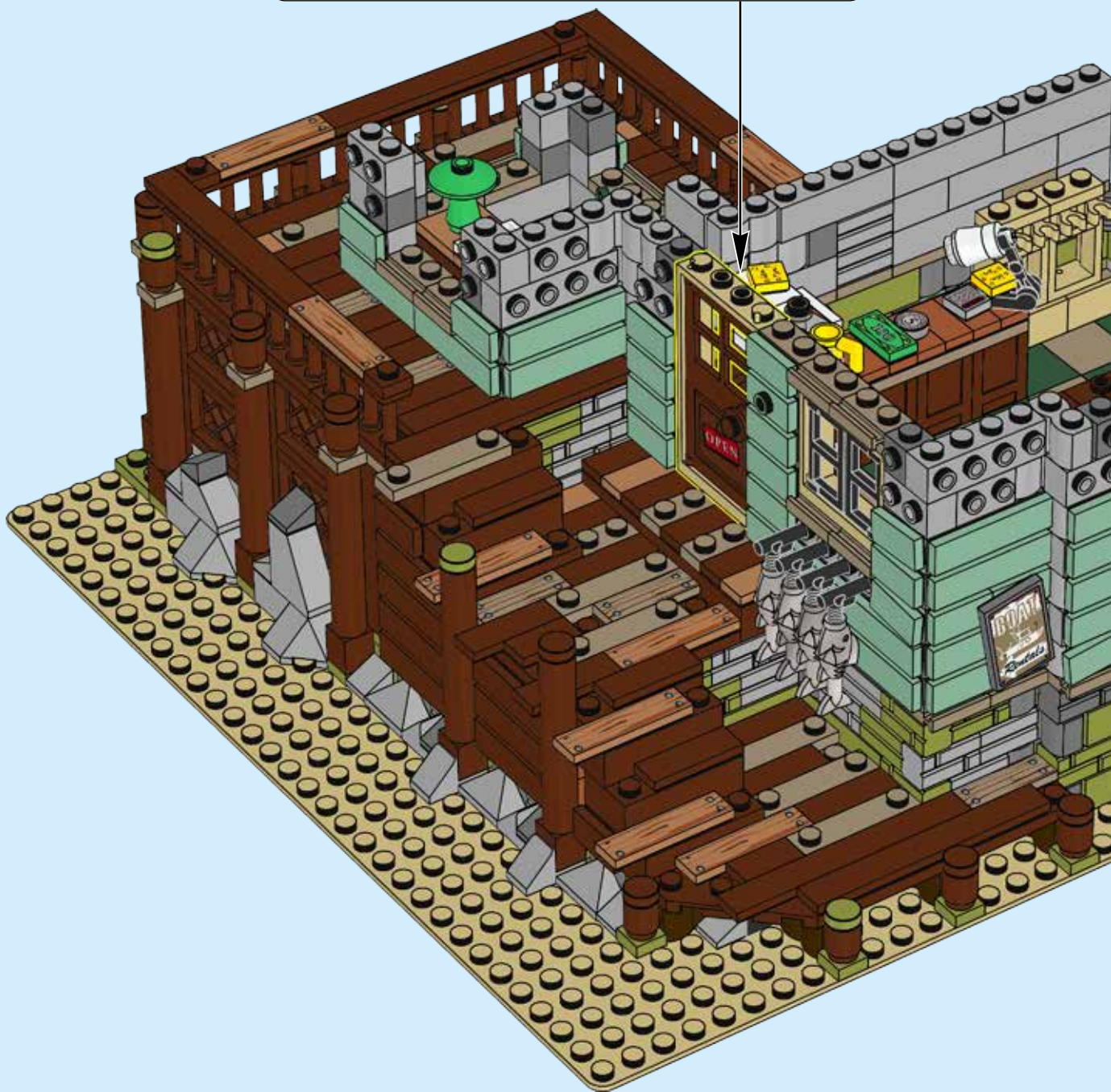
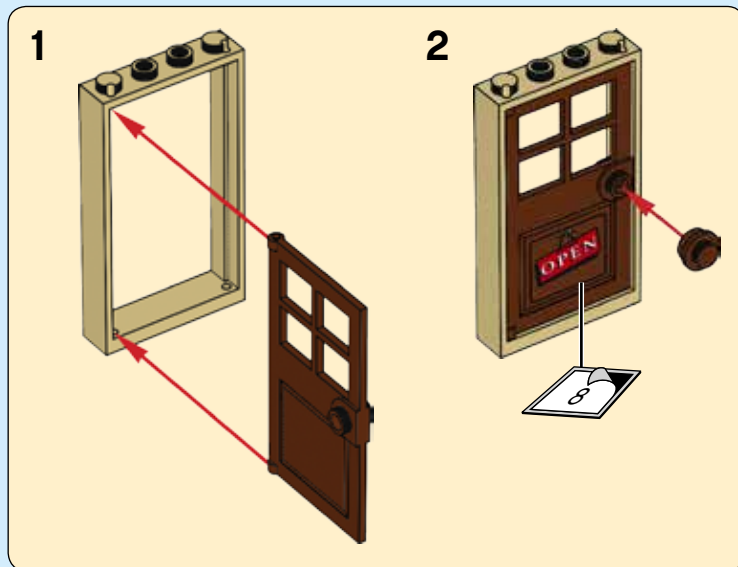

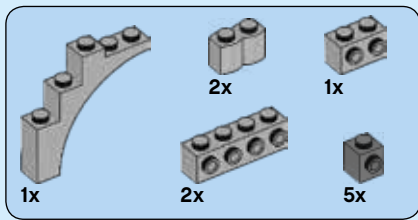

140

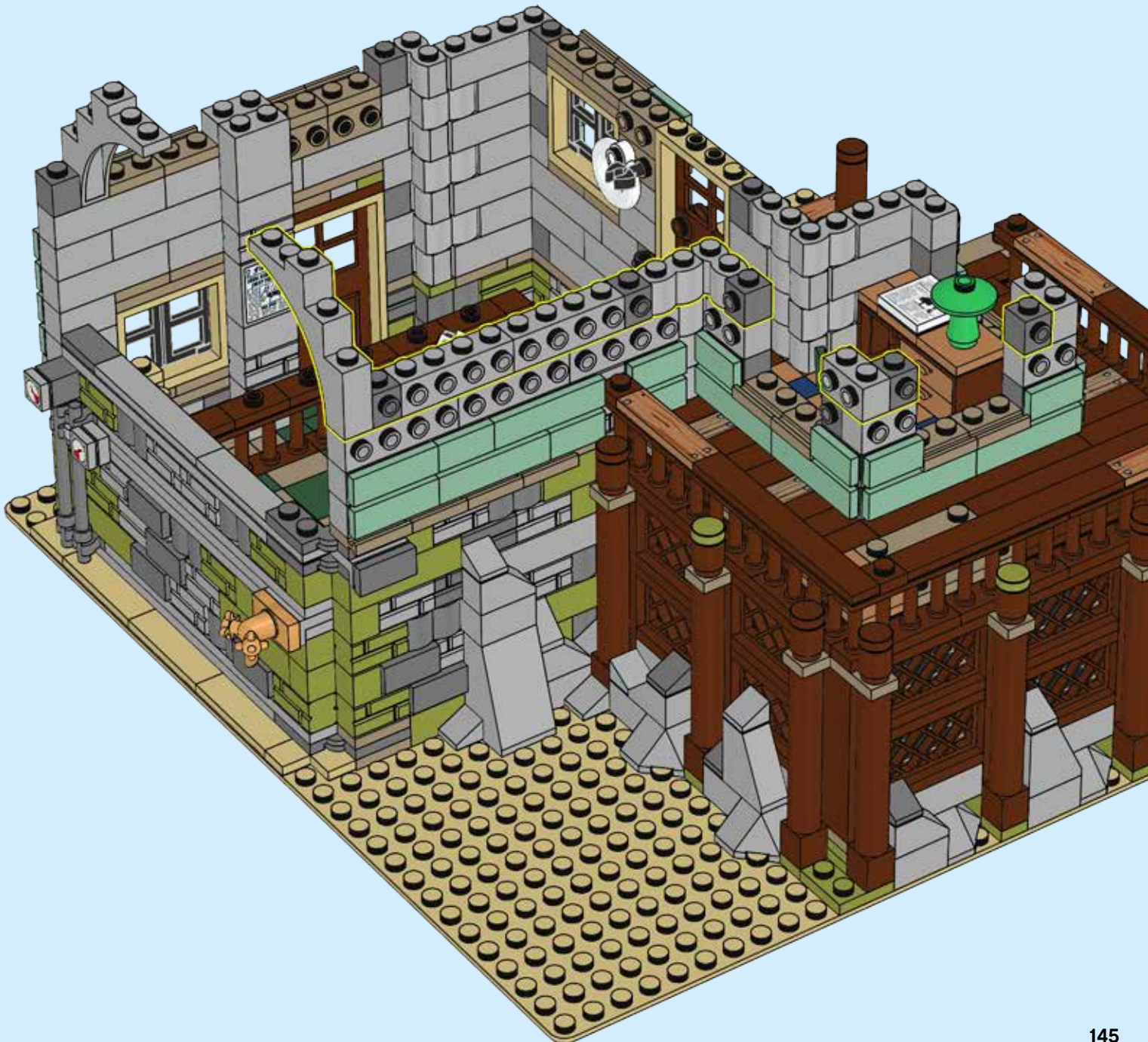
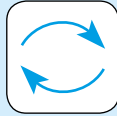

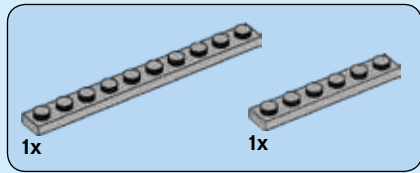

141

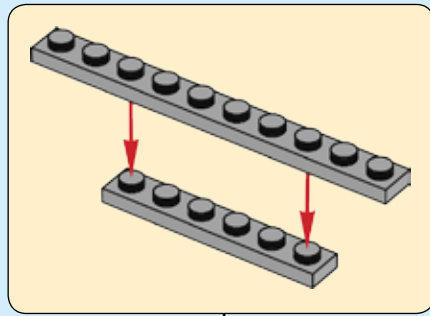

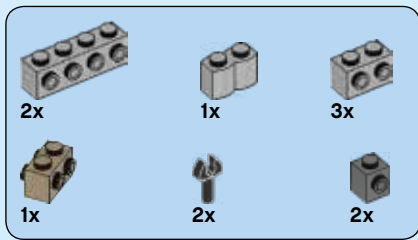

142

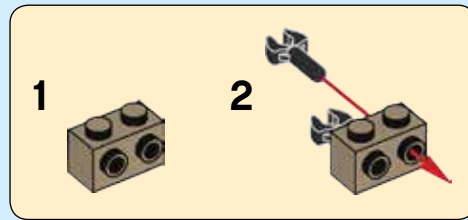

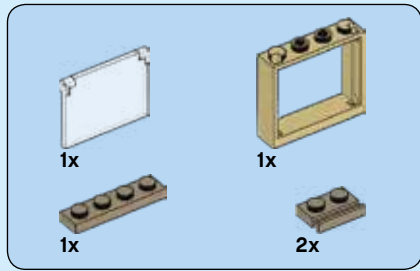

143

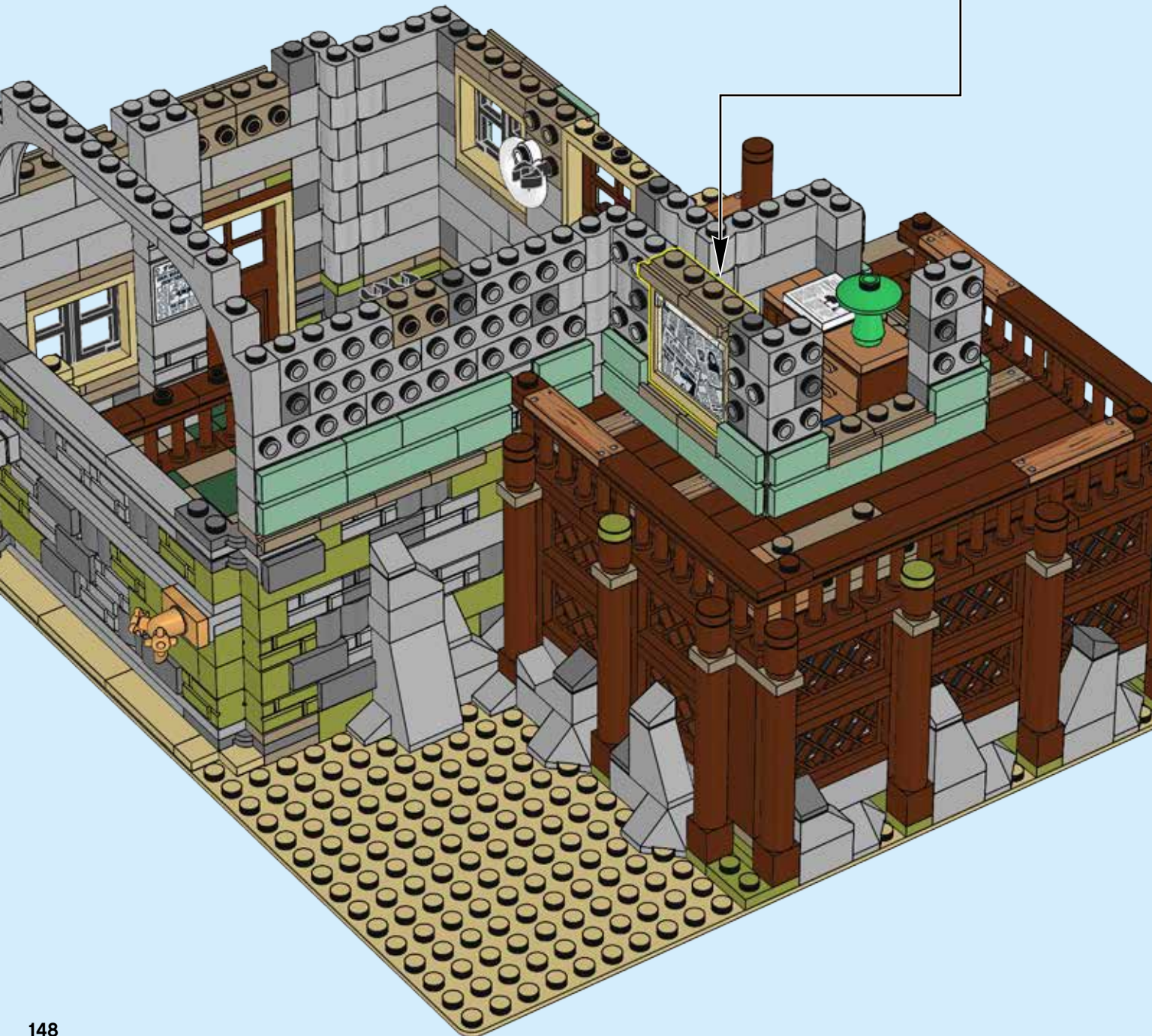
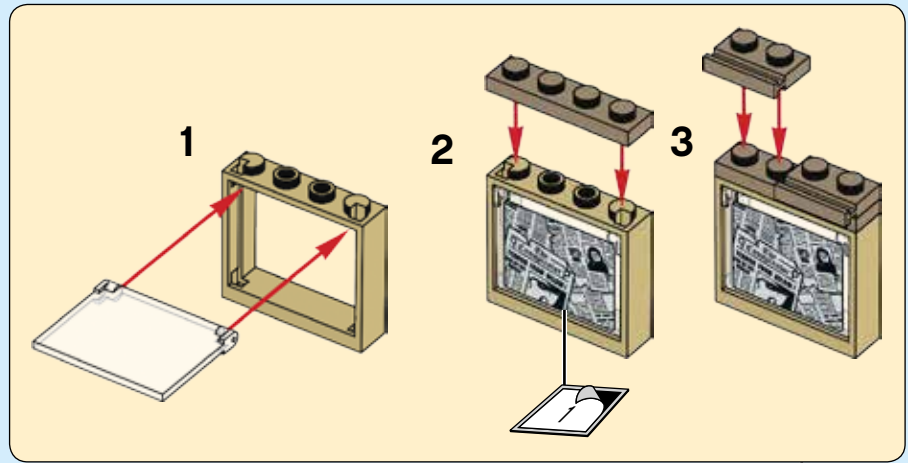

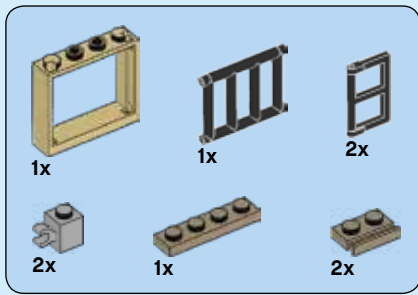

144

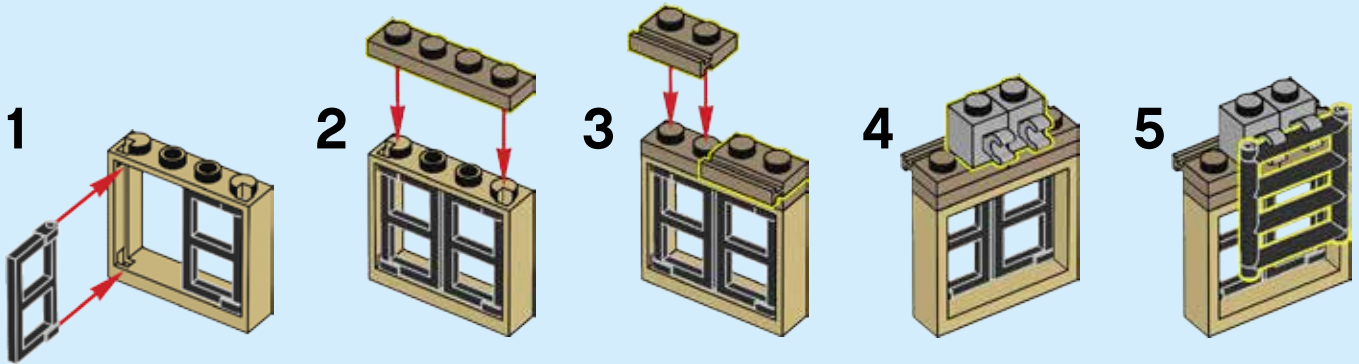
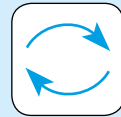

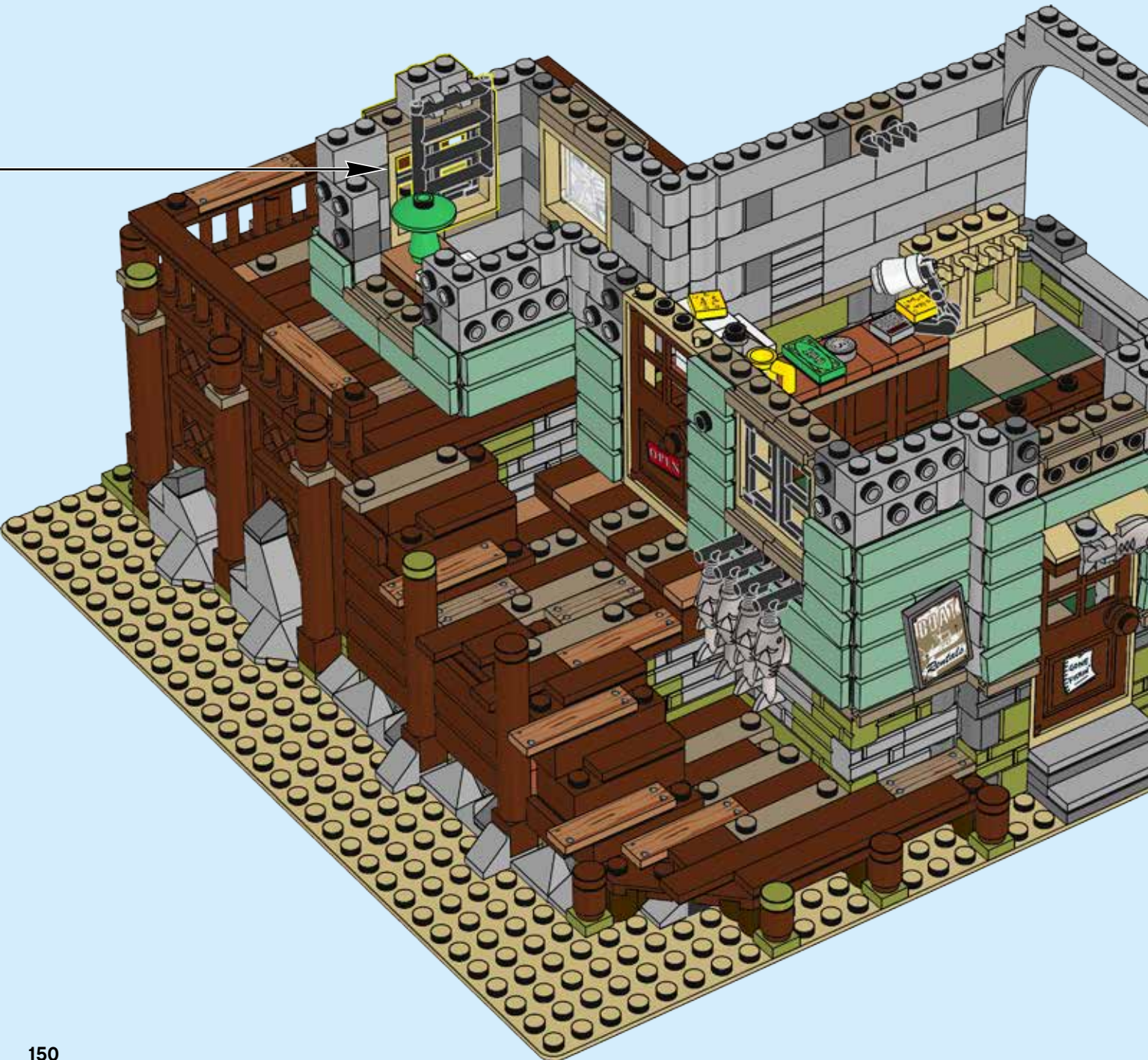
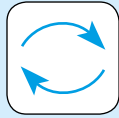

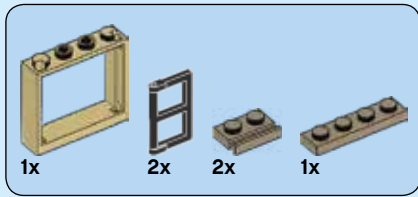

145

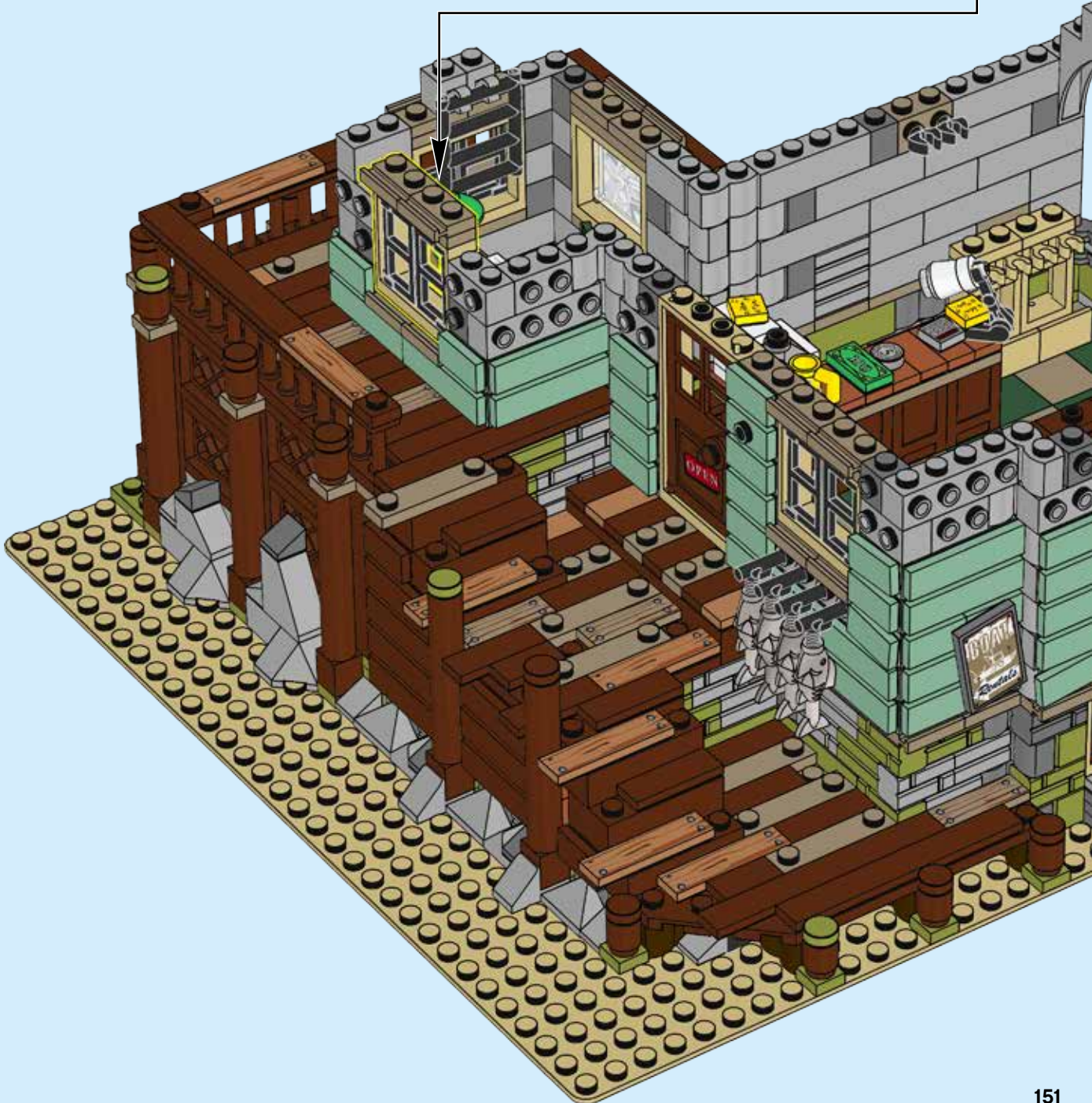
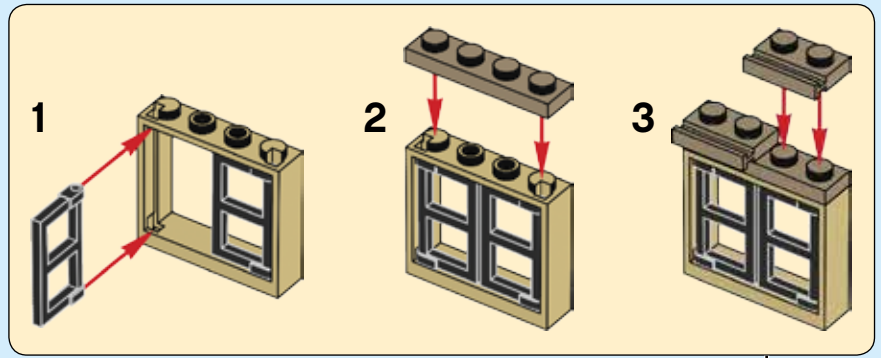

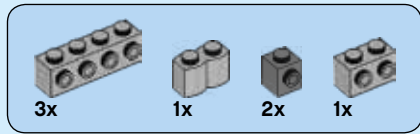



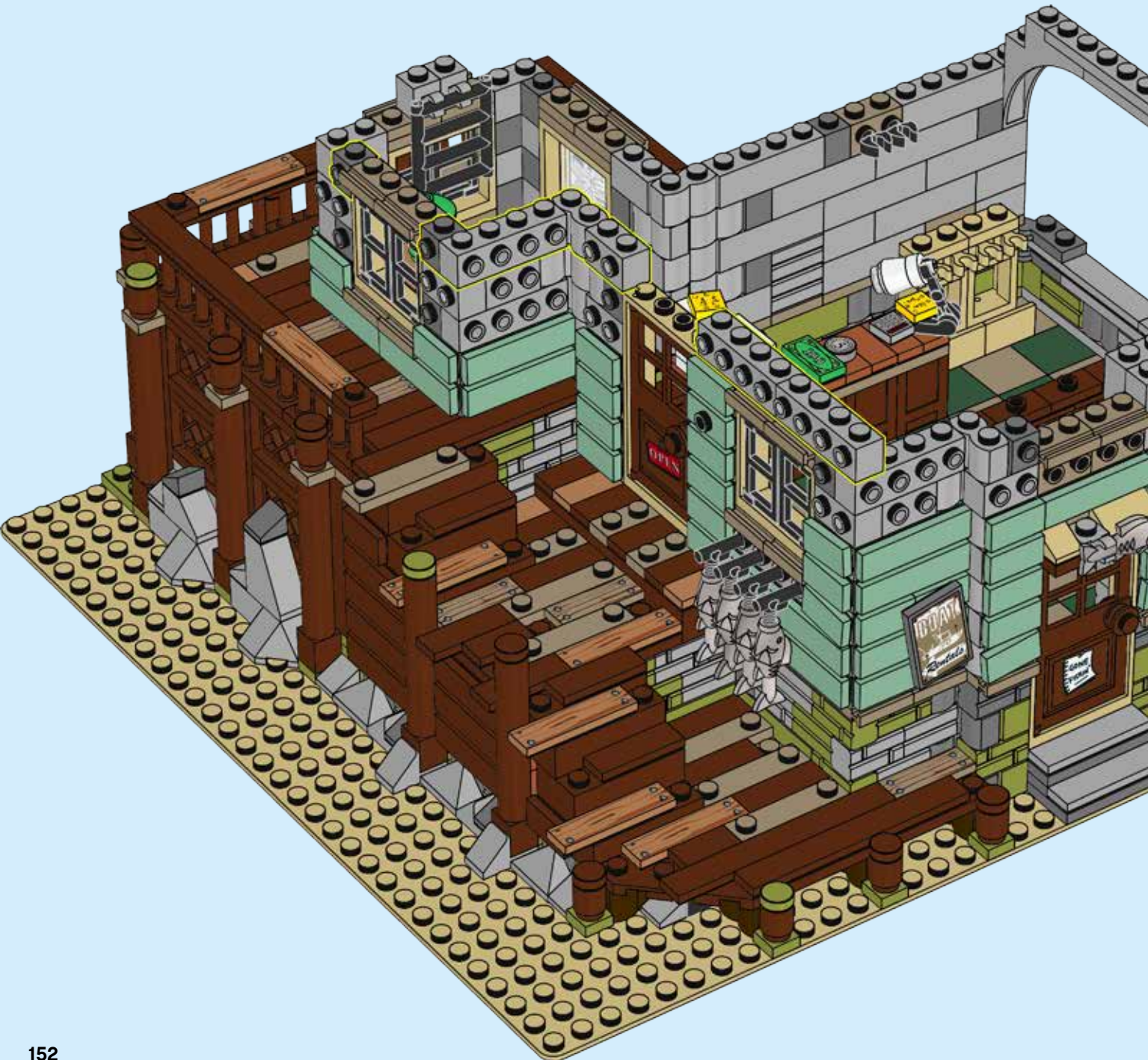

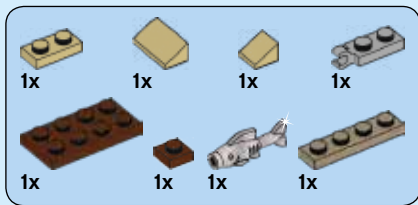
146



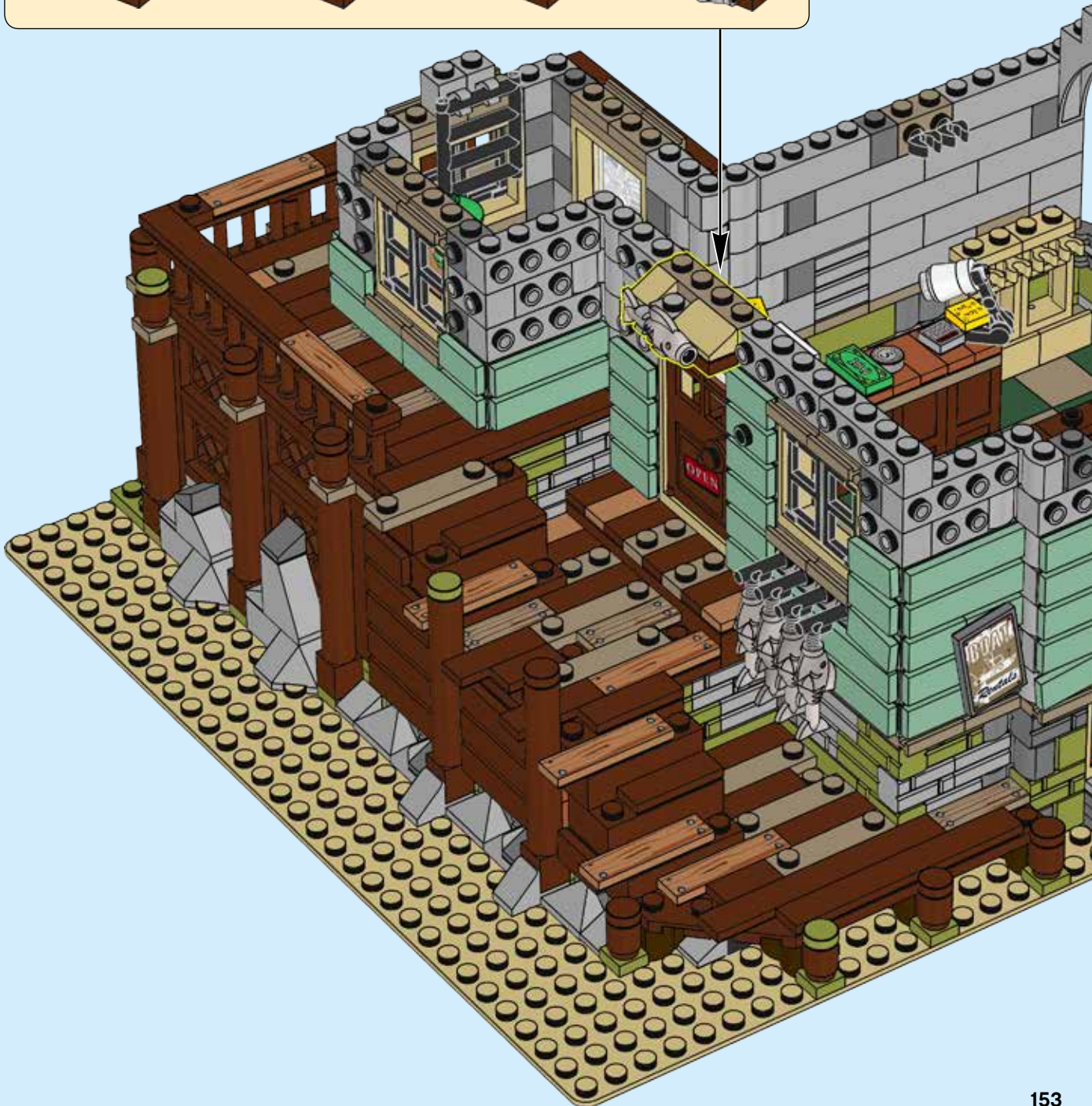

147



- 1x 
- 1x 
- 1x 
- 4x 

148

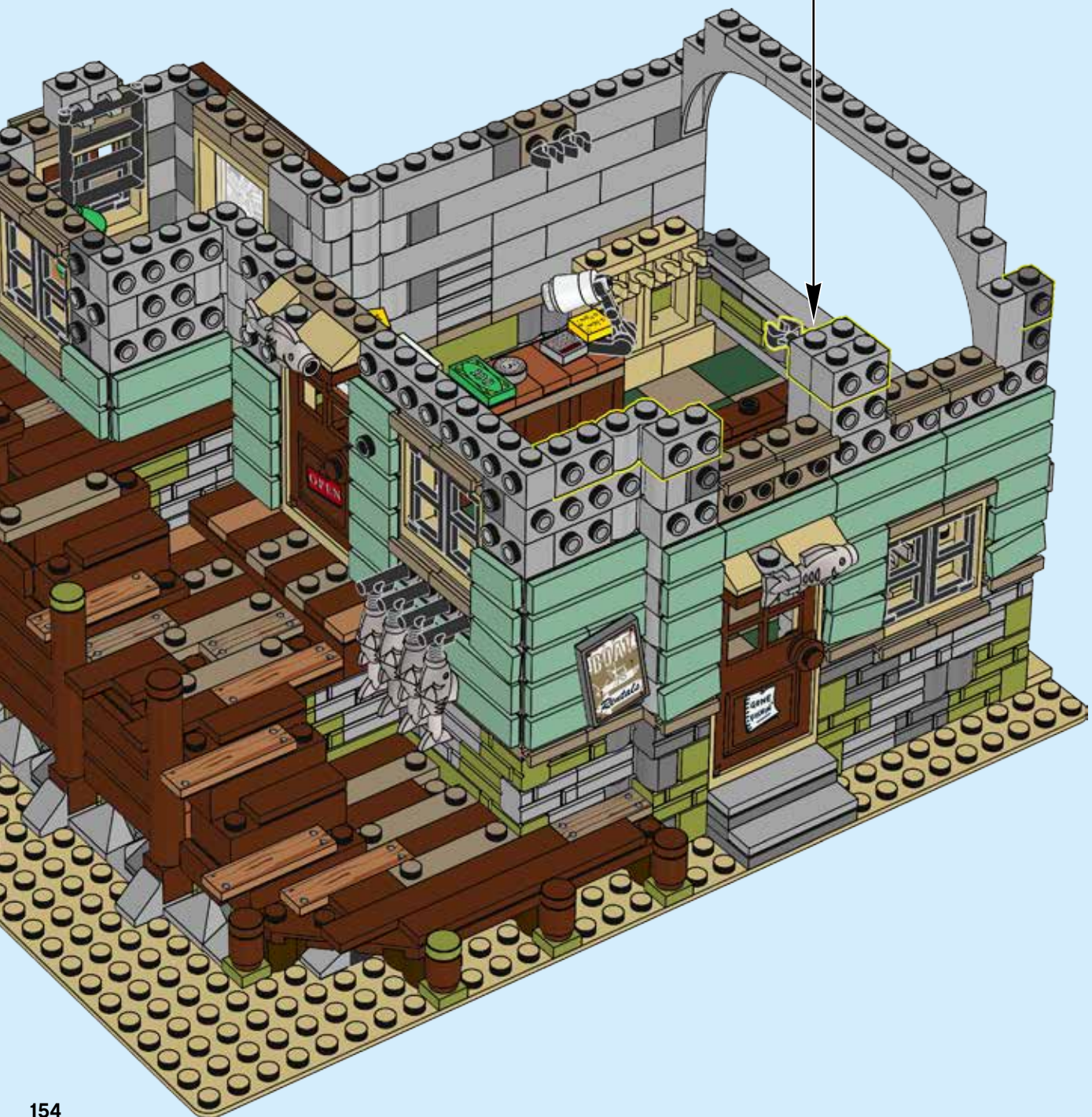
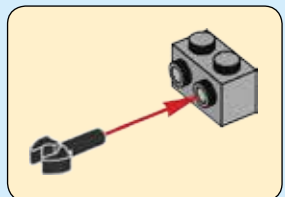

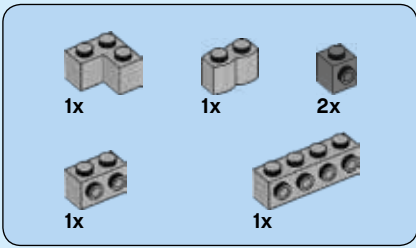

149



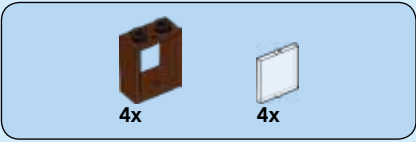

150

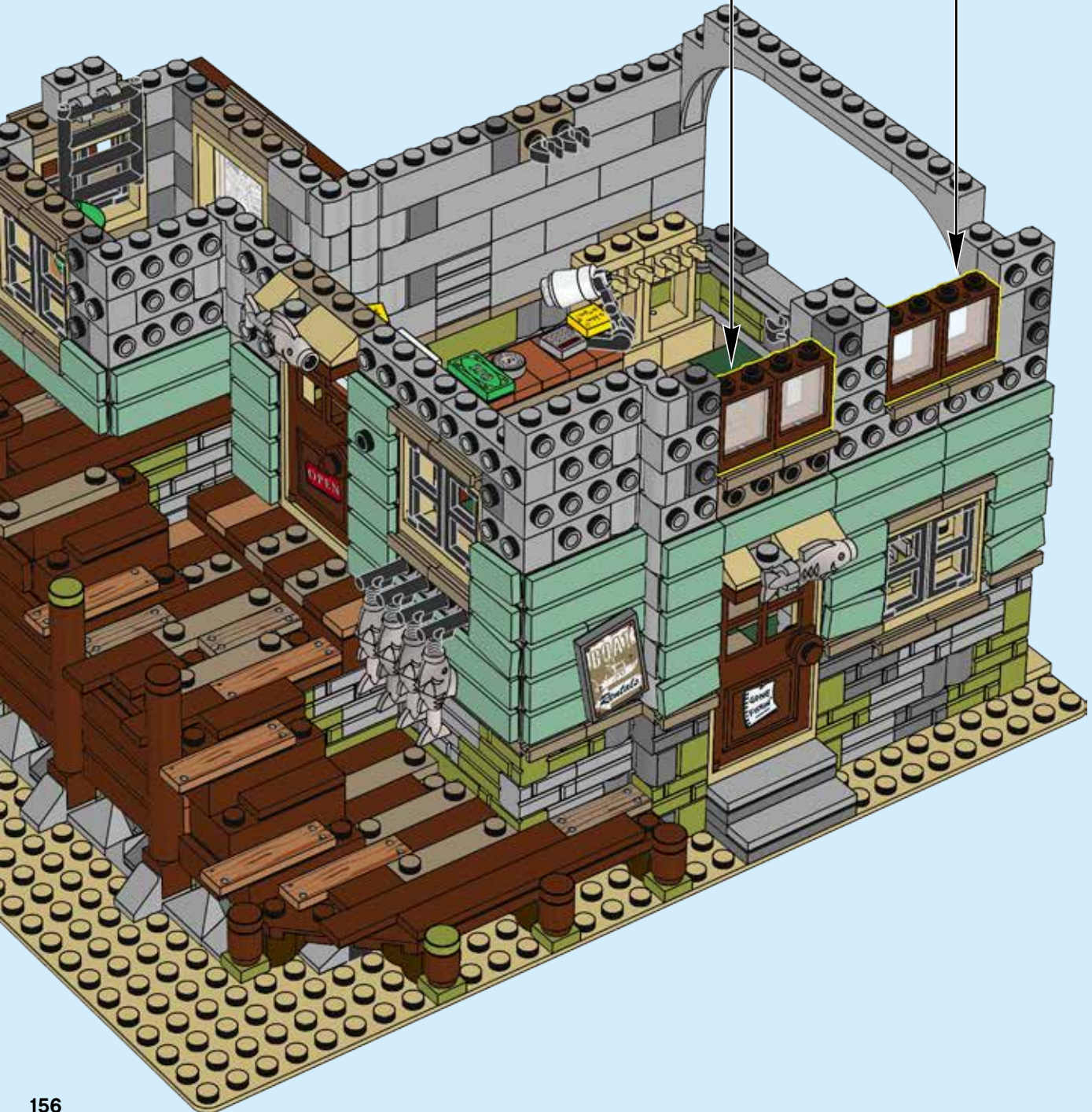
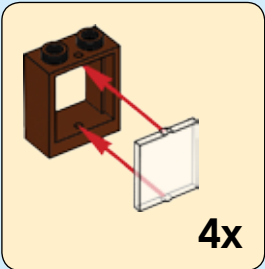

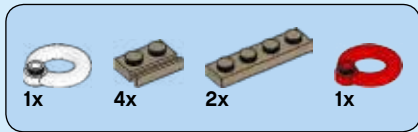

151

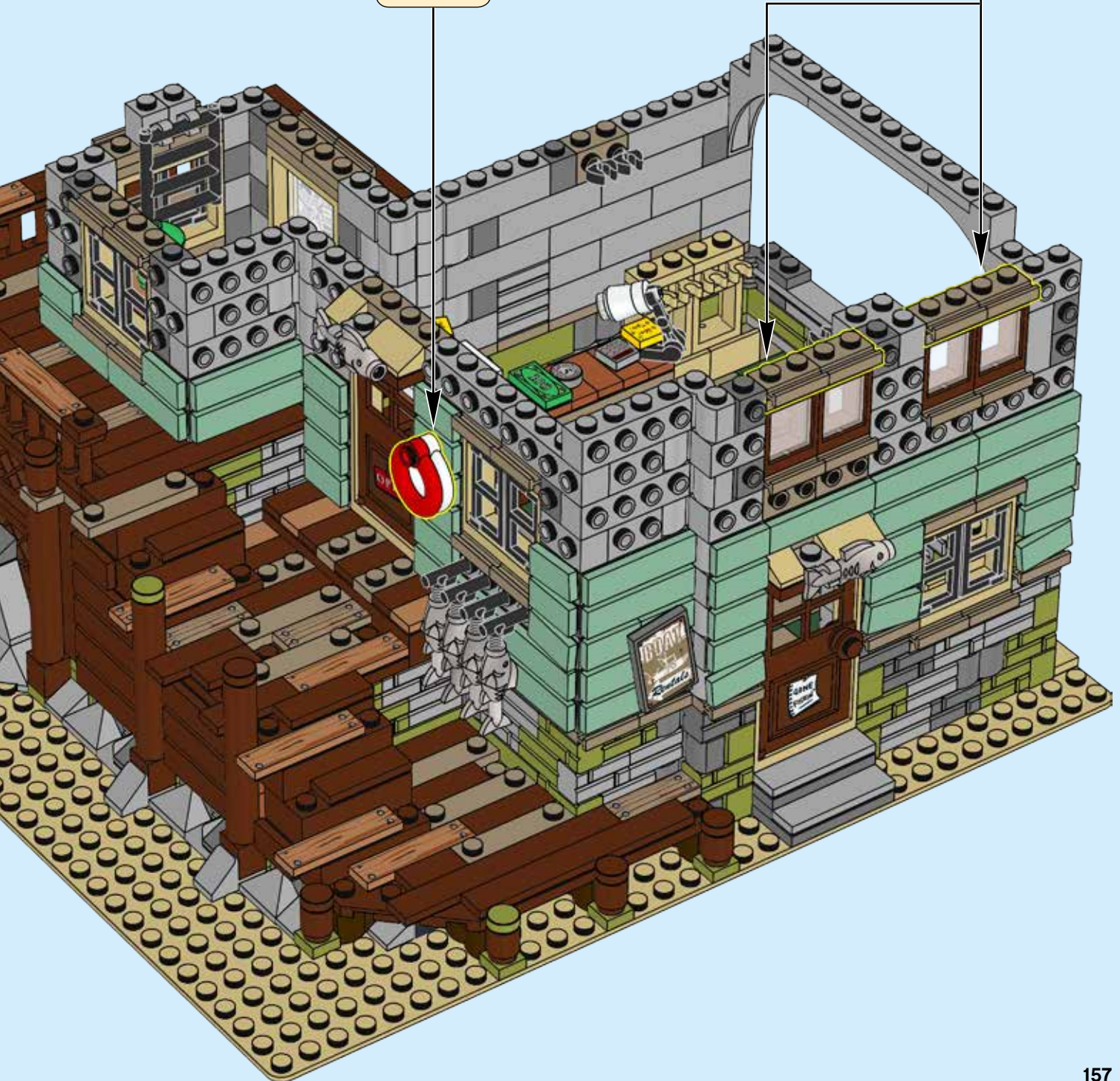
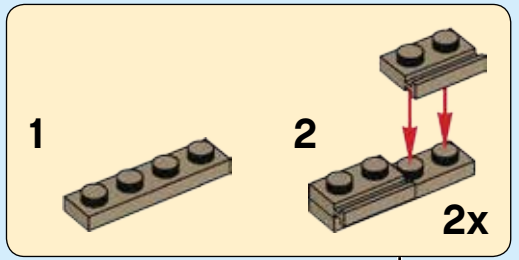
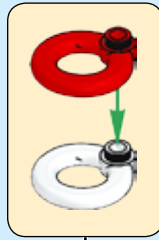

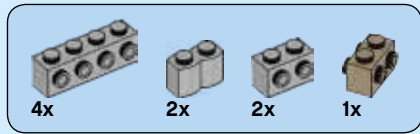

152

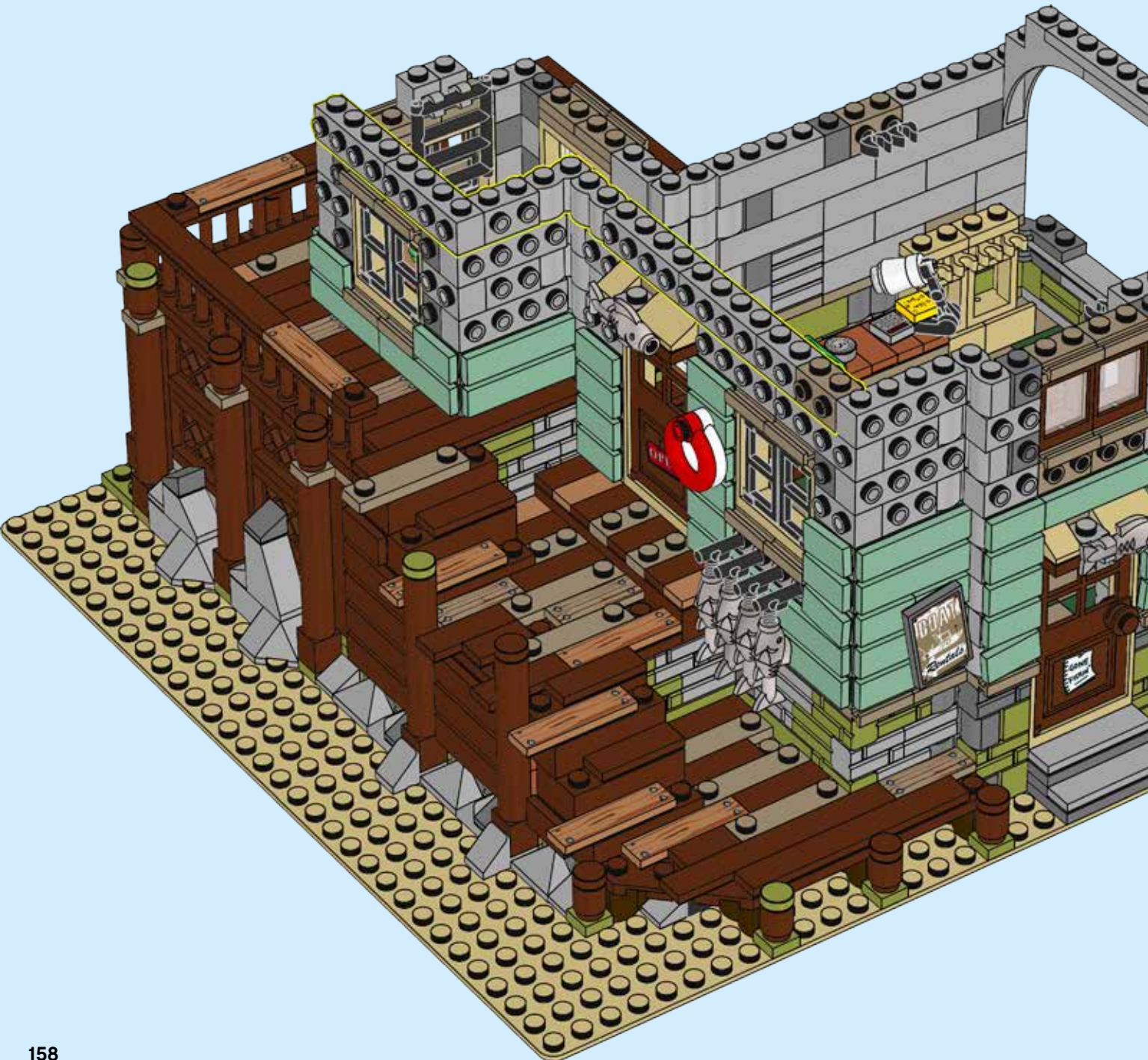

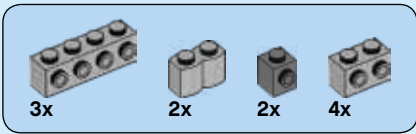

153

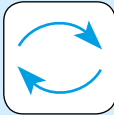

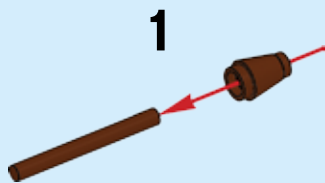
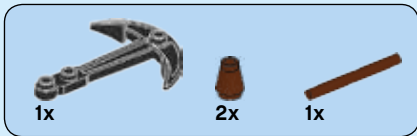

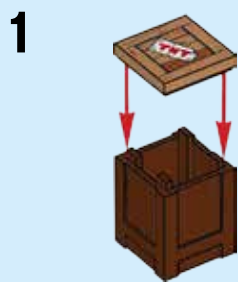
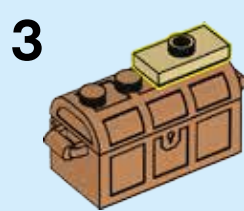
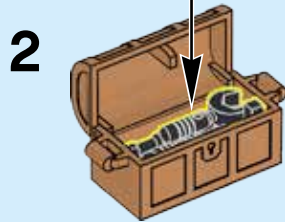
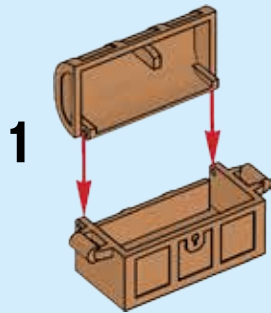
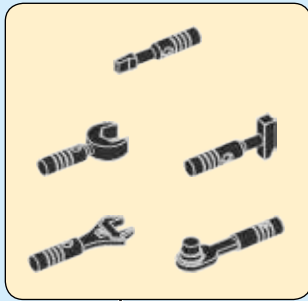
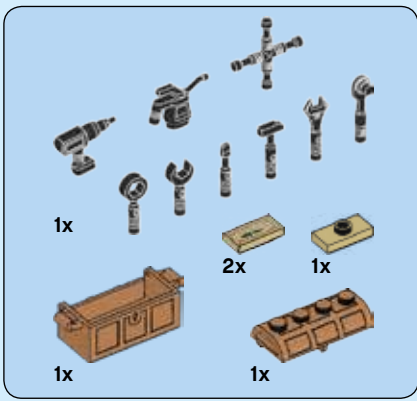

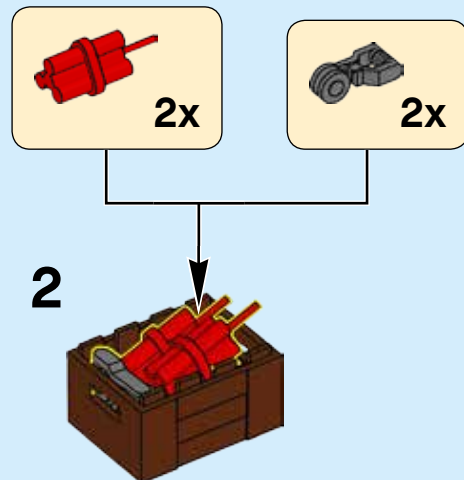
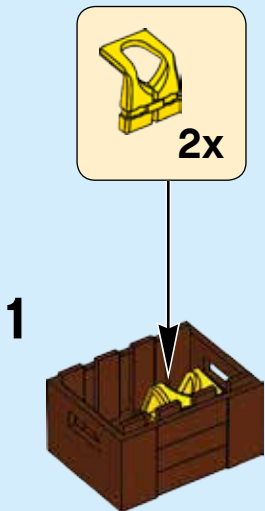
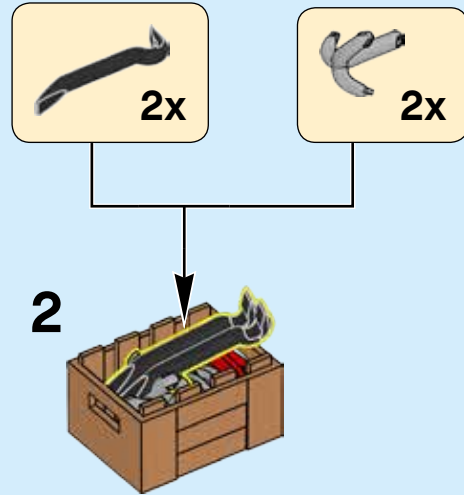
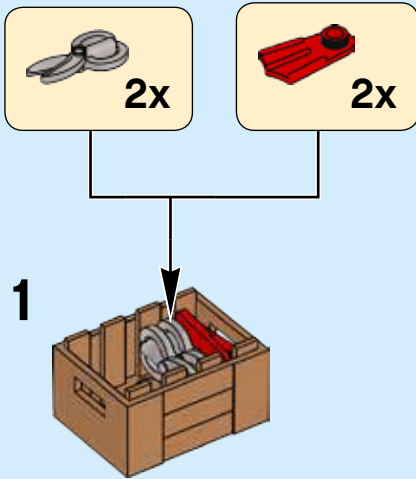
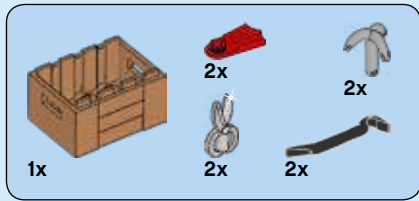

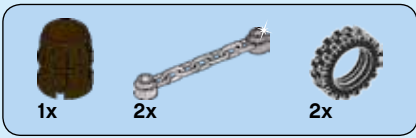

154

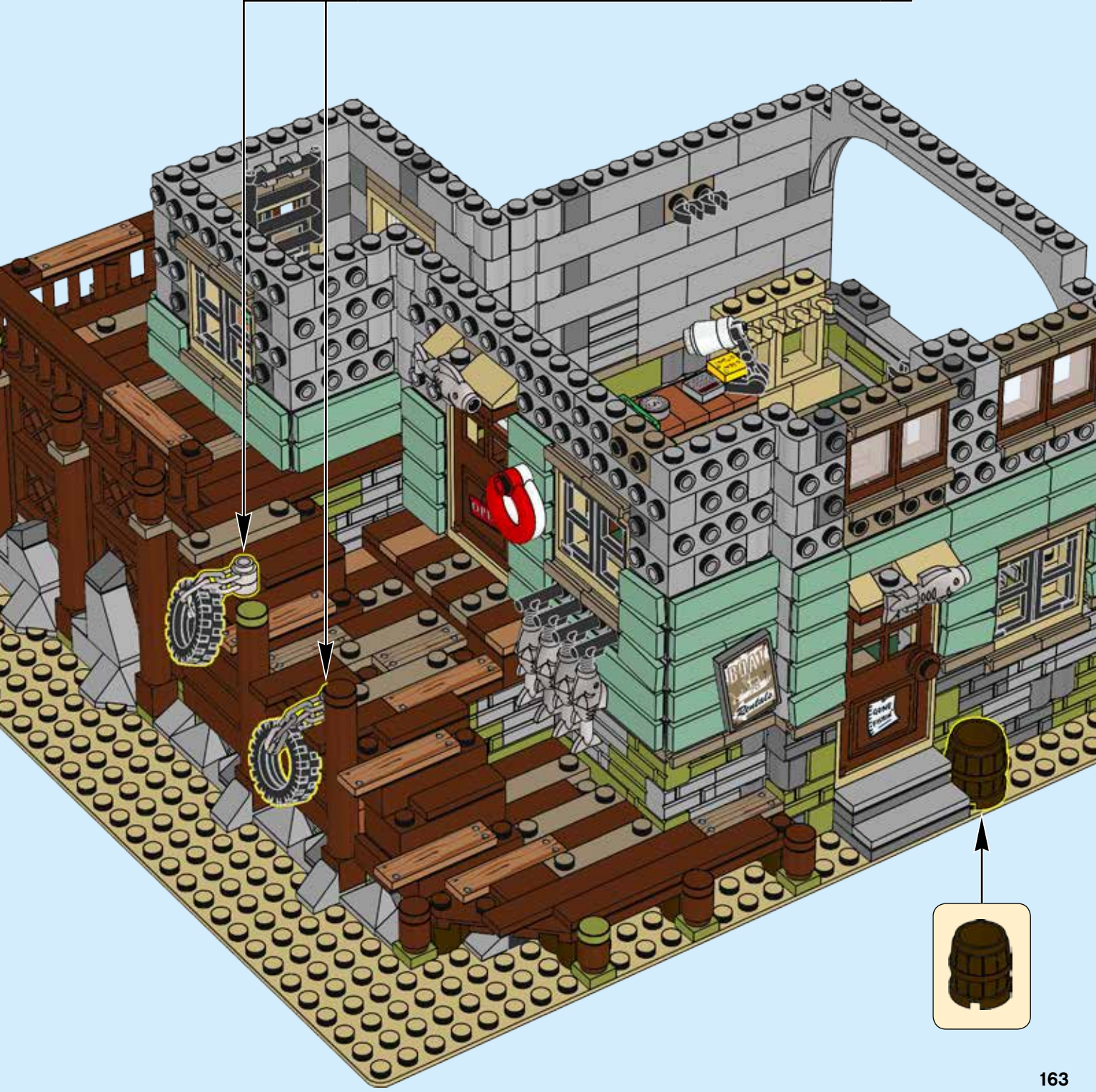
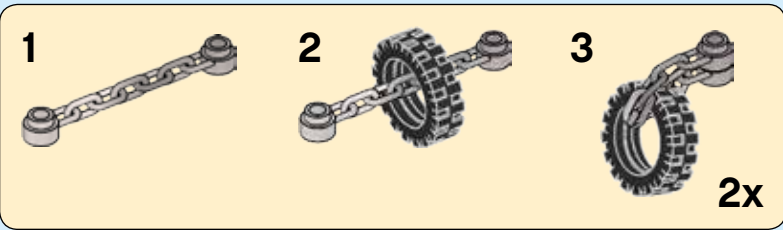

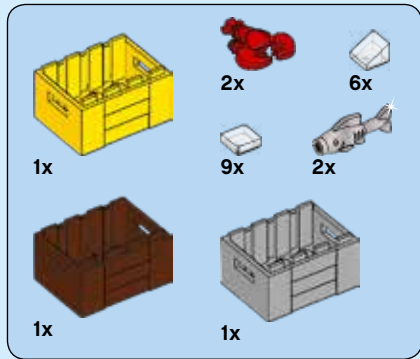

155

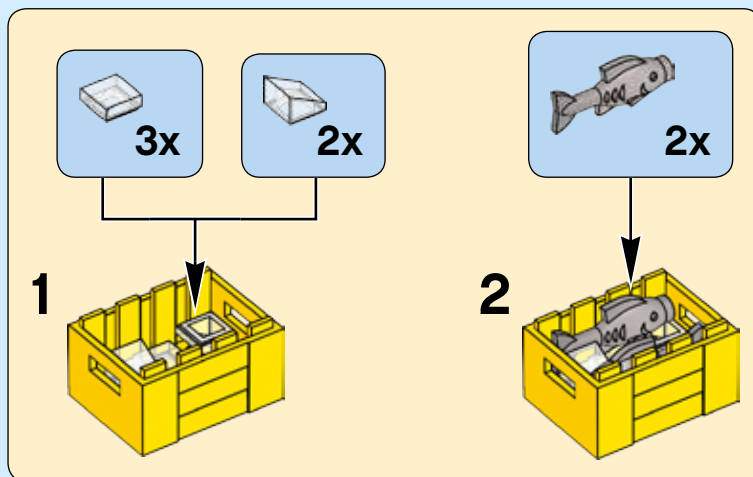
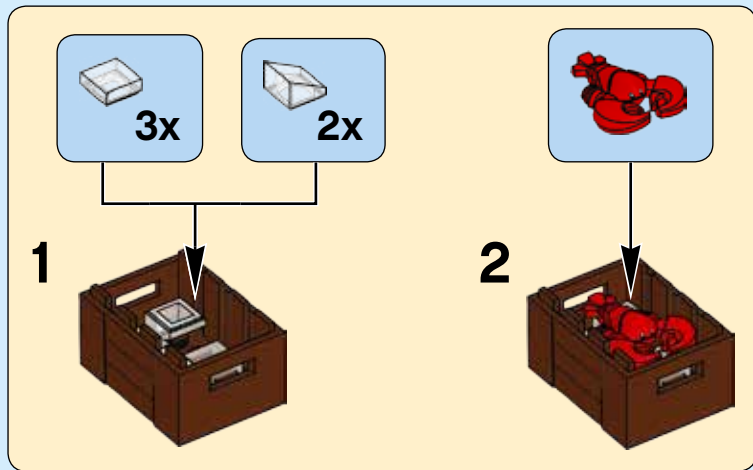
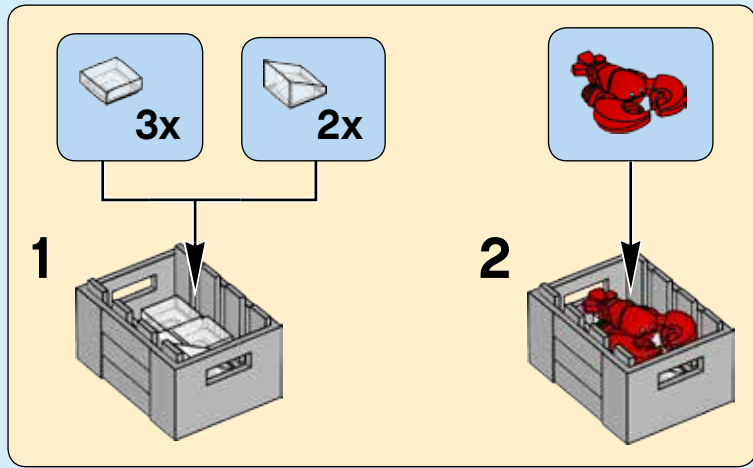

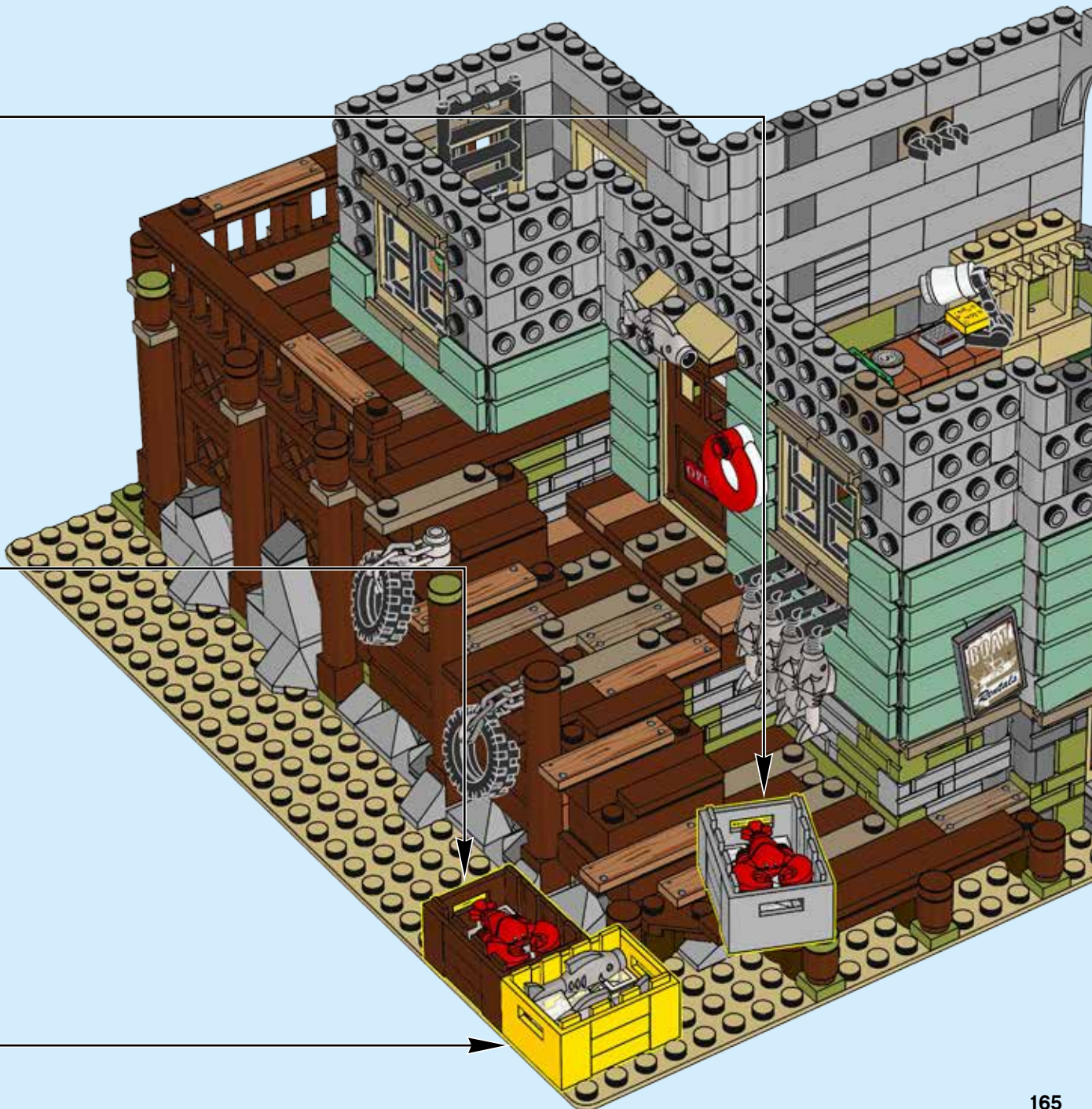

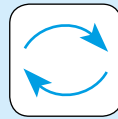
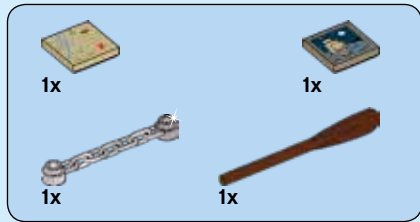

156



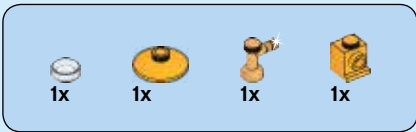

157

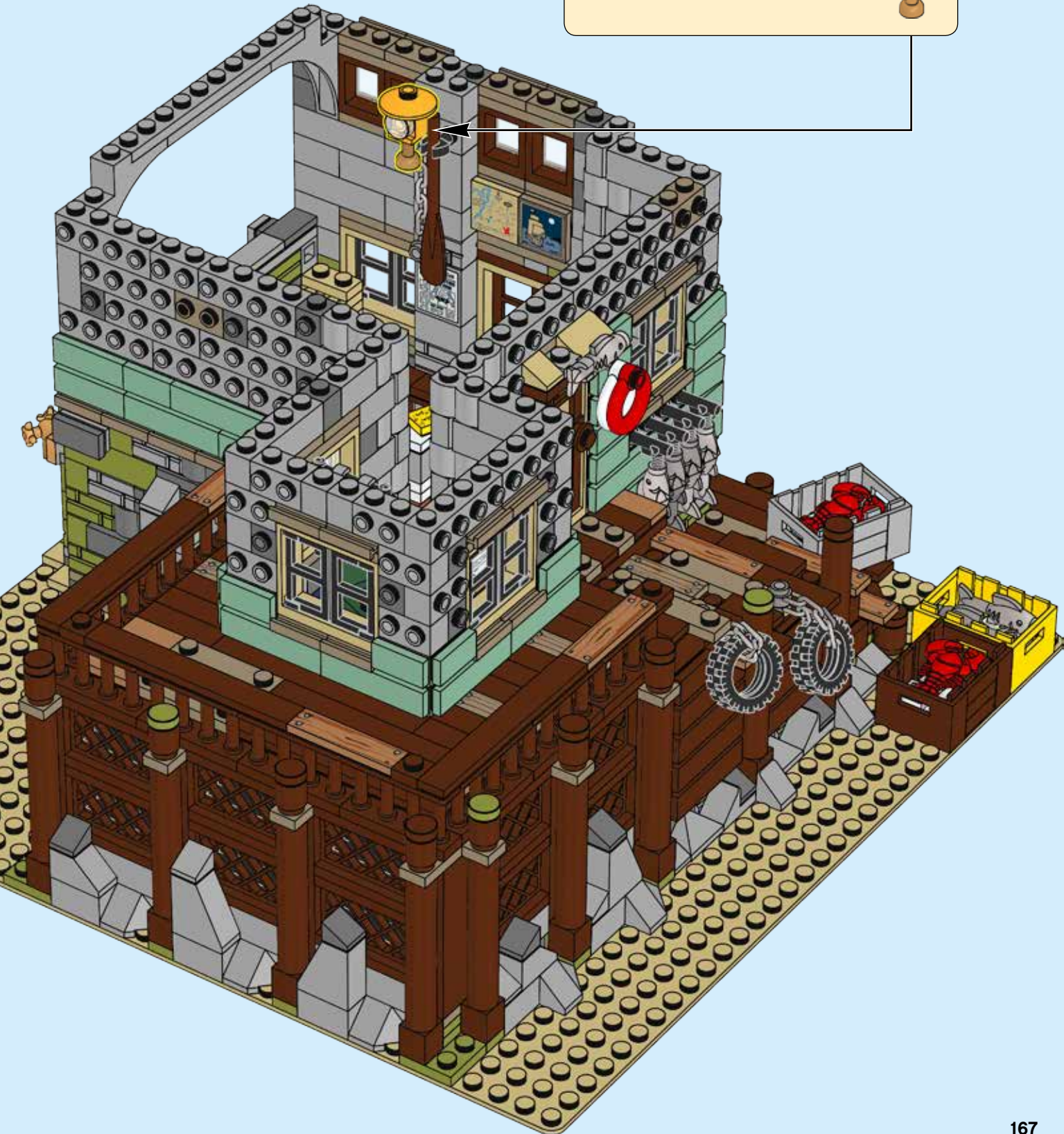

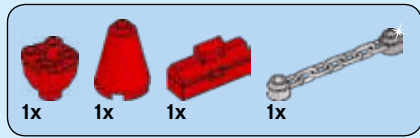

158

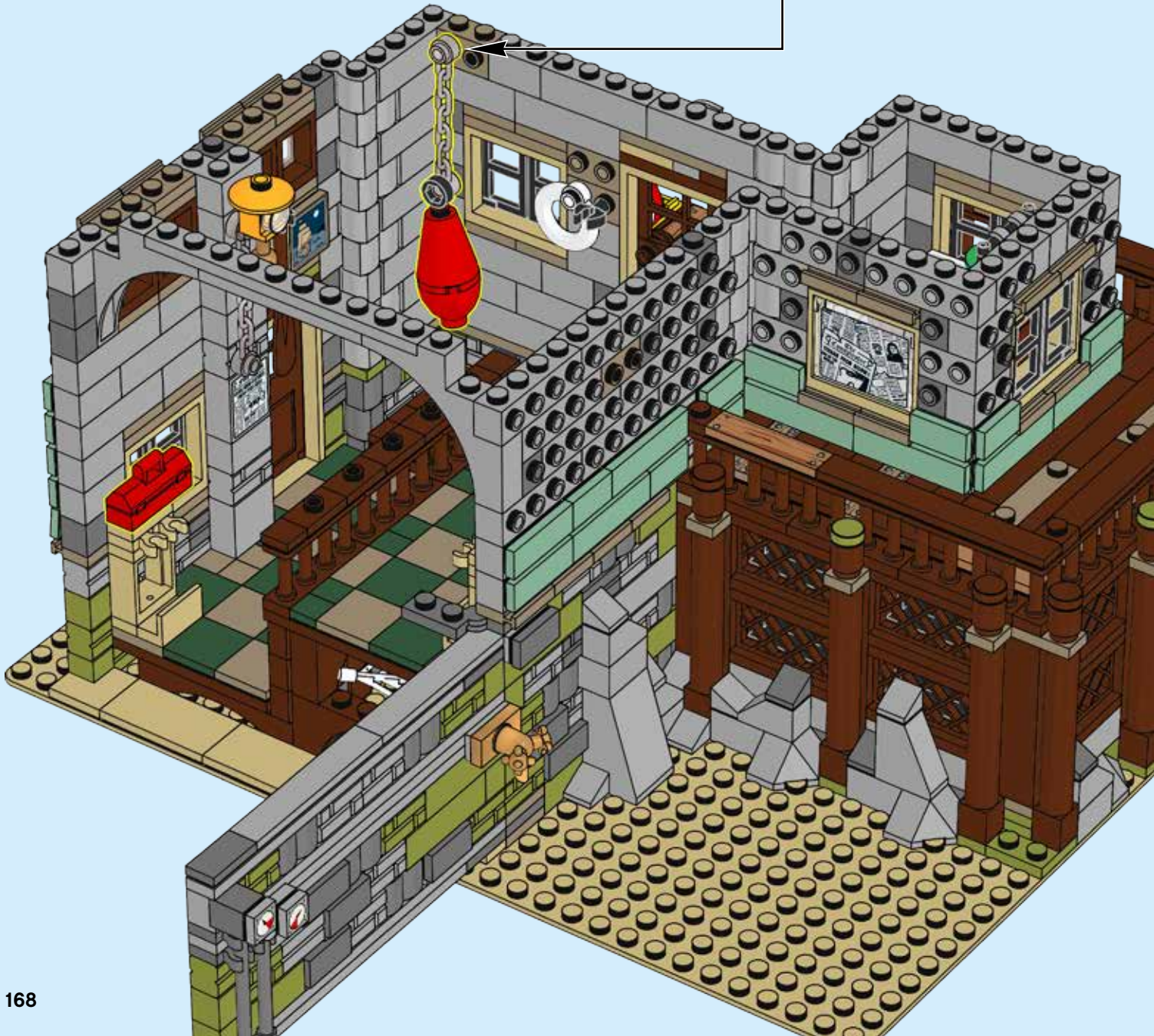
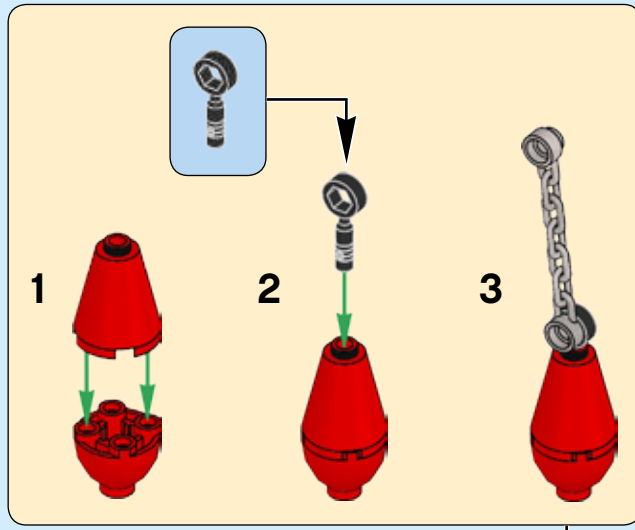
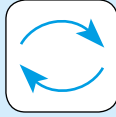

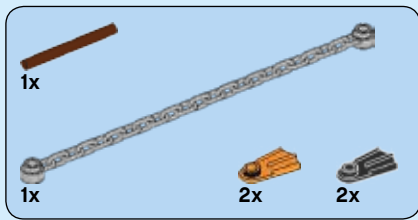

159

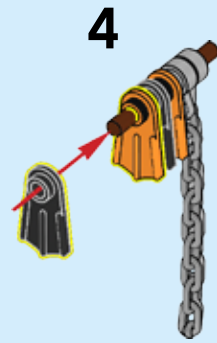
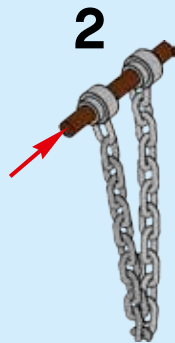

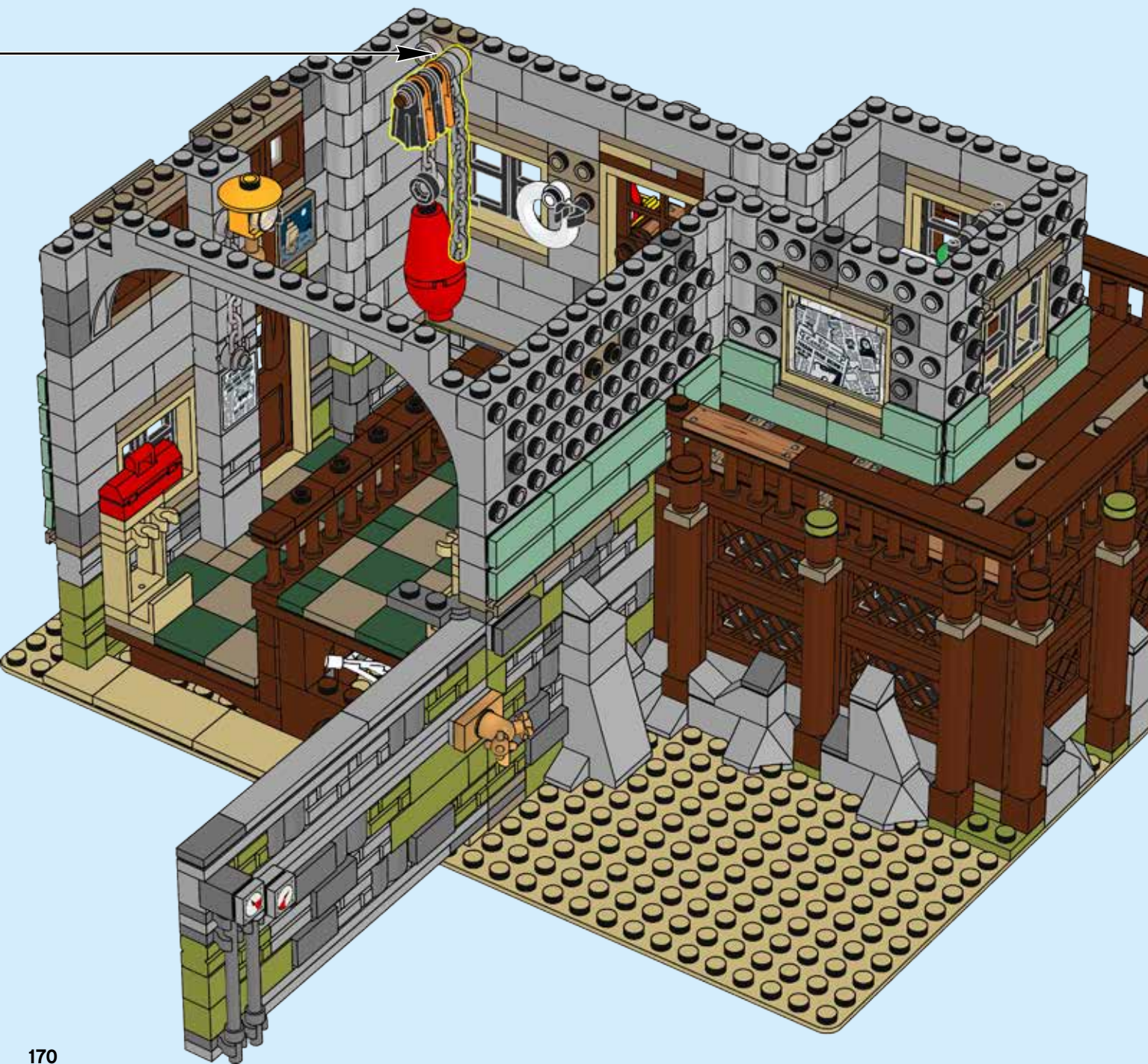

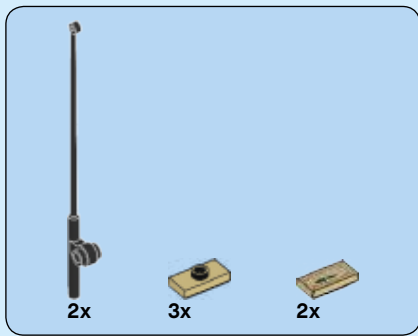

160

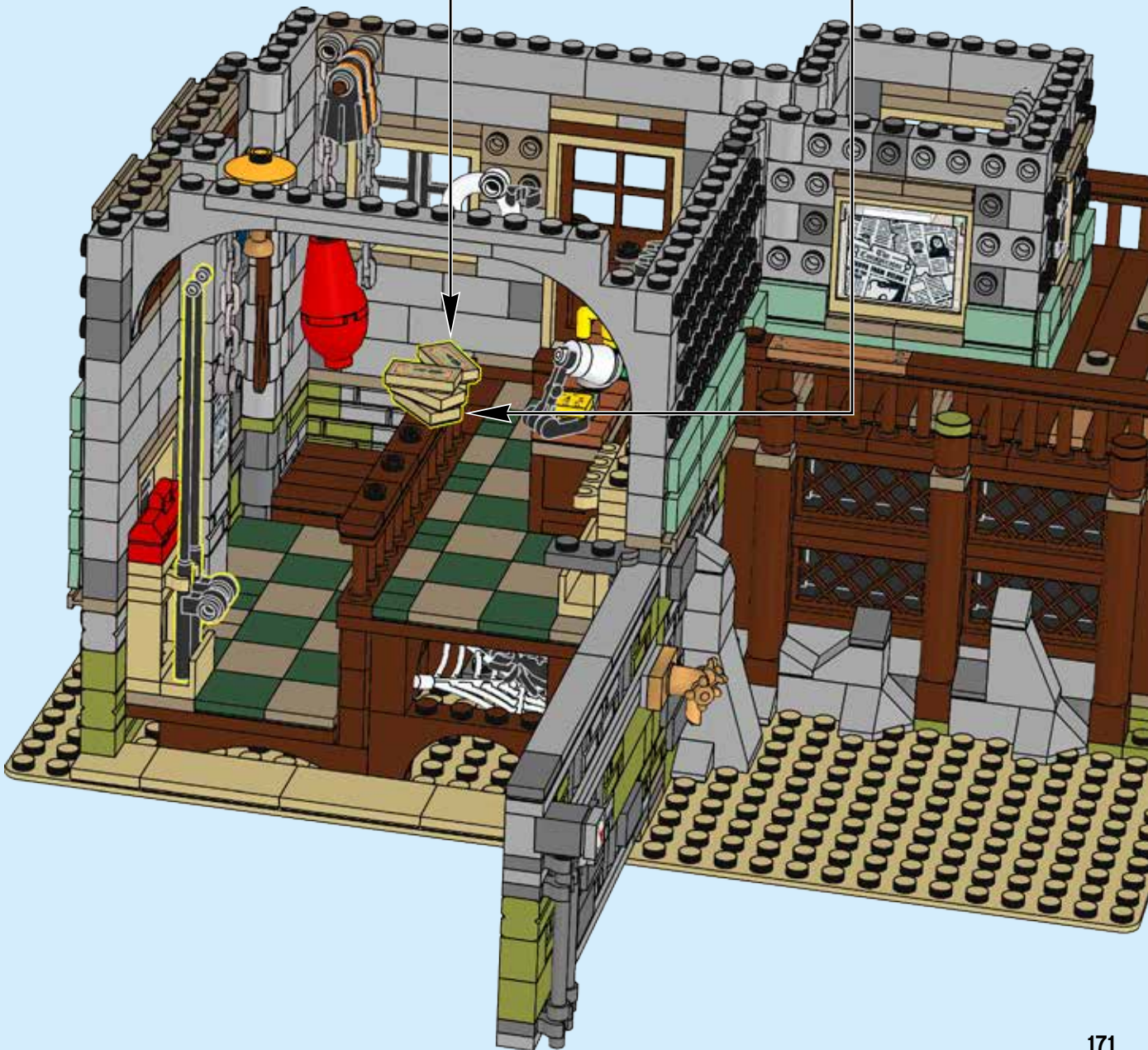
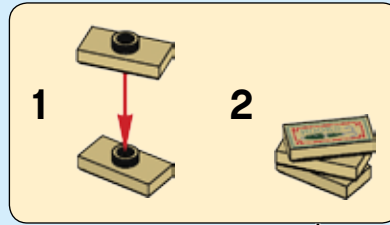
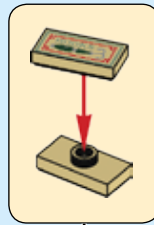



2x



1x

161

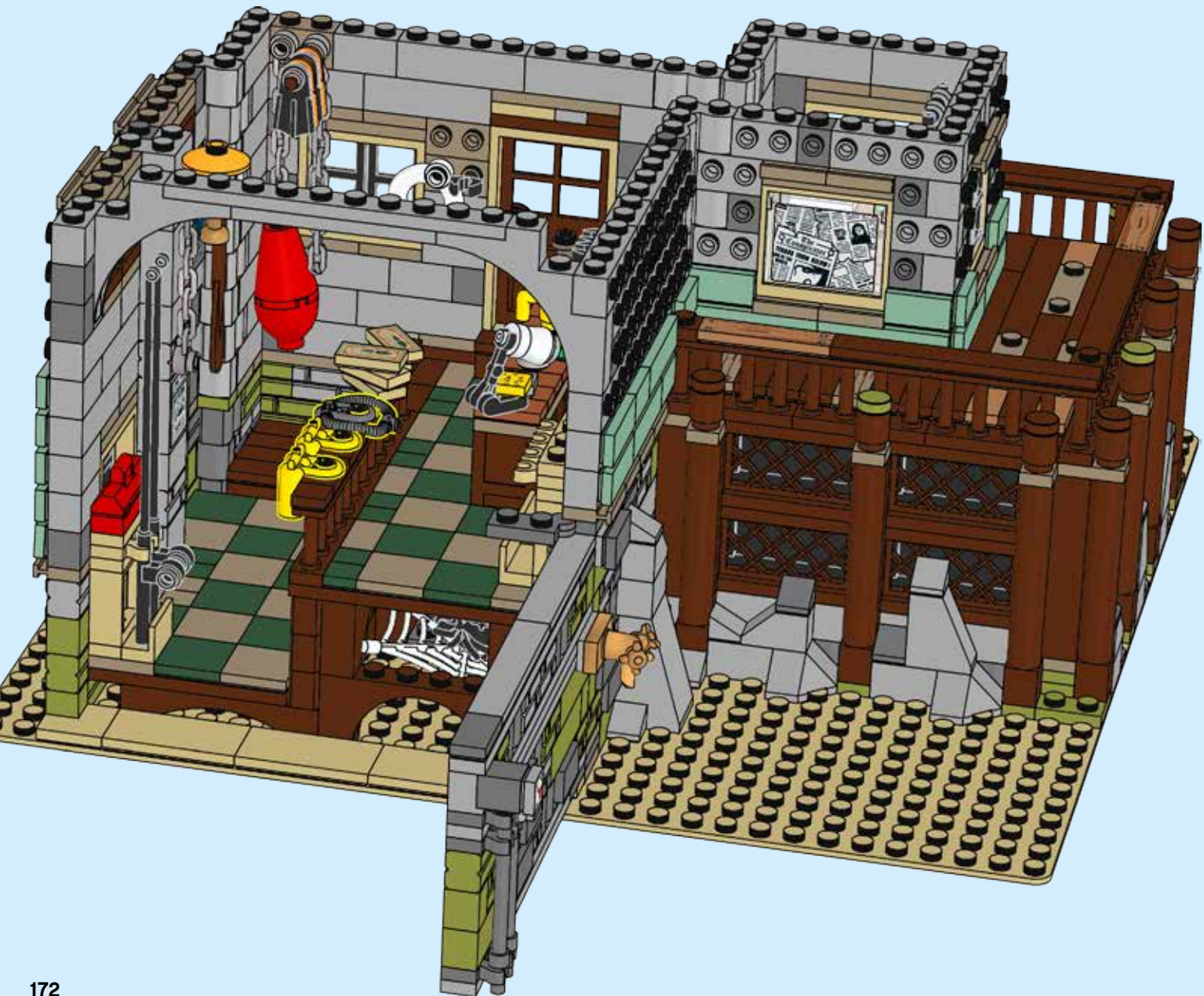



3x



3x

162

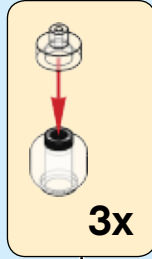

3x

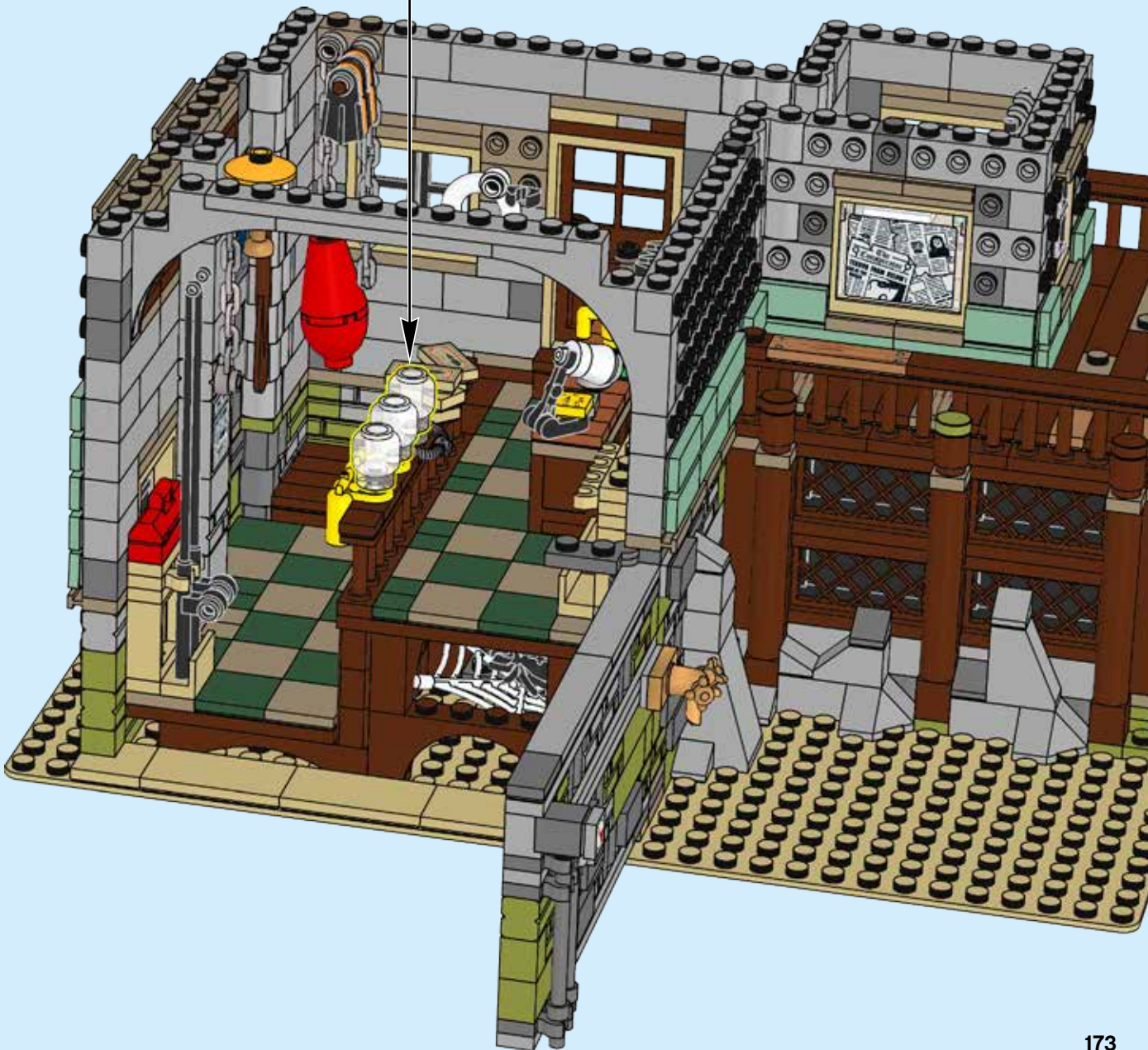

3x 3x 1x

163

3x

1x

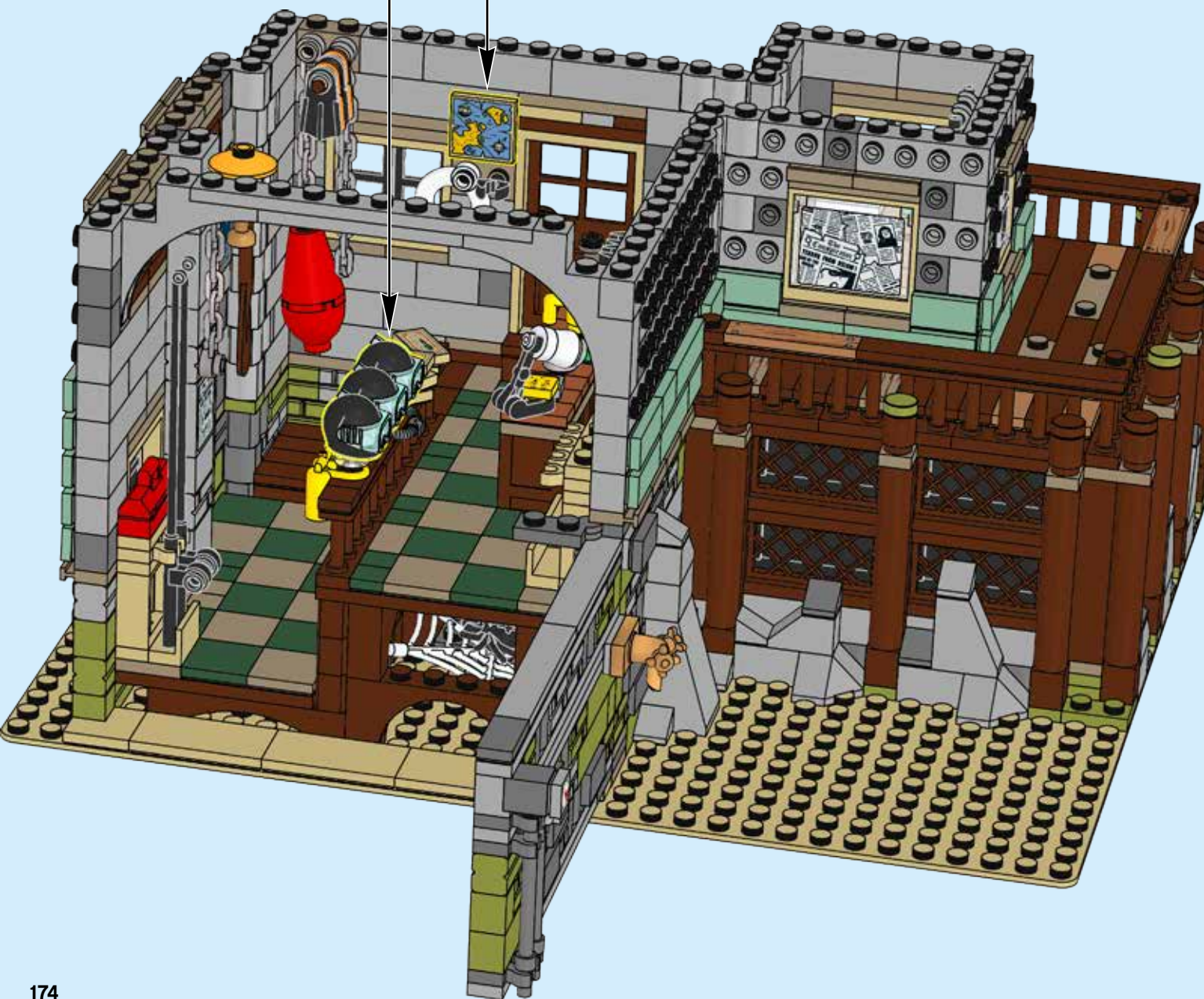

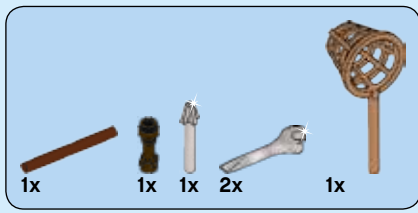

164

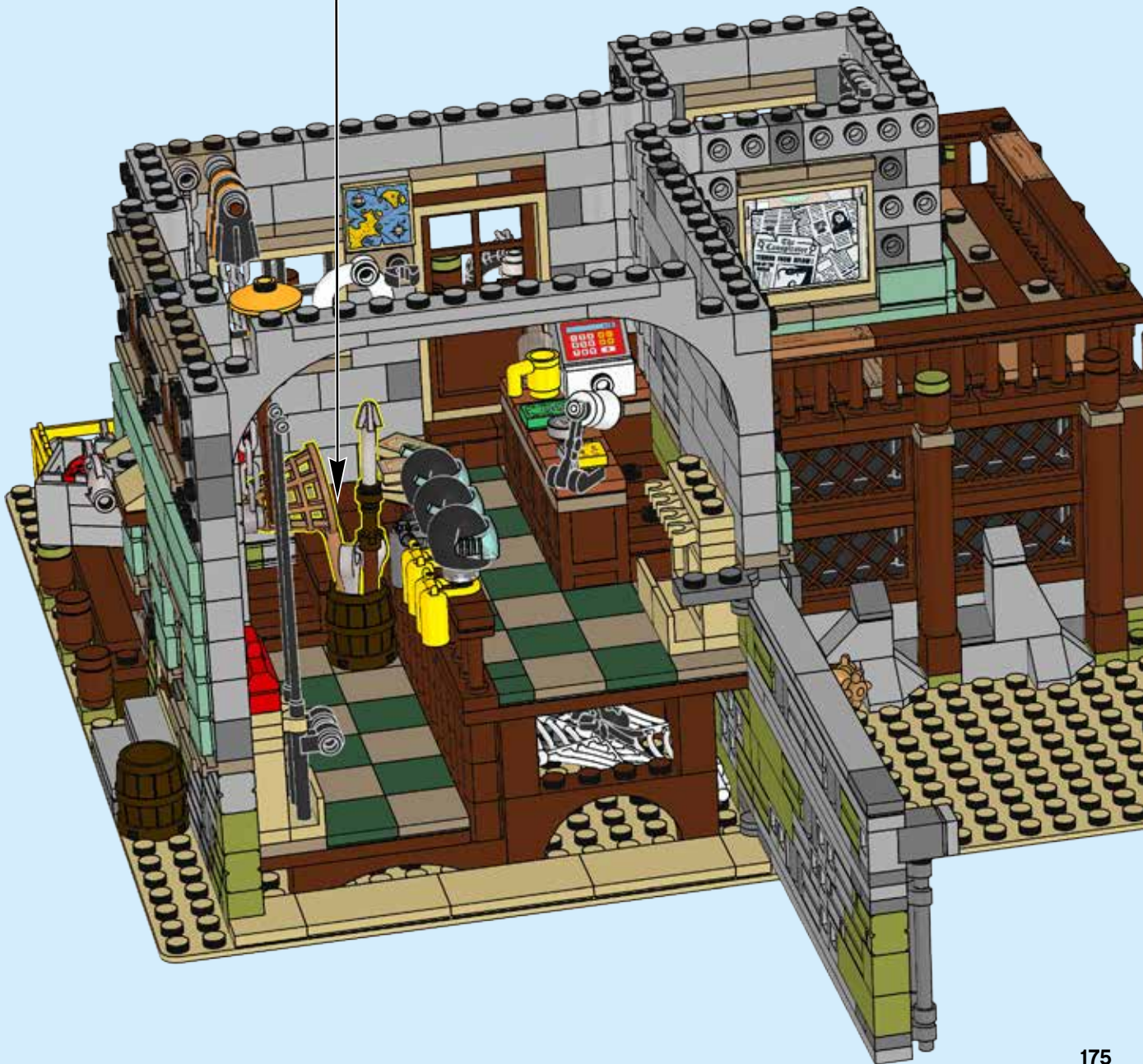
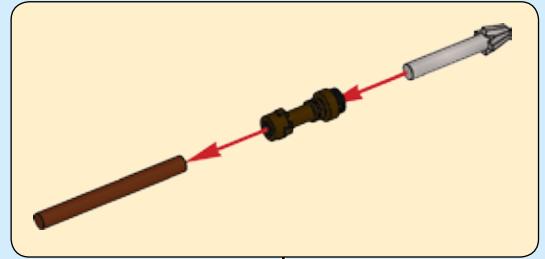
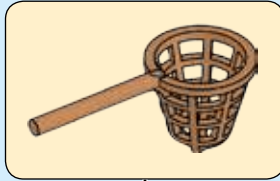
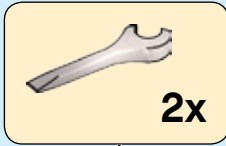

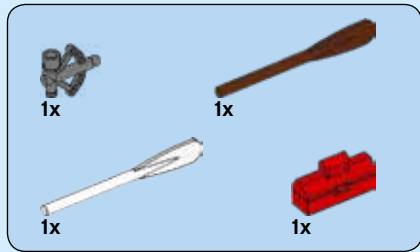

165



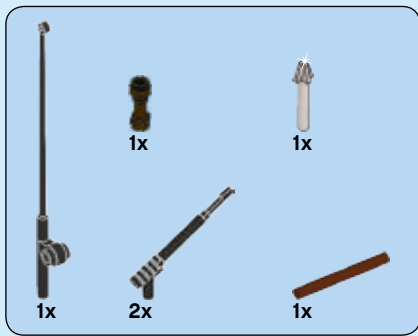

166

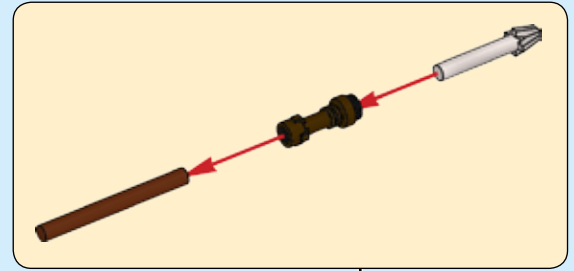

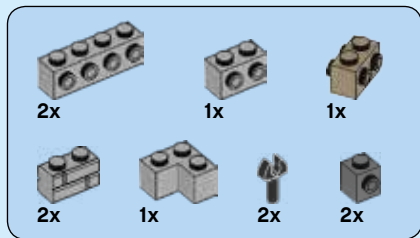

167

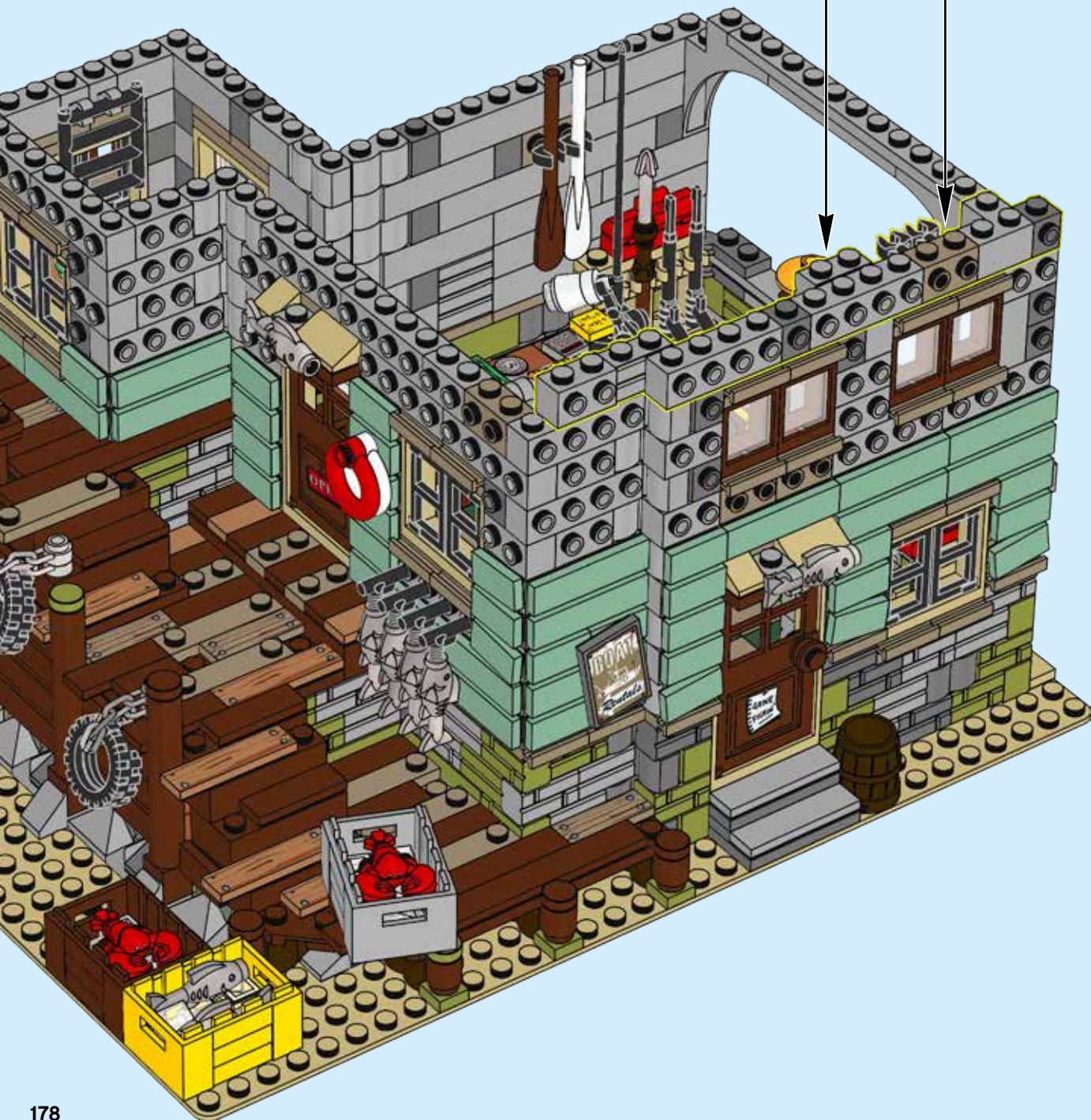
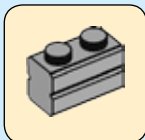
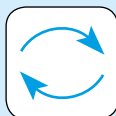
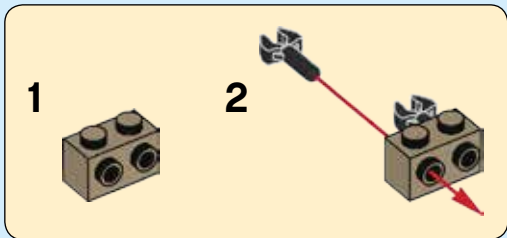



7x



1x

168

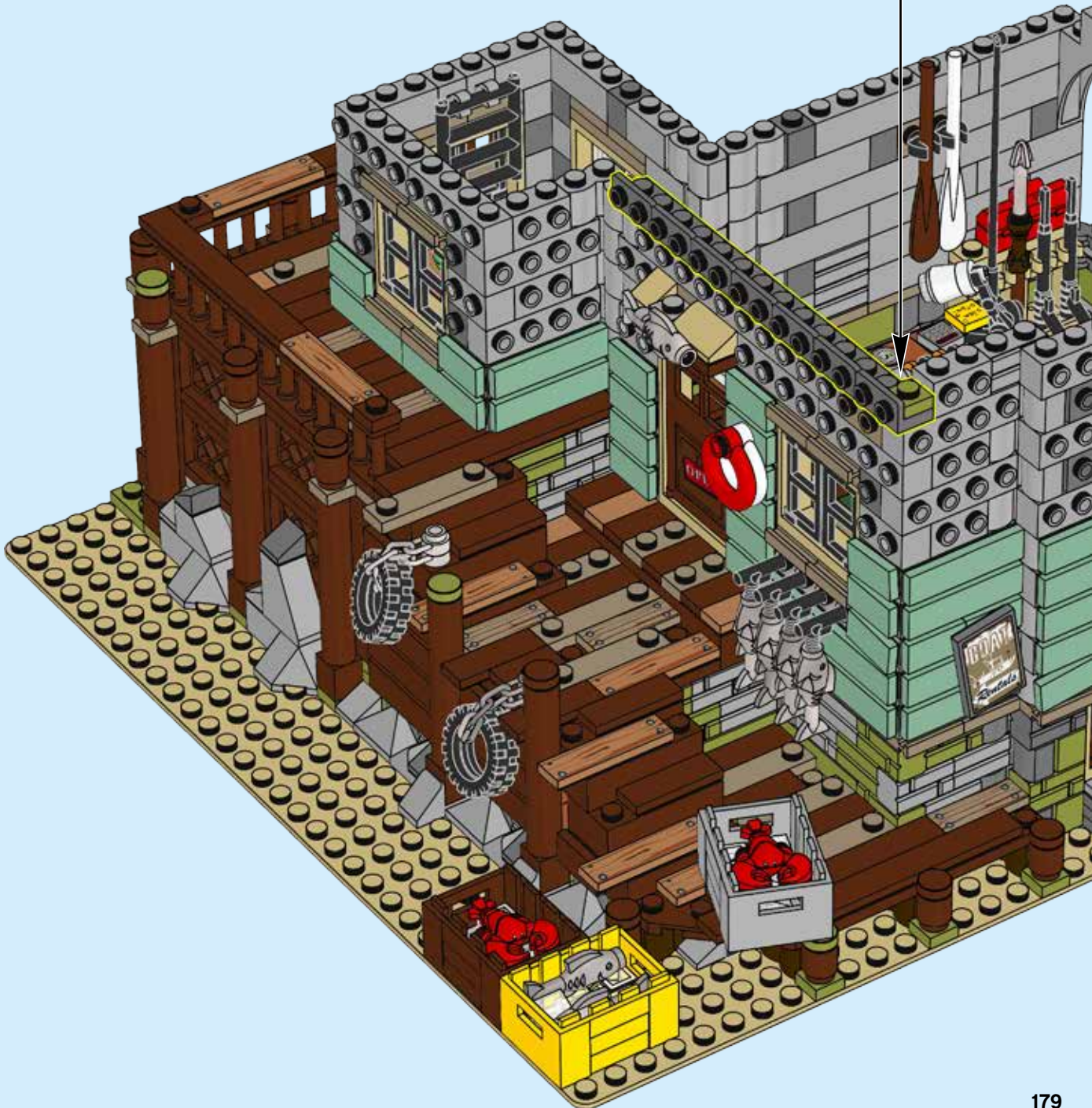
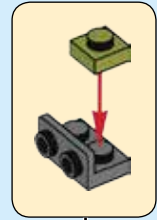

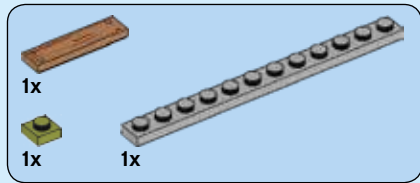

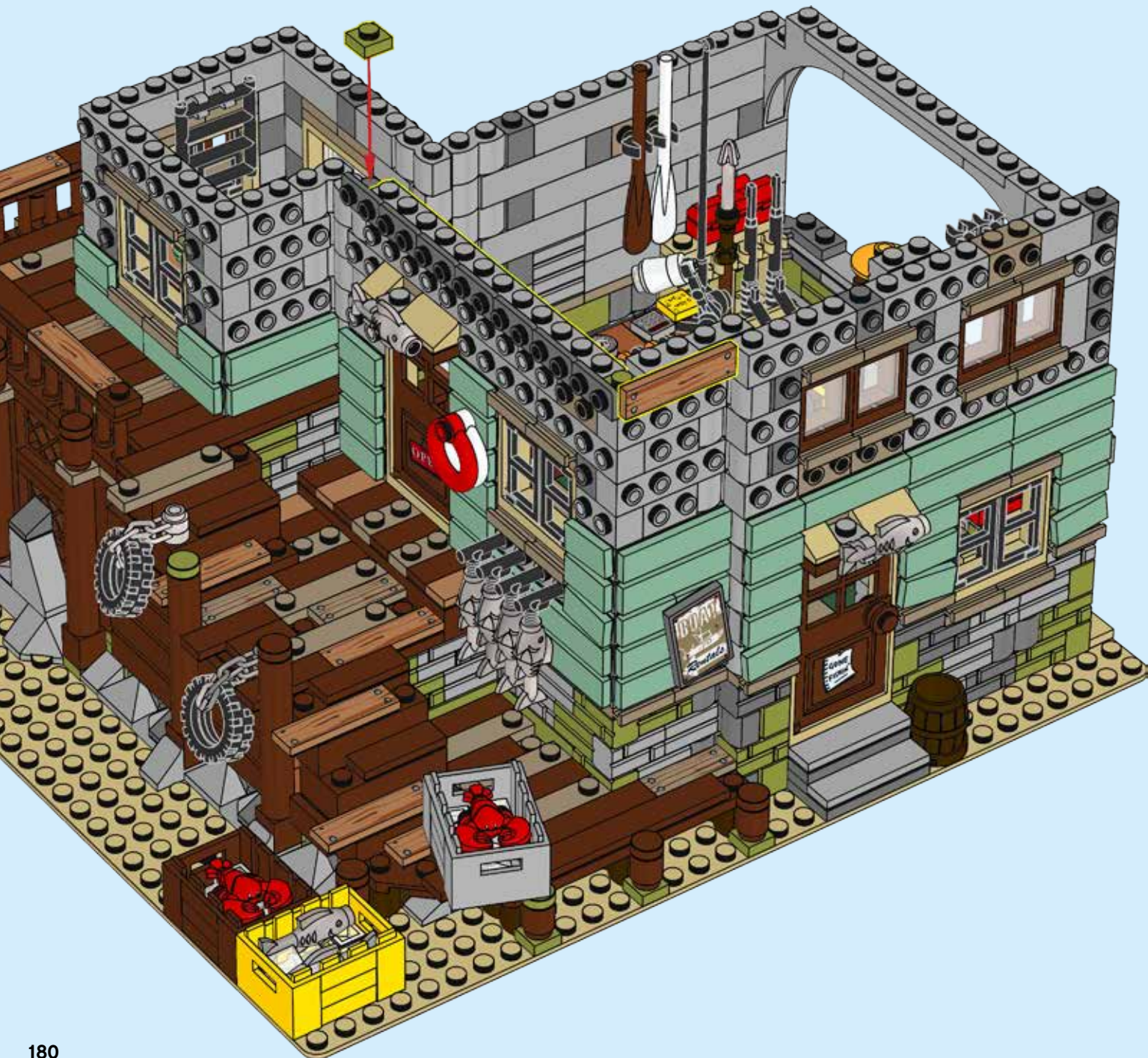

169



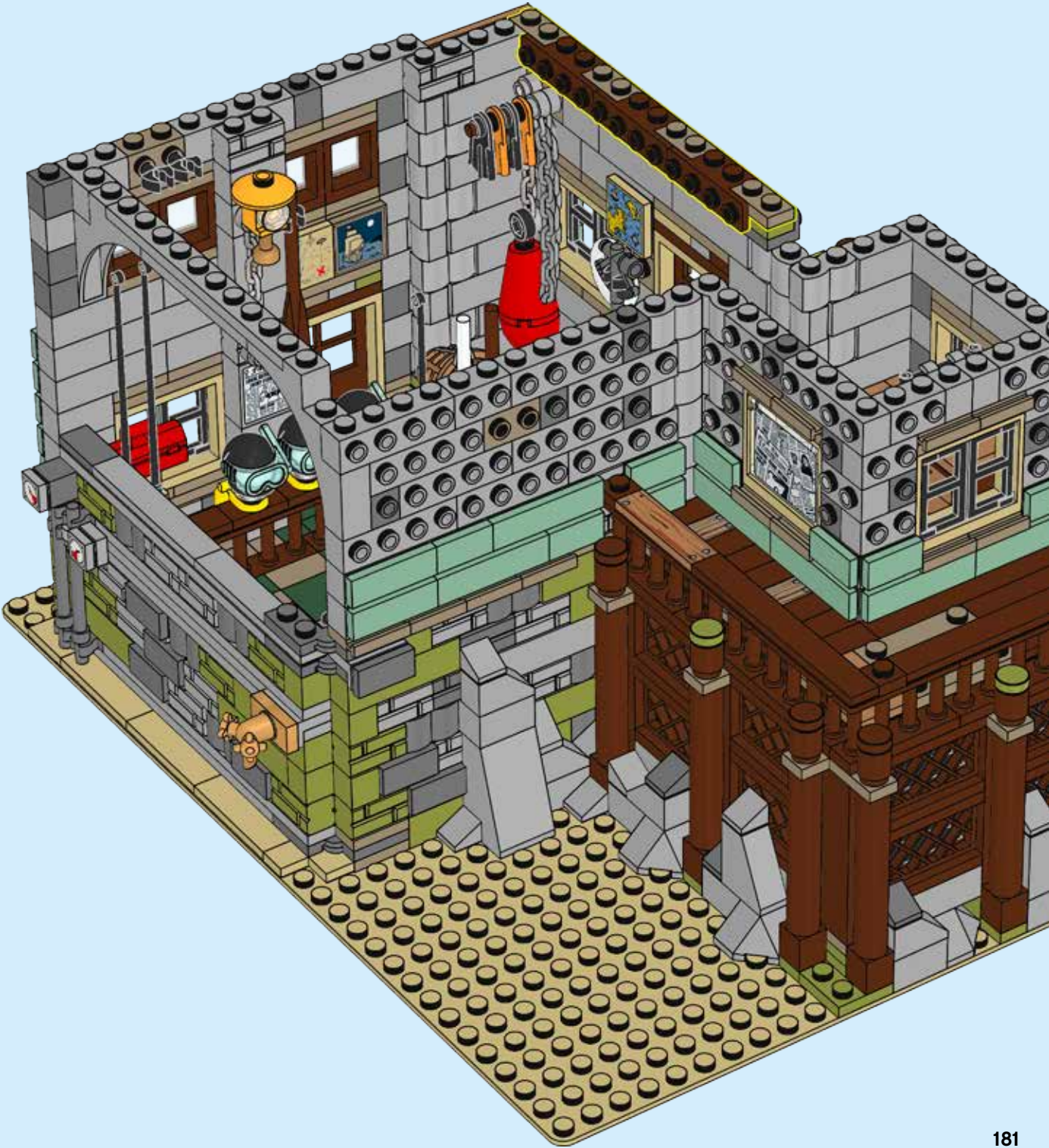

170



2x  3x 

171



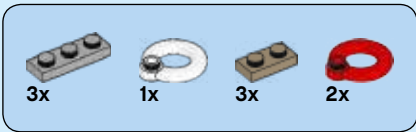

172

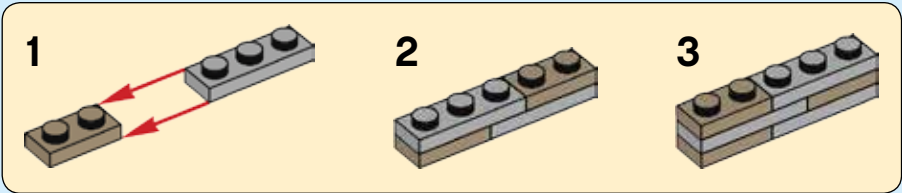
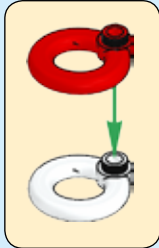

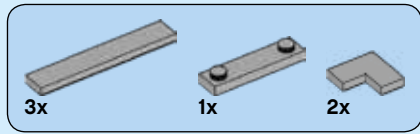

173



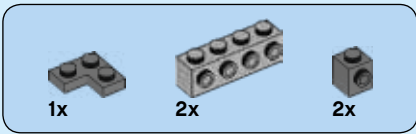

174

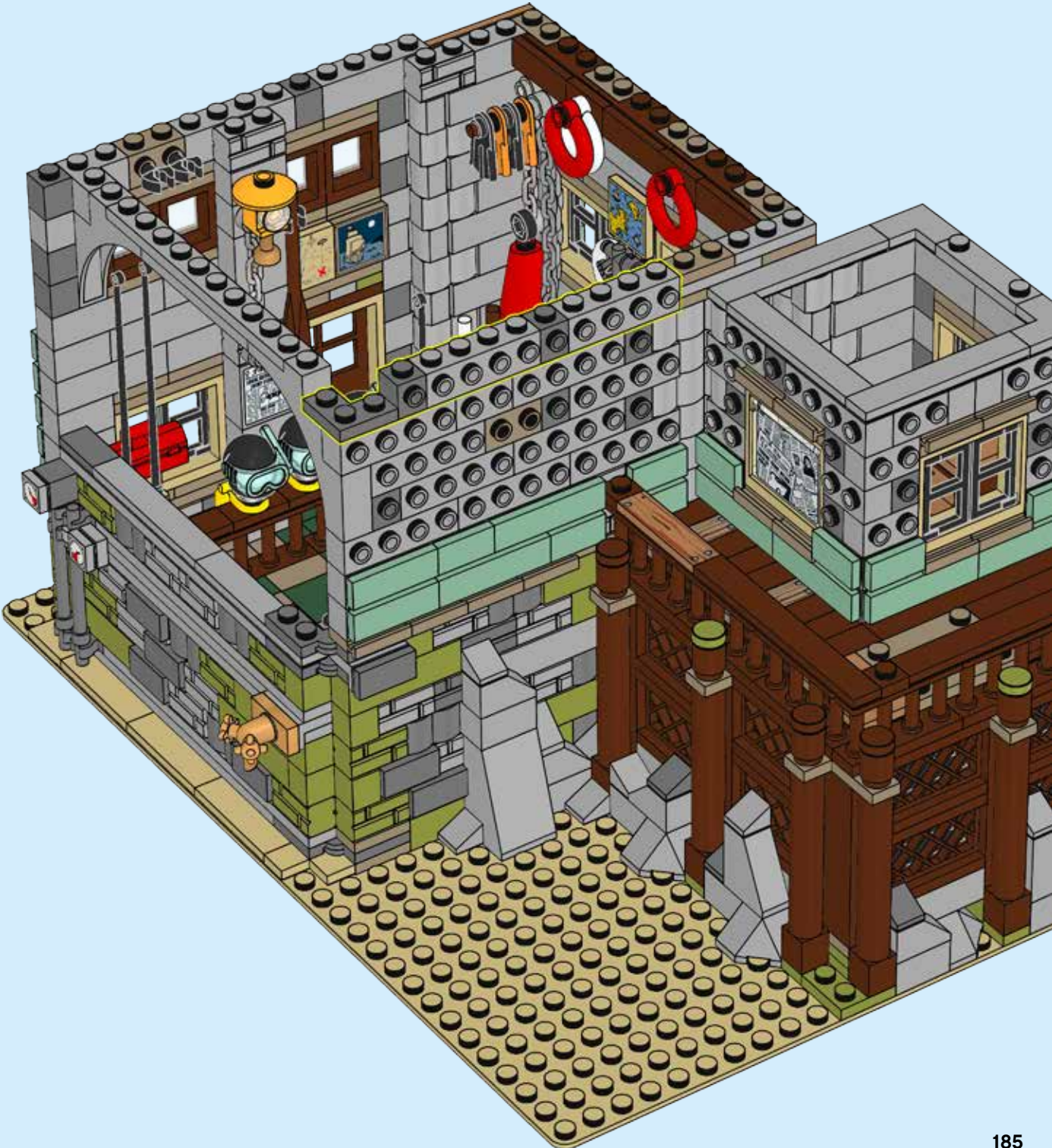

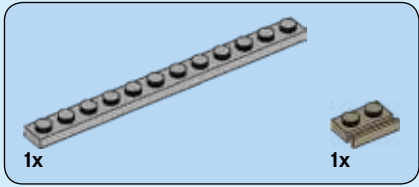

175

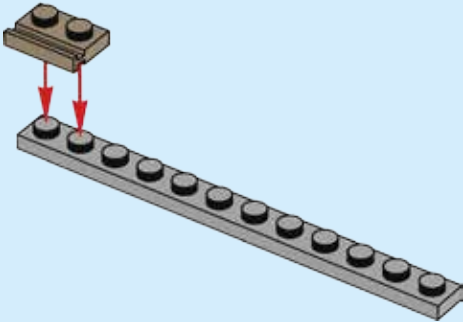

176

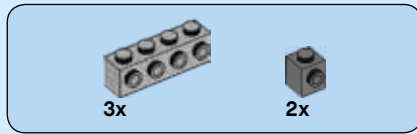
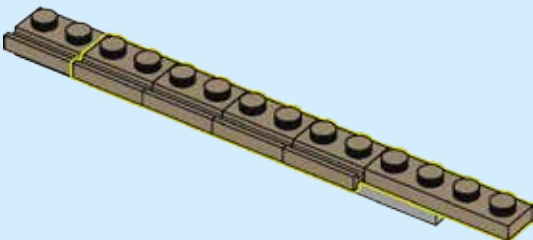

177

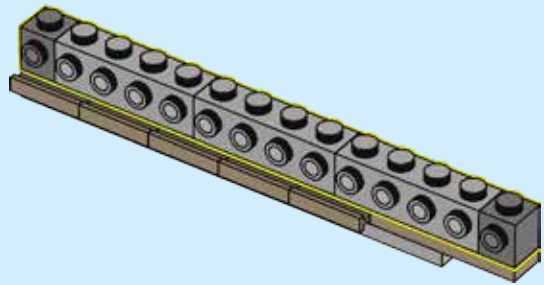

178

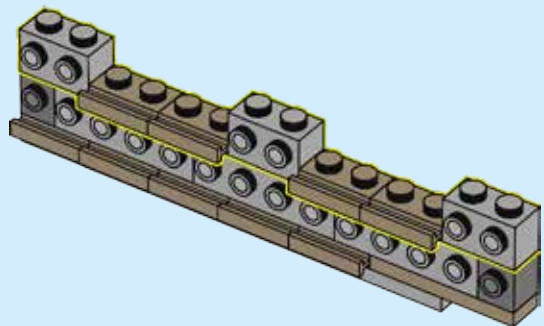



179

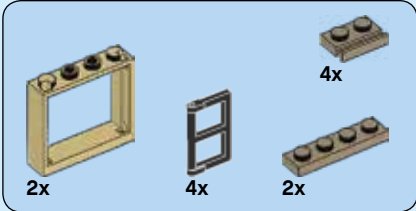
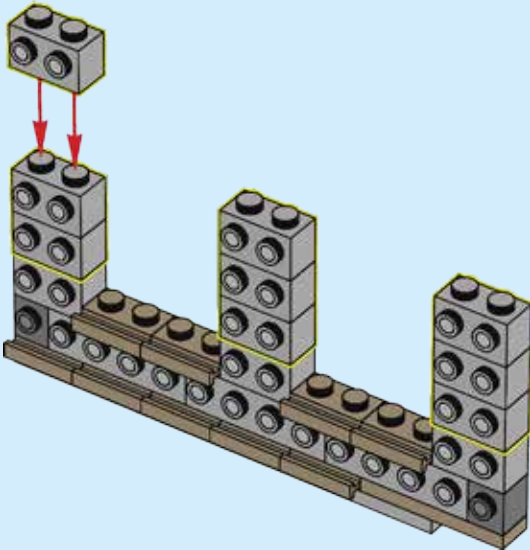

180

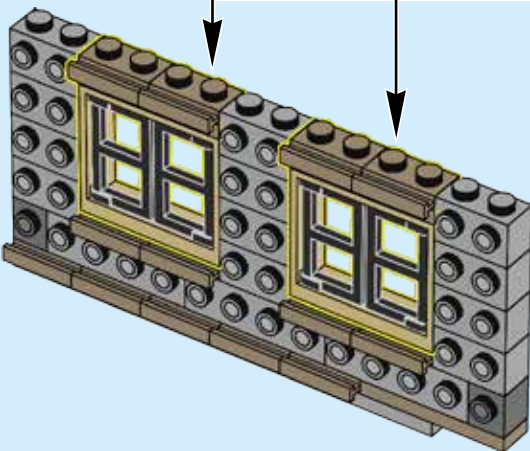
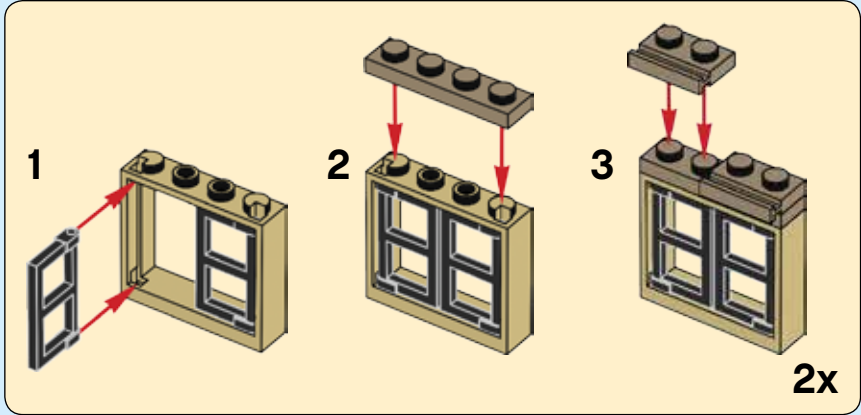

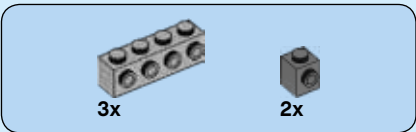

181

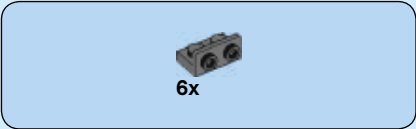
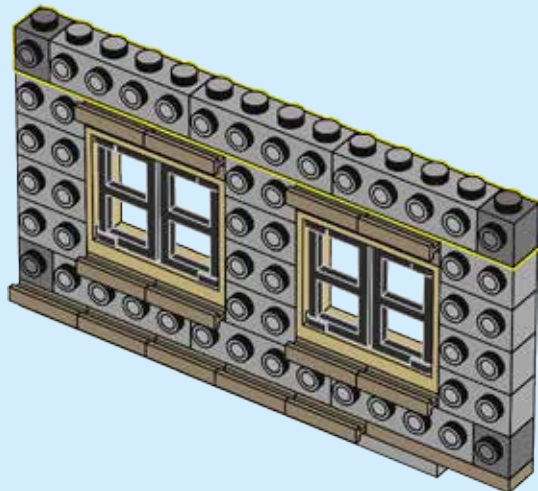

182

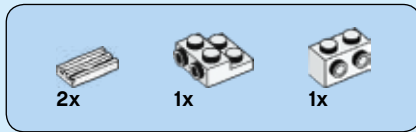
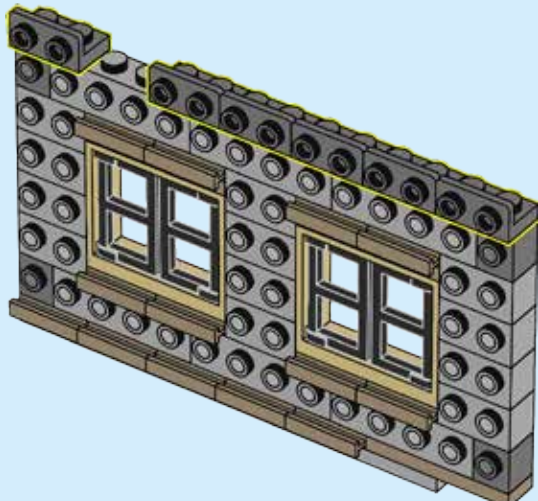

183

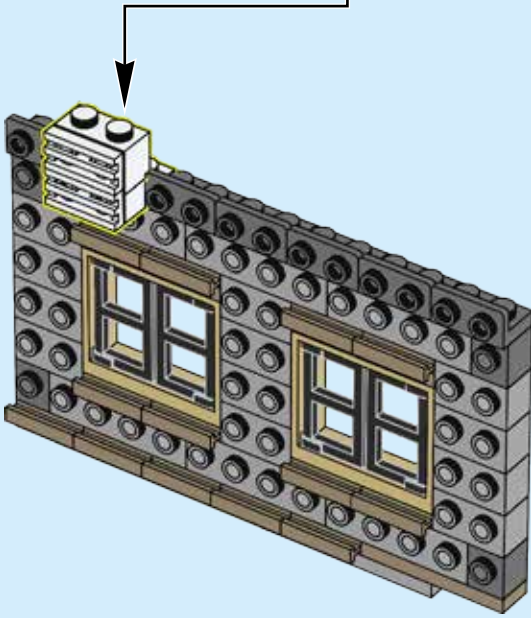
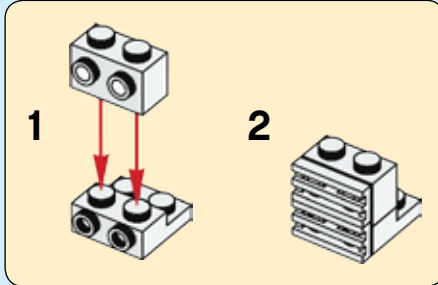

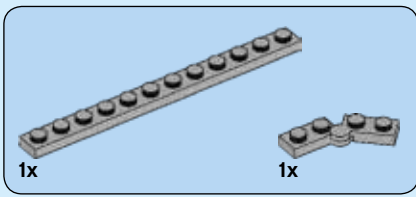

184

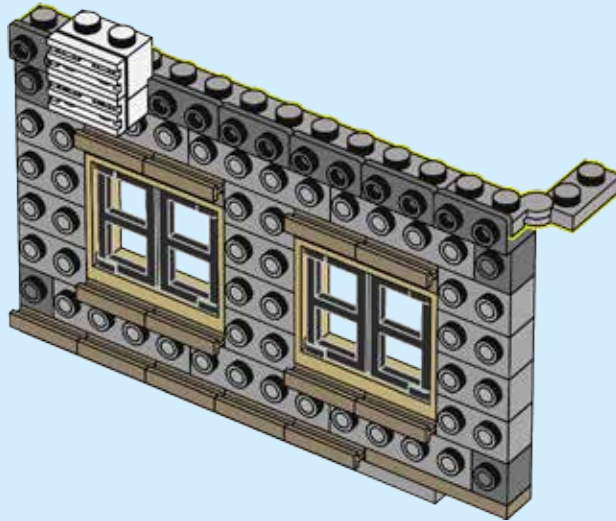

185

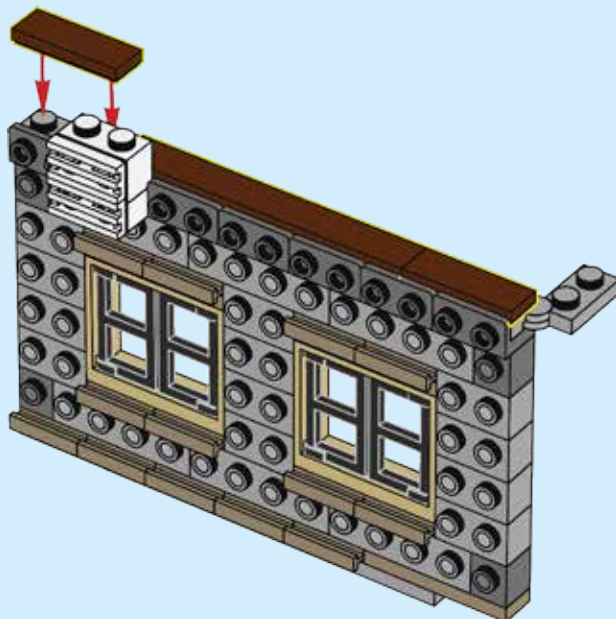

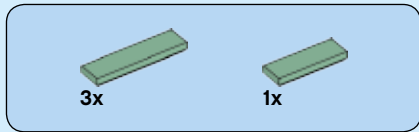

186

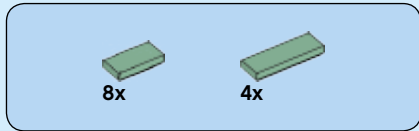
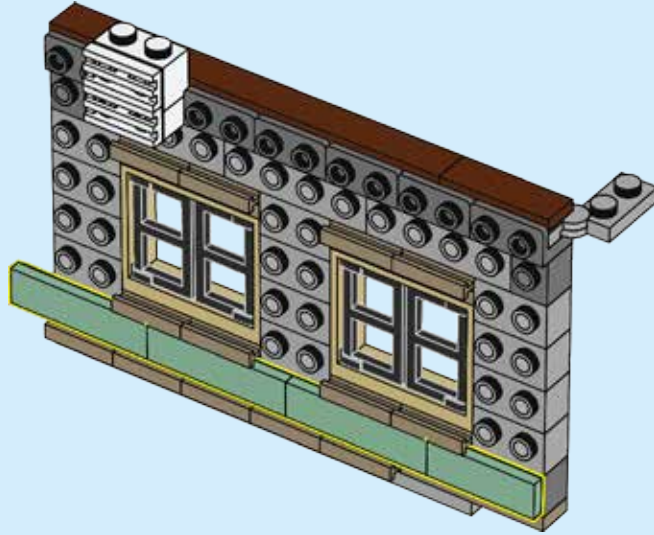

187

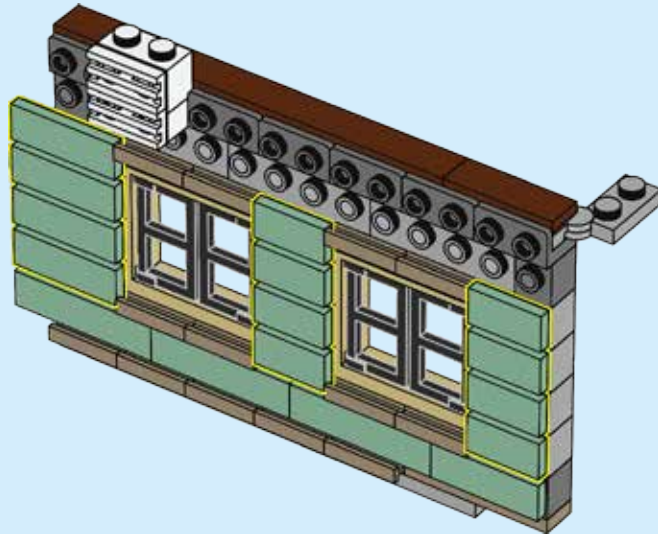

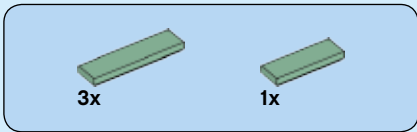

188

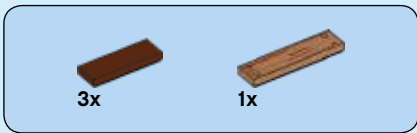
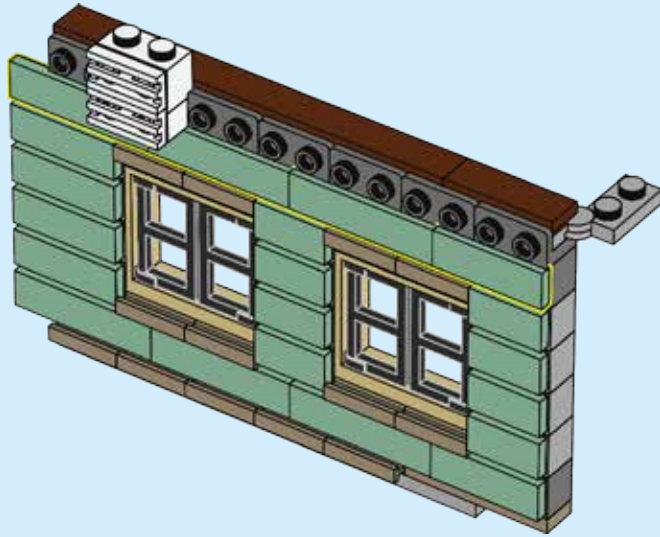

189

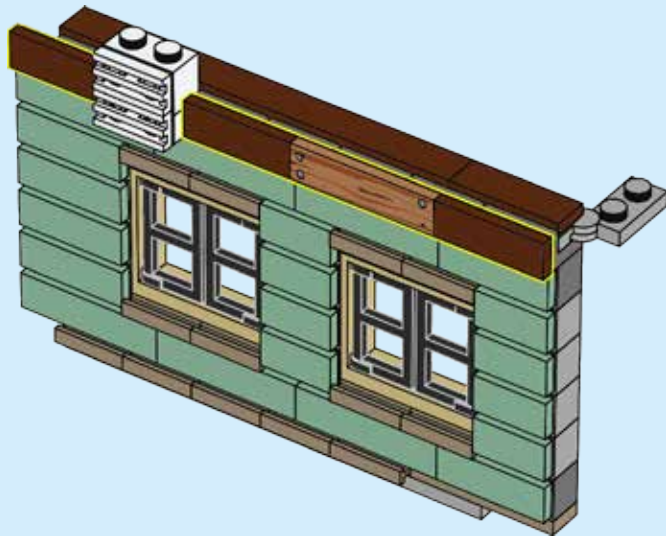



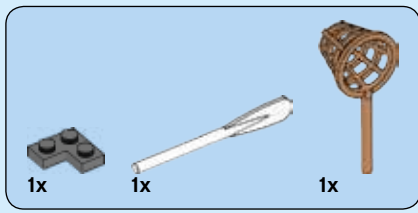

191

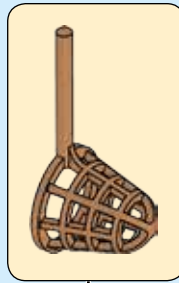
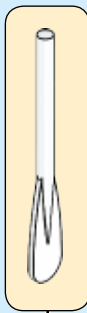



192

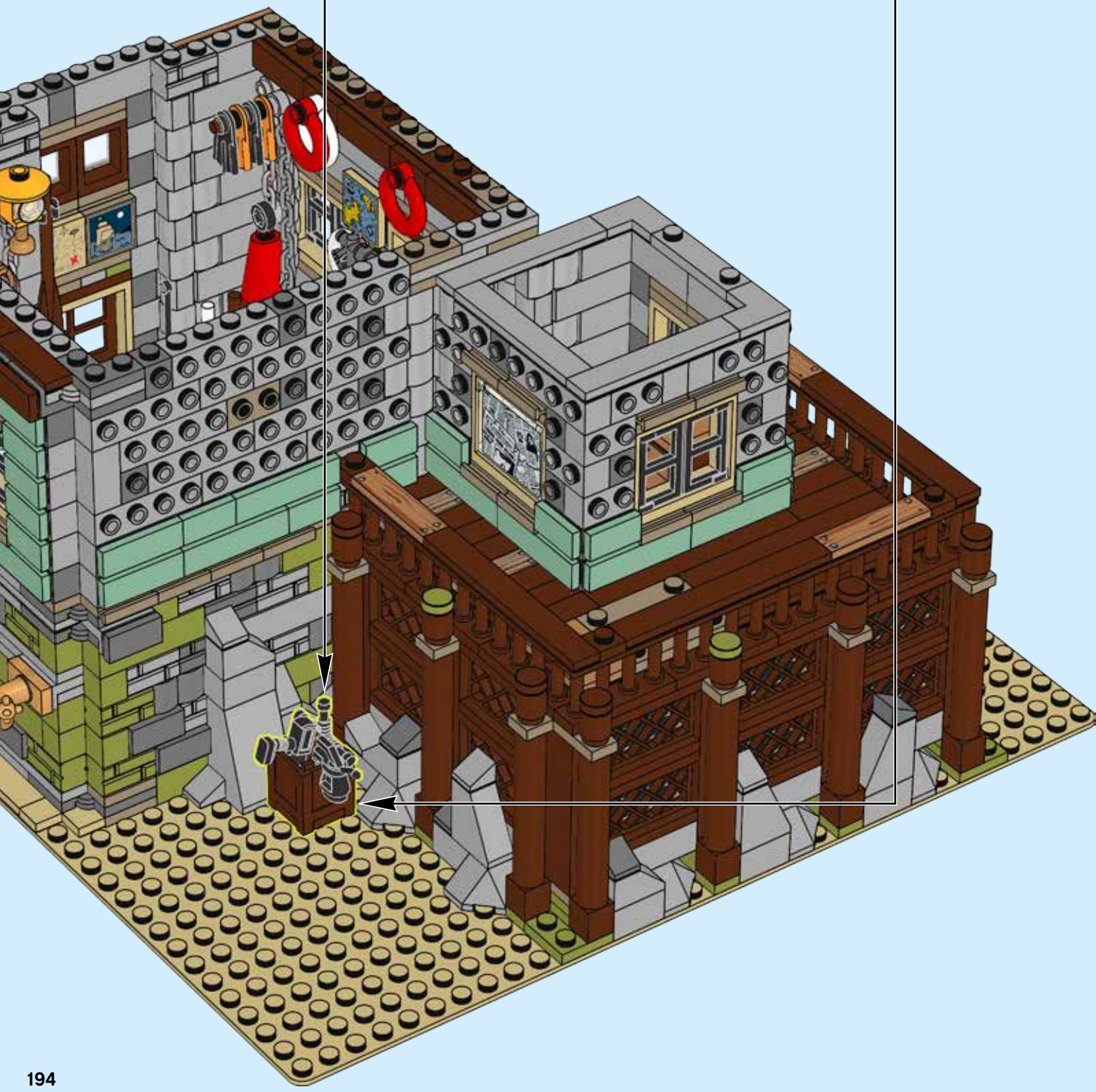
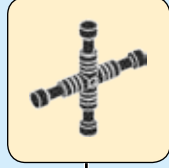
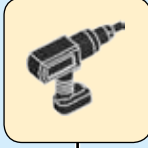

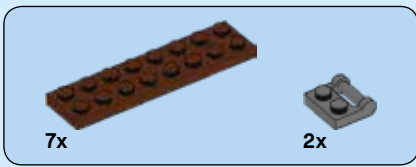

193





194



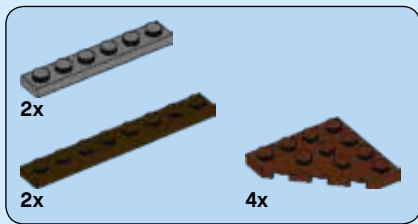

195



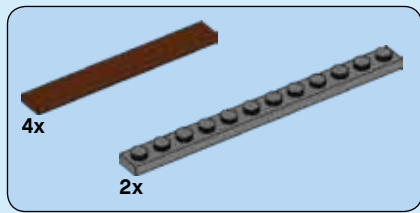

196



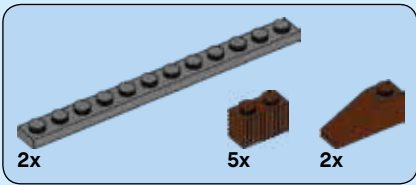

197

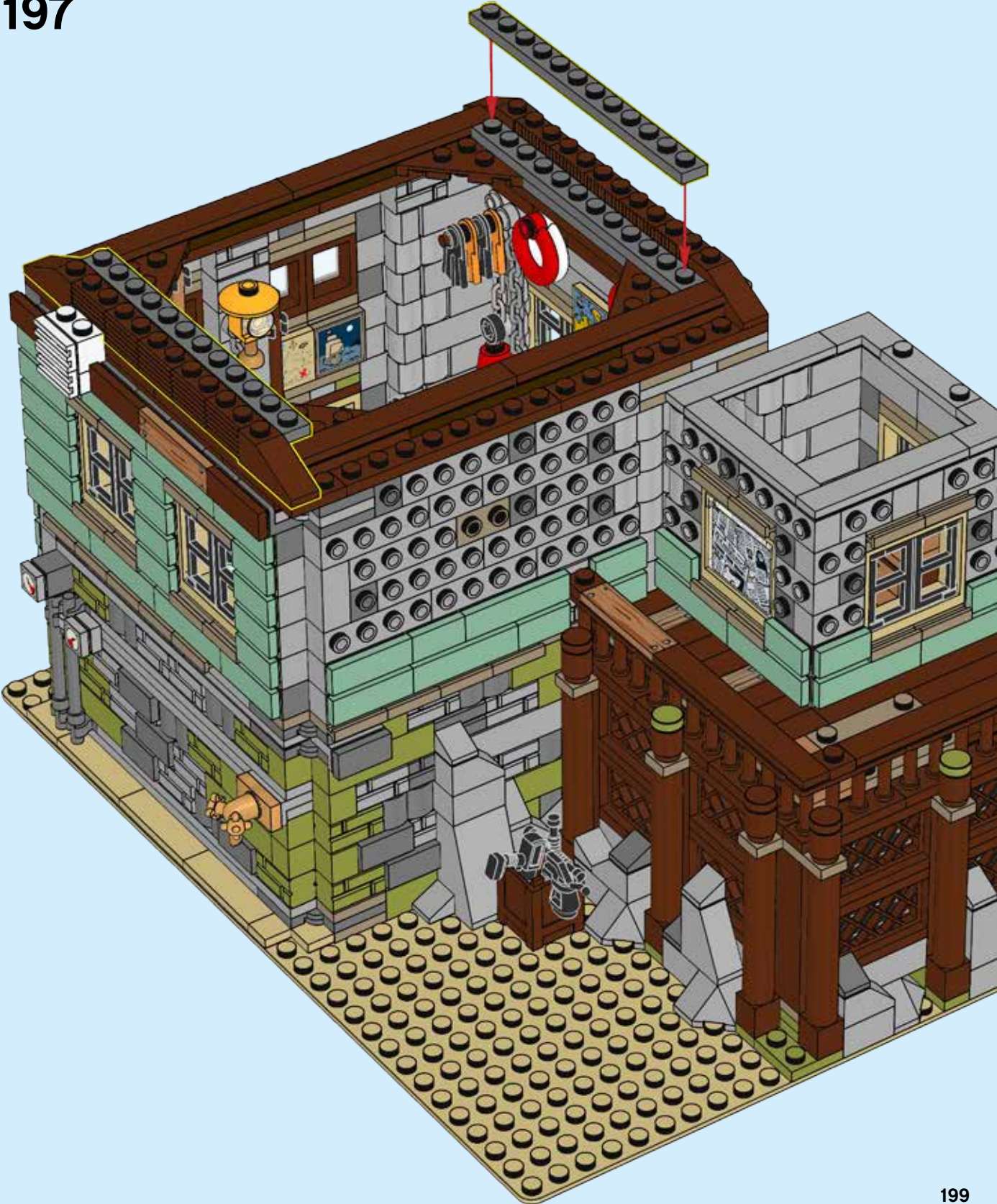

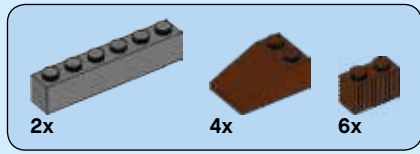

198



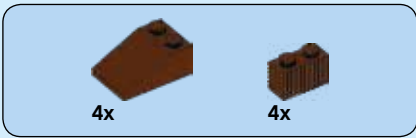

199

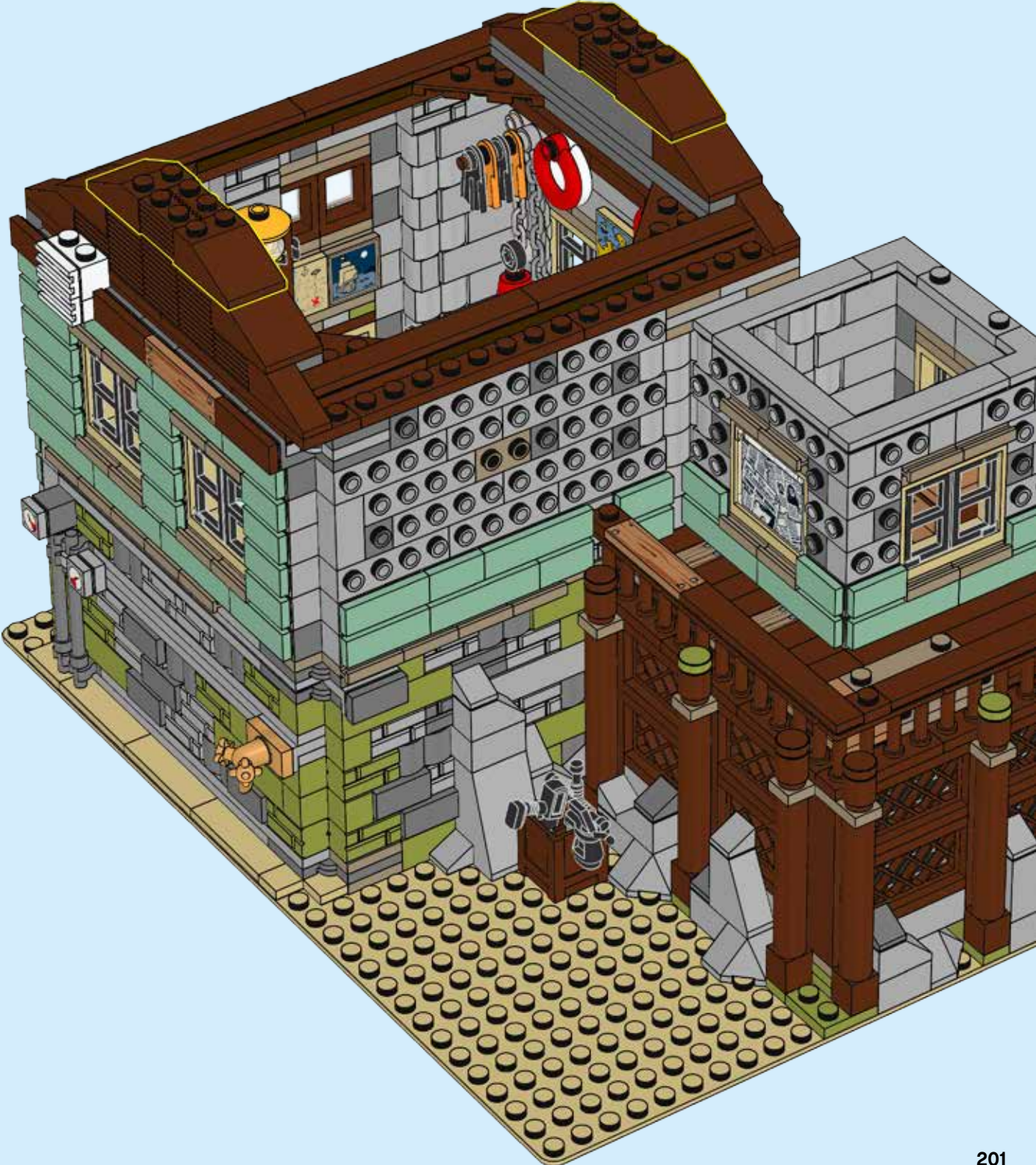

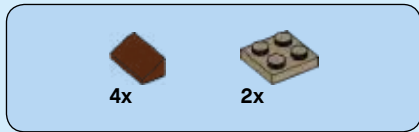

200



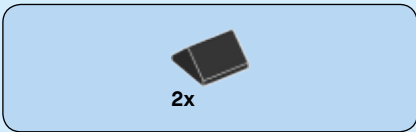

201

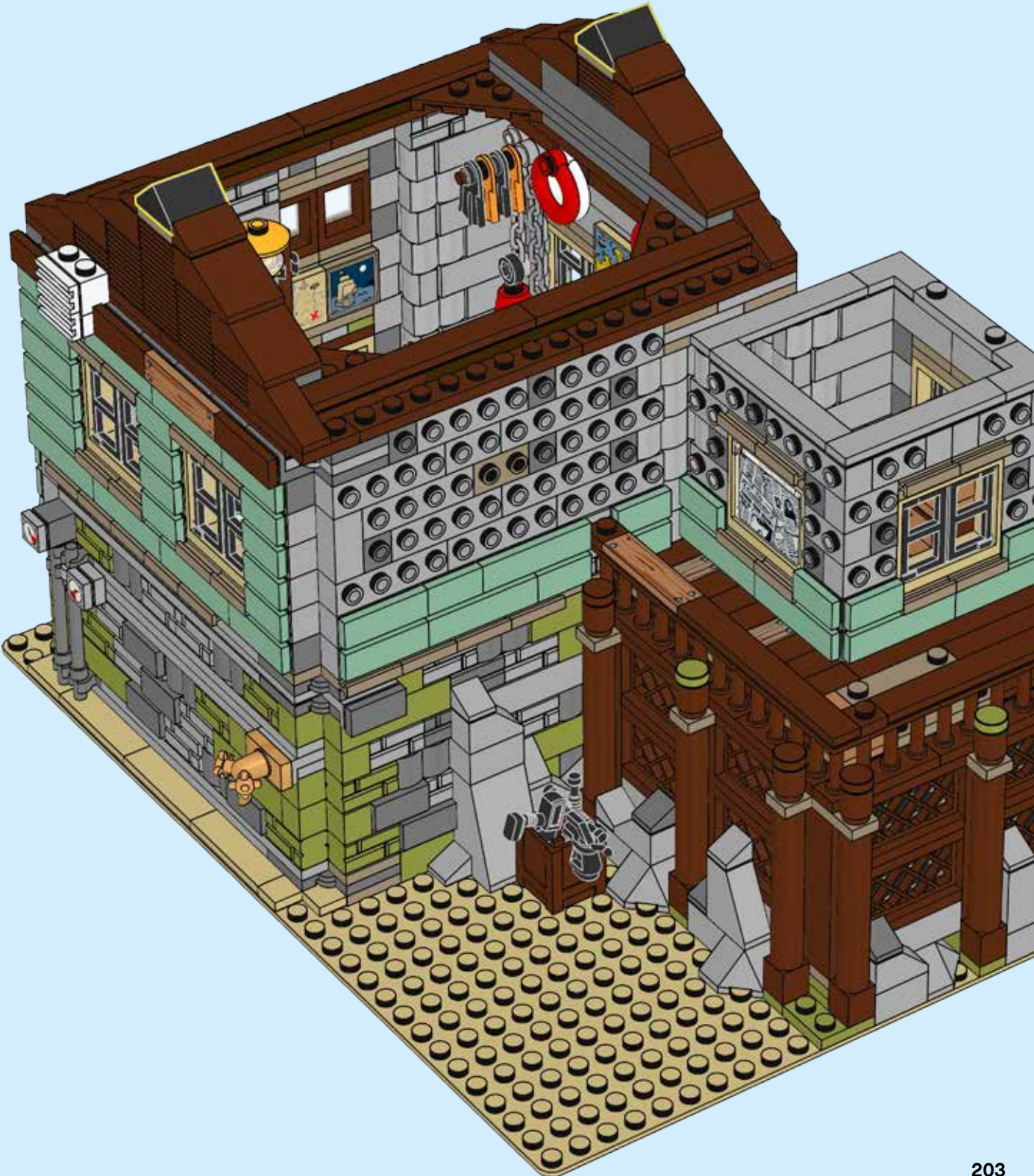

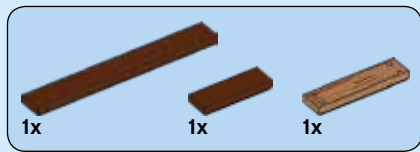

202

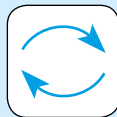



6



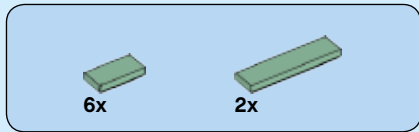

203



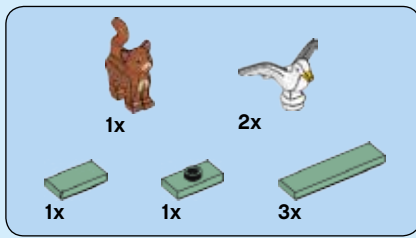

204



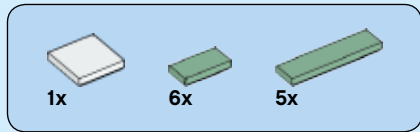

205

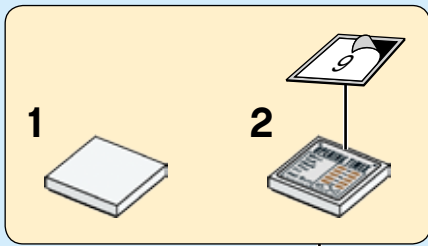

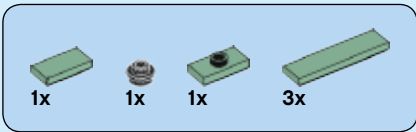

206

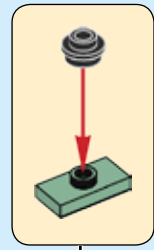

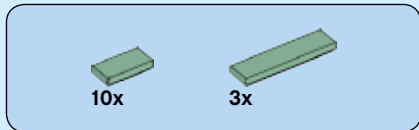

207

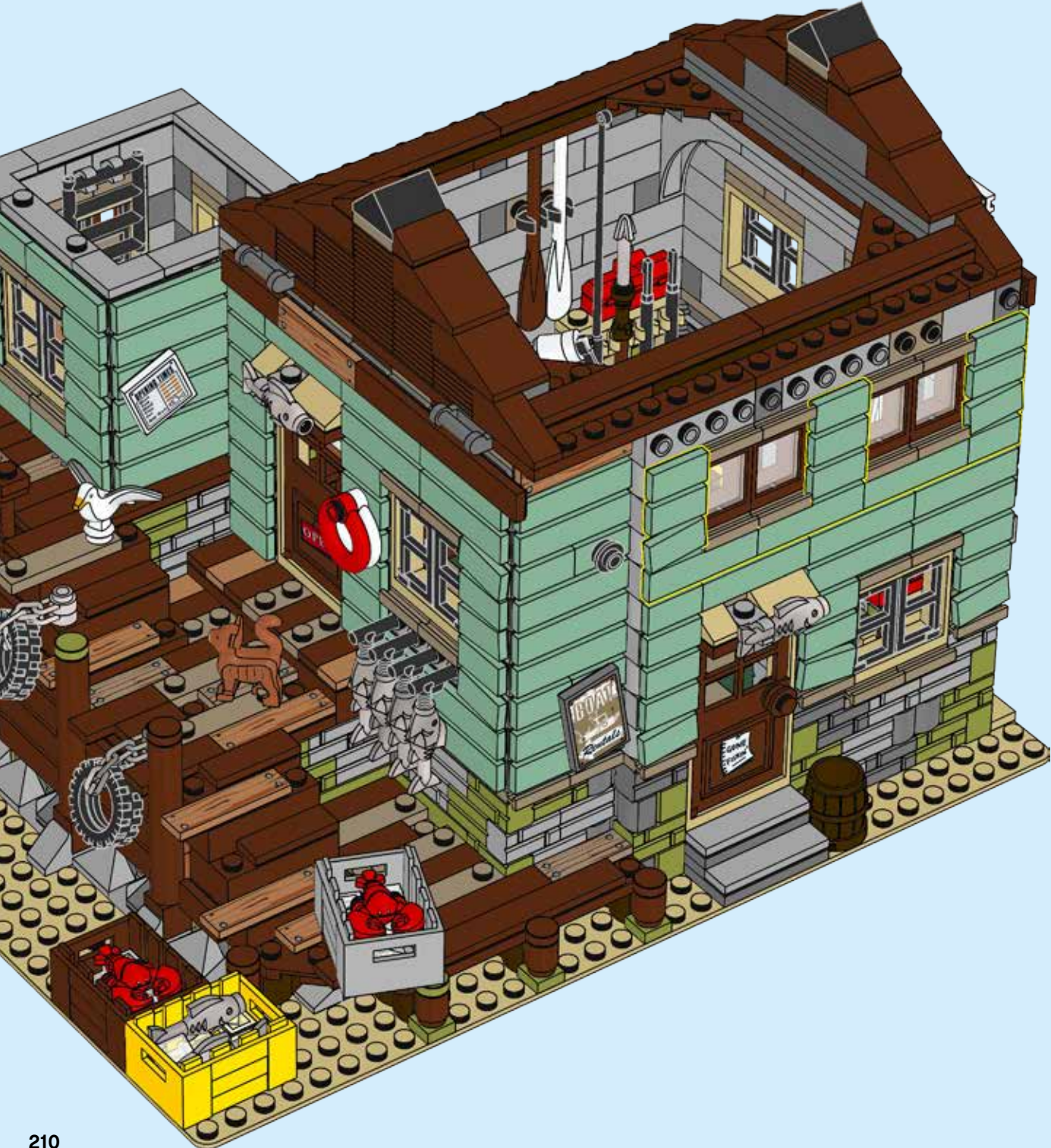

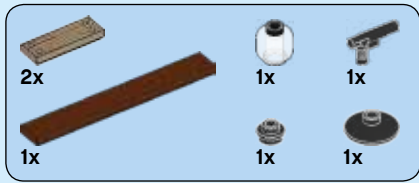

208

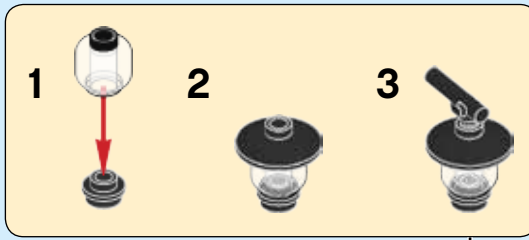

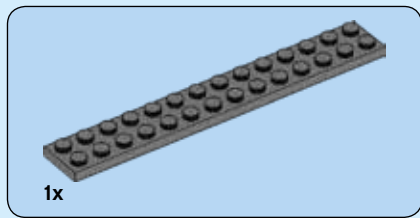

209

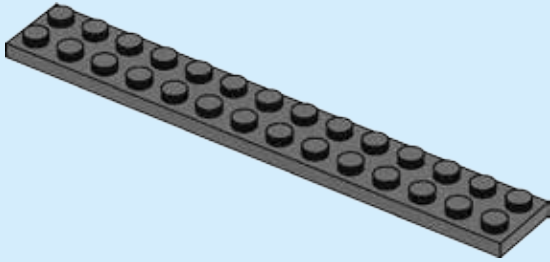

210

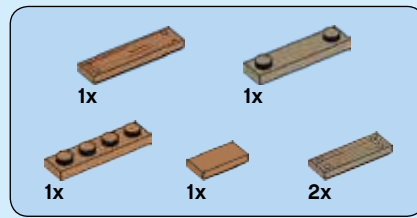
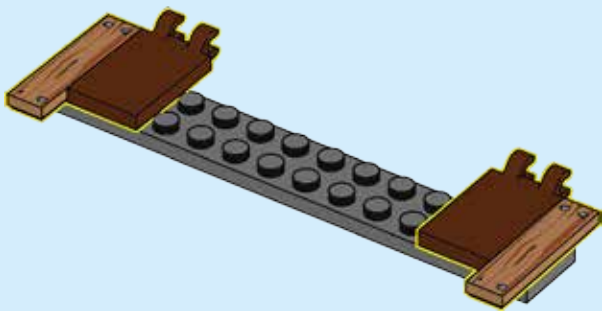

211

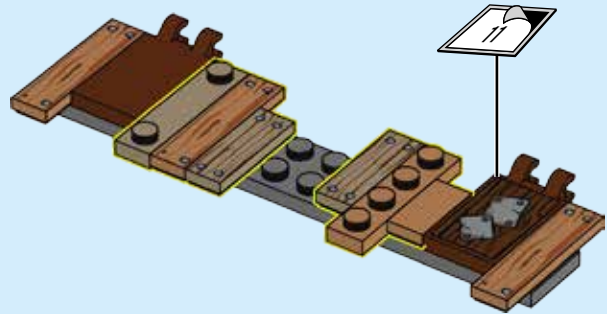



212

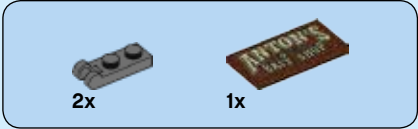
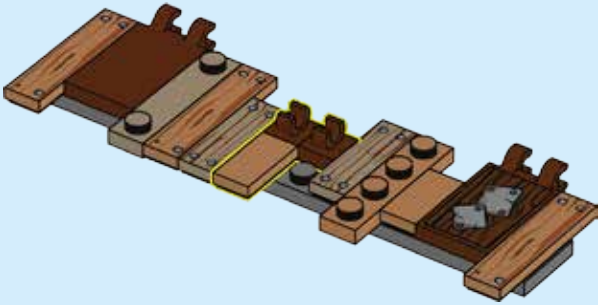

213

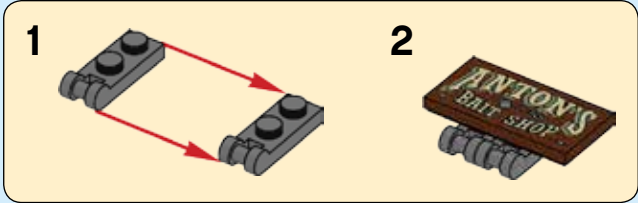

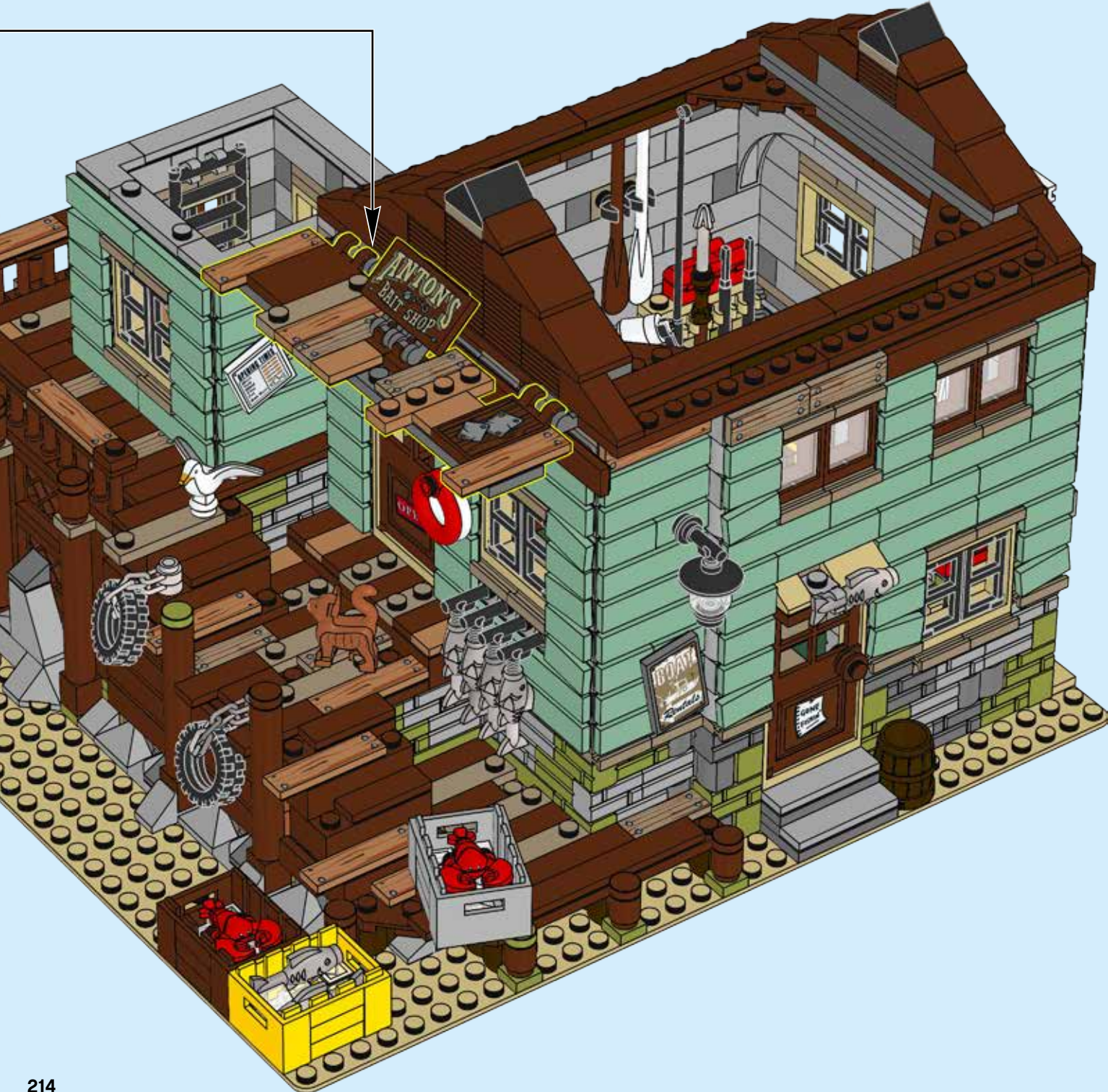

11x 1x 4x

215

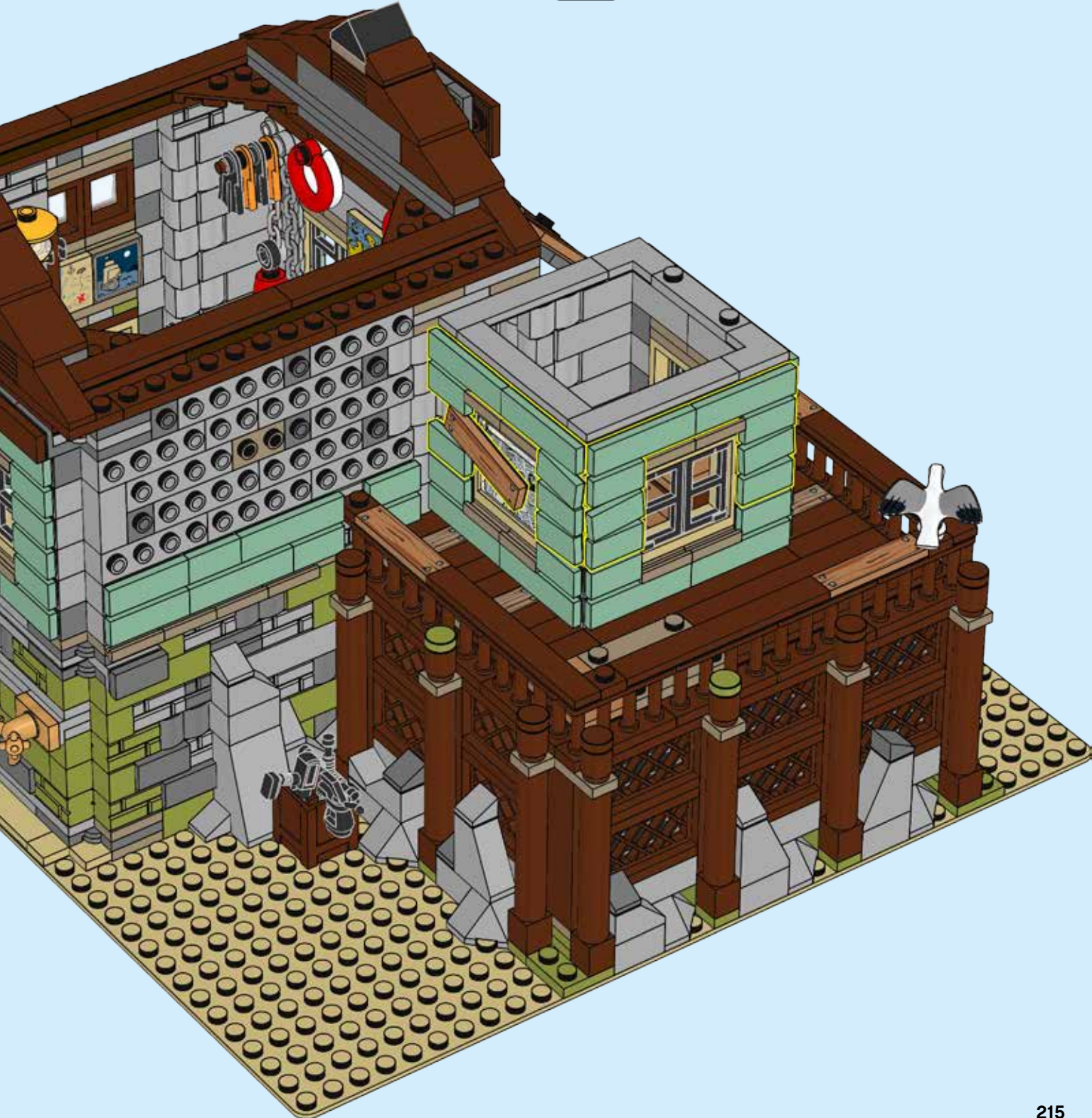
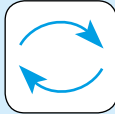

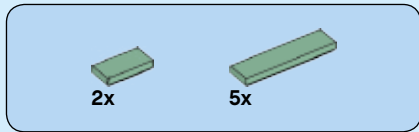

216

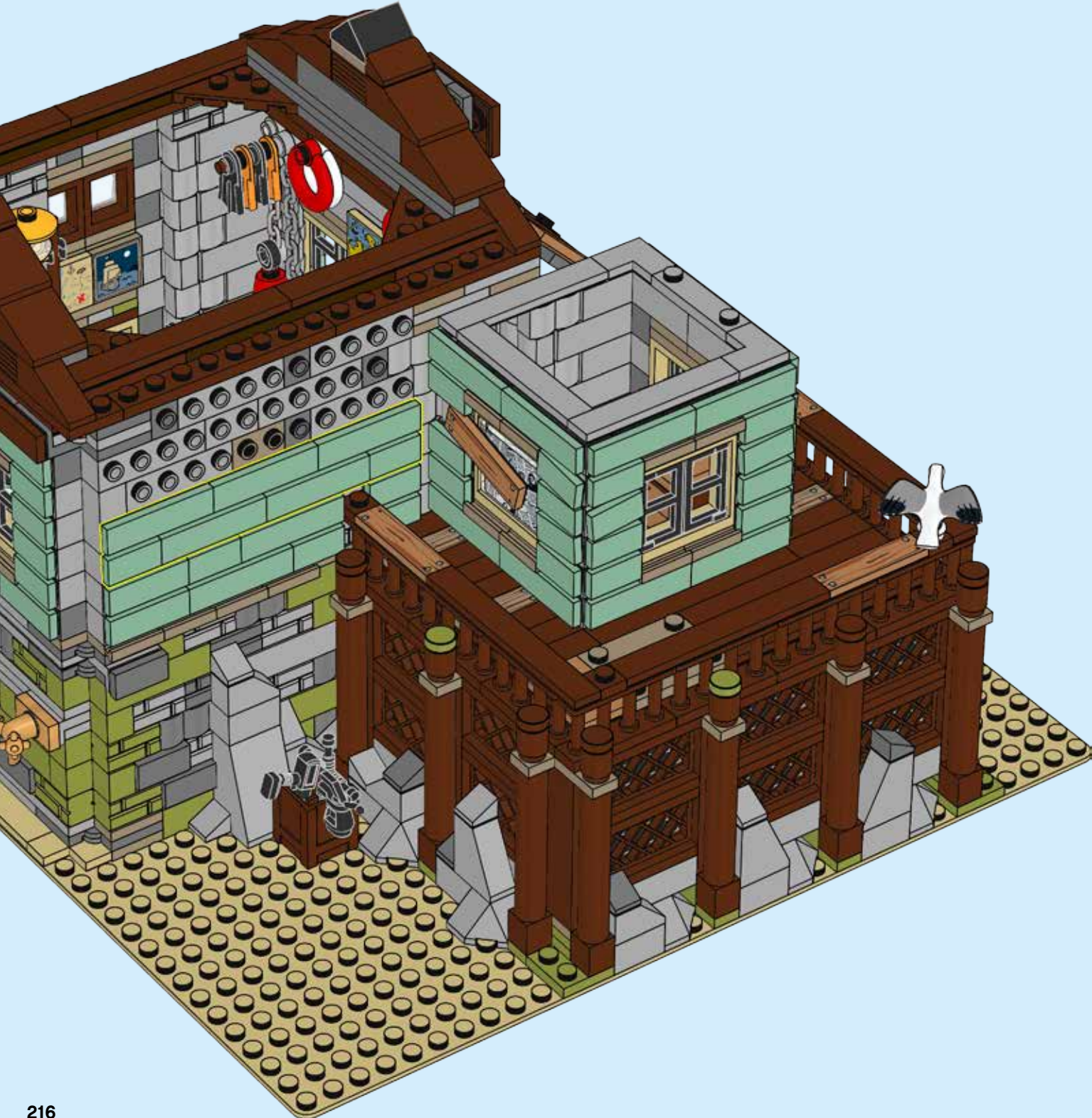

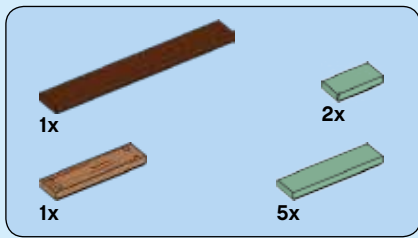

217



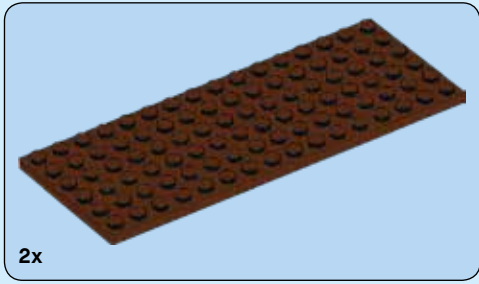
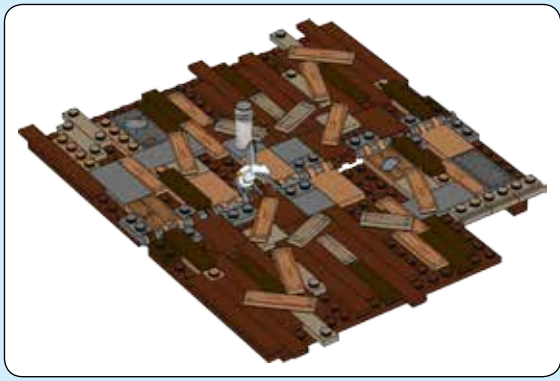

218

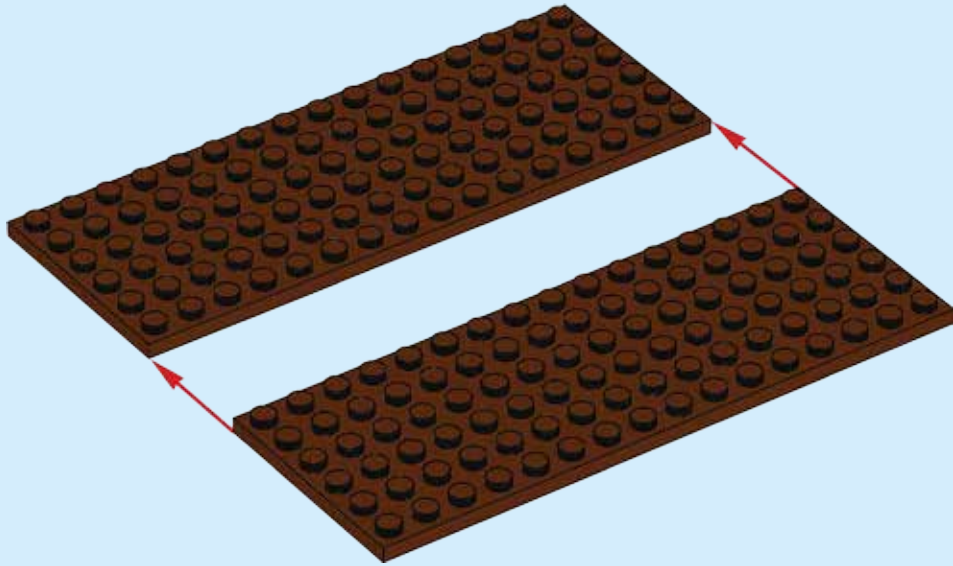

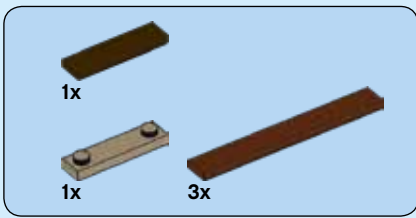

219

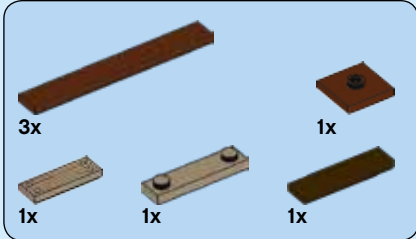
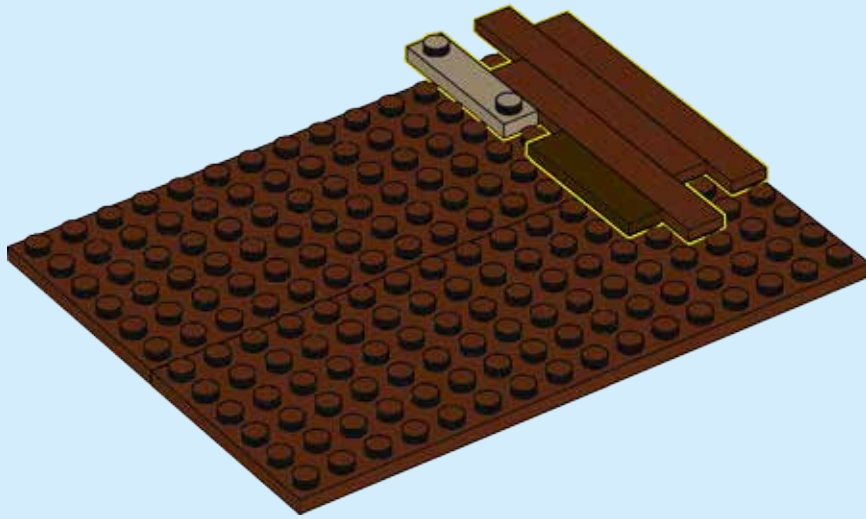

220

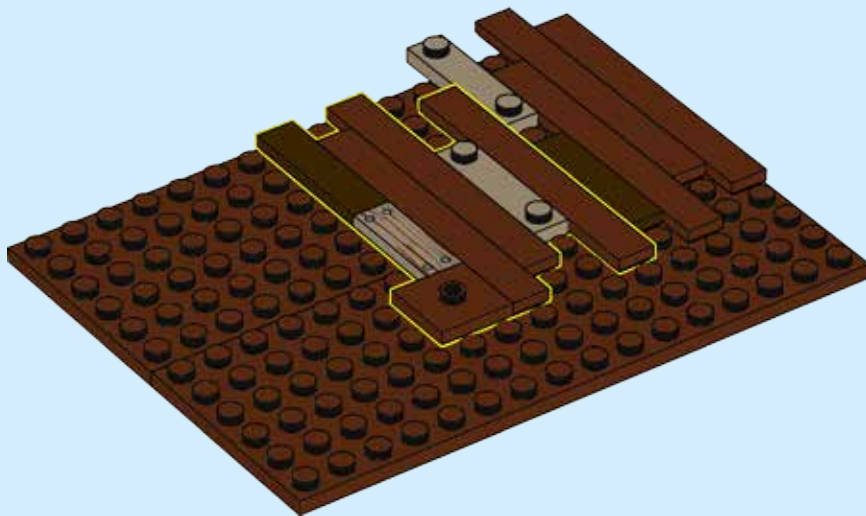

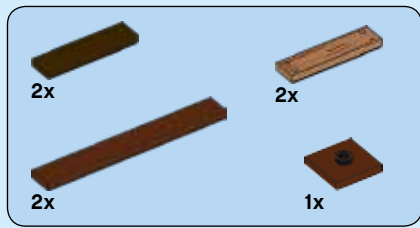

221

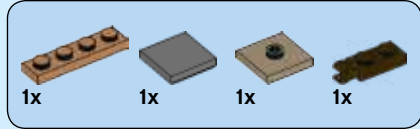
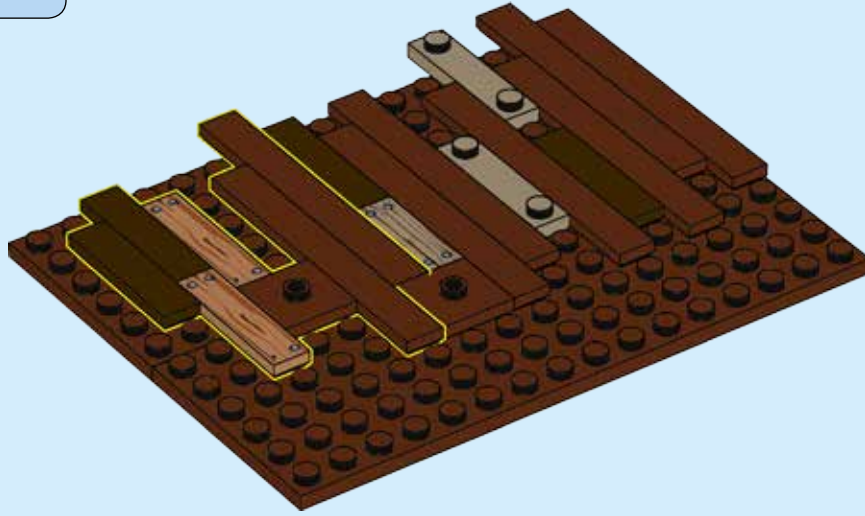

222

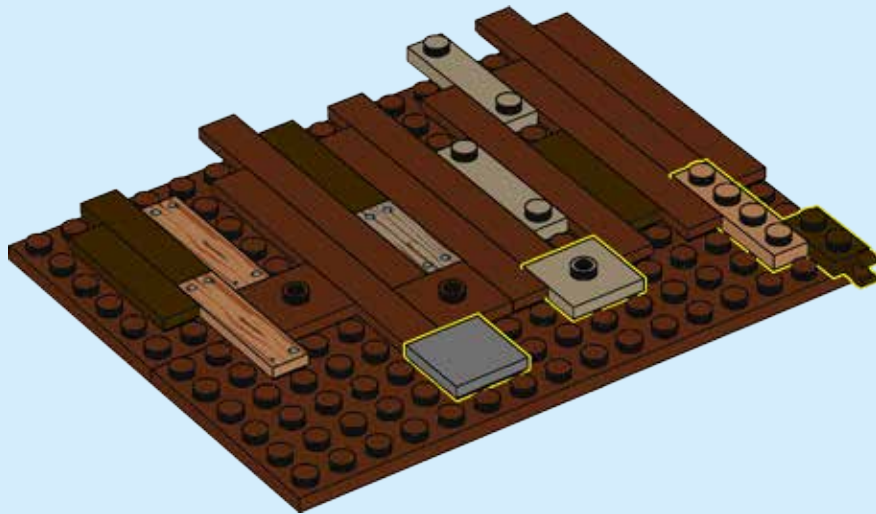

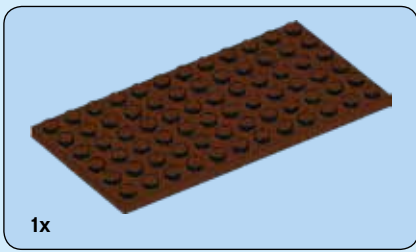

1x

223

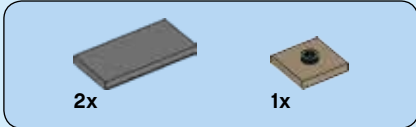
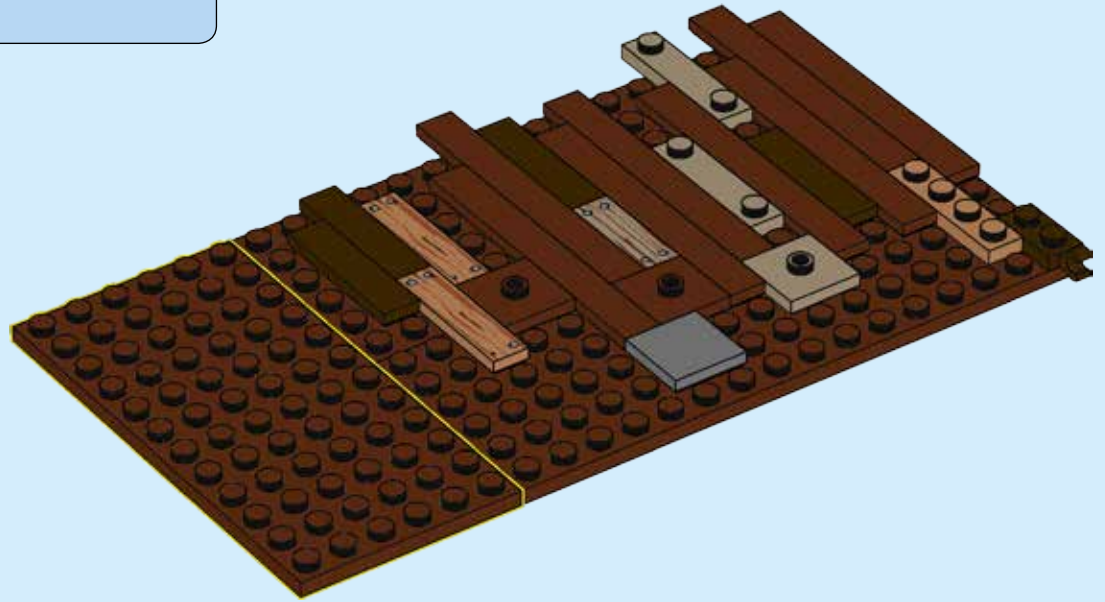

2x

1x

224

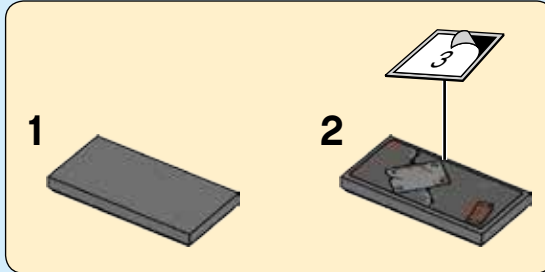

1

2

3

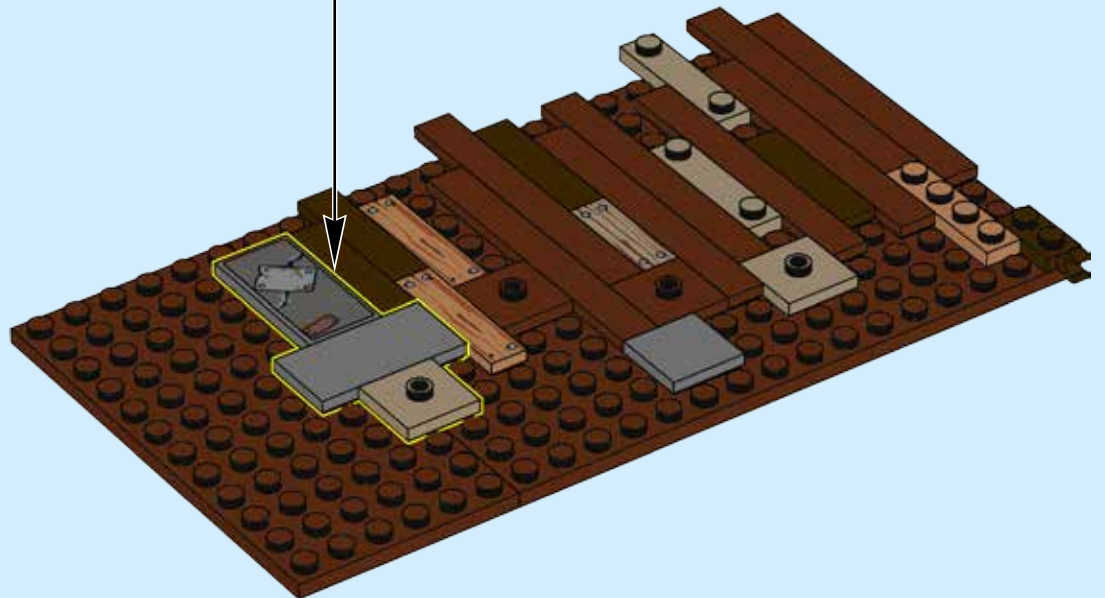

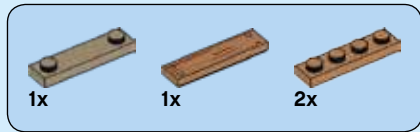

225

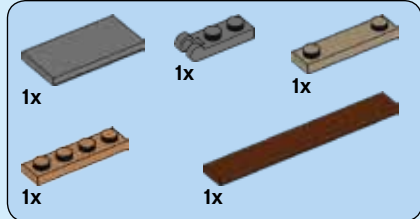
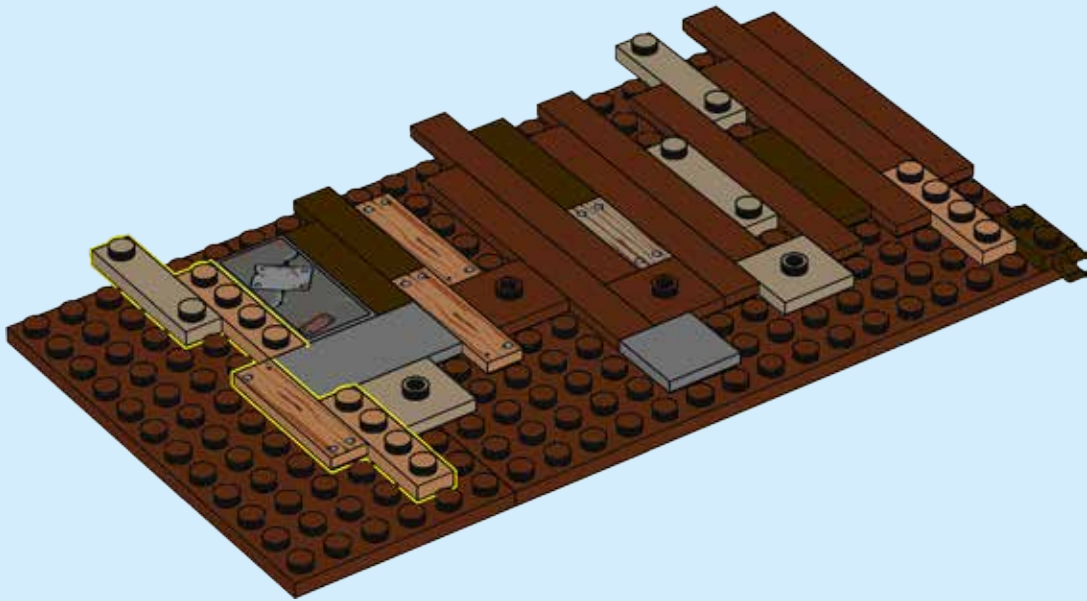

226

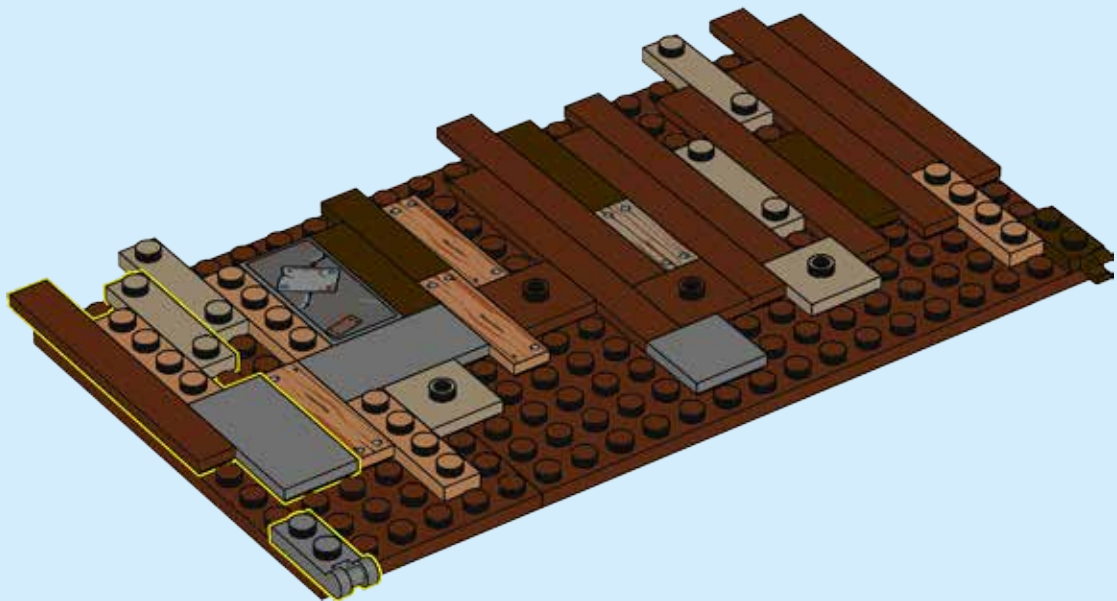

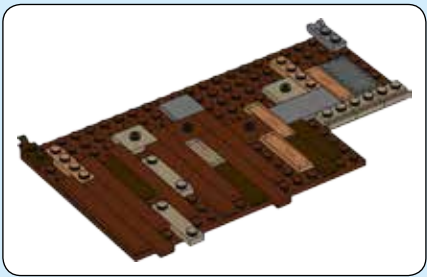

227

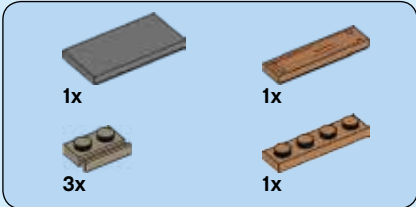

228

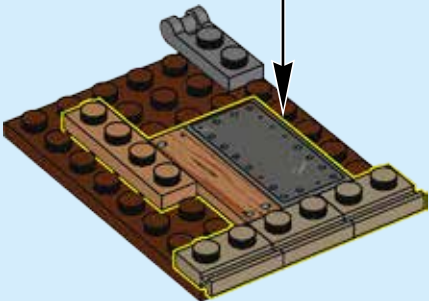
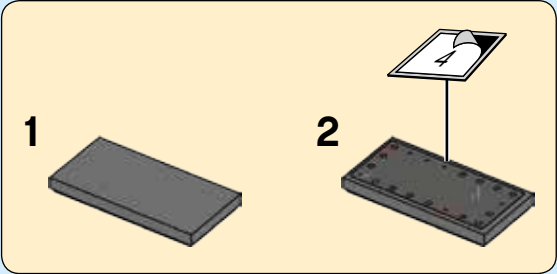

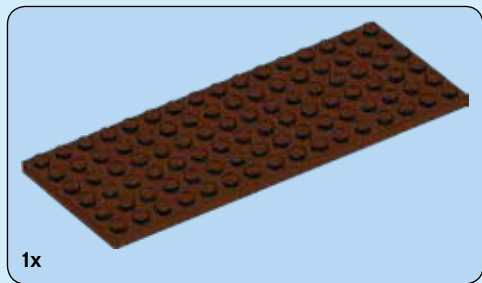

229

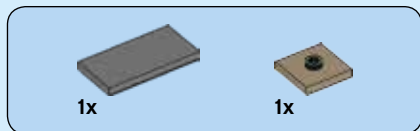
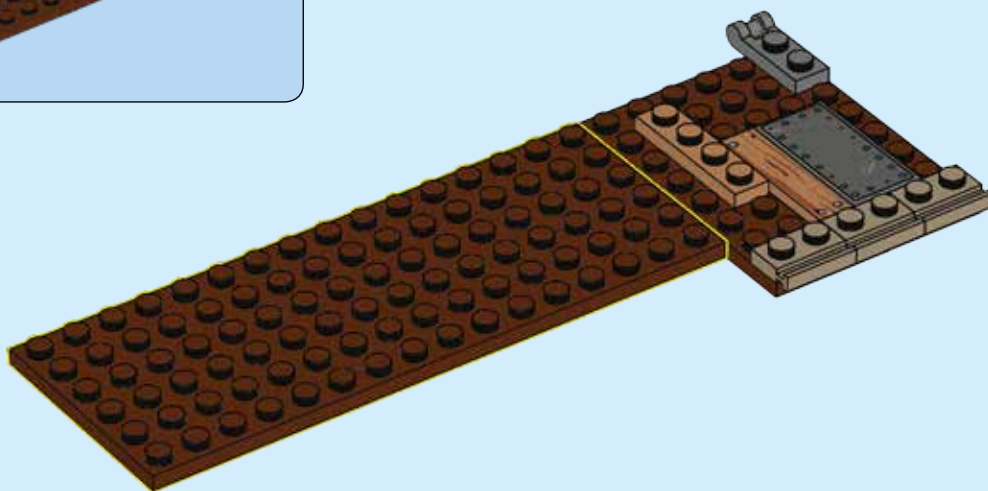

230

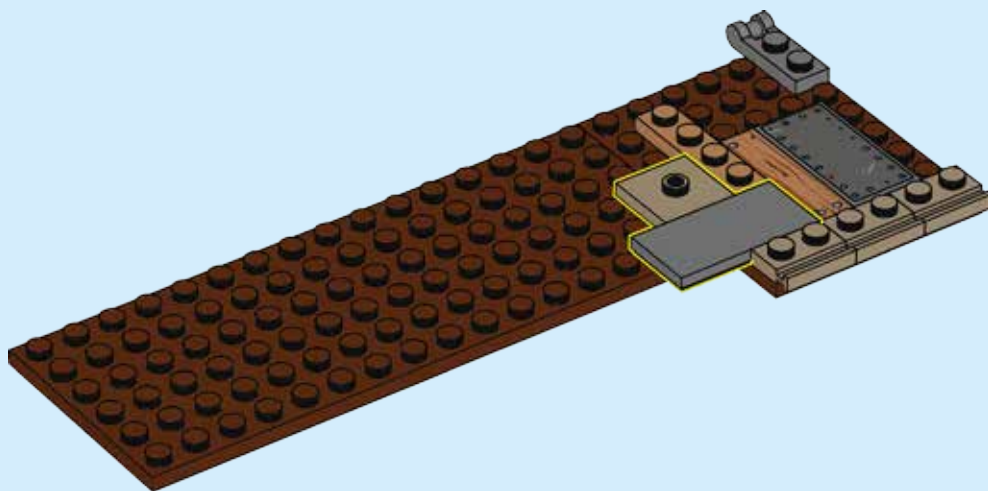

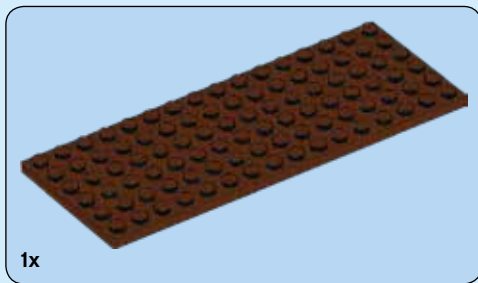

231

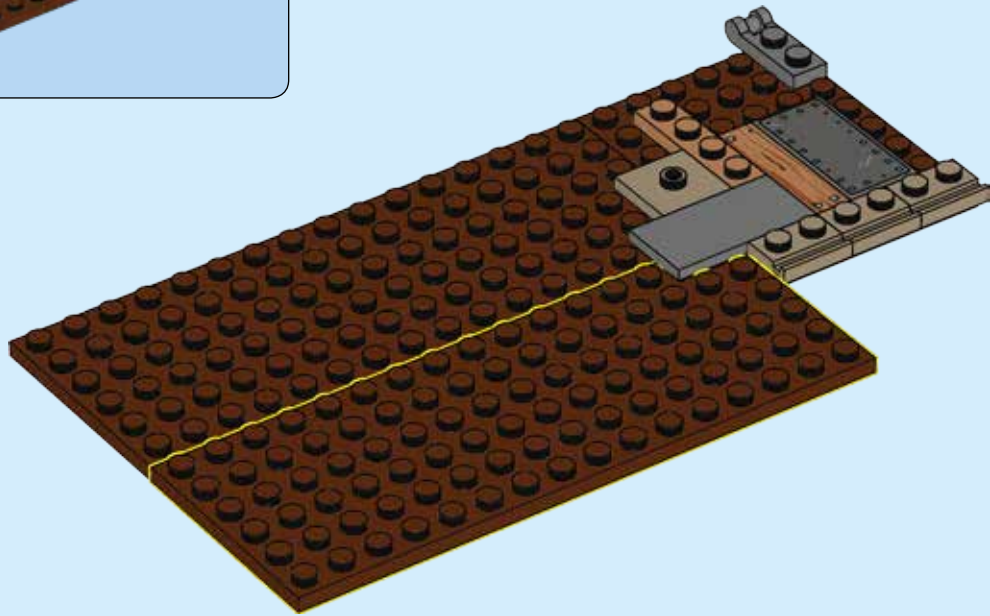

232

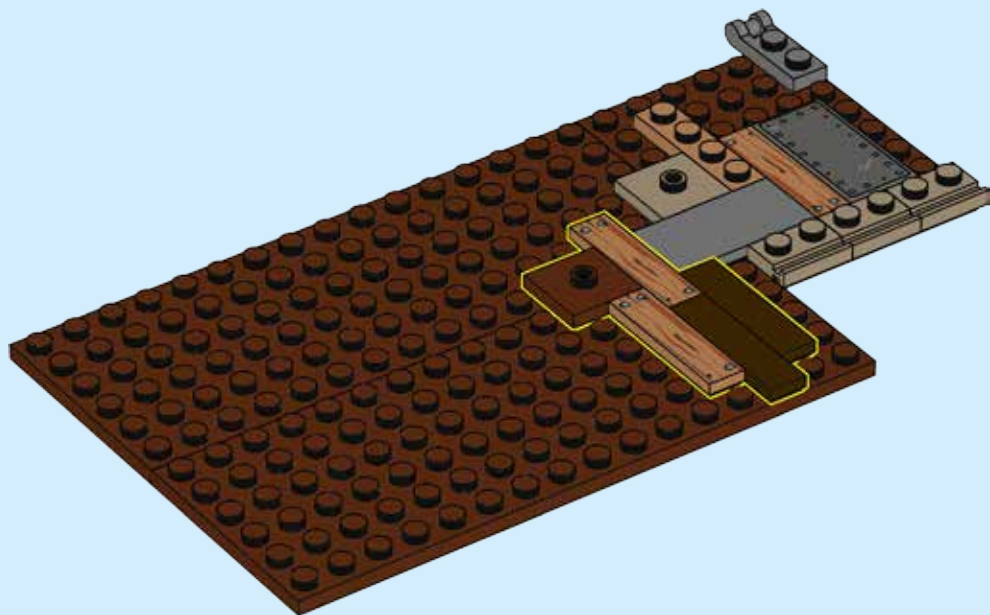

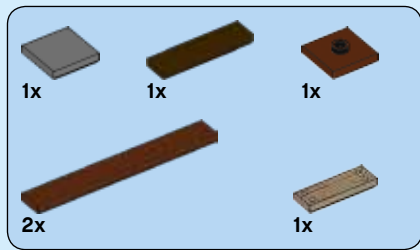

233

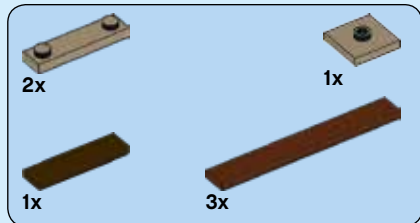
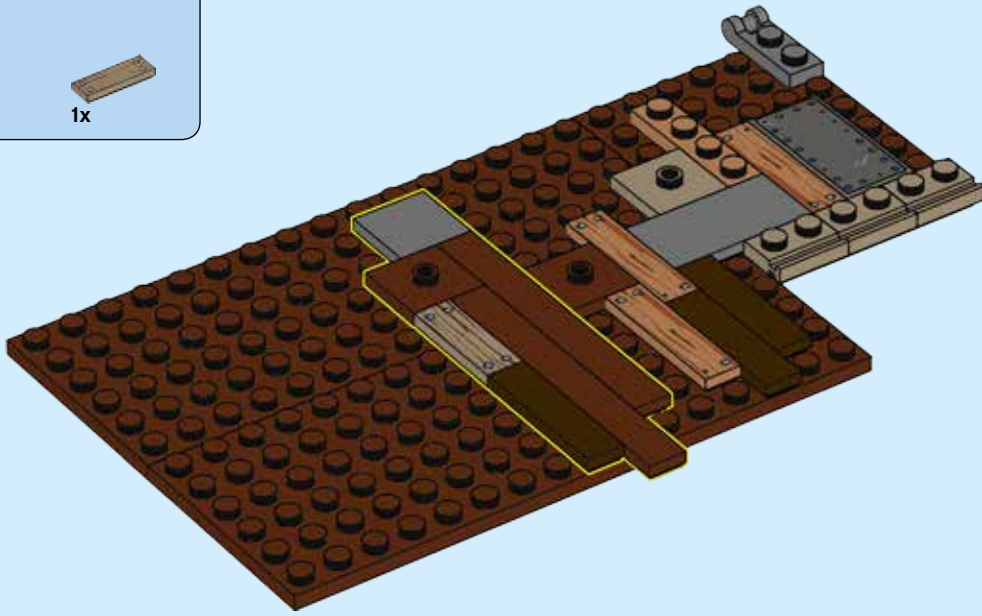

234

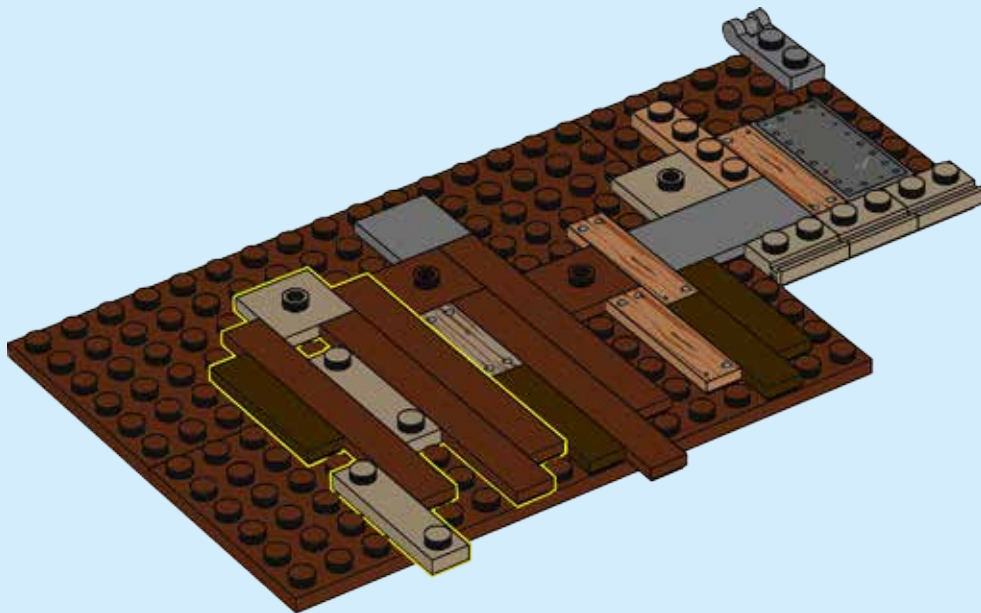

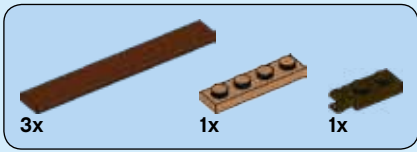

235

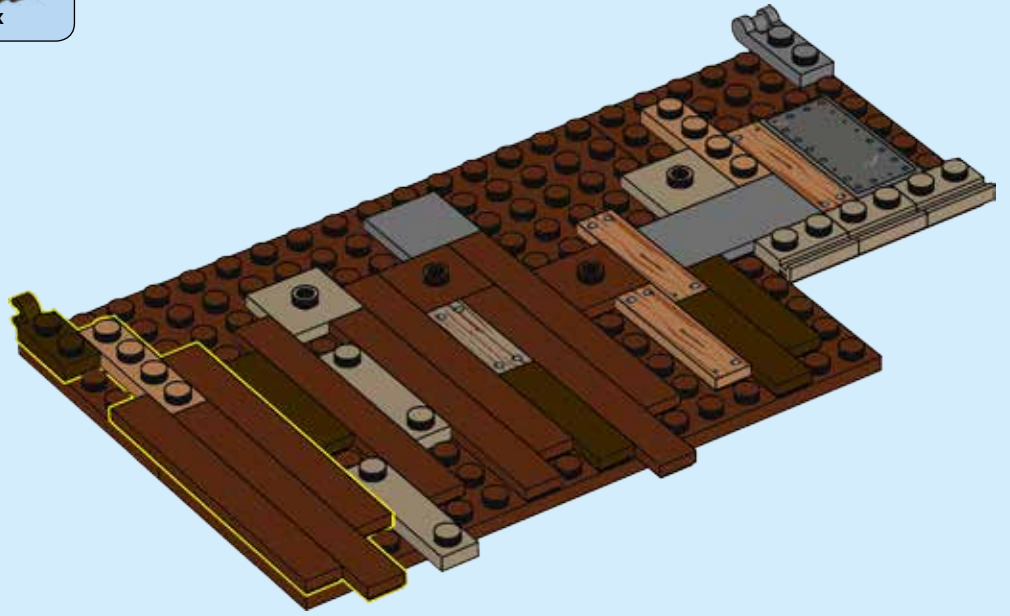

236

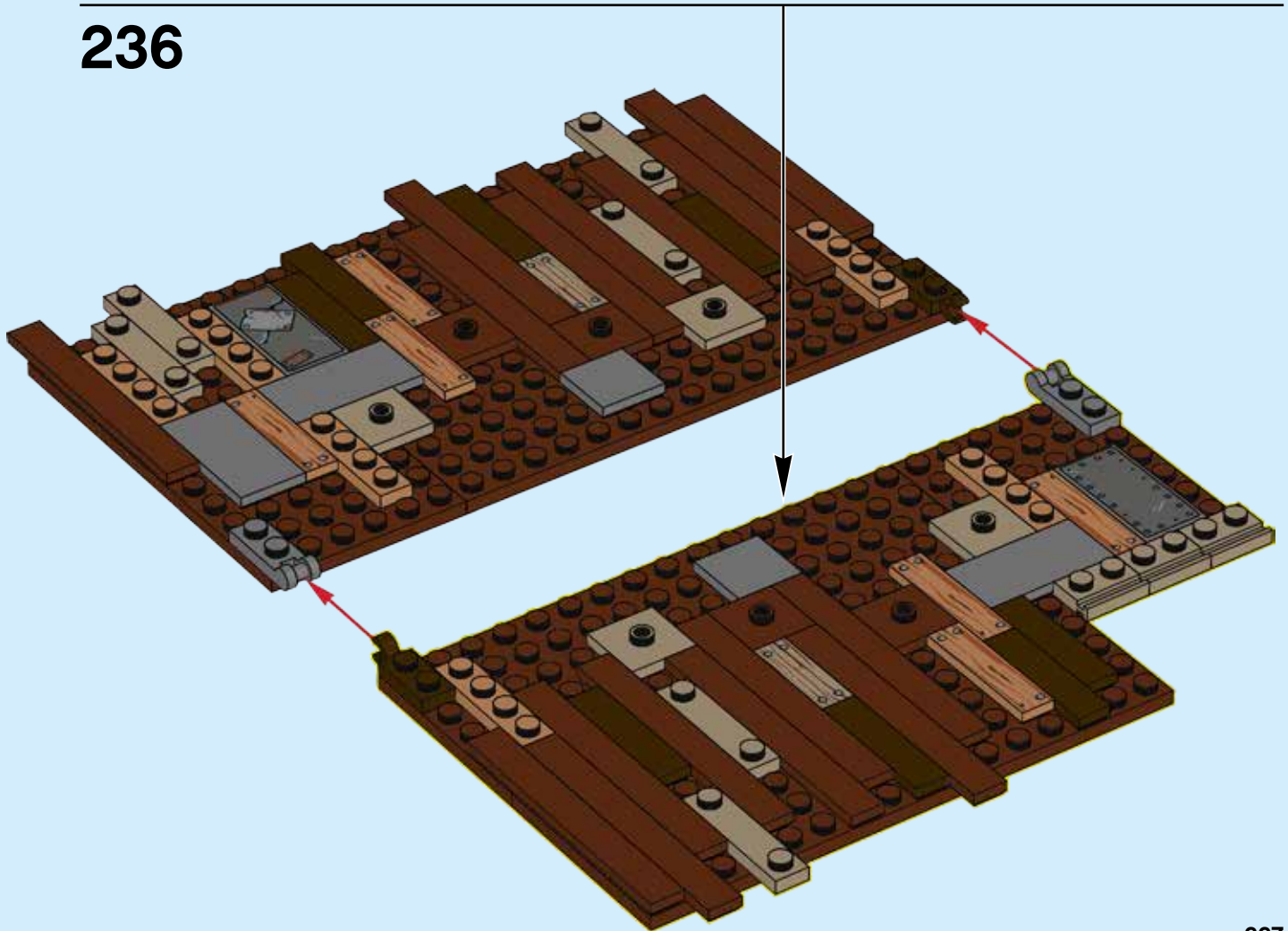



237

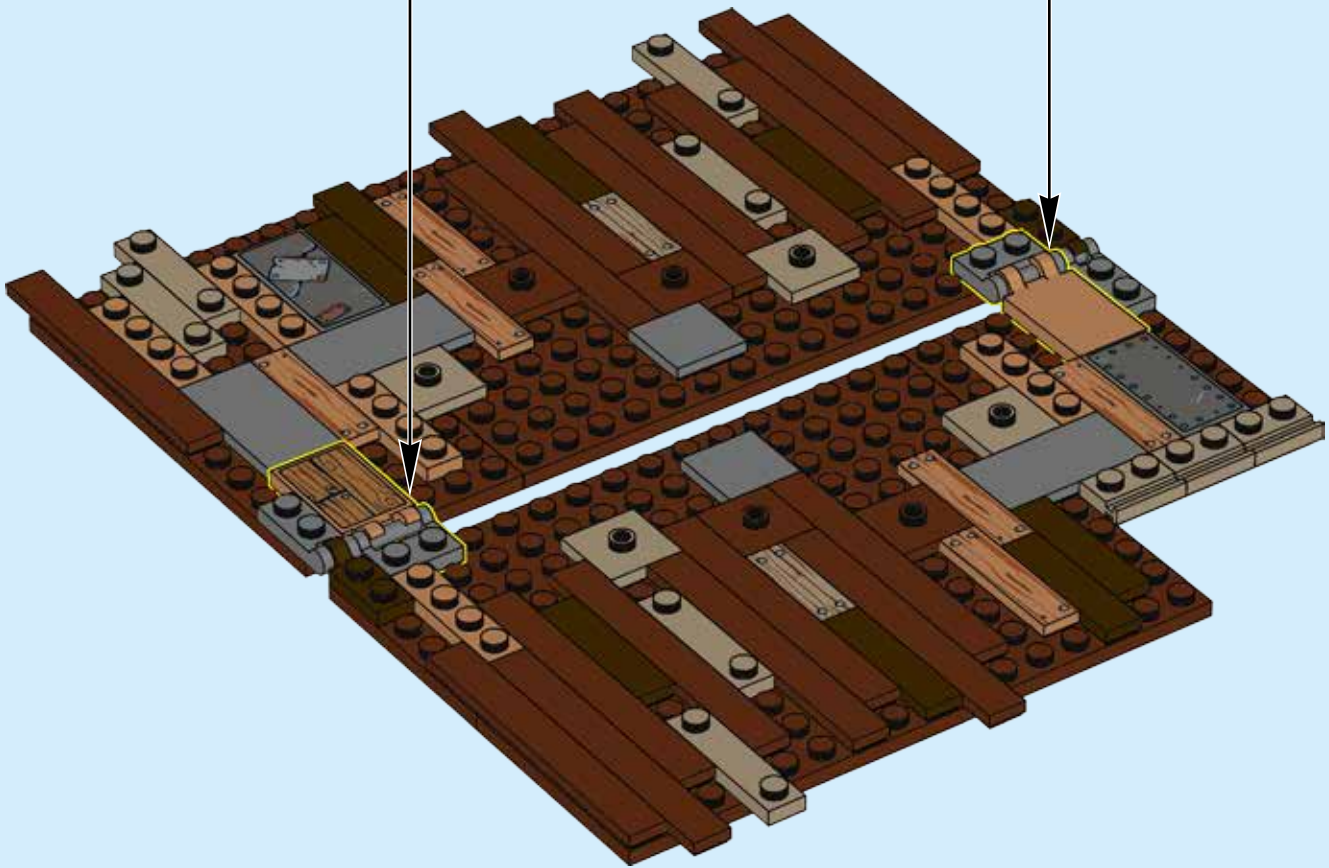
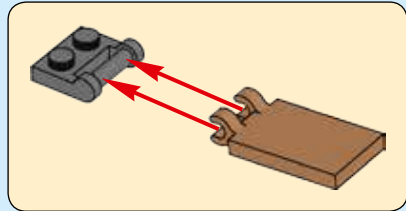
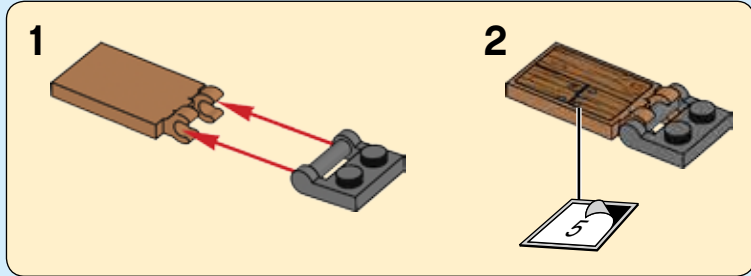

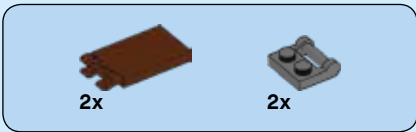

238

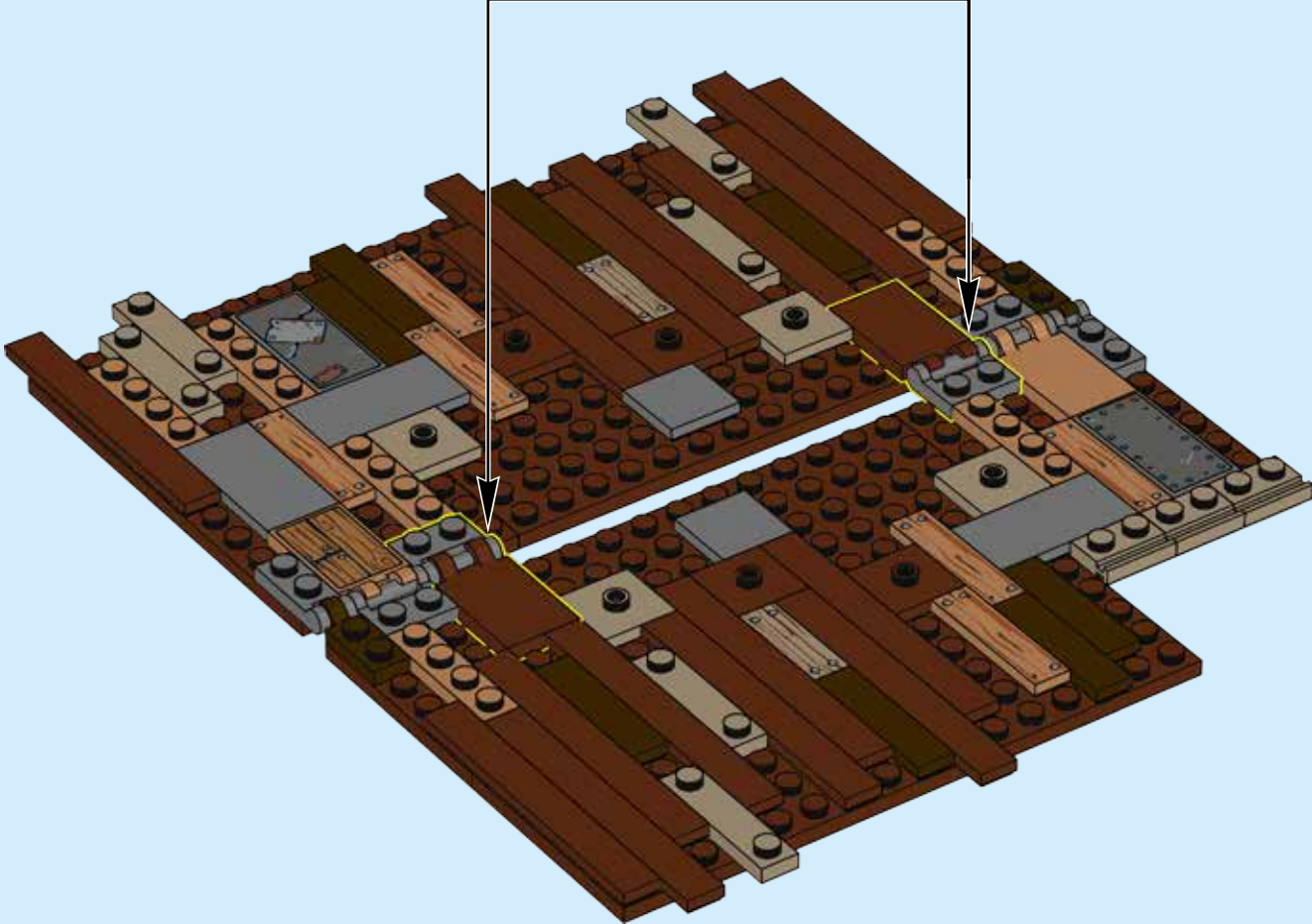
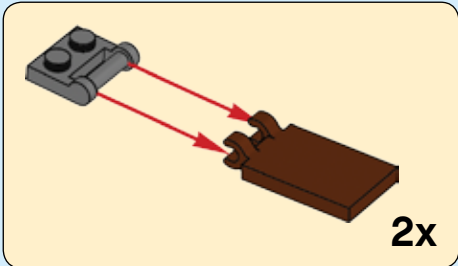

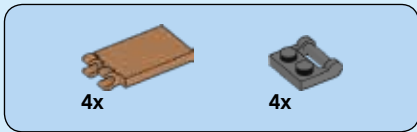

239

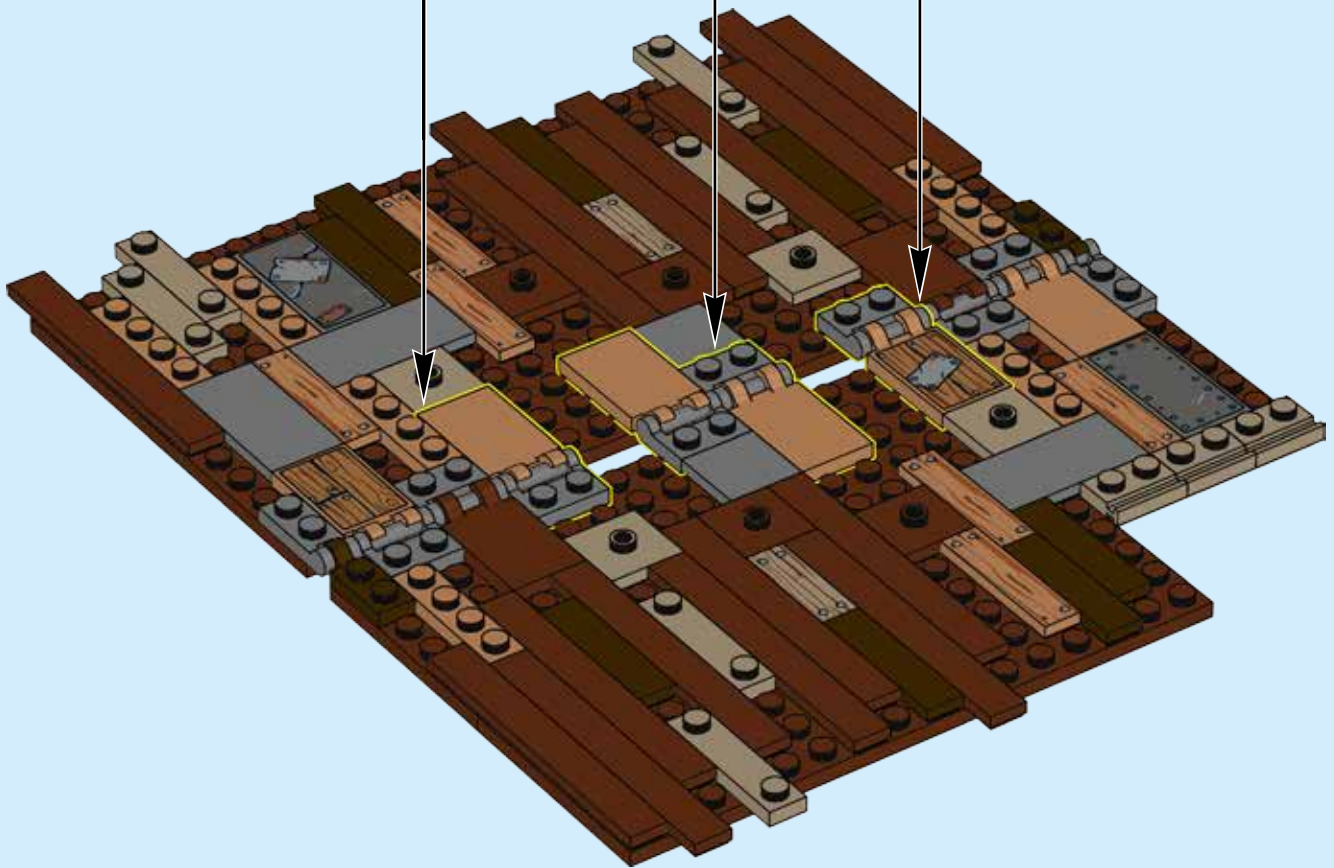
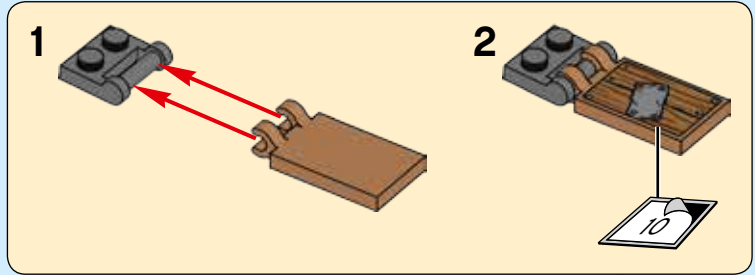
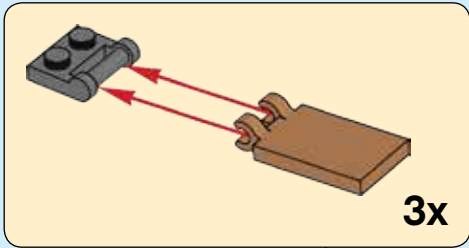



240

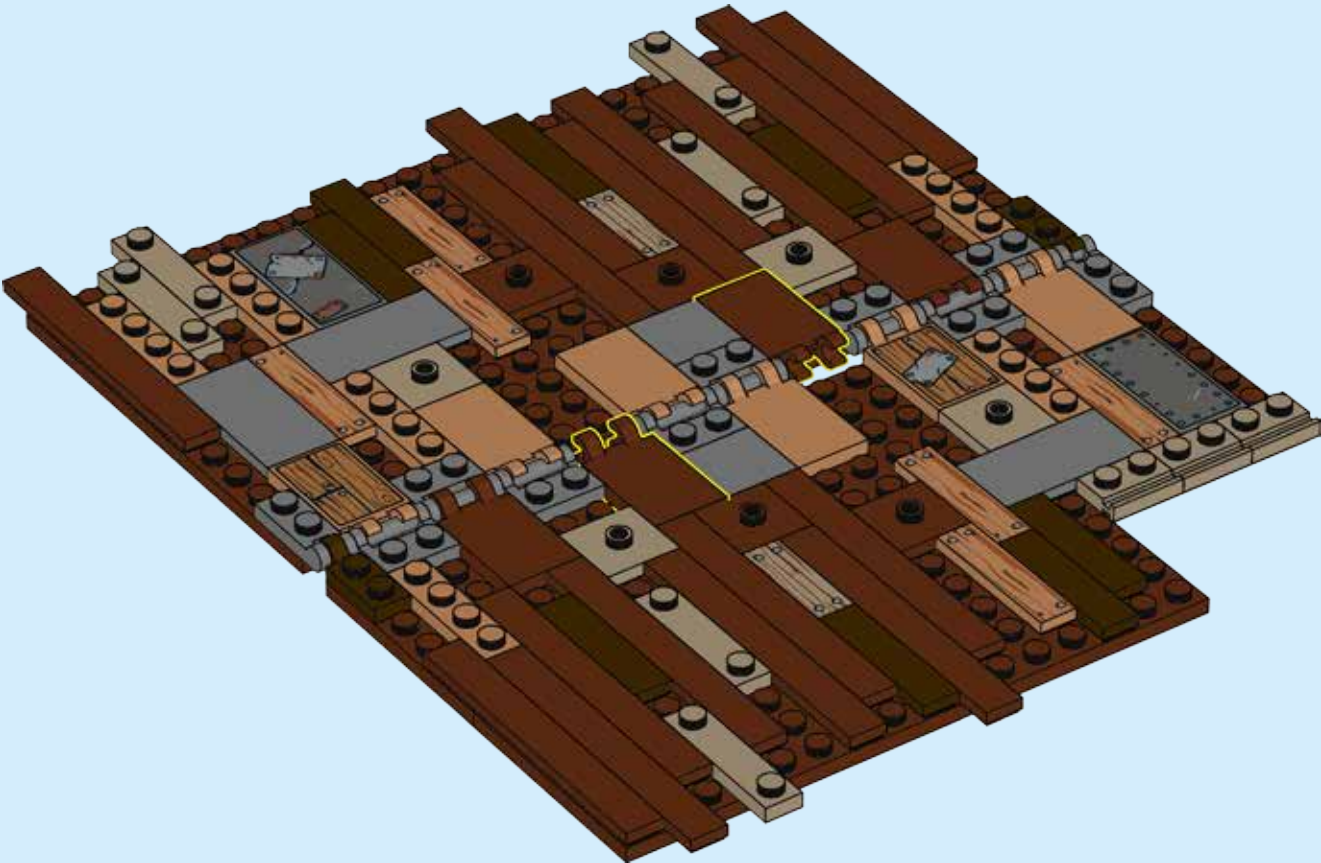

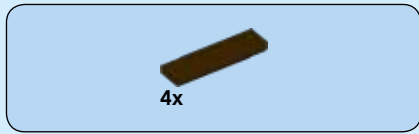

241

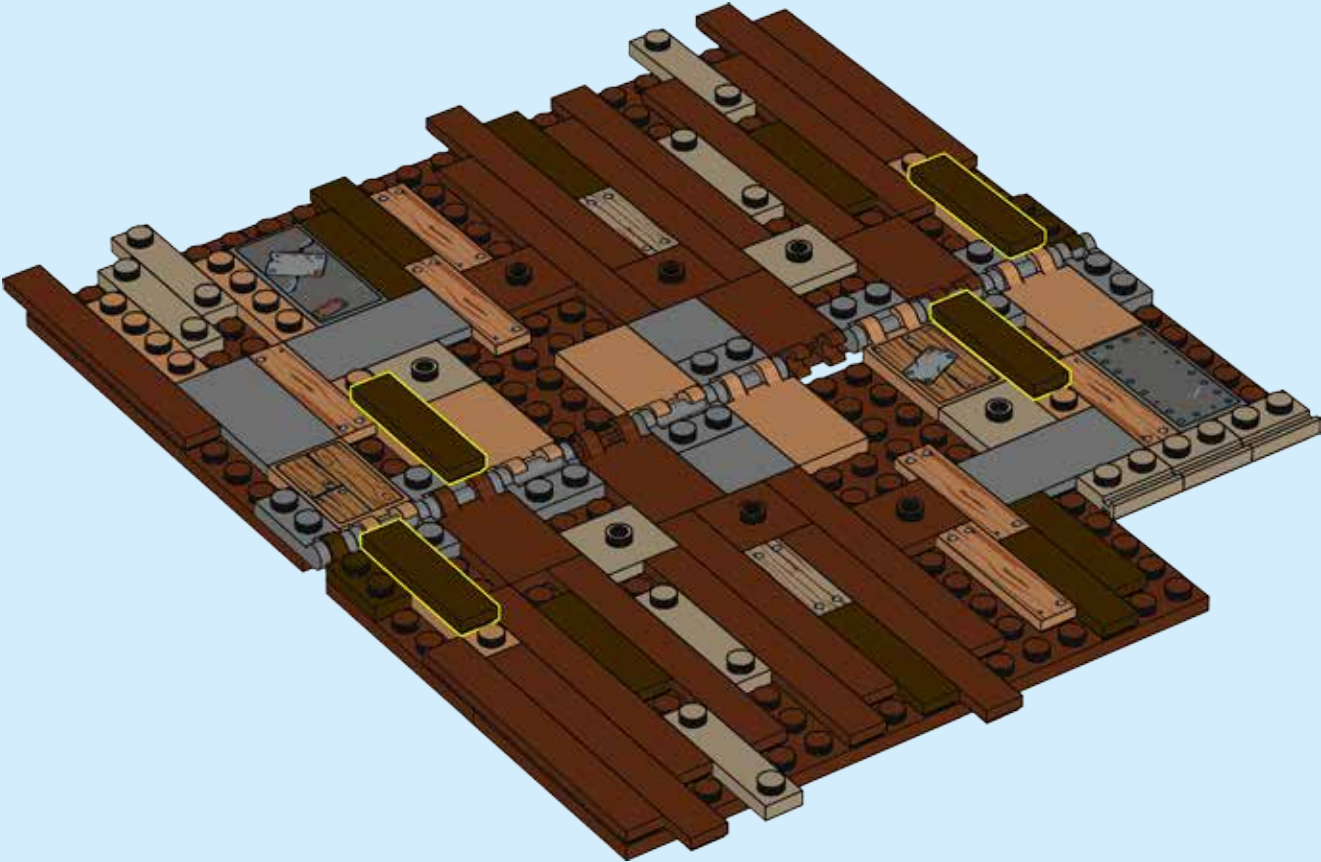



242

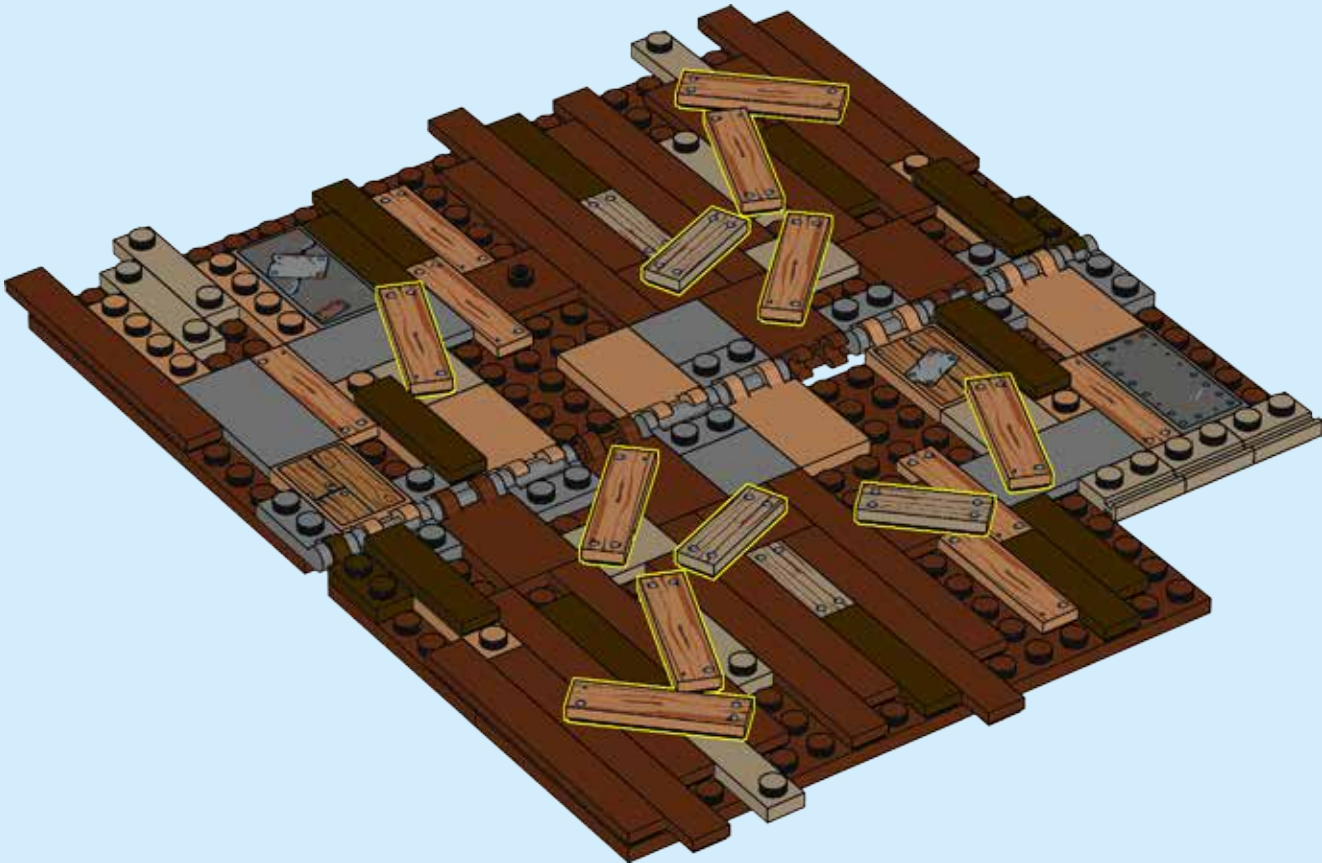

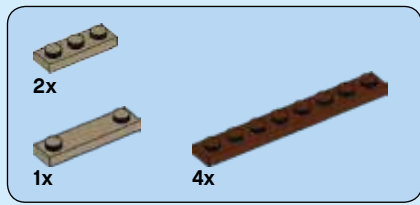

243

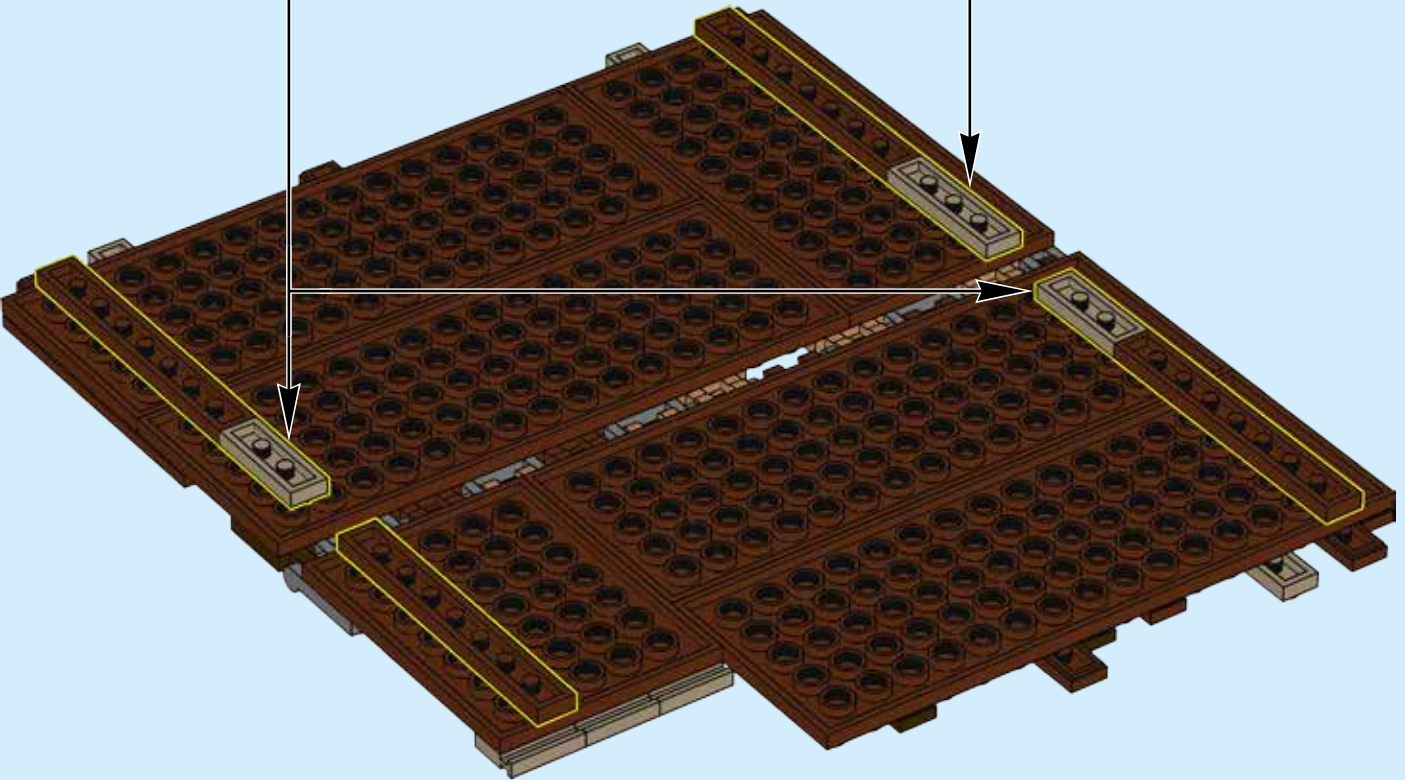
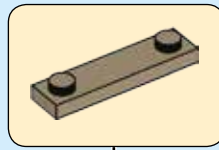
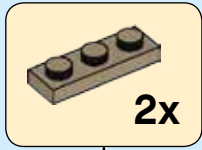
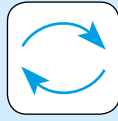

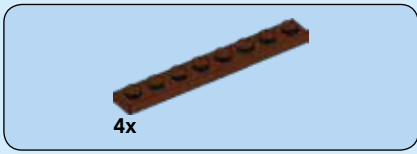

244

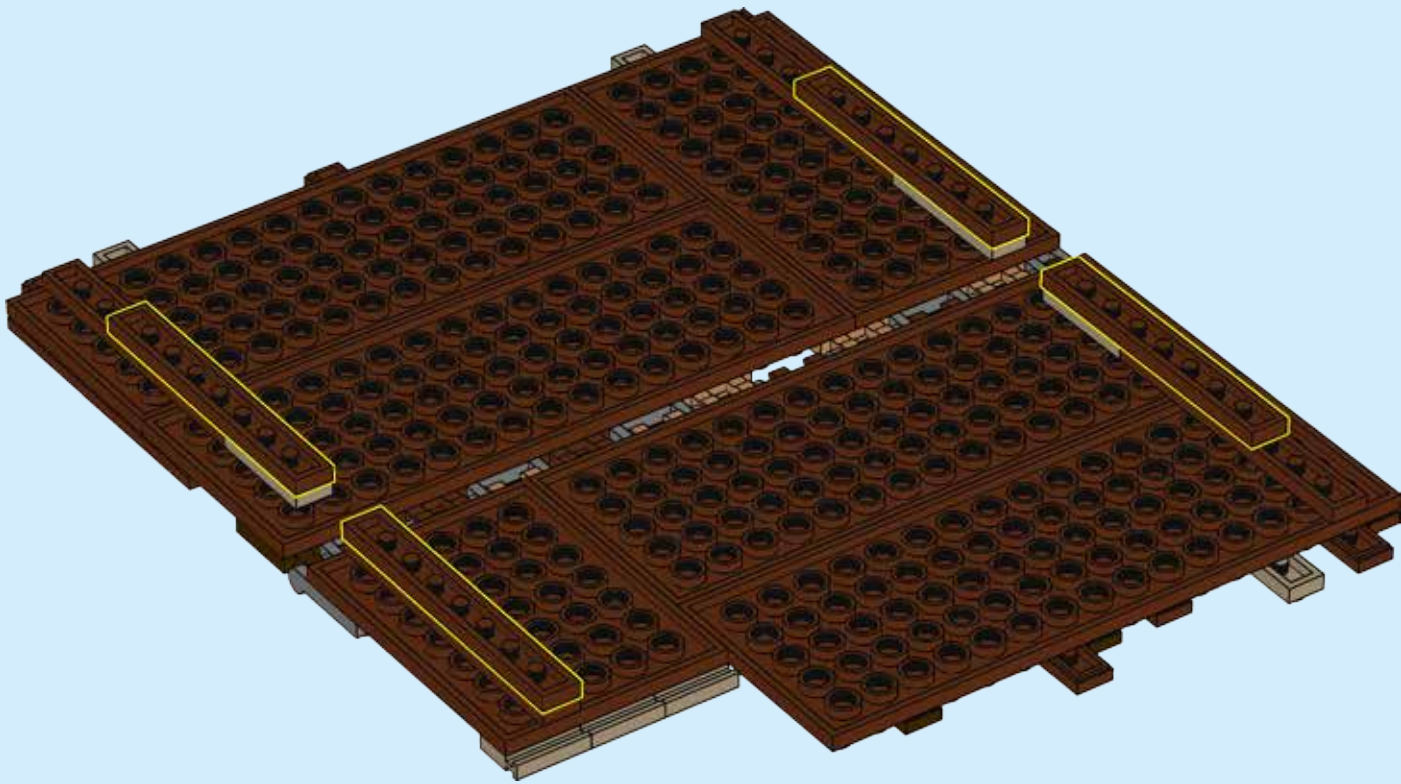



2x



2x

245

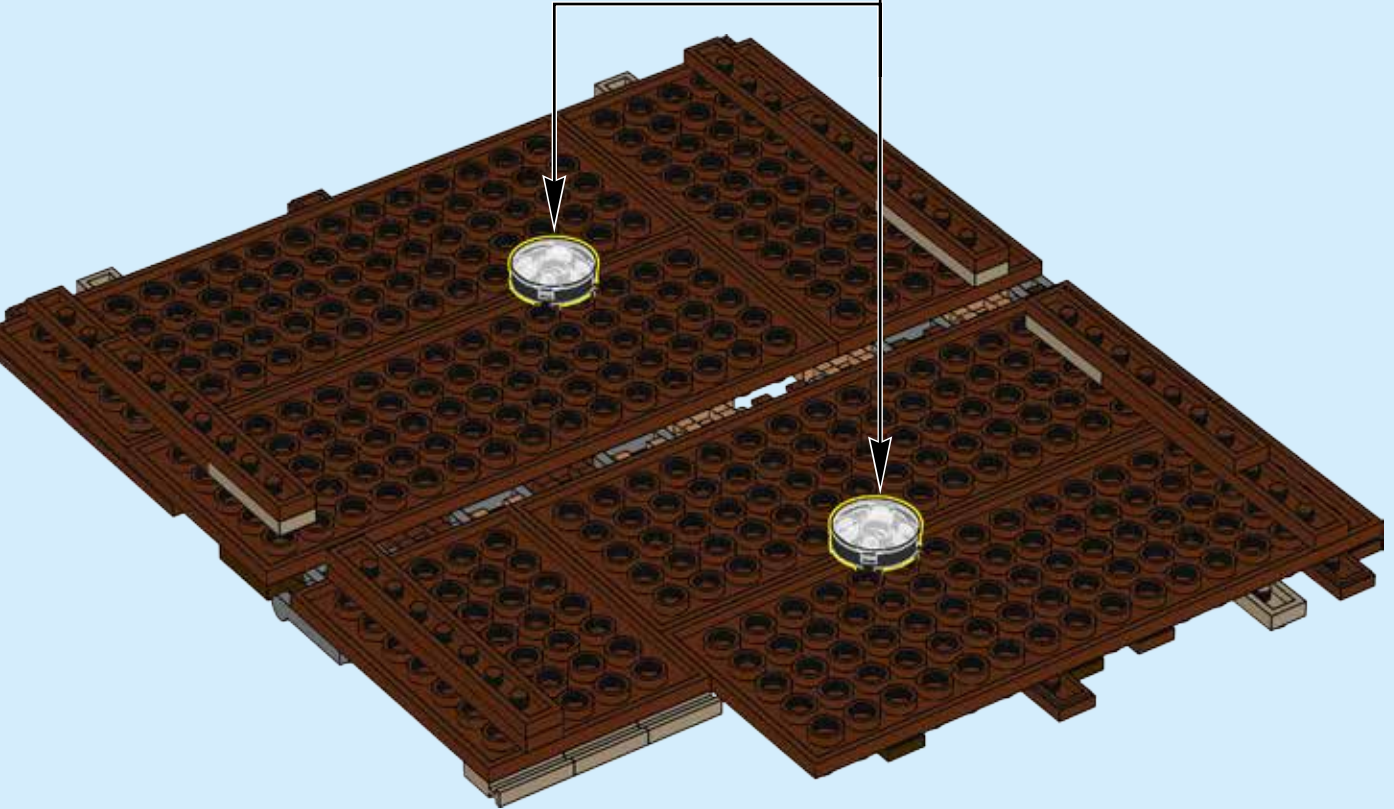
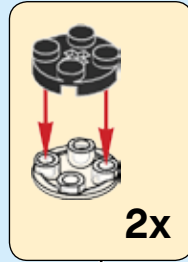

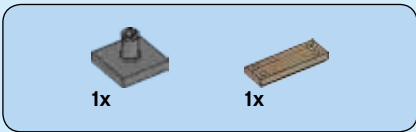

246

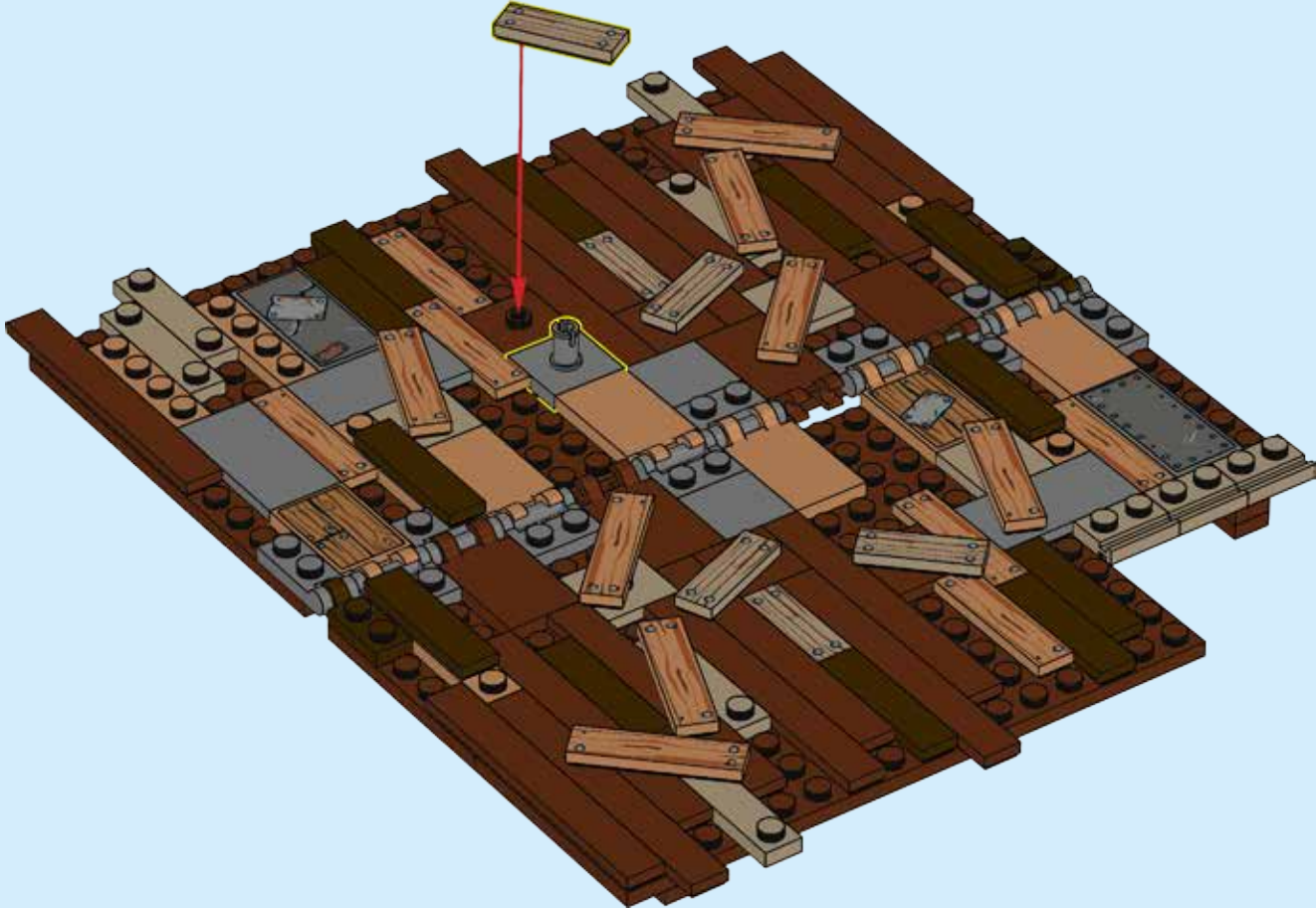
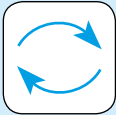

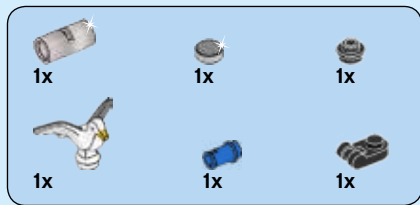

247

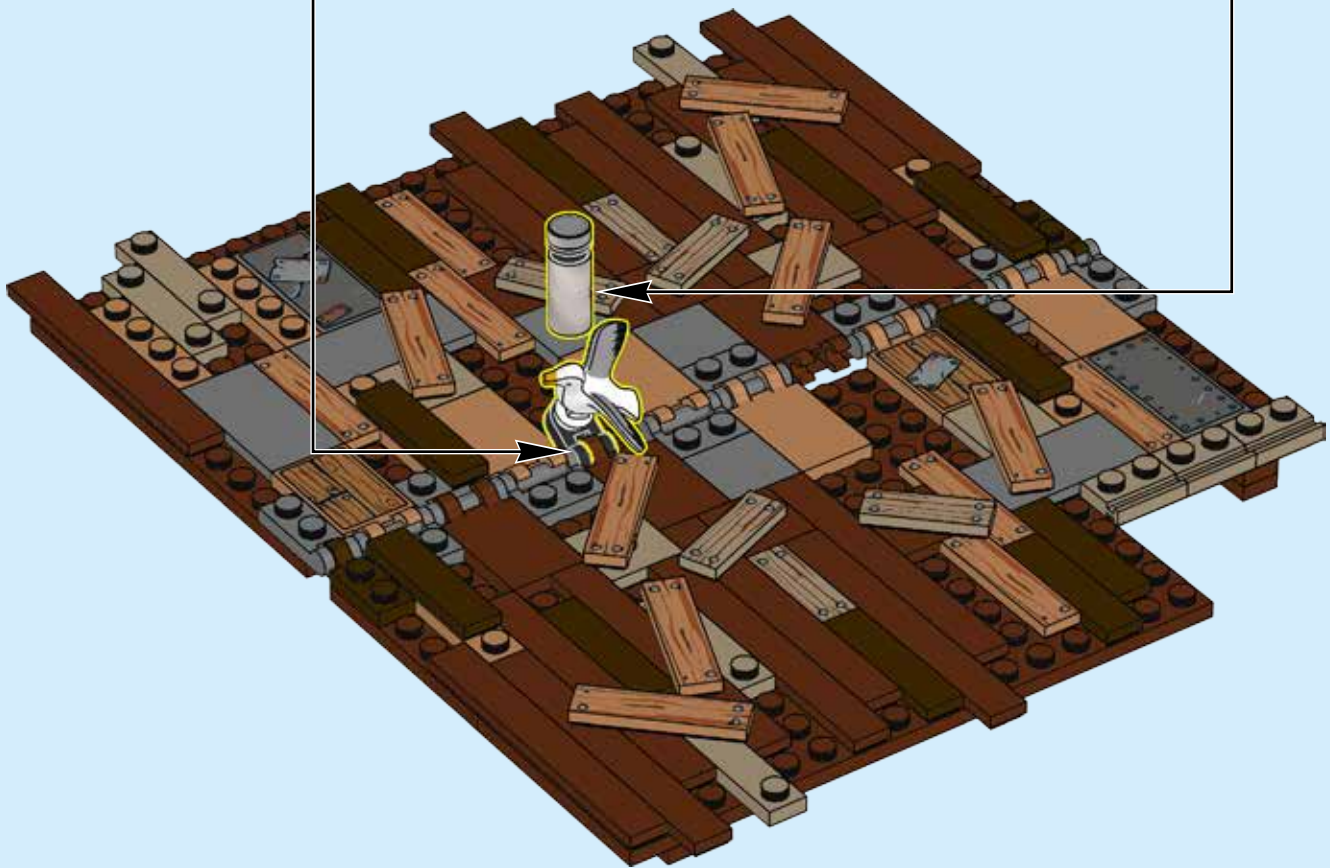
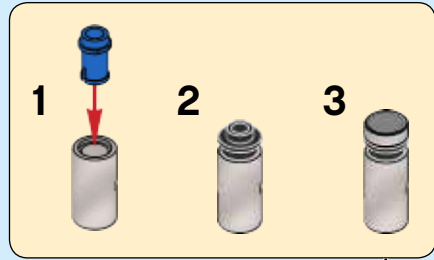
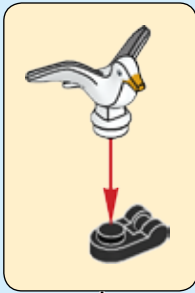

248

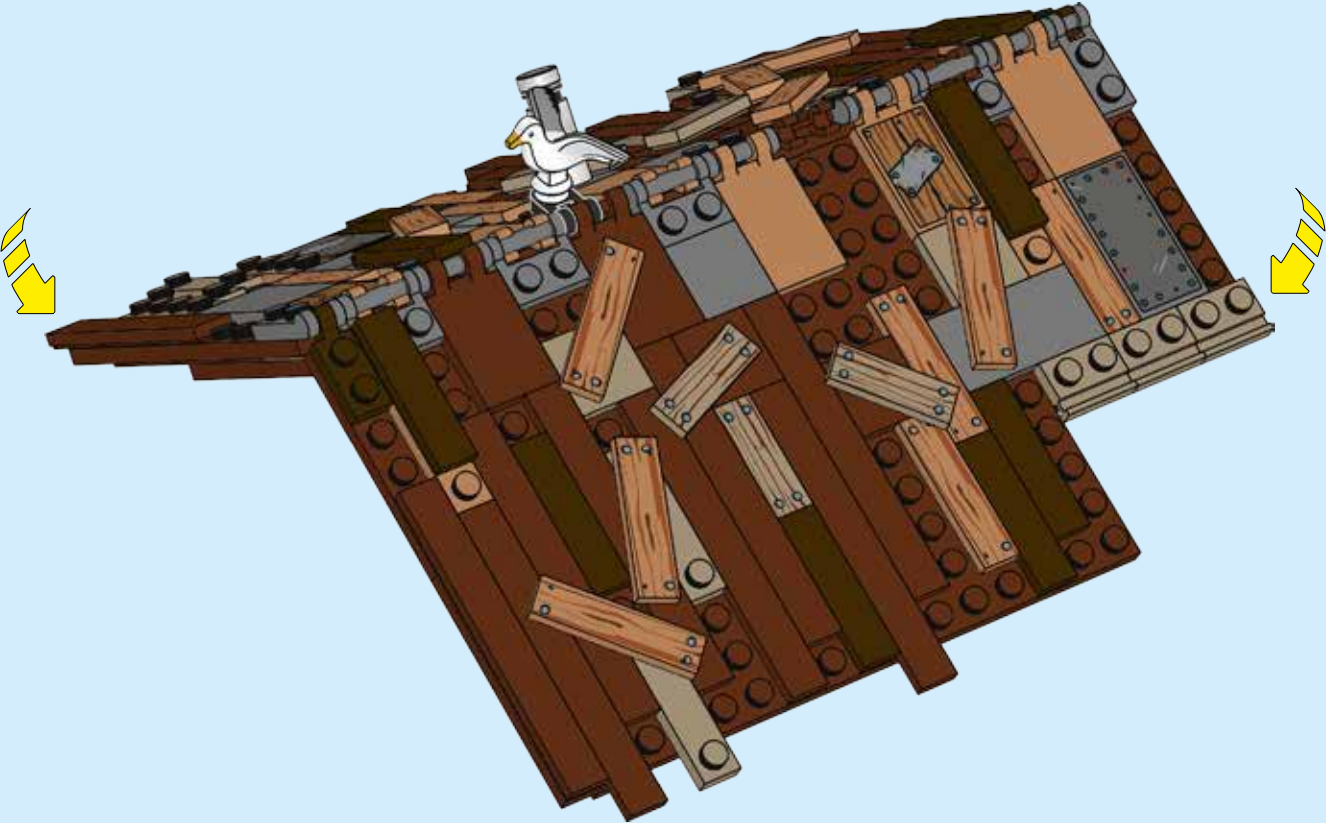





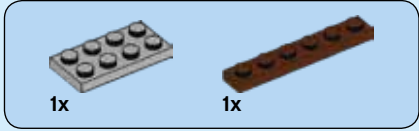

250

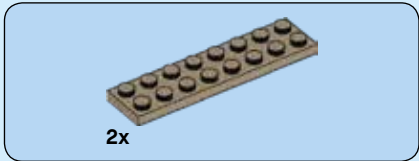
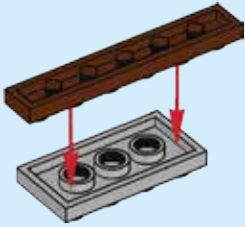

251

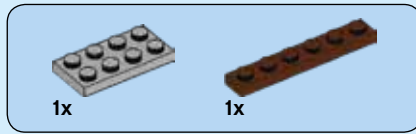
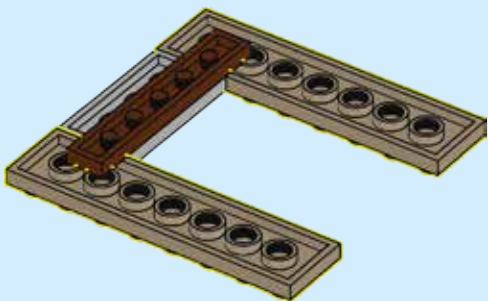

252

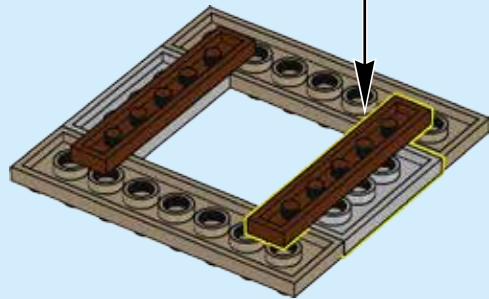
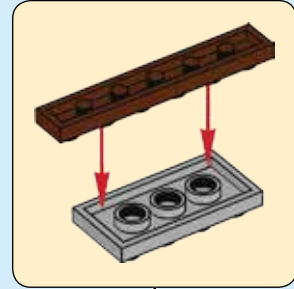

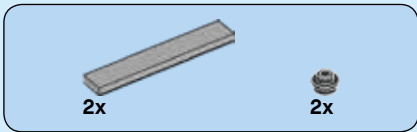

253

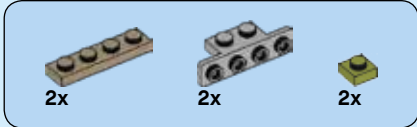
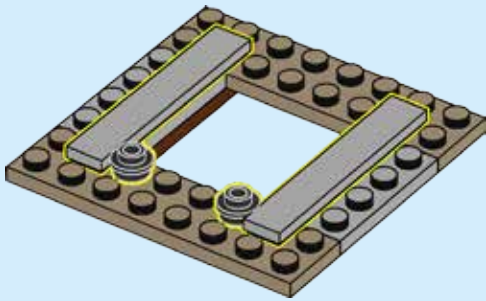
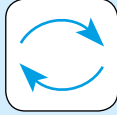

254

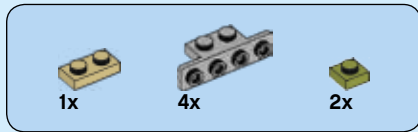
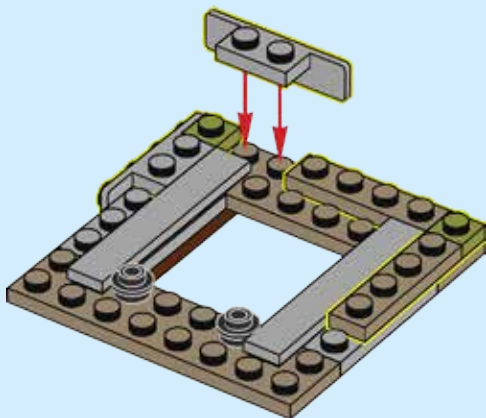

255

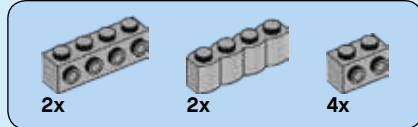
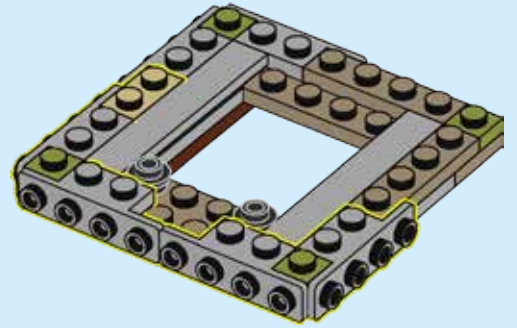

256

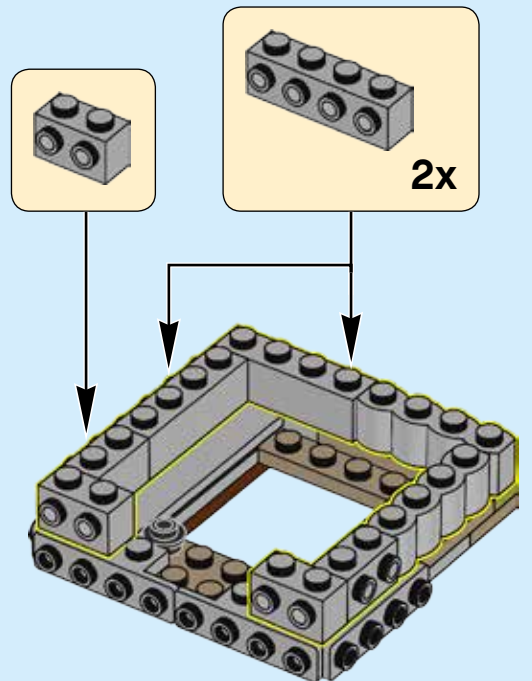

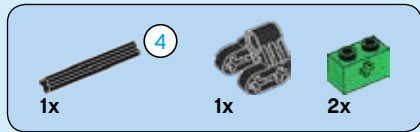

257

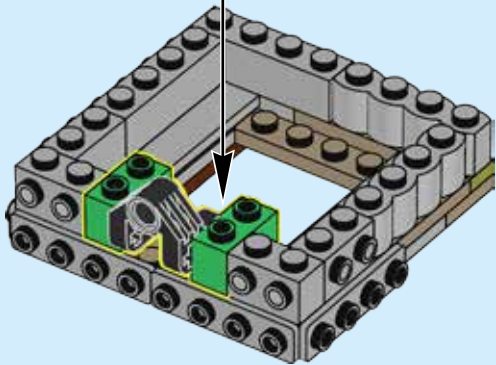
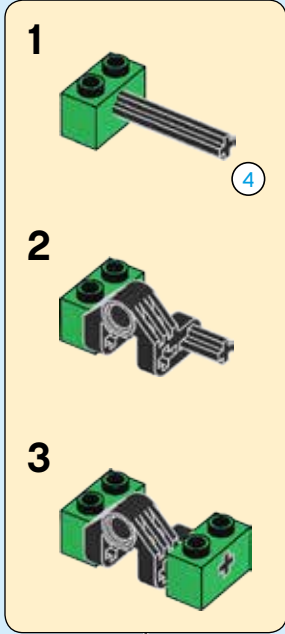

258

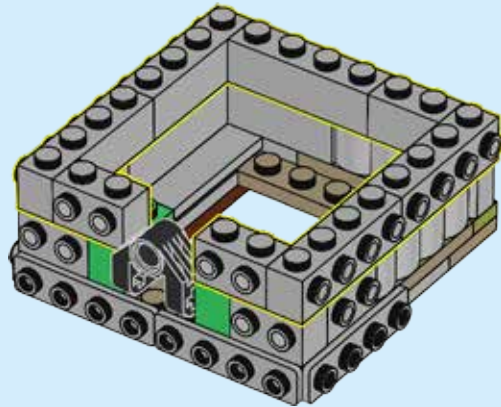

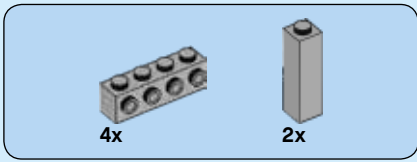

259

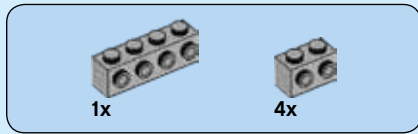
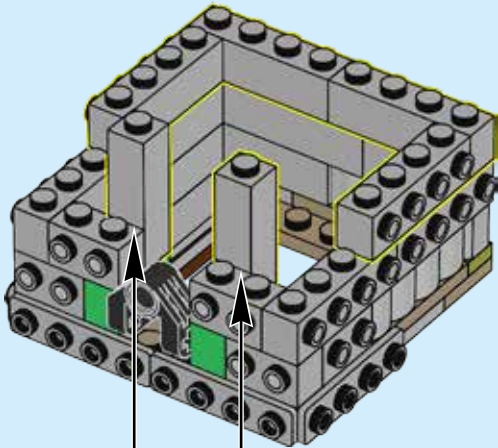

260

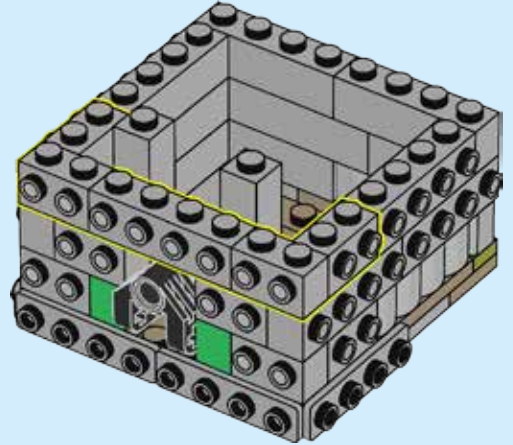

261

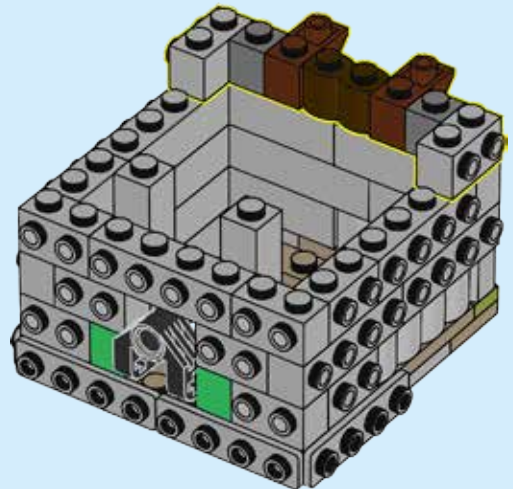



262

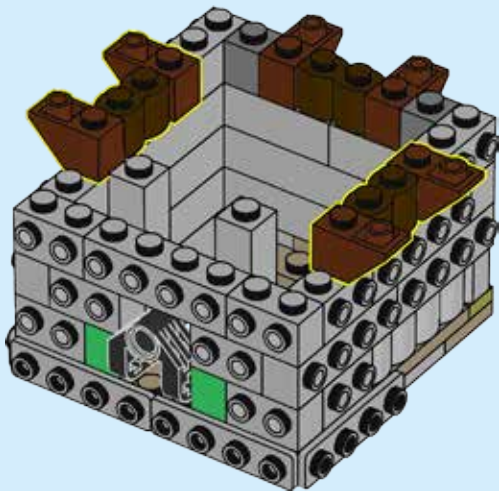

263

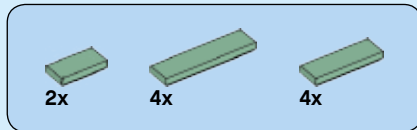
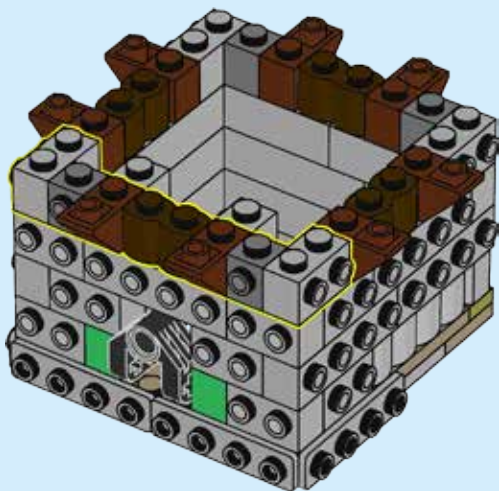

264

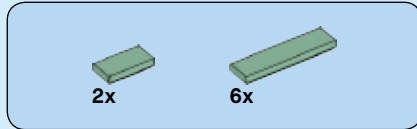
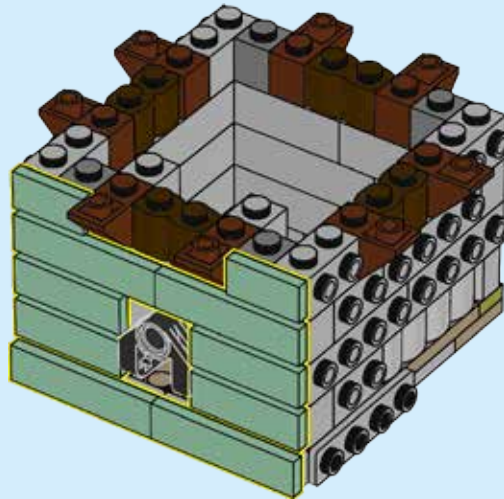

265

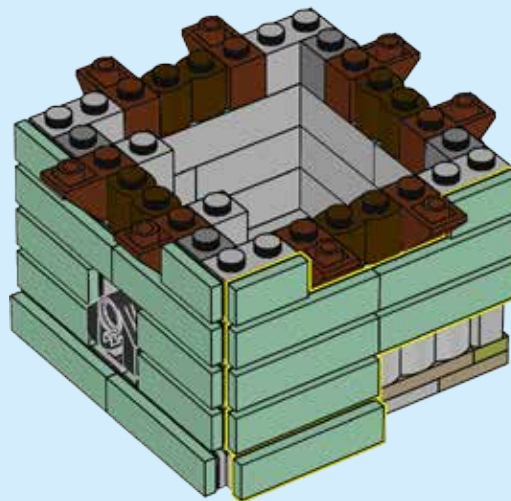

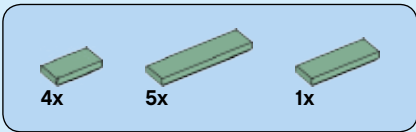

266

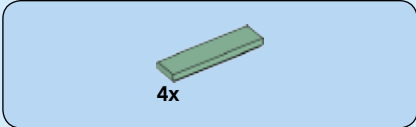
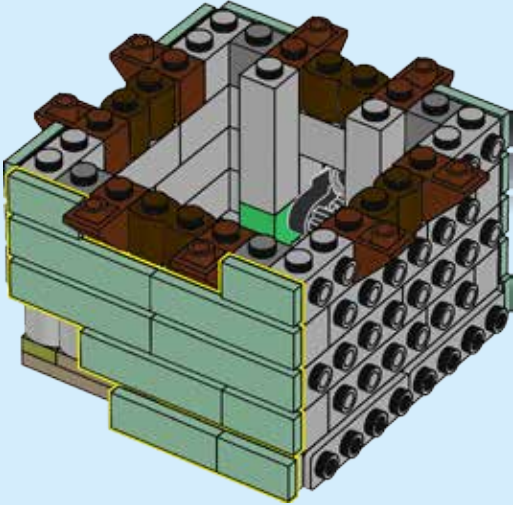

267

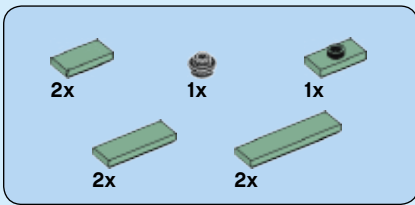
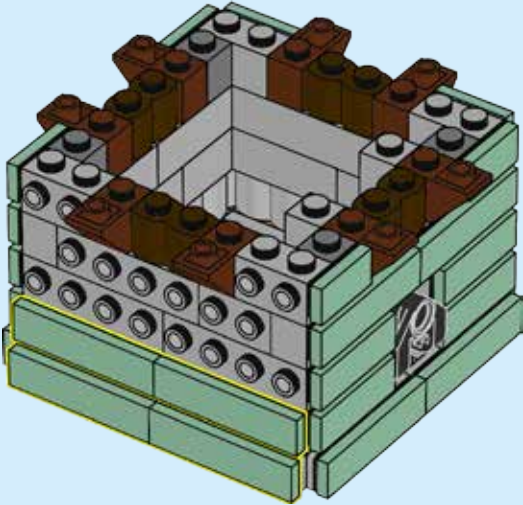

268

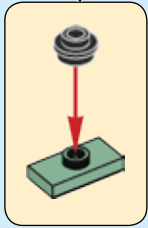
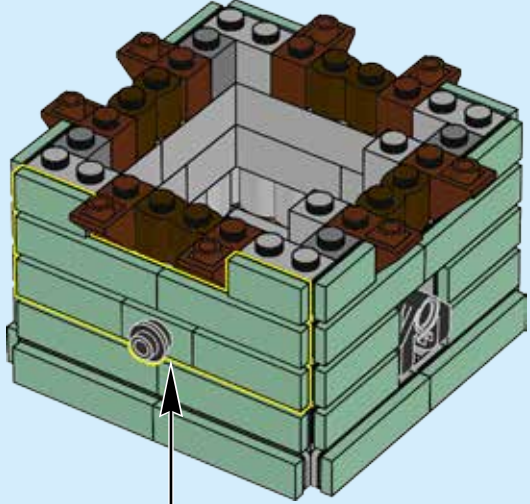

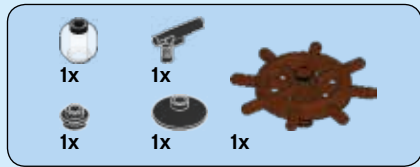

269

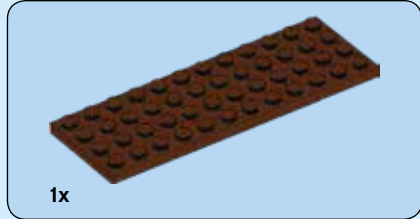
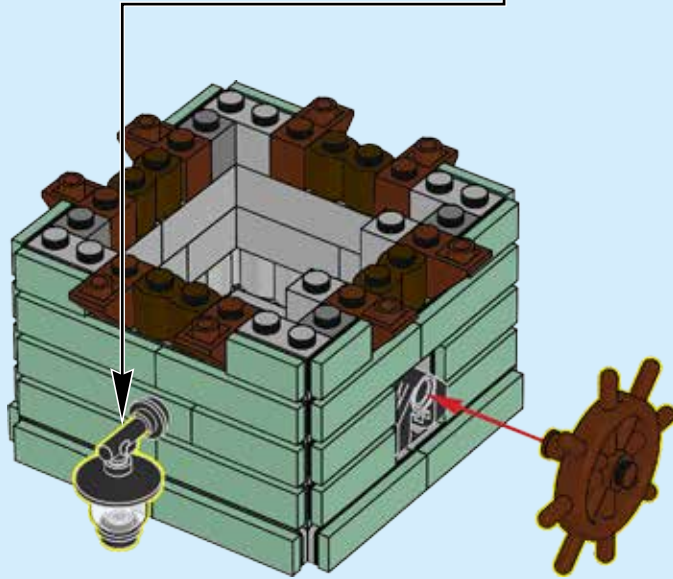
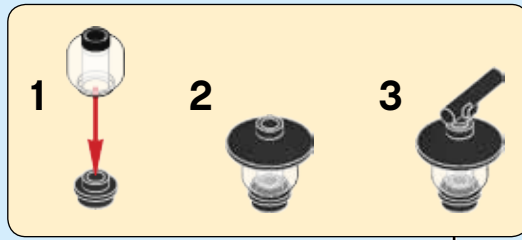

270

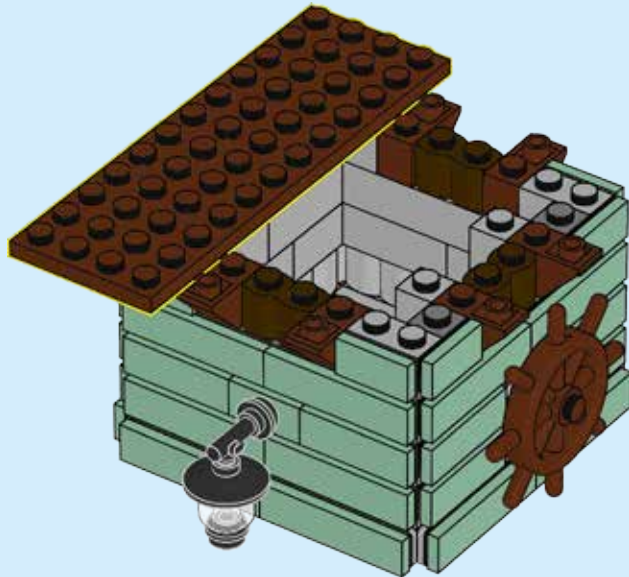



271

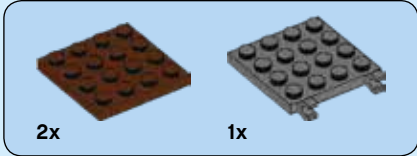
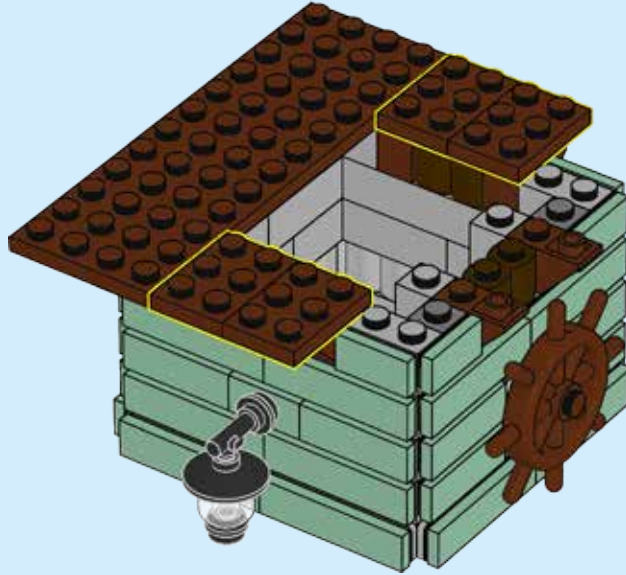

272

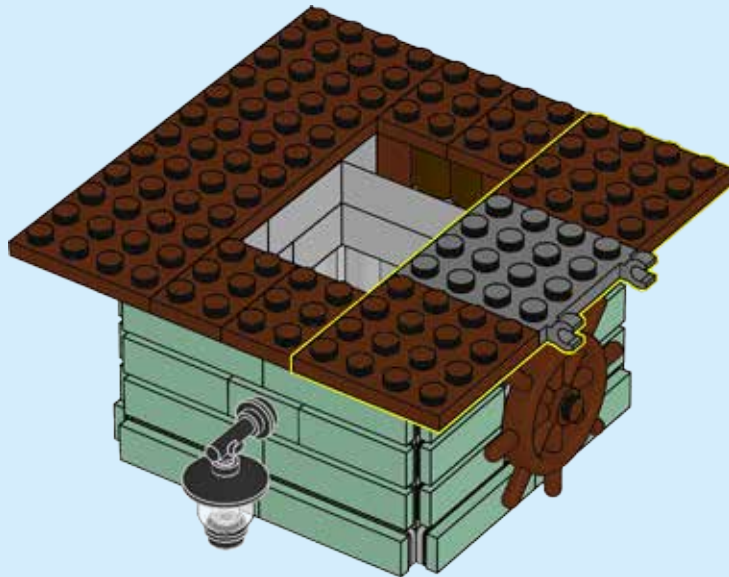

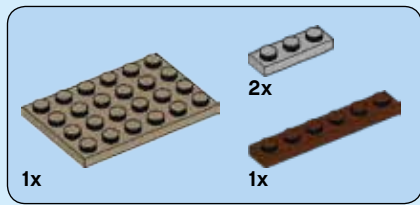

273

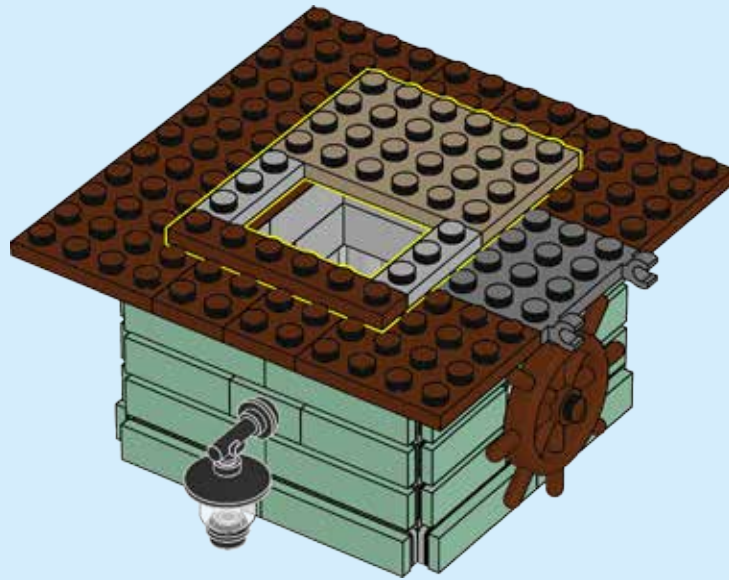

274

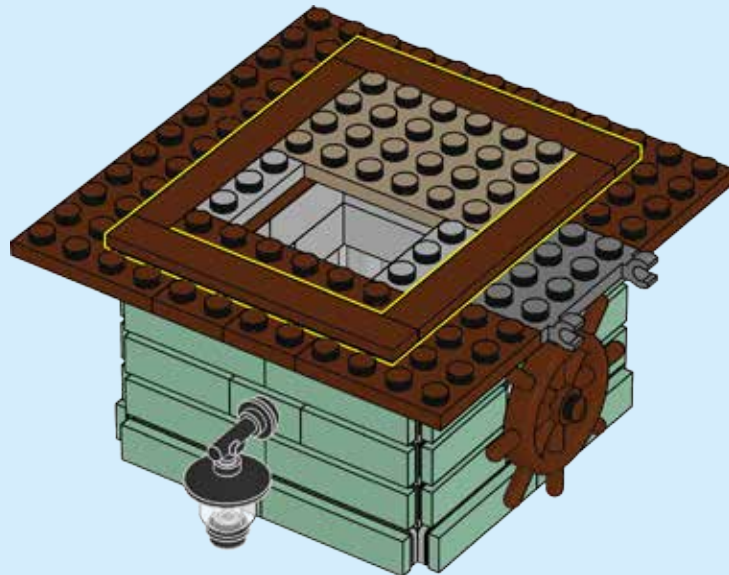



275

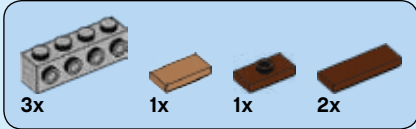
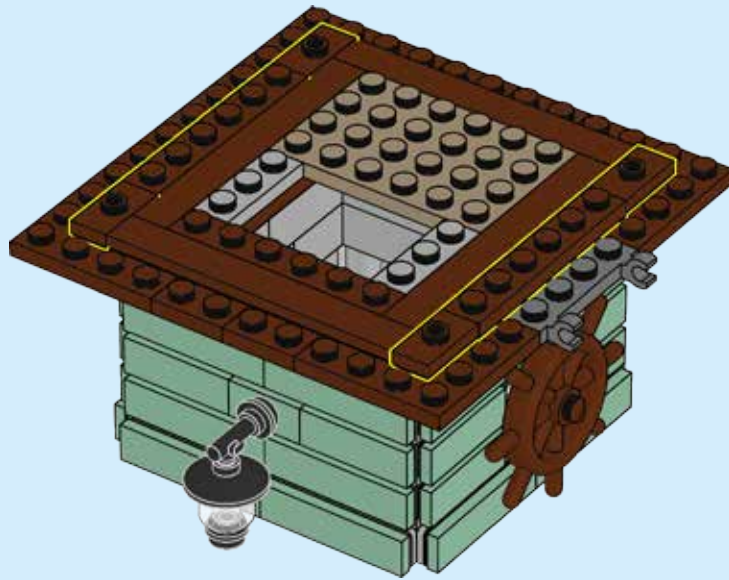

276

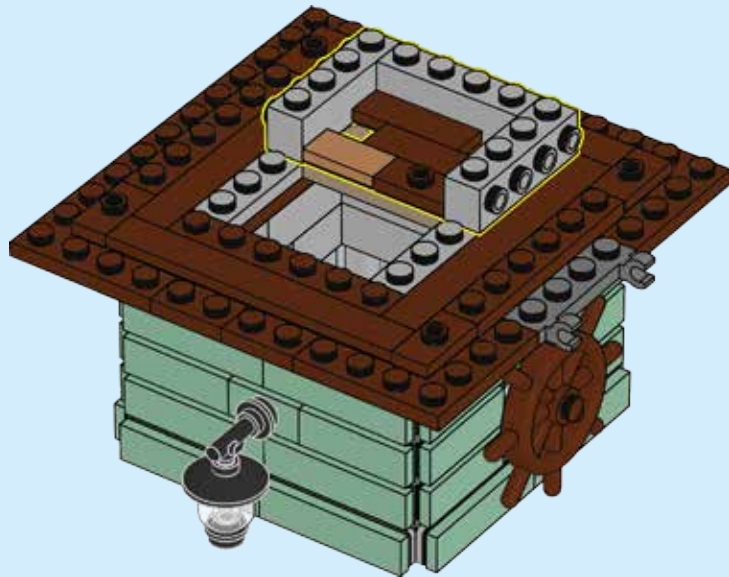



277

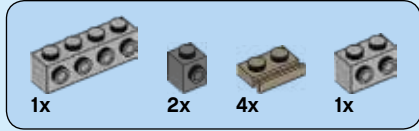
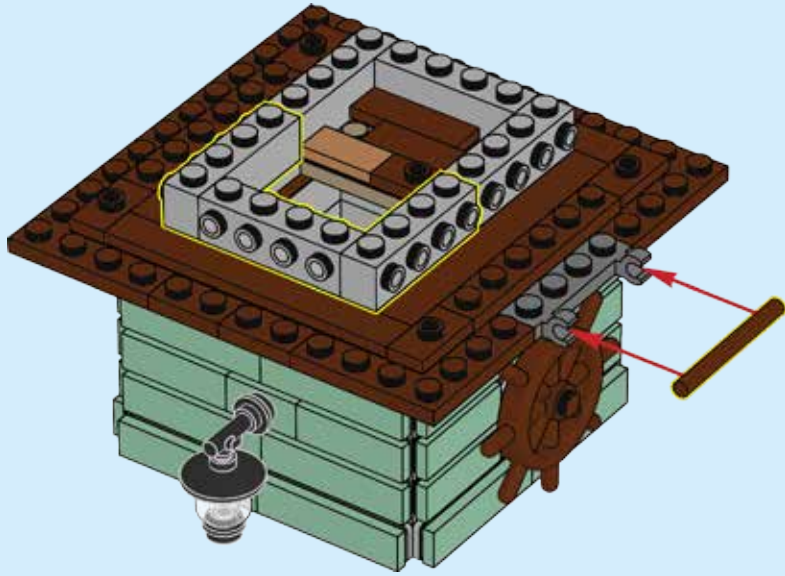

278

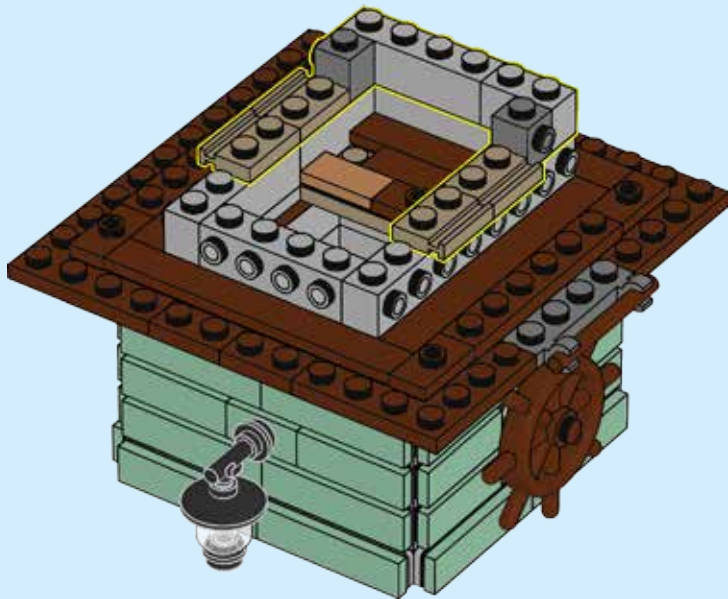

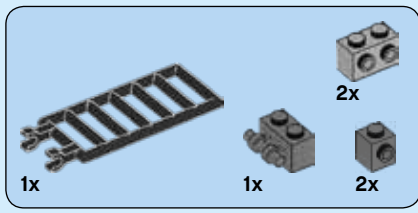

279

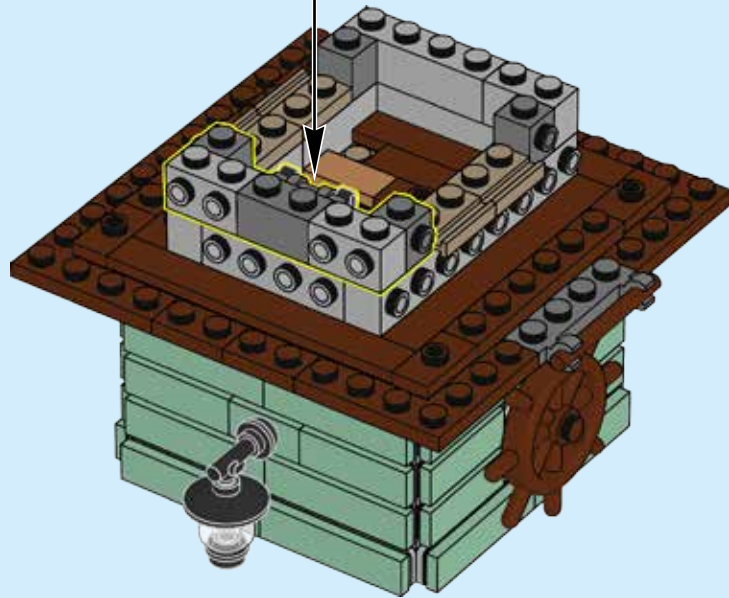
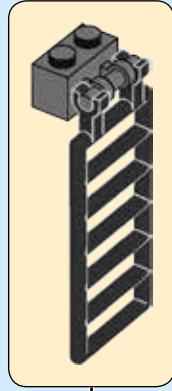

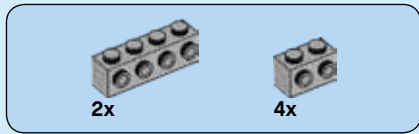

280

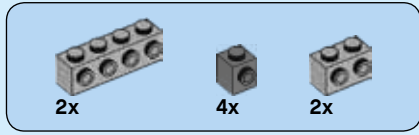
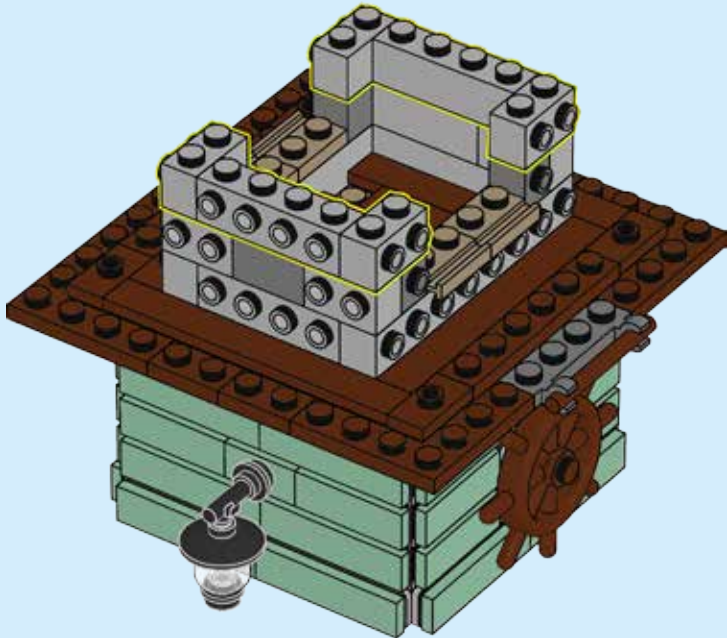

281

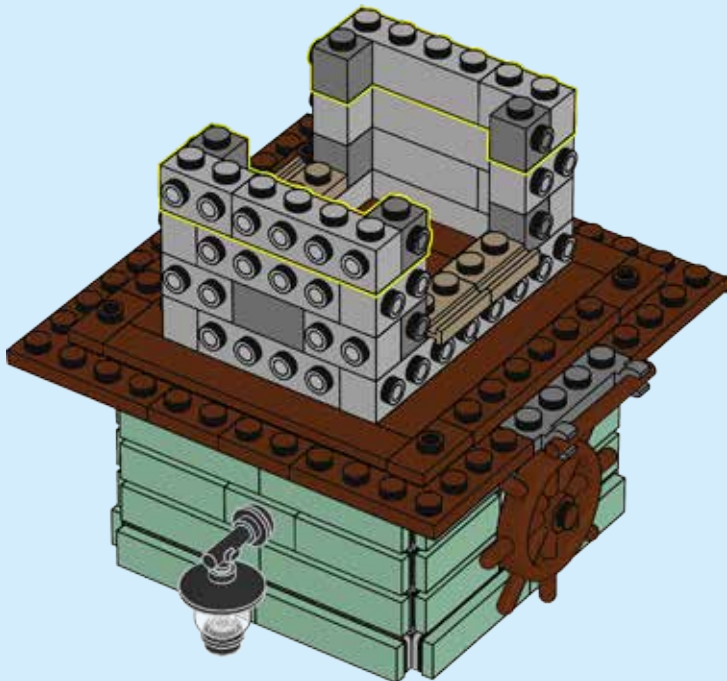

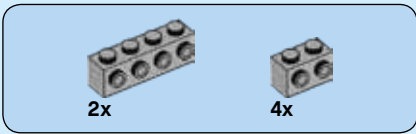

282

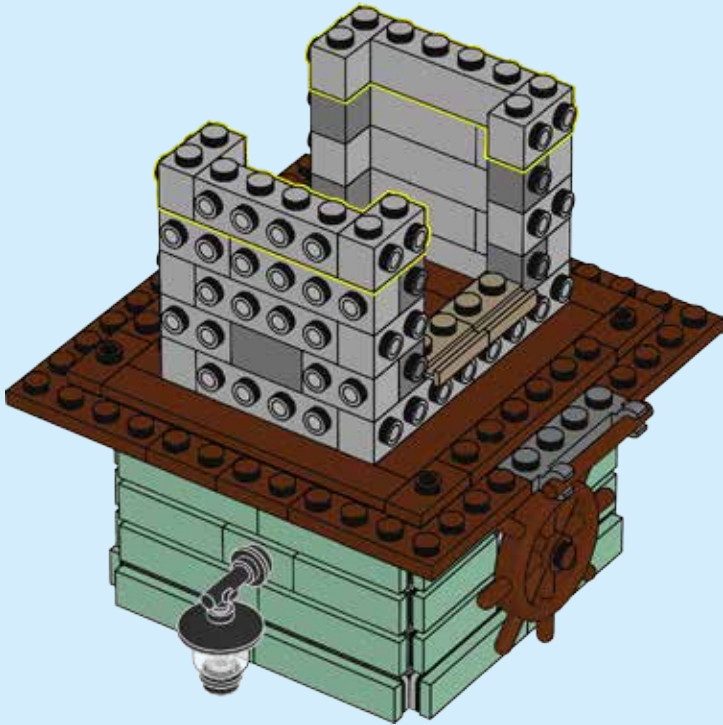

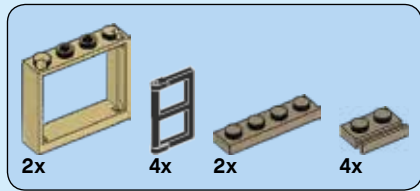

283

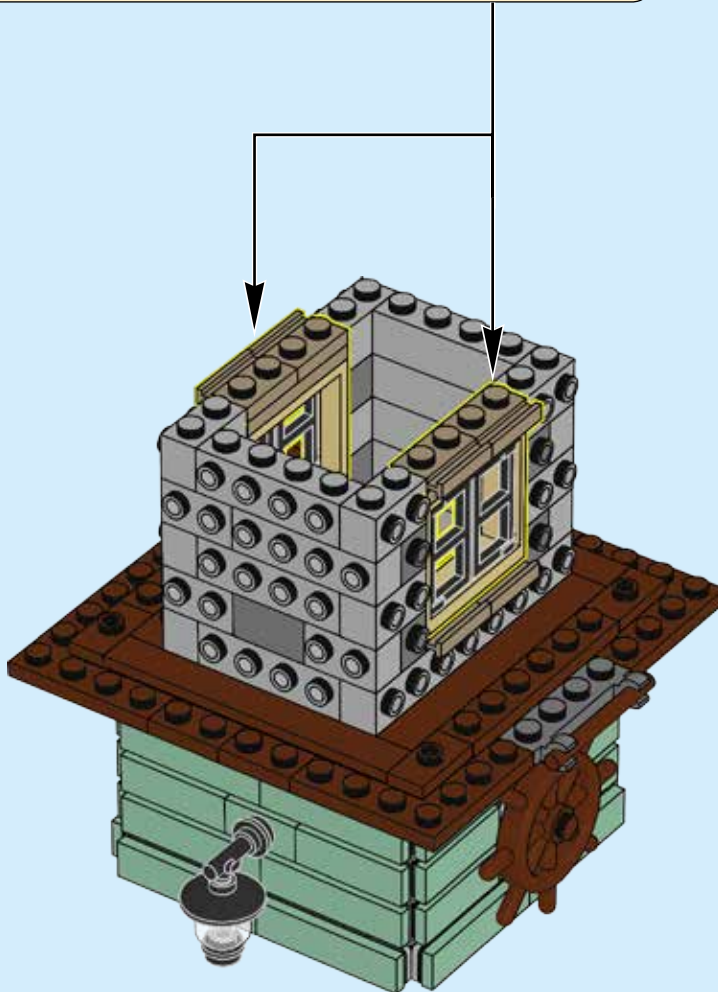
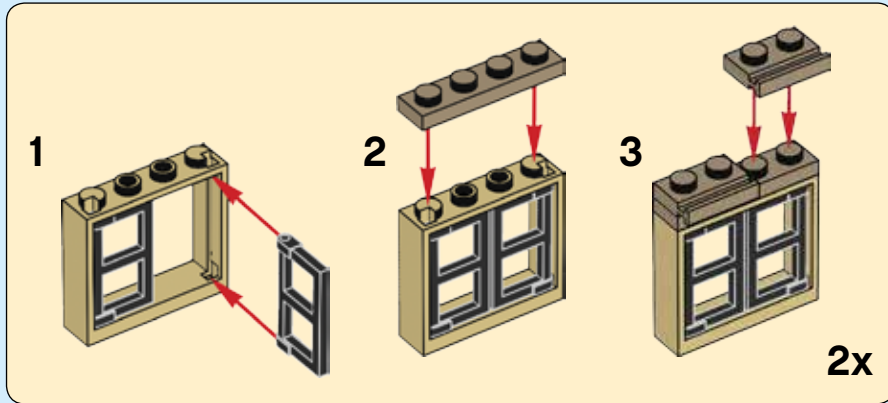

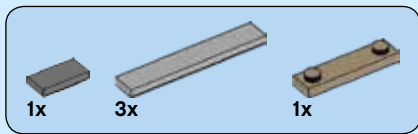

284

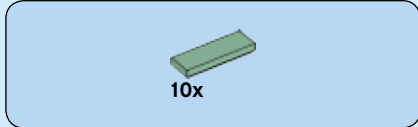
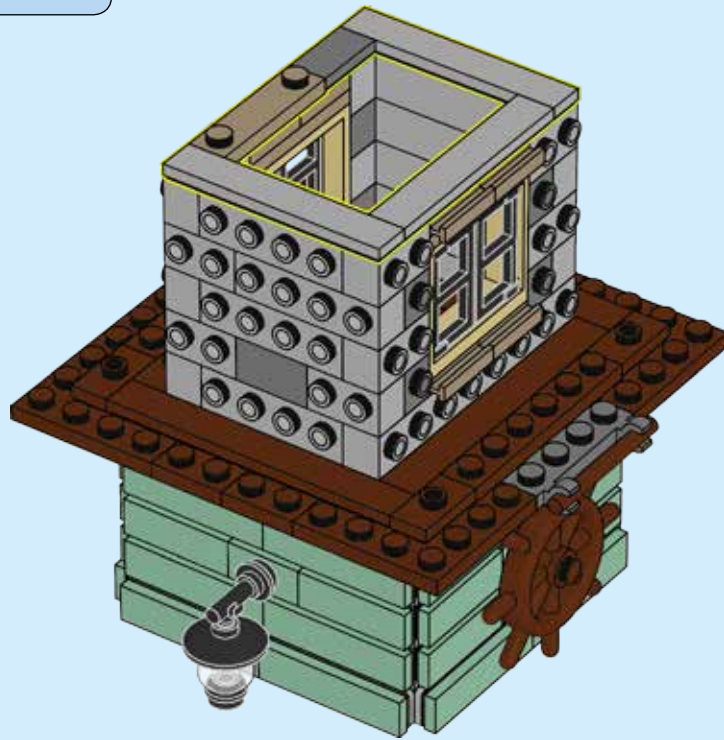

285

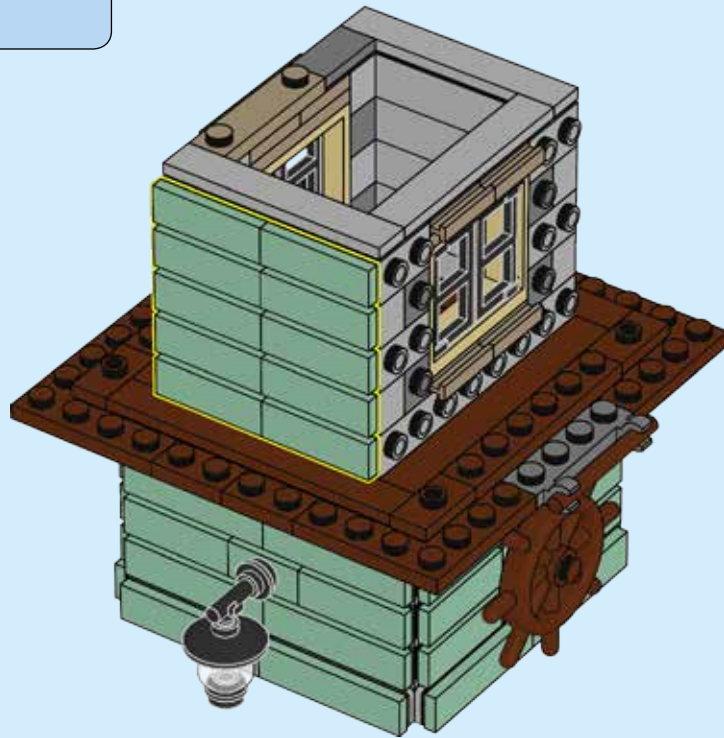

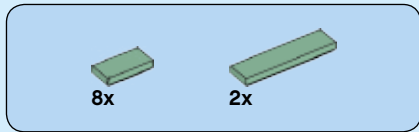

286

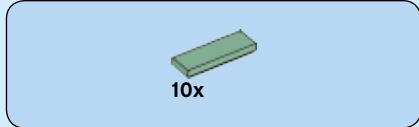
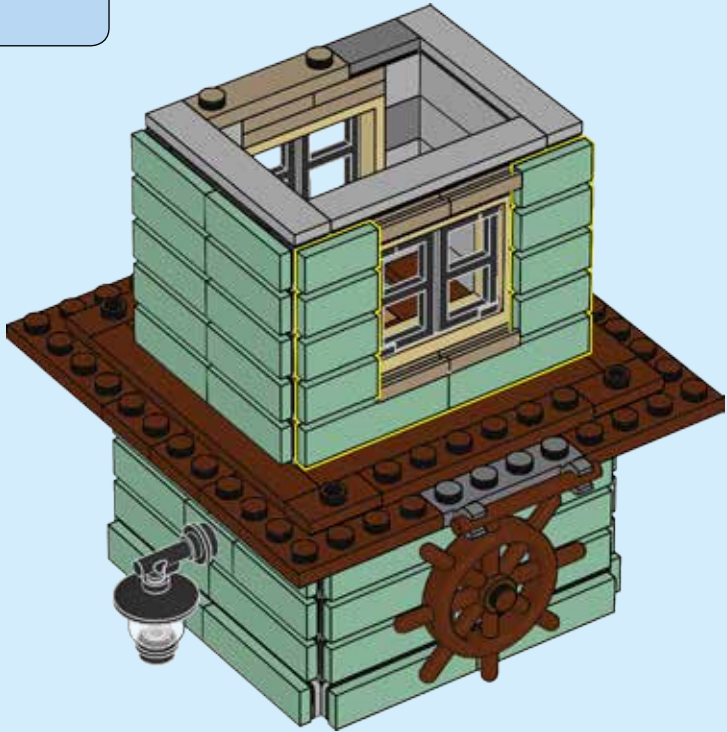

287

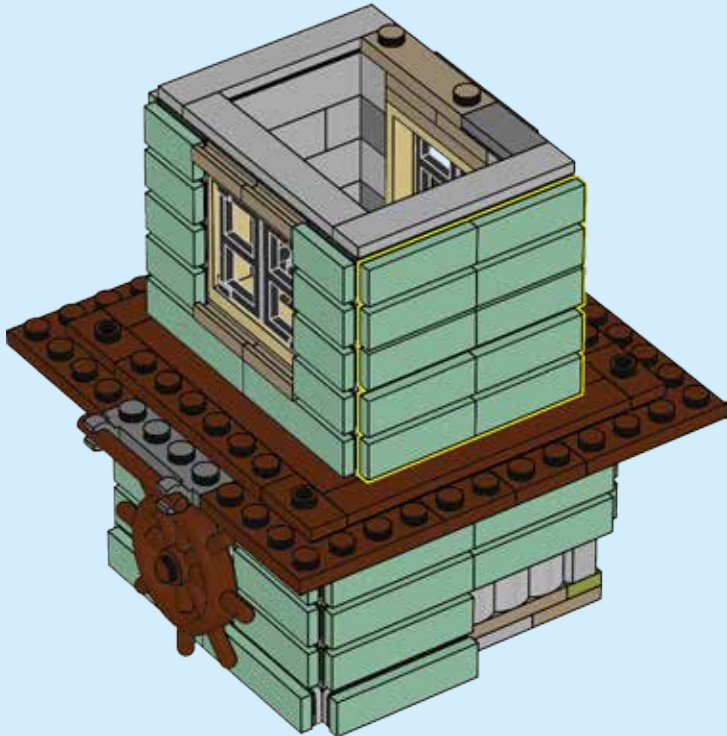
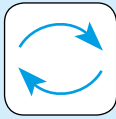

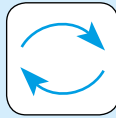
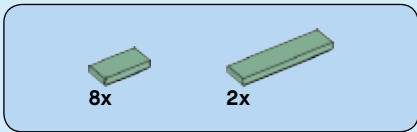

288

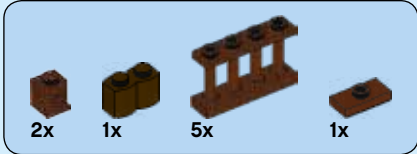
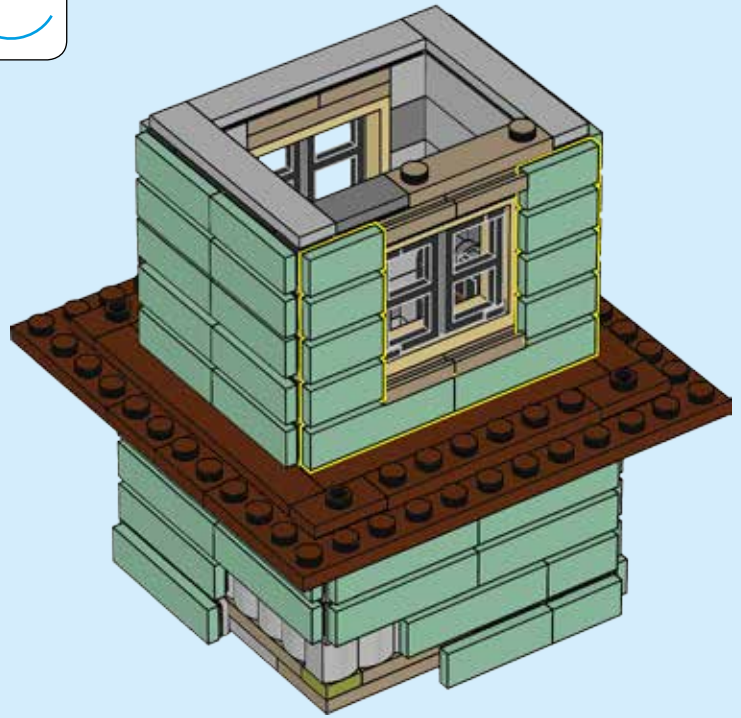

289

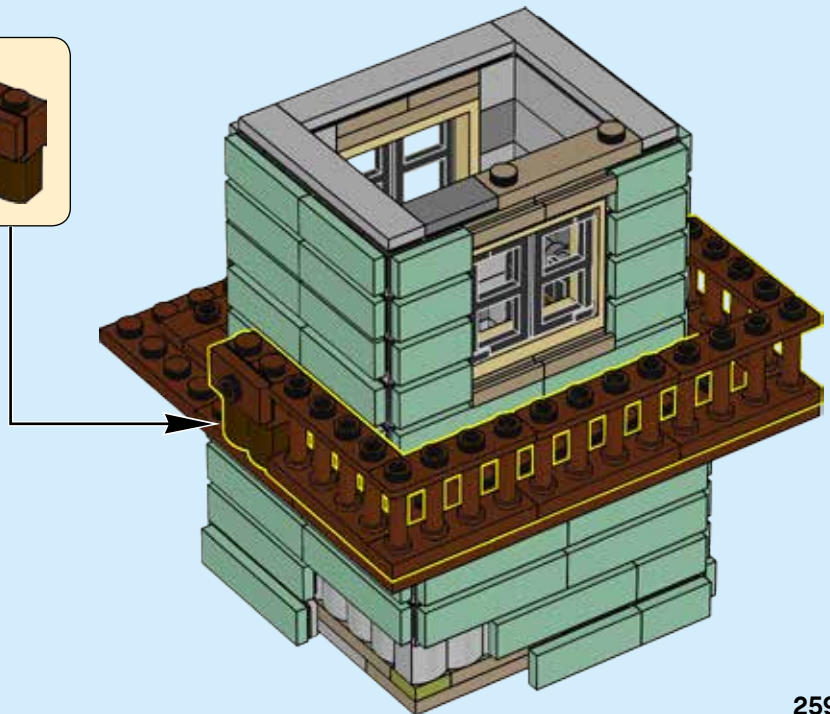

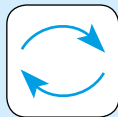
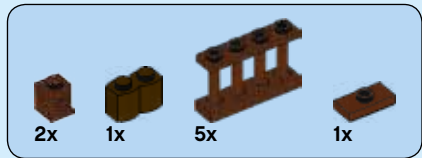

290

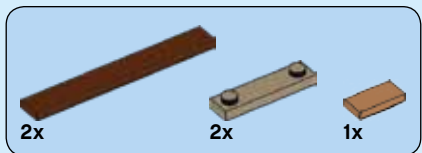
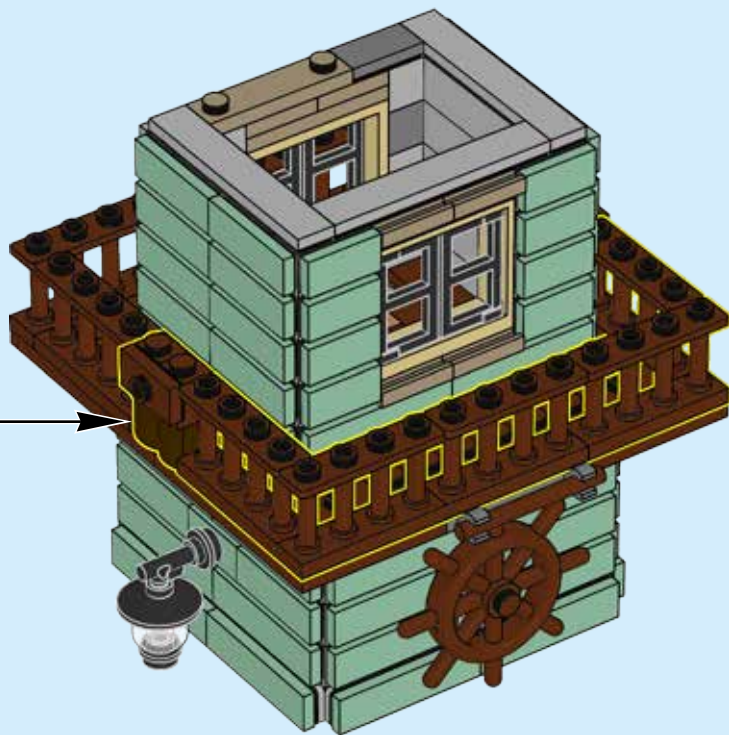

291

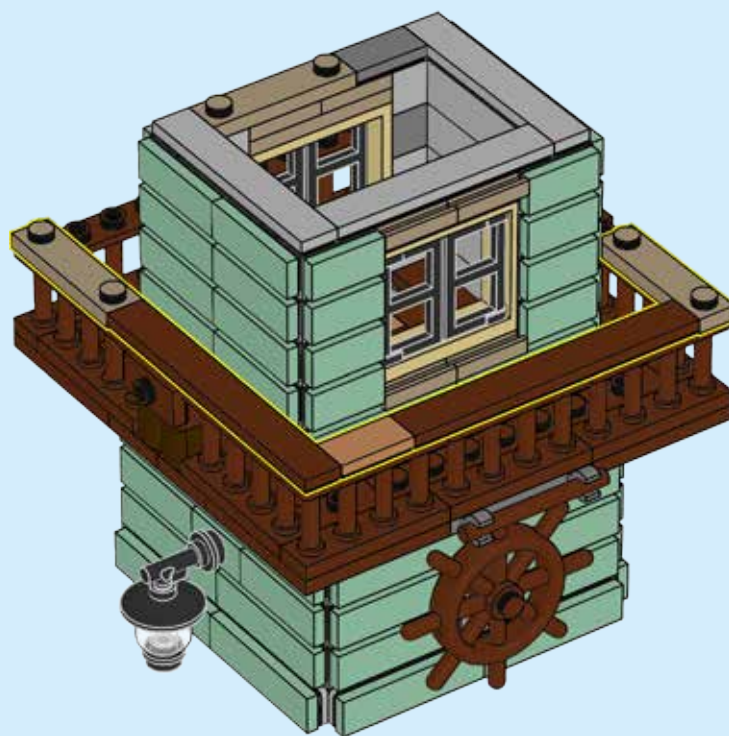

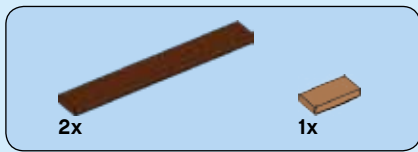

292

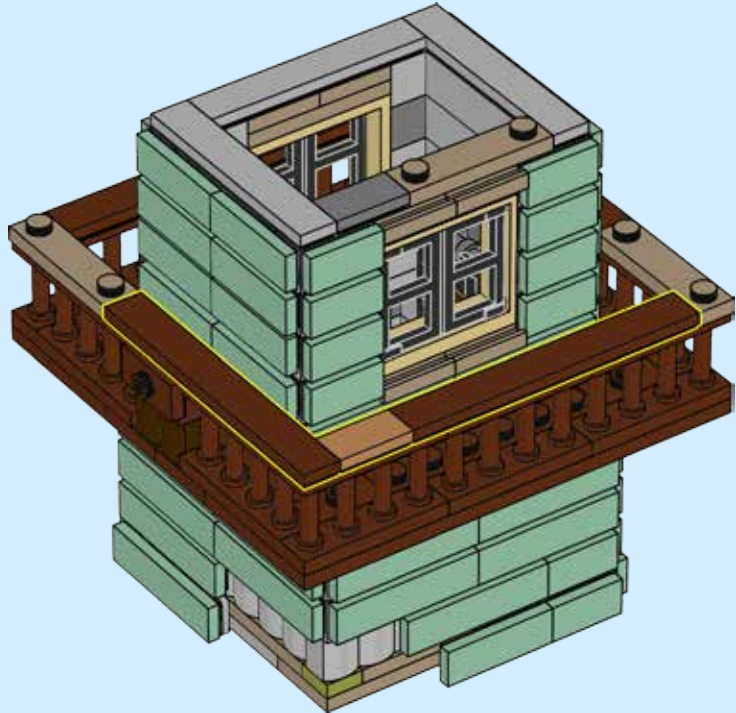
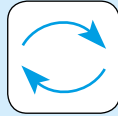

293

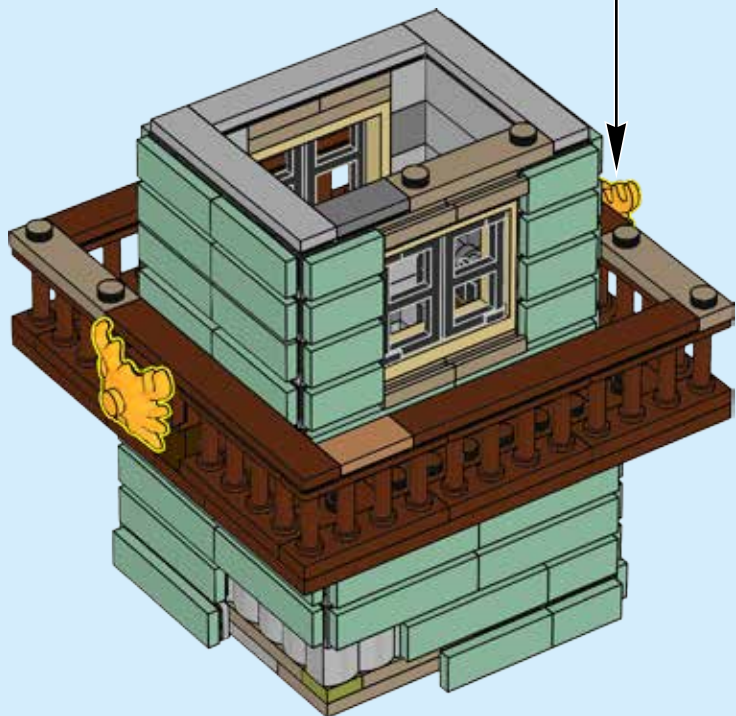

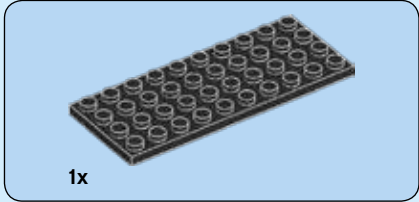

294

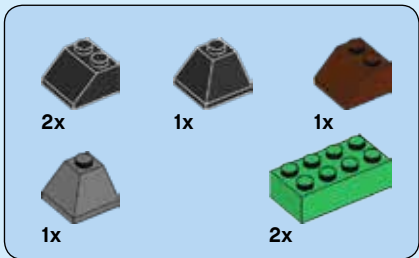
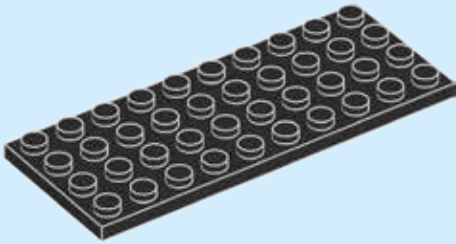

295

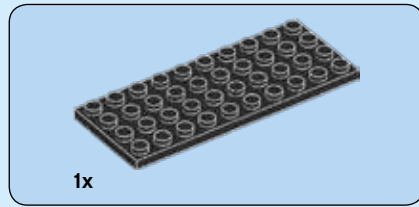
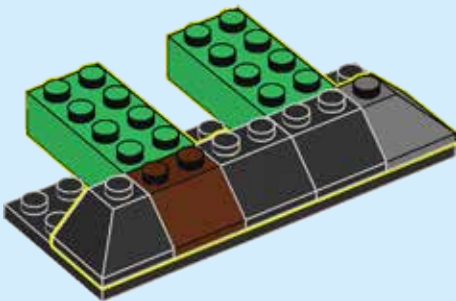

296

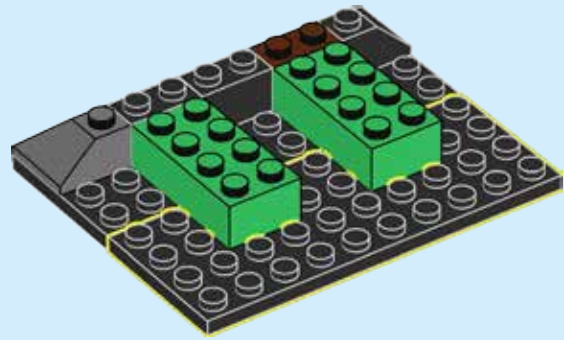
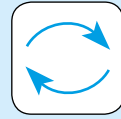

297

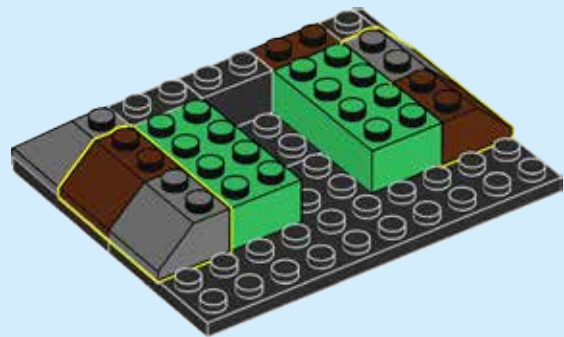

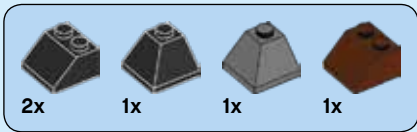

298

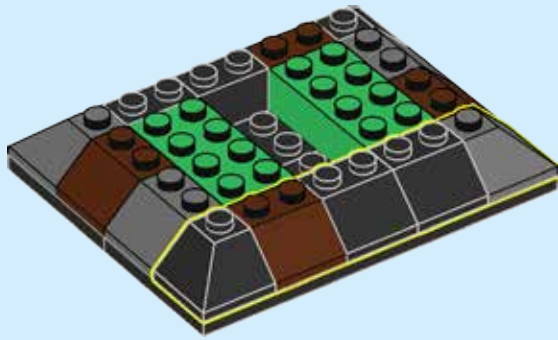

299

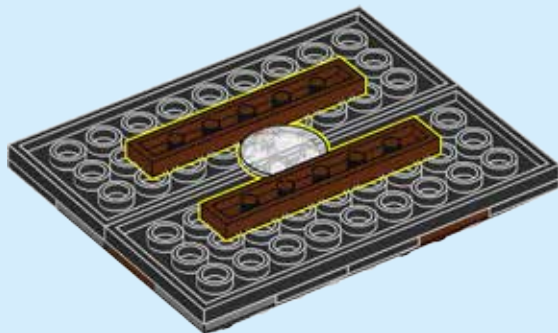
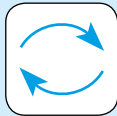

300

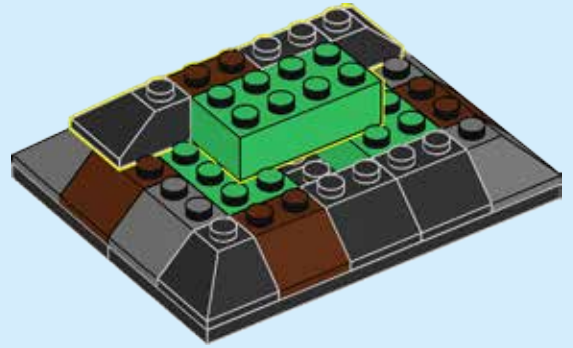
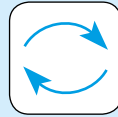

301

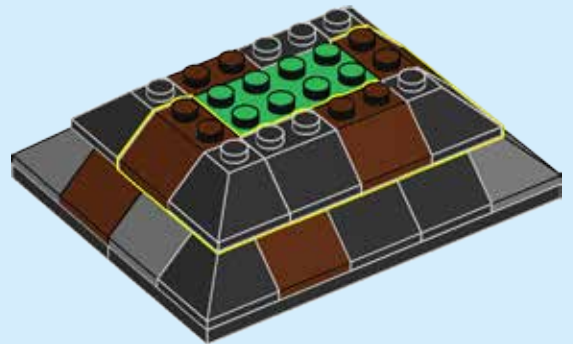



302

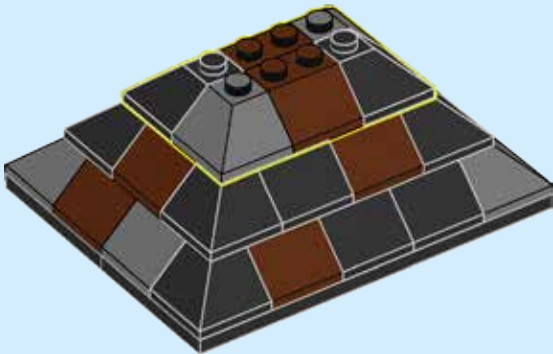

303

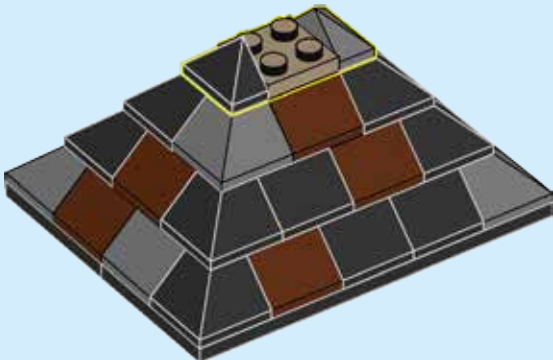

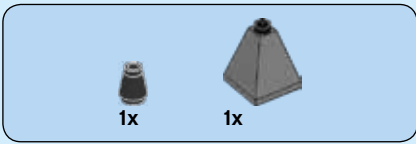

304

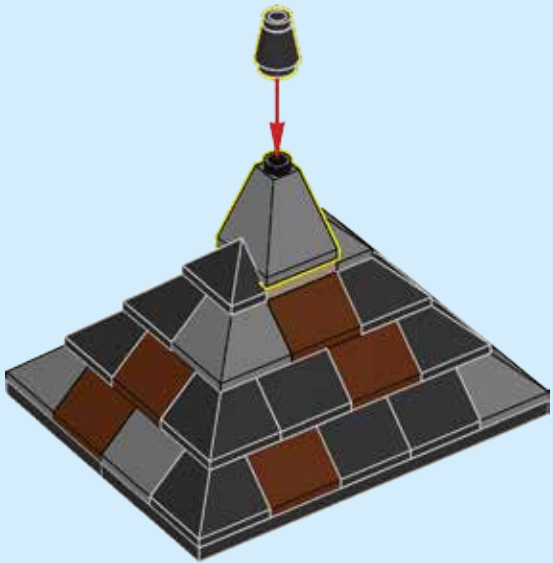

305

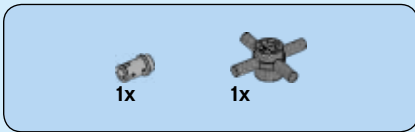
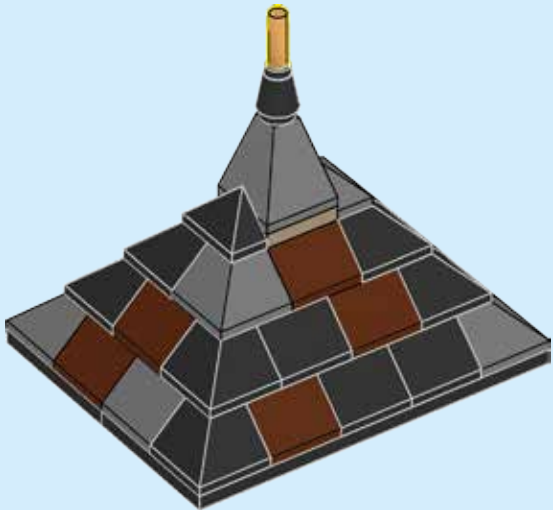

306

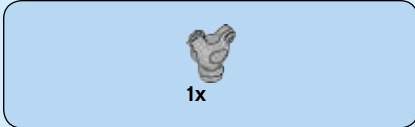
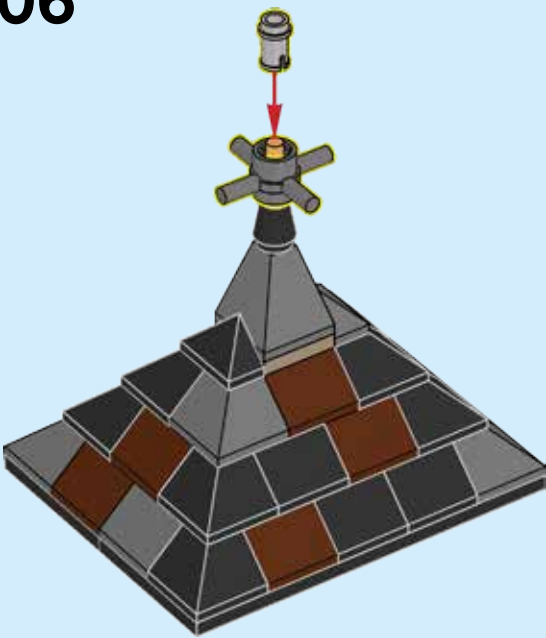

307

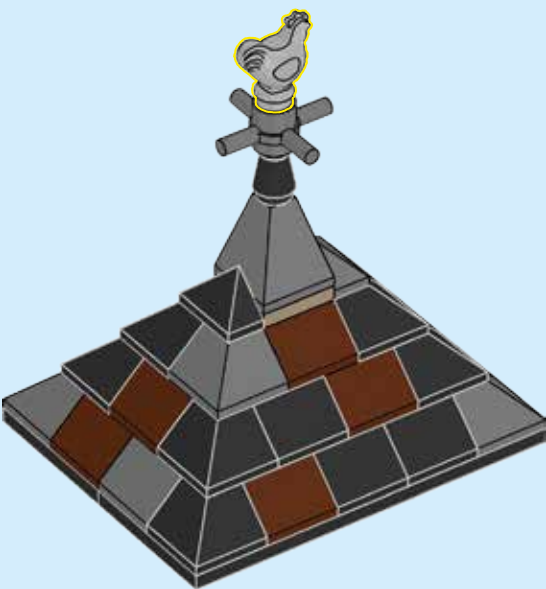



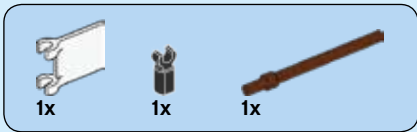

309

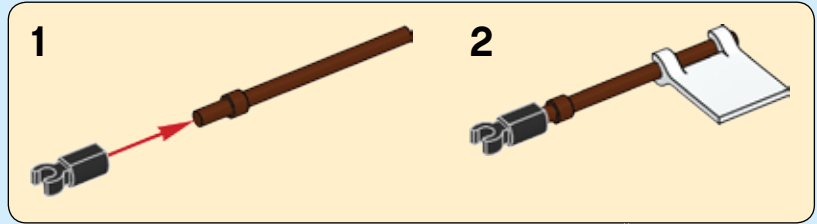
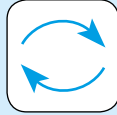



310

1

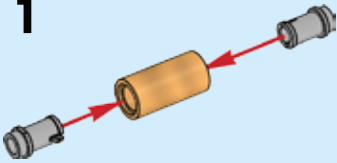

2



3

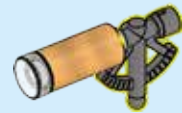

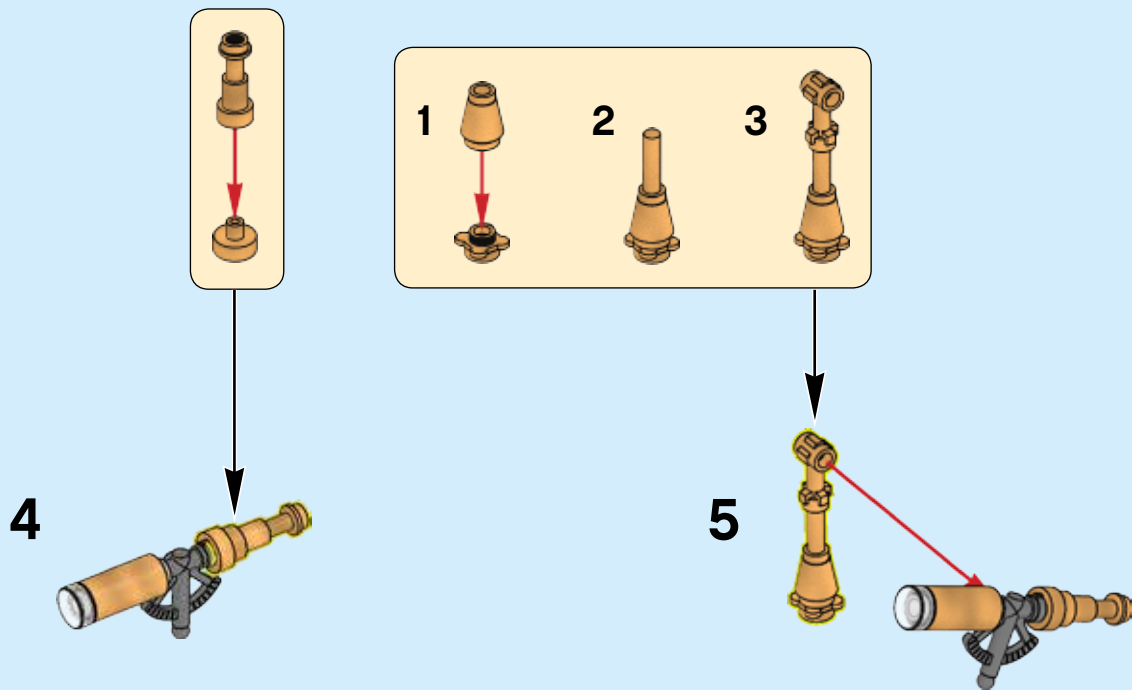

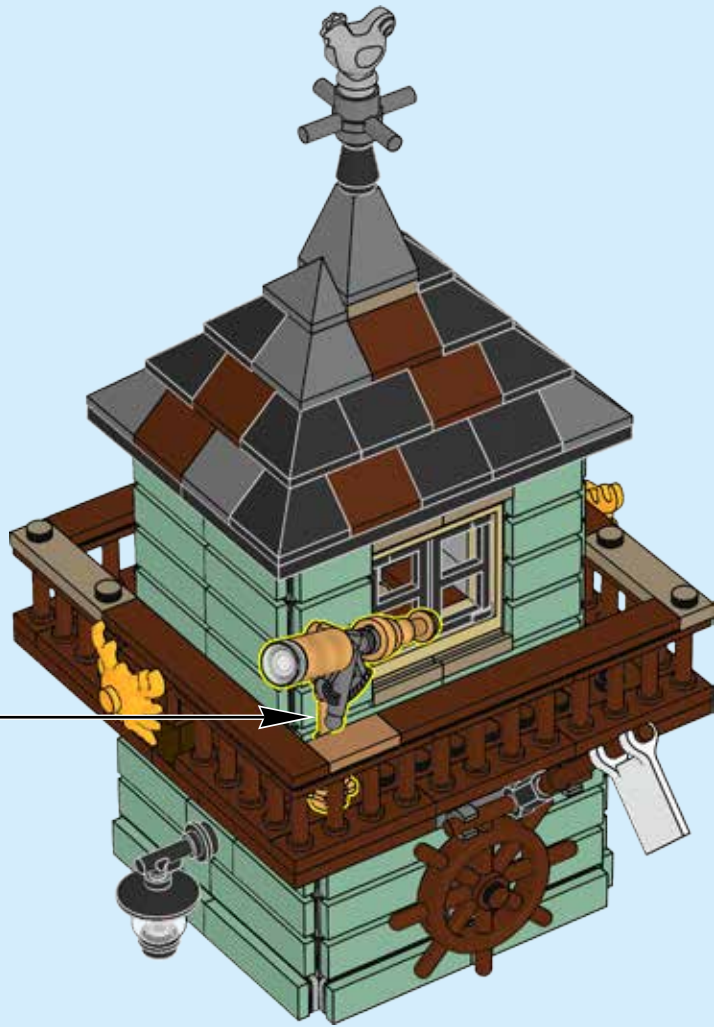

311

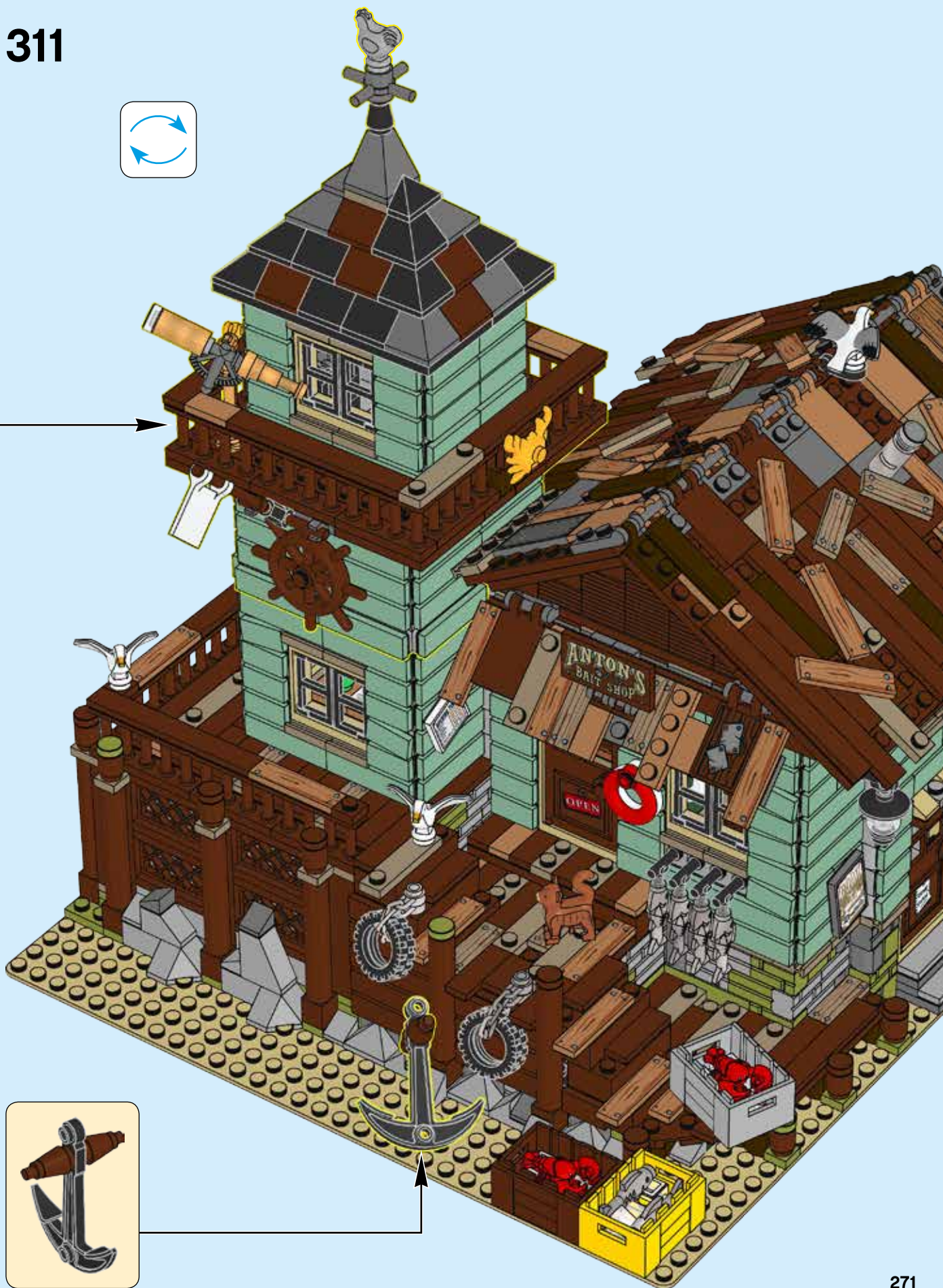
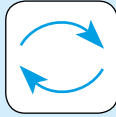

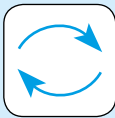

313

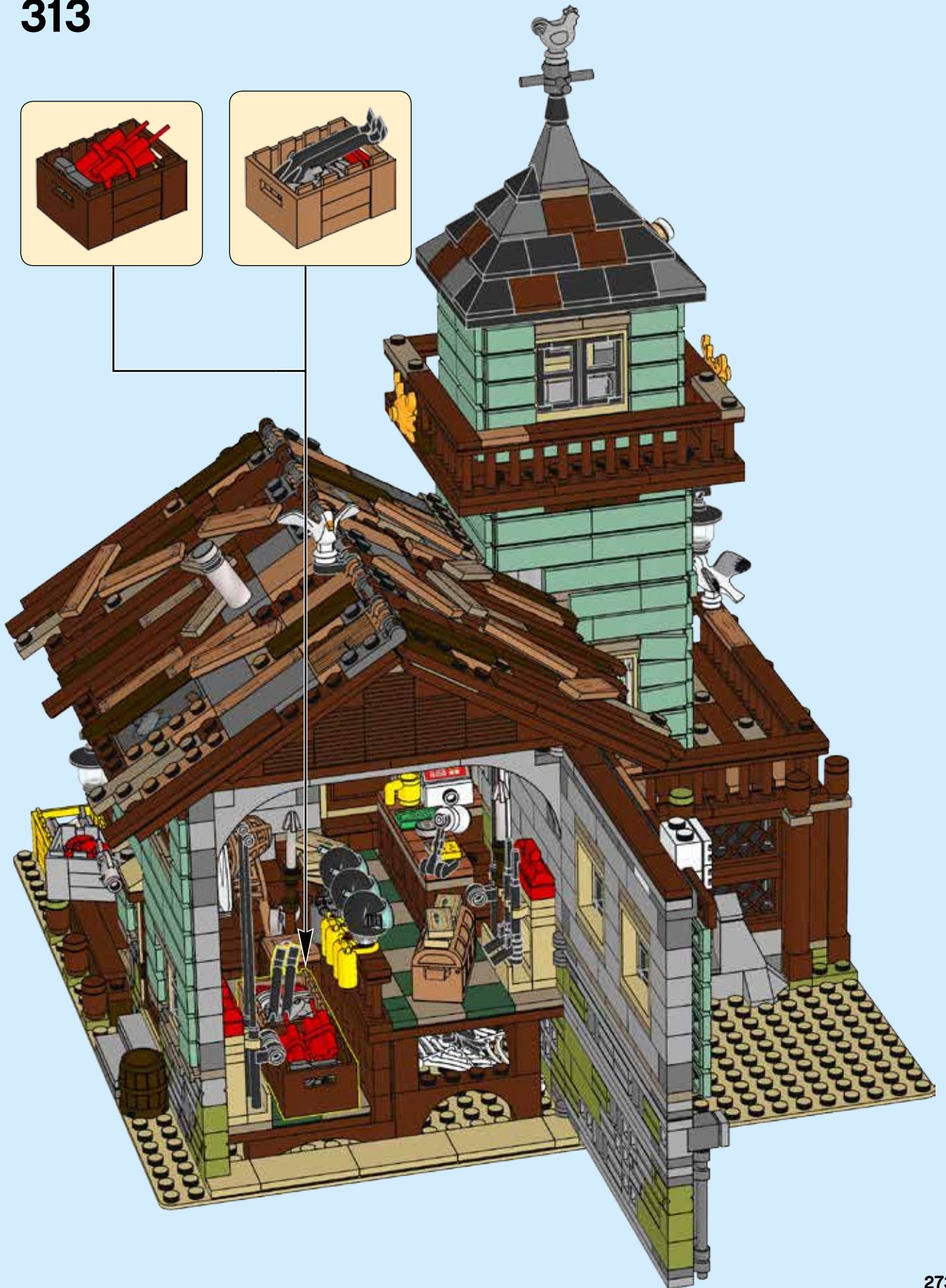
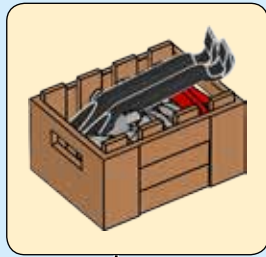
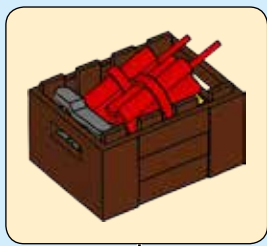



1x 6186681
1x 6173141
2x 6054551
1x 6179574
1x 4567912
1x 6058177
2x 6051511
2x 241201
1x 302301
3x 4297083
1x 6011794
1x 306801
1x 4655208
2x 6046979

3x 6208794

2x 6167187

1x 6006221

2x 4516055
6x 6029889

2x 4624086
4x 6092587

3x 6146221
4x 6205746
8x 4113917
3x 4578107
1x 6100077
1x 4524449
3x 4114077
2x 6173057
9x 4578109
2x 4578110
3x 6122047

1x 4558611

2x 4538780
1x 6056297
3x 6202627
2x 6172939
2x 6170934

1x 4620380
1x 6099581
1x 4651443
1x 4584727
1x 6205341
2x 6139426
1x 389924
2x 383824
2x 4648281
2x 362224
2x 371024
1x 4599378
1x 4514844

1x 6143596
2x 6060843
12x 4631385
1x 4162916
1x 4143005

1x 6205344
1x 6205345
1x 6153138
1x 6205335

5x 6047015
37x 6058245
20x 6058242
1x 6207113
22x 6202628
6x 6079617
11x 6062697
2x 6058219
1x 6187008
3x 6102774
5x 4560184
7x 4211065
2x 6081987
2x 4211100
2x 4211056
1x 6039699
4x 6133611
1x 6000970
2x 4210720

1x 6102984
1x 6035734
14x 6177146
11x 6021997
1x 6149979
2x 6102994
2x 6182225
2x 6126118
30x 6151654
7x 6167700
6x 6022075
1x 6167286
2x 6133832
2x 4536677
11x 4519970
2x 6141589
12x 4536989
2x 4519946

2x 6162578
1x 6078241
1x 6138964
2x 6096993
1x 6054858
8x 4611885
2x 6167576
4x 6064049
1x 4538126
2x 6093529
1x 4640843
1x 4529247
1x 6186672
1x 6170577
1x 6146054
1x 6170417
1x 6109756
1x 6207109
13x 6055171
12x 4528778
1x 4538760

2x 4163373
4x 300326
1x 368026
1x 6015891
1x 4529236
7x 6186646
6x 4289538
3x 4656122
16x 6143430
3x 4298619
2x 6157554
6x 4537551
1x 6051508
2x 403226
2x 474026
2x 6172936
1x 4505757
1x 4113209
2x 6064174
1x 4610371

8x 4189064
6x 303926
1x 4521681
1x 370526
2x 6186698
2x 6043130
14x 6115117
4x 6075062
1x 6170707
3x 4181144
1x 602026
1x 6030875
5x 611226
2x 303026
1x 4654448
2x 6172934

1x 4529239
1x 4567908
2x 6206248
1x 4295260
3x 4106356
16x 4666322
1x 6182674
8x 6092602
2x 4614158
2x 4650498
1x 3005740
3x 6112751
5x 3001140
6x 4244362
9x 6047501
4x 6024020
3x 4278412
1x 4552033
5x 6184432
107x 4616578
35x 6202626
83x 6192923

1x 3005744
3x 6055172
7x 6135609
7x 4496699
34x 4528604
61x 4616711
12x 4507045
9x 6047415
1x 4633881
4x 6126075
2x 6132768
17x 6177892
27x 4626904
20x 6146462
2x 6156492
2x 6167894
4x 4246957
1x 6186006
1x 6133925
2x 6005772

2x 4216581
11x 6133854
12x 4520612
5x 4221744
4x 4225469
2x 6071274
2x 6103769
3x 6123759
5x 6116613
4x 4211189
8x 4216625
1x 6132732
10x 4211181
14x 6202676
23x 6066114
7x 4211194
6x 4544525
1x 6205749

1x 4548857
7x 4221590
1x 6177998
5x 4655611
2x 4243838
5x 4224732
2x 4609635
8x 4216945
43x 4585337
6x 6174242
3x 4263776
9x 4211211
18x 4211186
10x 4211201
2x 4211185
1x 6081990

15x 4211183
 2x 4529242
 2x 4211288
 1x 6093515
 4x 6035291
 3x 4211180
 20x 4223303
 6x 6172808
 8x 4211222
 16x 6092590
 24x 4211151
 6x 4595814
 10x 4277016
 4x 4565394
 6x 4211200
 10x 4211202
 1x 4211210
 6x 4520638
 38x 6100769
 4x 4211197

1x 4223729
 1x 6065139
 2x 4264669
 4x 6132734
 5x 4211207
 1x 6096716
 3x 4499885
 1x 4211438
 1x 4251149
 9x 4514846
 1x 4512049
 2x 4211366

1x 4520155
 4x 6093859
 4x 4515374
 35x 6000066
 3x 4211564
 94x 6015344
 3x 4211483
 13x 4211476
 12x 4521921
 1x 6142309
 2x 6061702
 2x 4255629
 2x 6135556
 1x 6146899
 1x 4541978
 2x 4535764
 3x 6075075
 1x 4540203
 28x 4550325

6x 4211614
 2x 4654582
 2x 4535738
 1x 4622060
 2x 4211650
 4x 4211349
 2x 6065824
 8x 4211387
 1x 6007894
 7x 6034676
 5x 4211429
 6x 6014615
 2x 4211833
 2x 4211356
 75x 4211636

1x 4599498
 1x 6102769
 2x 4211395
 8x 4211385
 2x 6075066
 1x 6108560
 10x 4211549
 2x 4211081
 2x 4211055
 1x 4645099
 4x 4210646
 2x 4211054
 4x 4521187

56x 4558955
 8x 4504378
 1x 4210934
 6x 4587212
 1x 6076203
 28x 4211095
 2x 4217675
 7x 6000311
 9x 4211052
 13x 6000606
 1x 4500608
 1x 4211128
 10x 6146321
 1x 4222192
 1x 4211129
 2x 4210635



Customer Service
 Kundenservice
 Service Consommateurs
 Servicio Al Consumidor
 LEGO.com/service or dial



 : 00800 5346 5555
 : 1-800-422-5346



IDEAS

LEGO® REVIEW
EXAMEN LEGO®
REVISIÓN DE LEGO®

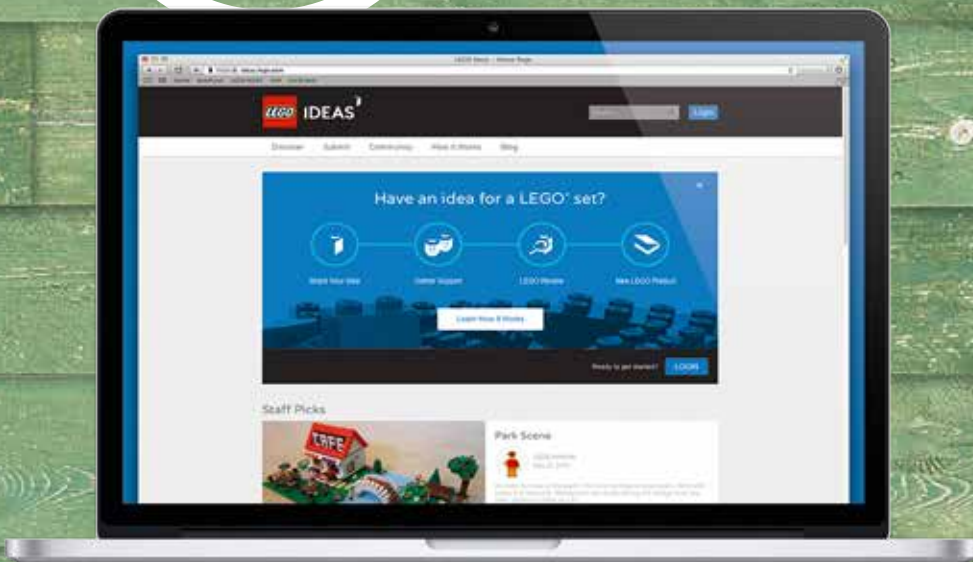
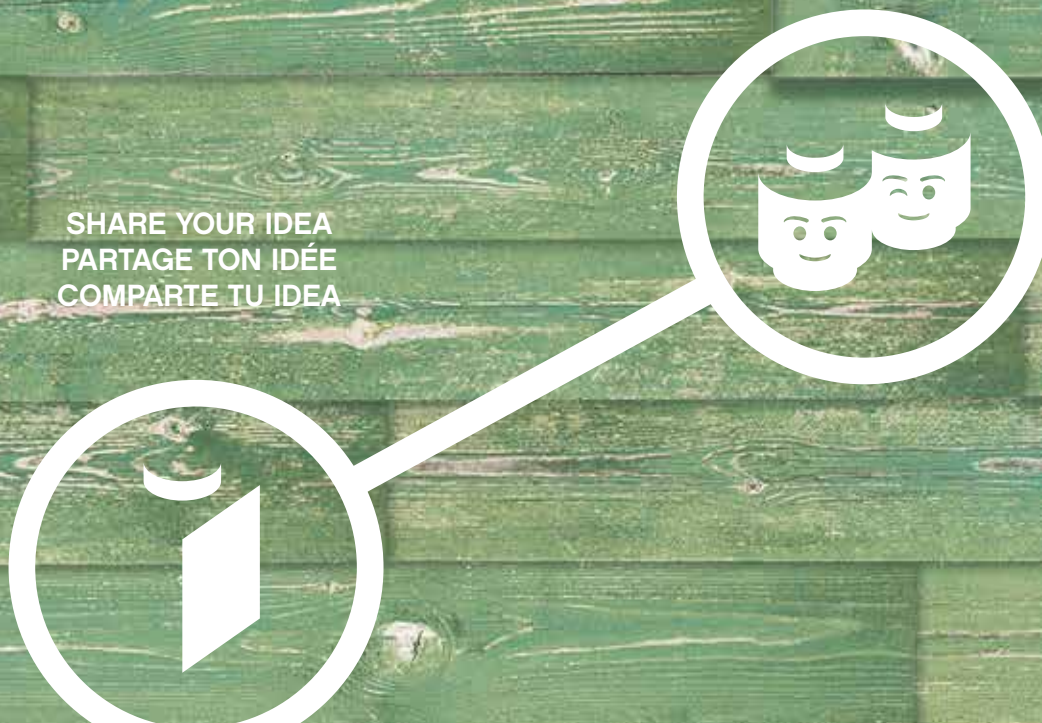
SHARE YOUR IDEA
PARTAGE TON IDÉE
COMPARTE TU IDEA



GATHER SUPPORT
OBTIENS DE L'APPUI
OBTÉN APOYOS

NEW LEGO® PRODUCT
NOUVEAU PRODUIT LEGO®
NUEVO PRODUCTO LEGO®



[LEGO.COM/IDEAS](https://www.lego.com/ideas)



IDEAS

Do you like this LEGO® Ideas set?

The LEGO® Group would like your opinion on the new product you have just purchased. Your feedback will help shape the future development of this product series. Please visit:

LEGO.com/productsurvey

By completing our short feedback survey, you will be automatically entered into a drawing to win a LEGO® prize.

See website for official rules and details. Open to all countries where not prohibited.



Aimez-vous cet ensemble LEGO® Ideas ?

Le Groupe LEGO® aimerait connaître votre opinion sur le produit que vous venez d'acheter. Vos commentaires nous aideront à concevoir les futurs produits de cette gamme. Veuillez visiter :

LEGO.fr/productsurvey

En remplissant ce court sondage sur le produit, vous serez automatiquement inscrit à un tirage au sort pour gagner un prix LEGO®. Consultez le site Web pour obtenir le règlement officiel et les détails. Ouvert à tous les résidents des pays autorisés.

¿Te gusta este set LEGO® Ideas?

The LEGO® Group quiere conocer tu opinión acerca del nuevo producto que acabas de comprar. Tus comentarios nos ayudarán a dar forma a los futuros productos de esta serie. Visita:

LEGO.com/productsurvey

Al contestar este breve cuestionario de opinión, participarás automáticamente en el sorteo de un producto LEGO®. Consulta las reglas oficiales y demás información en el sitio web. Válido en todos los países en los que esta actividad no esté prohibida.