





LEGO.com/sustainable-packaging



MILAN MADGE
Model Designer,
LEGO Group

PAZZO PER I FIORI

🌸 "Che tu stia coltivando la tua Collezione Botanica LEGO® o che questa sia la tua prima composizione floreale LEGO, probabilmente vai pazzo per i fiori come noi. Questo bouquet è un fresco mix di fiori che potresti raccogliere in un campo o in un giardino, e abbiamo abbinato colori e specie complementari provenienti da tutto il mondo per celebrare la biodiversità del nostro pianeta e la bellezza rilassante che amiamo in natura.

Mi auguro che vi divertirete a costruirlo!"

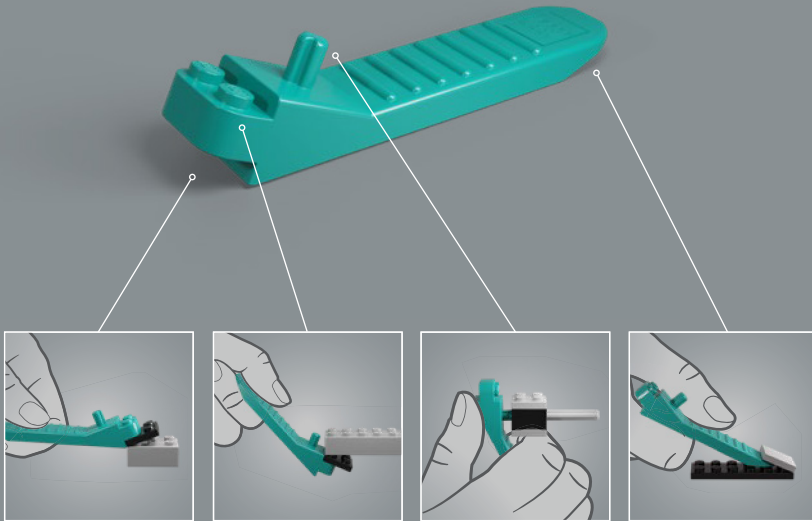

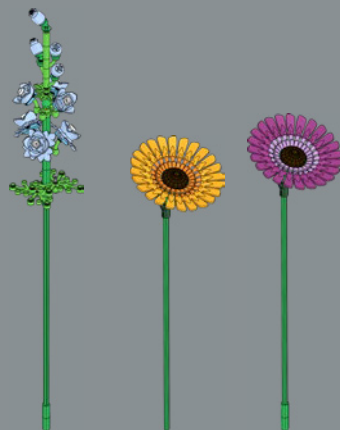
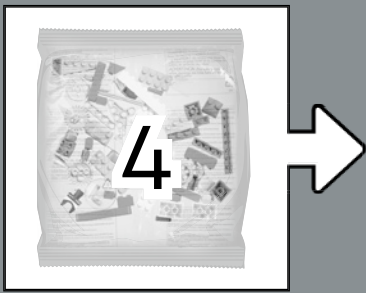
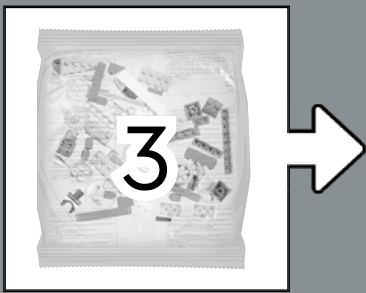
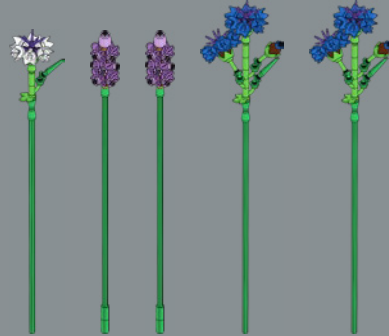
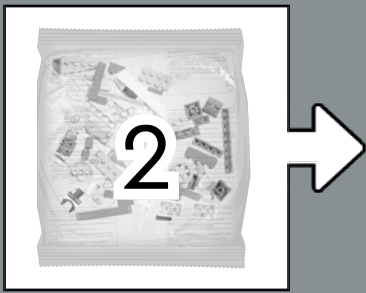
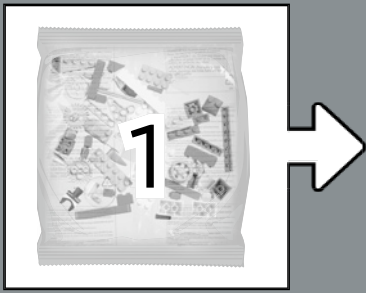

FELCE CUOIO

(Rumohra adiantiformis)

✿ La cespugliosa e lussureggiante Felce cuoio, originaria dei climi tropicali dell'emisfero meridionale, è molto popolare tra i giardinieri di tutto il mondo. Sebbene non fiorisca, il fogliame "piumoso" è molto amato dai fiorai ed è usato come riempitivo decorativo nelle composizioni floreali.



CERFOGLIO SELVATICO

(Anthriscus Sylvestris)

✿ Questa ariosa ombrellifera dotata di piccoli fiori bianchi può essere ammirata nelle zone ombreggiate di tutta Europa, Asia e Africa. I suoi fiori, simili a nuvola di fuochi d'artificio, sono una delizia per api, falene, farfalle e altri insetti in cerca di polline all'inizio della primavera. Sapevi che viene spesso utilizzata anche come repellente per le zanzare?

PAPAVERO DEL GALLES

*(Meconopsis cambrica/
Papaver cambricum)*

✿ Segnalando l'arrivo della primavera e dell'estate nelle isole britanniche e nell'Europa occidentale, questo morbido e dorato papavero gallese può essere ammirato nelle siepi, nei campi e lungo i bordi delle strade. Nonostante la sua struttura e i petali molto delicati, prospera anche in ambienti rocciosi con pochissimo terreno e nelle intercapedini tra le lastre dei giardini pavimentati o dei marciapiedi cittadini.

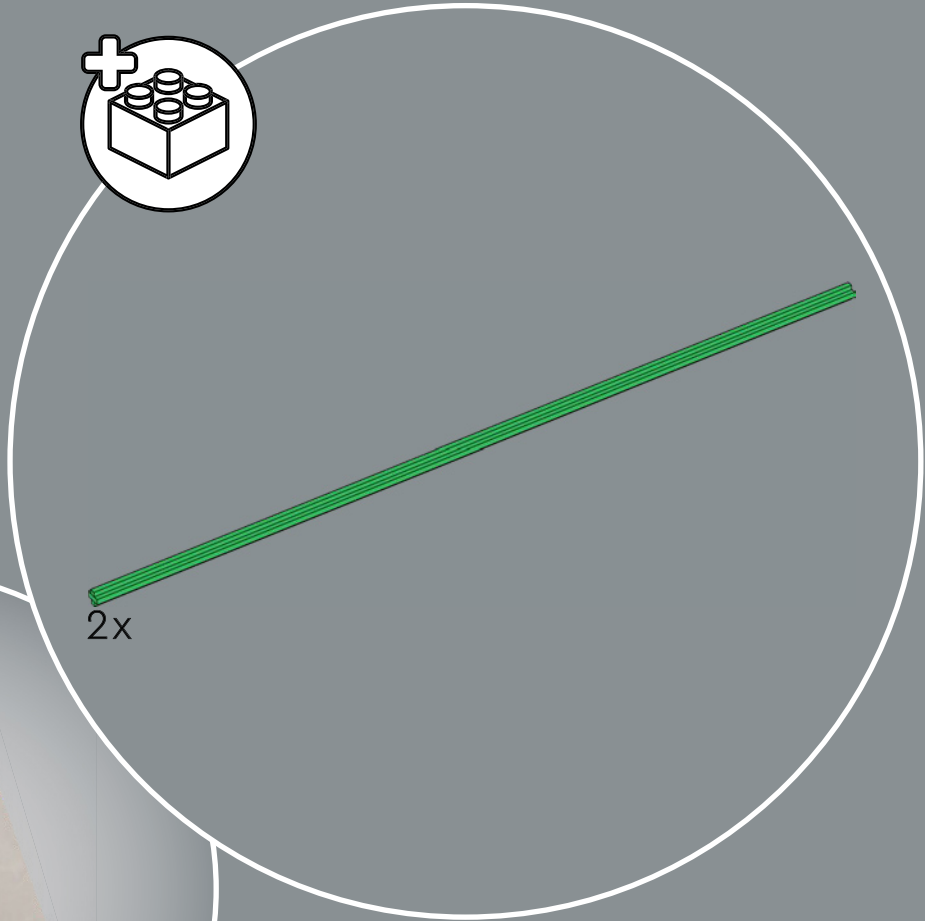
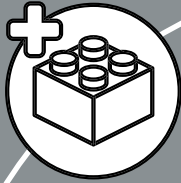

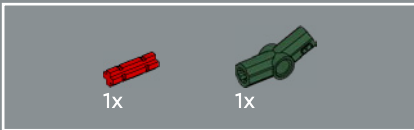

1

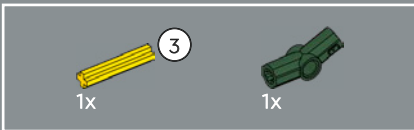
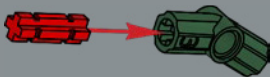

2

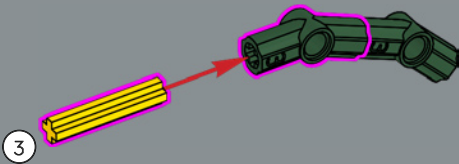

3

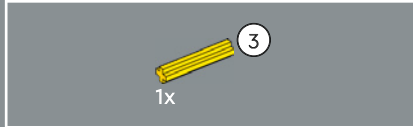
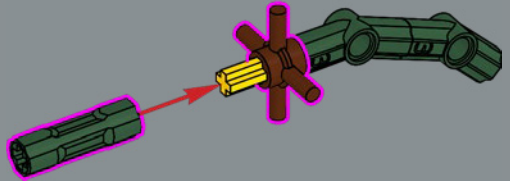

4

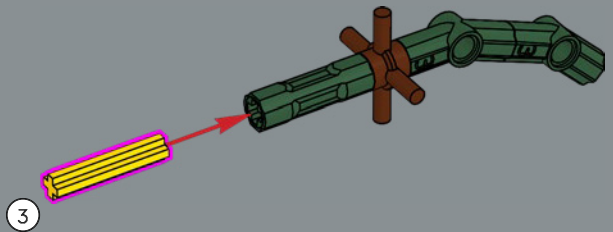

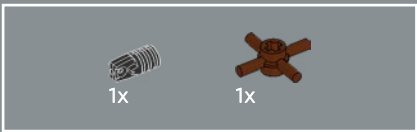

5

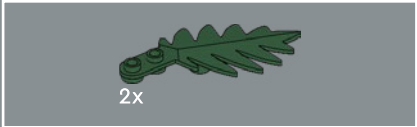
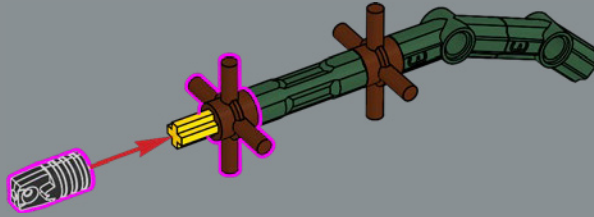

6

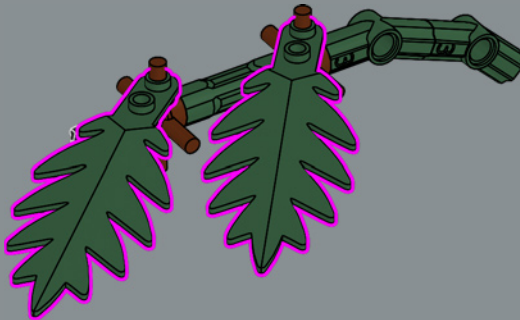

L'elemento della foglia di palma è stato introdotto per la prima volta nel nostro tema LEGO® Pirati negli anni '90. Ora viene riutilizzata per creare la Felce cuoio.

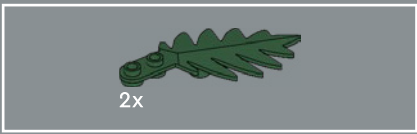

7

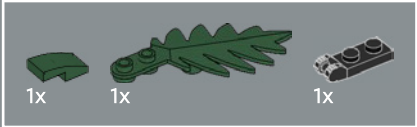

8

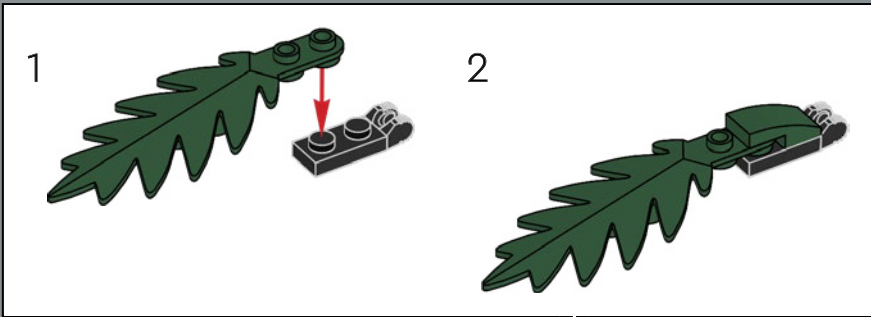

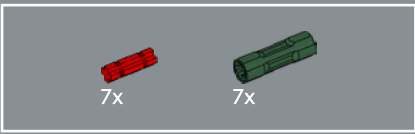

9

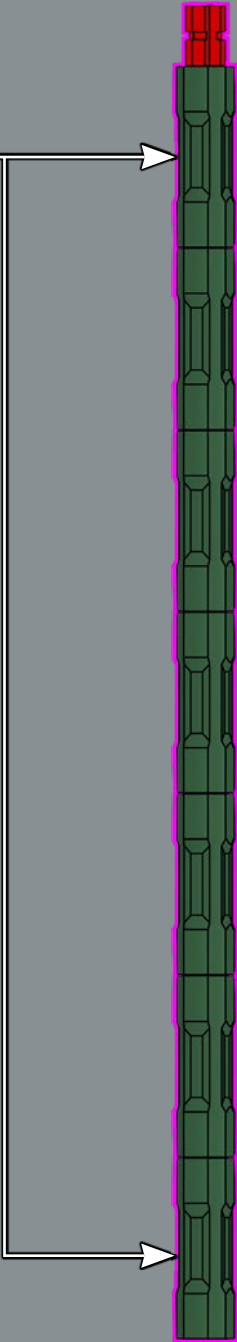
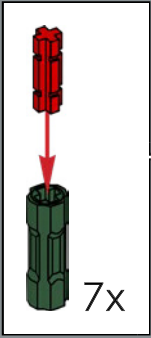

1:1

10

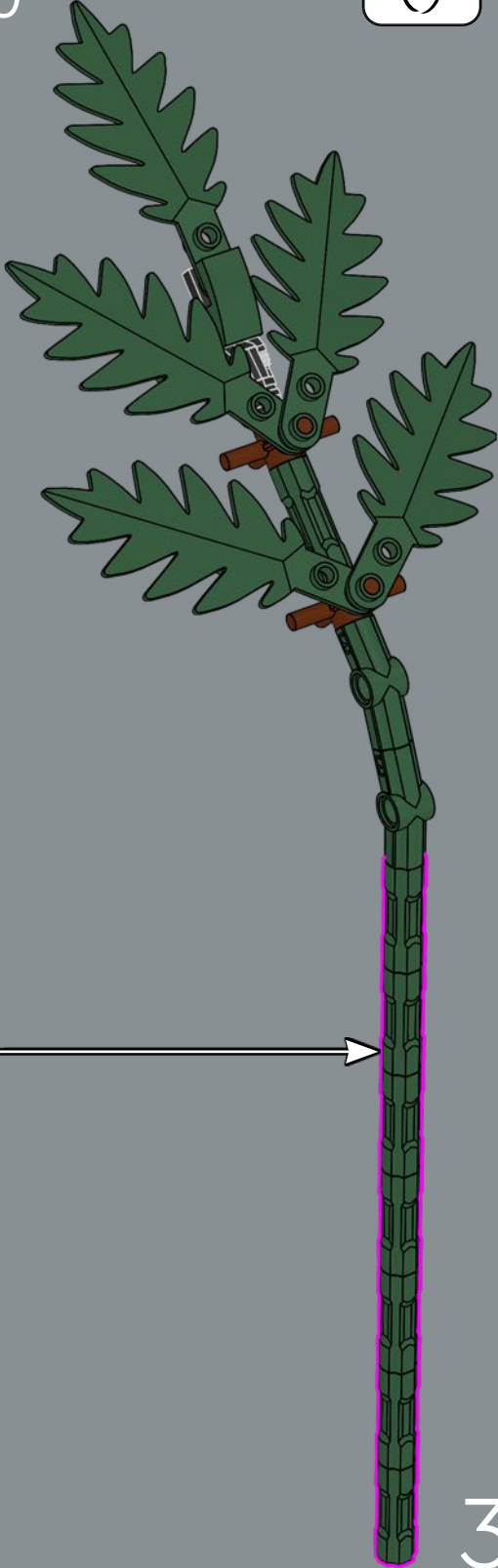

3x

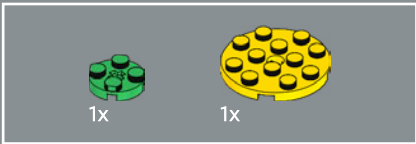
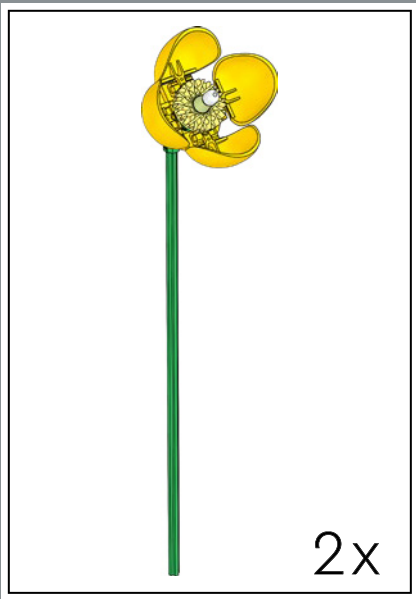

1

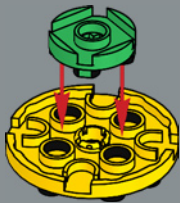

2



3

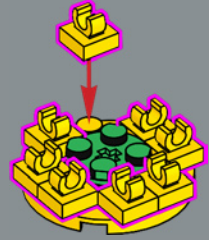

4

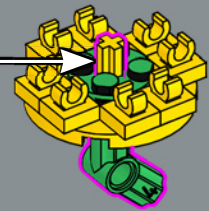
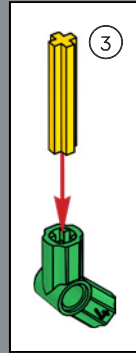

5

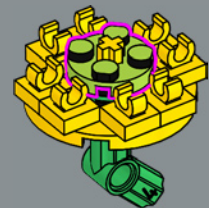



L'utilizzo insolito di elementi esistenti è una delle fondamenta delle costruzioni LEGO®. Qui, il mozzo di un'automobile è stato utilizzato per rappresentare lo stigma al centro del Papavero gallese.

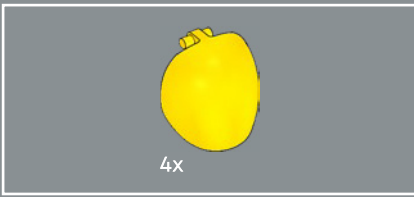

6

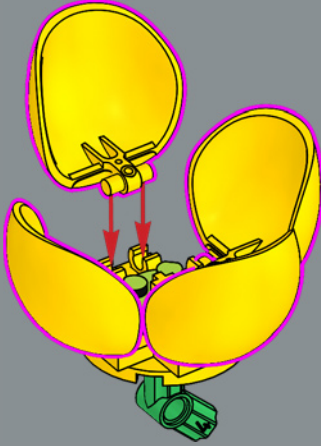

7

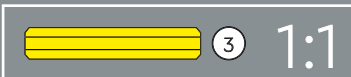
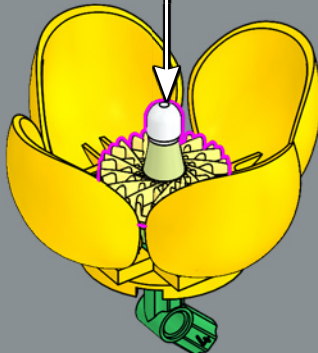
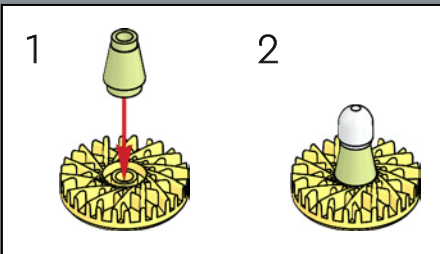

8

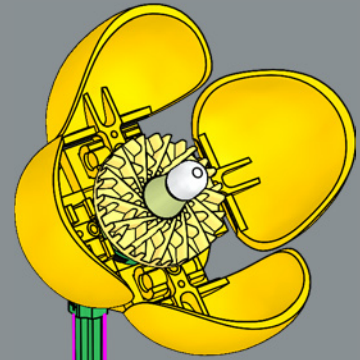

32

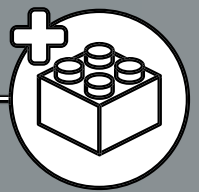

2x

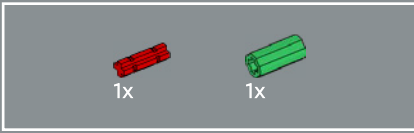
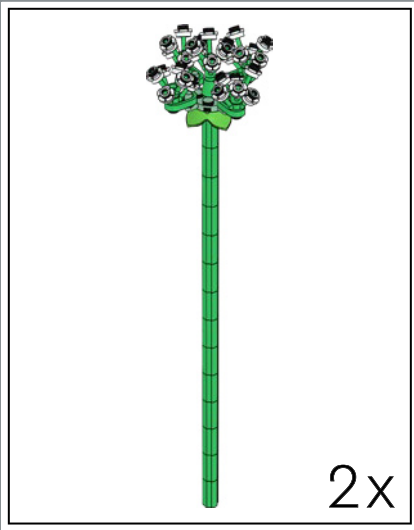

1

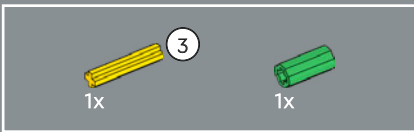

2

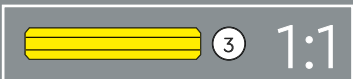

3

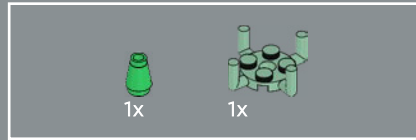

4

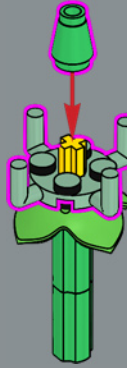

5

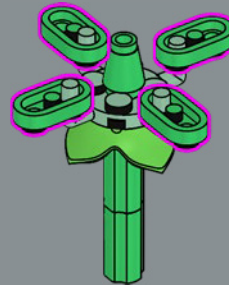

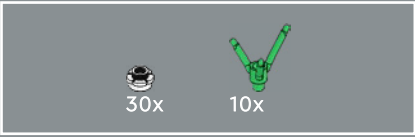
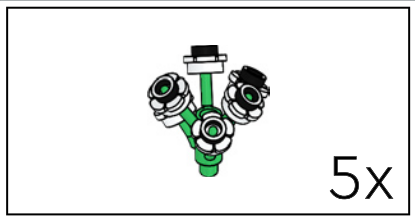

6

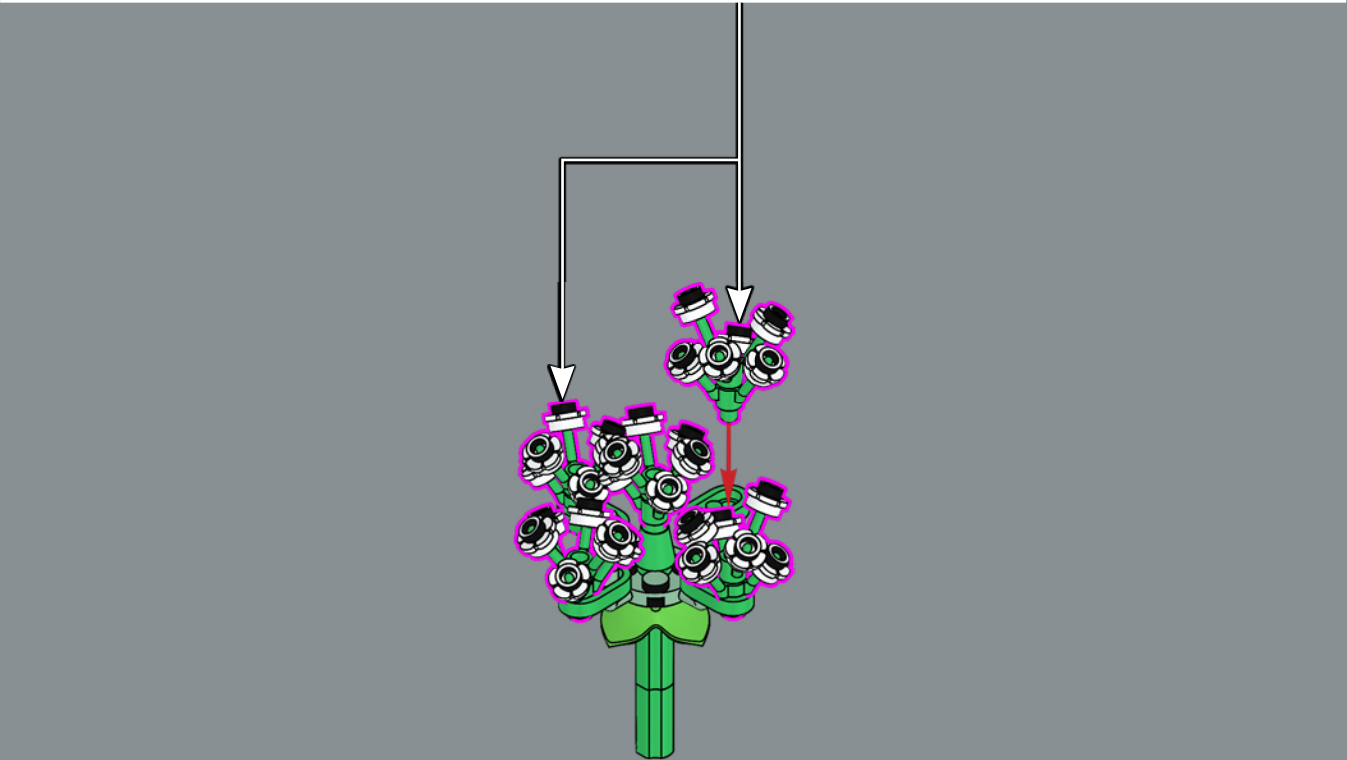
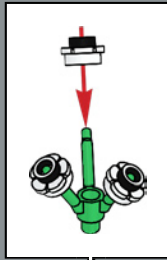
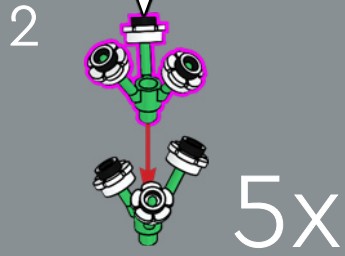
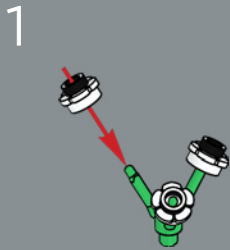

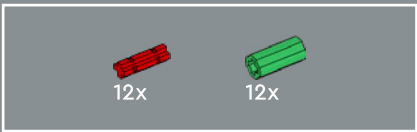

7

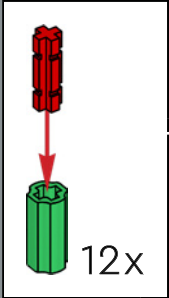

1:1



Il cerfoglio è considerato da molti il fratello sconosciuto del prezzemolo. Le sue foglie infatti sono utilizzabili in moltissime preparazioni gastronomiche. Esistono diverse varietà, tra cui il cerfoglio riccio.

8

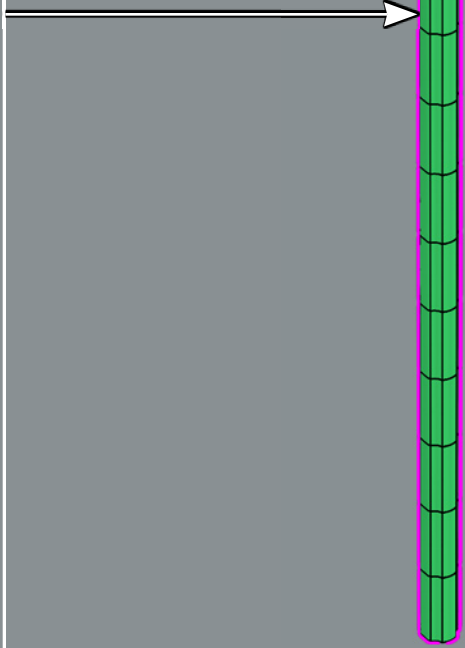

2x



FIORDALISO

(Centaurea cyanus)

🌸 Il coloratissimo ma delicato fiordaliso decora i campi e i giardini in bianco, rosa e blu dall'inizio alla metà dell'estate, soprattutto in Europa, Nord America e Asia. Il suo profumo dolce e il suo nettare attirano farfalle e api, rendendo il fiordaliso un compagno seducente per l'orto o il frutteto.



LAVANDA

(Lavandula)

🌸 Arbusto sempreverde dai colori violacei e dall'aroma rilassante, la lavanda ornamentale è tanto utile quanto decorativa. Originaria del Mediterraneo, del Medio Oriente e del Nord Africa, è largamente utilizzata come erba aromatica in cucina, per la distillazione di oli essenziali per la cosmesi e in erboristeria.

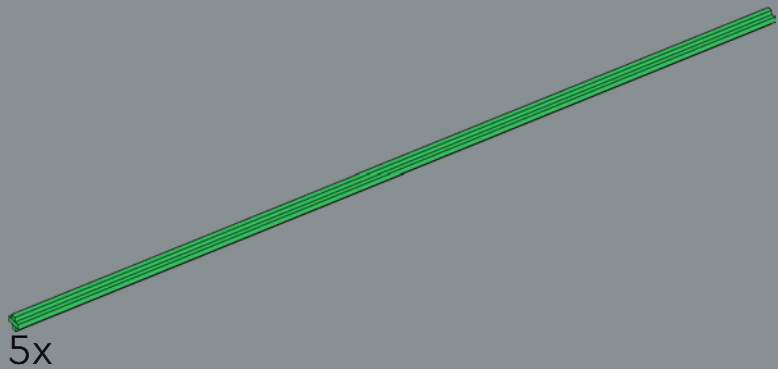
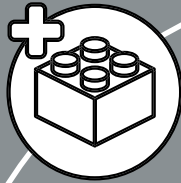

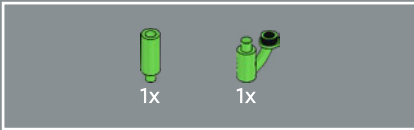
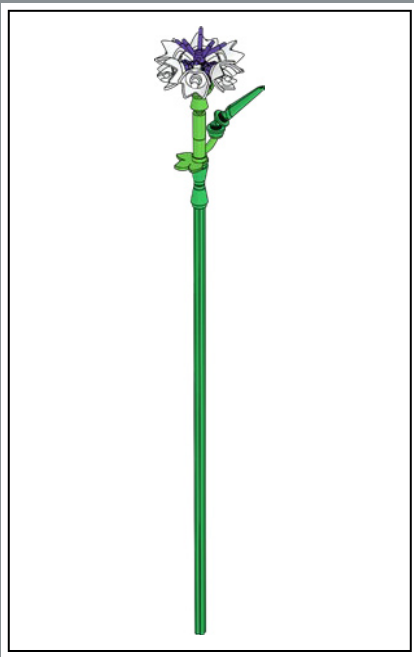

1

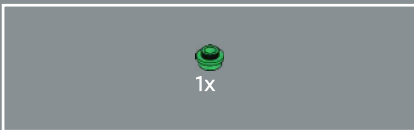

2

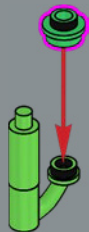

3

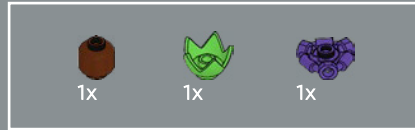
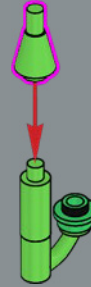

4

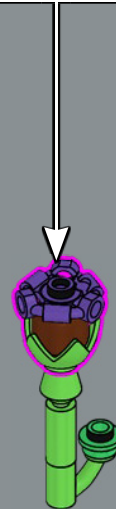



3x



3x

5

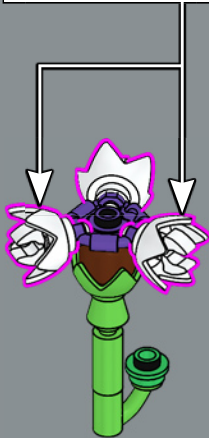
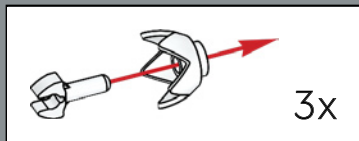

3x

6

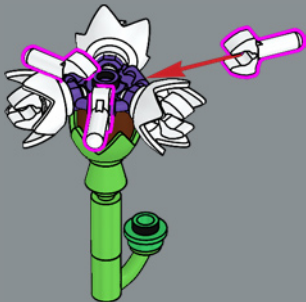

3x

7

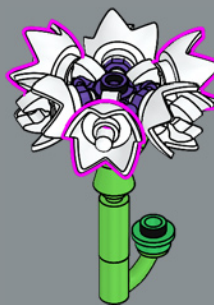

1x

8

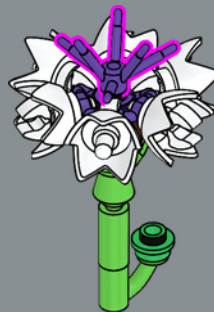

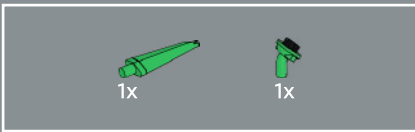

9

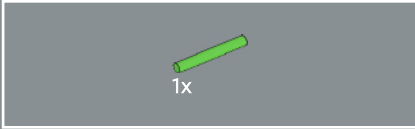
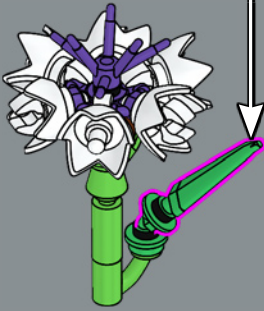
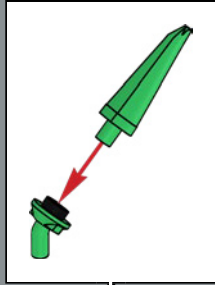

10

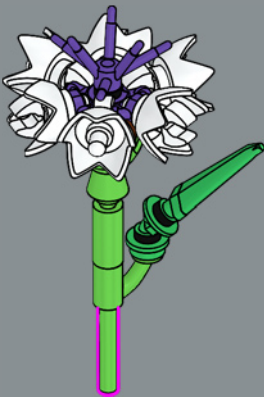

11

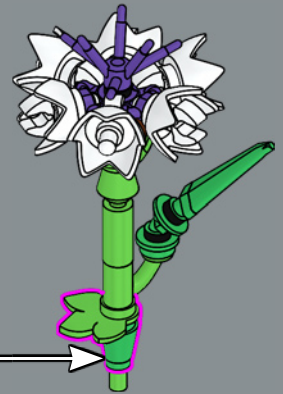
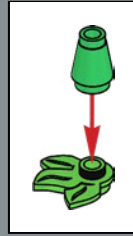



12

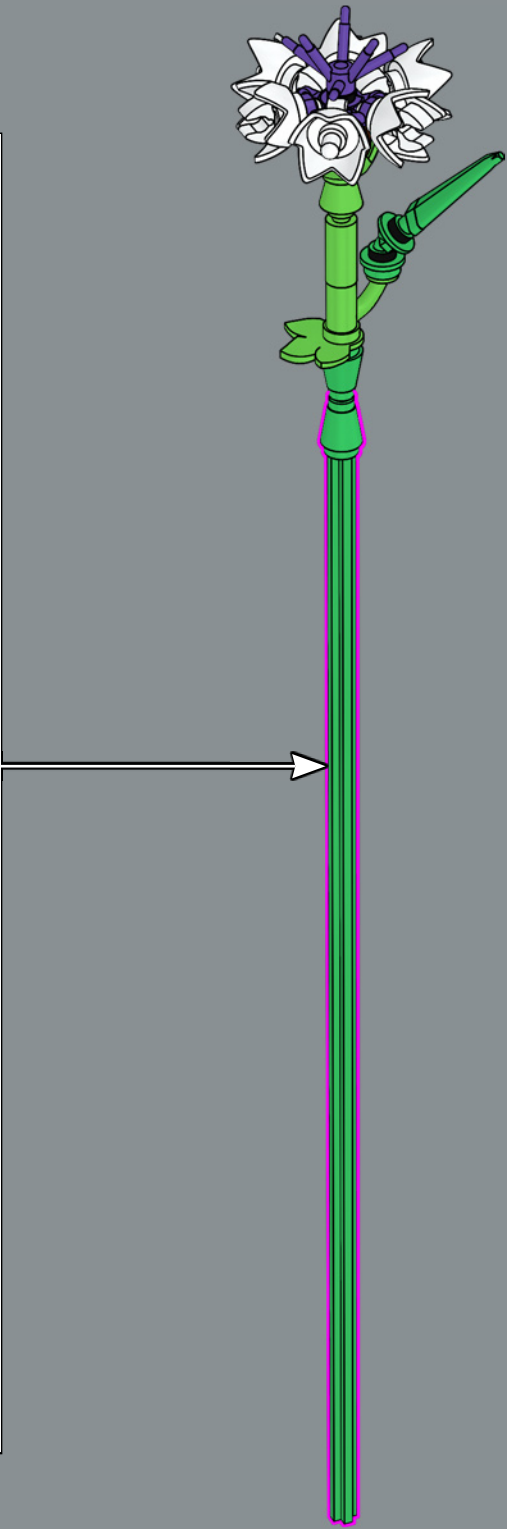
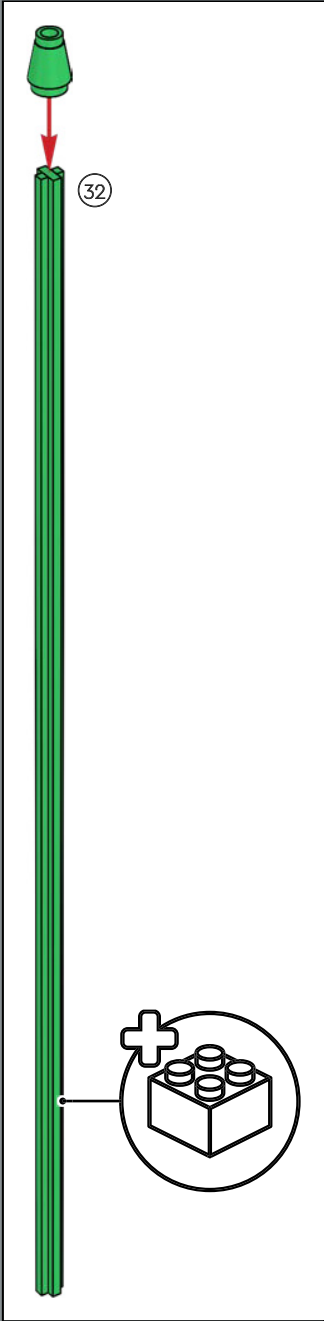

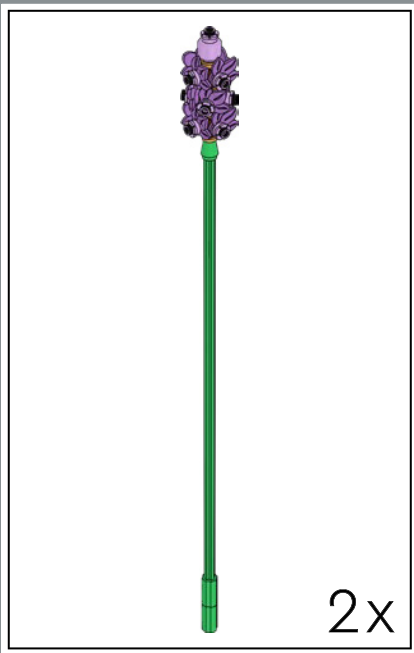

1



2



3

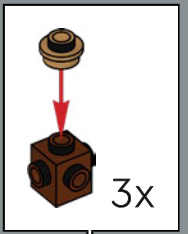

4

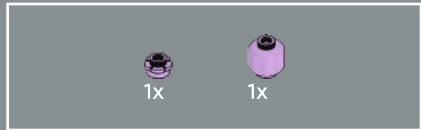
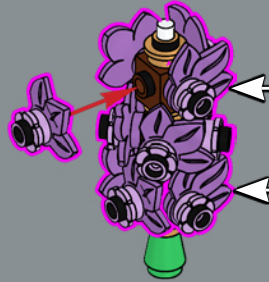
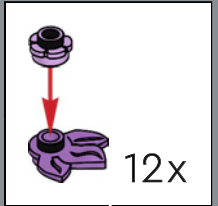

5





6

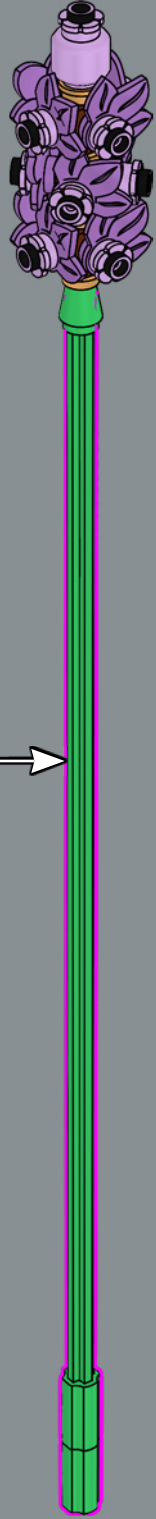
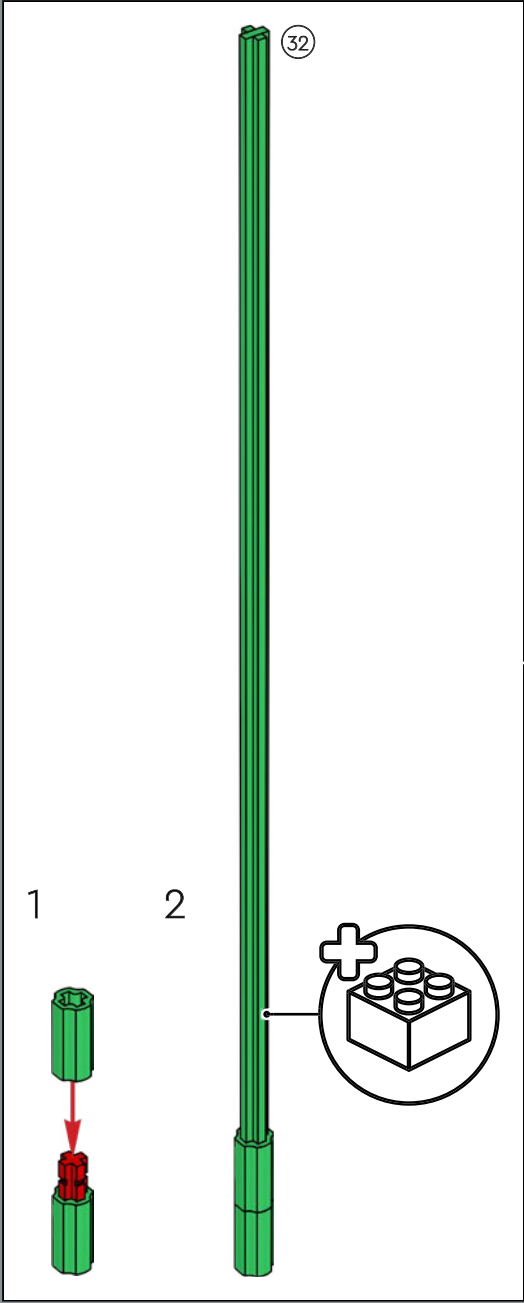

2x



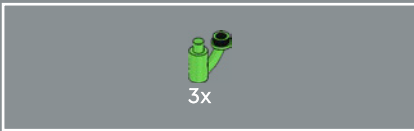
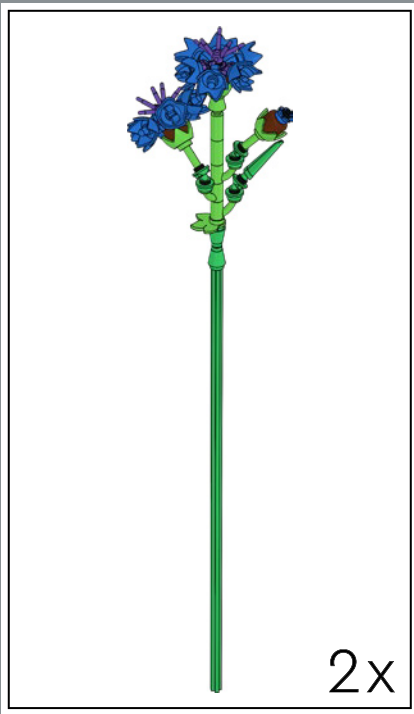

1

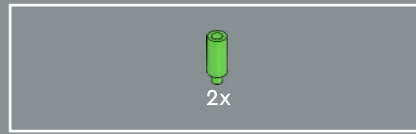

2

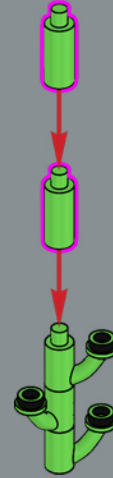

3

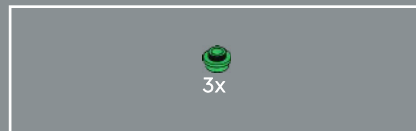
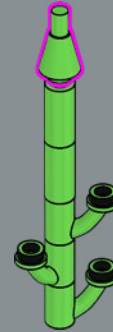

4

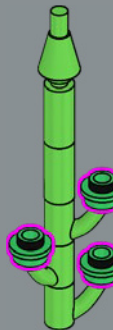

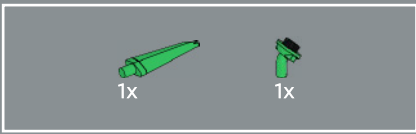

5

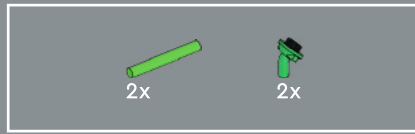
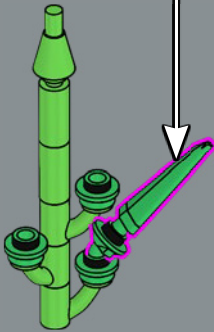
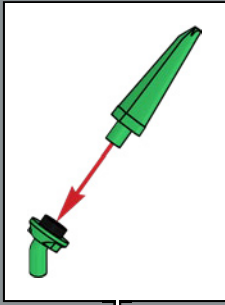

6

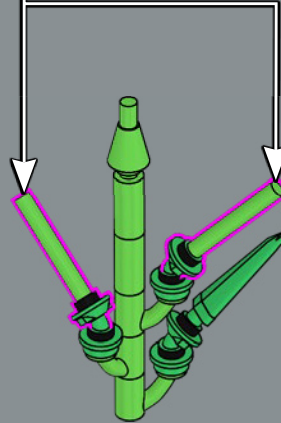
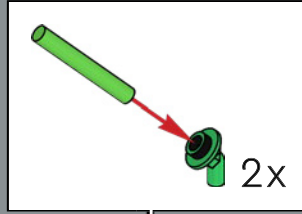

7

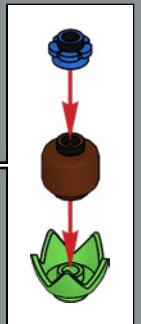
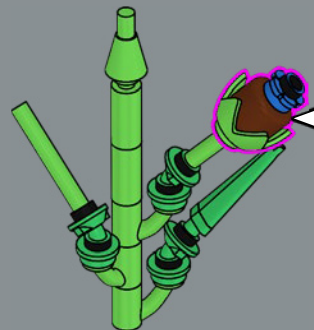

Il LEGO Group sta lavorando per costruire un futuro più sostenibile per i bambini. Attualmente, oltre 80 elementi LEGO®, incluso alberi, foglie e cespugli, sono realizzati con plastica a base vegetale, prodotta da canna da zucchero coltivata in modo sostenibile... Piante dalle Piante! Questi elementi rappresentano i primi passi di una missione più ad ampio respiro per realizzare mattoncini LEGO da fonti sostenibili entro il 2030.



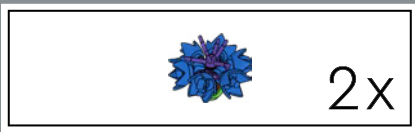

8



9

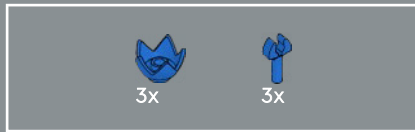

10

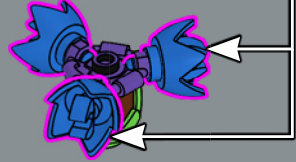
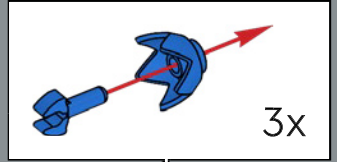

11

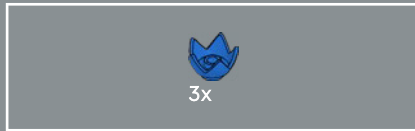
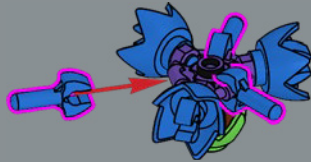

12

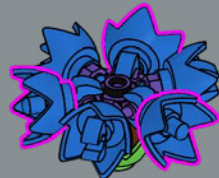



13

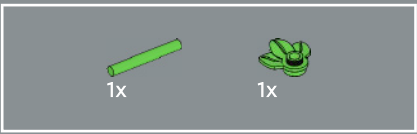
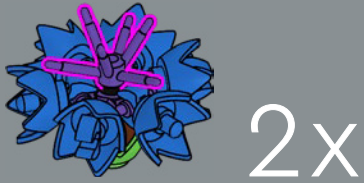

15

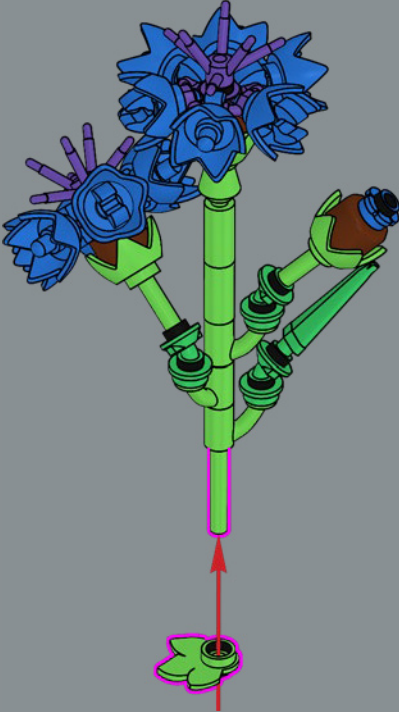

14

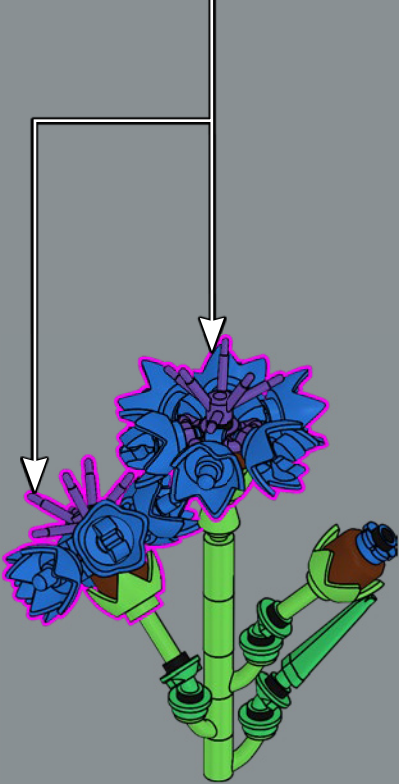

16

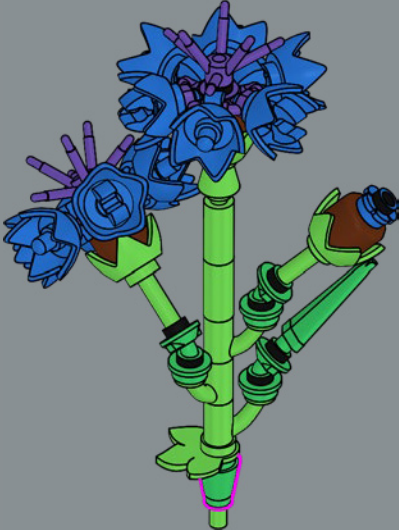



17

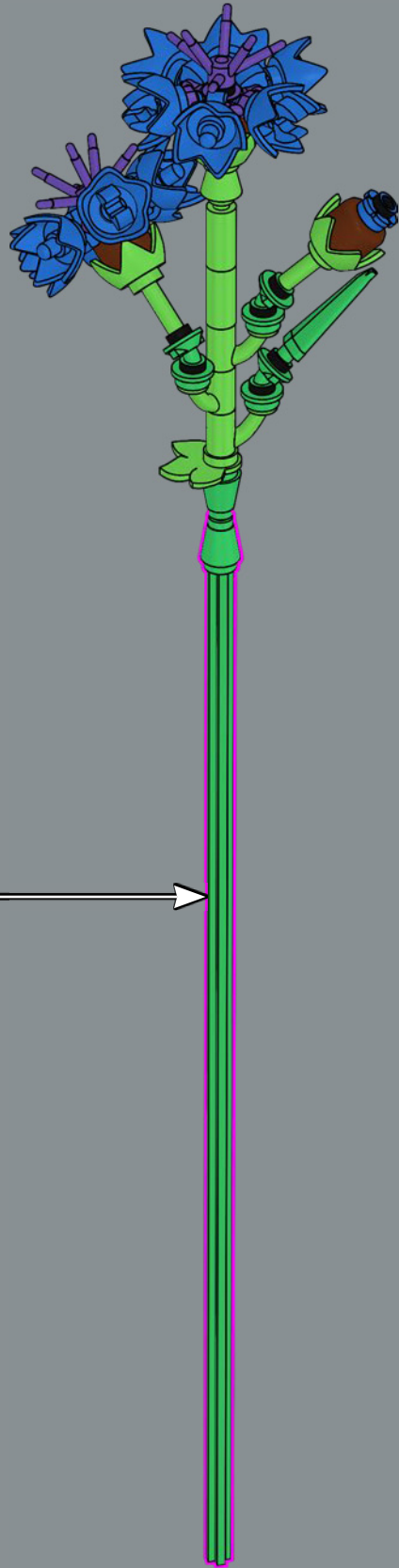
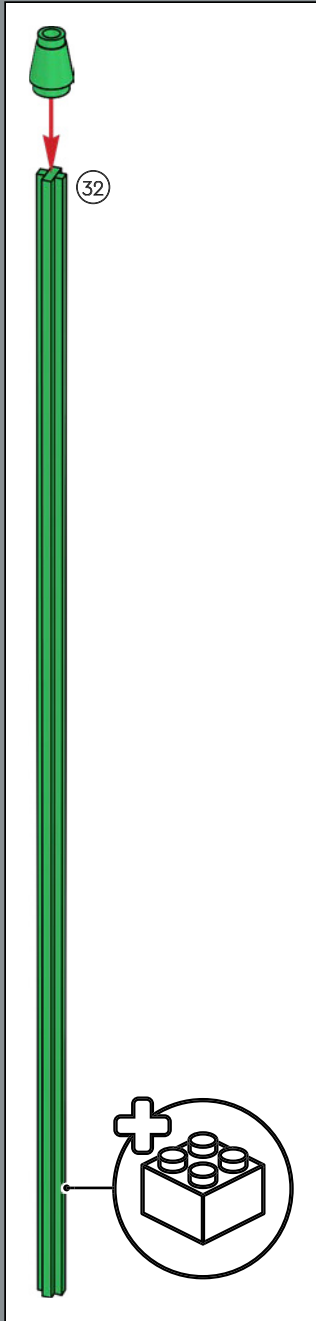

2x



LUPINO

(Lupinus)

🌸 Originario del Nord America, il lupino cresce anche in natura nel Mediterraneo e in Europa. Di tanti colori diversi, le loro "spighe" ombre spiccano nei campi per attirare l'attenzione degli impollinatori - e la nostra - nelle praterie del Nord America, lungo le strade e nei giardini di tutto il mondo.

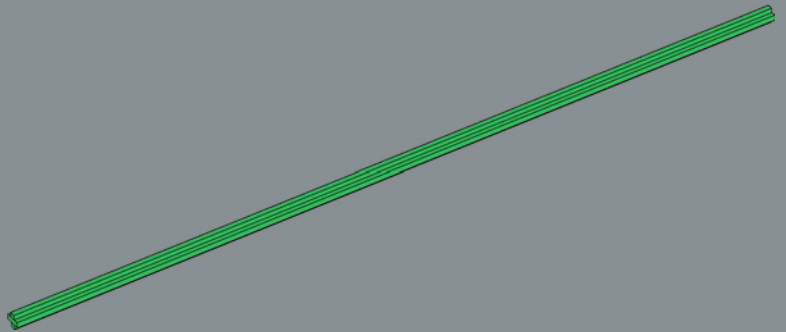
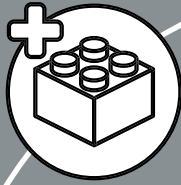

2x



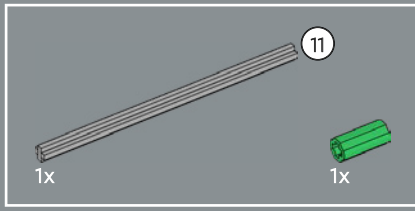
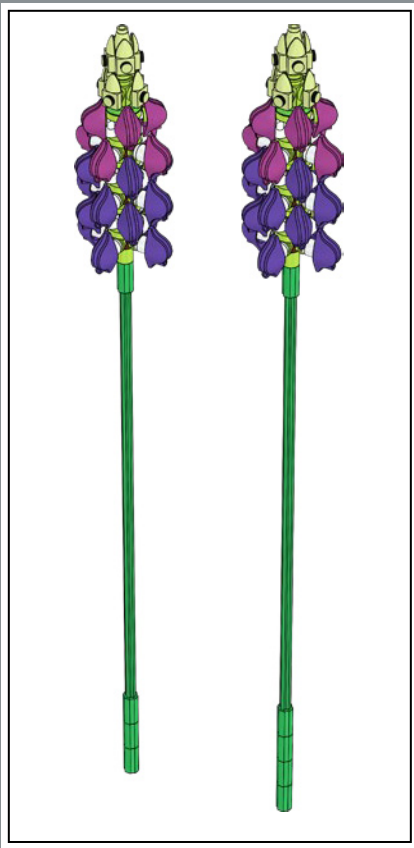

1

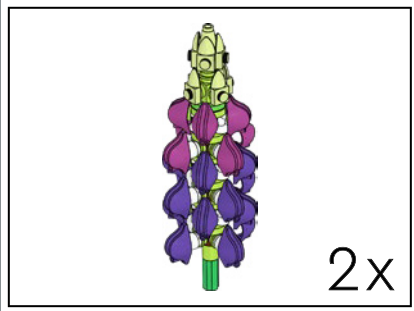
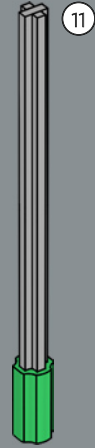

2x



2

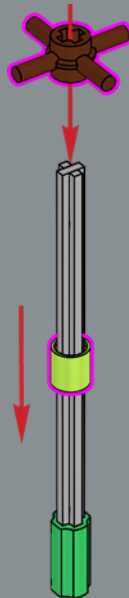



3

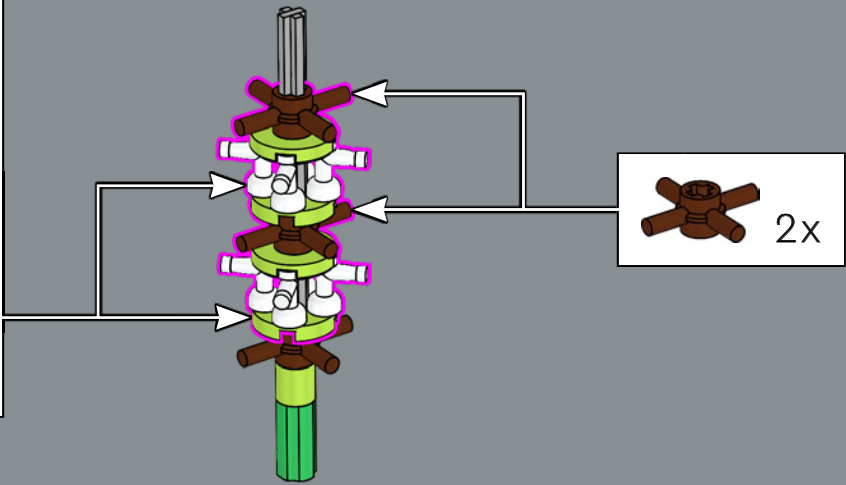
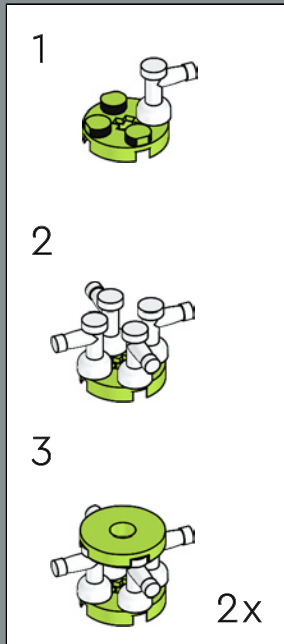

4

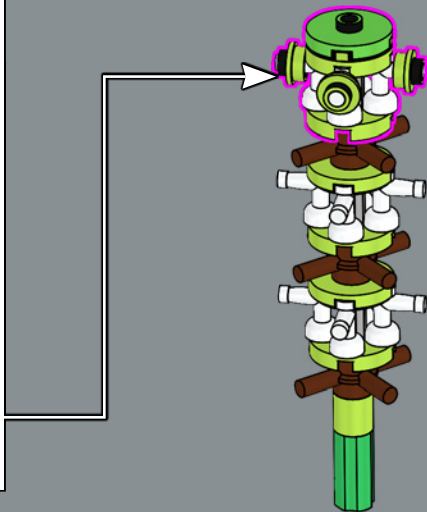
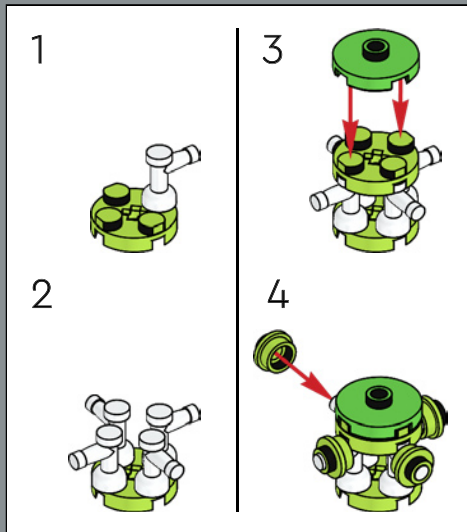

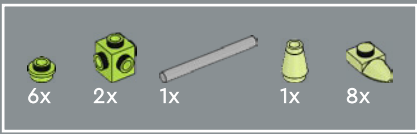

5

1



2

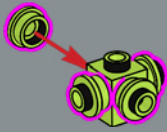

3



4

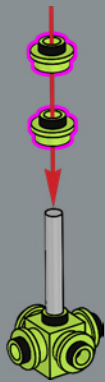

5



6



7

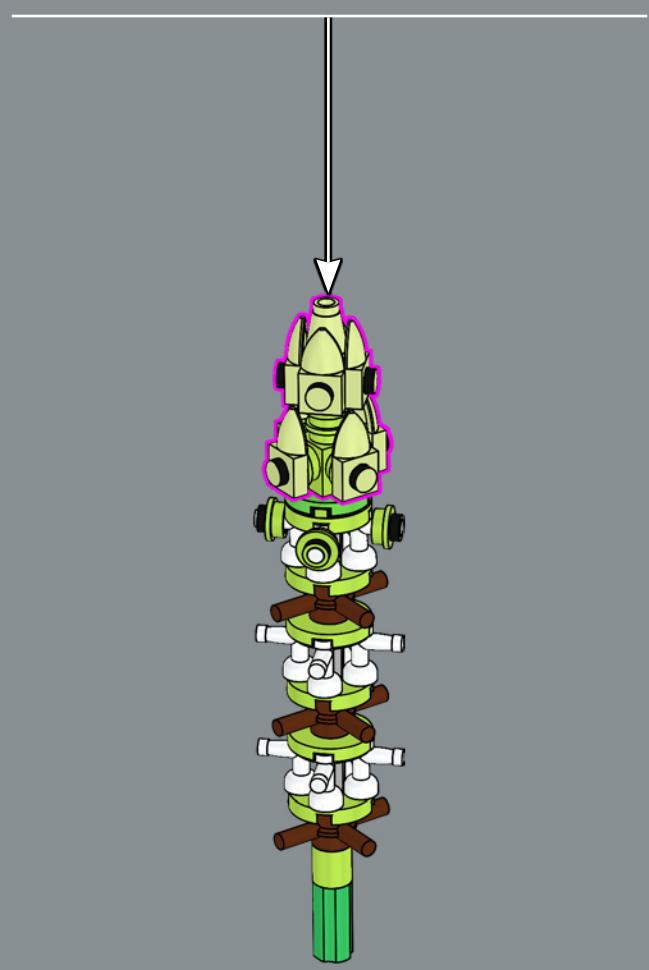
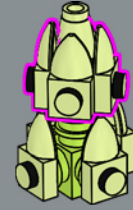



6

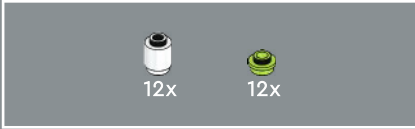
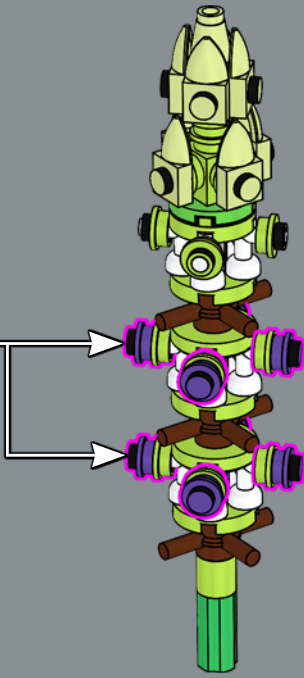
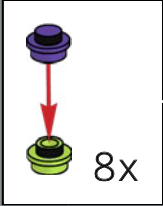

7

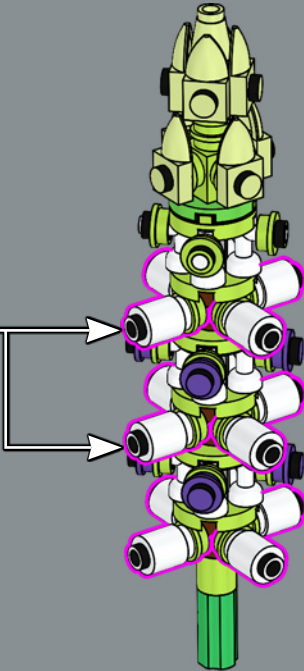
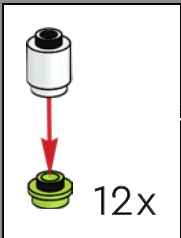

8

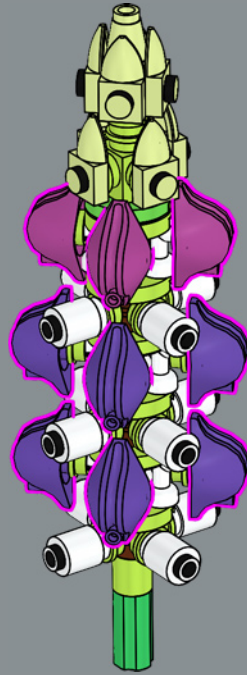

9

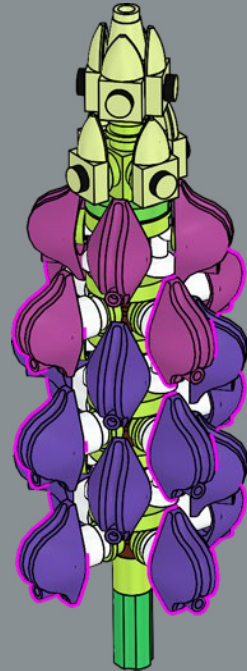

2x

10



Le minifigure che indossavano questi cappelli da pirata nel 1989 non avrebbero mai immaginato che i loro fantasiosi copricapi sarebbero stati utilizzati un giorno come petali di Lupino!

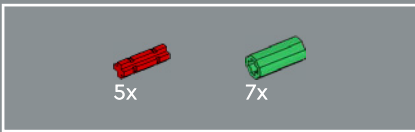

11

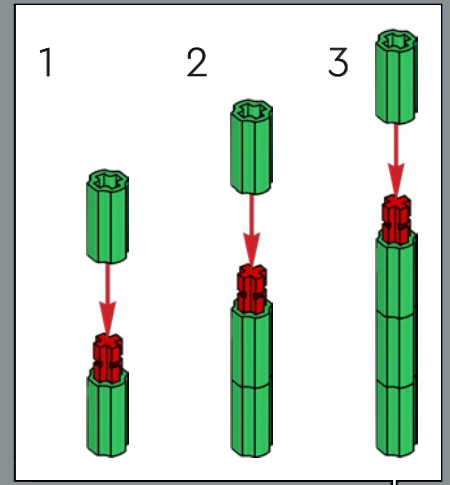
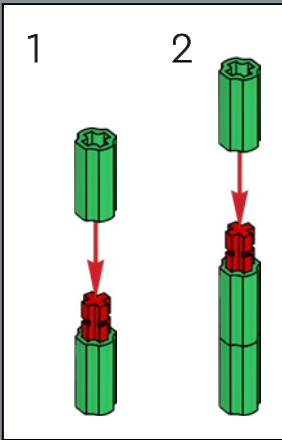
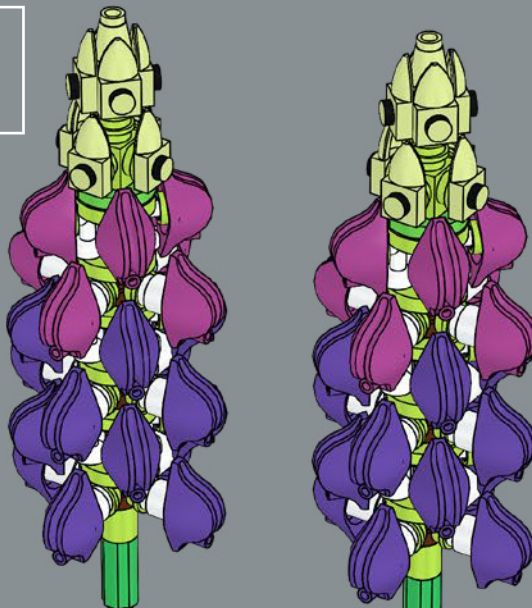

A LEGO Technic model of a plant. The main stem is green and has several blue flowers at different heights. Some are buds, some are partially open, and some are fully open. Below the main stem, there are two daisy-like flowers. One is yellow with a brown center, and the other is pink with a brown center. Both daisies have green bases and stems.

SPERONELLA FIOR-CAPPUCCIO

(*Consolida ajacis*)

🌸 La Speronella ci regala un'attraente distesa di fiori selvatici blu che sbocciano nei campi e nei giardini di tutto l'emisfero settentrionale. Una specie annuale, arriva all'inizio della primavera e, insieme al suo parente stretto, il *Delphinium perenne*, aggiunge altezza e un elegante tocco di colore al tuo bouquet.

MARGHERITA DEL TRANSVAAL

(*Gerbera jamesonii*)

🌸 Cugina del girasole, la lucente Margherita del Transvaal presenta un arcobaleno di variazioni cromatiche. Originaria del Sudafrica, è nota anche come Margherita di Barberton, dal nome dell'omonima città sudafricana. Con il suo profumo soave e la maestosa corona elevata, ricca di petali vellutati, irradia luce in qualsiasi giardino, campo o bouquet.

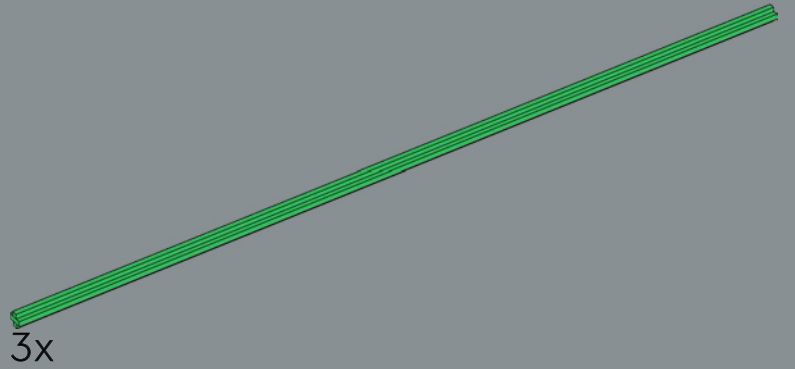
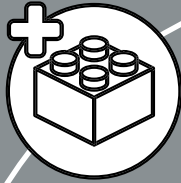

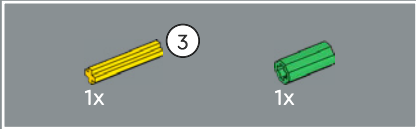
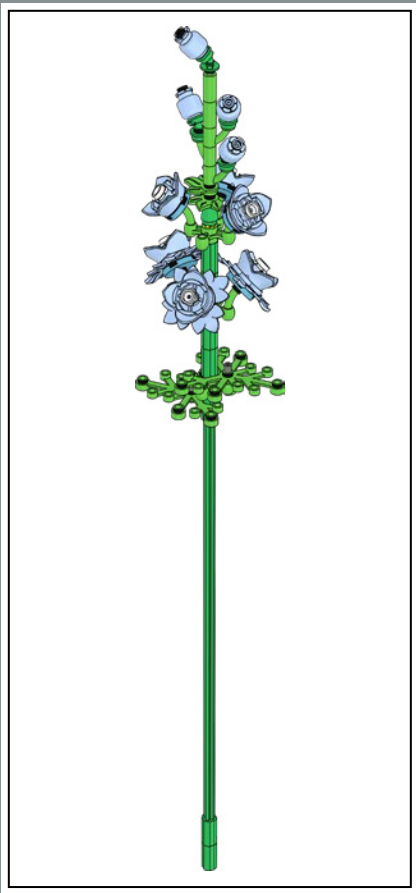

1

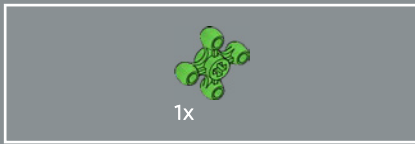
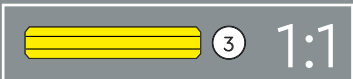
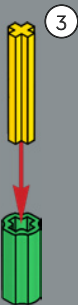

2

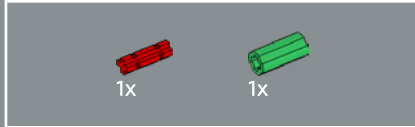
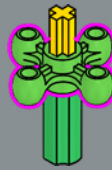

3

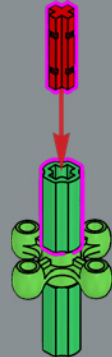

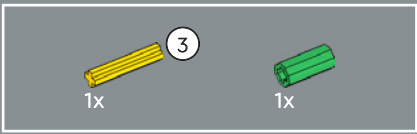

4

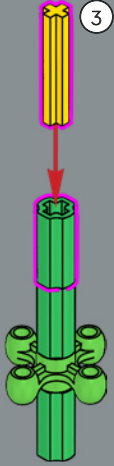

5

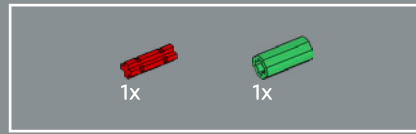
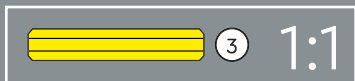
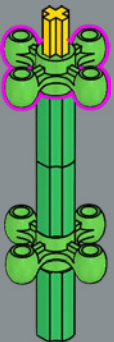

6

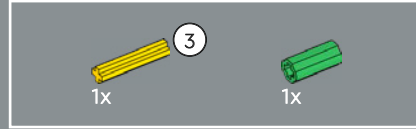
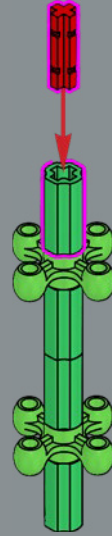

7

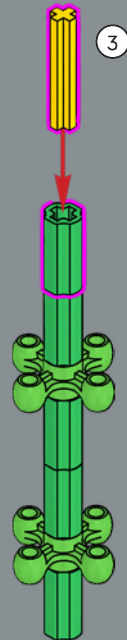

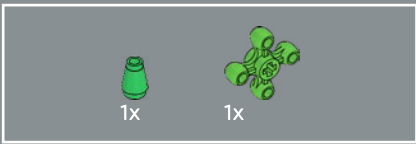

8

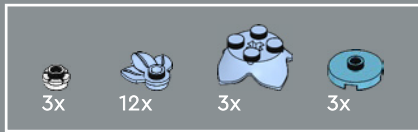
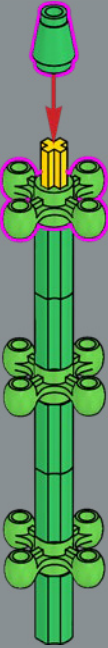

10

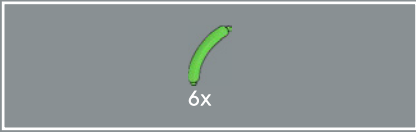
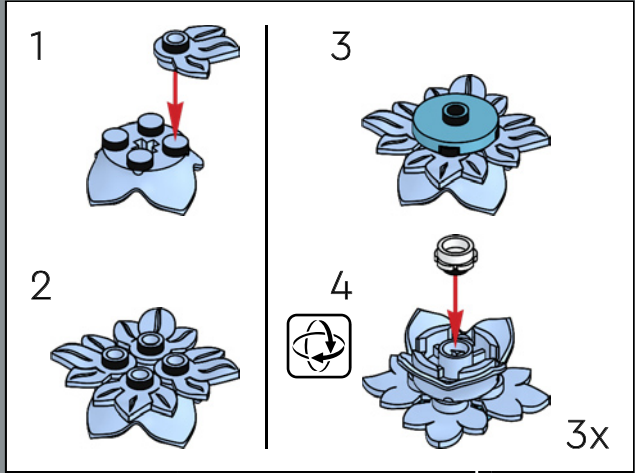

9

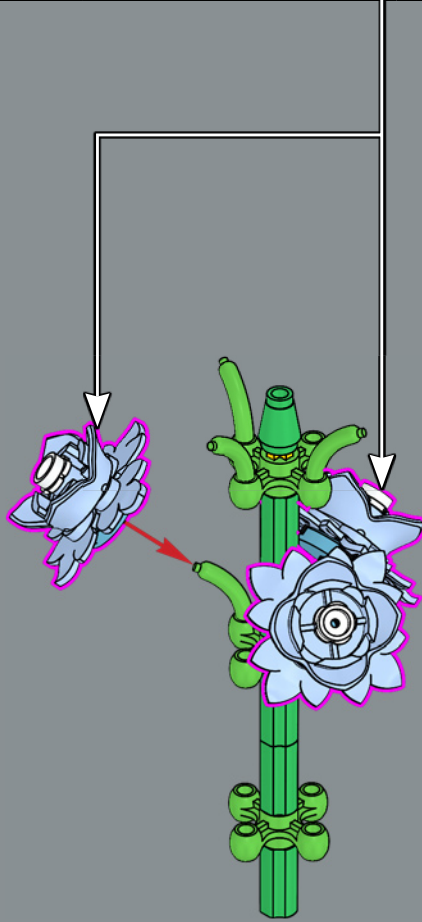
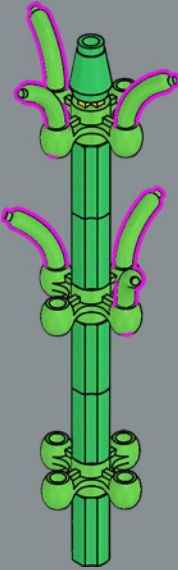



11

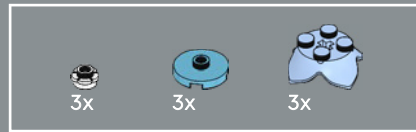
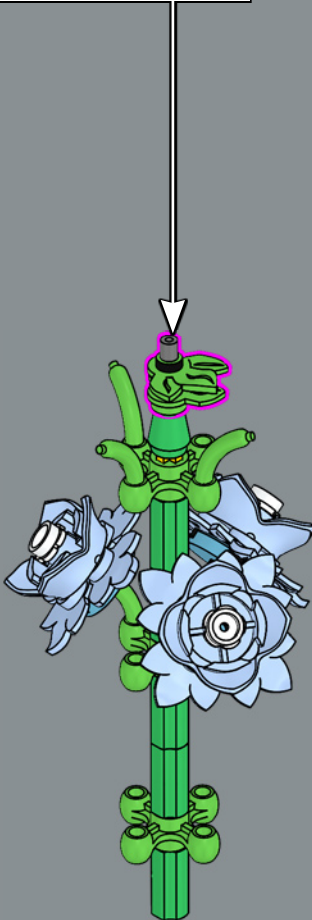
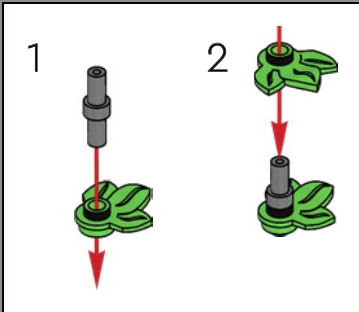

12

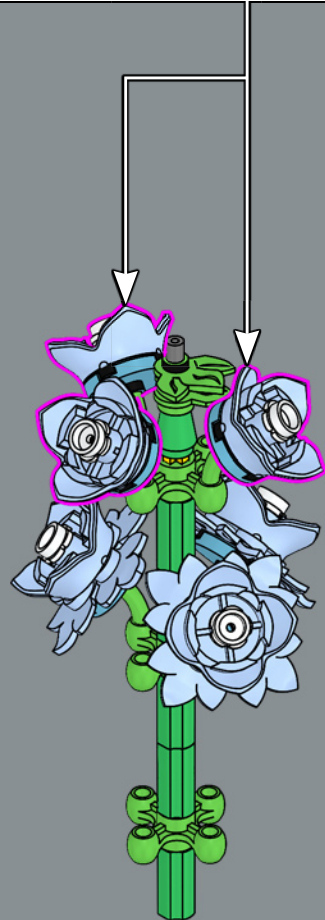
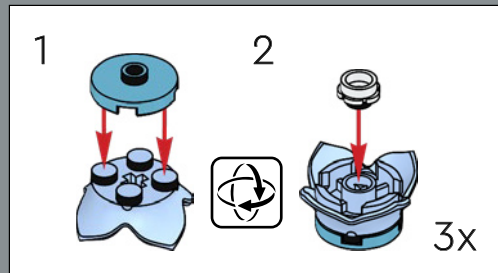

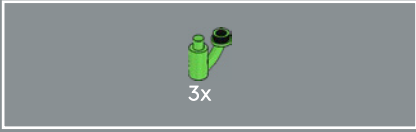
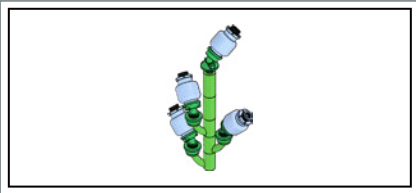

13

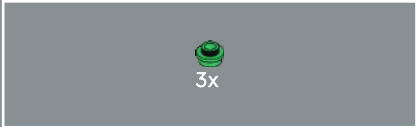

14

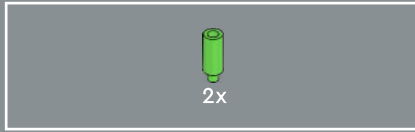
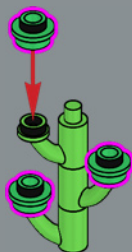

15

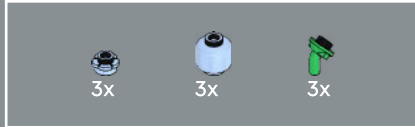
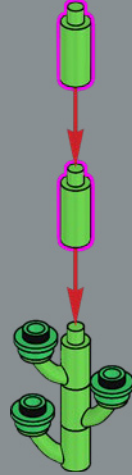

16

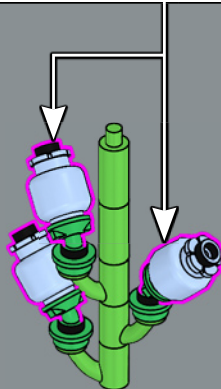
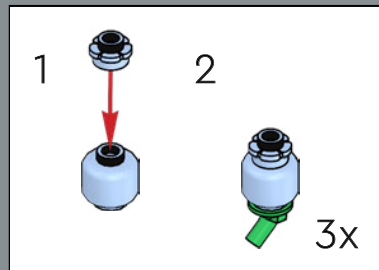



17

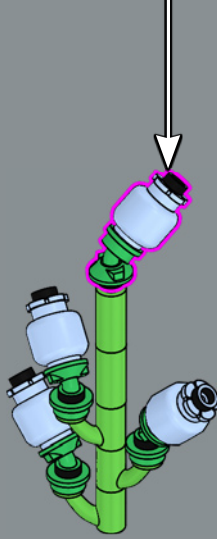
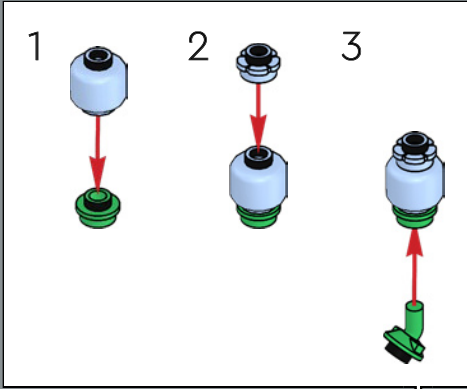

18

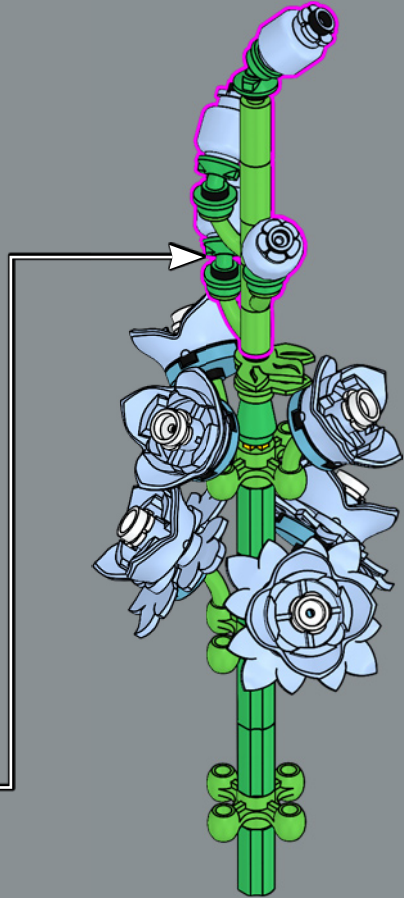

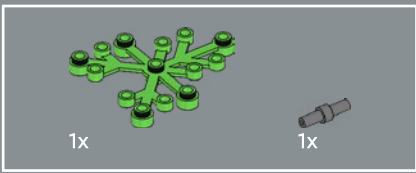

19

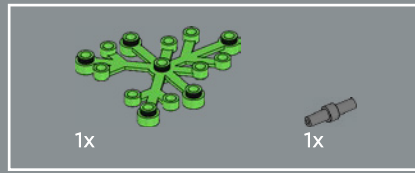
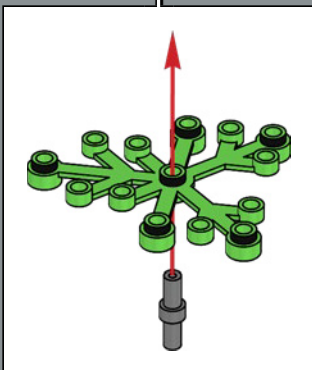
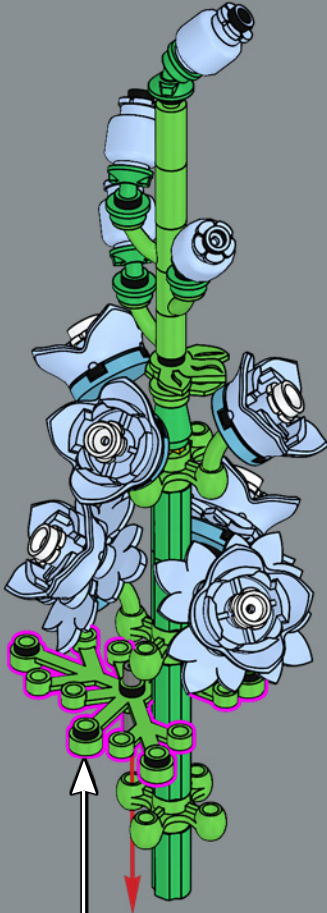

20

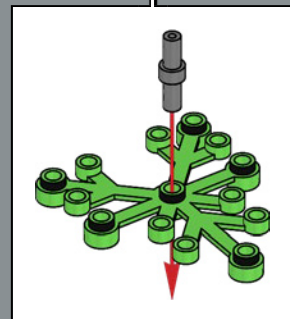
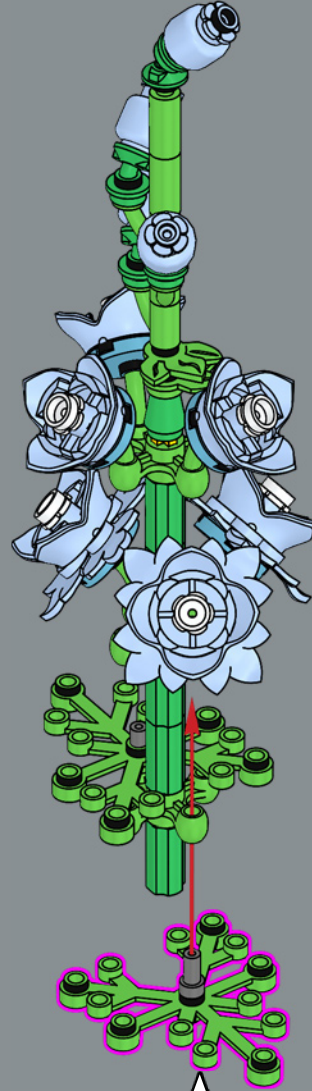

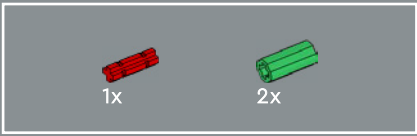

21

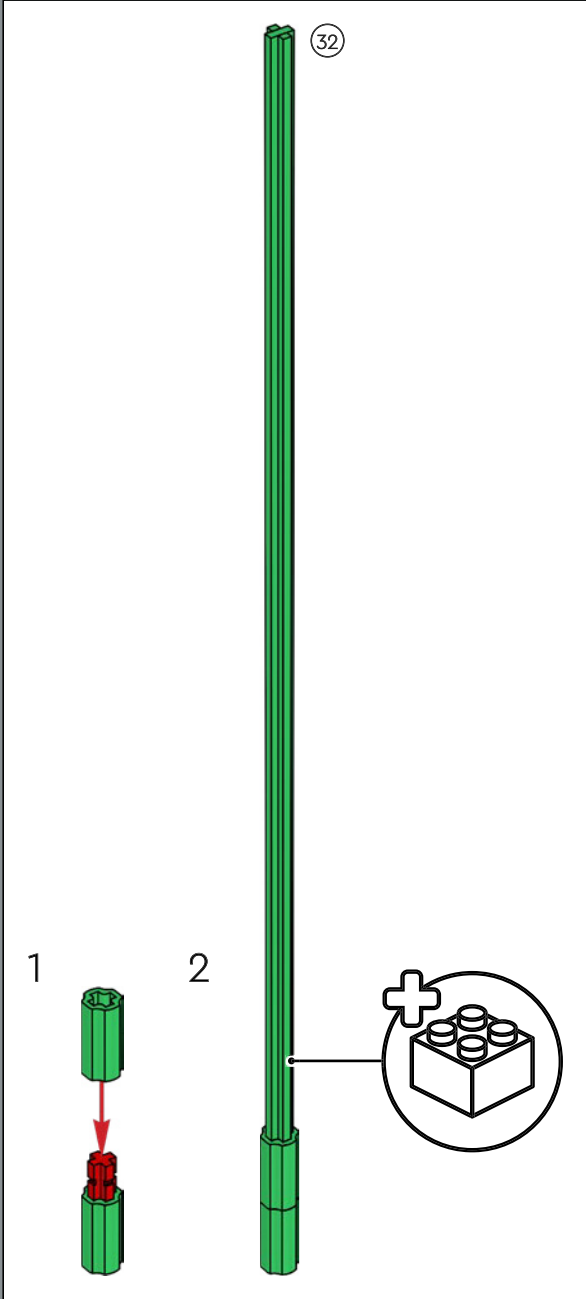
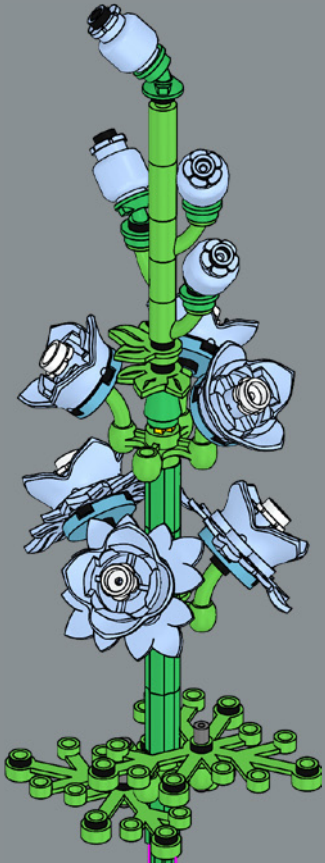

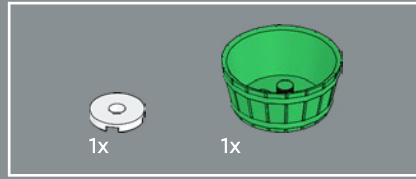
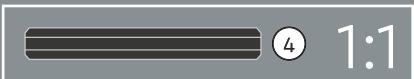
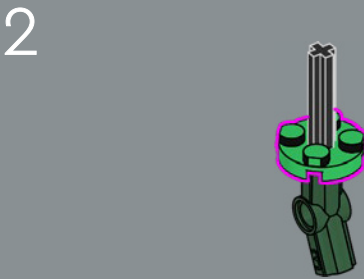
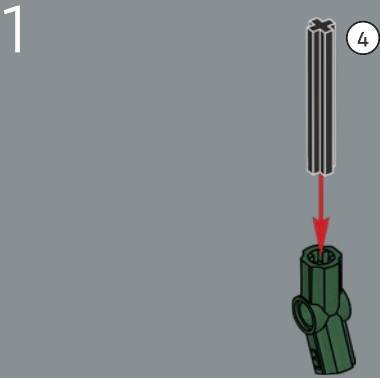
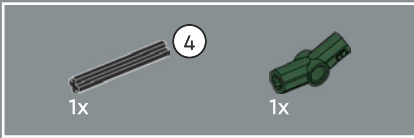

3

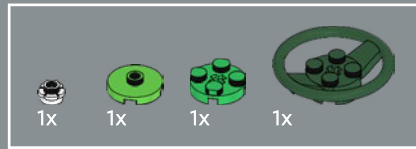
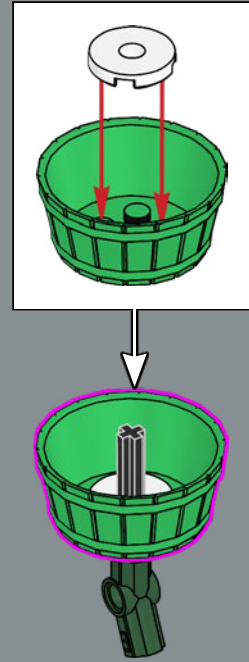

4

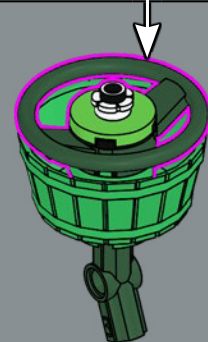
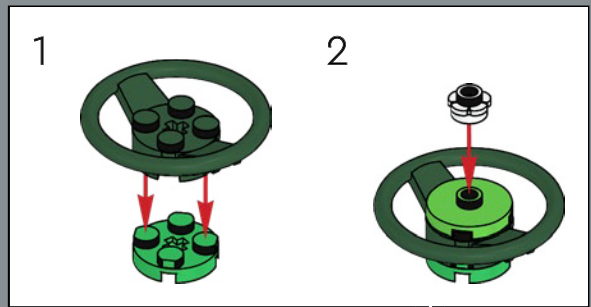



5

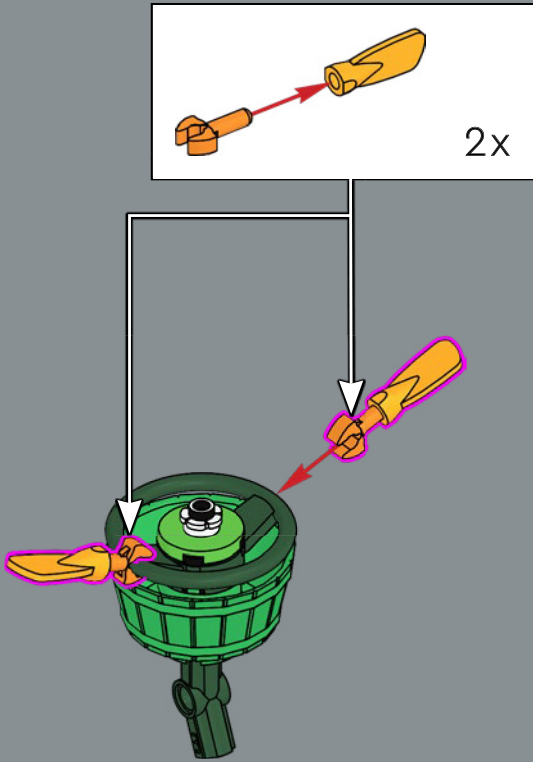

6

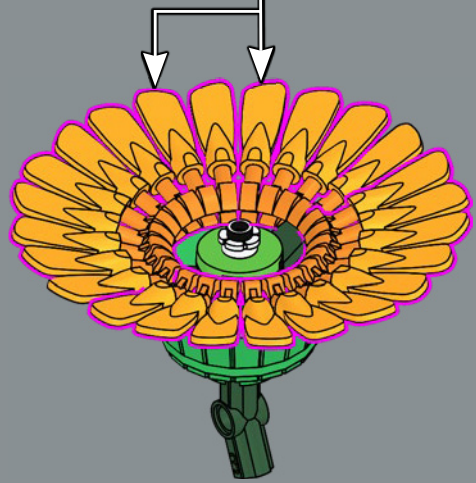
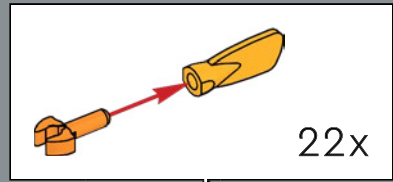

7



Questi delicati petali sono in realtà remi per le minifigure!

8





Introdotta per la prima volta nel 1983 come parte del tema LEGO® Fabuland, questo secchio è stato utilizzato per tanti elementi - dai motori a razzo ai contenitori per fiori.

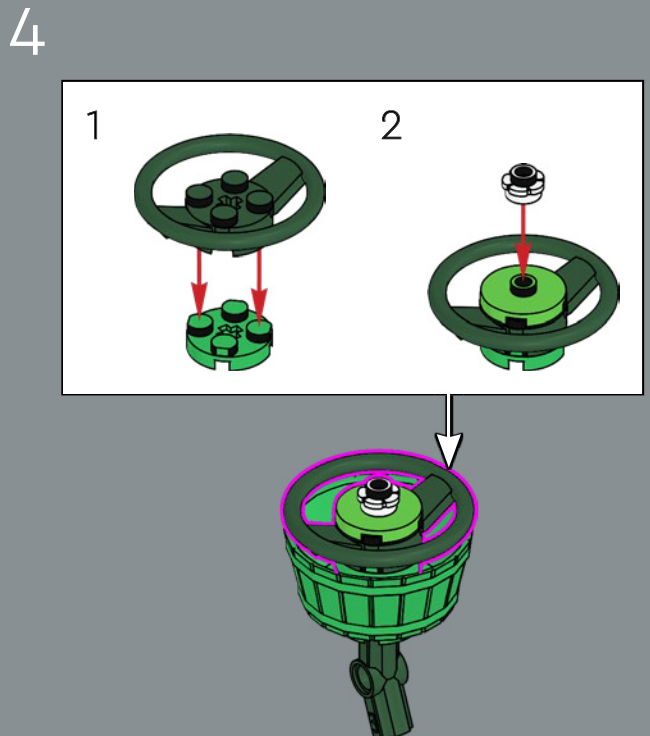
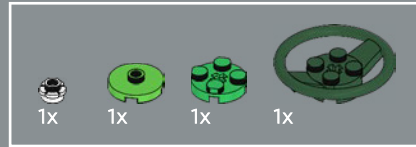
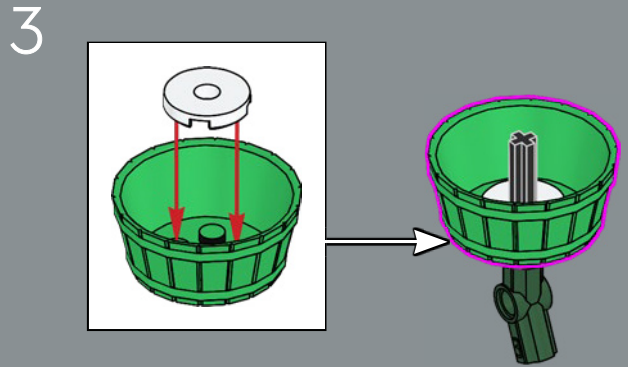
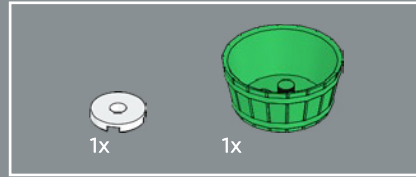
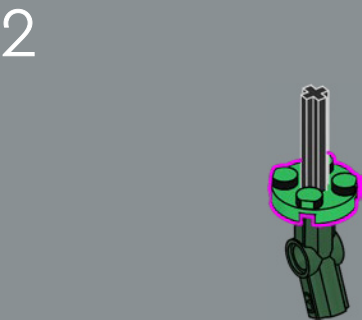
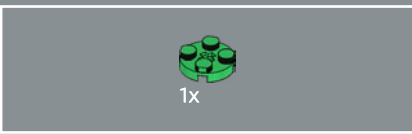
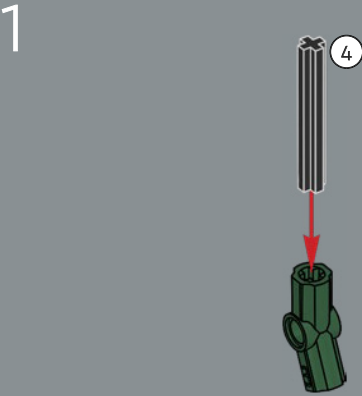
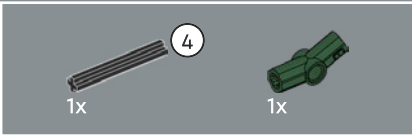



5

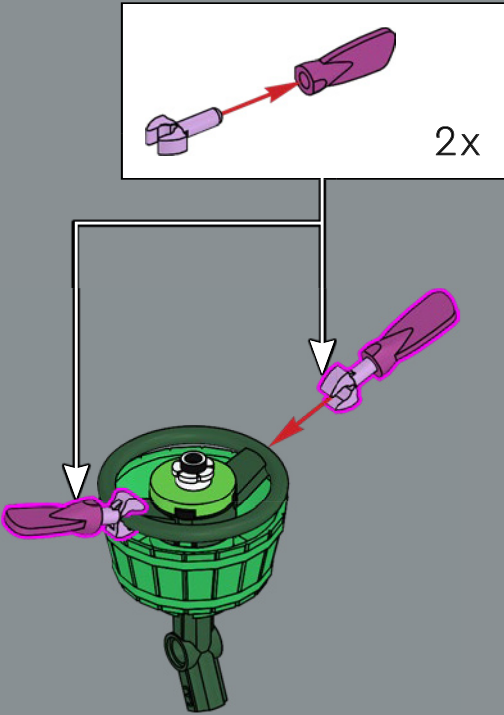

6

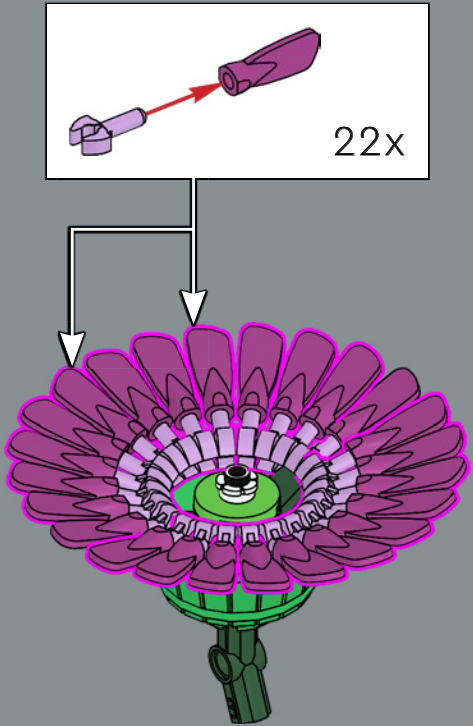

7



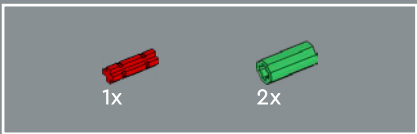

8

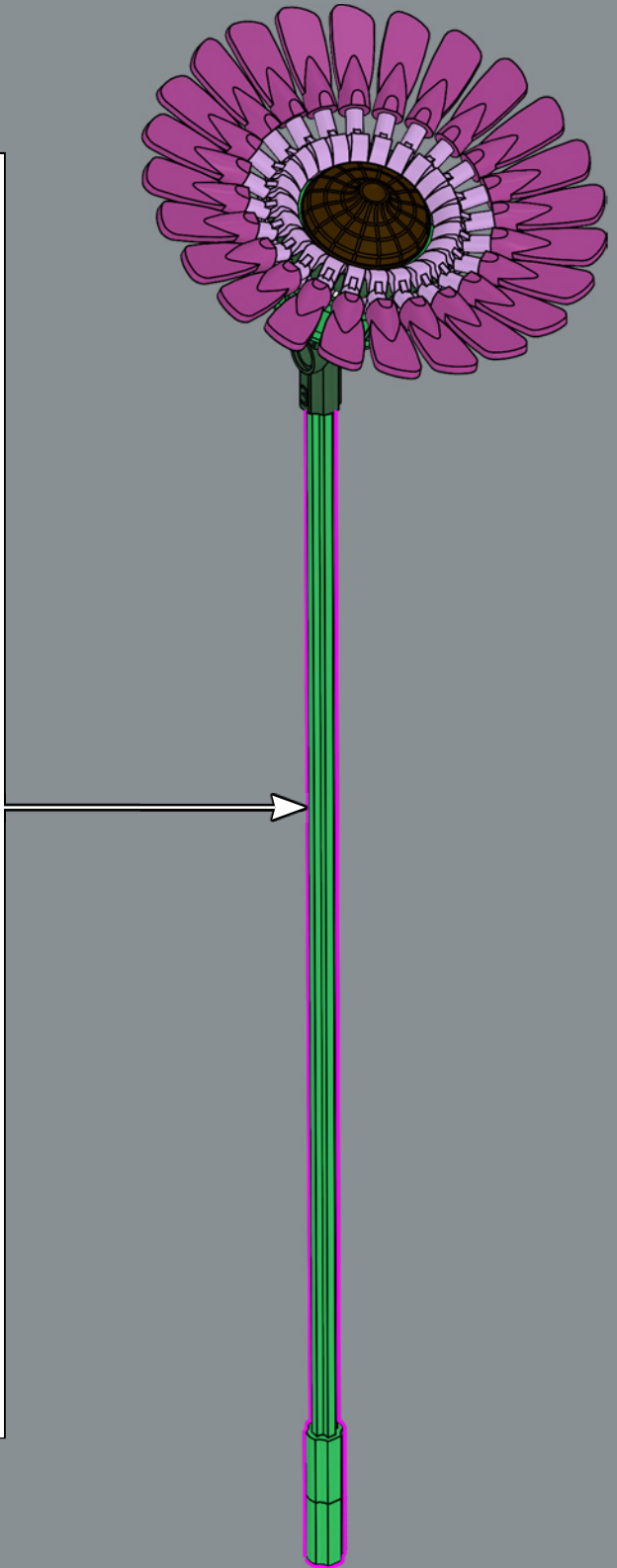
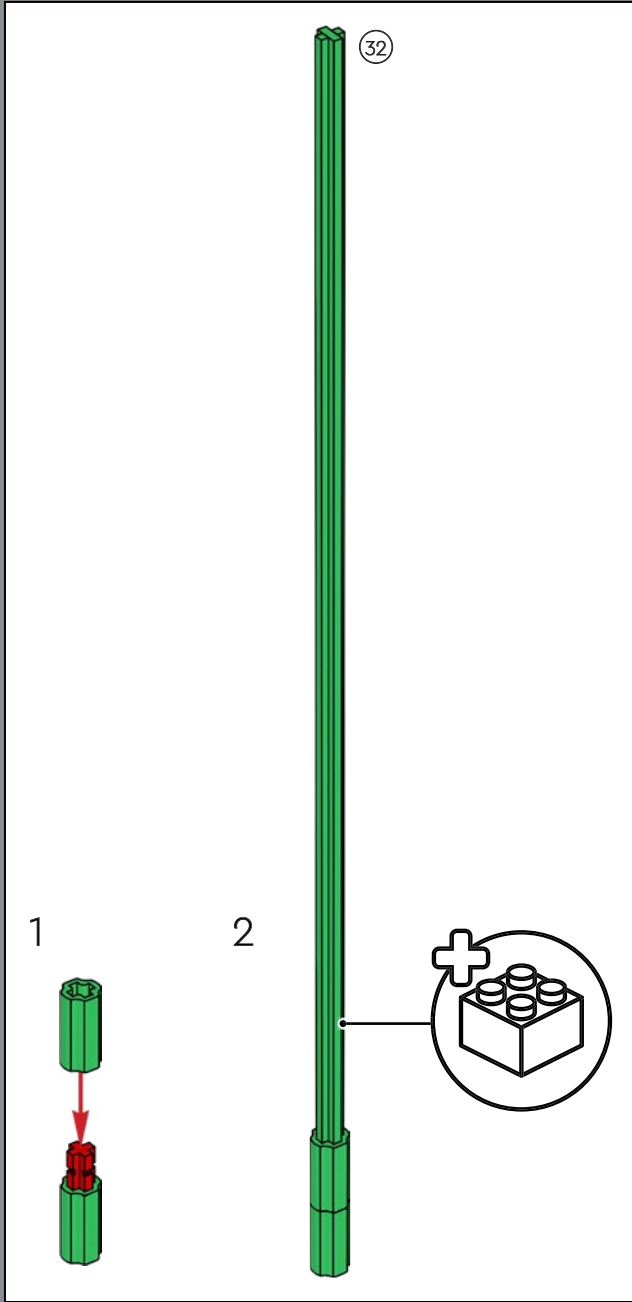

24x
306201

2x
6310185

24x
459901

68x
6206149

2x
6170419

2x
6194512

6x
6259700

6x
6339183

16x
6348056

2x
4515349

8x
6420923

13x
6130007

61x
4142865

3x
6055225

15x
6420219

2x
6329283

8x
6344177

24x
6330196

2x
6329274

24x
6424588

6x
6133765

7x
4211218

12x
6316697

2x
6382540

24x
6420229

24x
6420230

3x
6350724

2x
6116608

11

2x
6178172

4x
6209683

12x
6420914

6x
6420921

4x
6294900

2x
6420922

16x
4566522

5x
6420217

32x
6420916

5x
6420218

8x
6190252

2x
6416732

6x
6136419

24x
6210460

26x
6214235

2x
6329317

24x
6420920

4x
6420918

16x
6267420

11x
4529239

11x
6338221

8x
6210271

8x
403228

2x
6420221

2x
6266964

20x
6269971

11x
6382575

3x
6270084

50x
6374076

2x
6420635

12x
6420964

4x
6380676

10x
6388070

5x
6182261

2x
6345196

7x
6161772

7x
6328327

7x
6420228

3x
6331087

6x
6430093

3x
6420915

1x
6254100

24x
6278159

4x
6174006

2x
6302741

60x
6190251

10x
6314224

4x
6167483

16x
6420919

24x
6420220

3x
6267045

3x
6265699

2x
370526

32





COMPONI IL TUO BOUQUET CON TANTI FIORI DIVERSI

🌸 Il tuo bouquet di fiori selvatici può essere realizzato con tanti fiori diversi. Trova l'ispirazione per realizzare combinazioni creative con il set 10280 Bouquet di fiori.

