

Book 2

Livre 2

Libro 2

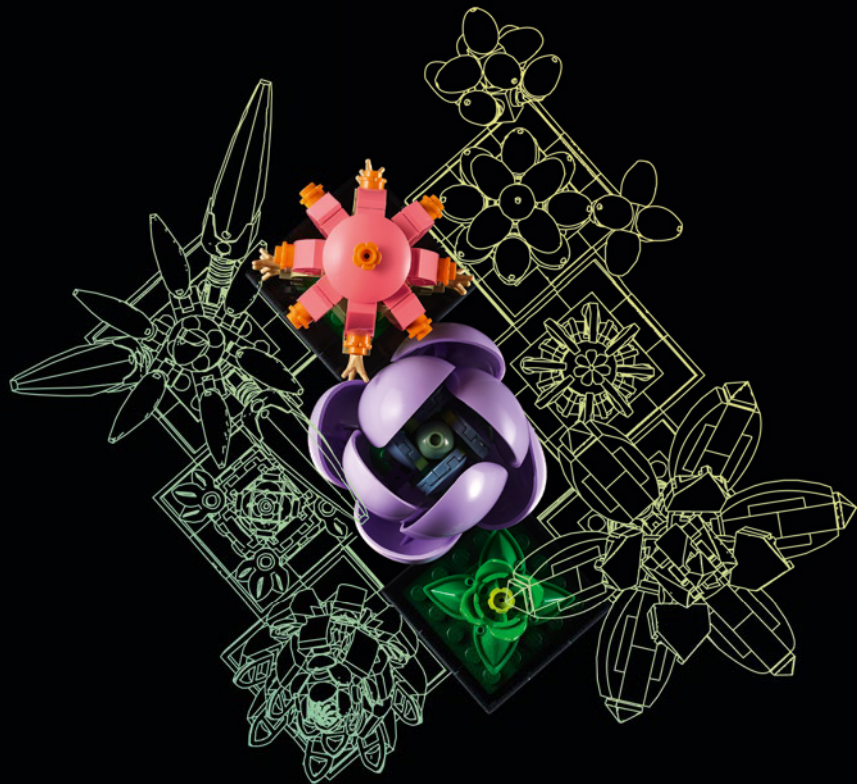

Booklet available in English on  
Livret disponible en français sur  
Folleto disponible en español en





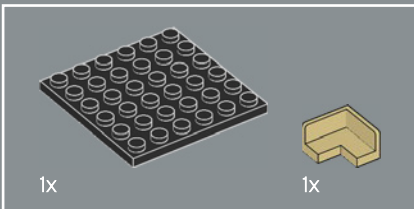

1x

1x

1

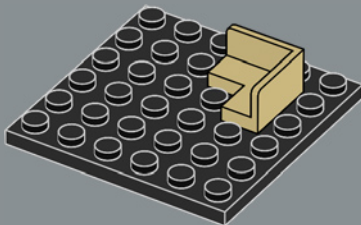

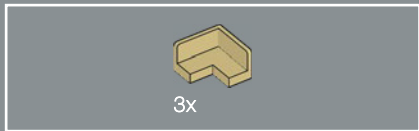

2

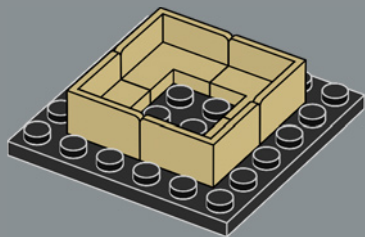

4

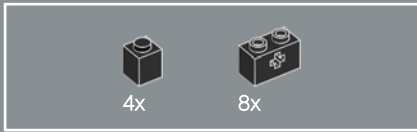

3

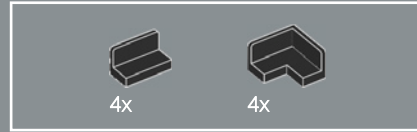
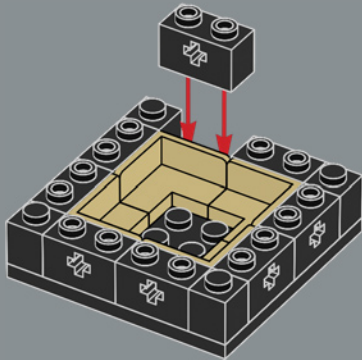

4

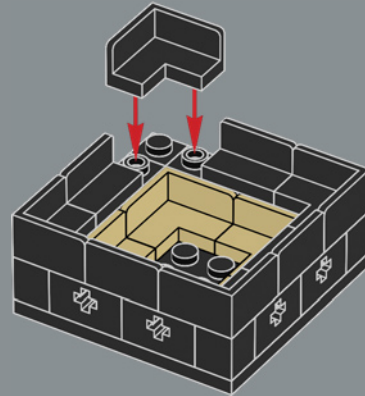

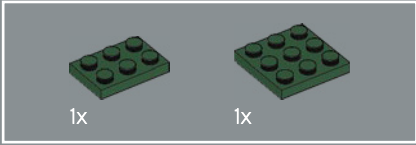

5

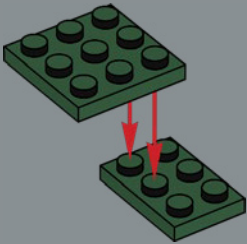

6

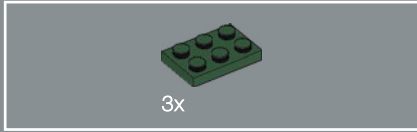

6

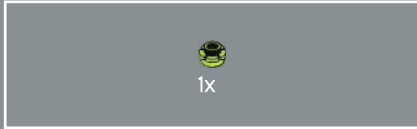
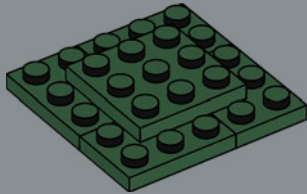

7

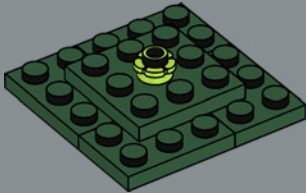

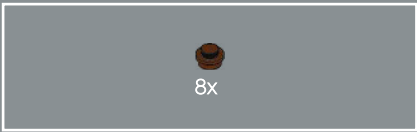

8

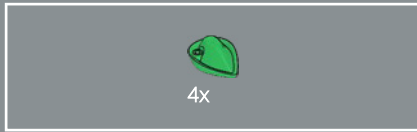
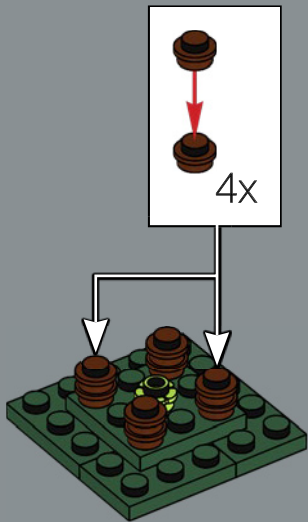

9

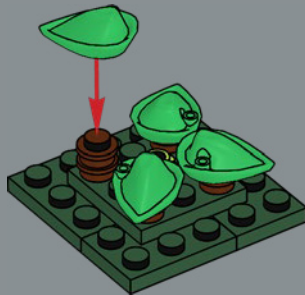



10

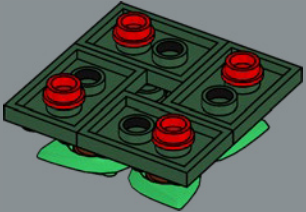

11

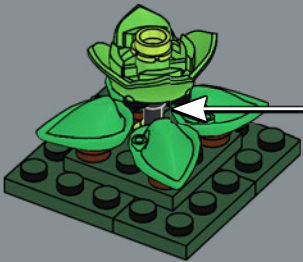
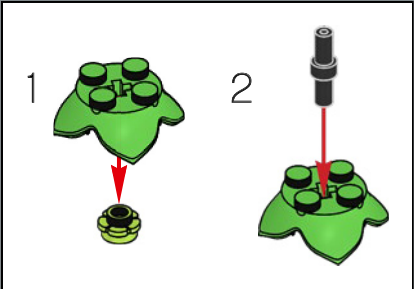



# 12

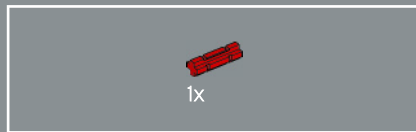
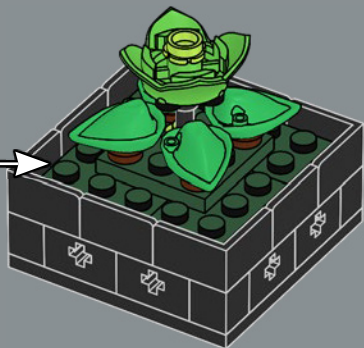

# 13

There are approximately 10,000 types of succulents that you can grow. The fun LEGO® Succulents are a great way to start your collection.

Il existe environ 10 000 types de plantes succulentes qui peuvent être cultivées. Les succulentes LEGO® sont un excellent moyen de commencer votre collection.

Existen cerca de 10.000 tipos de suculentas que puedes cultivar. Las divertidas Suculentas LEGO® son una excelente forma de empezar tu colección.

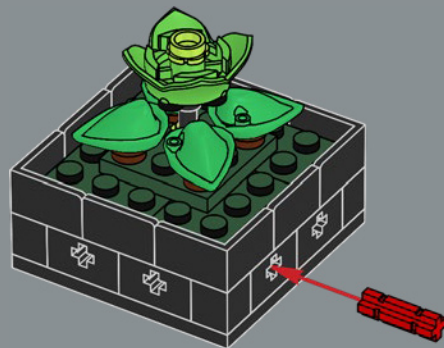

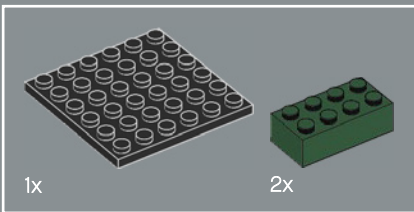
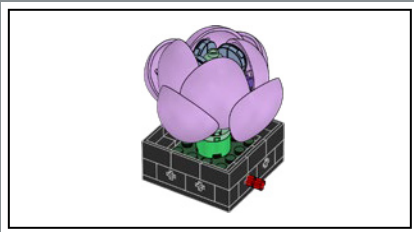

1

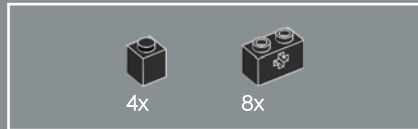
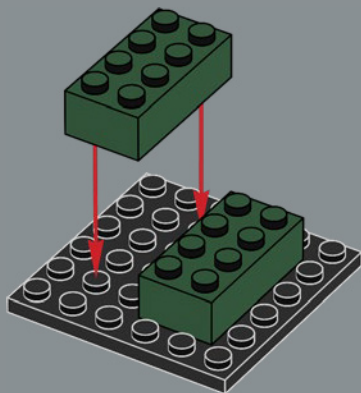

2

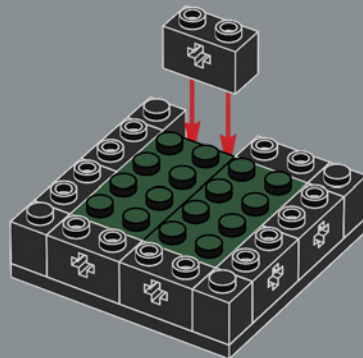

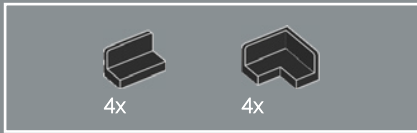

3

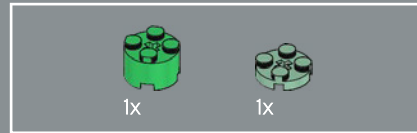
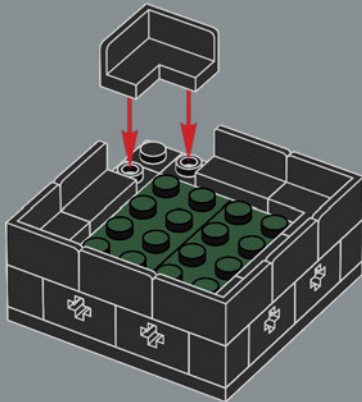

4

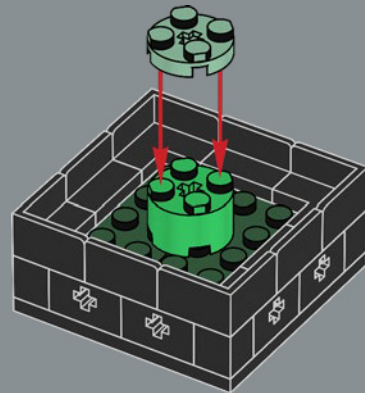

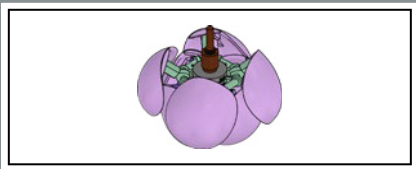

5

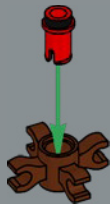

12

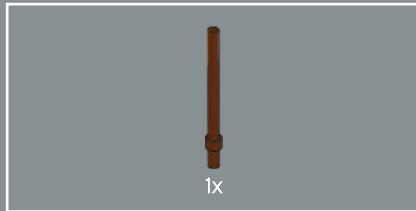

6

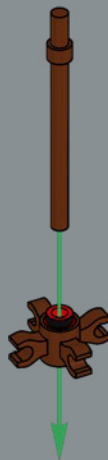

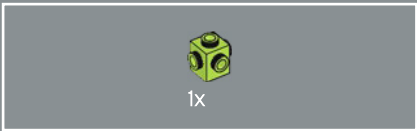

7

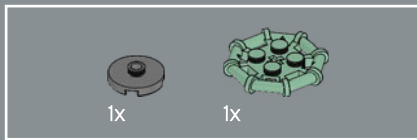

8

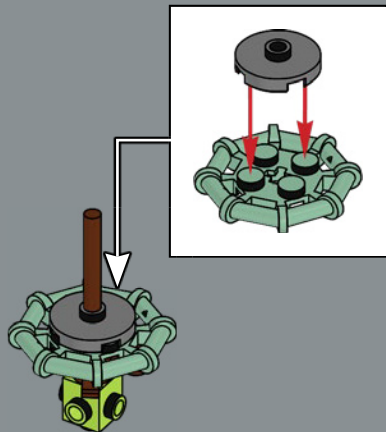



9

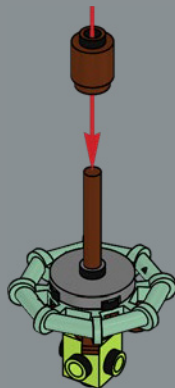

14



10

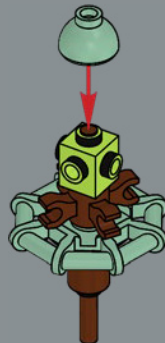



11

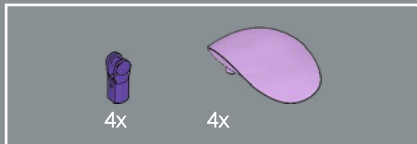
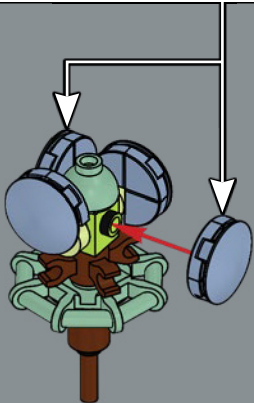
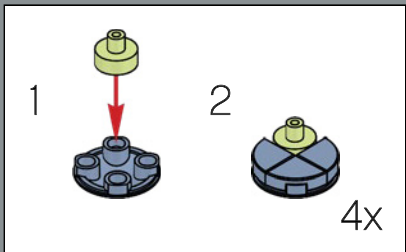

12

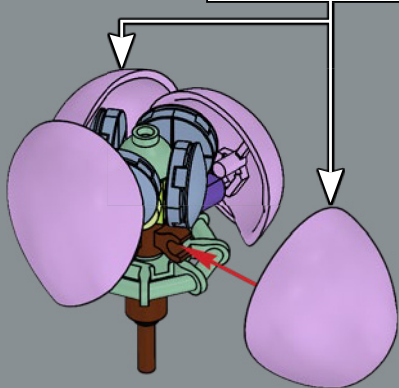
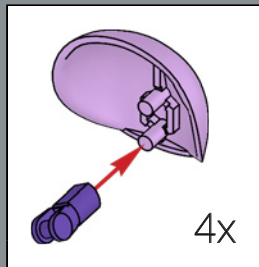

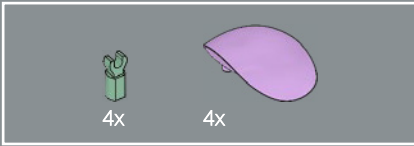

13

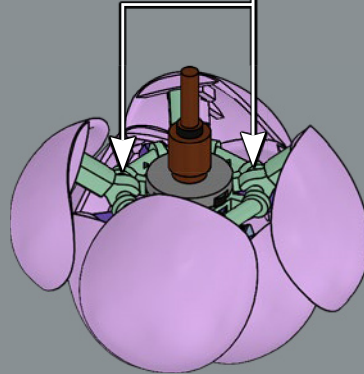
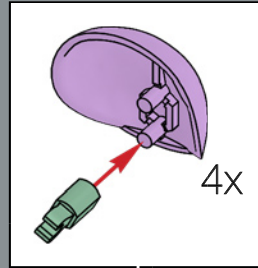

Lavender Echeveria

The lavender varieties of Echeveria have some fun names like 'Afterglow' and 'Cubic Frost.' What would you name yours?

L'echeveria lavande

Les variétés d'echeveria de couleur lavande portent des noms amusants comme « Afterglow » et « Cubic Frost ». Comment nommeriez-vous la vôtre ?

Echeveria lavanda

Las variedades lavanda de echeveria tienen nombres chistosos, como *resplandor crepuscular* y *escarcha púrpura*. ¿Cómo llamarías a la tuya?



14

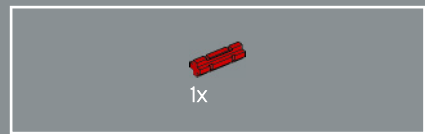
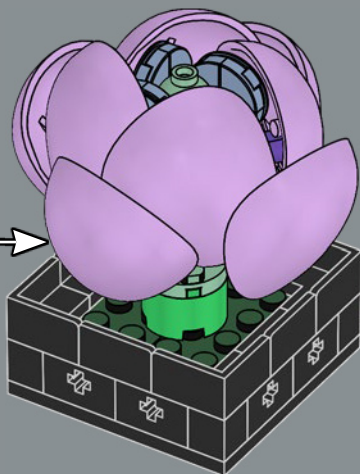

15

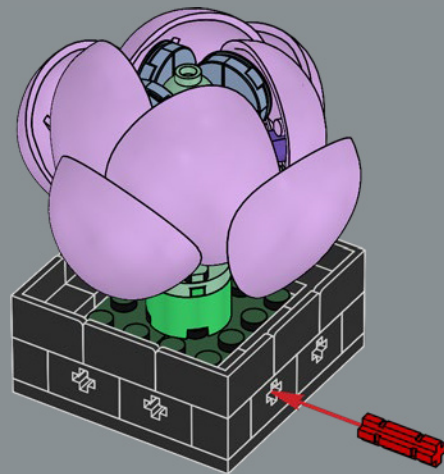

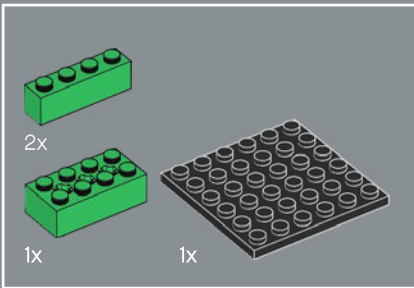
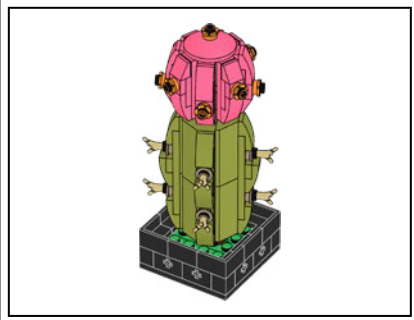

1

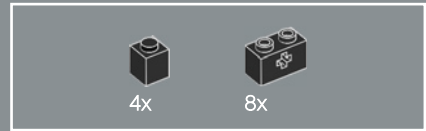
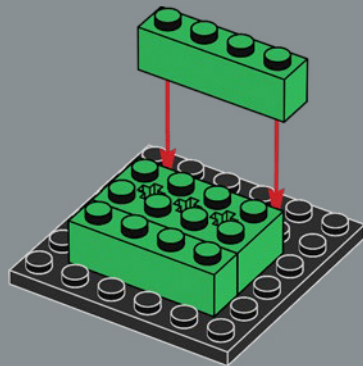

2

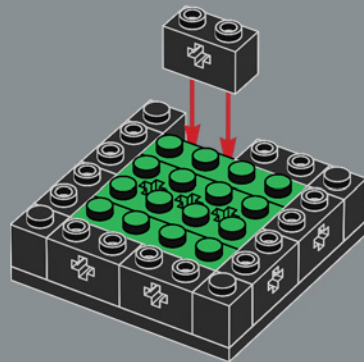

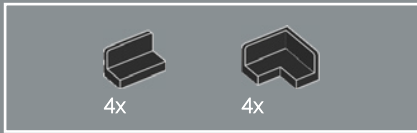

3

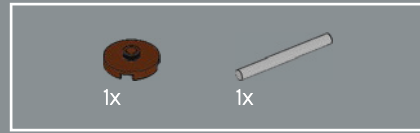
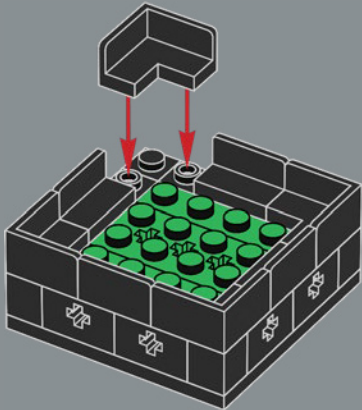

4

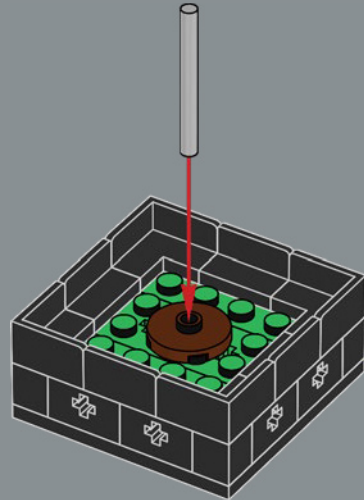

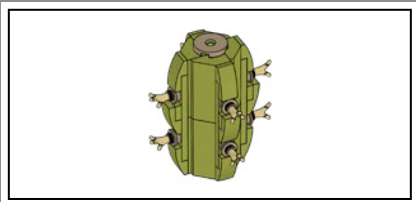

1x

1x

5

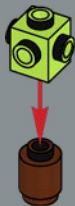

2x

6





7



8



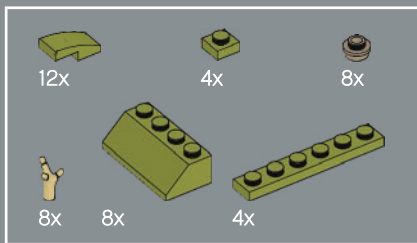
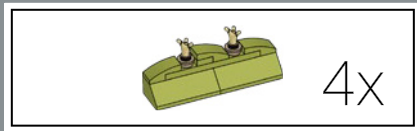

9

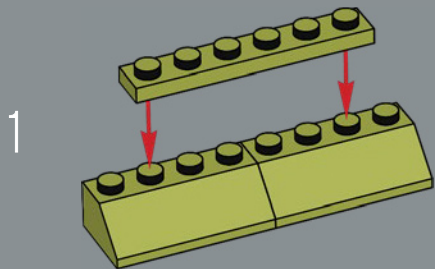

22

2

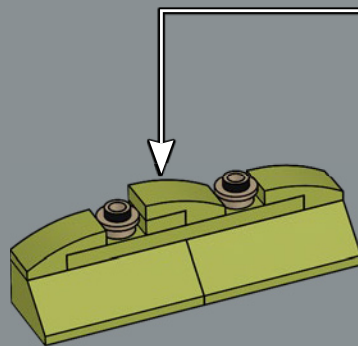

3

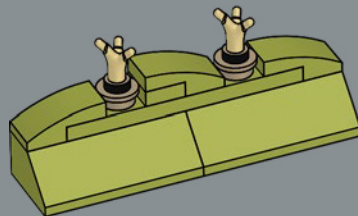

4x

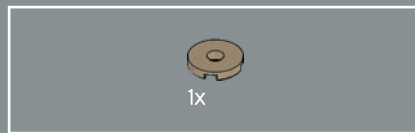
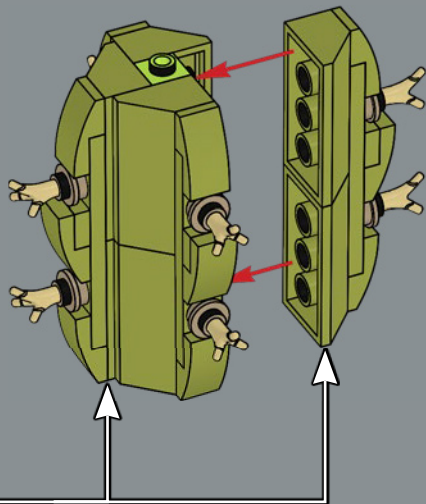

10

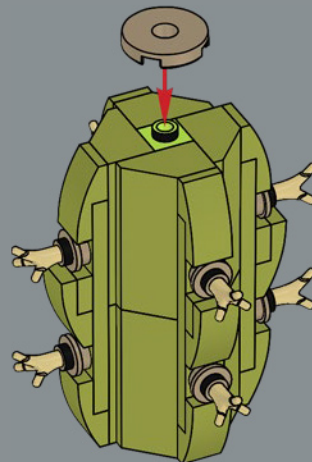

11

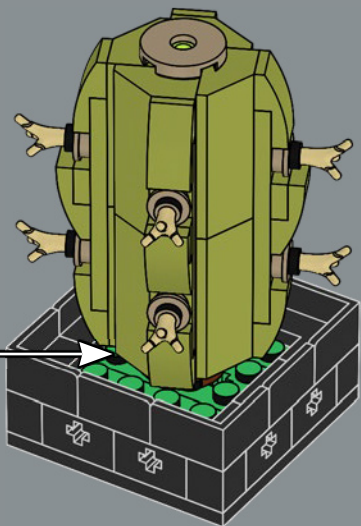

24

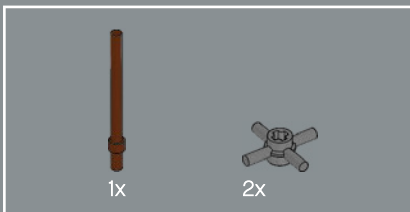
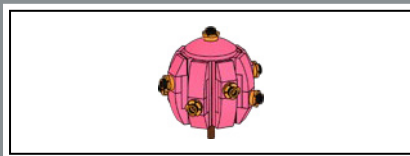

12

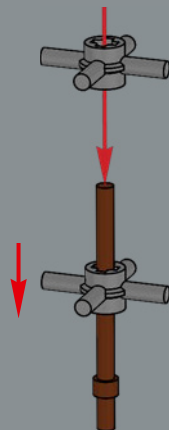





13

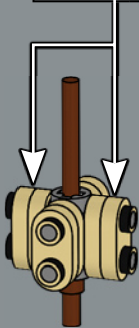
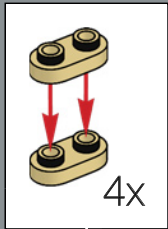

14

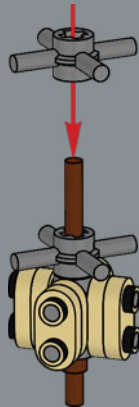



15

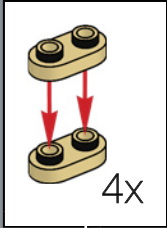

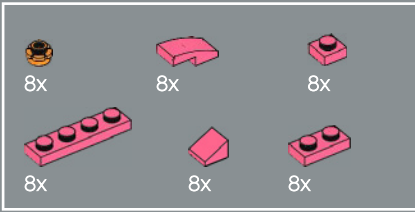

16

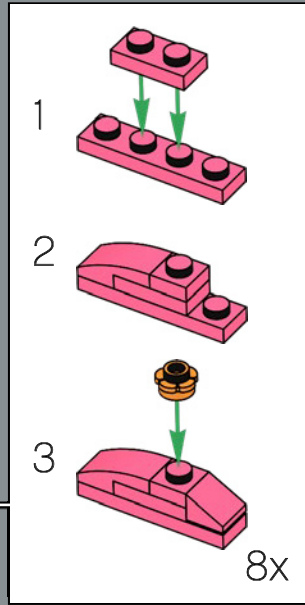
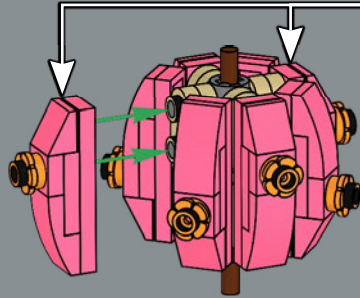



17

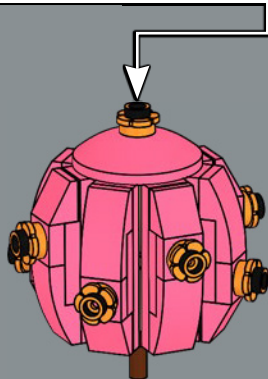
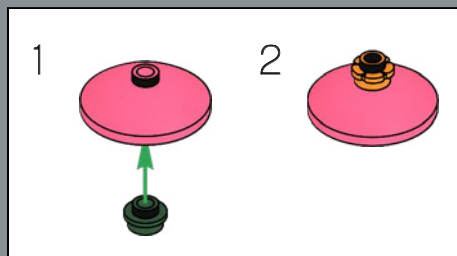

18

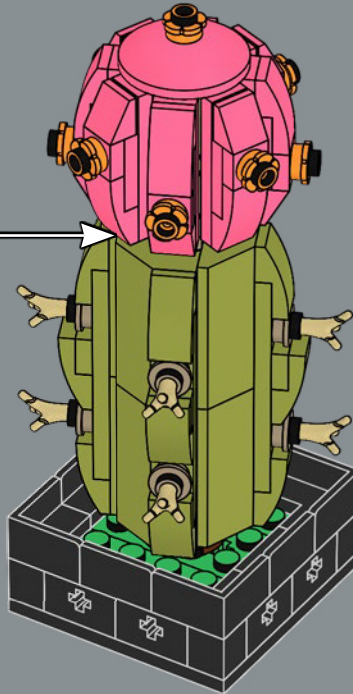

Moon Cactus  
The Moon Cactus glows red because it lacks chlorophyll and must be grafted onto other cacti for it to grow.

Le cactus fraise  
Le cactus fraise est rougeâtre, car il ne produit pas de chlorophylle. Il doit être greffé sur d'autres cactus pour pouvoir se développer.

Cactus bola de rubí  
El cactus bola de rubí es de color rojo brillante debido a que no puede producir clorofila y, por tal motivo, es necesario injertarlo en otra cactácea para que sobreviva.

19

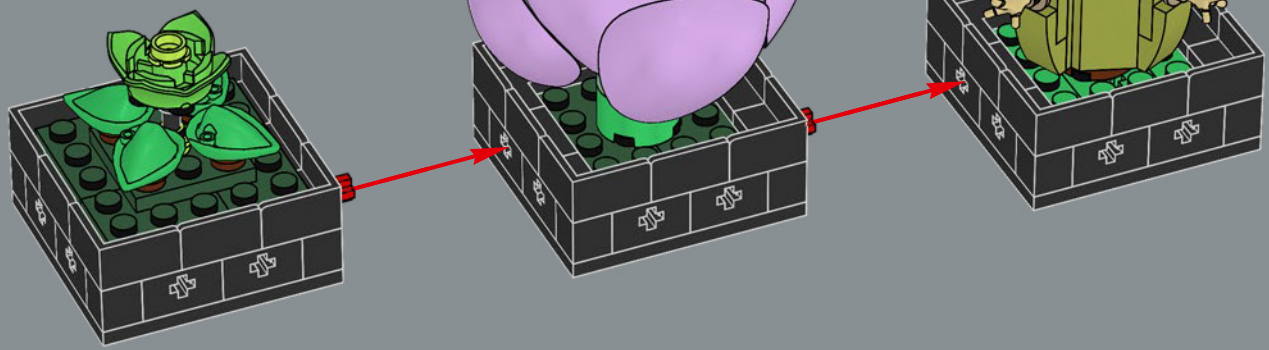



2x

20

