



NINJAGO

Master of Spinjitzu



9450



3

LLOYD ZX + SENSEI WU
INCLUDED





LLOYD ZX + SENSEI WU INCLUDED
LLOYD ZX + SENSEI WU INCLUS
INCLUYE A LLOYD ZX + SENSEI WU

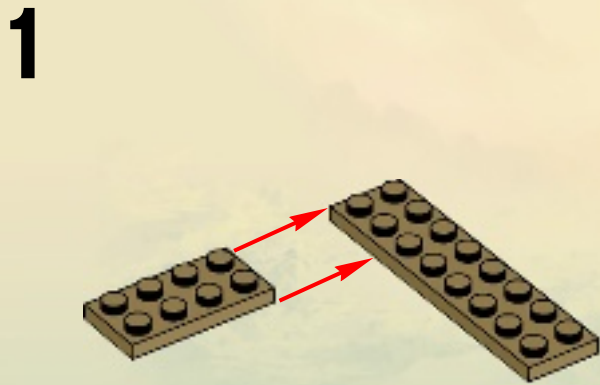
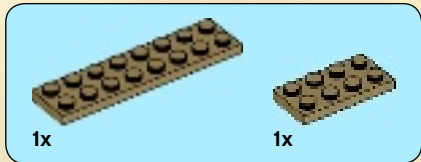
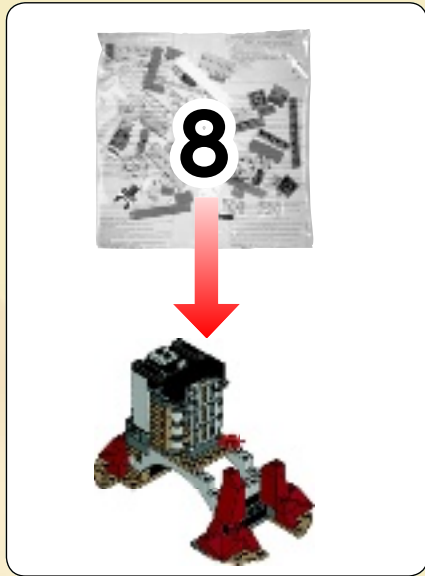

2

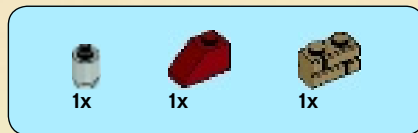
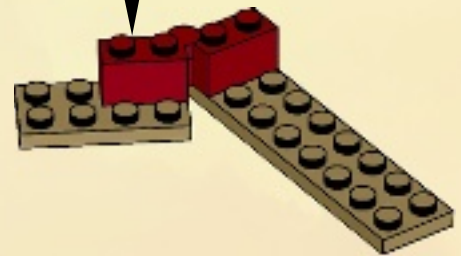
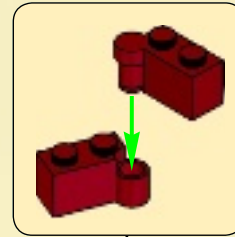

3

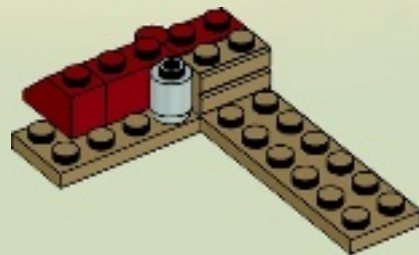



4

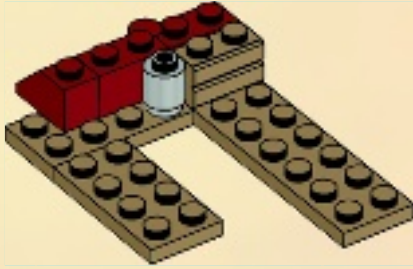

6

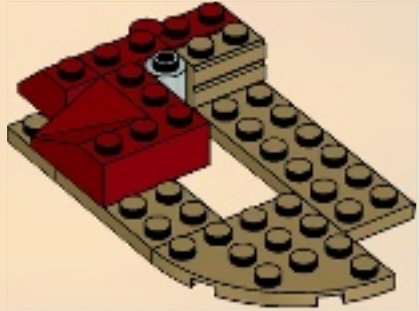

5

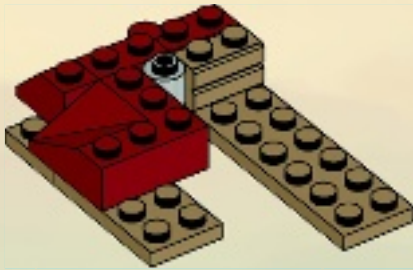

7





8

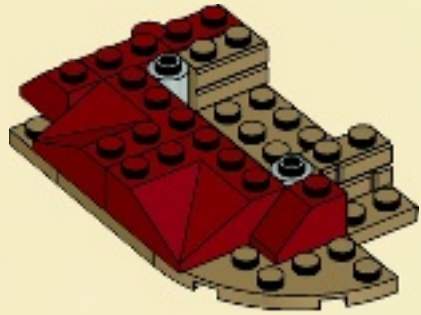

9

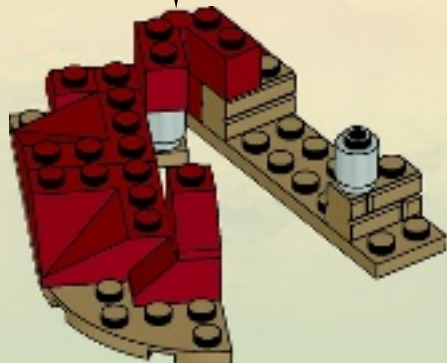
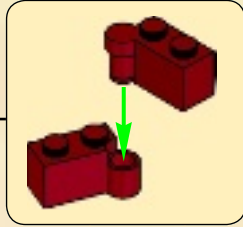

10

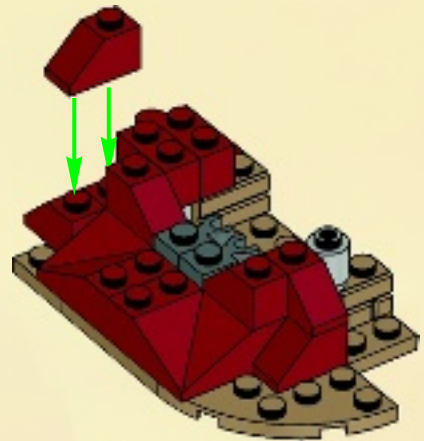

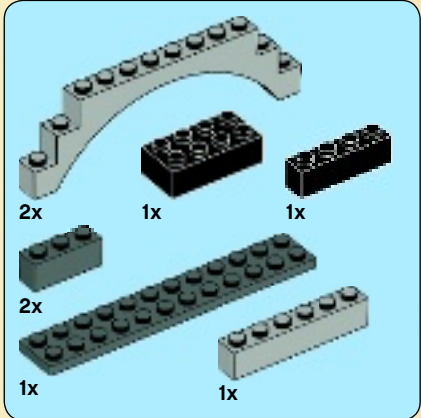
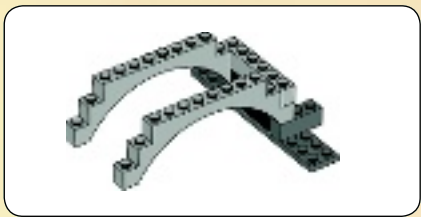

11

1

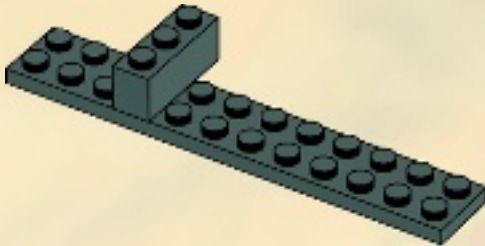

2

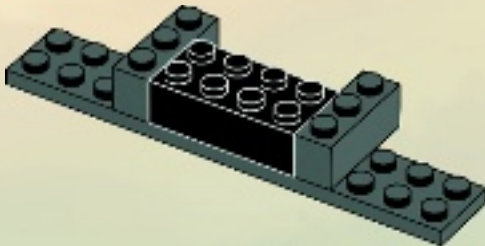

3

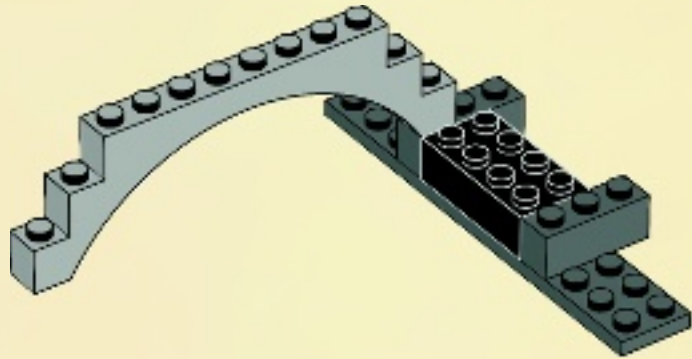

4

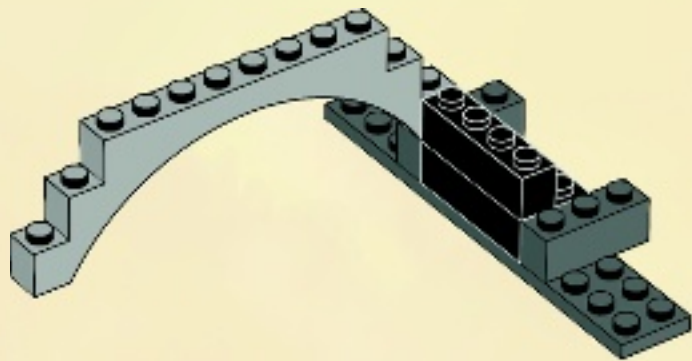

5

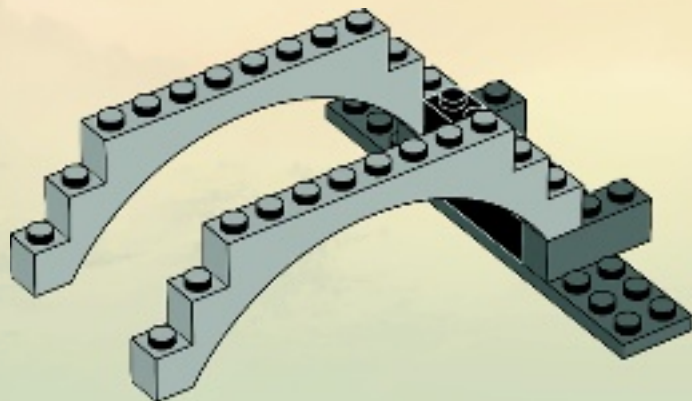

6

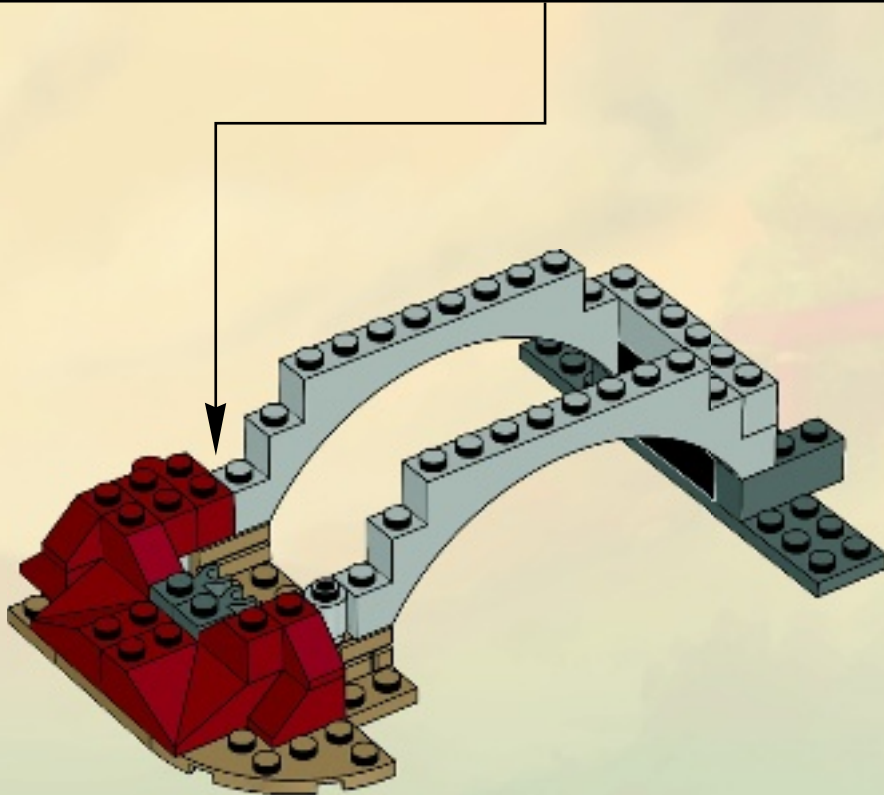
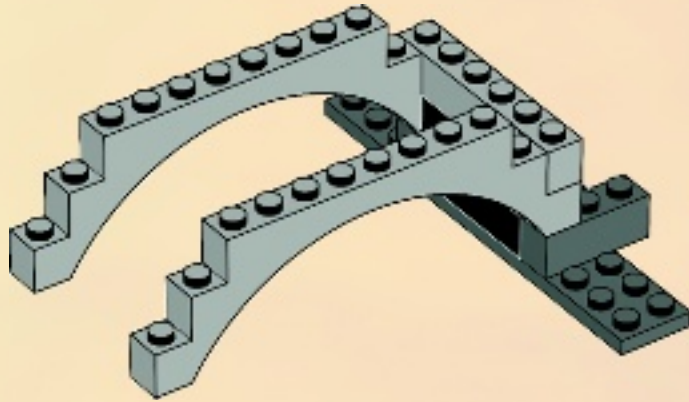



1x



1x



1x

12

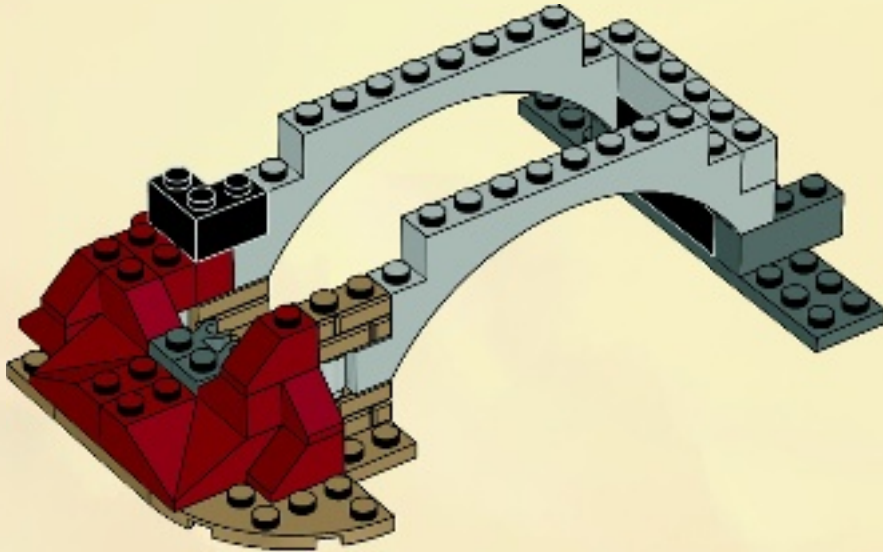



2x

13

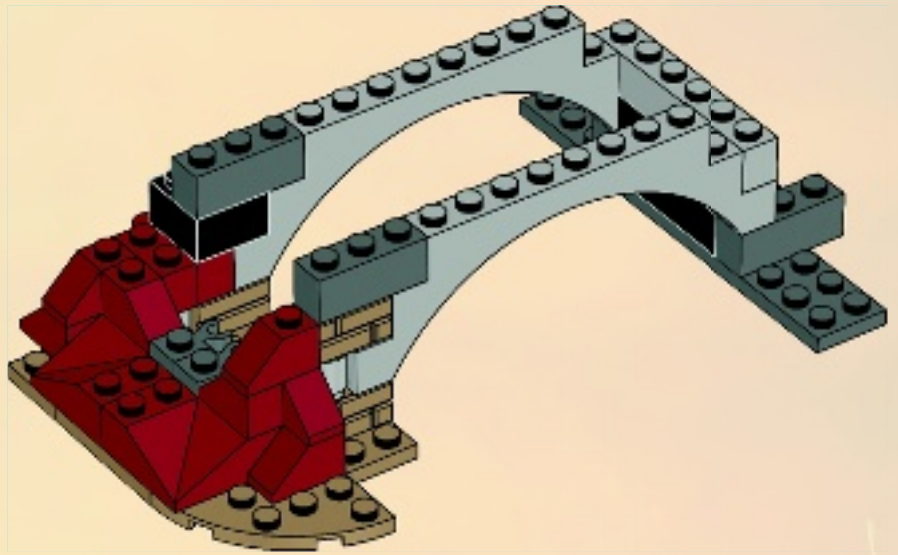

1x



1x

14

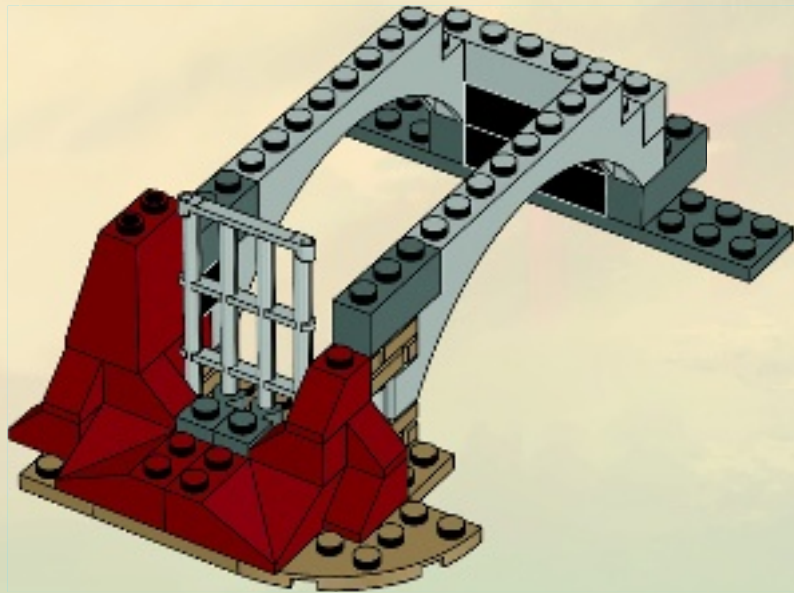



2x

15

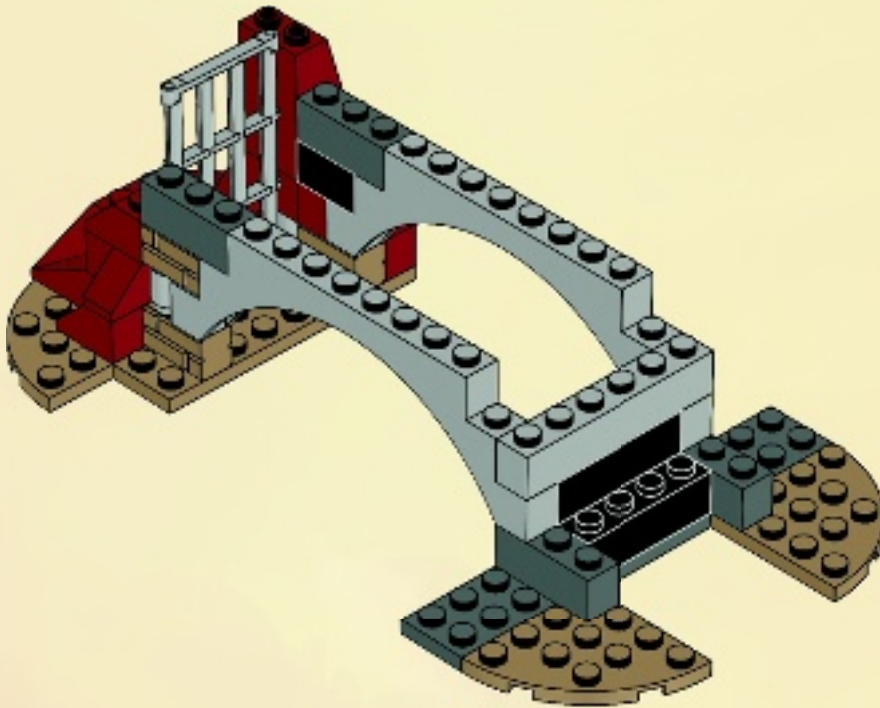

2x



2x

16

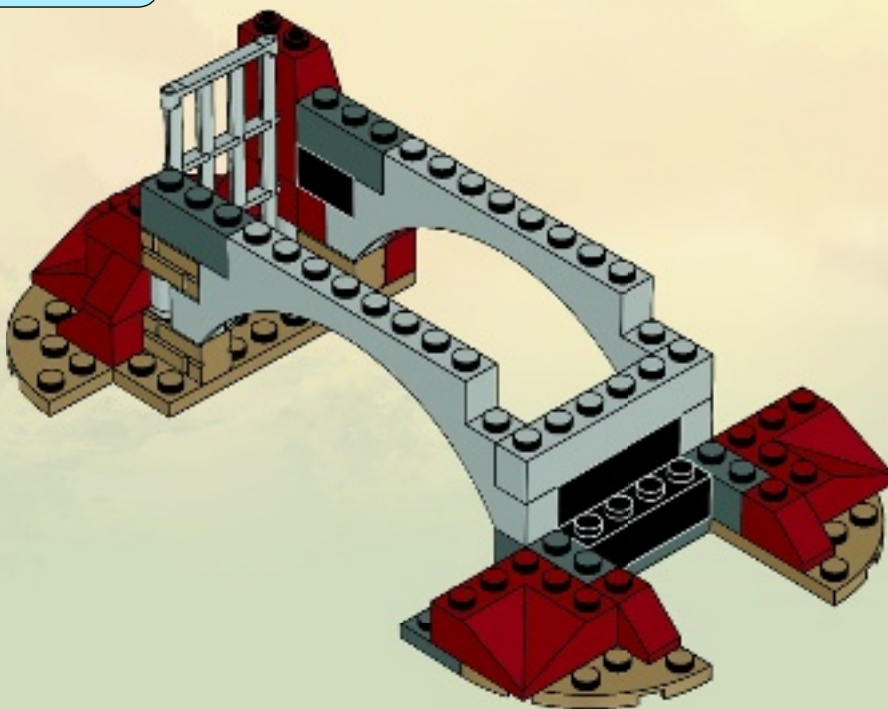



4x

17

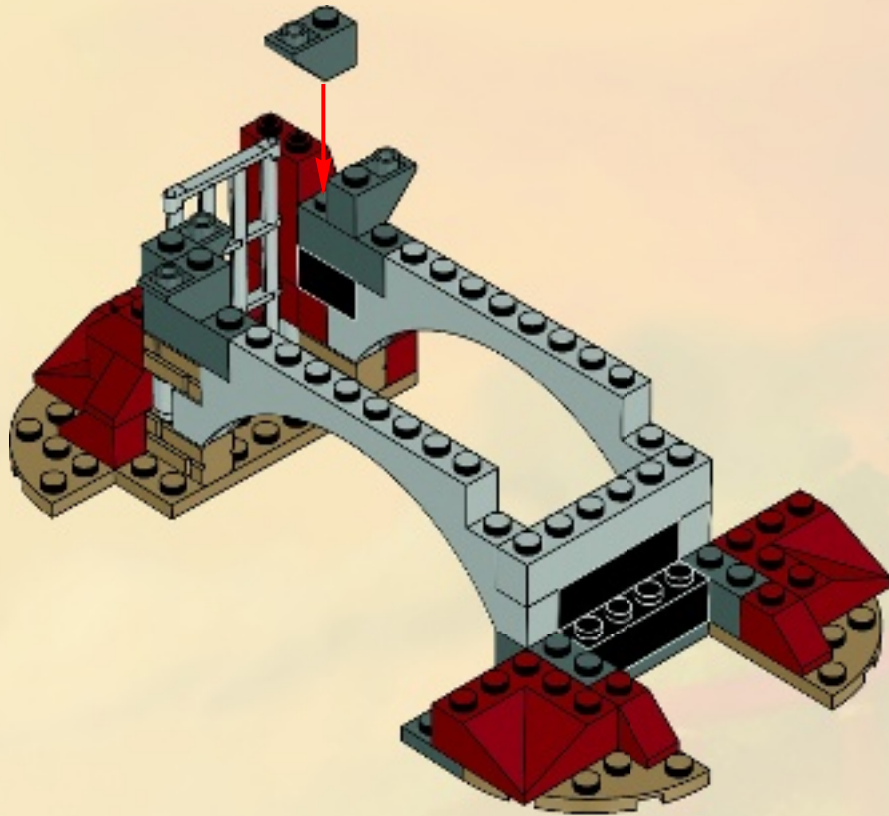

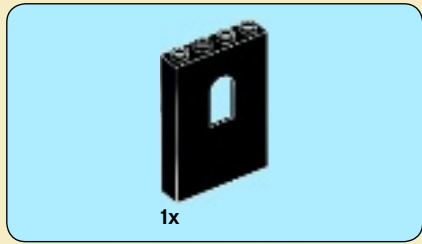

18

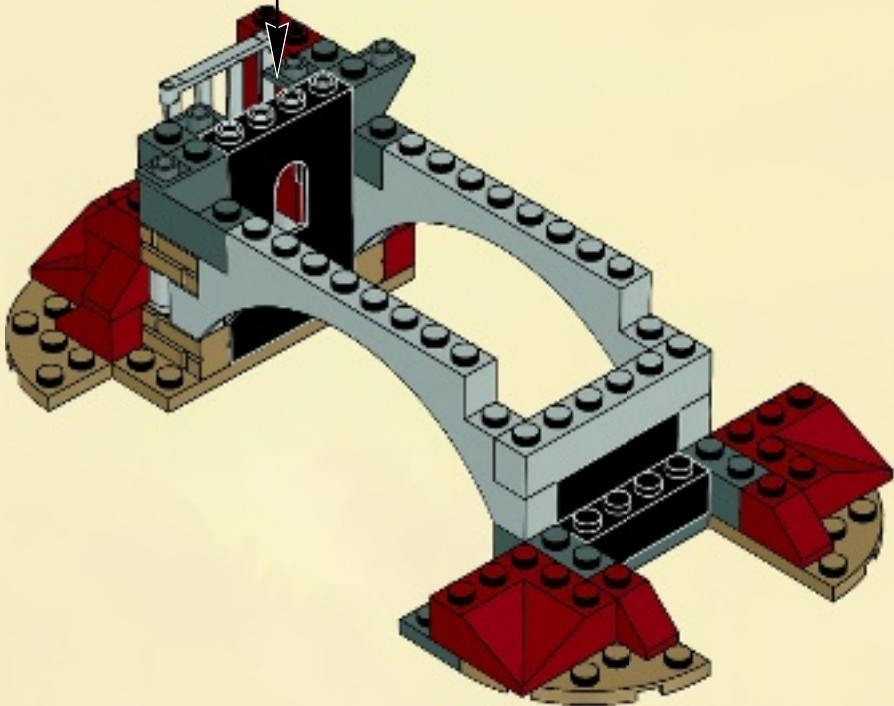
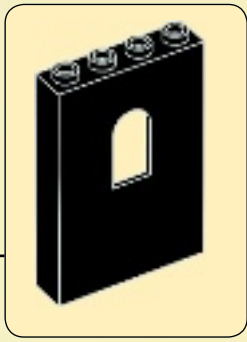

19

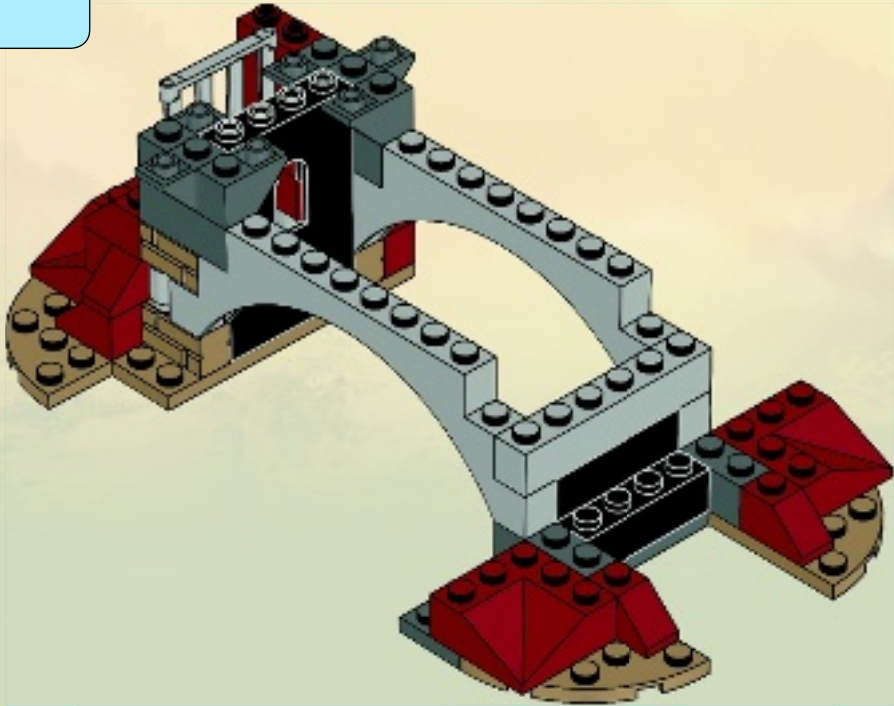



2x

20

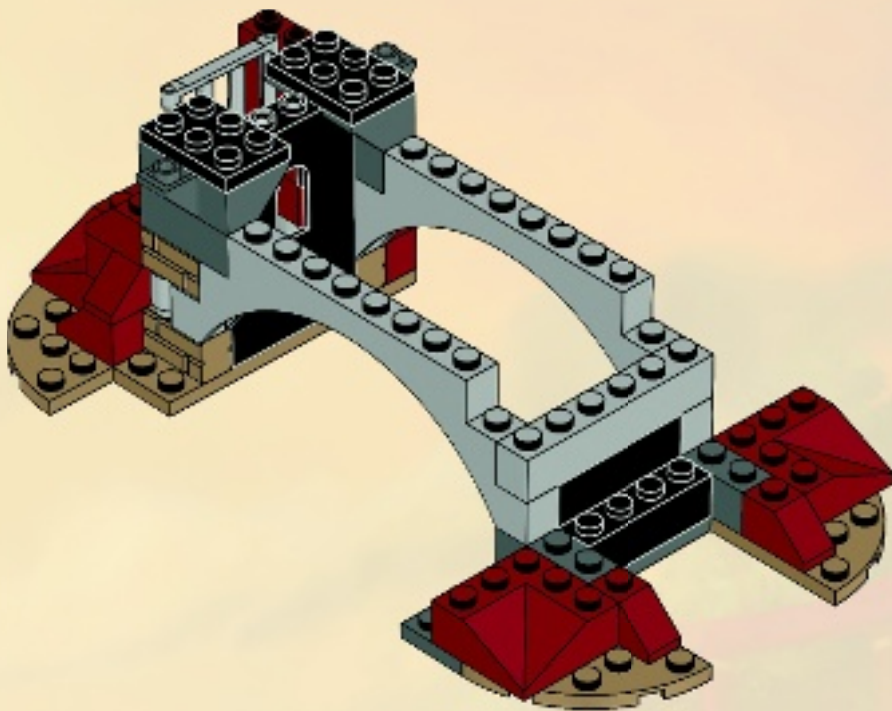



21

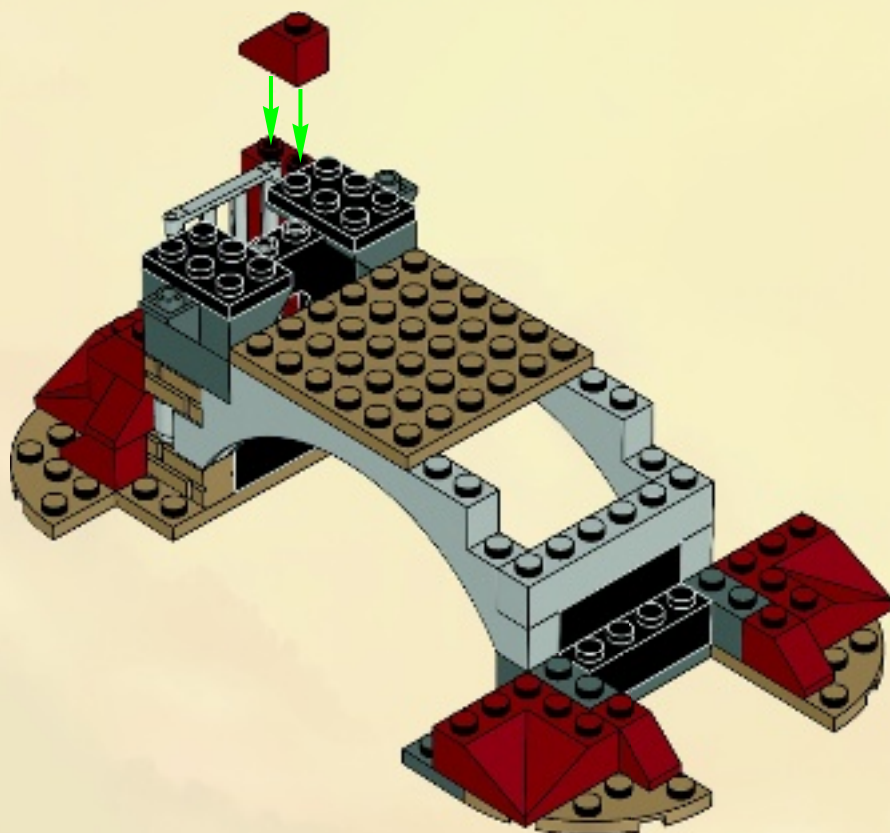



2x

22

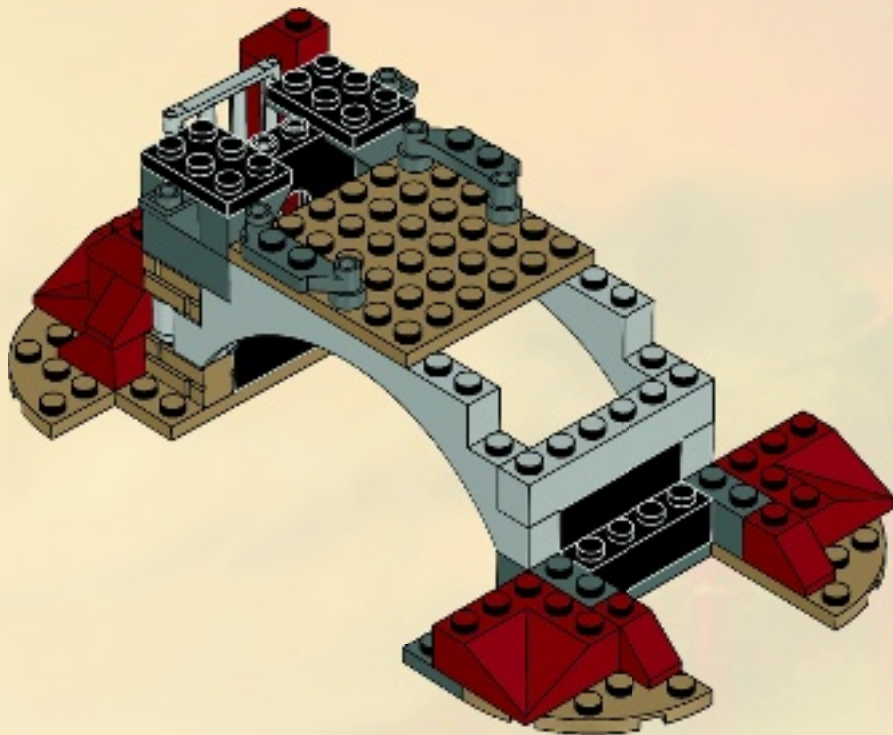

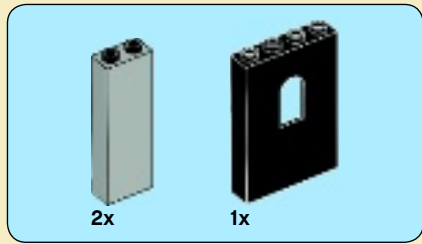

23

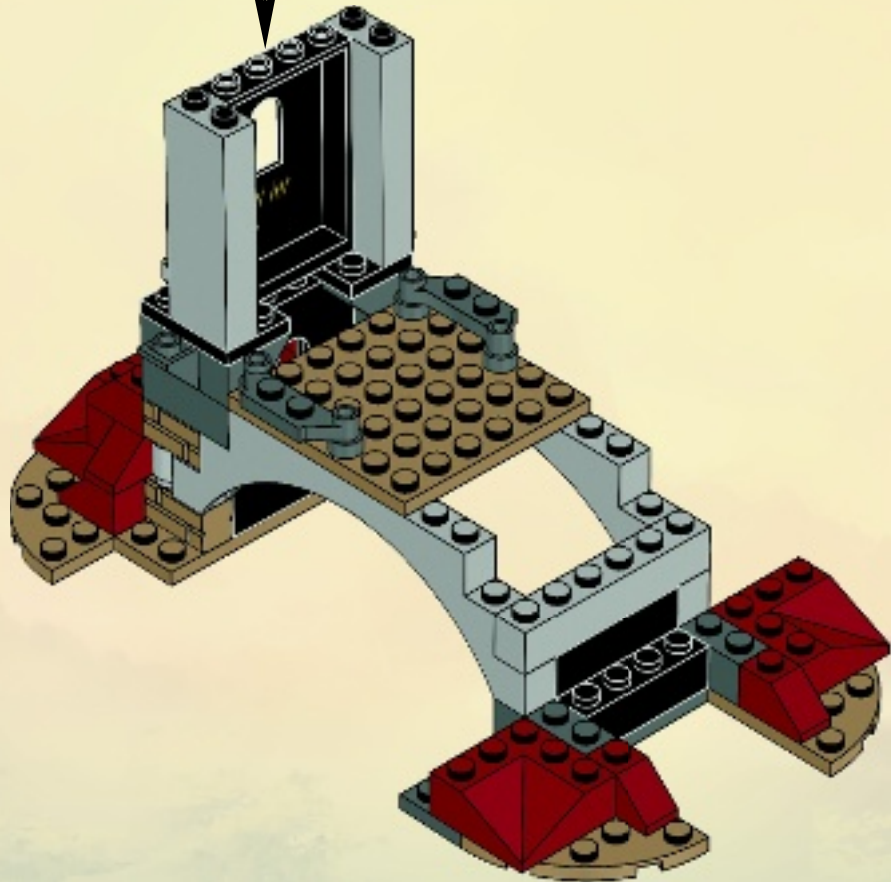
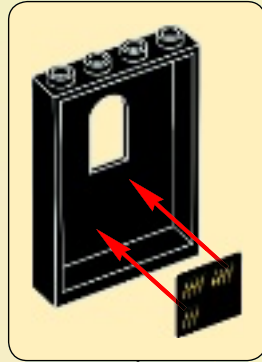



4x



6x

24

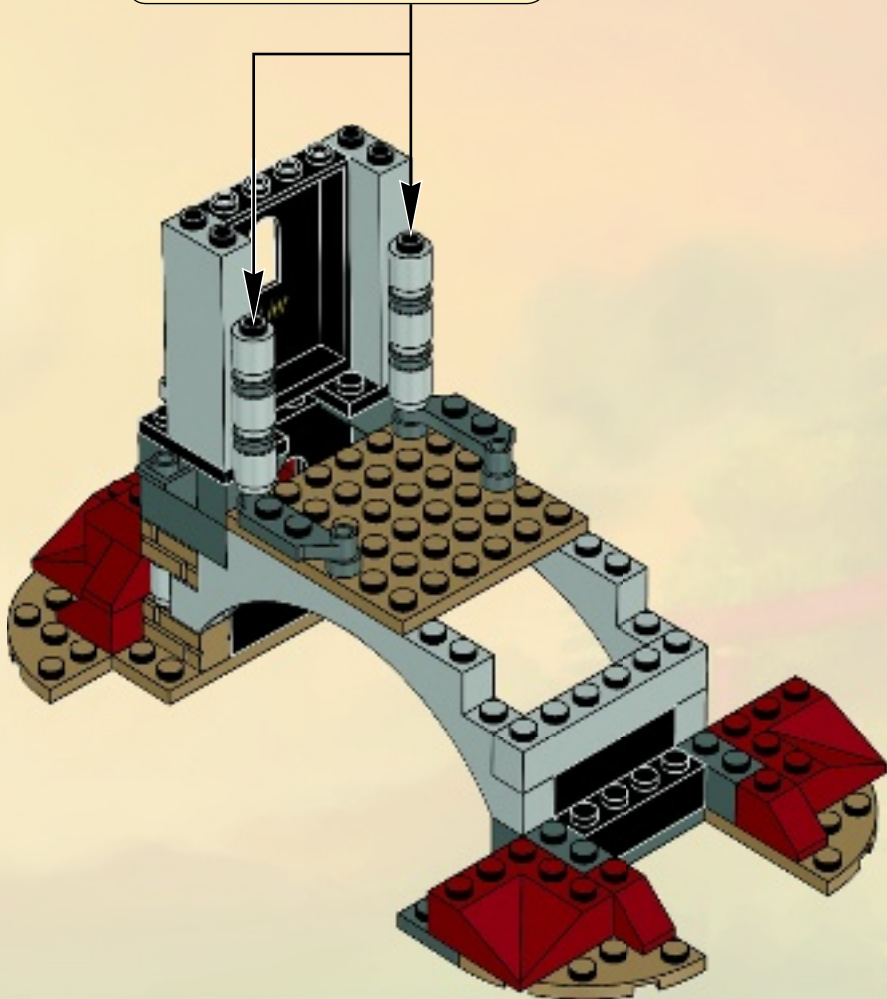
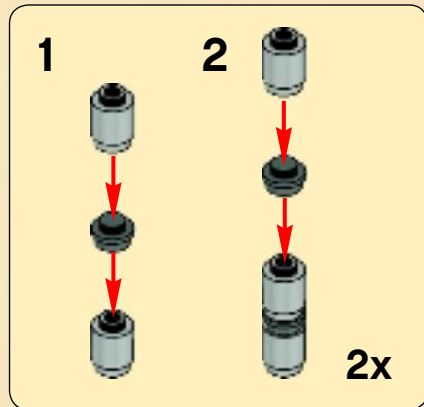



8x

25

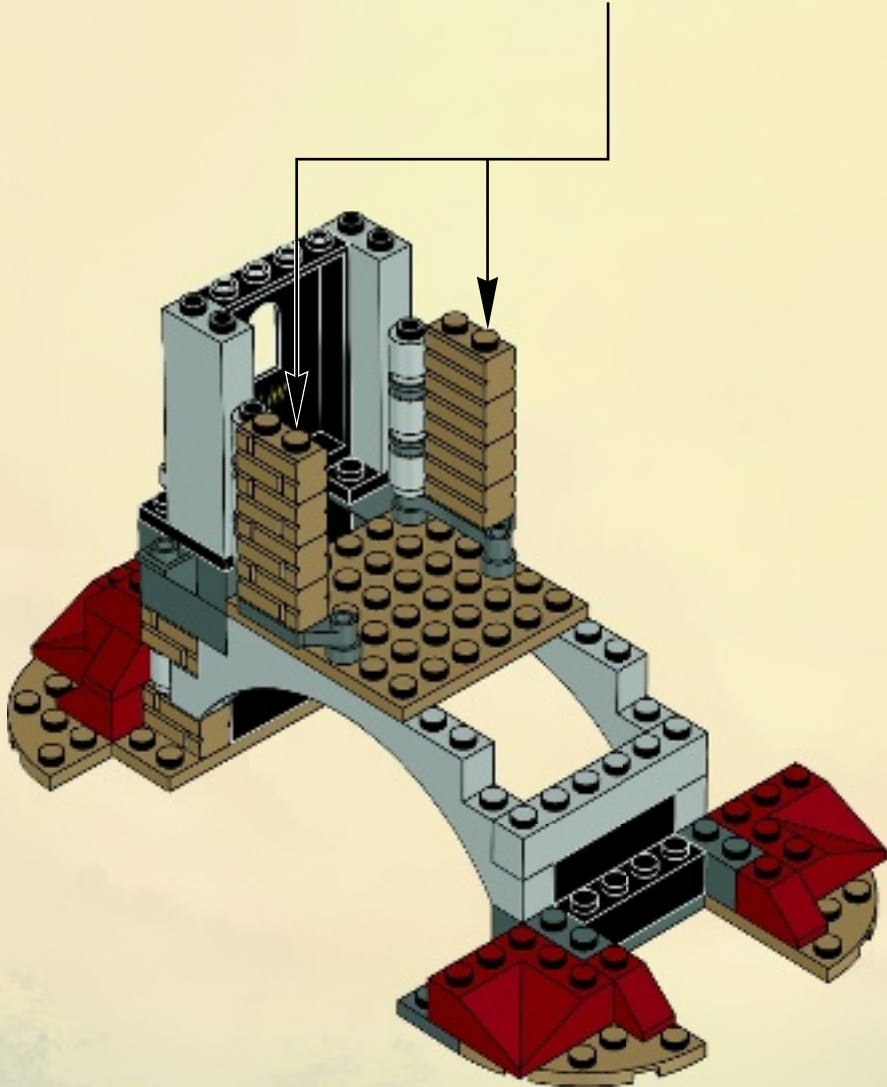
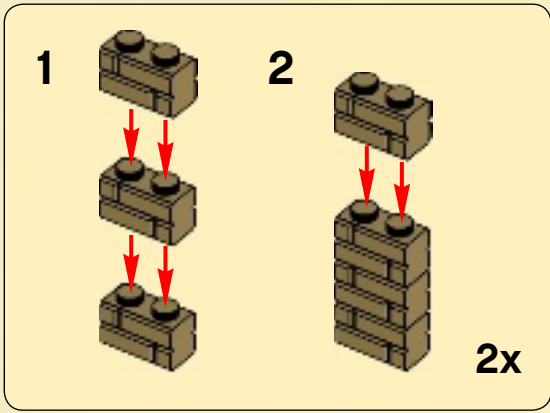

4x

6x

26

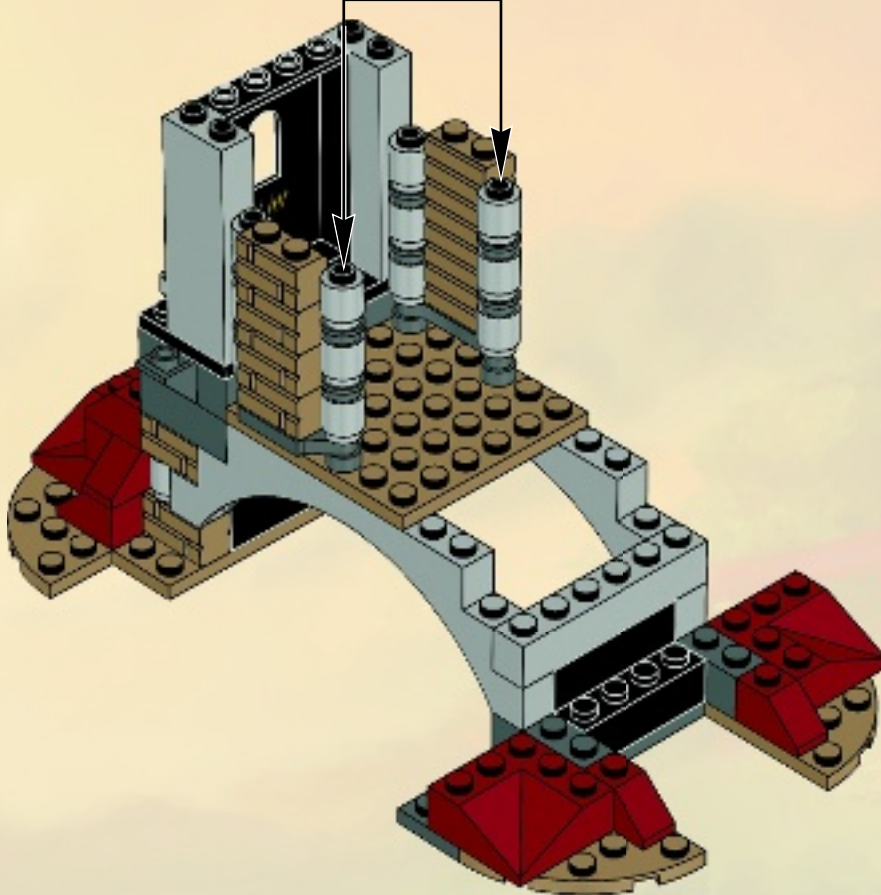
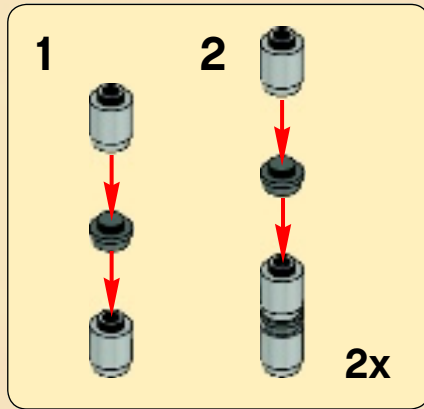



2x

27

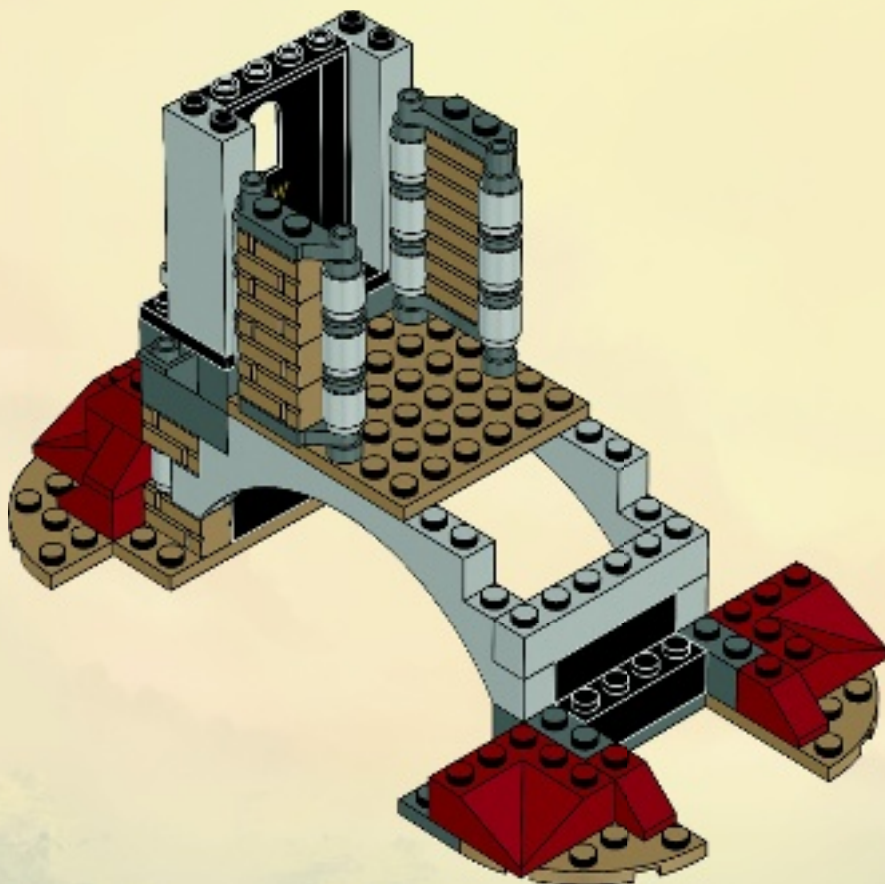

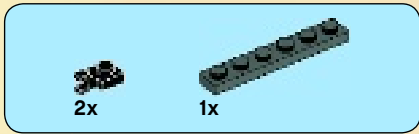

28

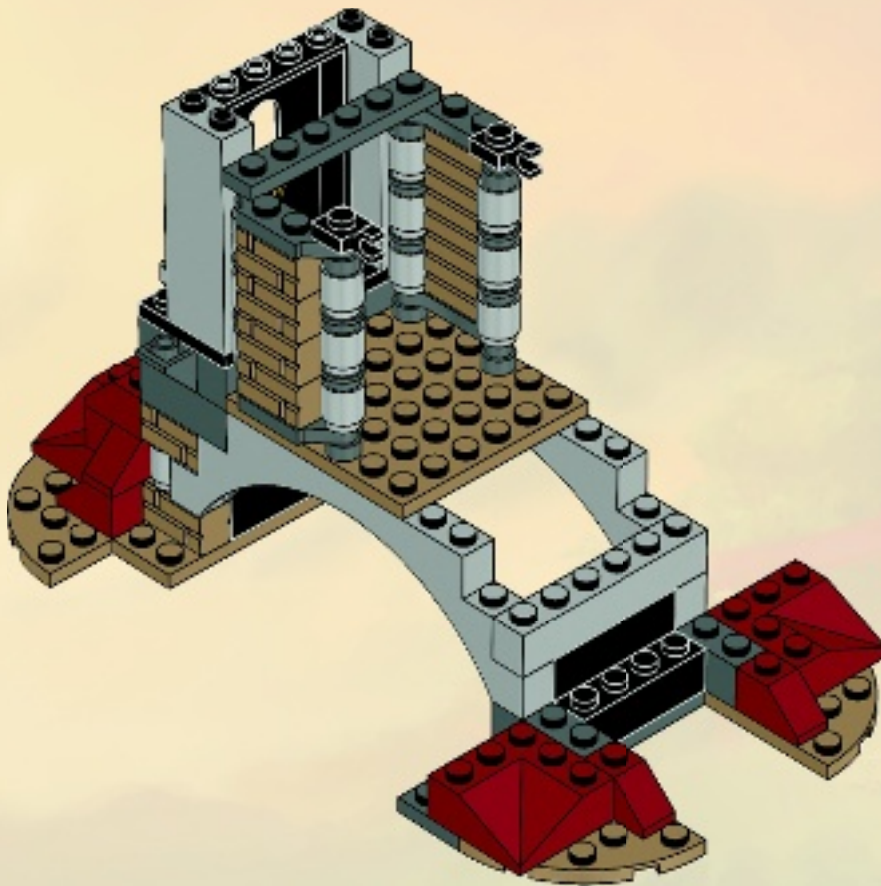



2x

29

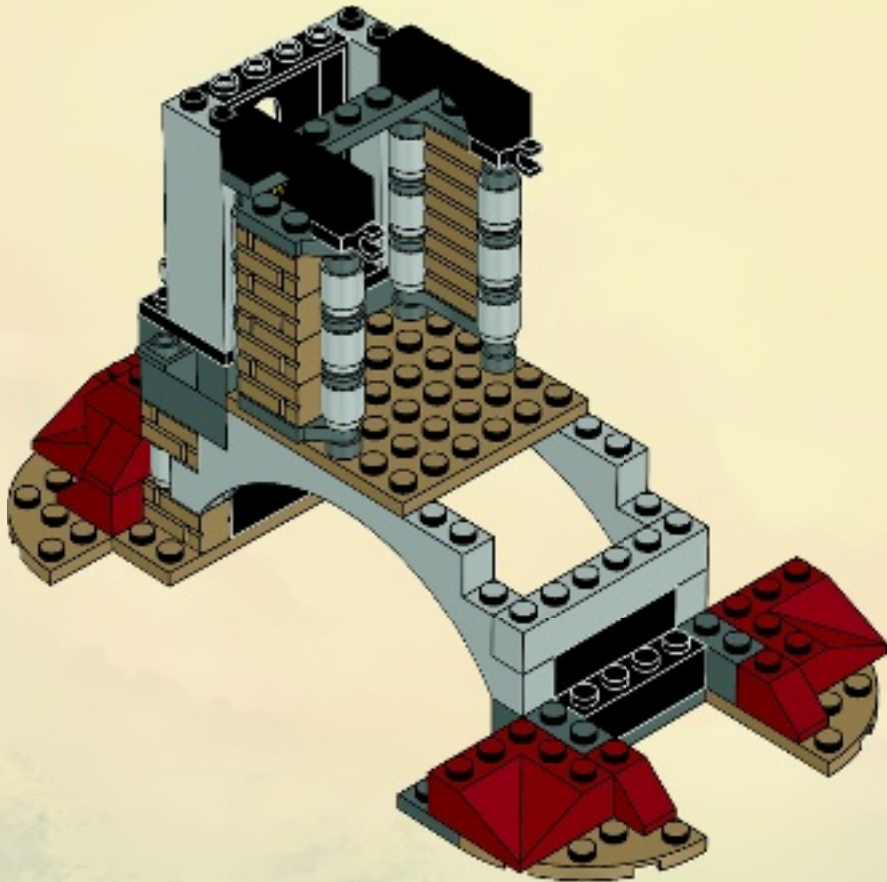

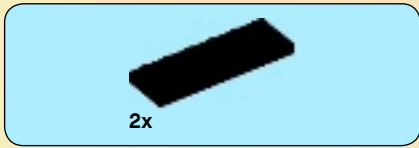

30

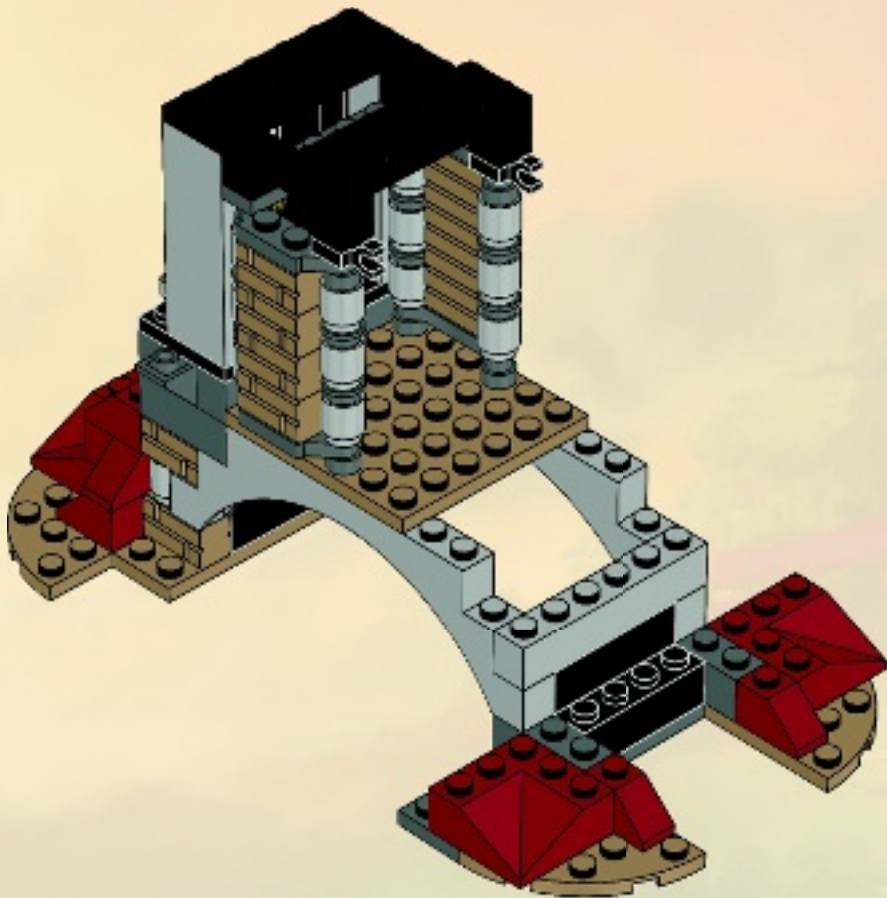

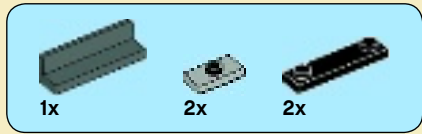

31

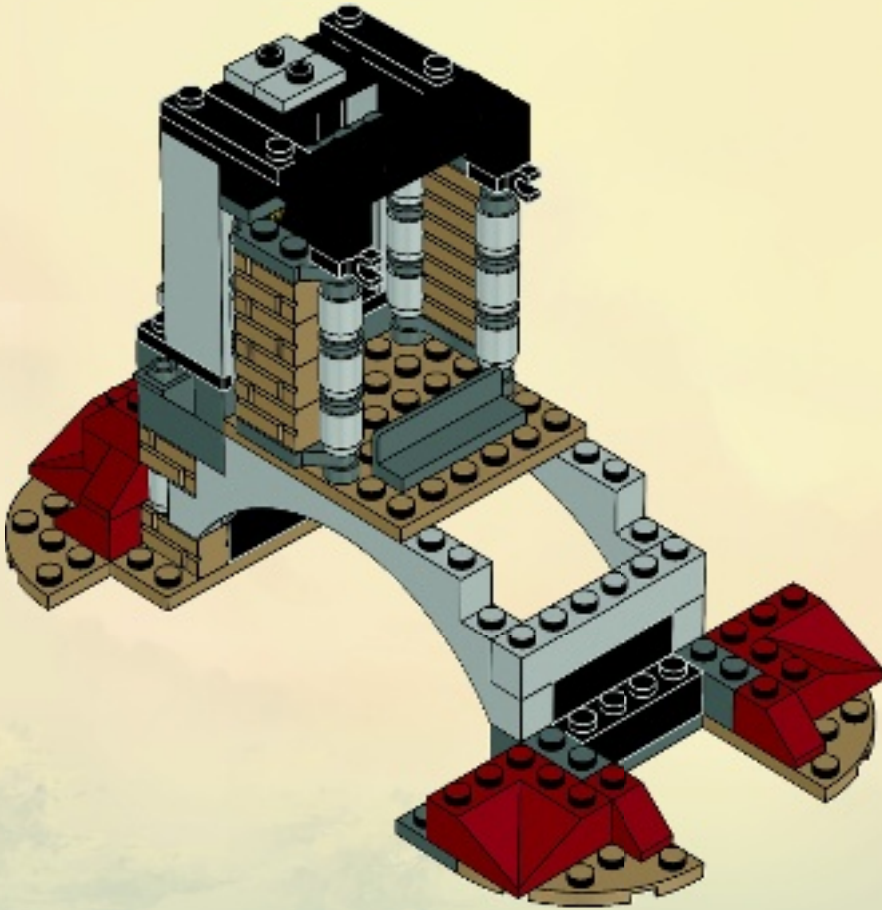

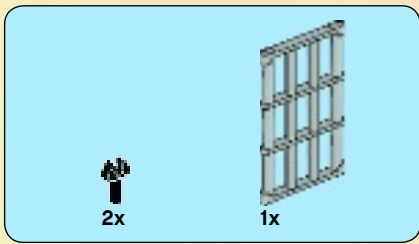

32

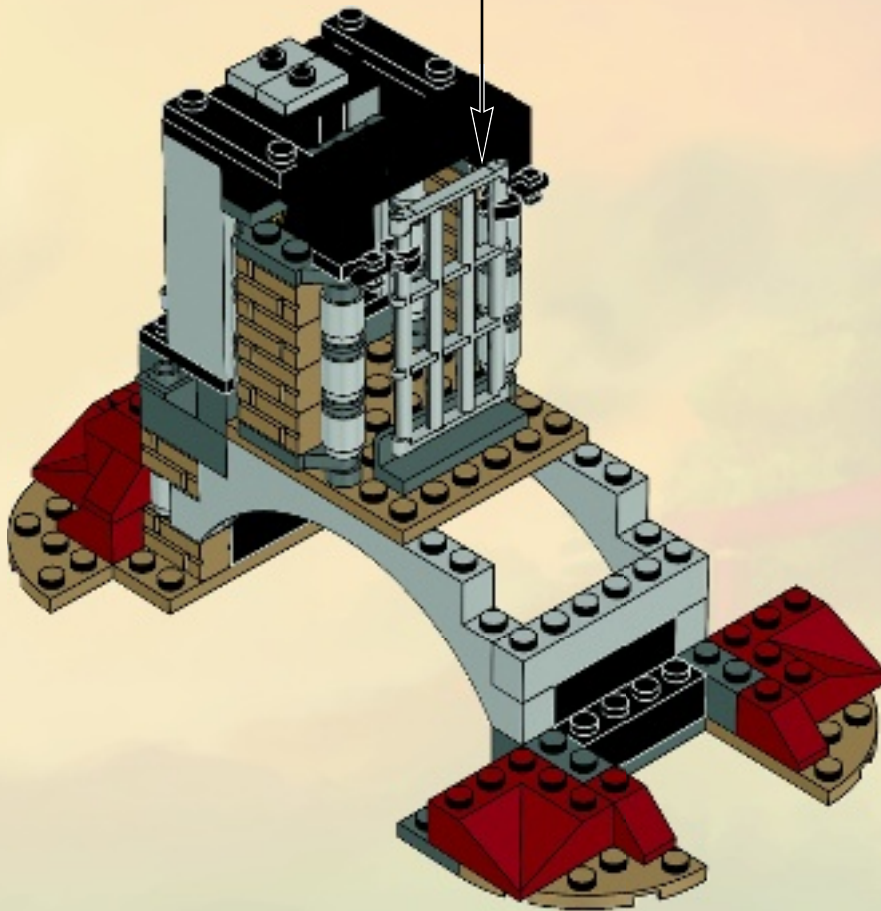
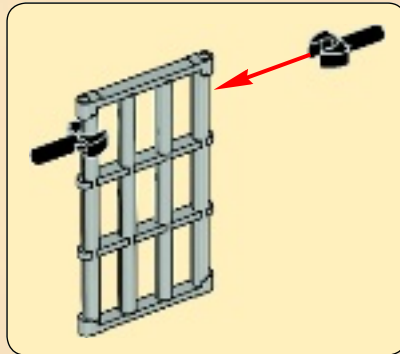



1x



2x

33

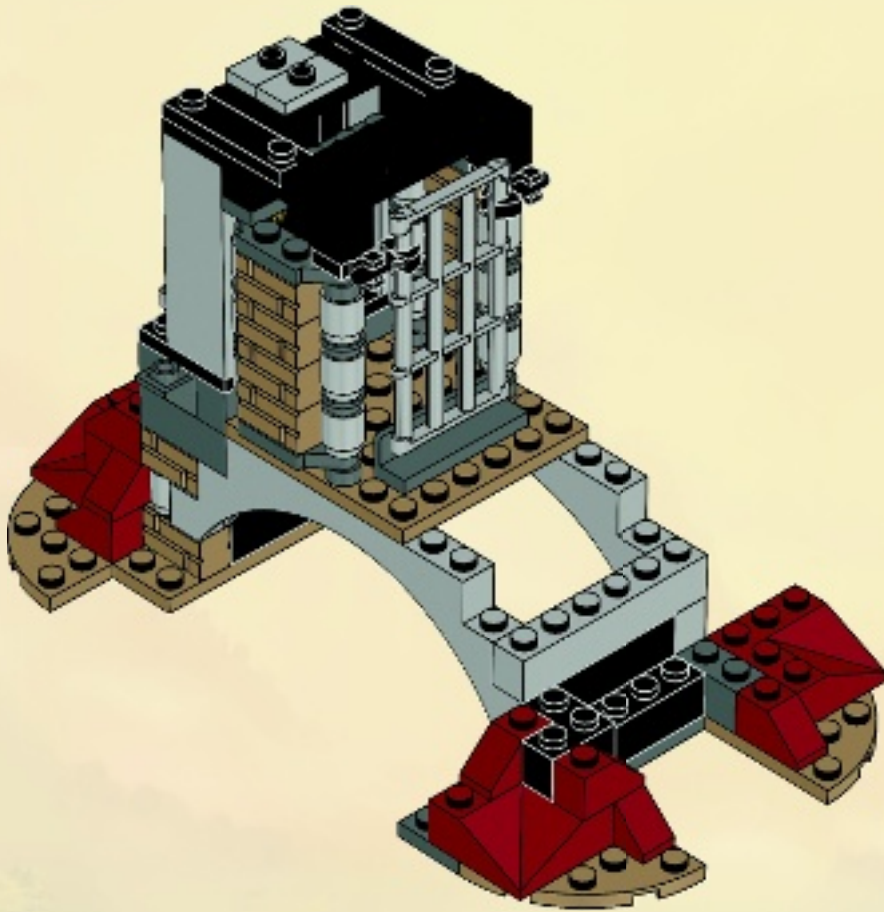

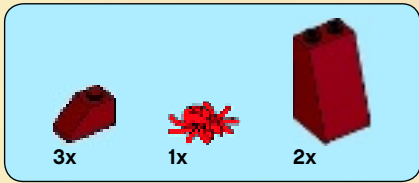

34

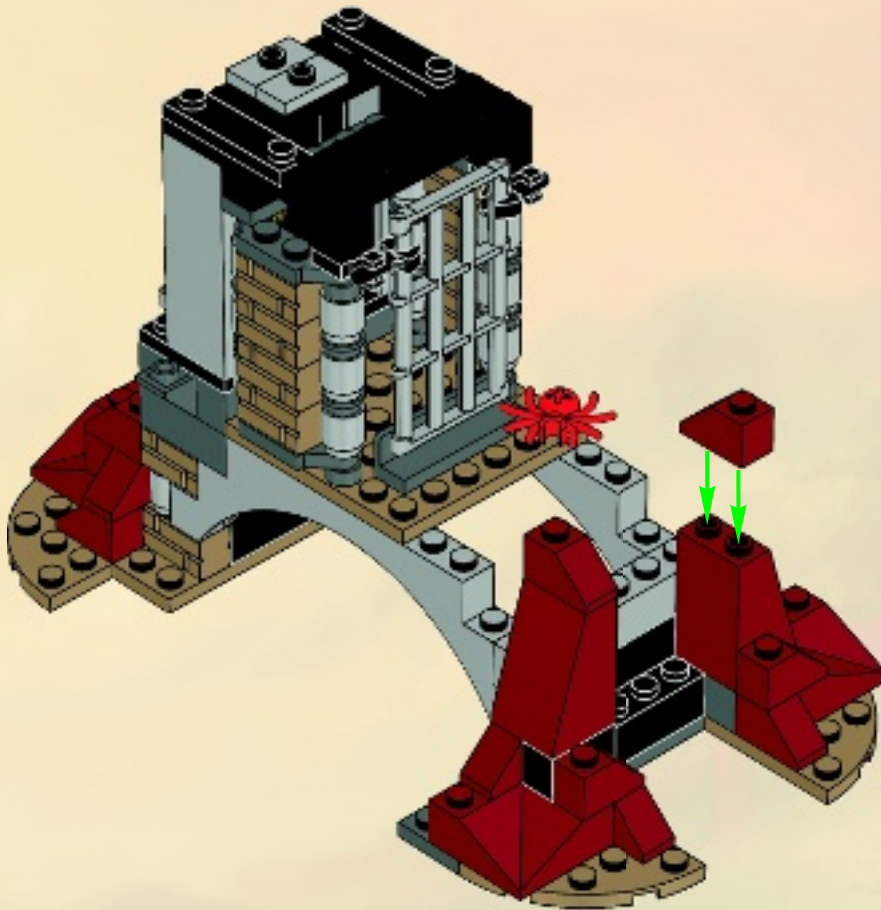

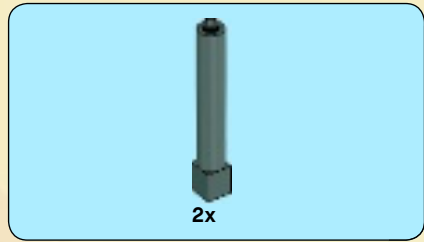
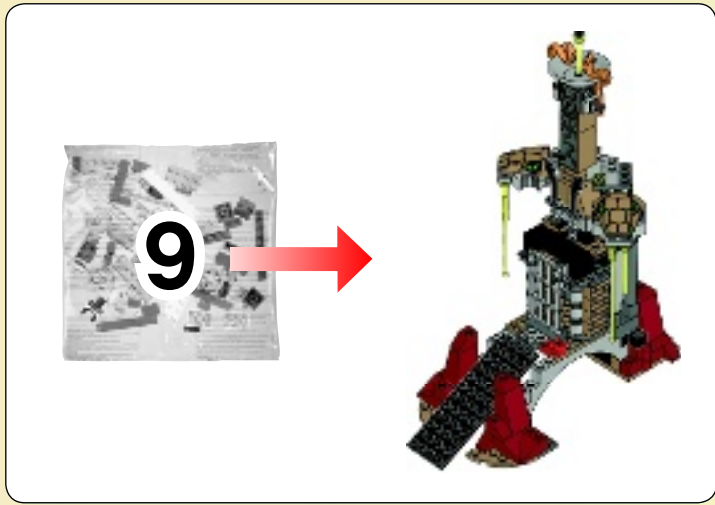

35

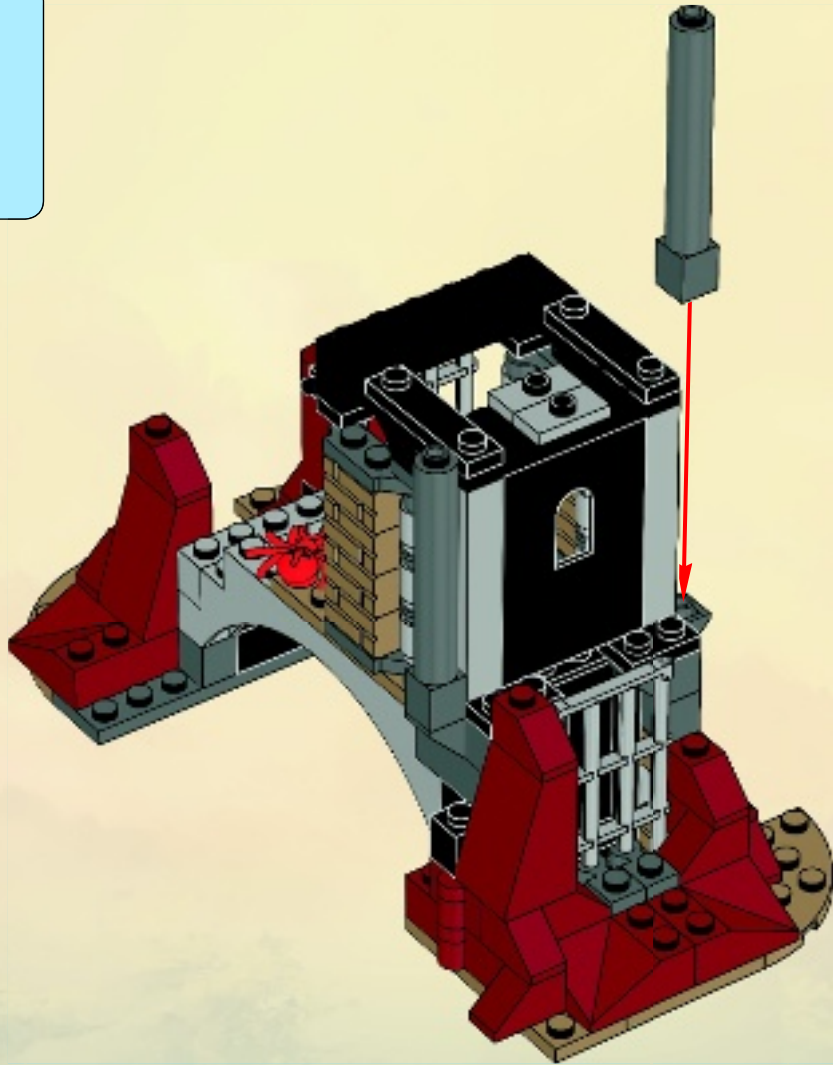
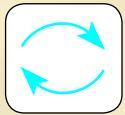



NINJAGO

Masters of Spinjitzu





NINJAGO

Masters of Spinjitzu



- ☐
9573
- ☐
9555
- ☐
9447
- ☐
9555
- ☐
9447
- ☐
9450
- ☐
9591
- ☐
9557
- ☐
9447
- ☐
9449
9450
- ☐
9556
- ☐
9450
- ☐
9447



- ☐
9569
- ☐
9449
9450
- ☐
9447
9570
9572
- ☐
9556
- ☐
9591
- ☐
9591
- ☐
9450
- ☐
9450
- ☐
9591
- ☐
9449
9574
9590
9591
- ☐
9590
- ☐
9450
9591
- ☐
9449
- ☐
9591
- ☐
9450



- 9555
- 9571
- 9450
- 9574
- 9573
- 9554
- 9591
- 9570
- 9449
9450
- 9573
- 9447
9556
9569
- 9554
- 9449



- 9590
- 9591
- 9572
- 9447
- 9447
- 9450
9554
9570
9572
9574
- 9557
- 9571
- 9449
- 9448
9449
9557
- 9591
- 9449
9550
- 9450



NINJAGO

Masters of Spinjitzu



LLOYD ZX
9574 • 9450



NRG ZANE
9590



NRG COLE
9591



NRG JAY
9570



NRG COLE
9572



CHOKUN
9553 • 9450



MEZMO
9555



FANGDAM
9571



SPITTA
9569 • 9449



PYTHOR
9449



SLITHRAA
9573



LIZURA
9557



BYTAR
9556 • 9448



1x



2x

36

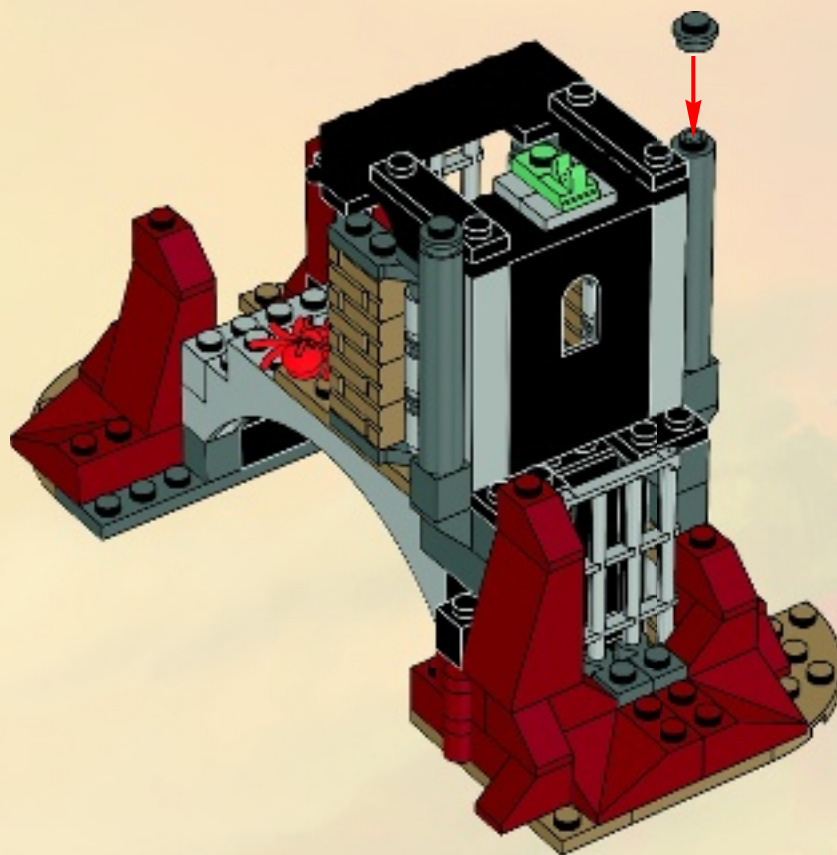

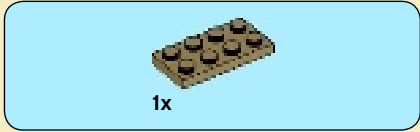
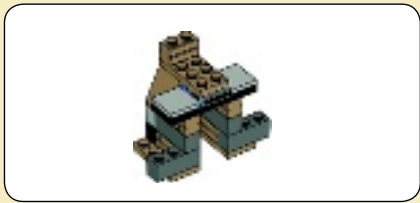

1

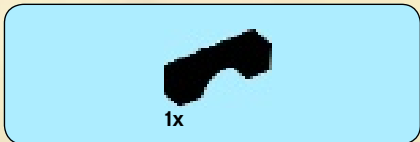

2



3

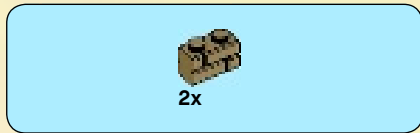
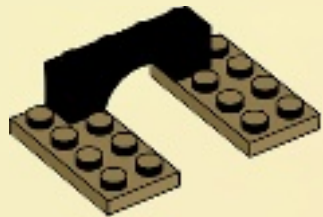

4

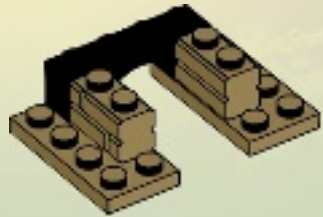

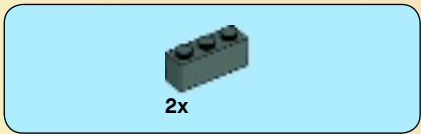

5

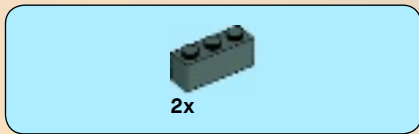
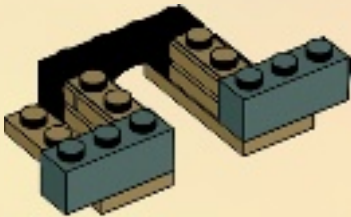

7

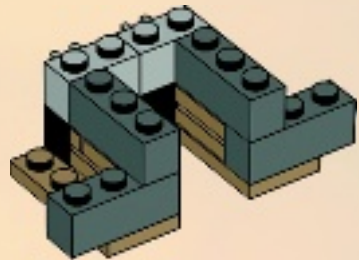

6

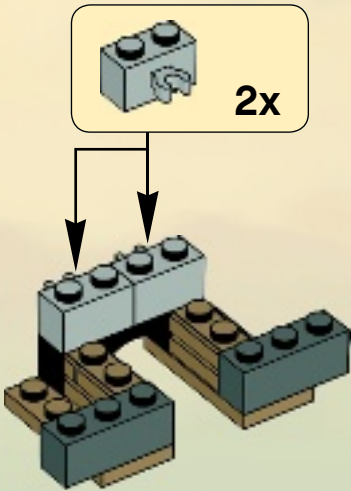

8

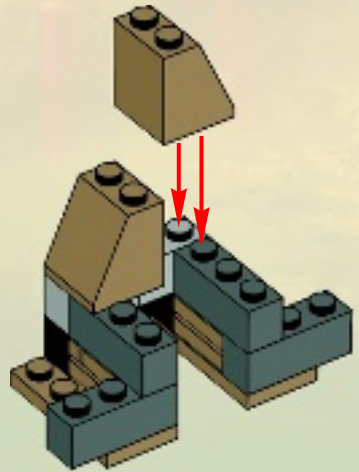



2x

9

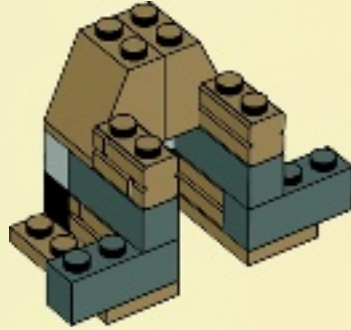

1x



1x



2x



1x

10

1



2

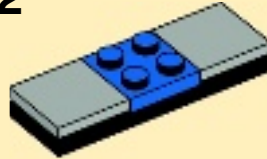

3

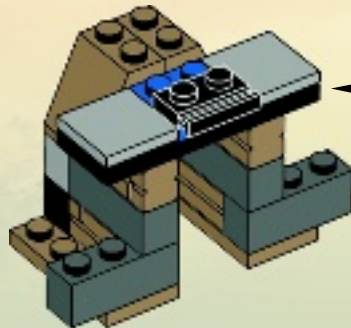
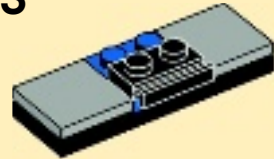



1x

11

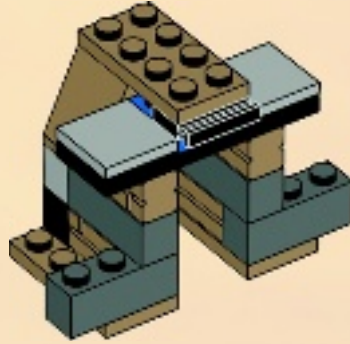

1x

12

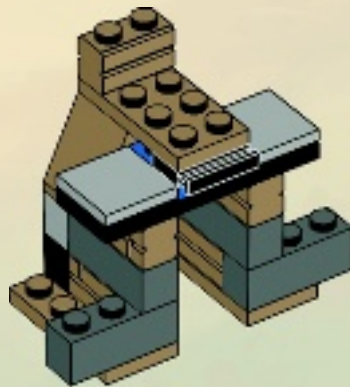

37

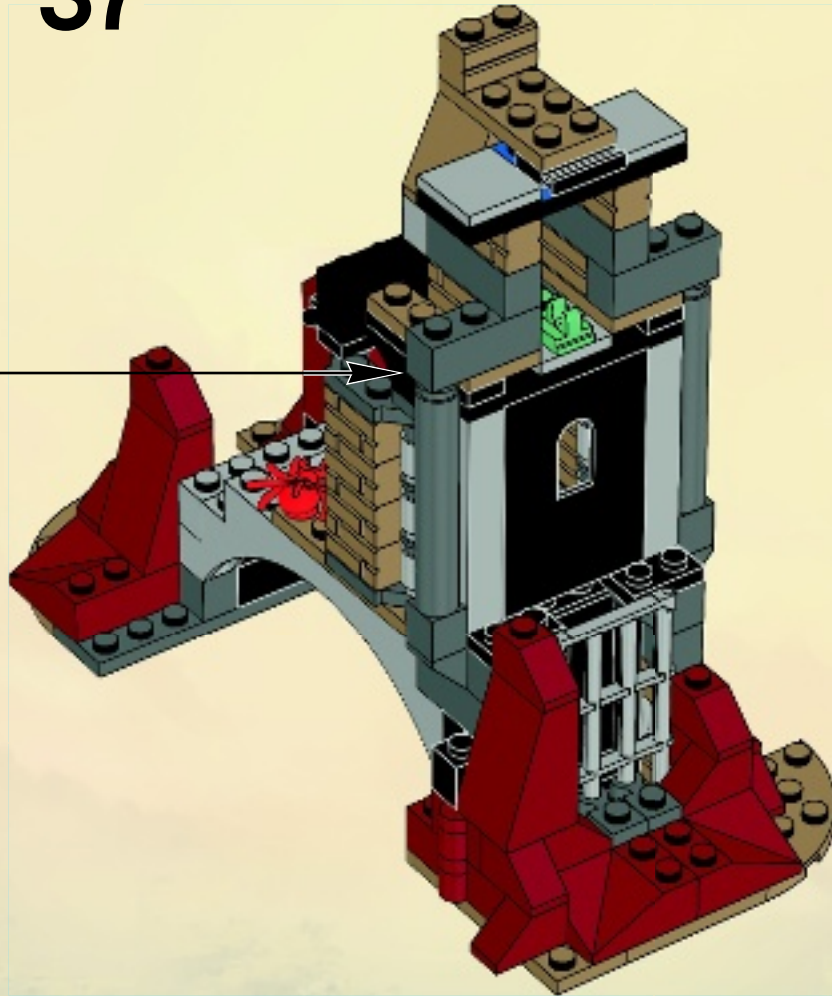

1x  2x 

38

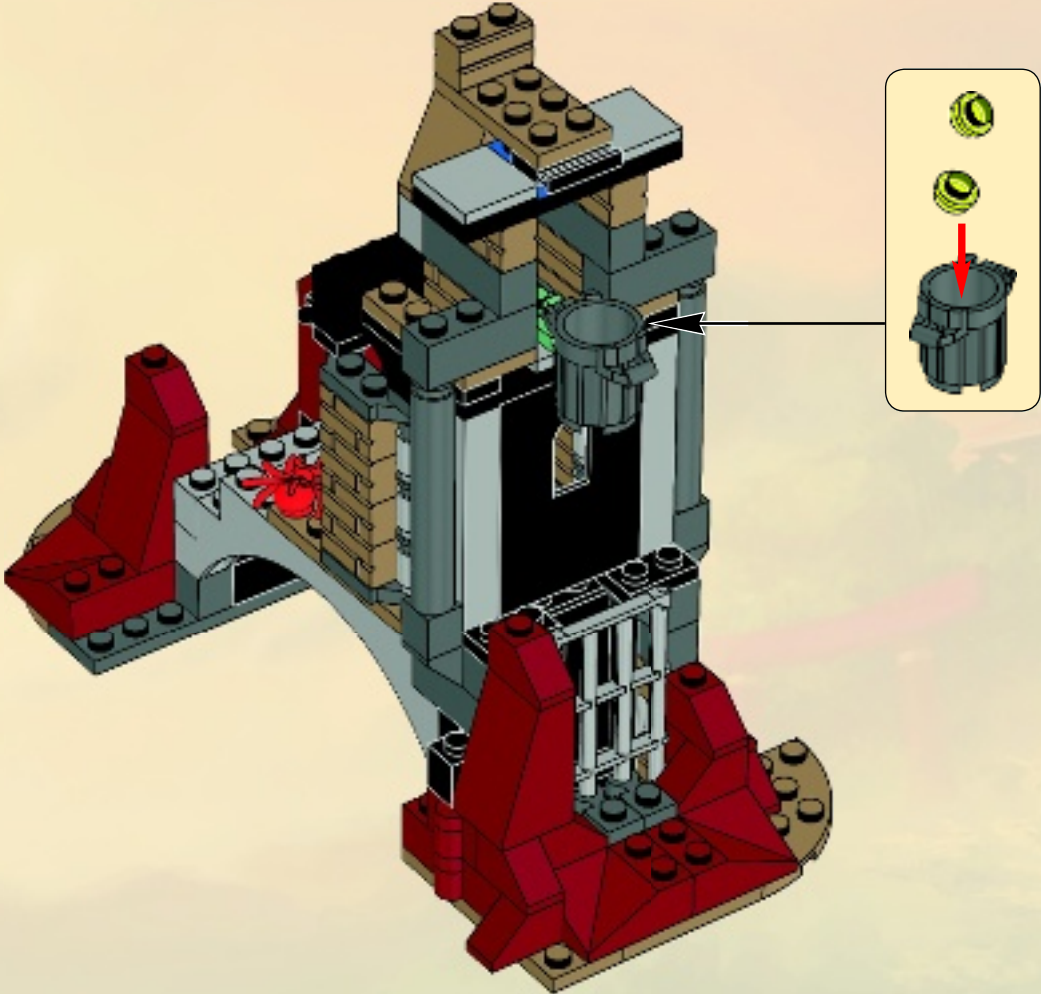

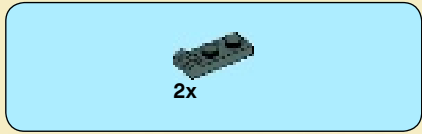
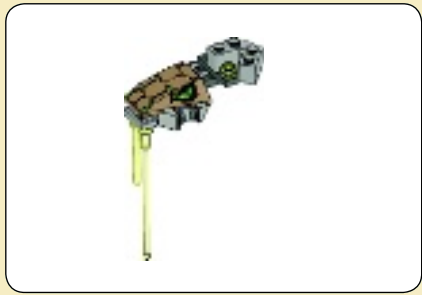

1

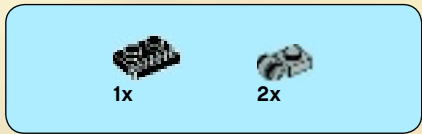
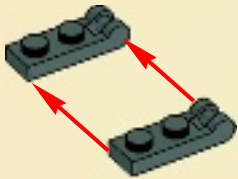

2

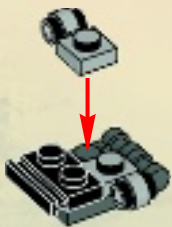

3

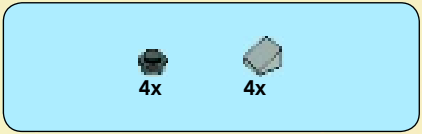
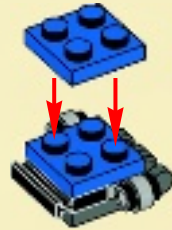

4

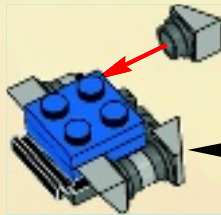
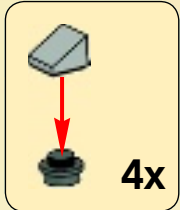

5



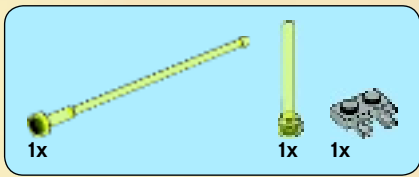

6

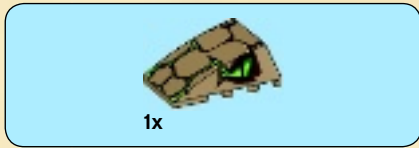
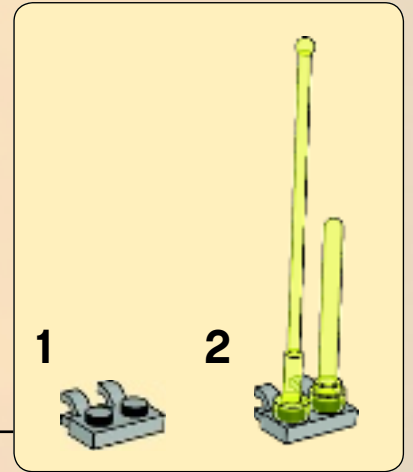
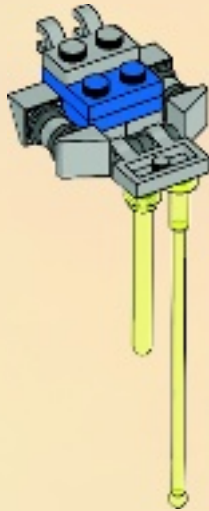
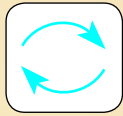

7

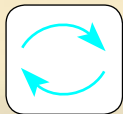

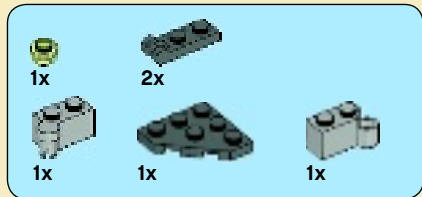

8

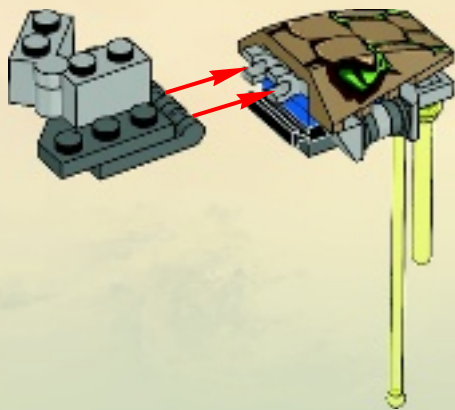
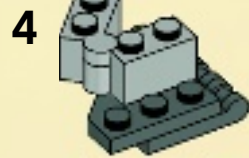
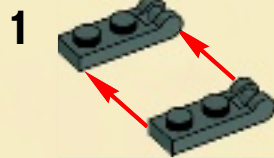
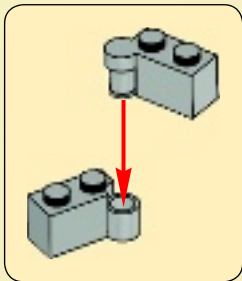

39

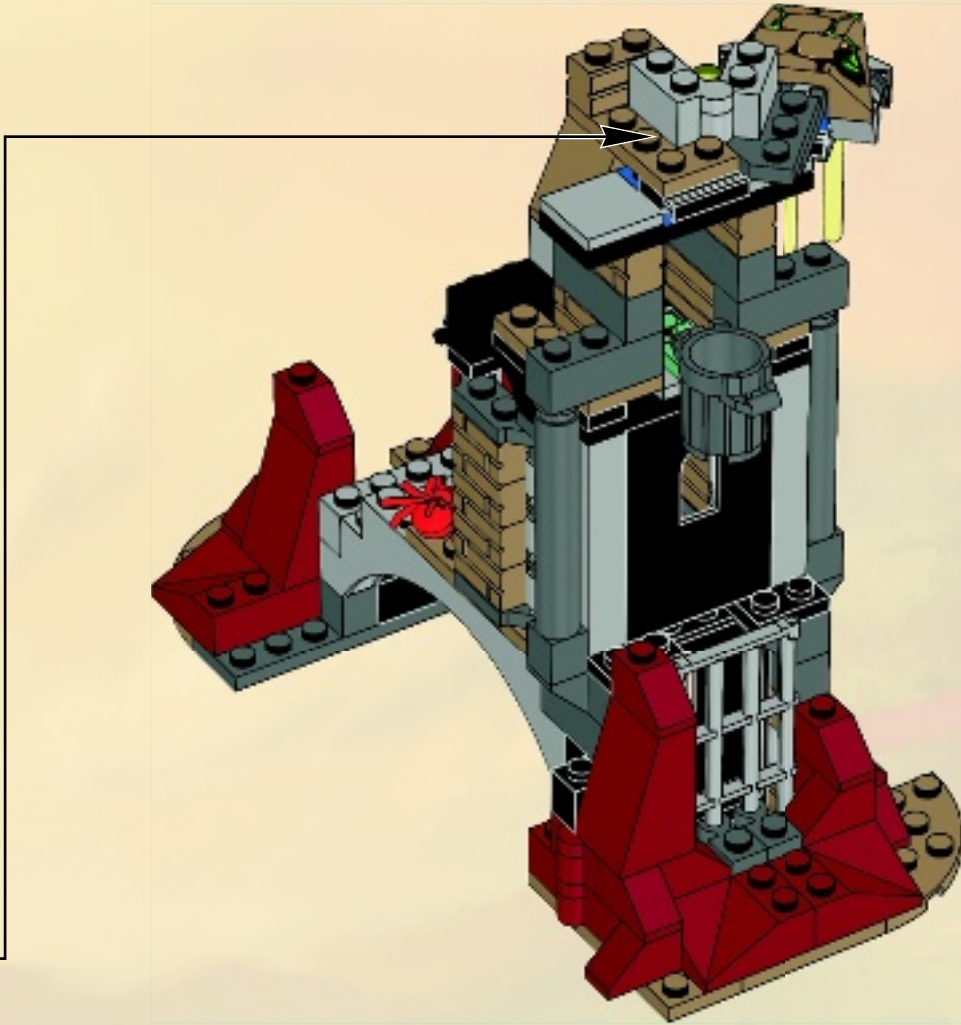

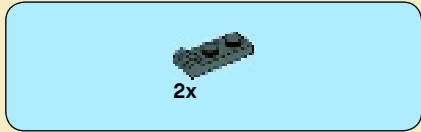

1

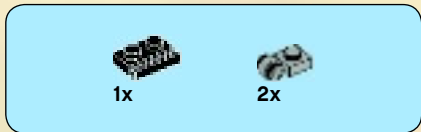
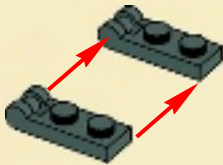

2

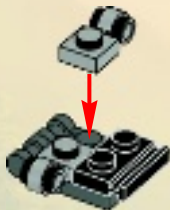

3

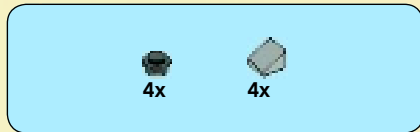
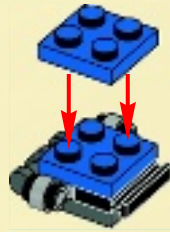

4

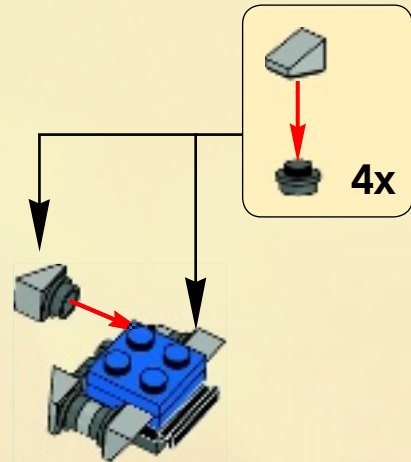

5

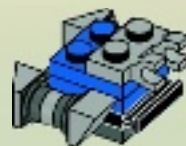

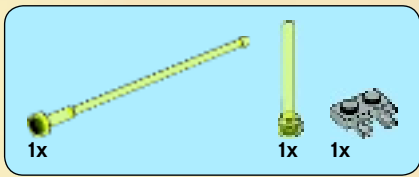

6

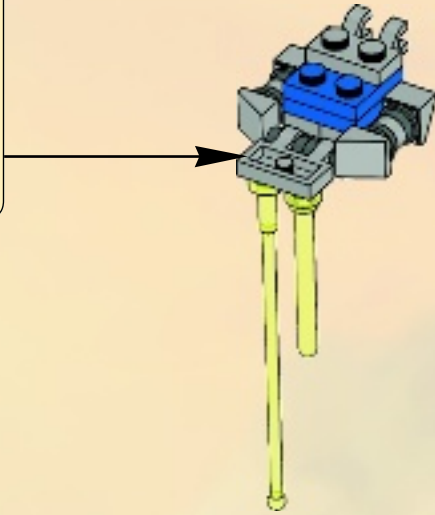
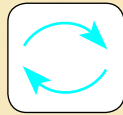
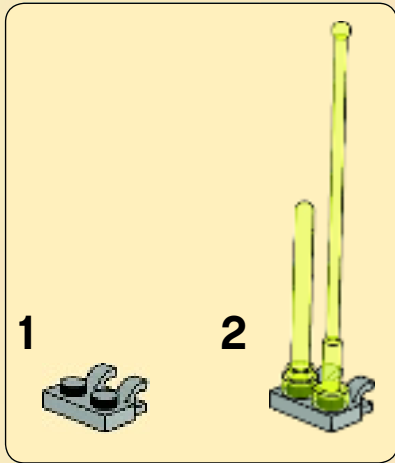

7

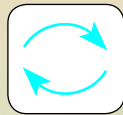

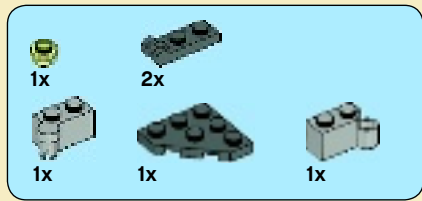

8

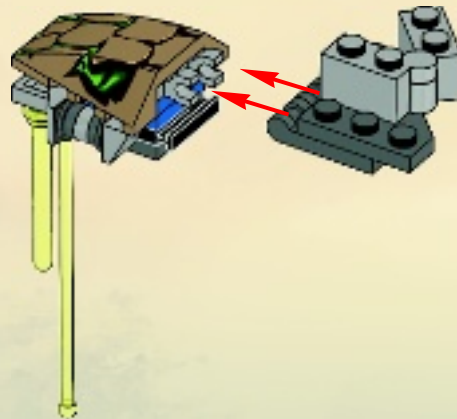
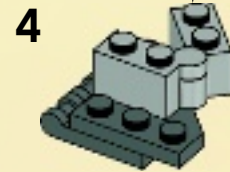
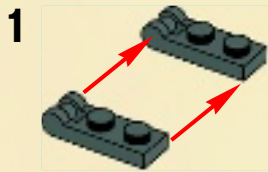
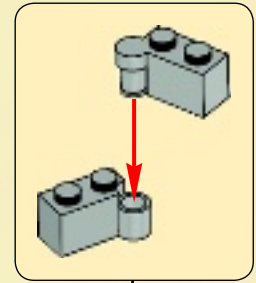

40

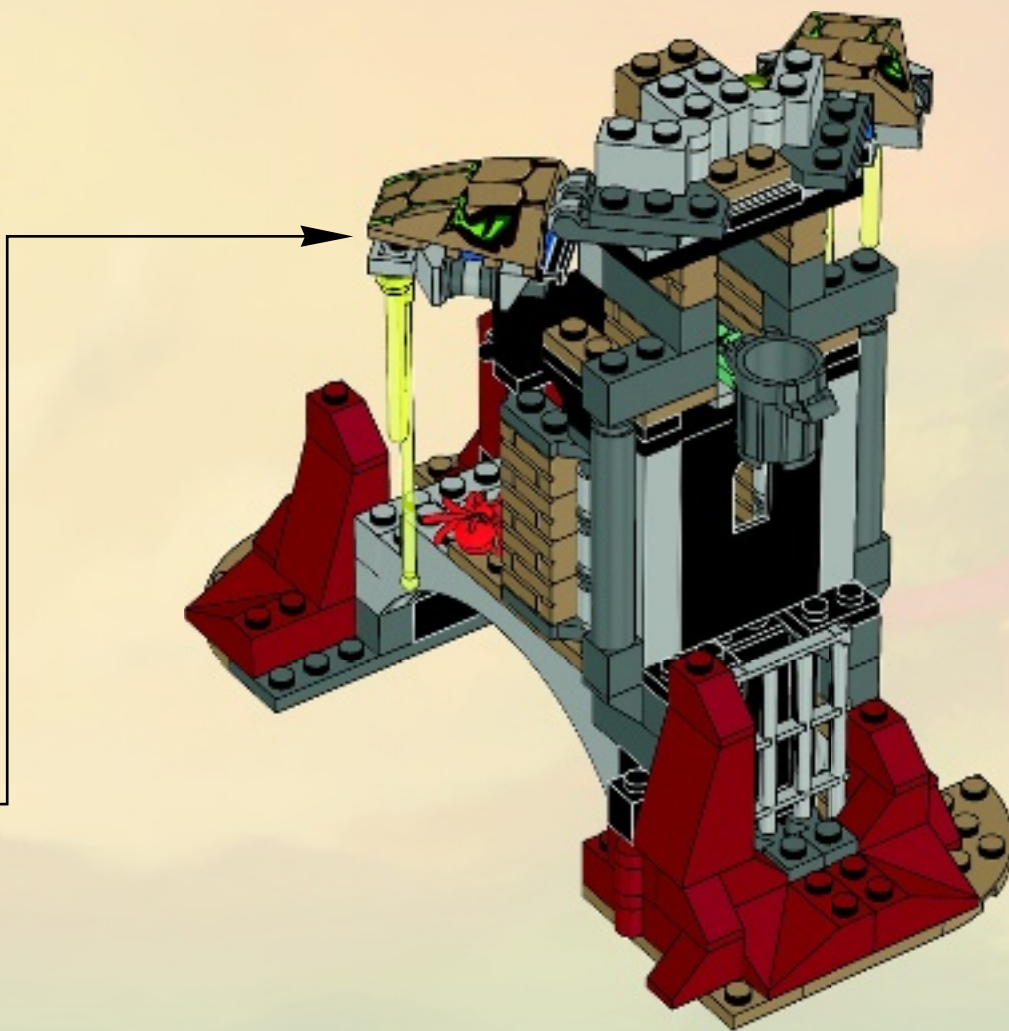

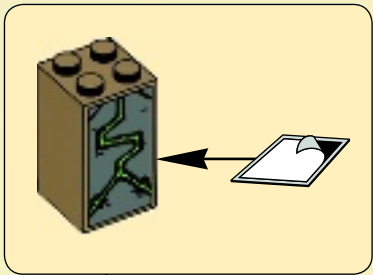

41

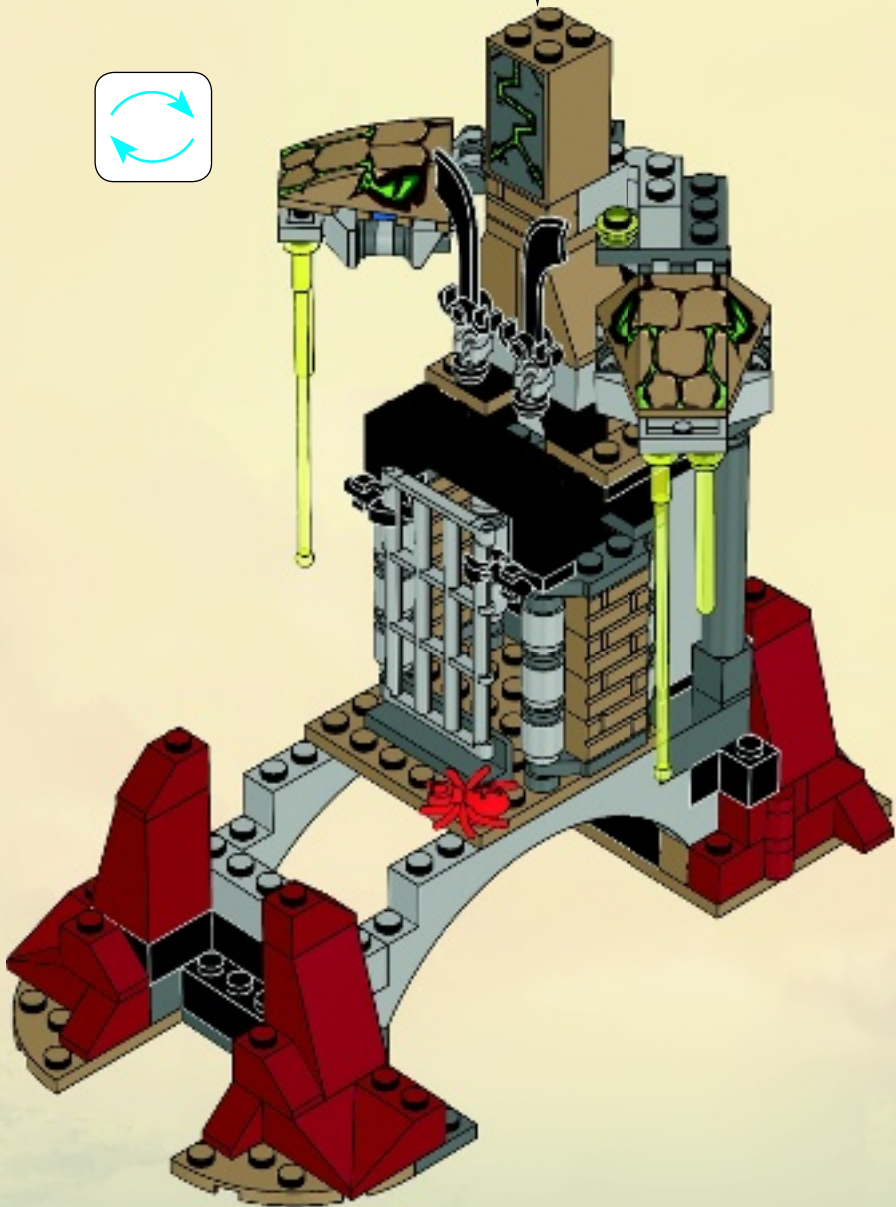
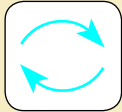

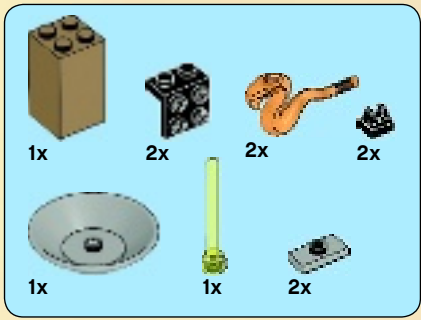

42

1



2

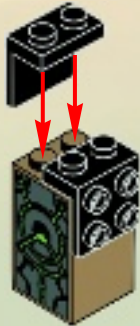

3

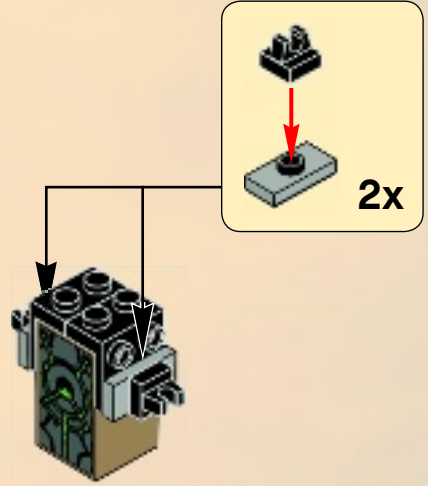

4



5



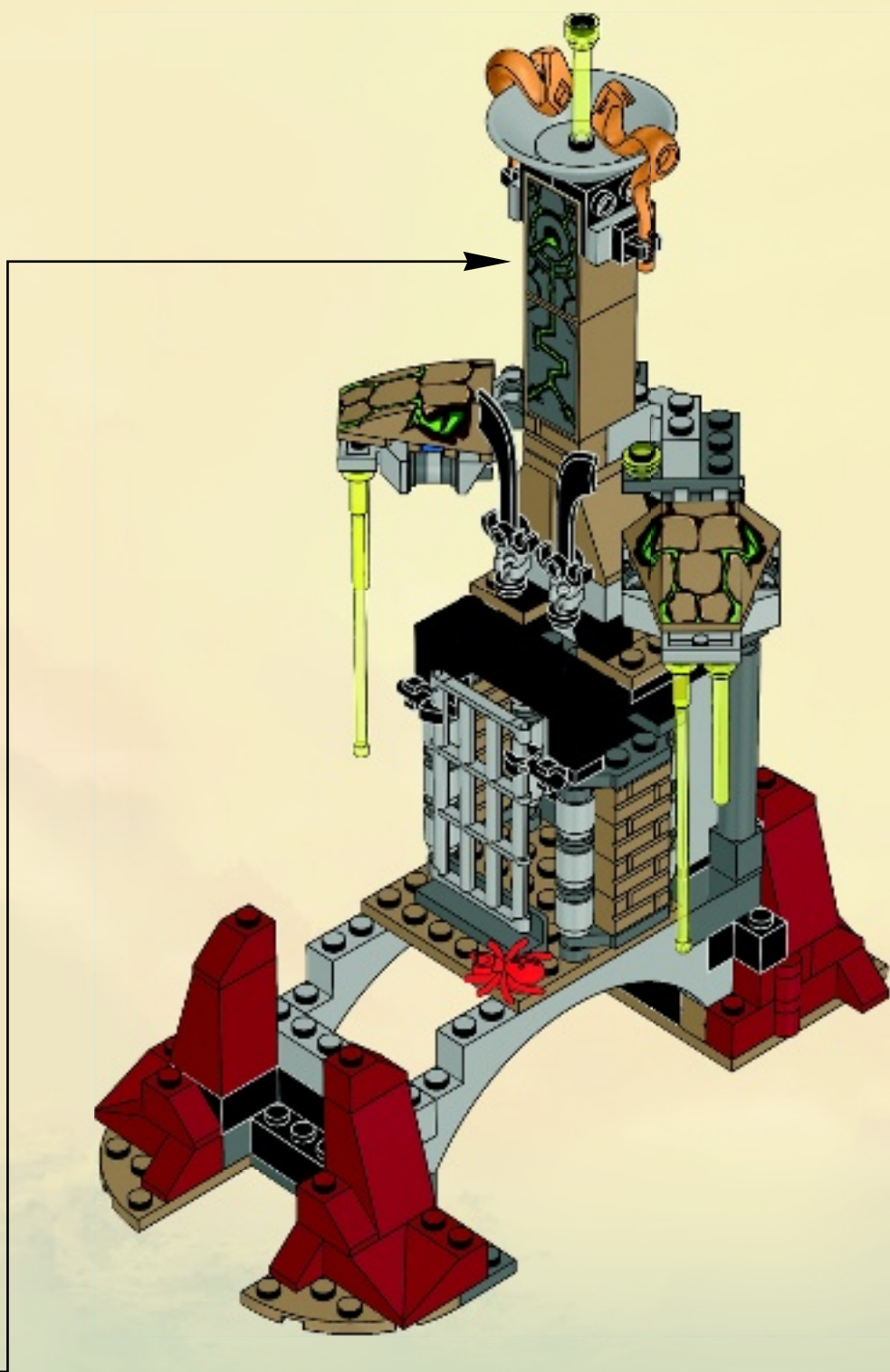

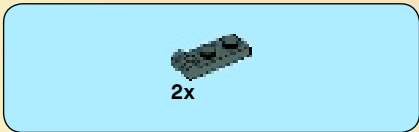

1

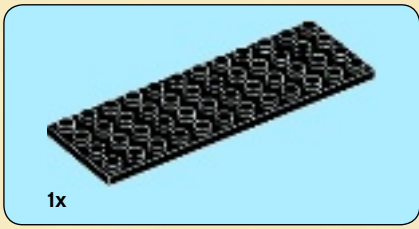
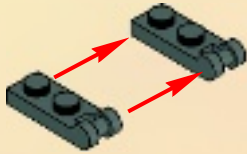

2



3

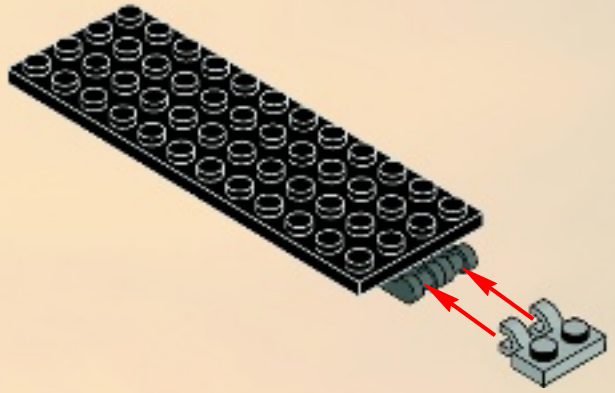

43

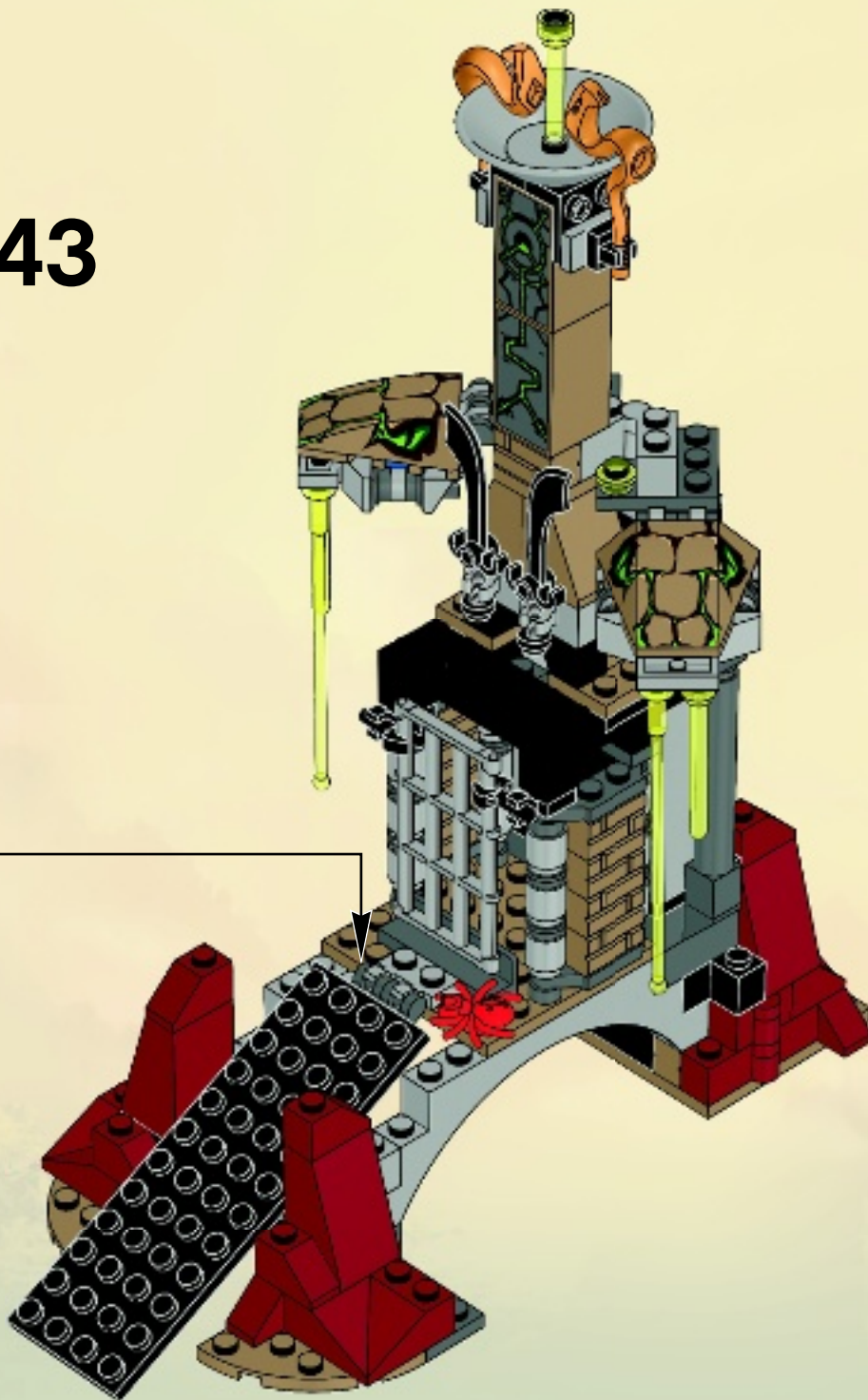

1

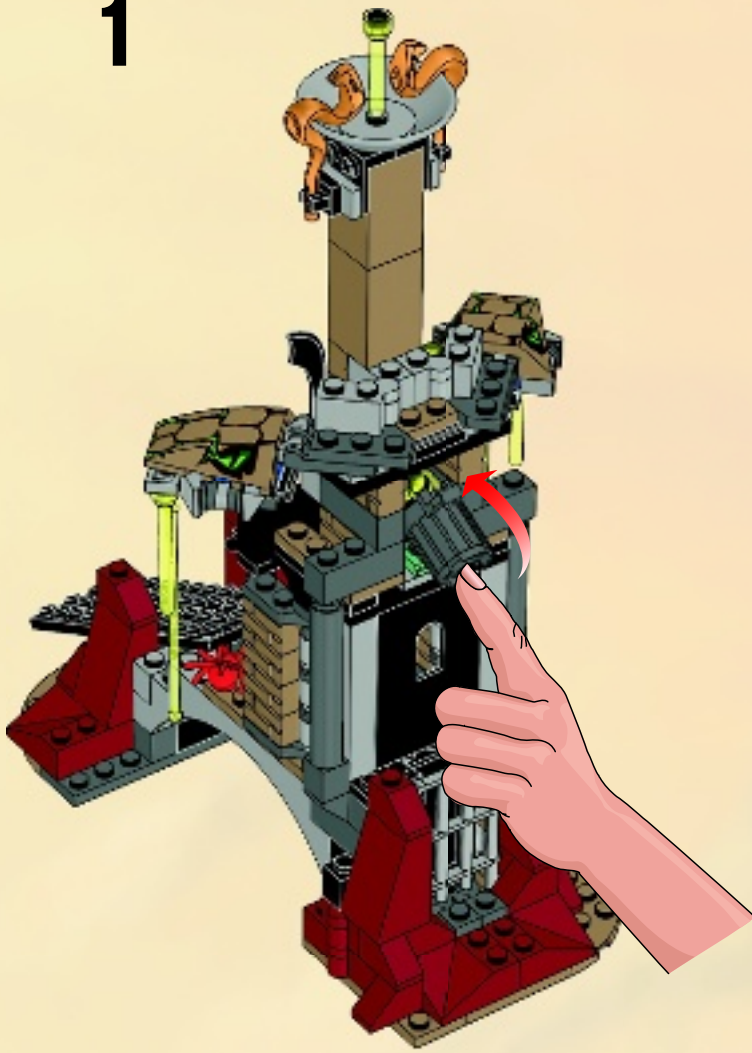

2





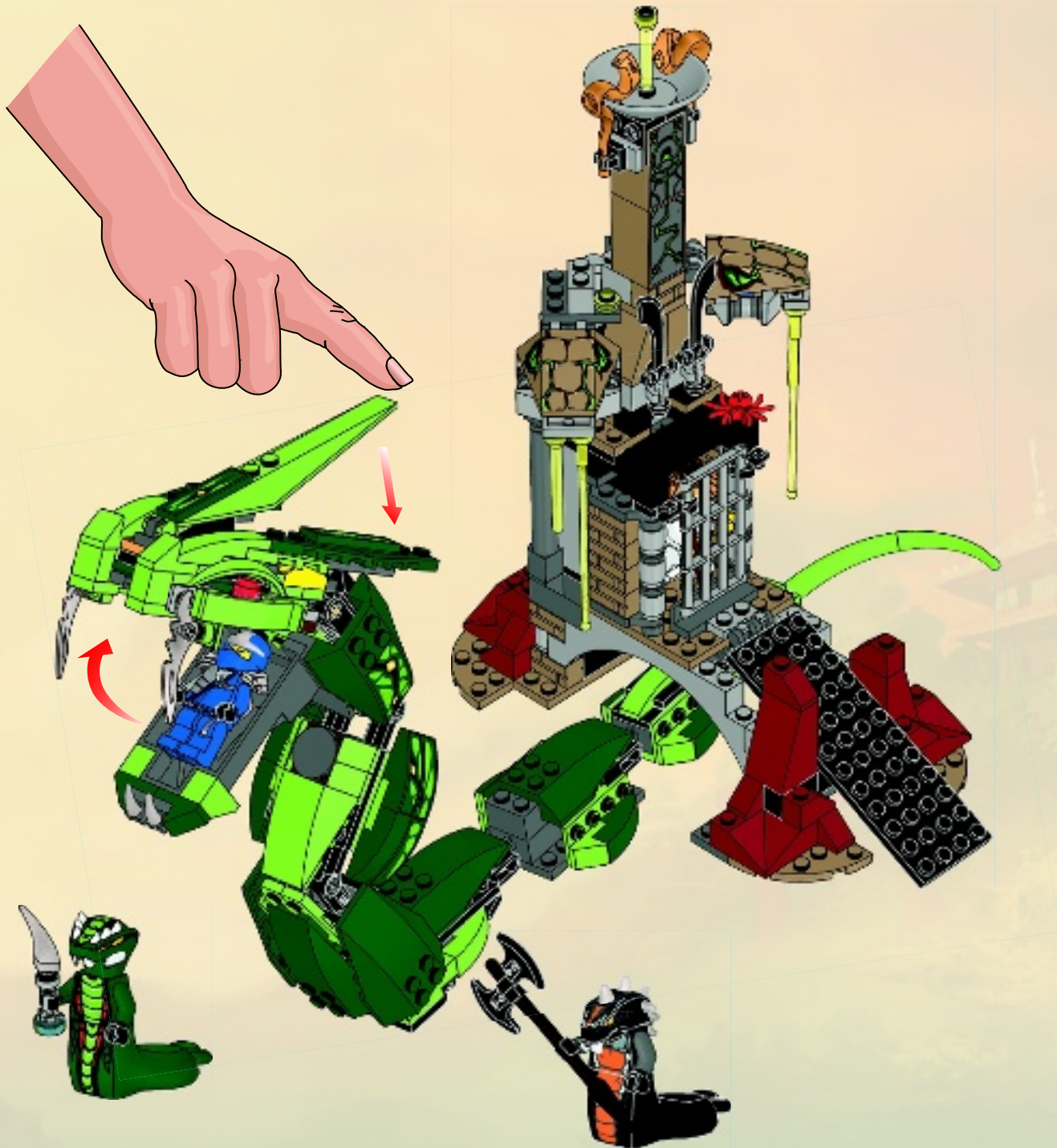



2x
4495412



2x
4143254



2x
306201



2x
4650644



2x
4121932



2x
4622545



2x
379401



2x
302301



1x
244501



4x
4615649



4x
4293876



6x
4282737

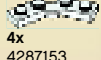

4x
4287153



1x
416201



8x
4650588



6x
4549264

56



1x
4160857



1x
4161326



2x
403201



1x
4249506



2x
241901



1x
4651720



1x
4651703



1x
4600294



1x
4609289



1x
6019887



1x
6006252



1x
6016747



1x
6016746



4x
4662268



1x
4159739



1x
4181134



1x
4114084



2x
4666579



4x
4558886



3x
302321



1x
4593768



4x
4227155



2x
4142865



5x
302223



1x
4650492



1x
4650129



1x
4650118



2x
4143005



22x
4206482



3x
4514553



7x
403224

1x
4611432



1x
4647015



1x
4611427



4x
4218699



6x
235726



1x
301026



2x
300126



7x
4644456



2x
4233487



5x
4619763



4x
370026



2x
389426



2x
4529549



2x
273026



6x
4653087



2x
4548180



1x
4273703



1x
428726



1x
4647286



2x
4160108



2x
4160130



1x
4180469



4x
379426



3x
302226



2x
4565323



4x
362326



2x
302126



2x
4599499



2x
366626

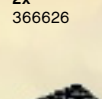

9x
4243819

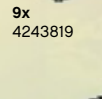

1x
303426

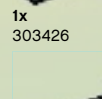

1x
302926

2x
255526

2x
4517925

4x
4144575

2x
4277932

3x
4107761

4x
4183043

2x
306826

2x
244426

5x
4613759

2x
4604304

1x
4636410

1x
4283047

1x
4251393

1x
4251394

1x
4251394

1x
4251394

1x
4251394

1x
4251394

1x
4283046

2x
4227392

2x
4160025

2x
4537058

1x
4650761

1x
4616334

1x
4647628

1x
6016733

1x
4616311

2x
4273400

2x
4656377

14x
4273590

6x
4143875

2x
4285883

2x
4289538

1x
6016743

1x
6016743

2x
4121667

4x
4610948

2x
4598410

4x
4584550

20x
4121715

10x
4107084

2x
4107081

1x
370526

1x
370626

2x
4629921

4x
4187334

4x
4233489

1x
4650497

1x
4650132

1x
4650121

1x
4650121

1x
4650121

1x
4650121

1x
4650121

2x
4544720

1x
4653400

6x
4244573

2x
3005748

9x
6000782

4x
3005749

3x
4114011

2x
256949

2x
4220634

2x
4504372

2x
4537925

12x
4648274

4x
4537928

2x
4537927

5x
4617069

1x
4653662

1x
4653662

1x
4653662

1x
4653662

2x
4633822

8x
4537937

11x
4537936

2x
4632576

12x
4617067

1x
4656148

3x
4539907

3x
4539908

1x
4650635

1x
4650634

2x
4610474

2x
4663285

16x
4646577

2x
4616593

2x
4616593

2x
4616593

2x
4616593

2x
4616593

2x
4616593



2x
465351



5x
4267874



1x
4246957



1x
4530712



3x
4570451



1x
6016729



2x
4648467



14x
4267850



7x
4652932



5x
4543949



2x
4648340



2x
4648342



1x
4647764



1x
6016717



1x
4625236



15x
4541526



3x
6007898



4x
4651936



2x
6011462



2x
4568761



2x
4211225



2x
4600541



1x
4211202



2x
4626666



9x
4211189



6x
4211186



3x
4211214



2x
4211219



1x
4538724



6x
6006740



2x
4211311



4x
4507833



2x
4211363

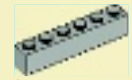

1x
4211393



2x
4641682



15x
4211412



1x
4211440



8x
4521921



2x
4224592



5x
4211398



4x
4211451



3x
4211395



2x
4211452



4x
4632575



2x
4611702



6x
4654582



5x
4556157



1x
4211568



2x
4211413



2x
4262978



2x
4211525



1x
4580598



2x
4599496



1x
4539481



2x
4211461



2x
6011459



2x
4211713

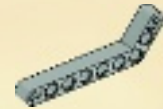

2x
4211624

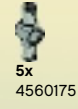

5x
4560175



4x
4211375



8x
4211815

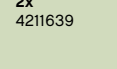

2x
4211639



8x
4211104



3x
4211085

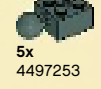

5x
4497253



1x
4513326



2x
4622338



14x
4213607



6x
4211096



2x
4211064



1x
4225873



1x
6008667

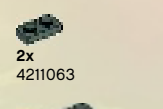

2x
4180486



2x
4211063



3x
4211001

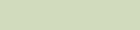

1x
4211056

4x
4539429



1x
4211115



1x
4211061



2x
4180811



1x
4161674



1x
4211067



2x
4211069



2x
4587212



4x
4210763



1x
4620079



4x
6000606



10x
4521187



1x
4210882



4x
4217558



3x
4271344



22x
4210633



4x
4278274



4x
4223981



2x
4210897



1x
4210844



1x
4626645



1x
6001668



4x
6006408



4x
4264952



4x
4498096



4x
4265486



2x
4210656



2x
4598409



2x
4508553



3x
4523157



1x
4600267



5x
4649896



1x
4626501



3x
4640843



1x
4600528



1x
4600519



1x
4614404



6x
4618195



1x
4611904



2x
4654026



1x
4600501



2x
4648296



3x
4623775



10x
4518687



4x
4566688



4x
4657347



1x
4549898



1x
4583979



2x
4651535



1x
4646815



2x
4612901



1x
4617190



4x
4609595



1x
4646806



1x
4646870



1x
4646817



1x
4650750



1x
4652114



1x
4647632



10x
4529685

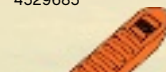

1x
4654448

Customer Service
Kundenservice
Service Consommateurs
Servicio Al Consumidor

www.lego.com/service or dial



: 00800 5346 5555

: 1-800-422-5346



WIN!

Go to www.LEGOsurvey.com/product to fill out a survey for a chance to win a cool LEGO® Product.

No purchase necessary.

Open to all residents where not prohibited.



www.LEGO.com



www.LEGOsurvey.com/product

GEWINNE!

Nimm an der Umfrage auf www.LEGOsurvey.com/product teil und hab die Chance ein cooles LEGO® Produkt zu gewinnen!

Die Teilnahme am Gewinnspiel führt zu keinerlei Kaufverpflichtungen. Teilnahme in allen nicht ausgeschlossenen Ländern möglich.

WIN!

Ga naar www.LEGOsurvey.com/product, vul een enquêteformulier in en maak kans op een cool LEGO® product.

Geen aankoopverplichting. Iedereen mag deelnemen, uitgezonderd ingezetenden van landen waar een enquêteverbod geldt.

GAGNE!

Visite www.LEGOsurvey.com/product pour répondre à un questionnaire et avoir une chance de gagner un produit LEGO® très cool!

Aucune obligation d'achat. Ouvert à tous les résidents des pays autorisés.

当てよう!

www.LEGOsurvey.com/product にアクセスして、アンケートにご記入ください。当選者にはレゴ製品を差し上げます。

お買い上げの必要はありません。禁止されていない限り、すべての皆様にご利用いただけます。