



NINJAGO

Masters of Spinjitzu



9442



CONVERTS

**JAY ZX
INCLUDED**



1

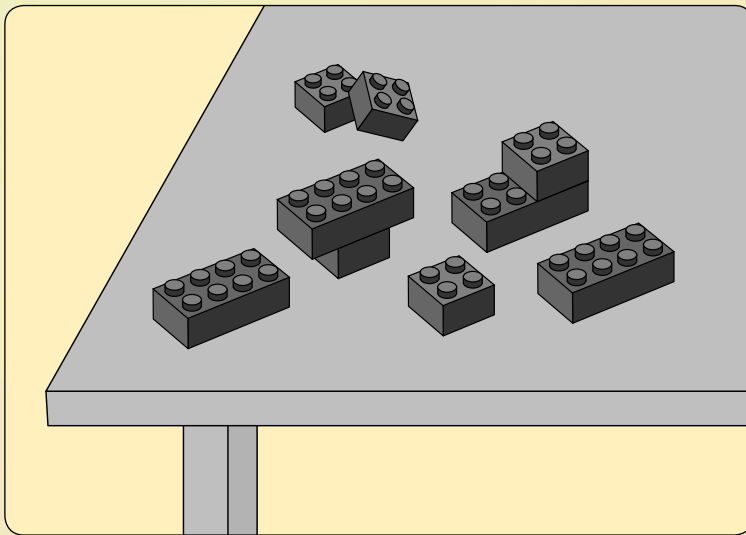
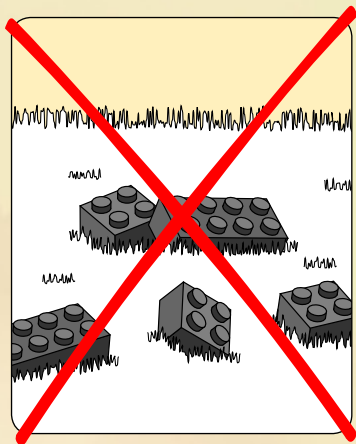

2

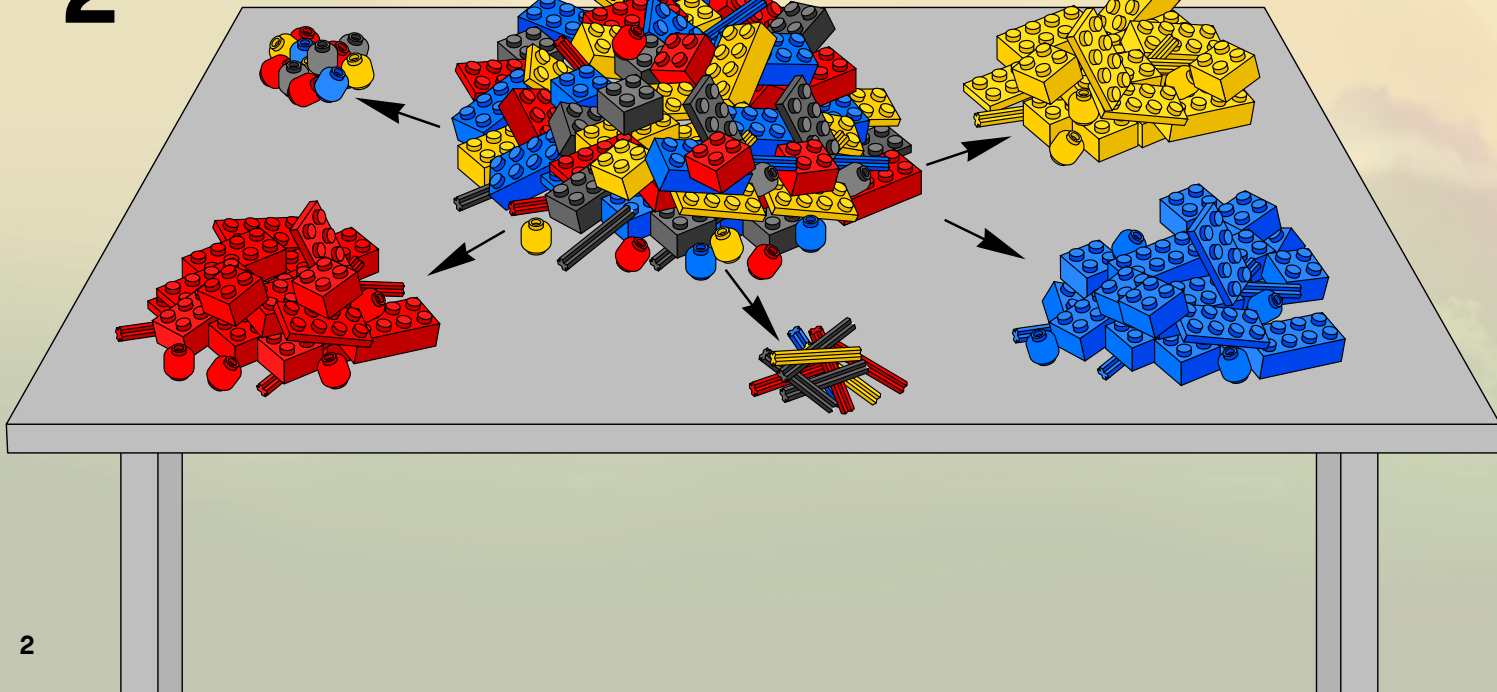



CONVERTS
SE TRANSFORME
SE CONVIERTE

JAY ZX INCLUDED
JAY ZX INCLUS
INCLUYE A JAY ZX

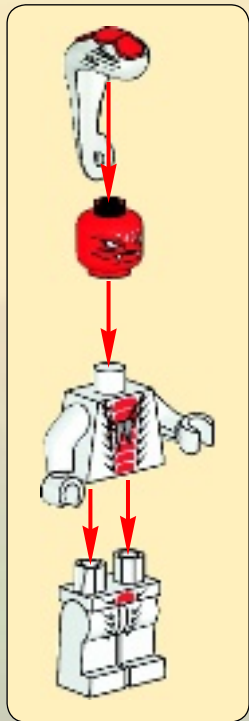



1x

1

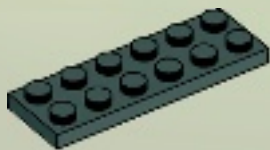

4



2x

2



2x



2x

3

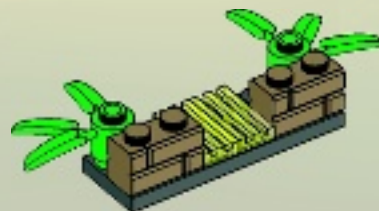



2x

4



1x

5

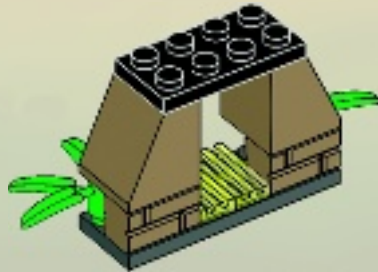

1x



2x

6

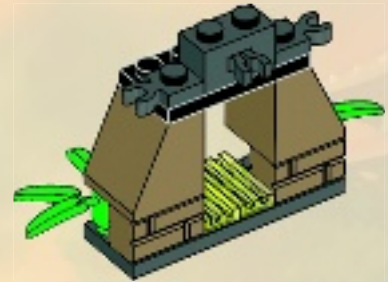

2x

7

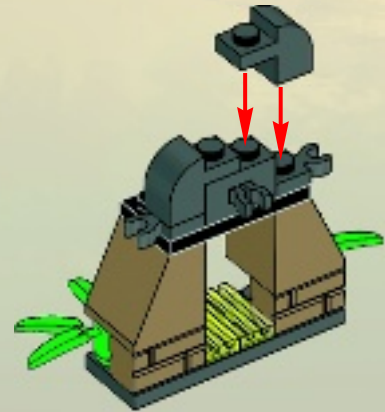



2x

8

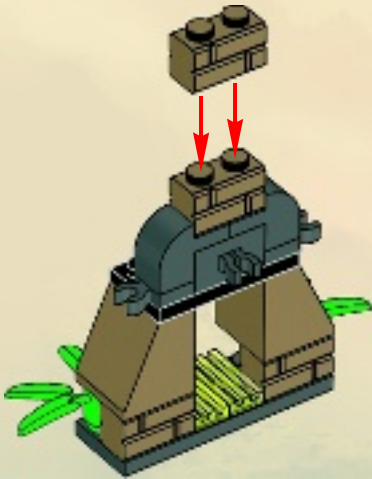

2x

9

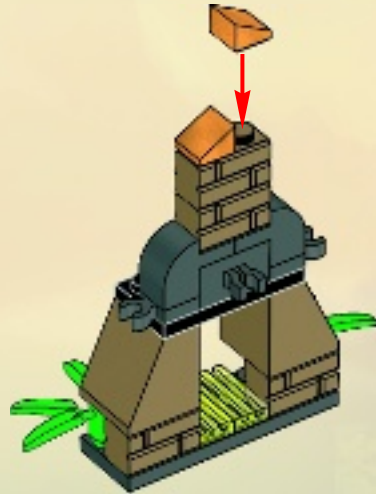

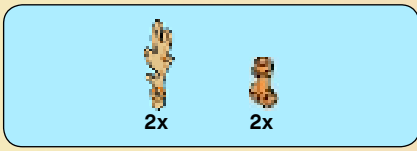

10

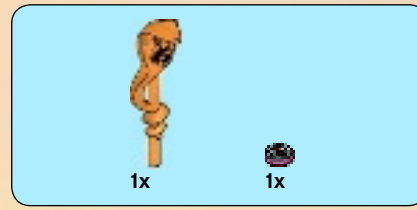
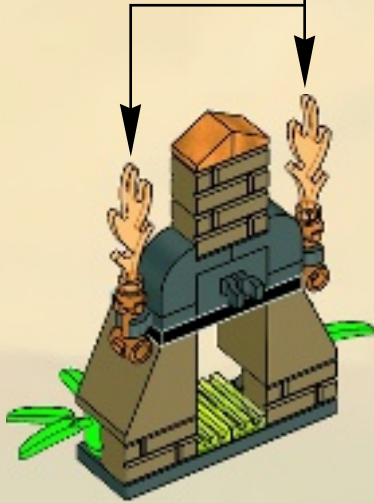
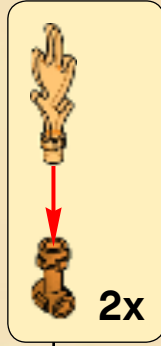

11

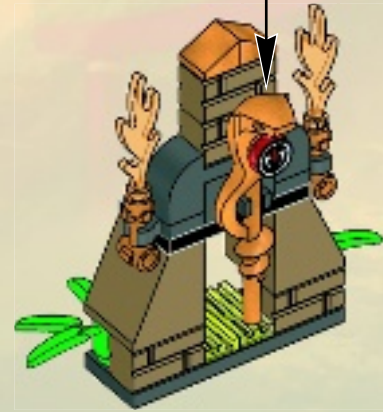
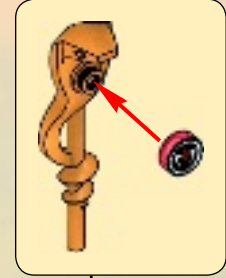



1



2

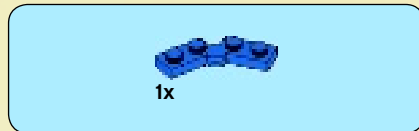
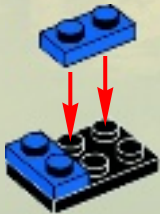

3



4





5

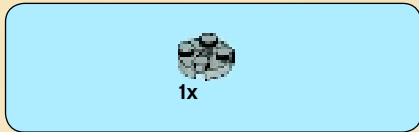

6

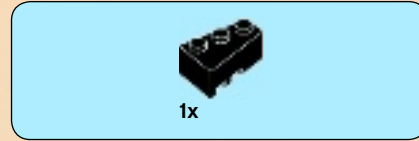
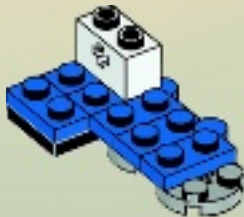

7

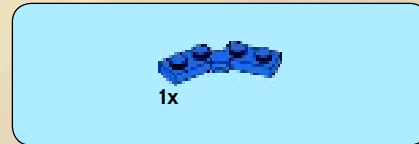
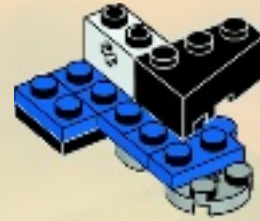

8



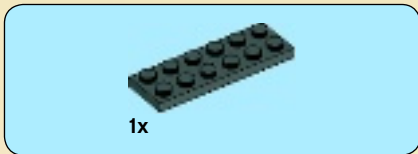

9

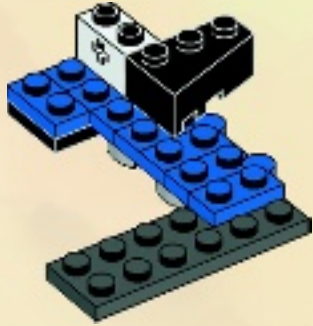

10

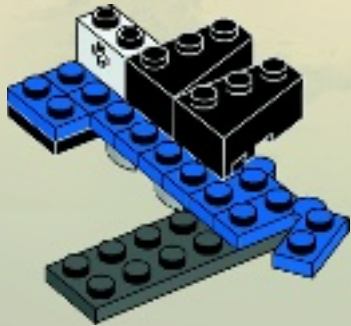

11

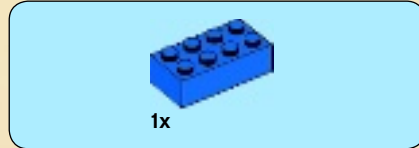
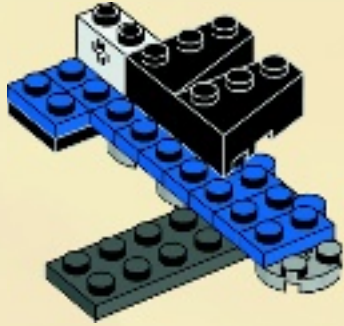

12

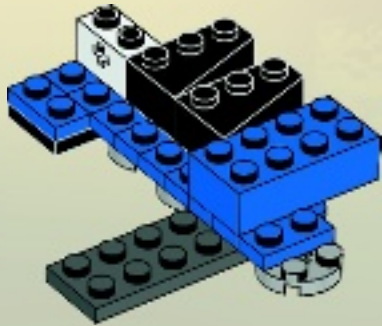



1x

13

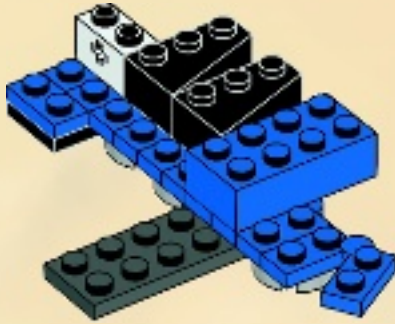

1x

14

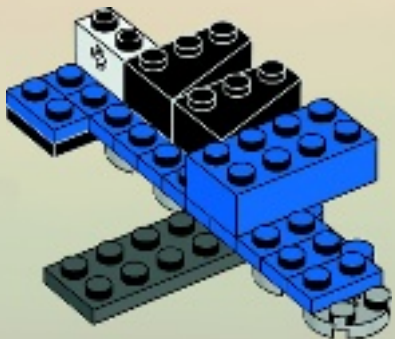

1x

15

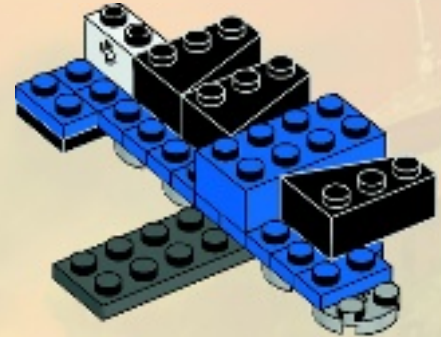

1x

16

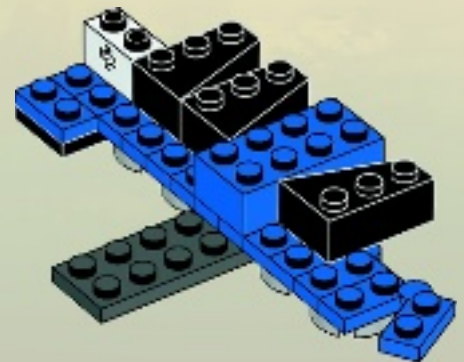



1x

17

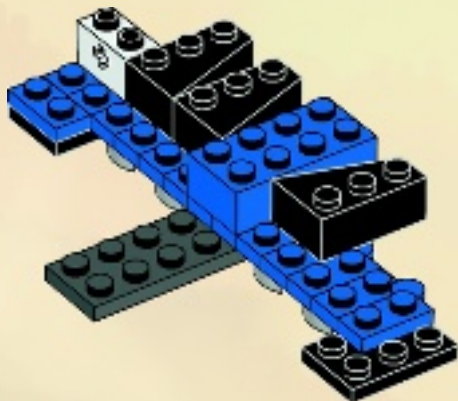

1x

18

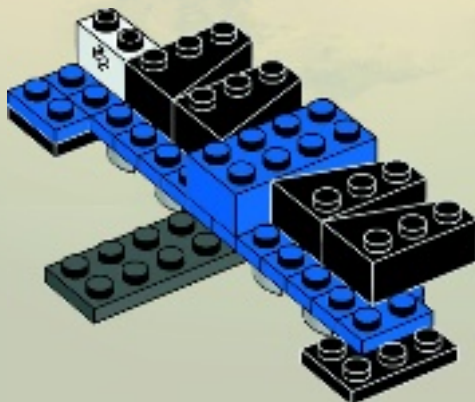

2x

19

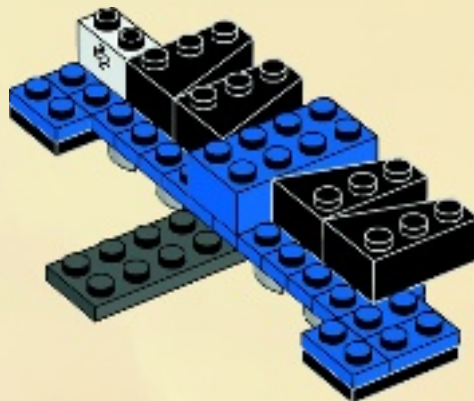

1x

20

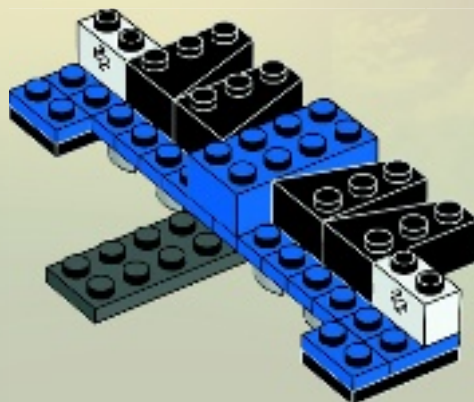



6x

21

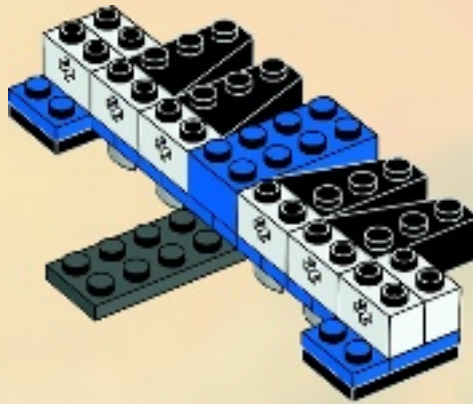

2x

22

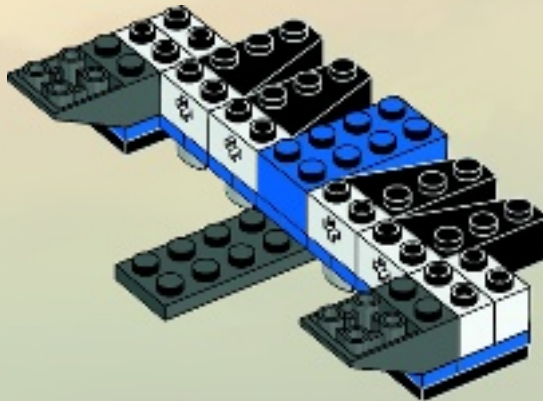

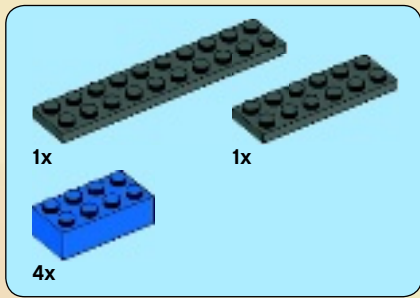

1

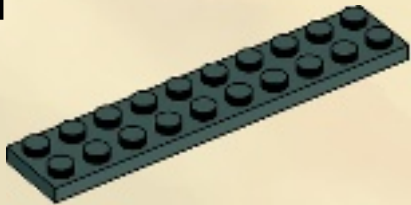

2

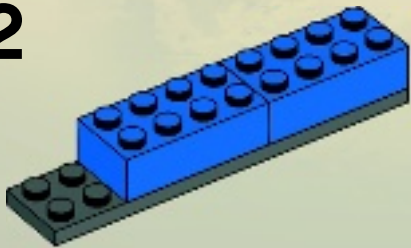

3

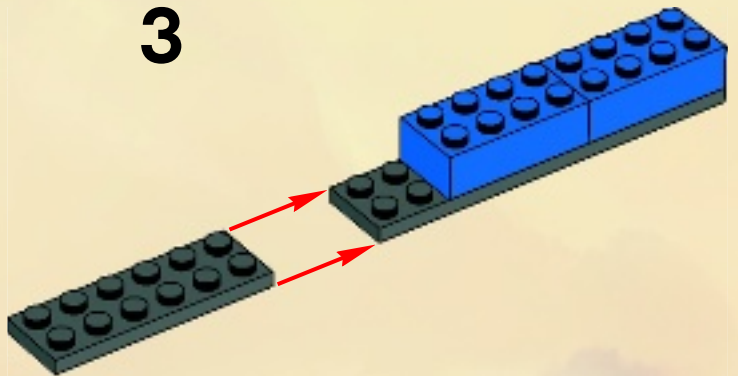

4

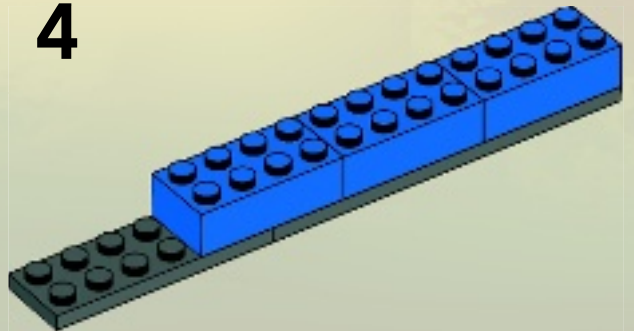

5

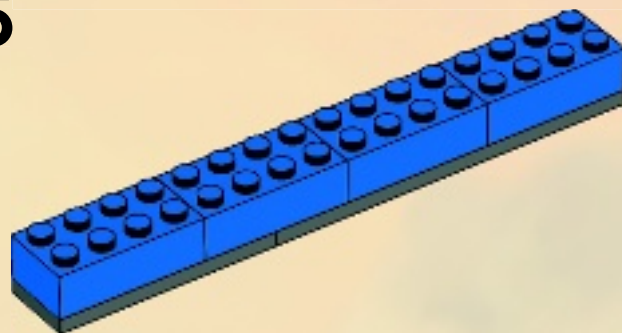

23

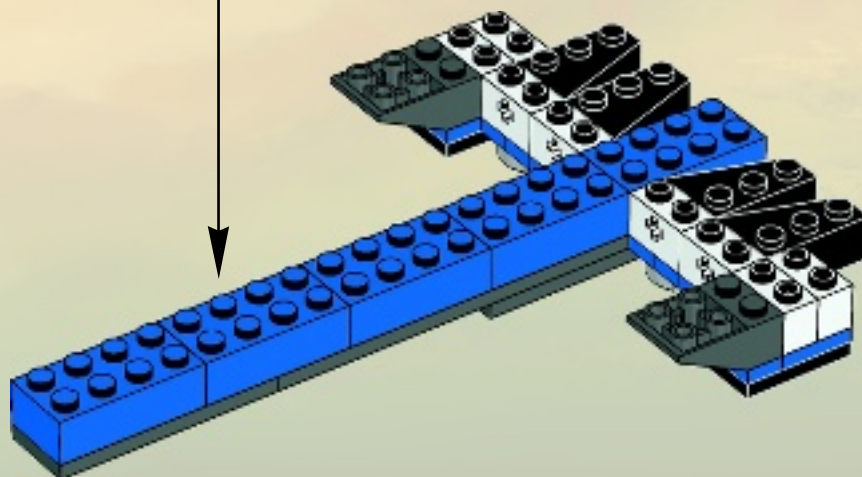

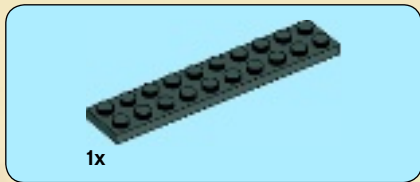

24

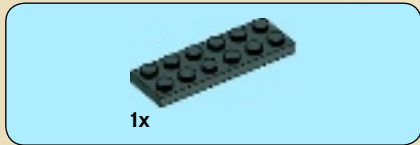
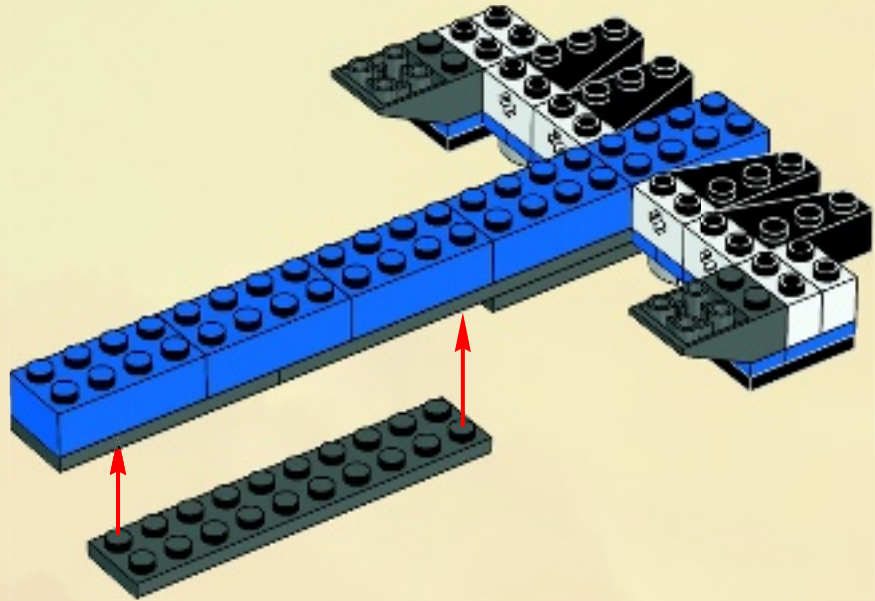

25

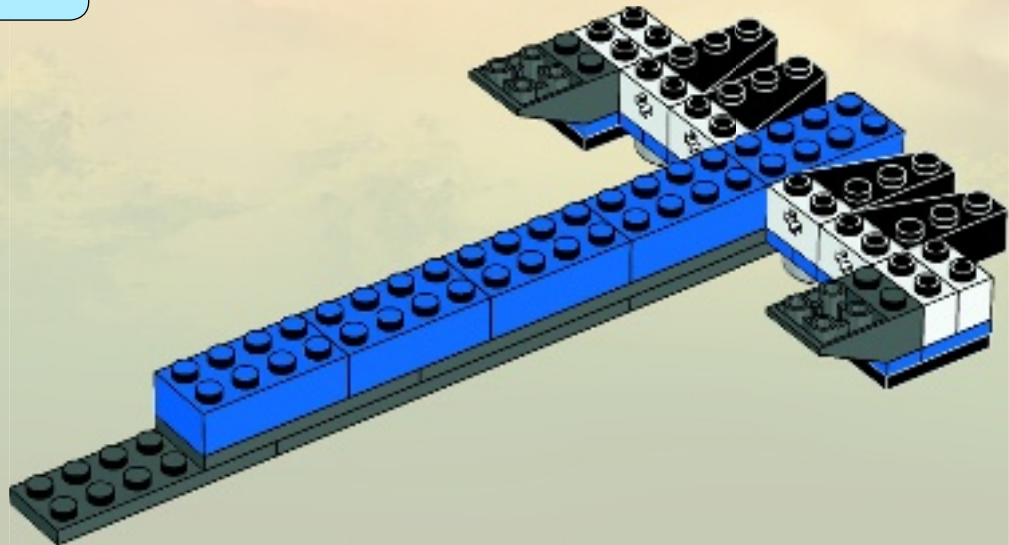



26

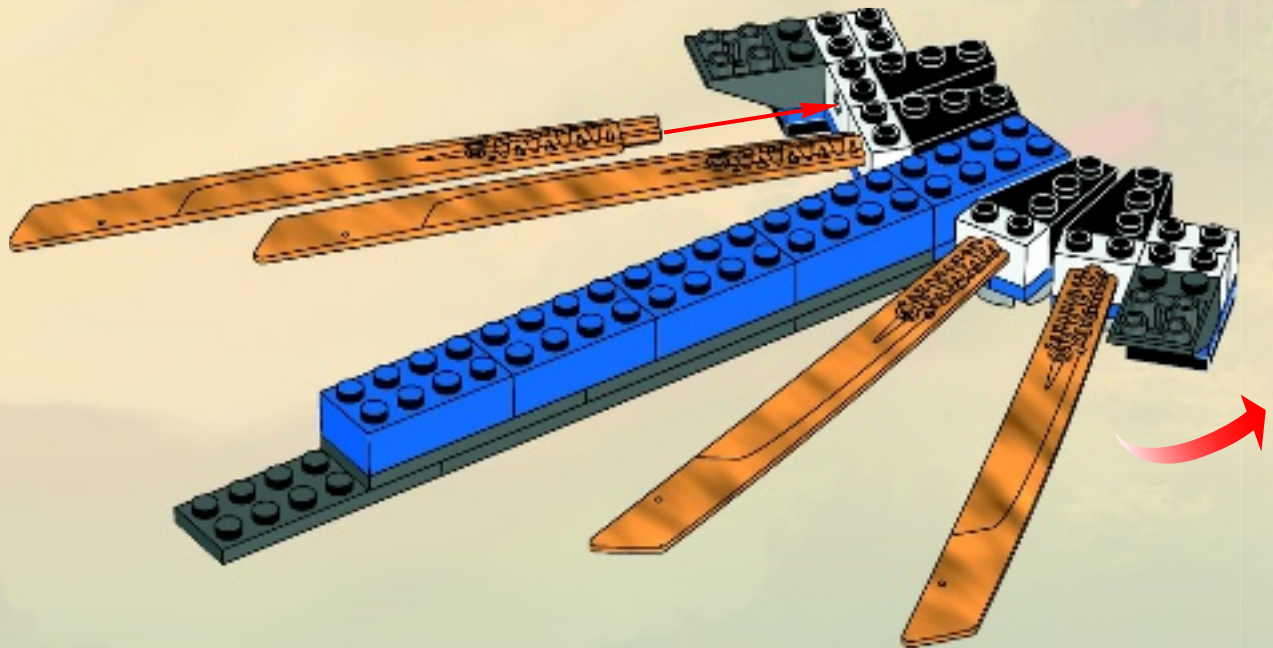



2x



1x

27

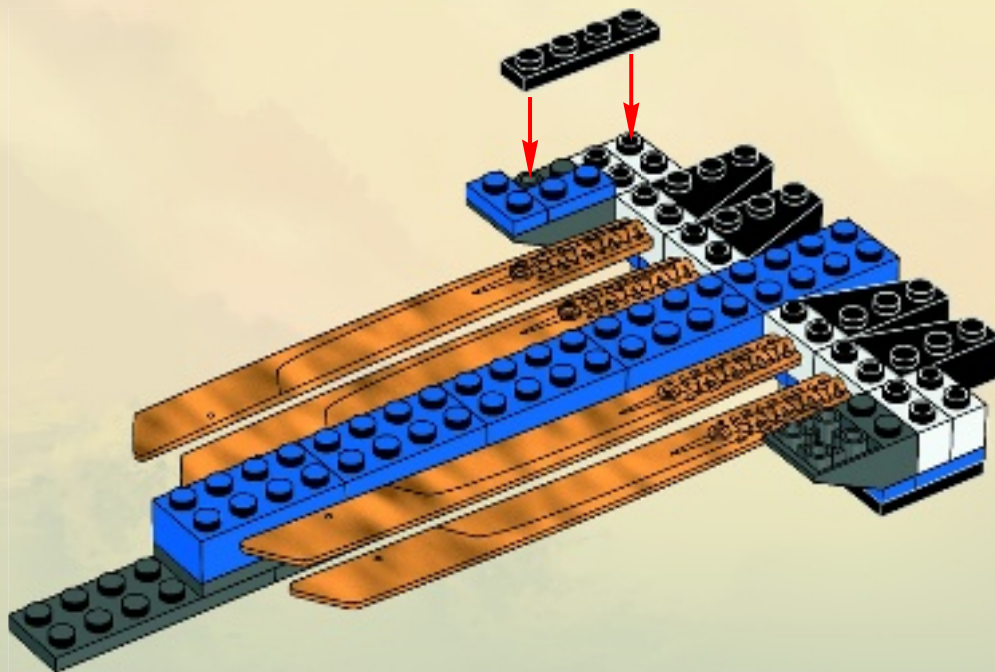

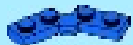

1x

28

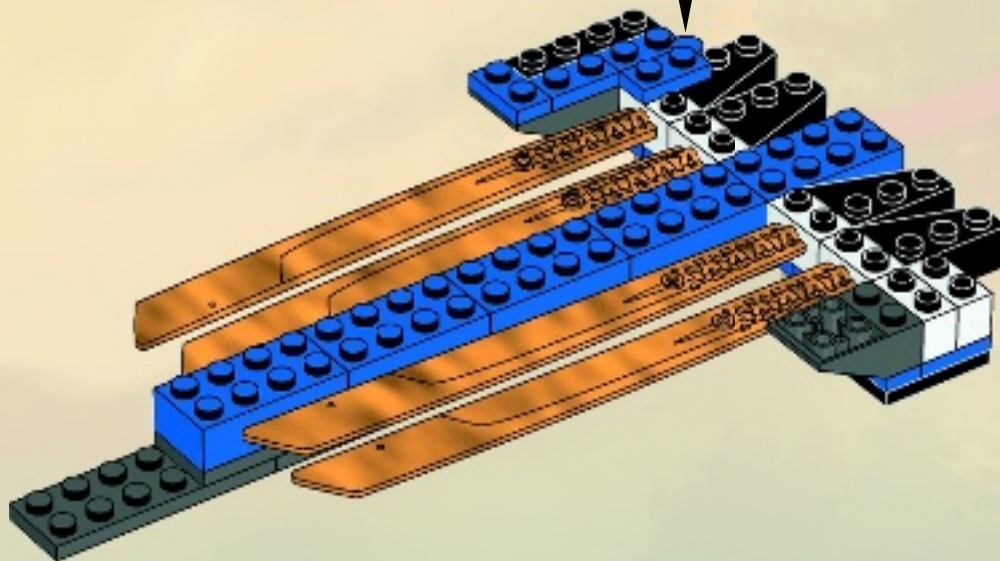

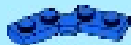

5x

29

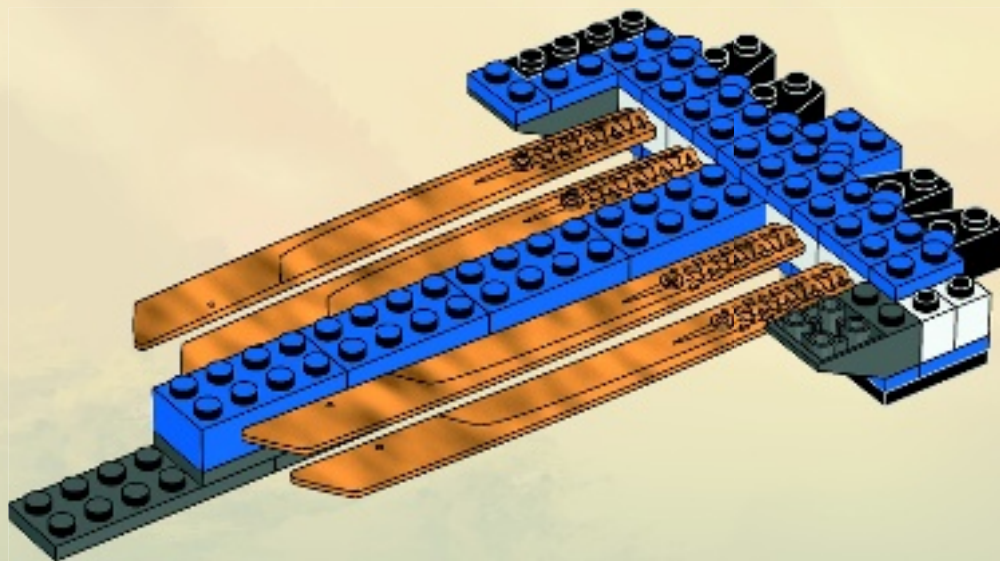



30

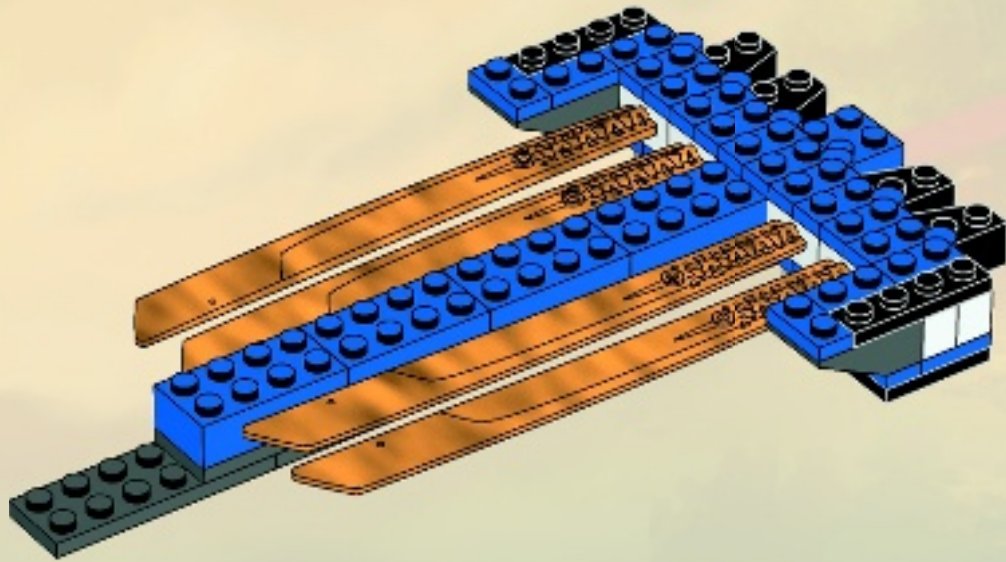

2x

2x

31

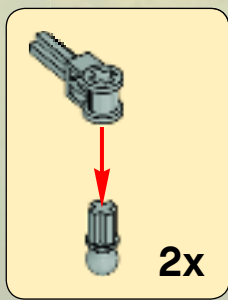
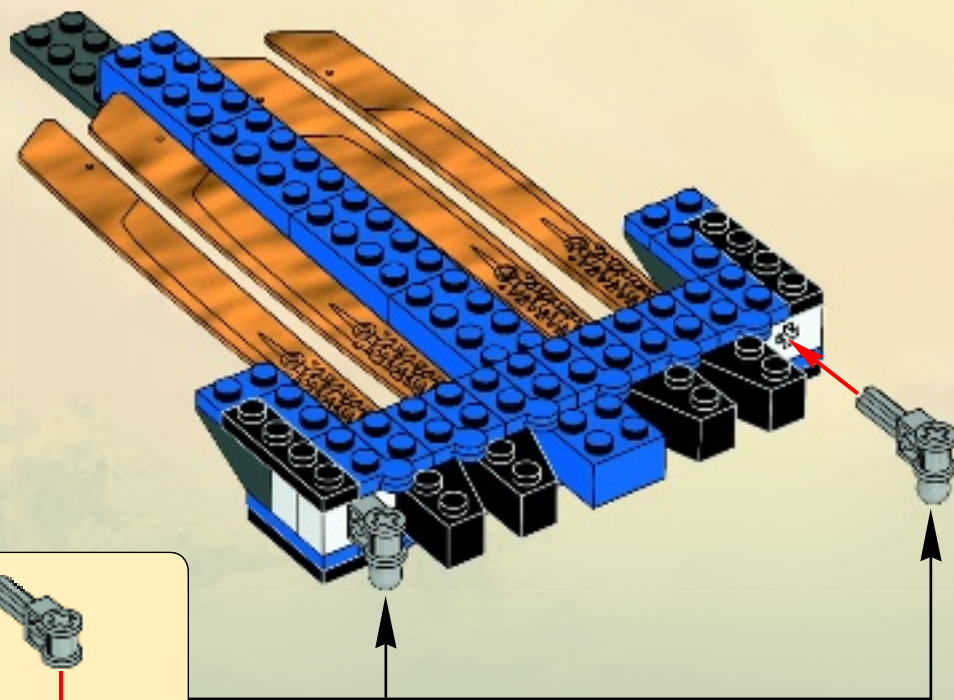

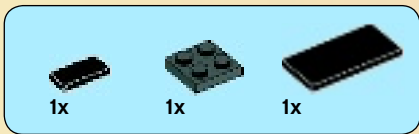

32

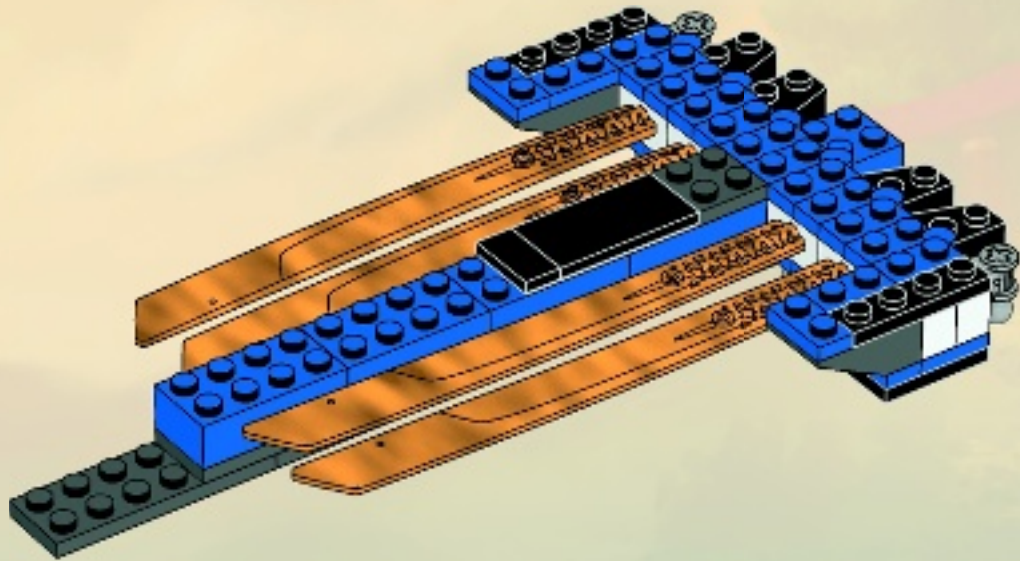



1x



4x

33

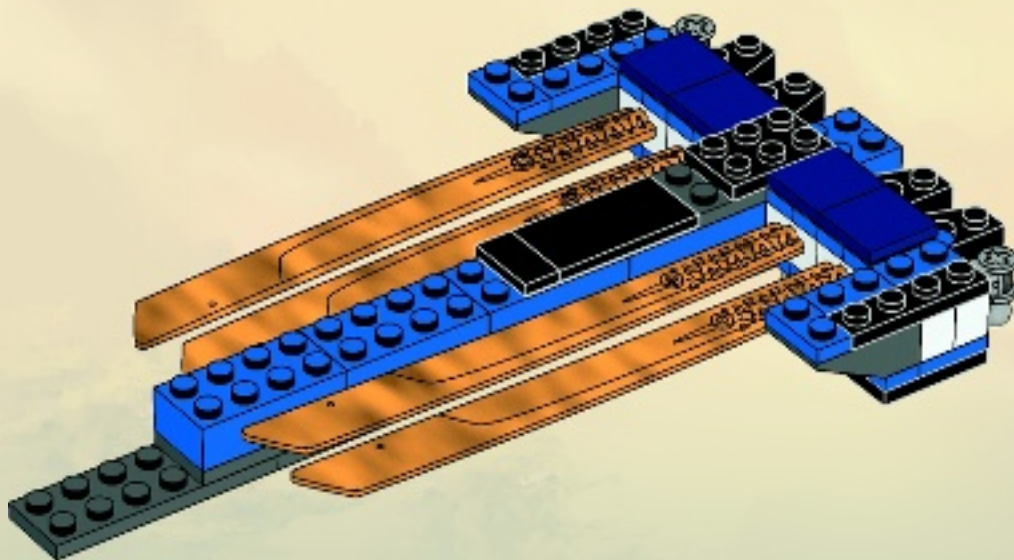

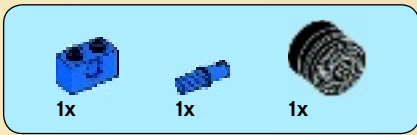

34

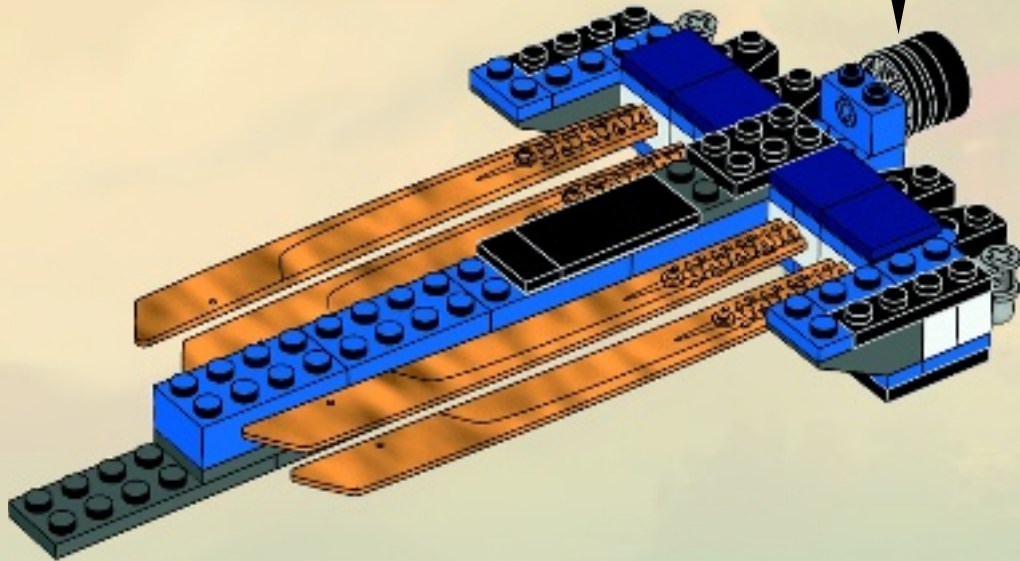
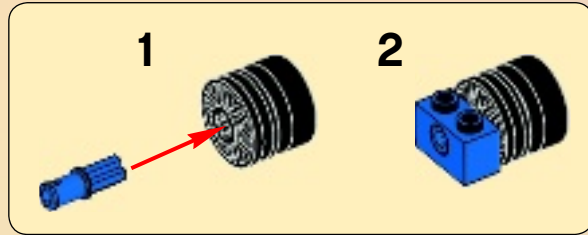



2x



2x

35

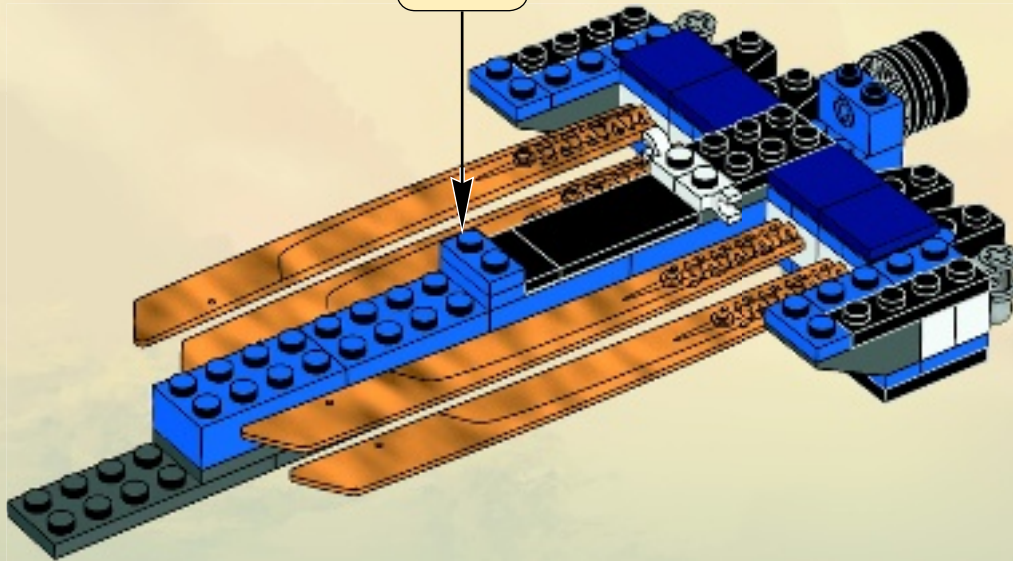
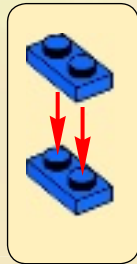



2x



1x

36

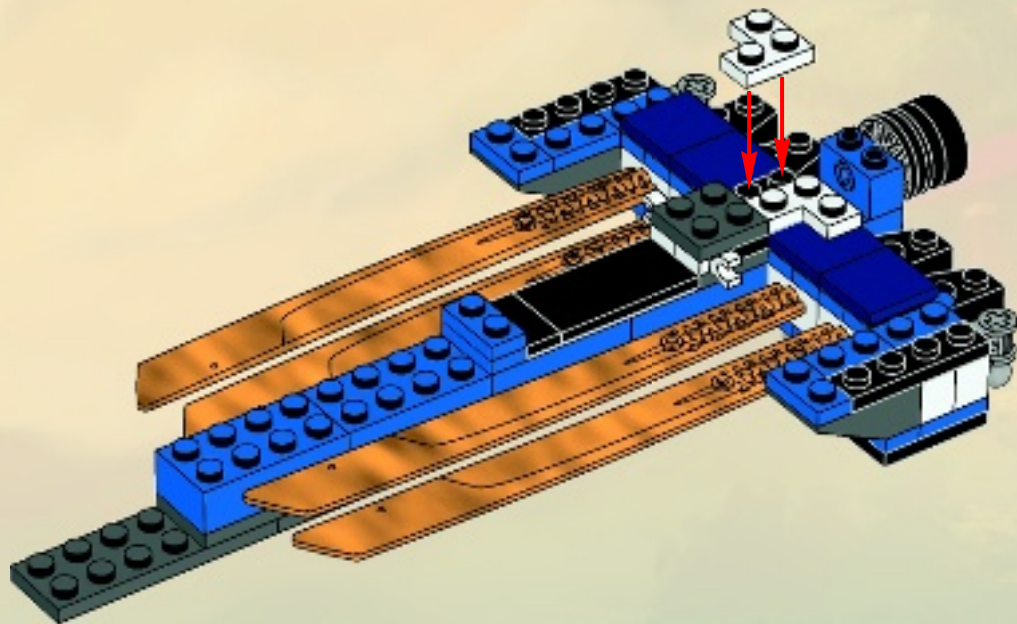



2x

37

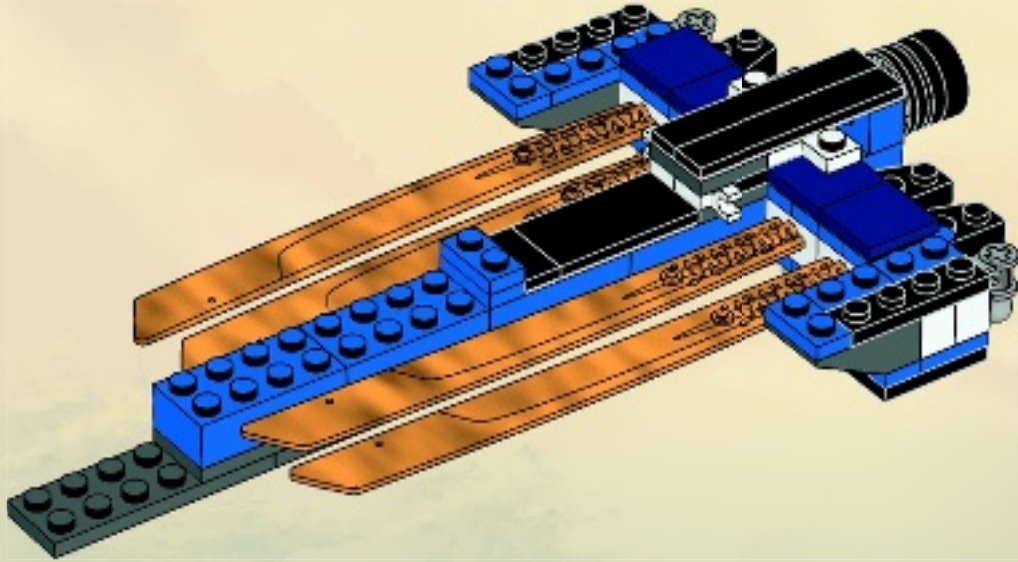



1



2

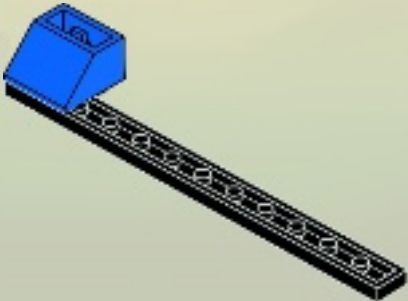

3

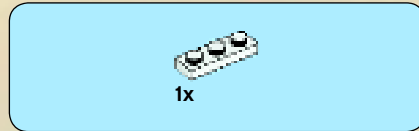
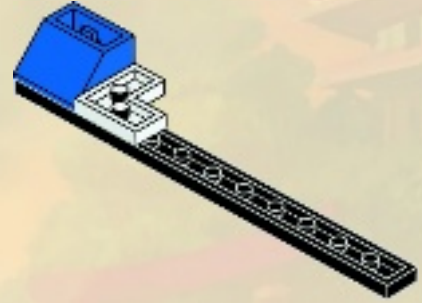

4

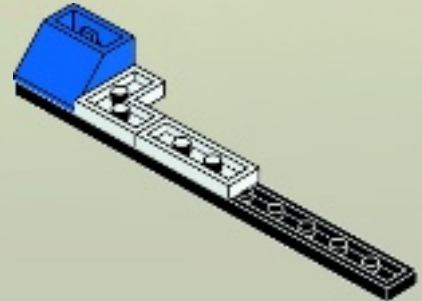

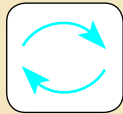

38

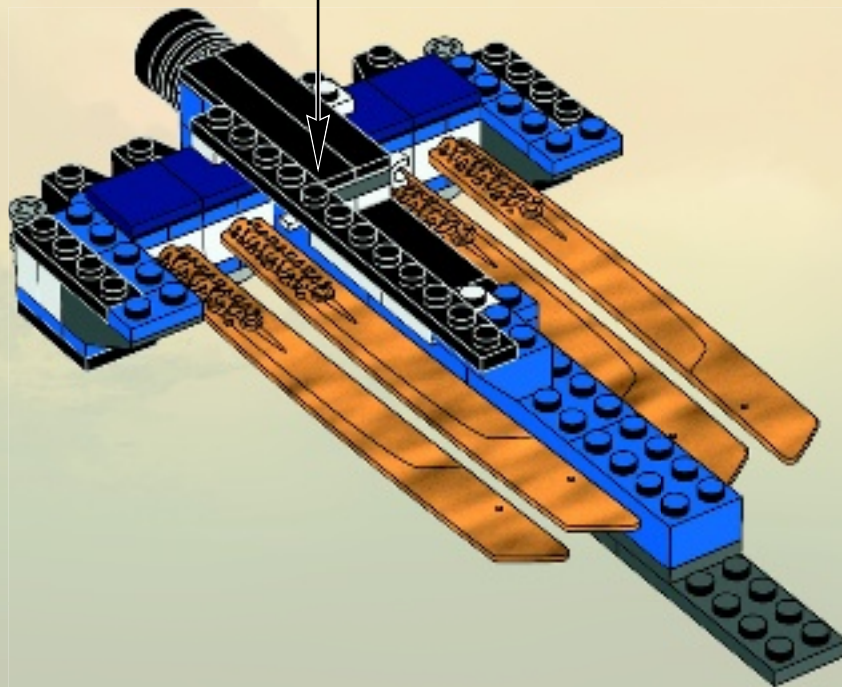

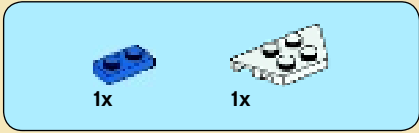

1

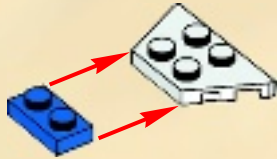

2



3

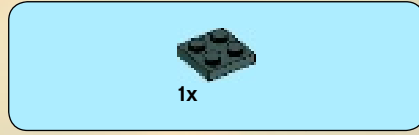
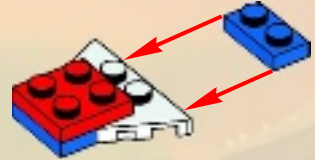

4



5



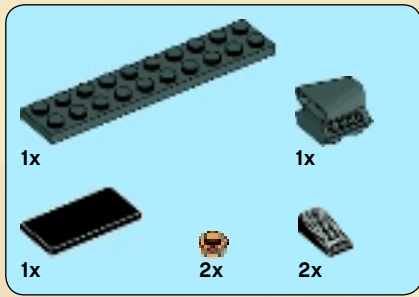

6

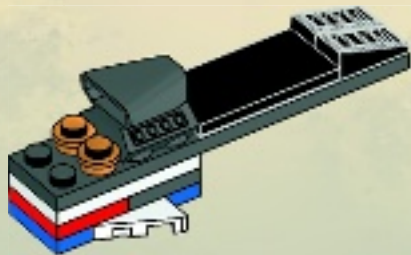
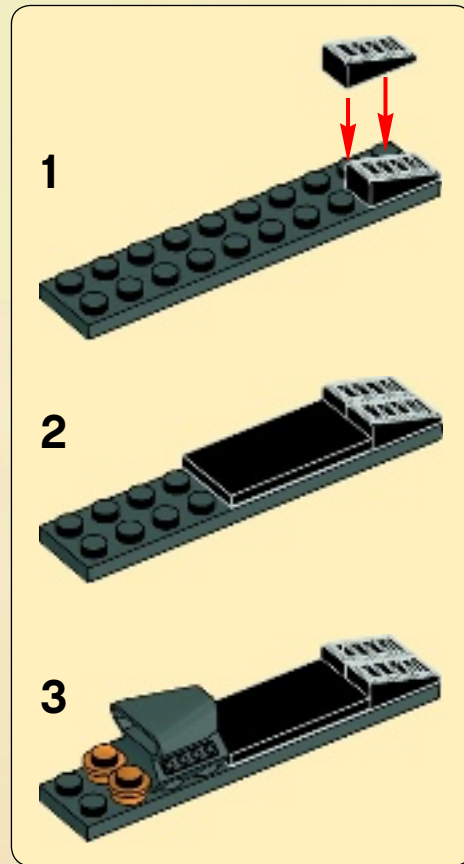

39

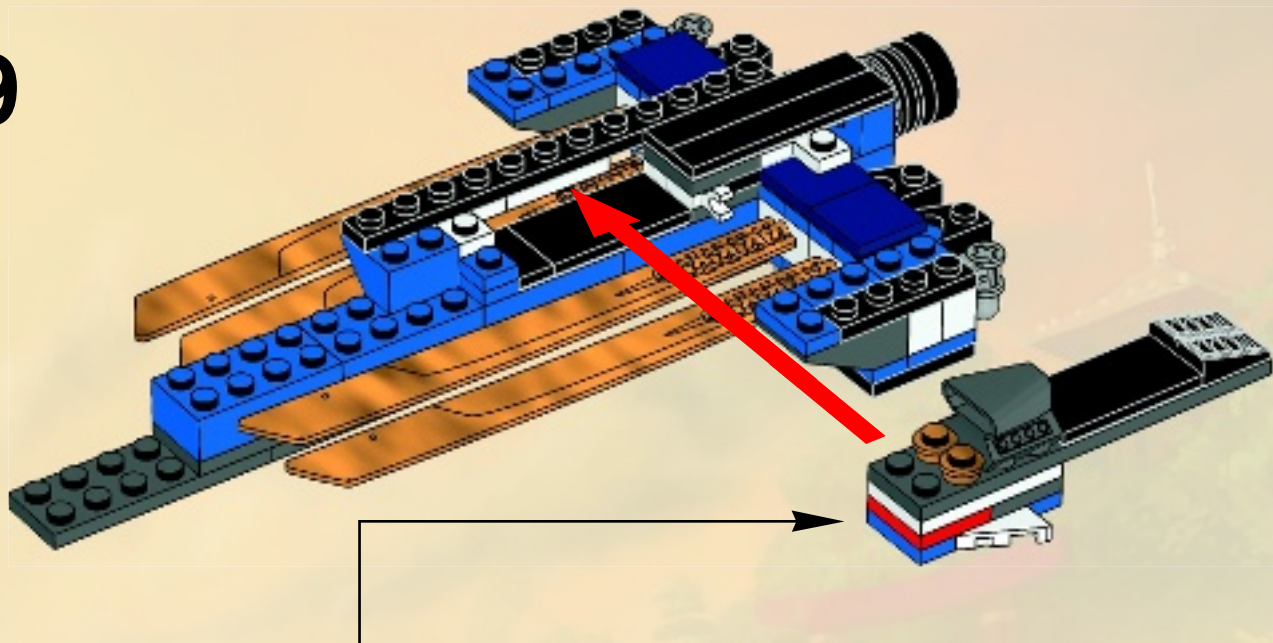

40

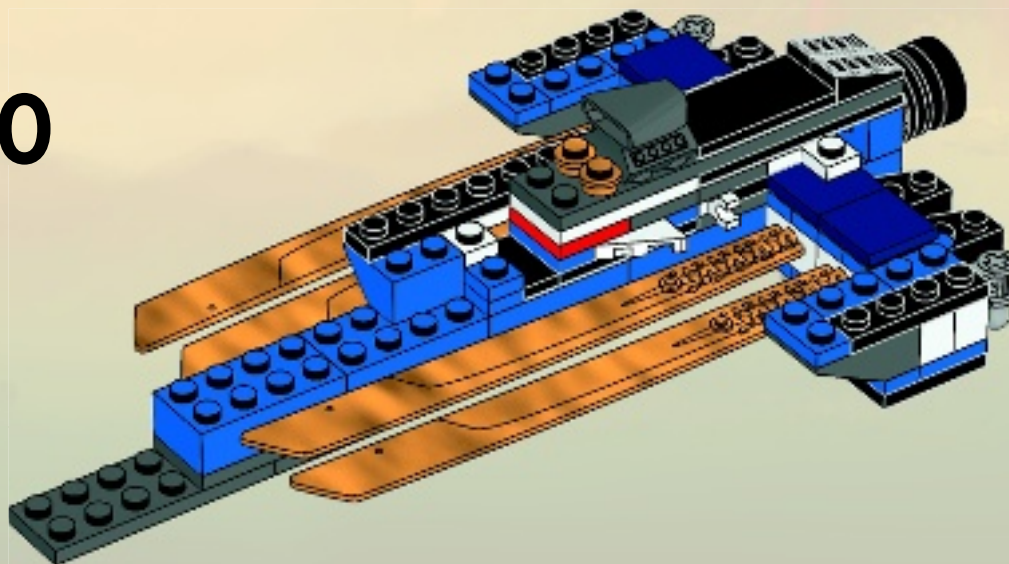



1



2

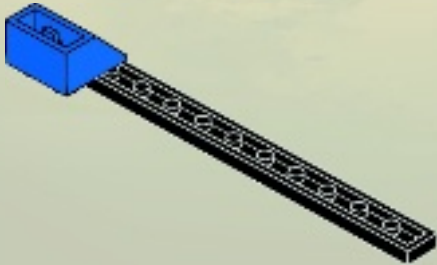

3

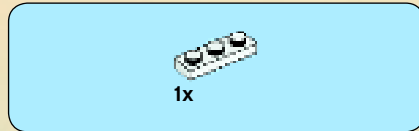
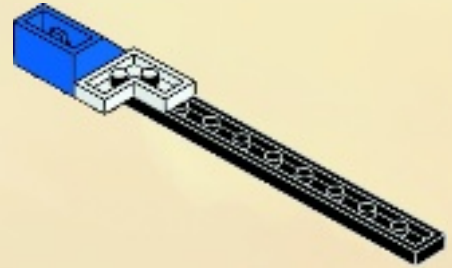

4

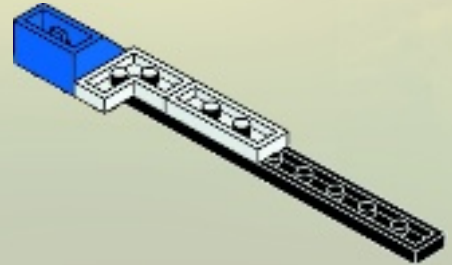

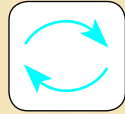

41

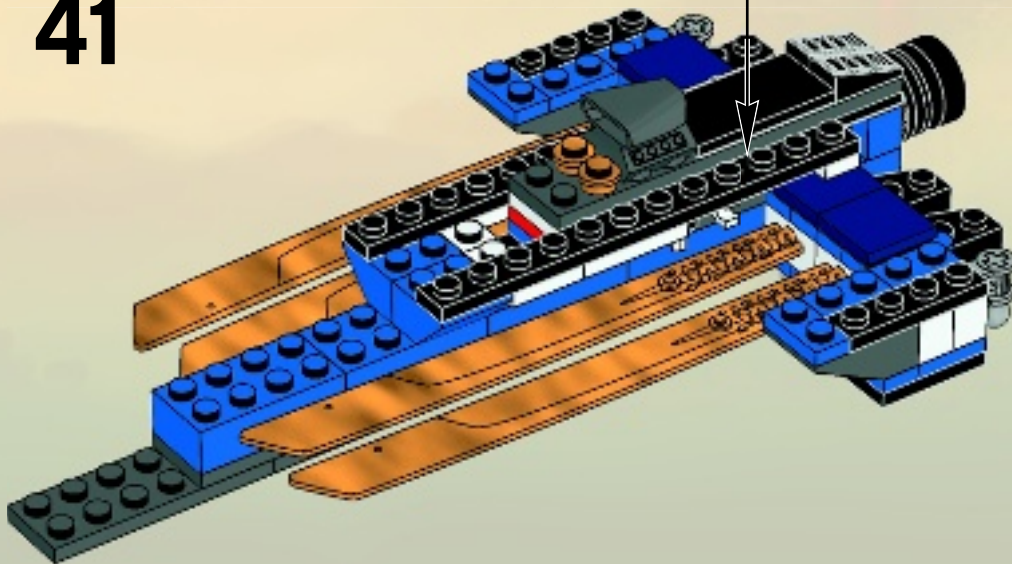



4x



1x

42

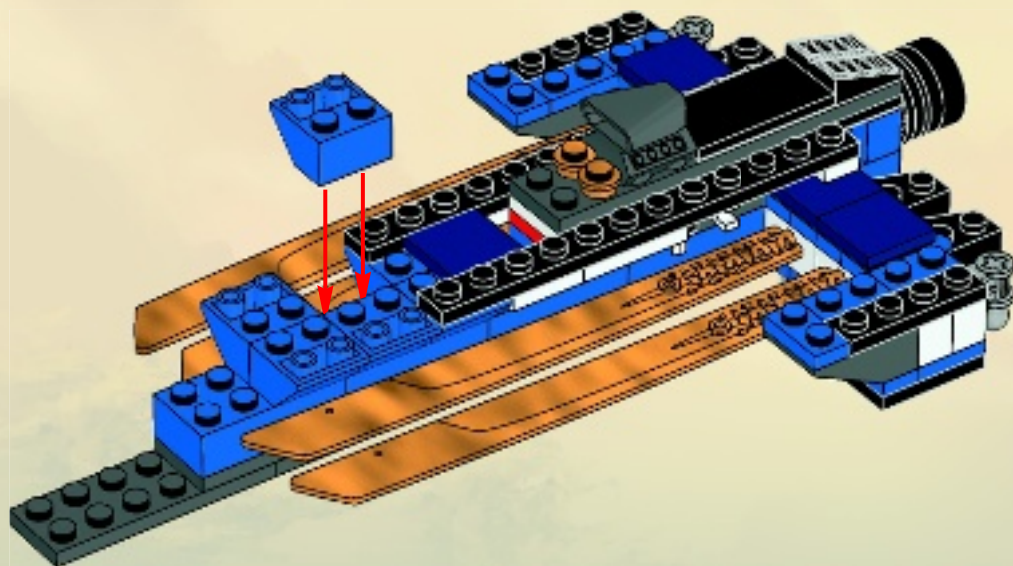



43

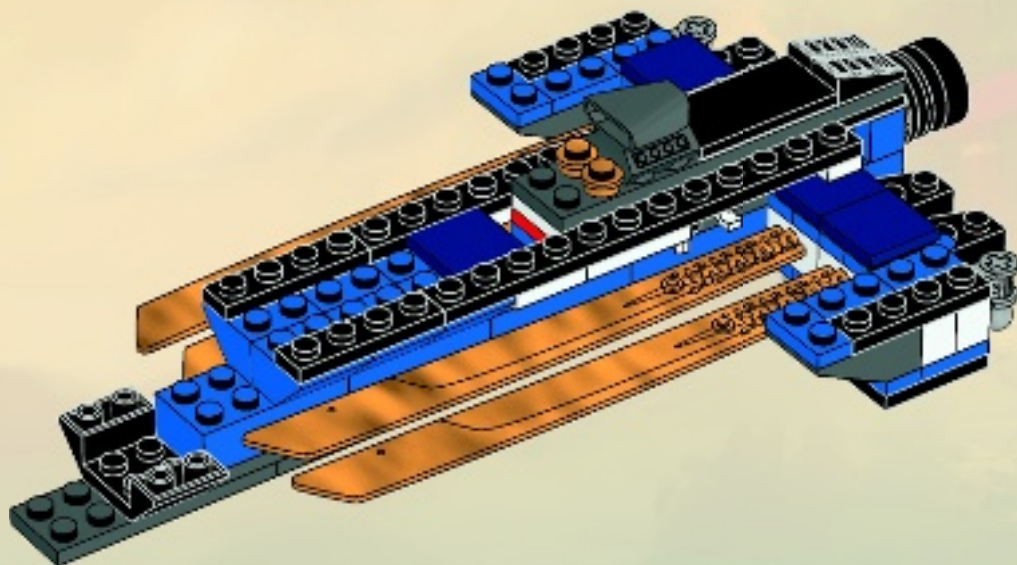

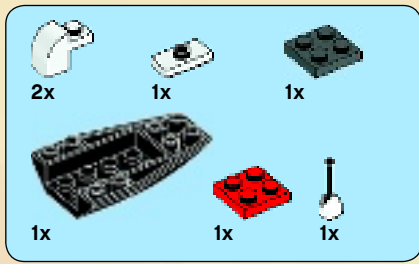

1



2



3



4

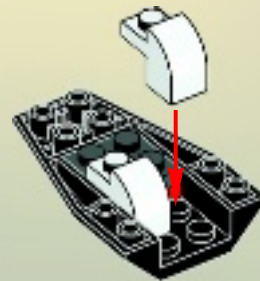

5



6

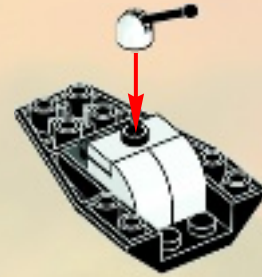

44

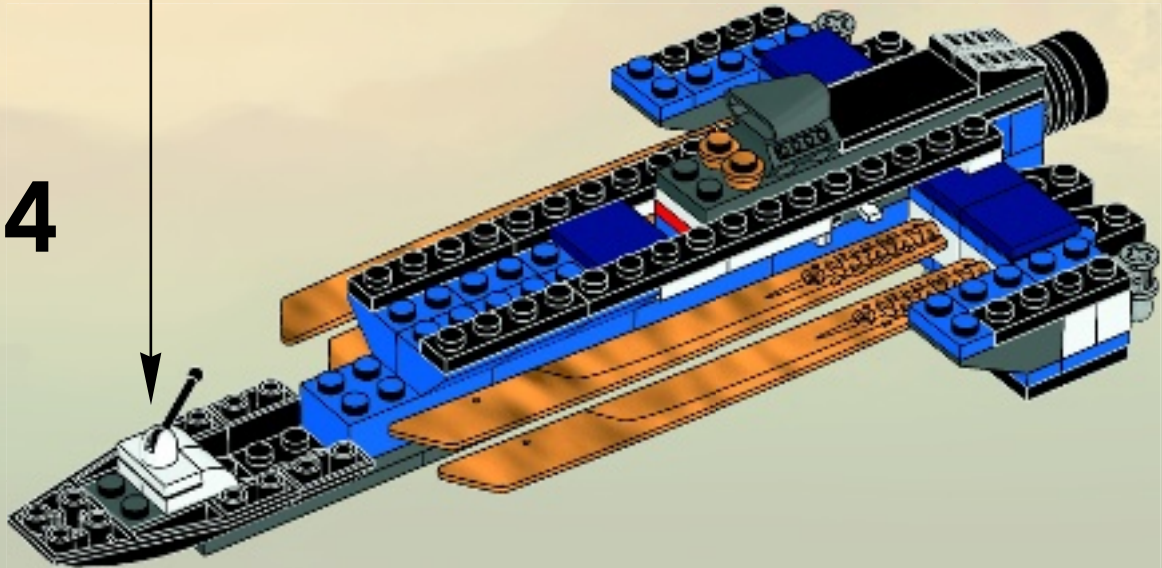



2x

45

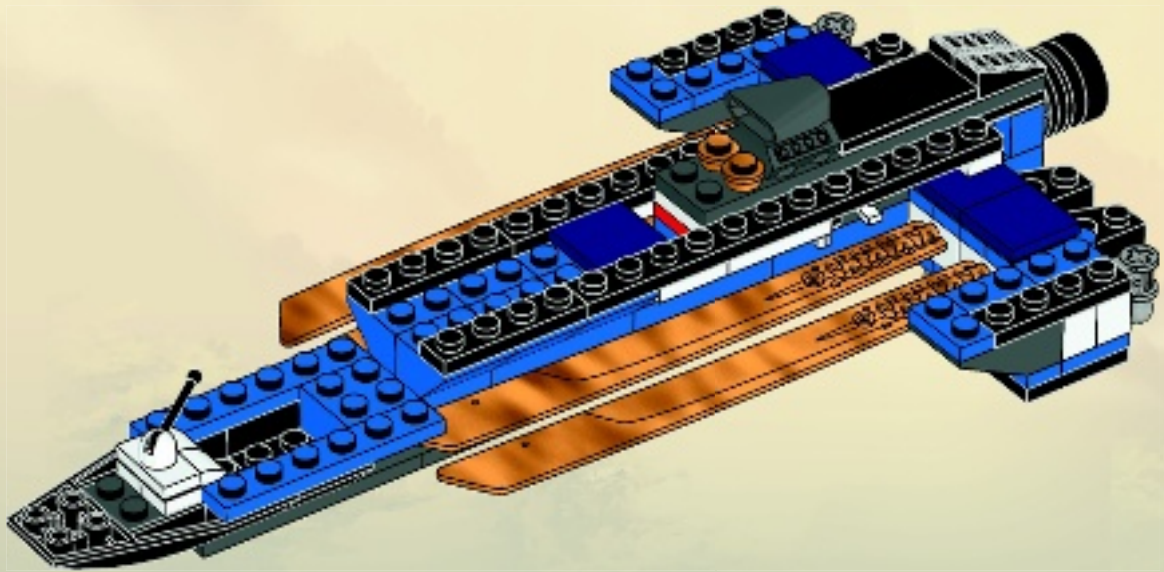



NINJAGO

Masters of Spinjitzu



NINJAGO.COM



9445

9442

9443

9446

9567
9552

9564

9563

9561

9552

9566

9566

9441
9558
9579



9444

9441
9558

9441
9444
9446

9579

9562
9440

9444
9566

9551

9440
9445
9446
9553
9558

9562

9558

9563
9567

9564



9551
 9443
 9446
 9446
 9443
 9446
 9552
 9444
9579
 9561
9553
 9442
9558
 9579
9558



9562
 9564
 9443
 9442
9445
 9446
 9446
9551
9558
9561
 9558
9579
 9579
 9567
 9553
 9440
 9445



NINJAGO

Masters of Spinjitzu



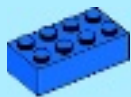

1x

46

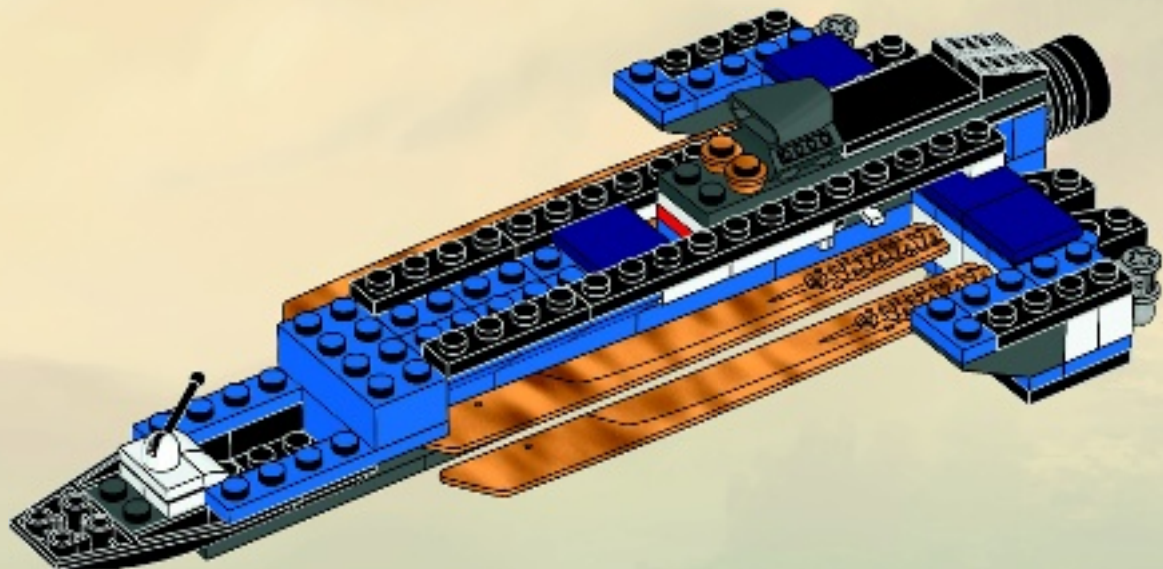

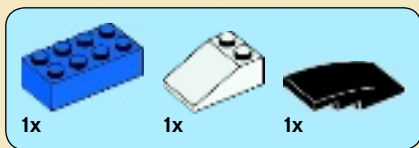

47

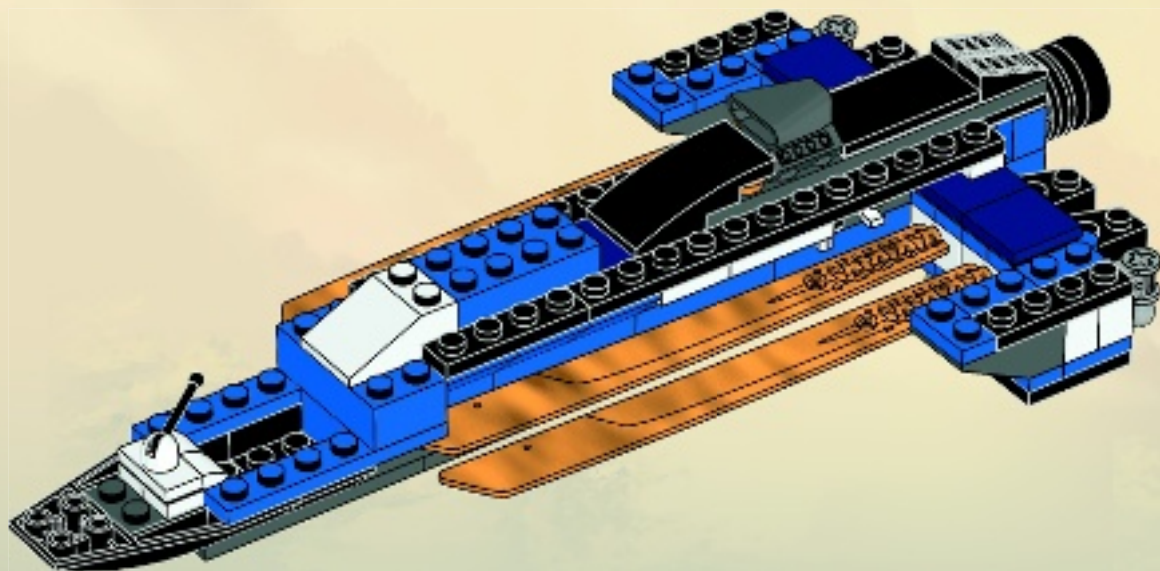



2x



2x



2x

48

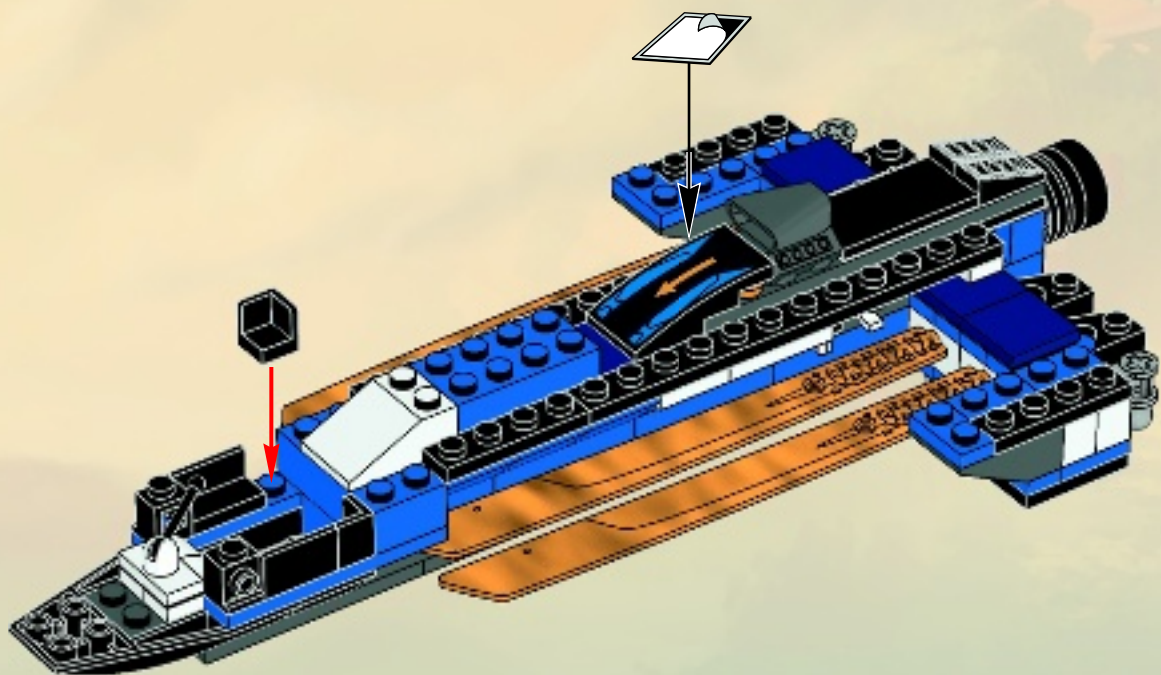

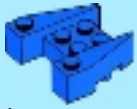

1x

49

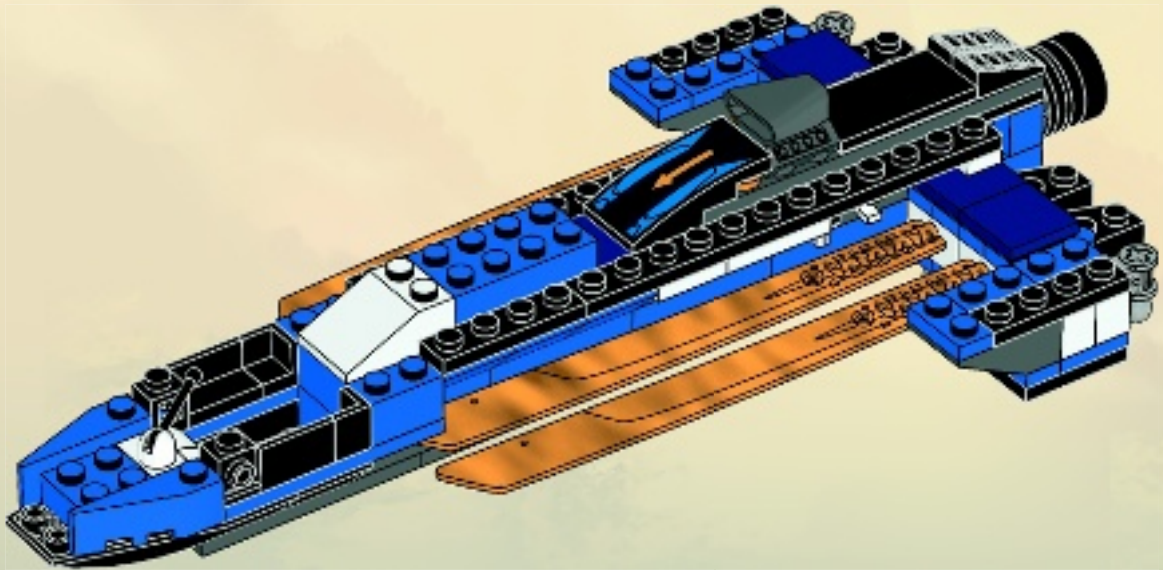

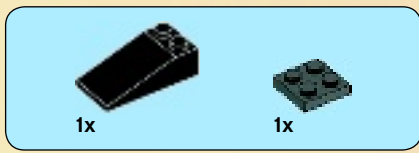

50

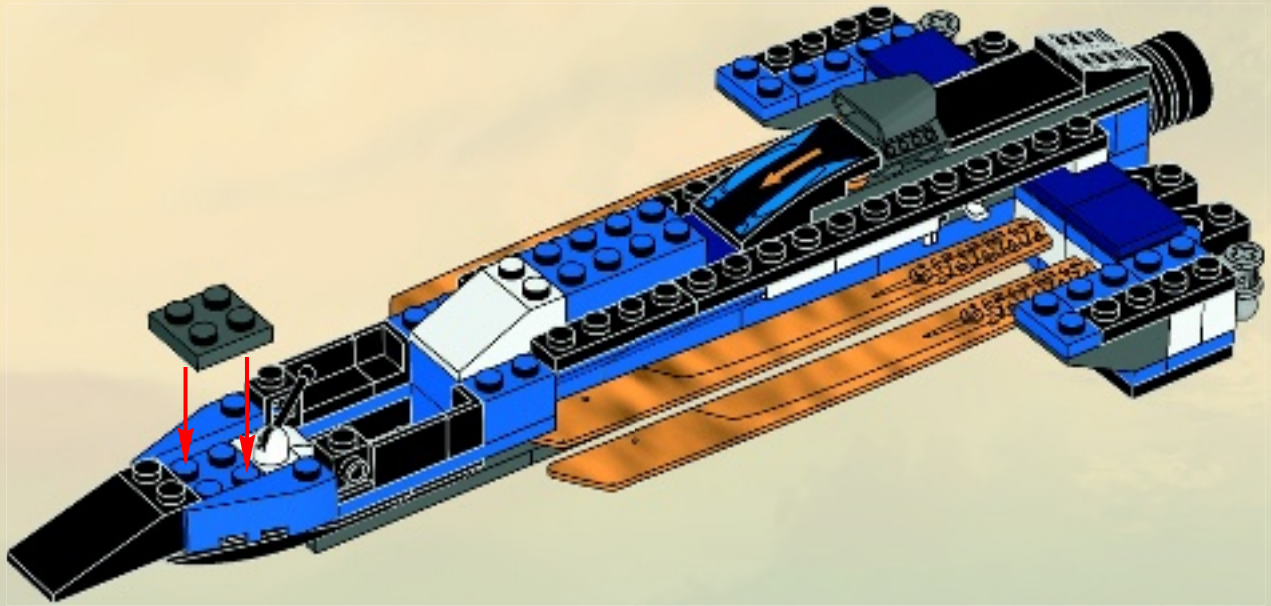



1x

51

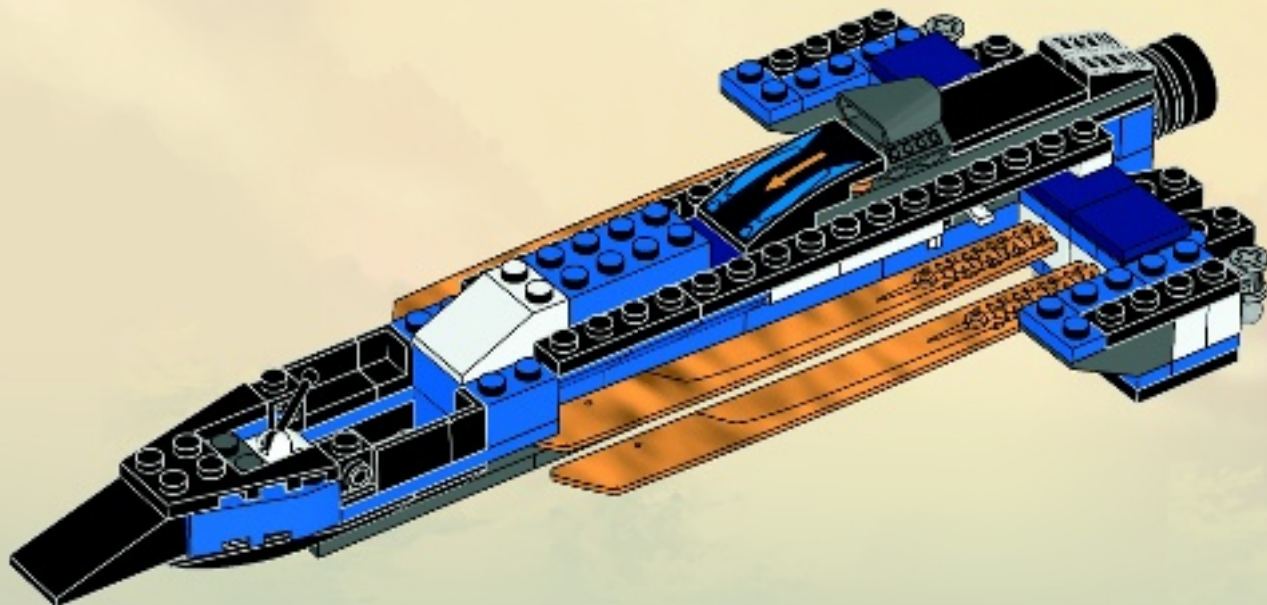

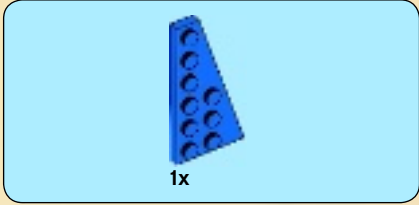

1

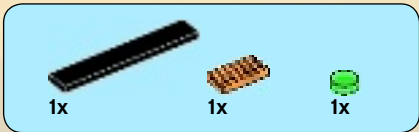

2

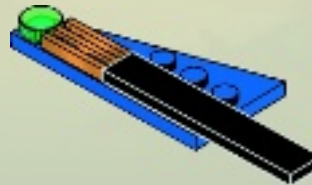

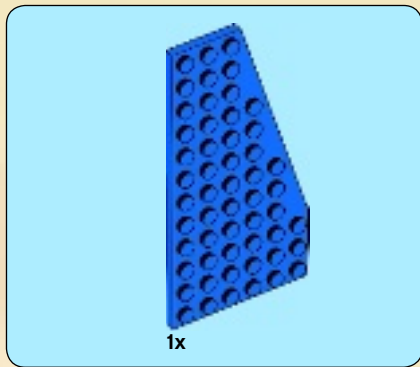

3

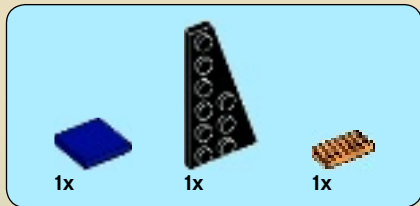
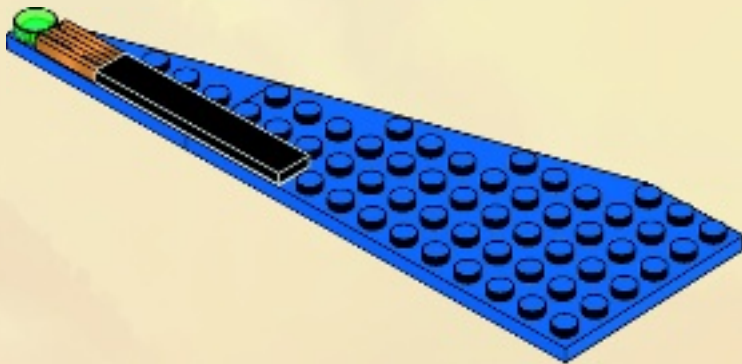

4

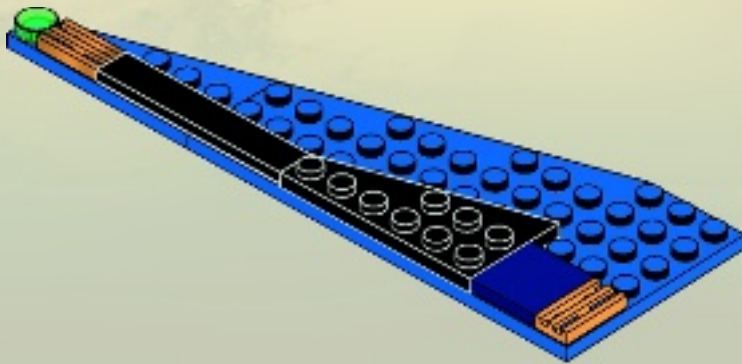

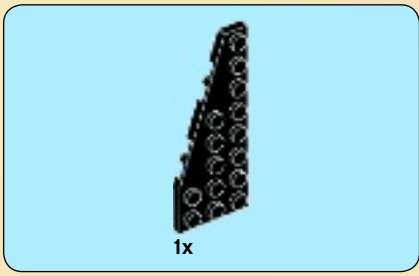

5

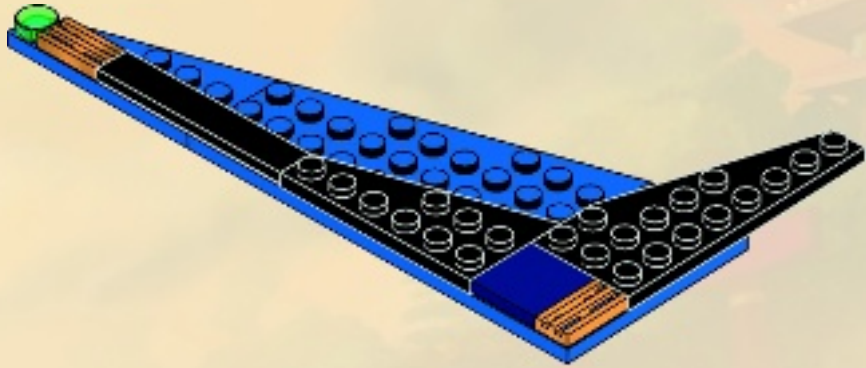

6

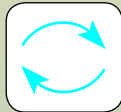
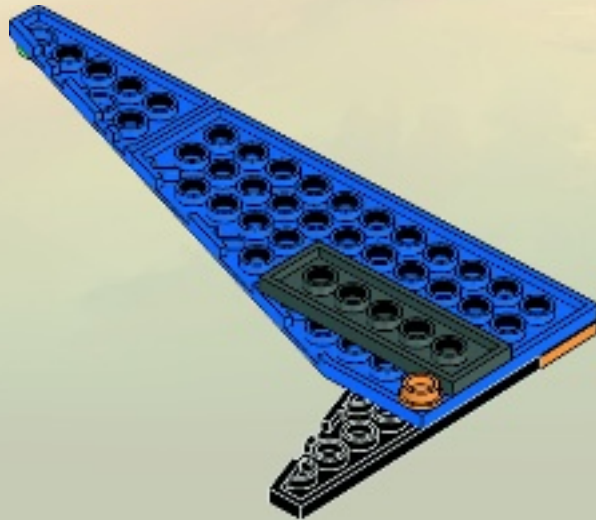



7

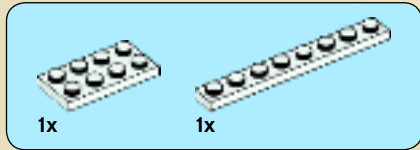
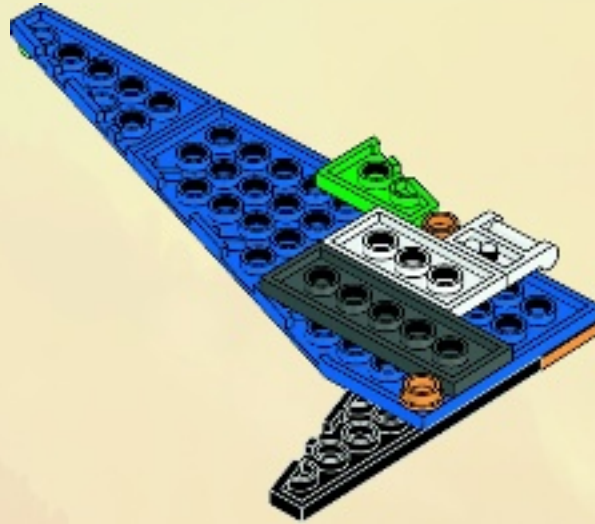

8

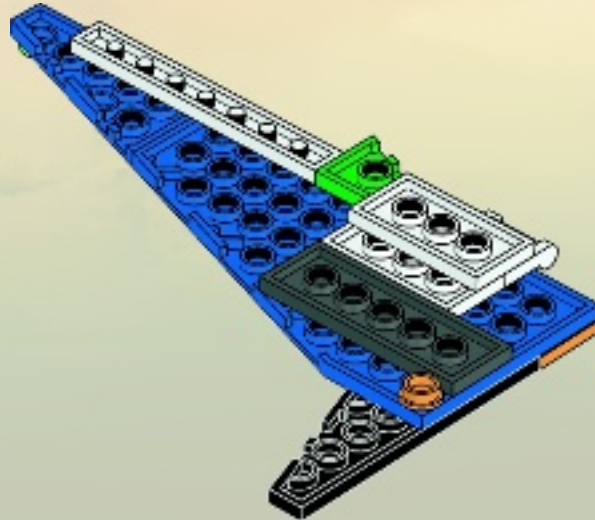



2x



1x

9

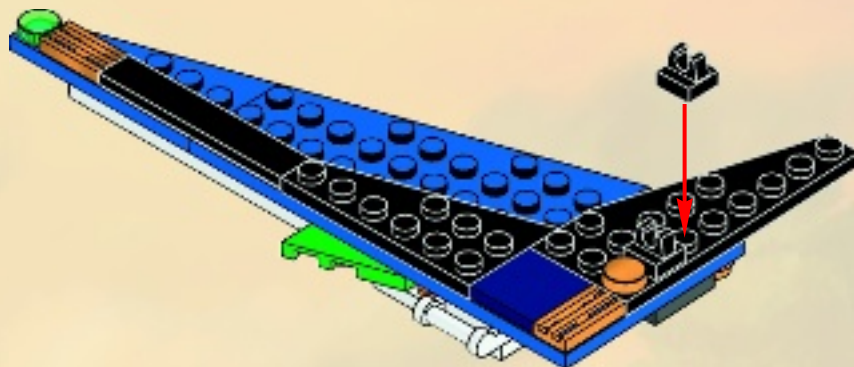
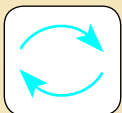

1x

10

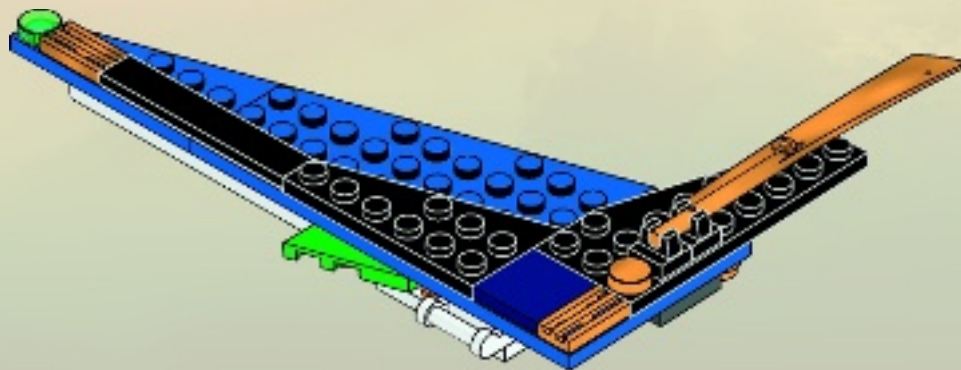

52

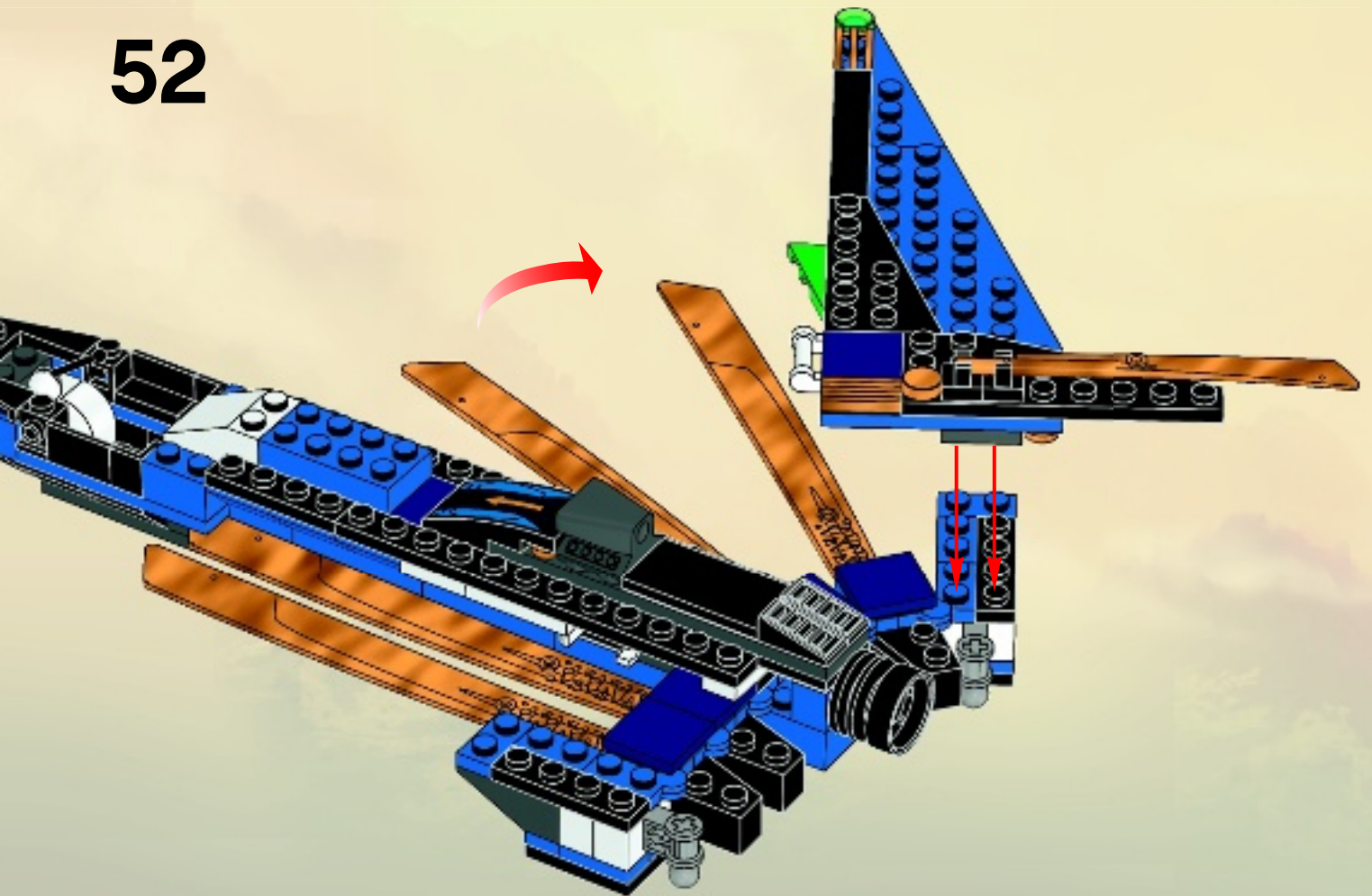

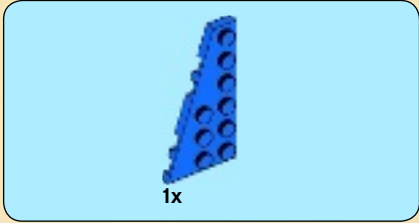
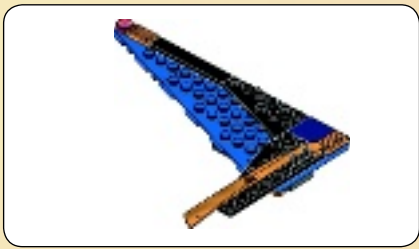

1

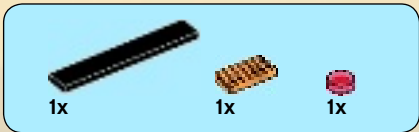
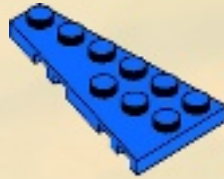

2

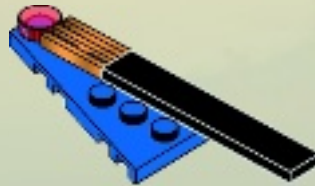

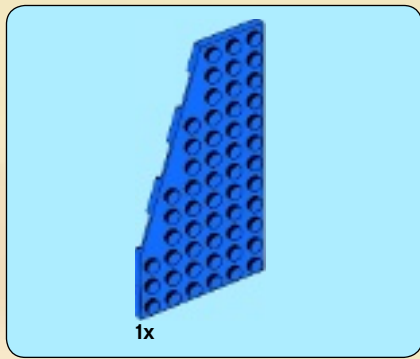

3

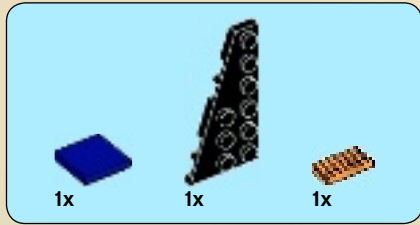
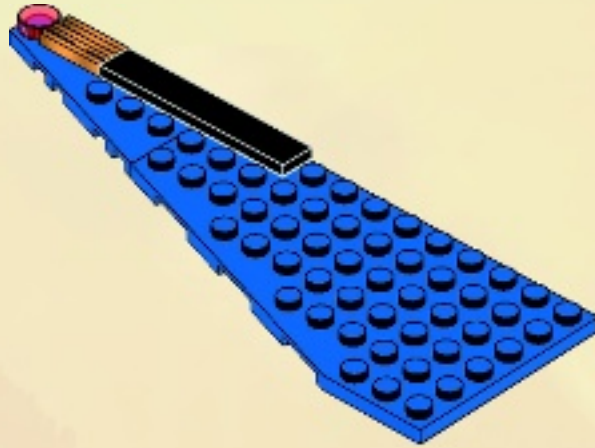

4

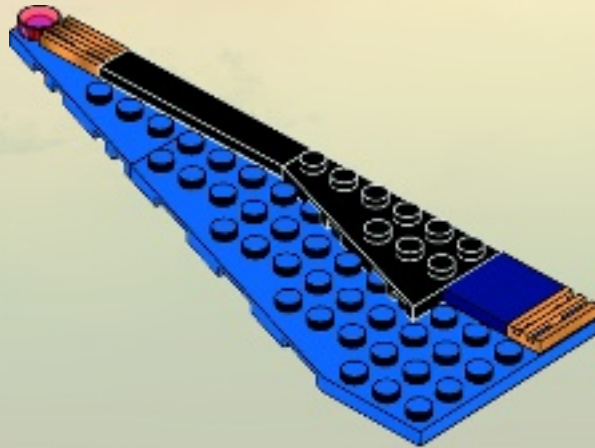

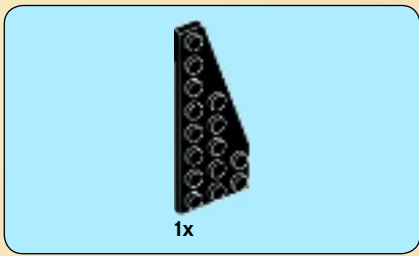

5

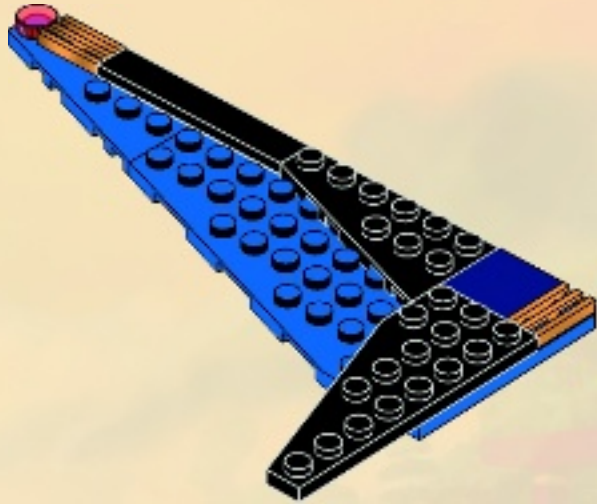

6

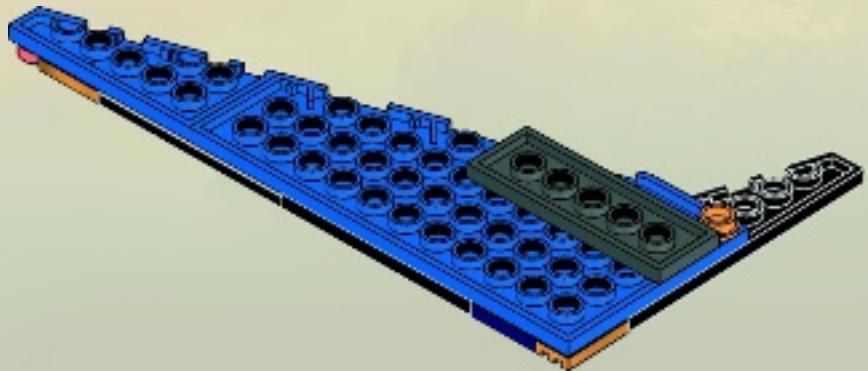
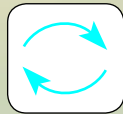

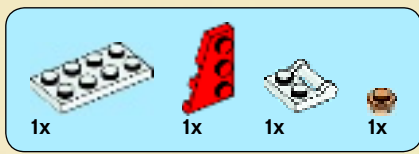

7

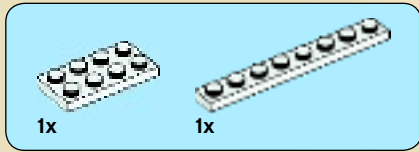
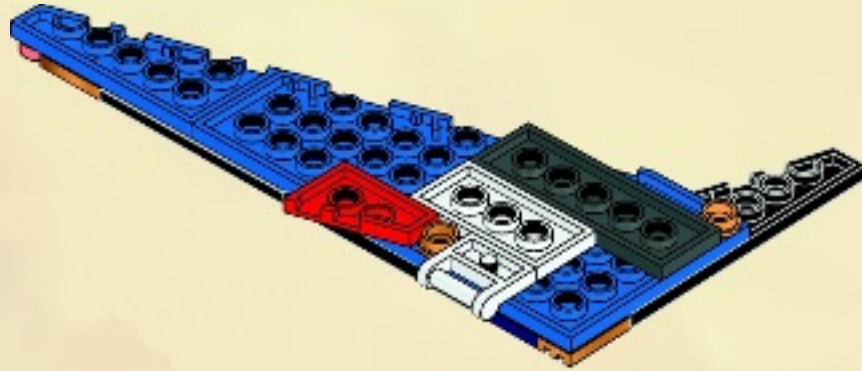

8

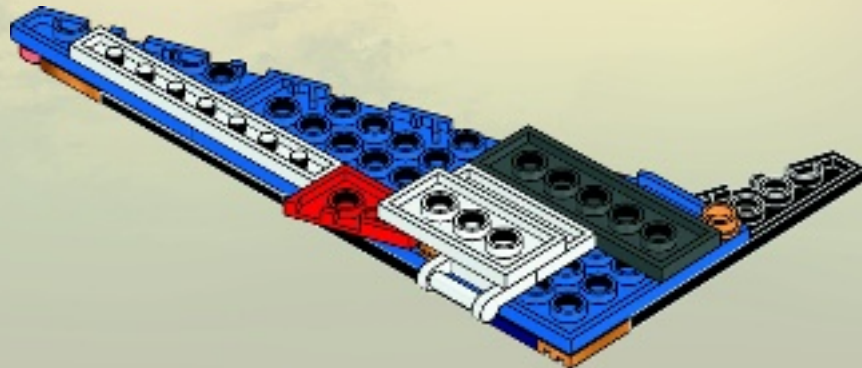



2x



1x

9

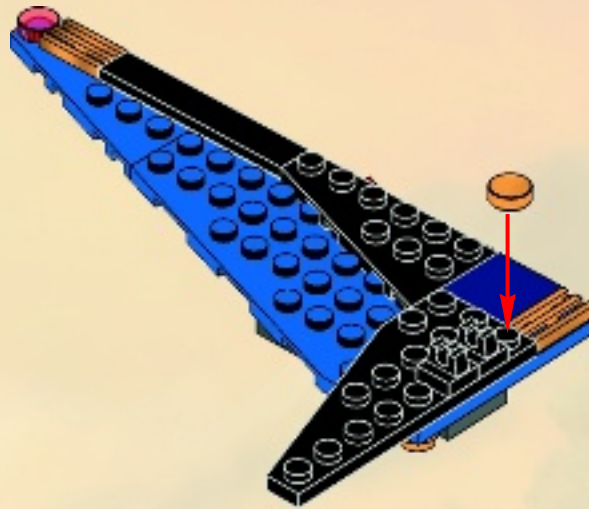

1x

11

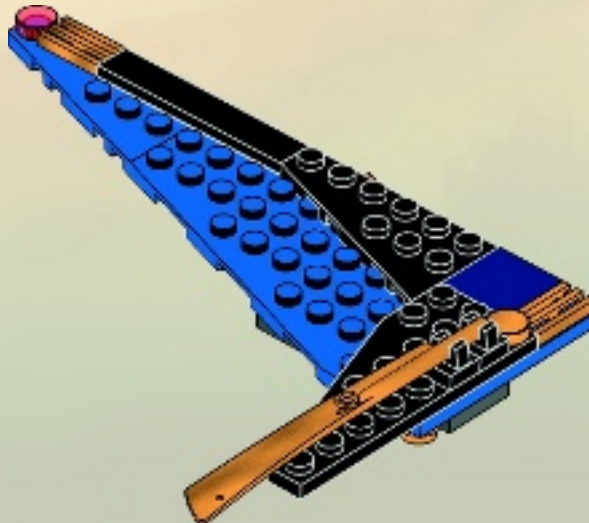

53

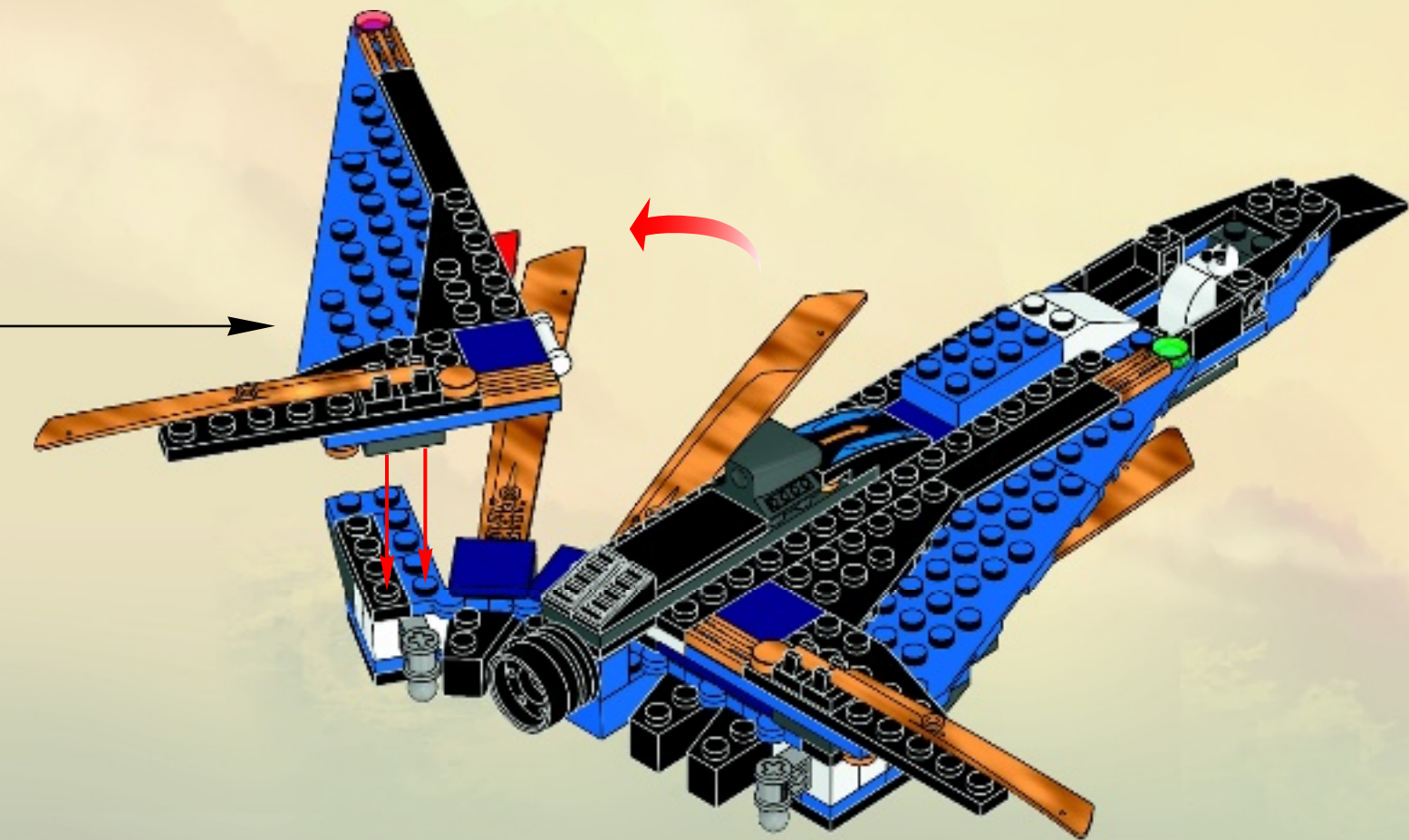



2x

54

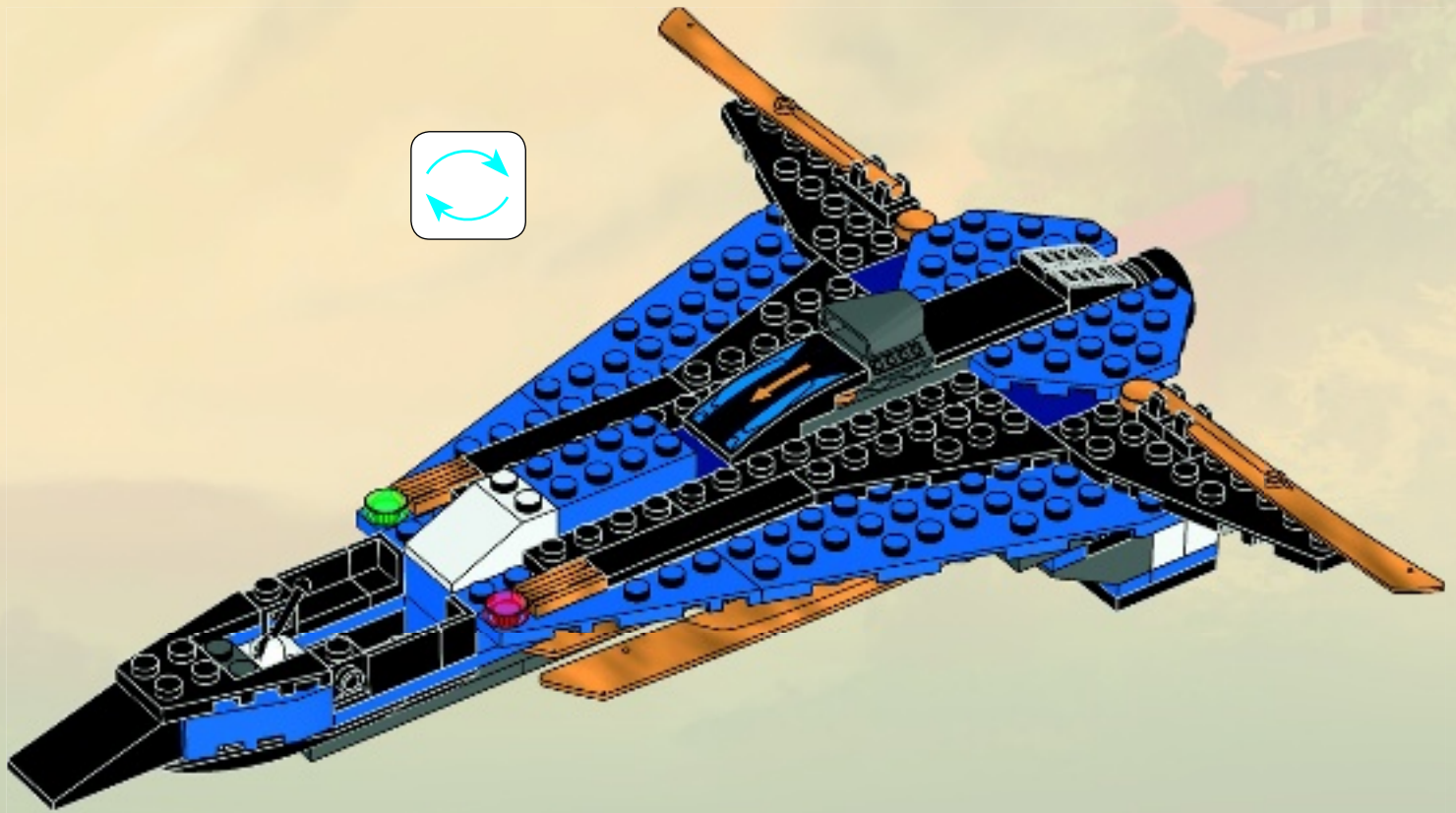
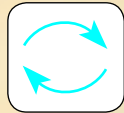



2x

55

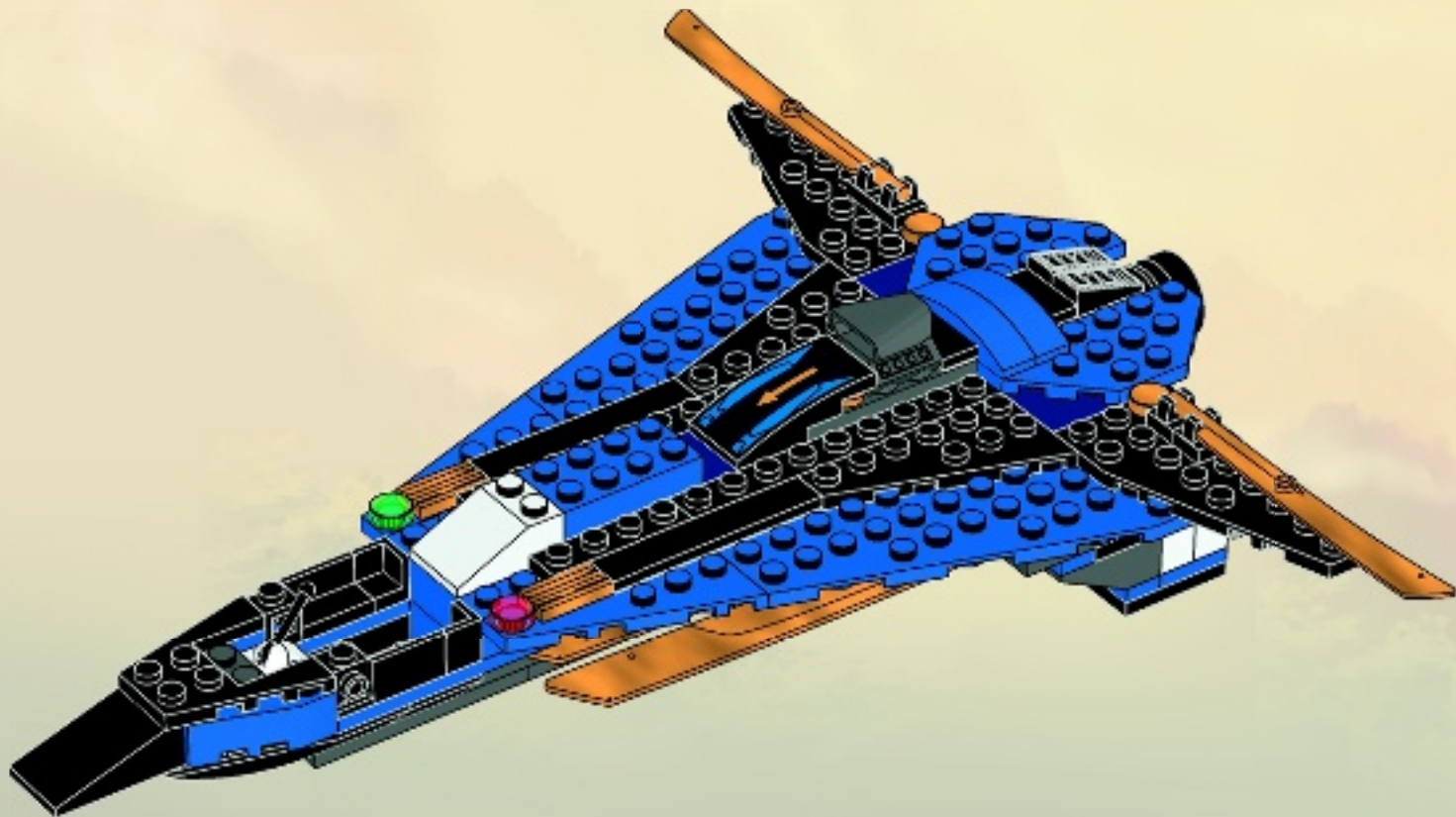

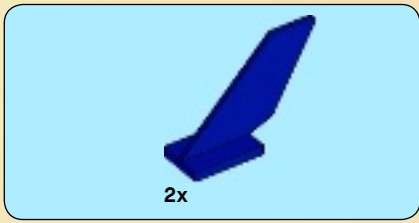

56

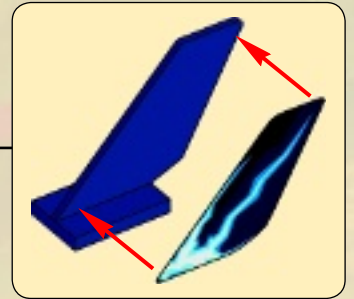
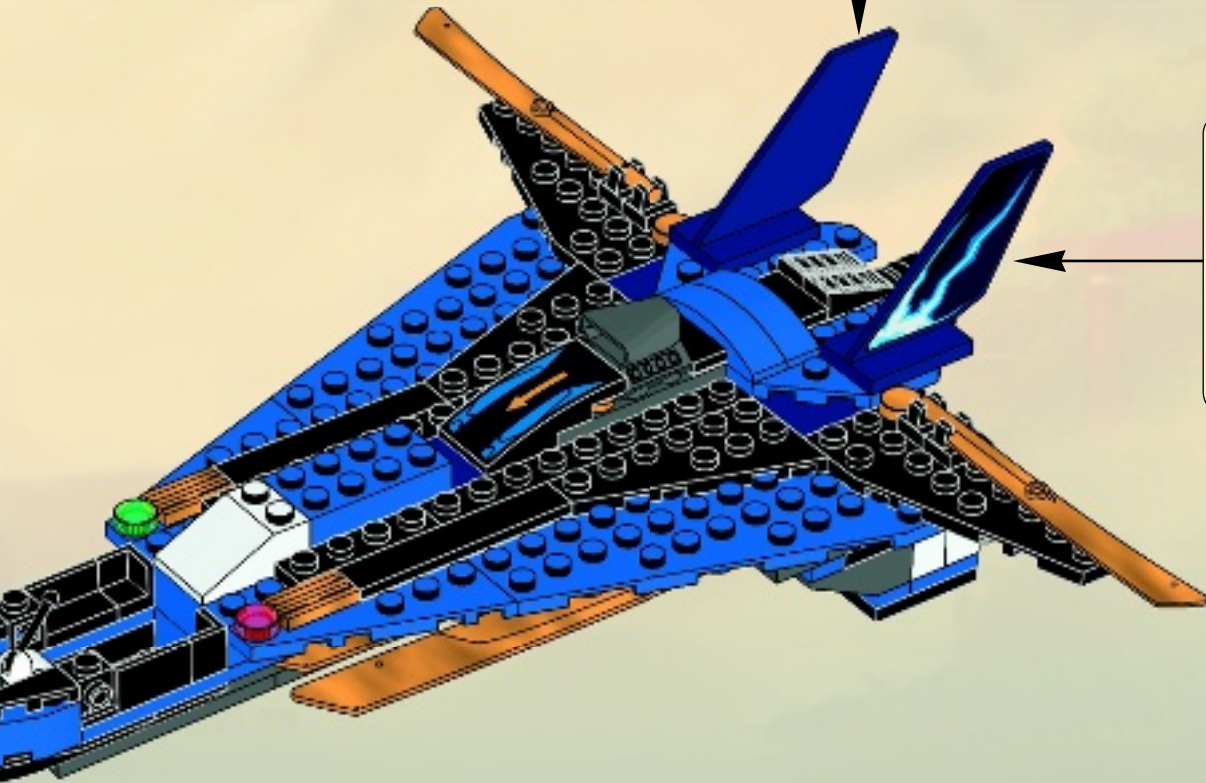
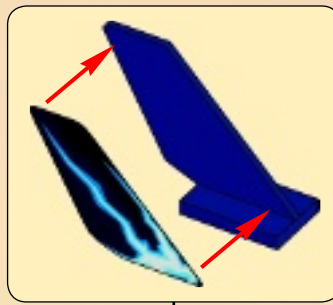



1x



1x



6x

57

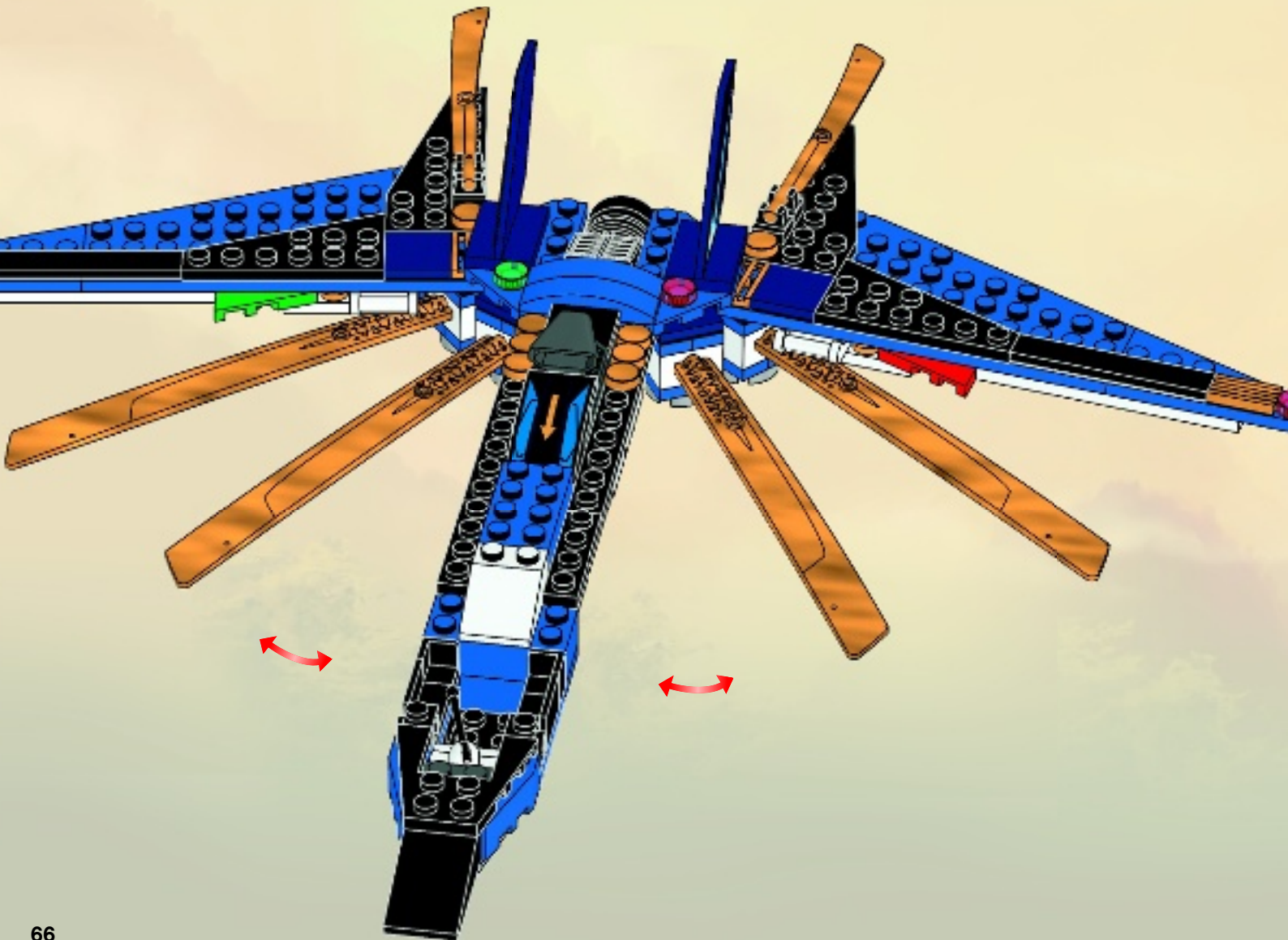



2x

58

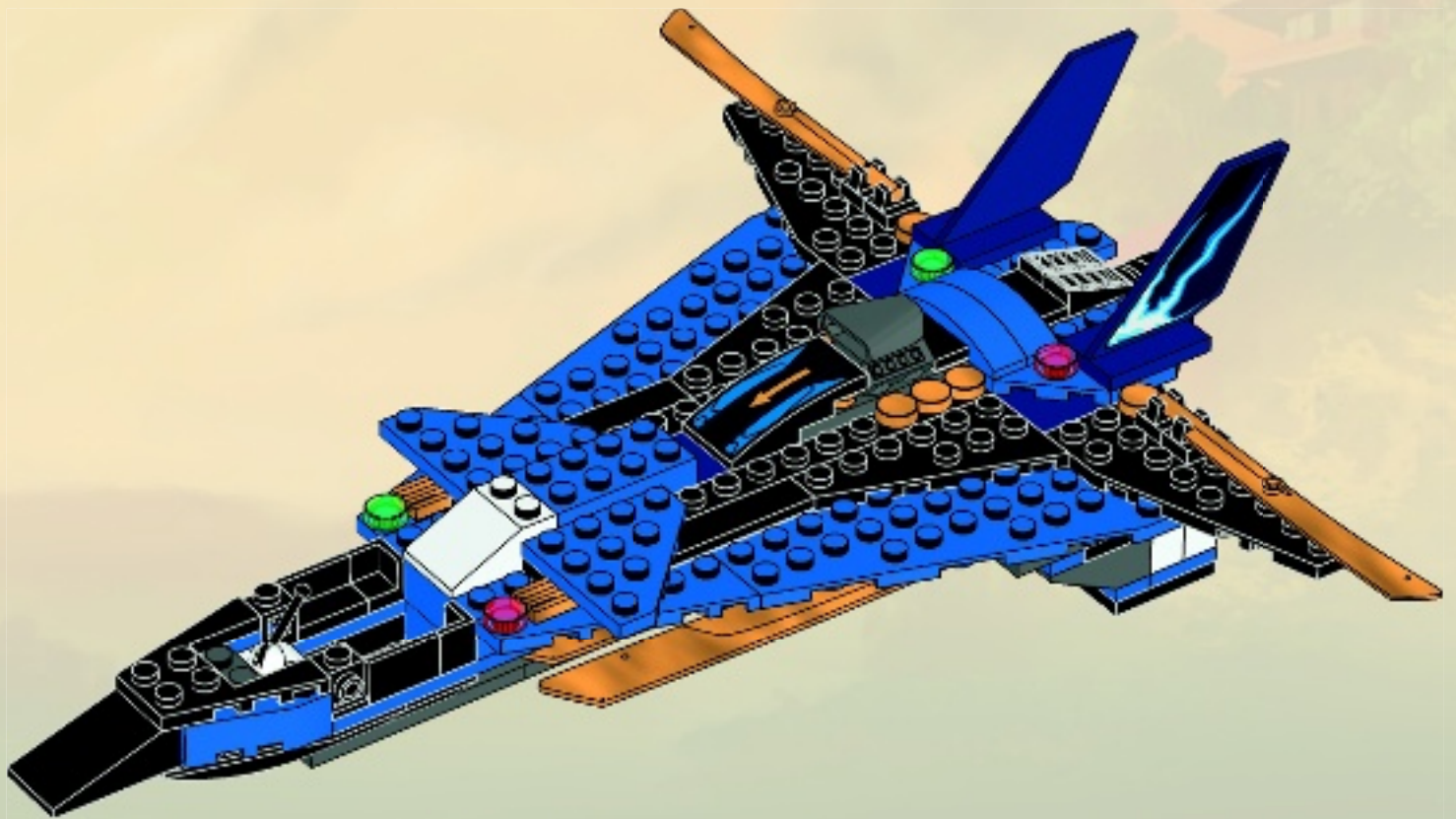

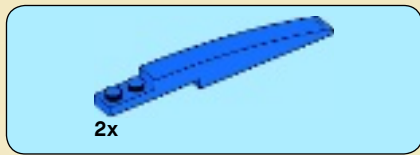

59

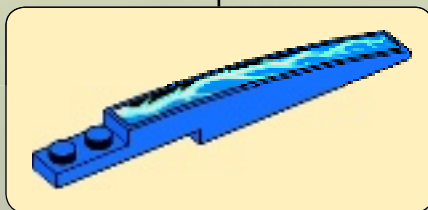
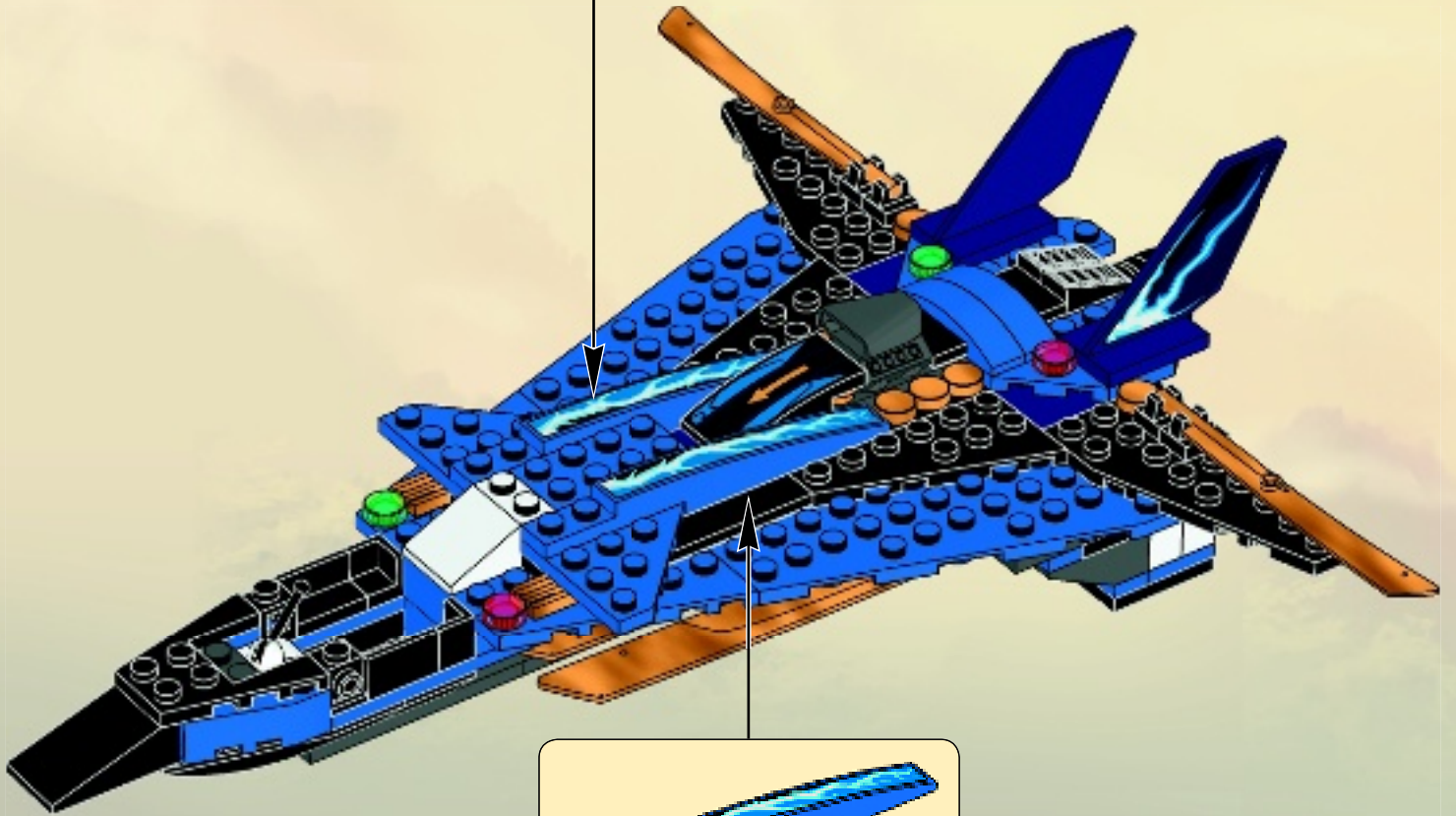
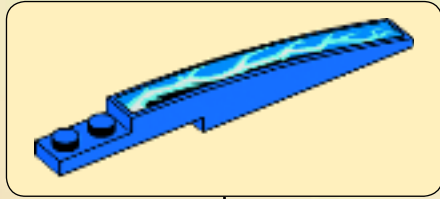



4x

60

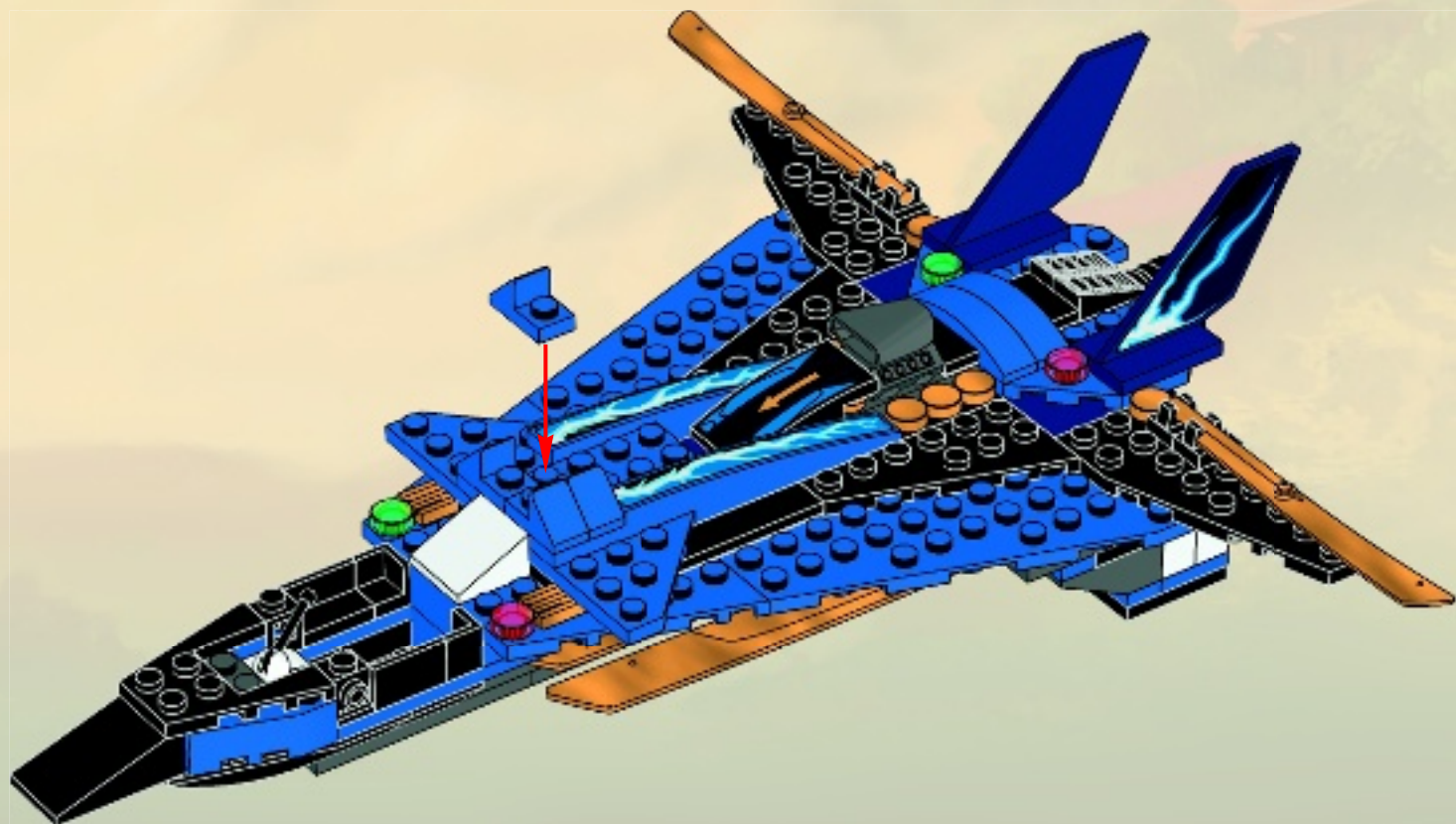



2x

61

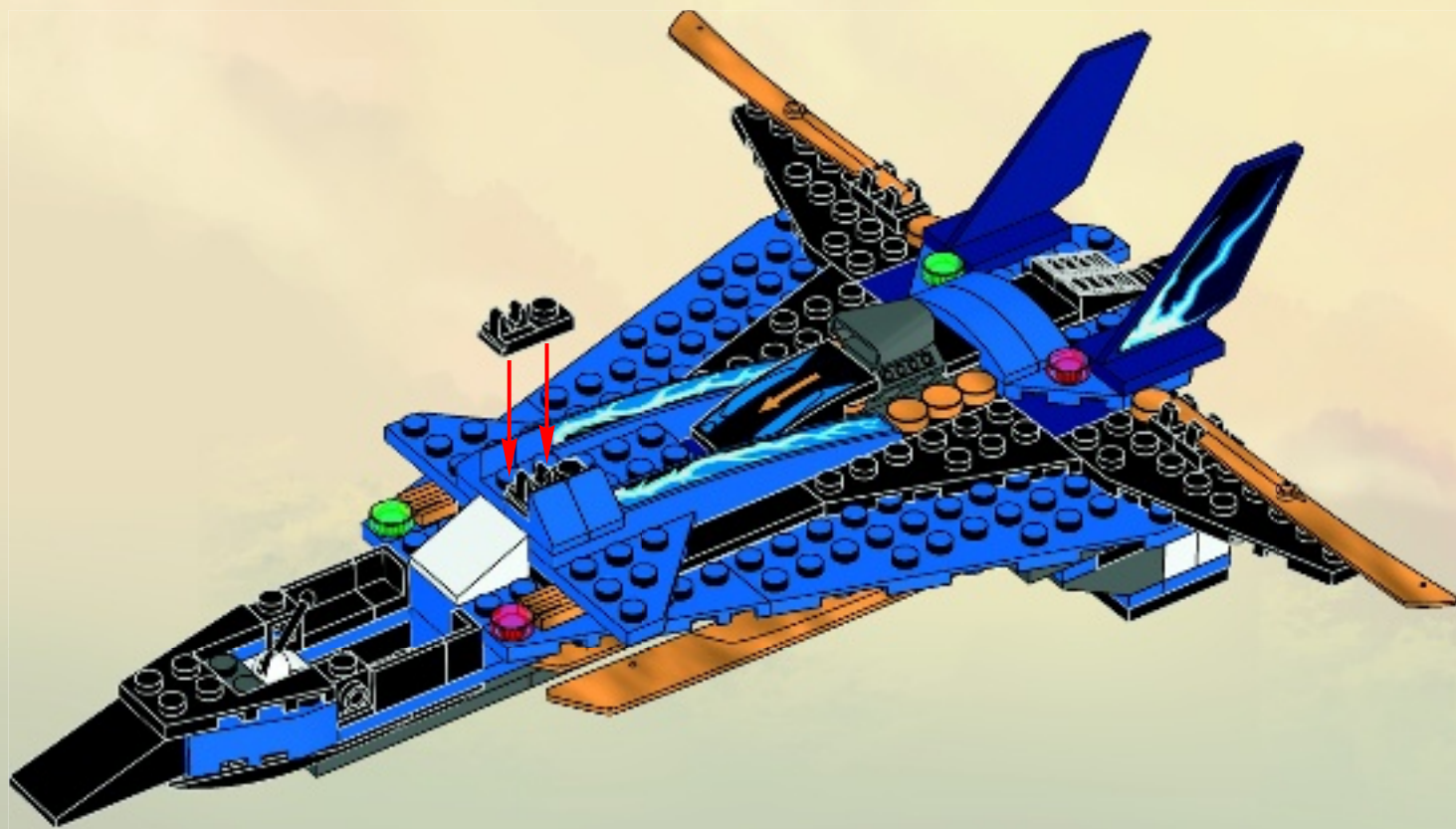



1x

62

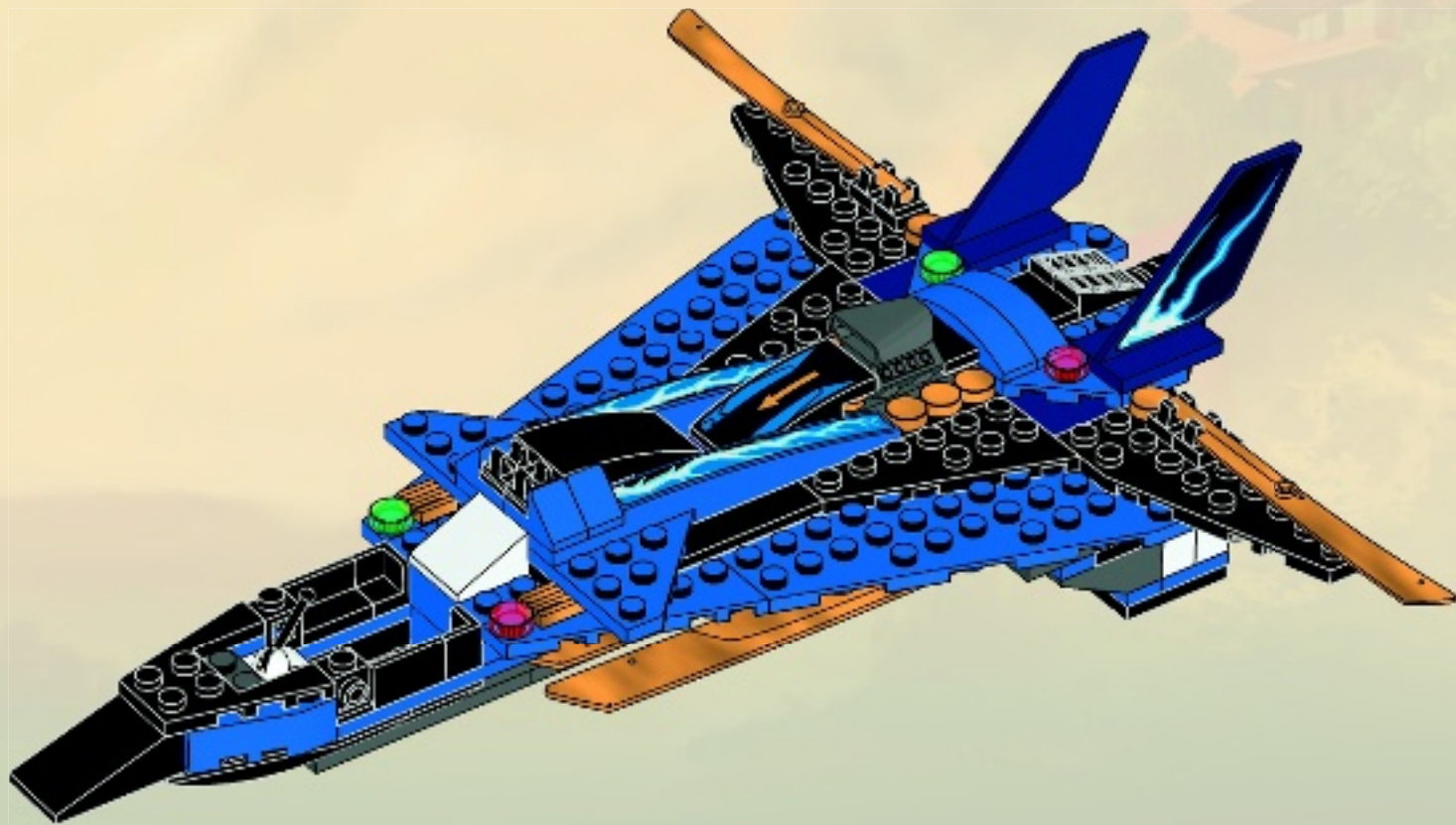



2x



2x

63

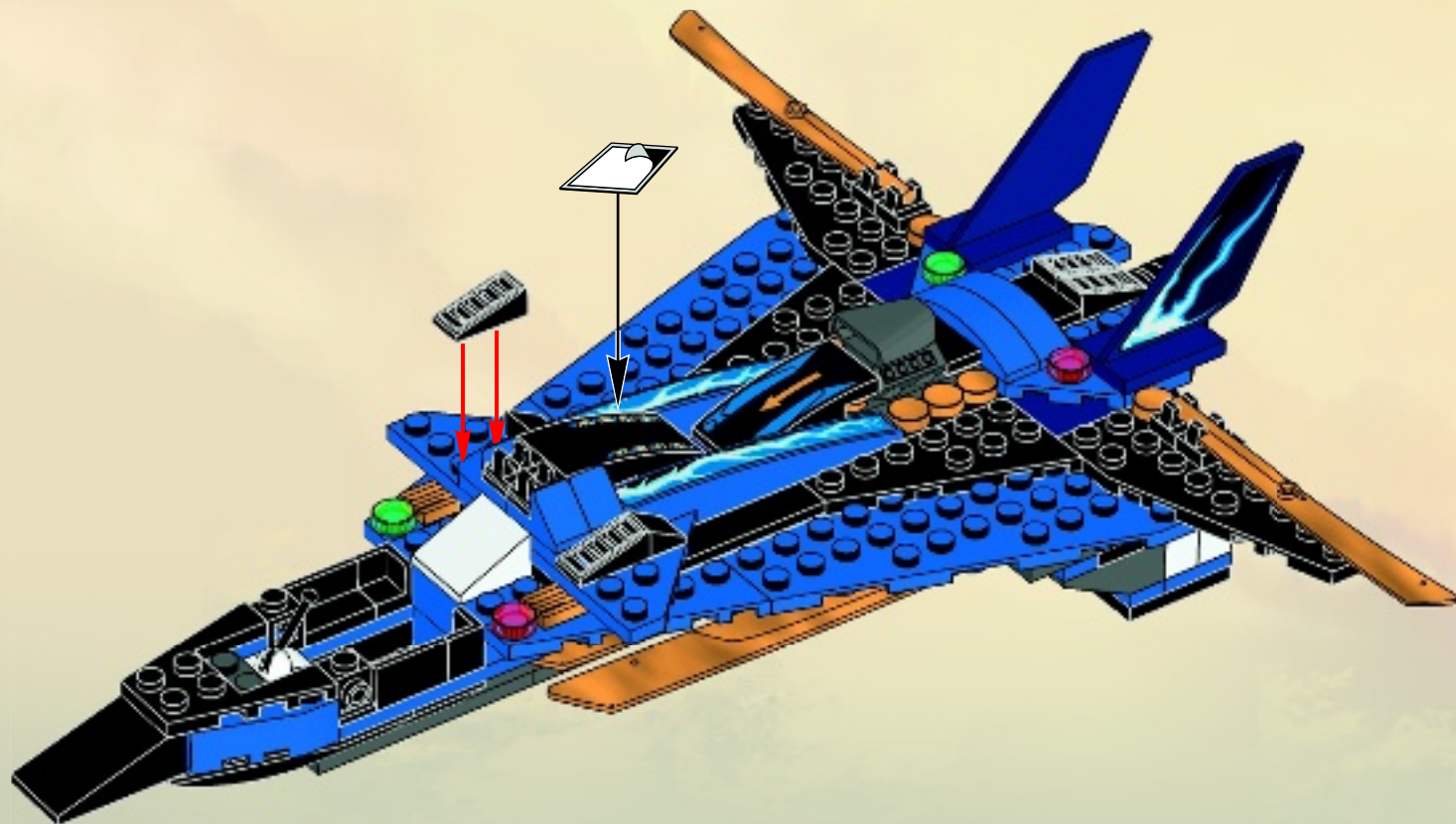



1x

64

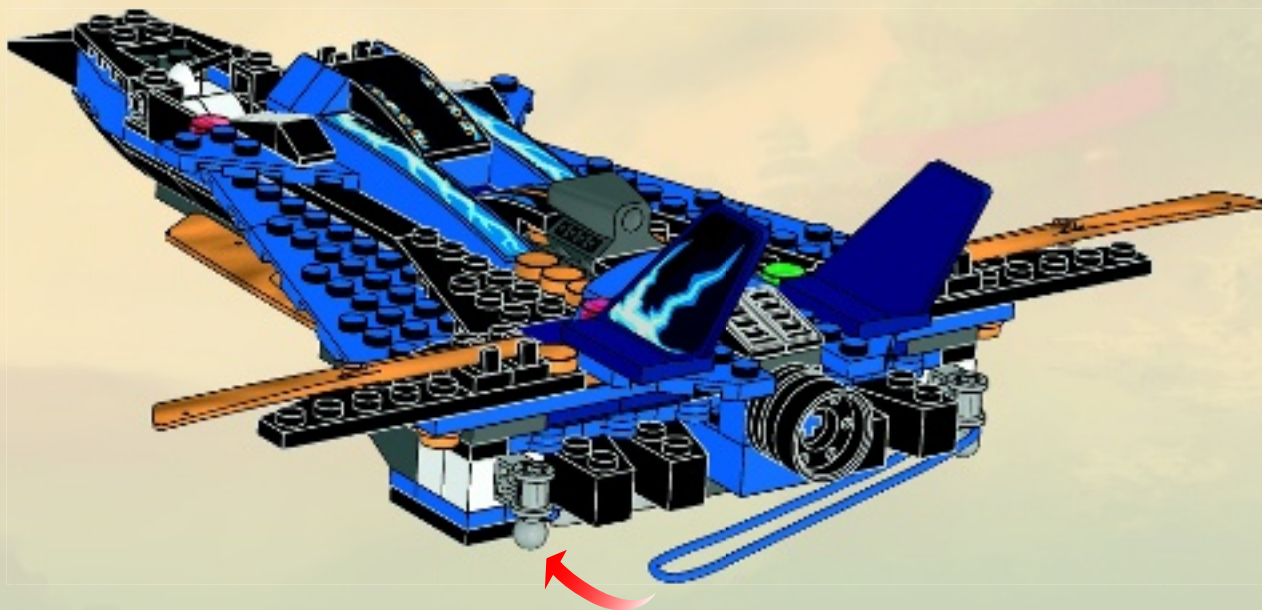



65

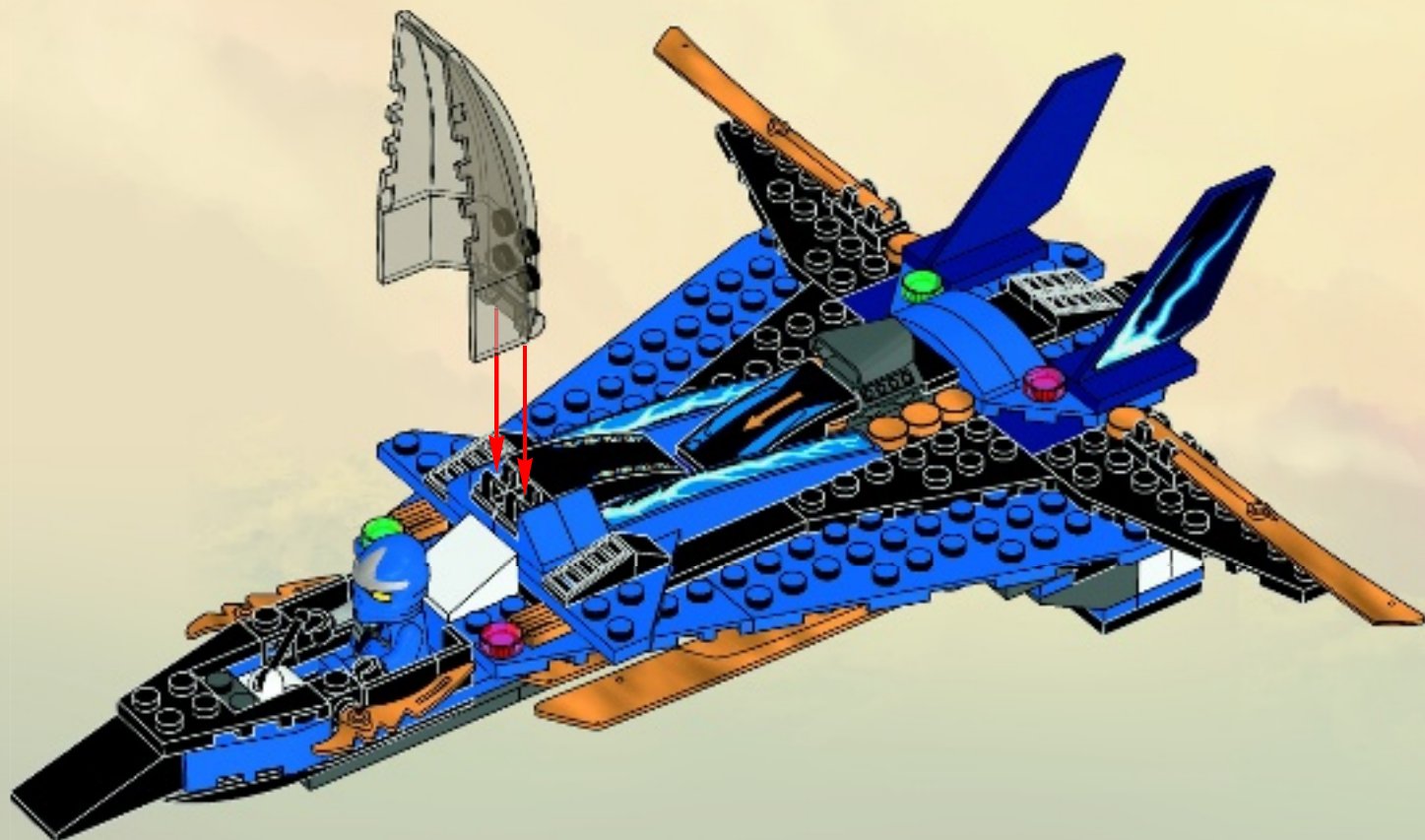

66

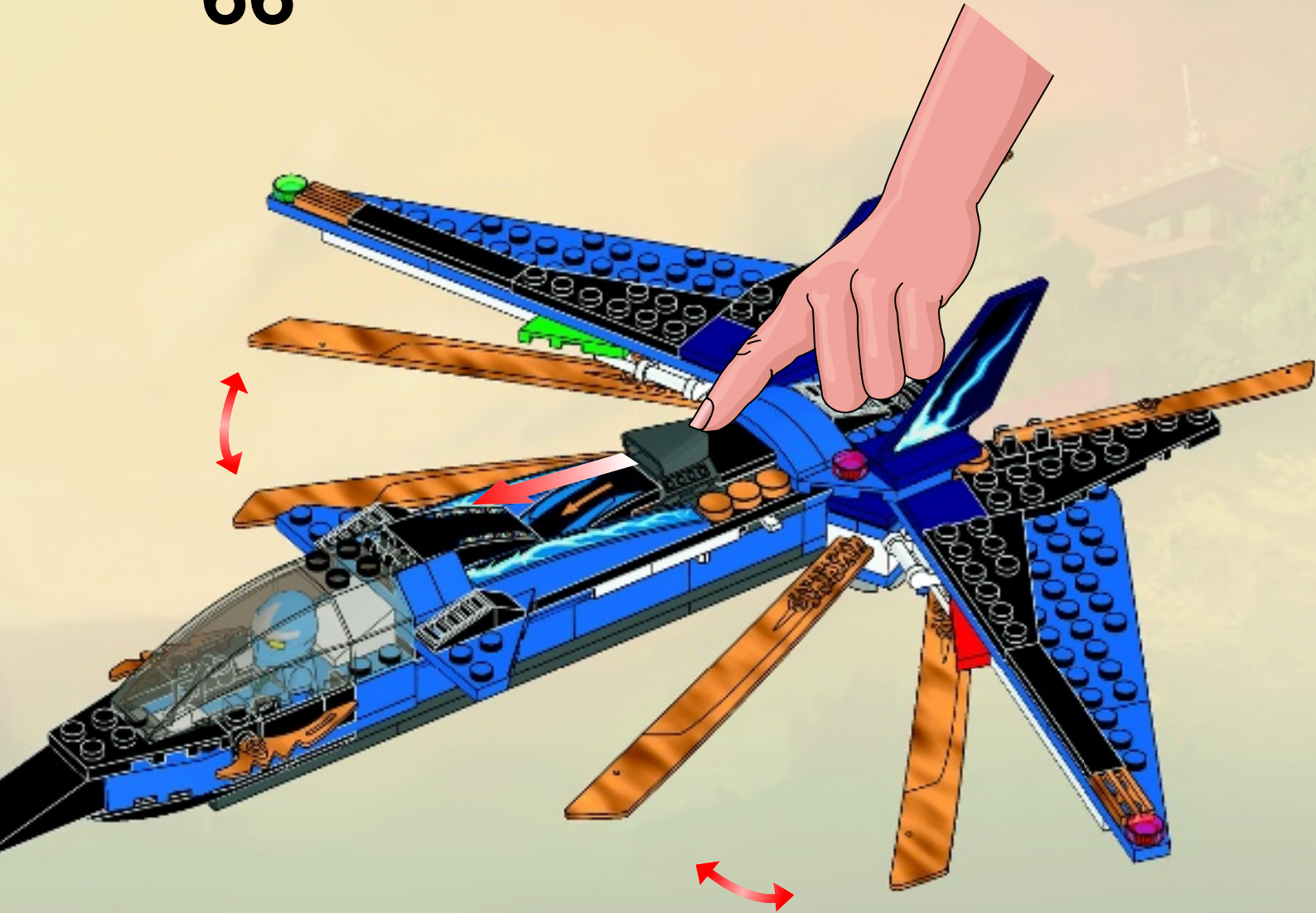



8x
4233486

1x
329801

2x
609101

4x
242001

2x
362301

5x
302001

2x
346001

1x
379401

2x
4222017

1x
4249506

1x
4647447

1x
4648341

1x
4648982

2x
4538353

1x
73737

2x
302221

1x
4180533

1x
4648344

7x
300123

1x
4622604

1x
370023

6x
366023

12x
302323

2x
366623

1x
4543090

1x
4543089

2x
241923

2x
4609342

4x
4620297

2x
4649773

1x
4650492

1x
4650129



1x
4650118

1x
4544147

1x
4206482

1x
4611427



12x
4119371

2x
4649421

1x
4647545

1x
4647544

2x
407026

2x
4526931

2x
4527766



1x
4188534



1x
4185583

1x
4180469

3x
302126

4x
371026

1x
302026

2x
4514845

1x
4283047

1x
4251393

1x
4251394



1x
4283046



4x
255526

2x
4598528

2x
4504382

1x
306926

2x
4560182

4x
663626

2x
4647286

1x
4561035

2x
4106347

2x
486526

1x
4517737

4x
4541191



1x
4621947



2x
4114348



2x
4646864



1x
4653402



2x
4646860



2x
4272661



1x
4598530



4x
4646577



2x
4616593



7x
4205004



2x
4647626



4x
4211475



2x
4211375



2x
4211536



1x
4265794



2x
4211064



2x
4210797



5x
4211094



6x
4211002



3x
4210678



2x
4587212



1x
4509194



1x
4502068



2x
4587002



4x
4490599



6x
4523159



8x
4649422



2x
4640843



1x
4646828



2x
4646871



2x
4261397



2x
4646843



4x
4646835



Customer Service

Kundenservice

Service Consommateurs

Servicio Al Consumidor

www.lego.com/service or dial



00800 5346 5555 :



1-800-422-5346 :



CUSTOMIZE YOUR SPINNERS
PERSONNALISE TES TOUPIES · PERSONALIZA TUS SPINNERS

RATTLA



9579

COLE ZX



ARENA INCLUDED
ARÈNE INCLUSE
ARENA INCLUIDA



9551



9552



9553



CUSTOMIZE WITH BOOSTER PACKS

PERSONNALISE GRÂCE AUX BOOSTERS

PERSONALÍZALO CON PACKS DE REFUERZO

NINJAGO.COM

COLE ZX VS RATTLA



9579



9562



9563



9564



9566



9561



9567



KENDO ZANE
9563 - 9446



KENDO KAI
9558



KENDO COLE
9551



COLE ZX
9579 - 9444



ZANE ZX
9440
9445



JAY ZX
9553
9442
9445



SAMURAI X
9566



LLOYD GARMADON
9552 - 9443



FANG-SUEI
9567 - 9443



FANGDAM
9445



LASHA
9562



RATTLA
9579 - 9441



SNAPPA
9564 - 9442

LEGO **NINJAGO**
Masters of Spinjitzu



NINJAGO.COM



NINJAGO

Masters of Spinjitzu



NINJAGO.COM

LEGO club
FREE! GRATIS! GRATUIT!



www.LEGOclub.com



LEGO Club Magazine



LEGO Club Email

VISIT THE WORLD'S
BIGGEST LEGO® SHOP!

www.LEGOshop.com

00800 5346 5555

1-866-534-6258 • 1-877-518-5346

UK & Canada only

South East Africa



- * Freephone. Mobile charges may apply.
- * Numéro sans frais. Des frais peuvent s'appliquer avec les téléphones cellulaires.
- * Gebührenfrei, Kosten für Anrufe aus Mobilfunknetzen können abweichen.
- * Gratis telefonnummer vanaf vaste lijn.
- * Det er et gratis nummer, når du ringer fra fasttelefon.
- * Det är gratis, när du ringer från en fast telefon.
- * Numéro sans frais. Des frais peuvent s'appliquer avec les téléphones portables.

BI115

YES! I want to join the LEGO® Club FREE! **OUI!** Je veux m'abonner au LEGO® Club GRATUITEMENT !

Ja! Ich möchte Mitglied im kostenlosen LEGO® Club werden. **Ja!** Ik wil graag GRATIS lid worden van de LEGO® Club. **Ja!** Jeg ønsker å melde meg inn i LEGO® Club gratis! **Ja!** Jag vill gå med i LEGO® Club GRATIS!

First name • Prénom
Vorname • Voornaam
Fornavn • Förnamn

Last name • Nom de famille
Name • Achternaam
Etternavn • Efternamn

Date of Birth • Date de naissance
Geburstag • Geboortedatum
Fødselsdato • Födelsedatum

Boy • Garçon • Junge • Jongen • Gutt • Pojk Girl • Fille • Mädchen • Meisje Jente • Flicka

Street • Adresse
Straße, Hausnr.
Straat, huisnr. • Adress

City • Ville
Ort • Woonplaats
Poststed • Postort

State
Prov. • County

Zip/Postcode
Code Postal • PLZ
Postcode
Postnummer

Country
Pays
Land

Email • Courriel
E-Mail • E-post

- Fill in your email address and we will send you a membership confirmation and monthly email newsletters. If you do not wish to receive the newsletters please tick here. Remplis ton adresse e-mail et nous t'enverrons une confirmation d'adhésion ainsi que le bulletin e-mail mensuel. Si tu ne désires pas recevoir le bulletin, coche cette case. Vul je e-mailadres in en we sturen je een bevestiging van je lidmaatschap en maandelijke e-mail nieuwsbrieven. Als je geen e-mail wilt ontvangen, kruis dan dit vakje aan.
- Ich möchte per E-Mail den monatlichen LEGO Club Newsletter erhalten. Ønsker du at vi skal sende en liten hilsen til barnet ditt for å bekrefte medlemskapet, ber vi deg krysse av i feltet, samt oppgi e-postadressen som hilsenen skal sendes til. Om du vill att vi ska skicka en bekräftelse på ditt barns medlemskap, ber vi dig sätta ett kryss i rutan och skriva den e-post adress som bekräftelsen ska skickas till.
- If you do not wish to receive additional mailings from the LEGO Club please tick here. Si tu ne désires pas recevoir de courrier supplémentaire du Club LEGO, coche cette case. Als je geen verdere post van de LEGO Club wilt ontvangen, kruis dan dit vakje aan.
- Dersom du ønsker å motta annen informasjon fra LEGO Gruppen, setter du et kryss her.

Mail to: / Poster à:



LEGO® Club
P.O. Box 1157
Enfield, CT USA
06083-1157

Per Post an:



LEGO® Club
Postfach 14 15
D-36243 Niederaula

Send til:



LEGO® Club Norge
Postboks 58
1314 Vøyenenga

Mail to:



LEGO® Club
33 Bath Road
Slough SL1 3UF
United Kingdom

Stuur na naar:



LEGO® Club
Postbus 40250
3504 AB Utrecht

Skickas till:



LEGO® Club Sverige
Ubox 841
202 29 Malmö

Poster à:



LEGO® Club
21 rue de la banque
75 002 PARIS
FRANCE

The English language version of the magazine can only be mailed to addresses in the US, Canada, the UK, and Republic of Ireland. Club membership is valid for two years and includes free copies of the LEGO Club Magazine and e-mail newsletters. In the US and Canada please allow up to 6 weeks for delivery of your first magazine. In the UK and Republic of Ireland please allow six to 14 weeks for delivery of your first magazine. By signing this form you consent the LEGO Club to use your child's data for LEGO mailings. The data will only be used for LEGO mailings and will not be sold, rented or otherwise disclosed to any company outside the LEGO Company except for disclosure to companies acting as our agents to help us provide services requested by the child. This coupon is valid for one free membership per person, group or organization. Photocopied coupons are accepted. La version française du magazine peut être postée uniquement au Canada. L'abonnement est valide pour 2 ans et inclut des exemplaires gratuits du Magazine LEGO. Aux É.U. et au Canada, allouer 6 semaines pour la livraison initiale. En remplissant ce formulaire, vous consentez à ce que LEGO utilise les informations de votre enfant pour des envois de LEGO. L'information sera utilisée uniquement pour des envois postaux par LEGO et ne sera en aucun cas, vendue, louée, échangée ou divulguée à d'autres compagnies autres que la compagnie LEGO, à l'exception des compagnies affiliées qui nous procurent des services auxquels l'enfant en a fait la demande. Formulaires photocopiés acceptés. Mit der folgenden Unterschrift erkläre ich, für mein Kind den Beitritt zum kostenlosen LEGO Club, der von der LEGO GmbH, D-85627 Gräfelfing, betrieben wird. Die Mitgliedschaft beinhaltet die Zusendung des LEGO Club Magazines und kann beiderseits jederzeit beendet werden. Mit der Mitgliedschaft im LEGO Club sind keinerlei Verpflichtungen verbunden. Das deutschsprachige LEGO Club Magazin wird nur an Adressen in Deutschland, Österreich und der Schweiz versendet. Eine Anmeldebestätigung kann nur per E-Mail geschickt werden. Das Magazin erscheint fünfmal jährlich. Daher kann die Zustellung des ersten Heftes bis zu drei Monate dauern. Die Mitgliedschaft ist beidseitig jederzeit kündbar, ohne dass Ihnen Kosten entstehen. Sie können der werblichen Nutzung Ihrer Daten jederzeit widersprechen. Kündigung und Widerspruch können Sie telefonisch erklären (00800 / 5346 5555, Anruf gebührenfrei, Kosten für Anrufe aus dem Mobilfunknetz können abweichen) oder an die LEGO GmbH senden. Het Nederlandse LEGO Club Magazine kan alleen worden gestuurd naar adressen in Nederland. Het lidmaatschap is 2 jaar geldig en geeft recht op toezending van het gratis LEGO Club Magazine en LEGO Club e-mails. Het eerste magazine zal binnen 12 tot 14 weken toezestuurd worden. Het lidmaatschap kan op ieder moment opgezegd worden en kan na 2 jaar gratis worden verlengd, tenzij LEGO met deze activiteit stopt. Uw gegevens worden uitsluitend gebruikt voor mailings van LEGO en zullen niet worden verkocht, verhuurd of op welke wijze dan ook verstrekt aan derden buiten de LEGO Groep, uitgezonderd de organisaties die namens ons optreden om de informatie te sturen waarvoor toestemming is verleend. Den norske utgaven av magasinet sendes kun til adresser i Norge. Medlemskap i klubben gjelder 2 år og inkluderer gratisutgaver av LEGO Club Magazine. Prøven minimum oppliks seks uker leveringstid for første magasin. Ved å undertegne dette skjemaet, gir du ditt samtykke til at LEGO Club kan bruke opplysningene om barnet ditt i LEGO forsendelser. Dataene vil utelukkende bli brukt i LEGO forsendelser og vil ikke bli solgt, utleid eller på annen måte gjøres tilgjengelig for selskaper utenfor LEGO gruppen, unntatt selskaper som er våre agenter og som hjelper oss å tilby tjenestene barnet etterser. Dette skjemaet gjelder for ett gratis medlemskap per person, gruppe eller organisasjon. Den svenska versionen av tidningen kan endast skickas till adresser i Sverige. Club-medlemskapet är giltigt i 2 år och innefattar gratis exemplar av LEGO Club Magazine. Vänligen räkna med minimum 6 veckor för leverans av din första tidning. Genom att skicka in det här formuläret godkänner du att LEGO Club använder barnets uppgifter för LEGO utskick. Uppgifterna kommer bara att användas för LEGO utskick och kommer inte att säljas, hyras ut eller vidarebefordras till något företag som inte tillhör LEGO Gruppen, med undantag av företag som agerar som våra ombud för att tillhandahålla tjänster som barnet har begärt. Den här kupongen gäller för ett gratis medlemskap per person, grupp eller organisation. En complétant ce bulletin d'adhésion, vous acceptez que LEGO Club utilise les données relatives à votre enfant pour l'envoi de courriers concernant LEGO. Ces données seront uniquement utilisées pour l'envoi d'information concernant LEGO et ne seront ni vendues, ni louées, ni utilisées par d'autres sociétés que le groupe LEGO, à l'exception des sociétés agissant pour le compte de LEGO en tant que sous-traitant de services divers. L'abonnement au LEGO Club est valable pour 2 ans. Il inclut l'envoi par courrier du magazine LEGO Club et par email des newsletters. Un délai de 6 à 14 semaines est à prévoir pour la réception de votre premier magazine. Ce bulletin d'adhésion gratuit est valable pour l'inscription d'une seule personne. Les photocopies sont acceptées. ATTENTION! Le bulletin d'adhésion doit être rempli et signé par un parent ou un tuteur.

Parent's signature • Signature d'un parent ou d'un tuteur •
Unterschrift Erziehungsberechtigter • Handtekening ouders •
Foreldres/foresattes underskrift • Förälders/förmyndares underskrift

Date
Datum
Date



WIN!

Go to www.LEGOsurvey.com/product to fill out a survey for a chance to win a cool LEGO® Product. No purchase necessary. Open to all residents where not prohibited.

 www.LEGO.com



www.LEGOsurvey.com/product

GEWINNE! WIN!

Nimm an der Umfrage auf www.LEGOsurvey.com/product teil und hab die Chance ein cooles LEGO® Produkt zu gewinnen!
Die Teilnahme am Gewinnspiel führt zu keinerlei Kaufverpflichtungen. Teilnahme in allen nicht ausgeschlossenen Ländern möglich.

Ga naar www.LEGOsurvey.com/product, vul een enquêteformulier in en maak kans op een cool LEGO® product.
Geen aankoopverplichting. Iedereen mag deelnemen, uitzonderend ingezetenden van landen waar een enquêteverbod geldt.

GAGNE! 当てよう!

Visite www.LEGOsurvey.com/product pour répondre à un questionnaire et avoir une chance de gagner un produit LEGO® très cool!
Aucune obligation d'achat. Ouvert à tous les résidents des pays autorisés.

www.LEGOsurvey.com/product にアクセスして、アンケートにご記入ください。当選者にはレゴ®製品を差し上げます。
お買い上げの必要はありません。
禁止されていない限り、すべての皆様にご利用いただけます。