

nickelodeon

LEGO

NINJA
TURTLES™

79115



2



WARNING: CHOKING HAZARD.
Toy contains small parts and a small ball.
Not for children under 3 years.

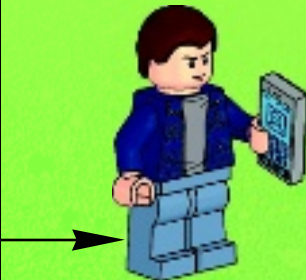
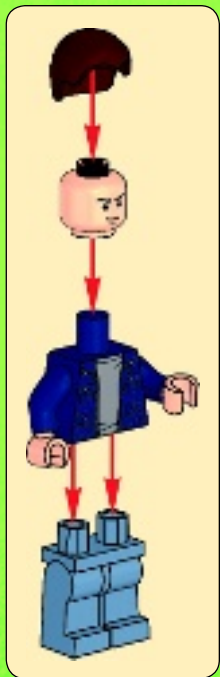
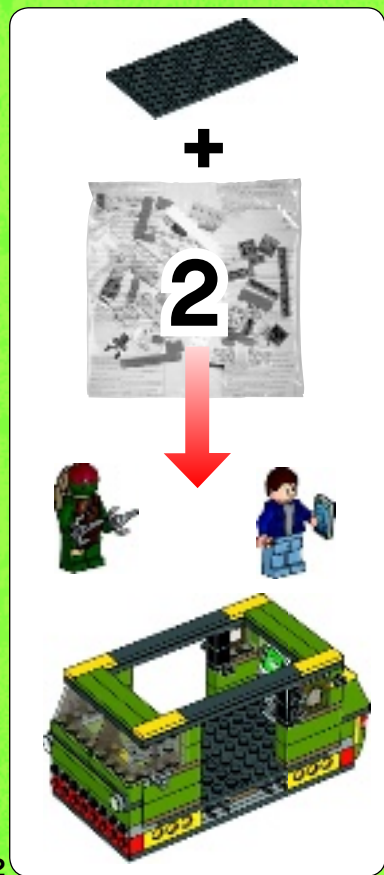



1

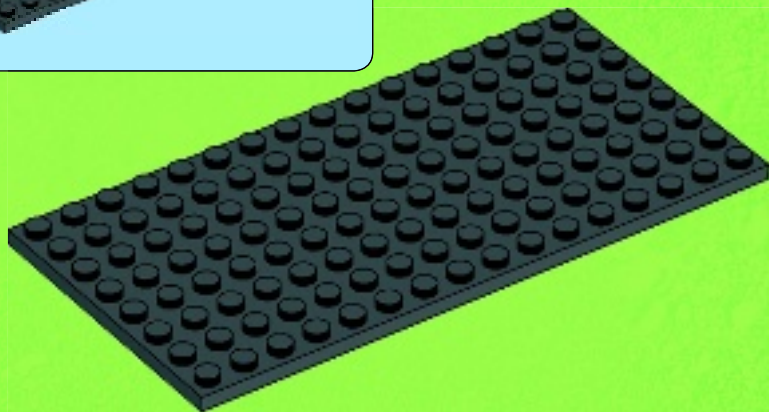

AVERTISSEMENT : RISQUE D'ÉTOUFFEMENT.
Le jouet contient des petites pièces ainsi qu'une petite boule.
Il ne convient pas aux enfants de moins de 3 ans.



ADVERTENCIA: PELIGRO DE ASFIXIA.
Juguete que contiene partes pequeñas y una pelota pequeña.
No recomendado para niños menores de 3 años.

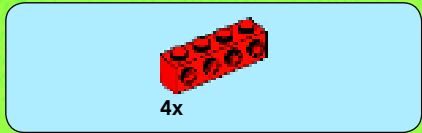

2

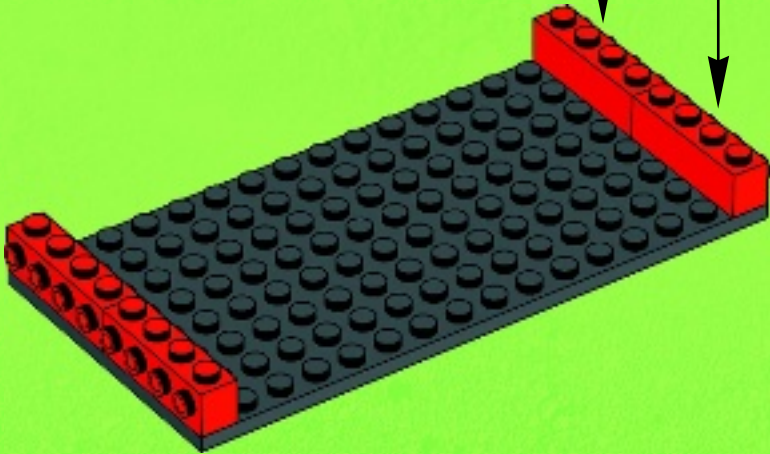
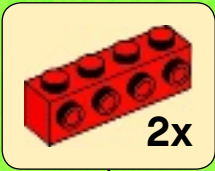



4x

3

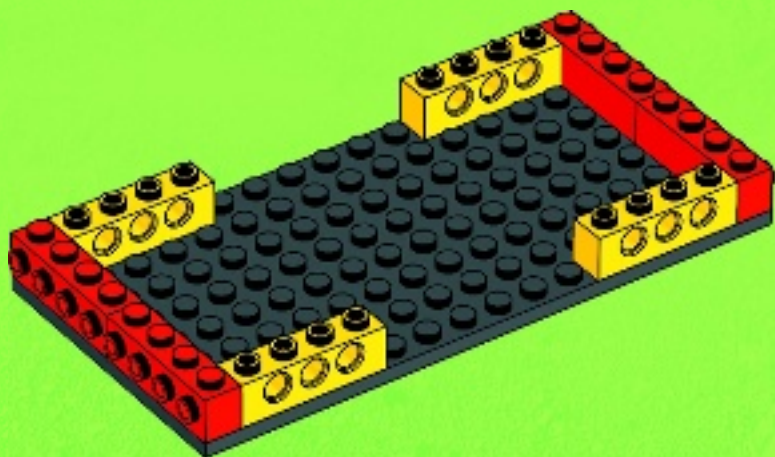

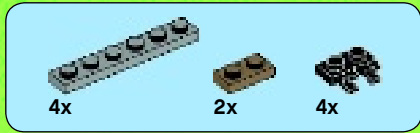

4

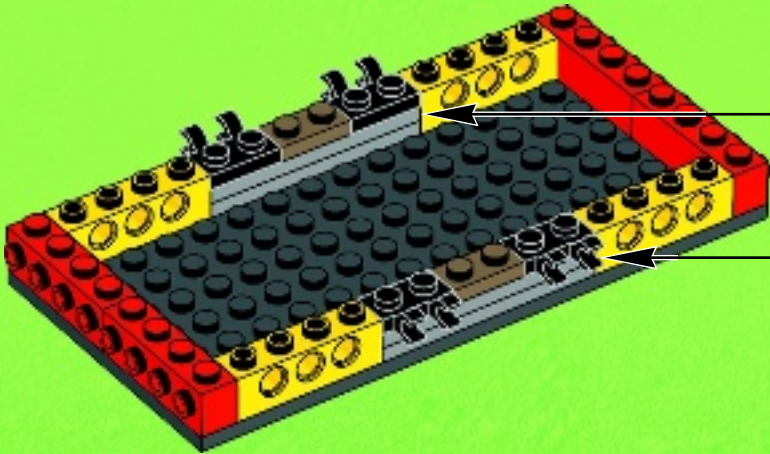
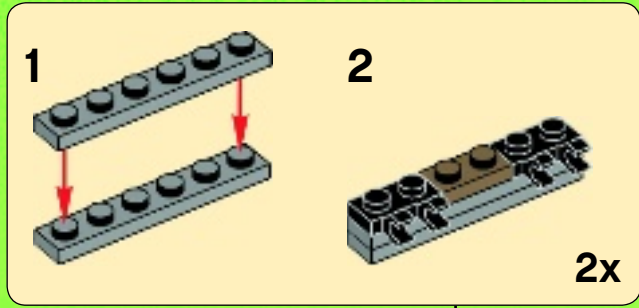

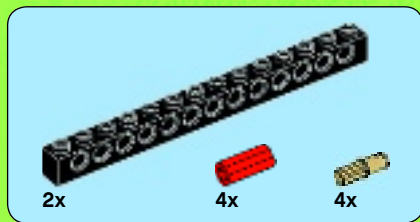

5



2x

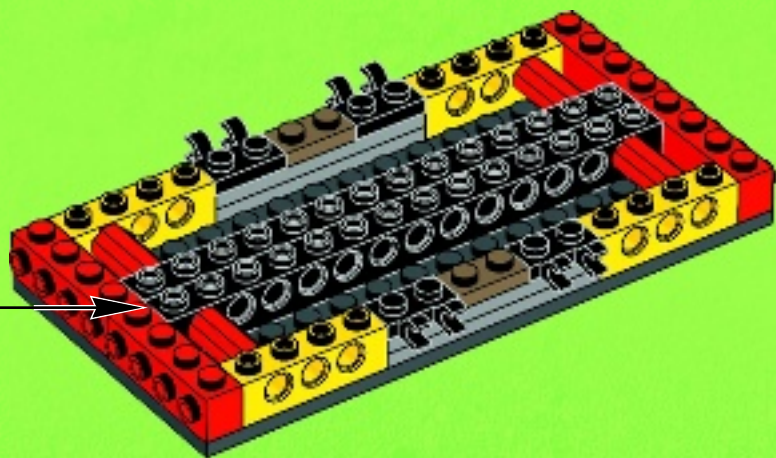



8x

6



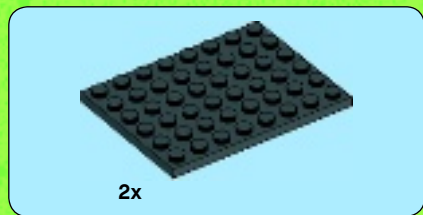

7





2x



4x

8





2x



2x

9





8x



1x

11

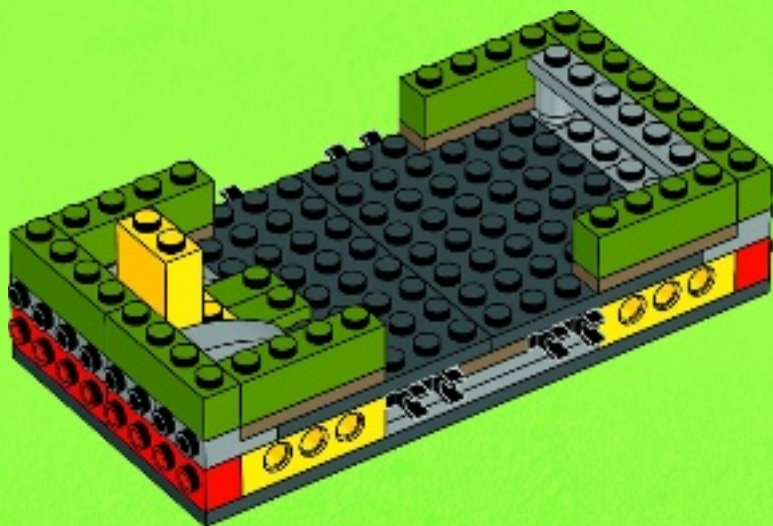



4x

12

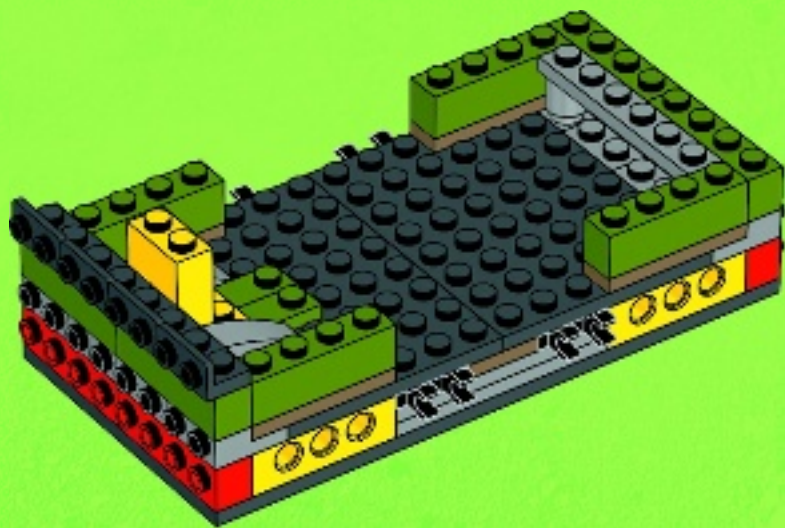



4x

13

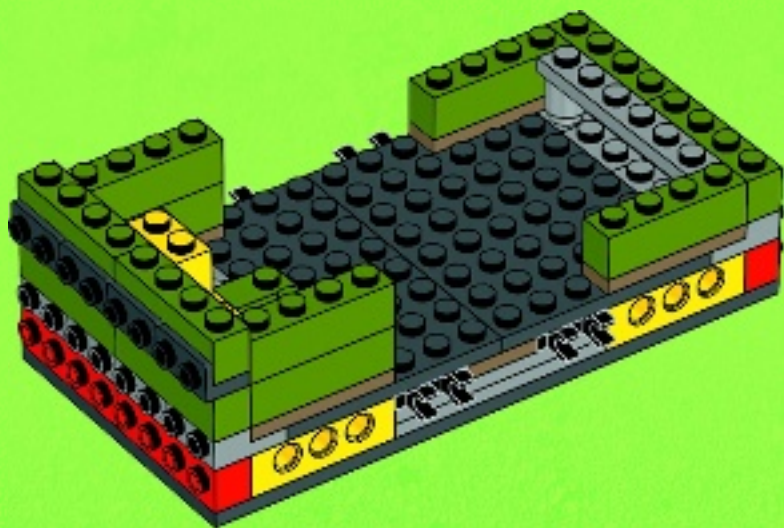



2x

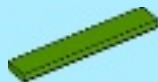

1x

14

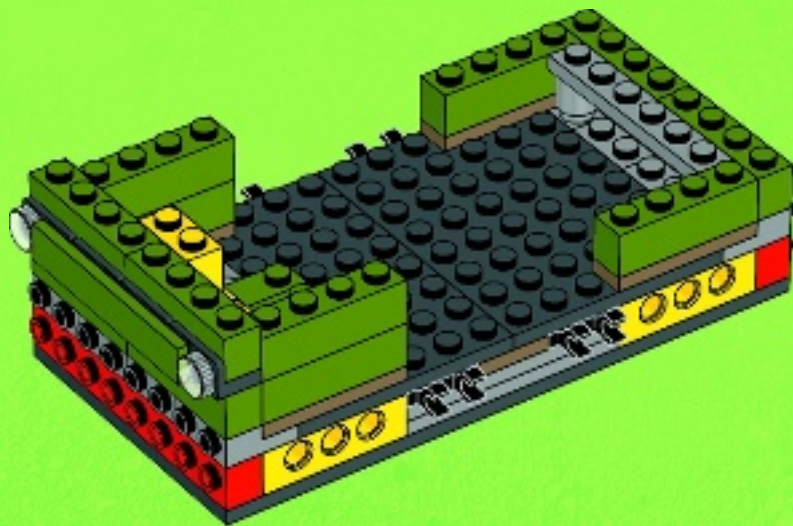



2x



2x

15

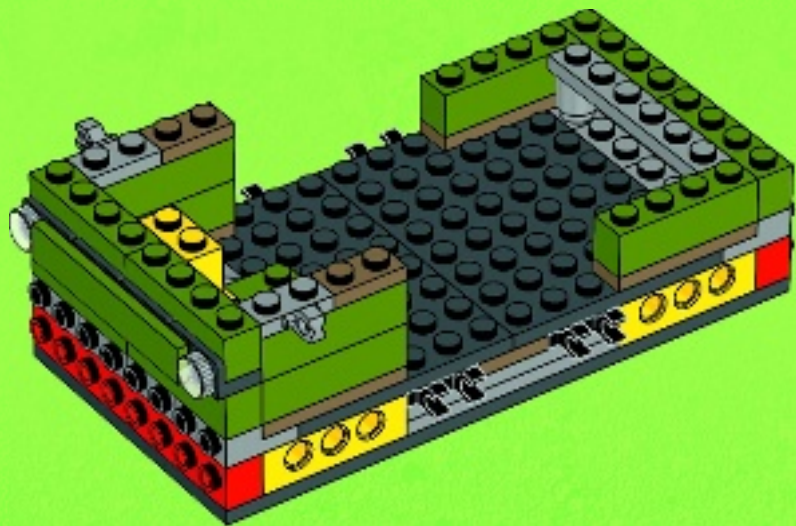

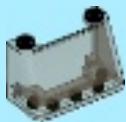

2x



16

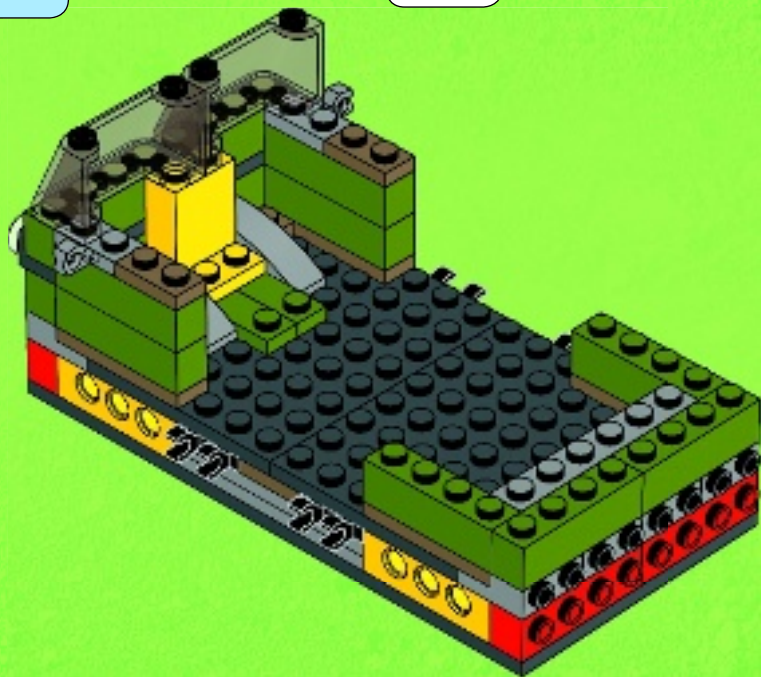



2x



1x

17

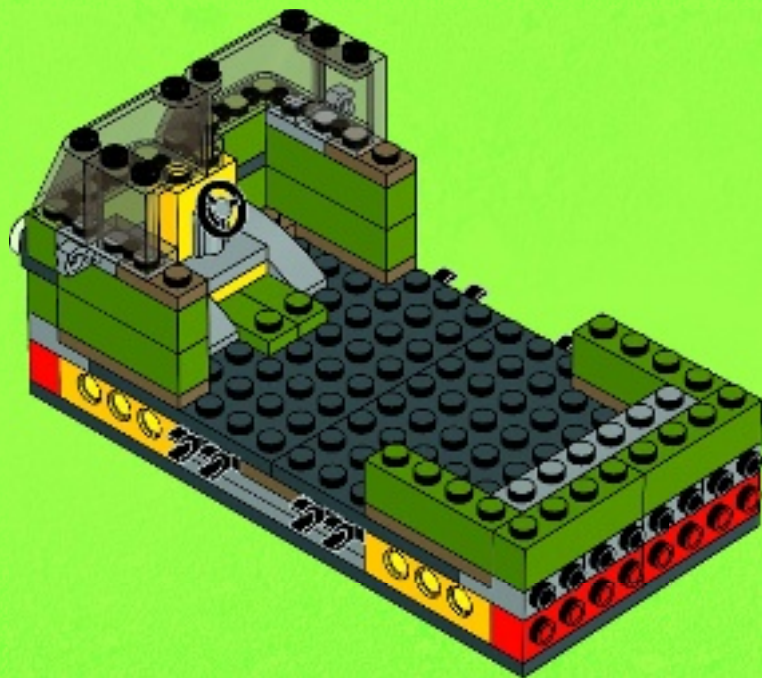



4x

18

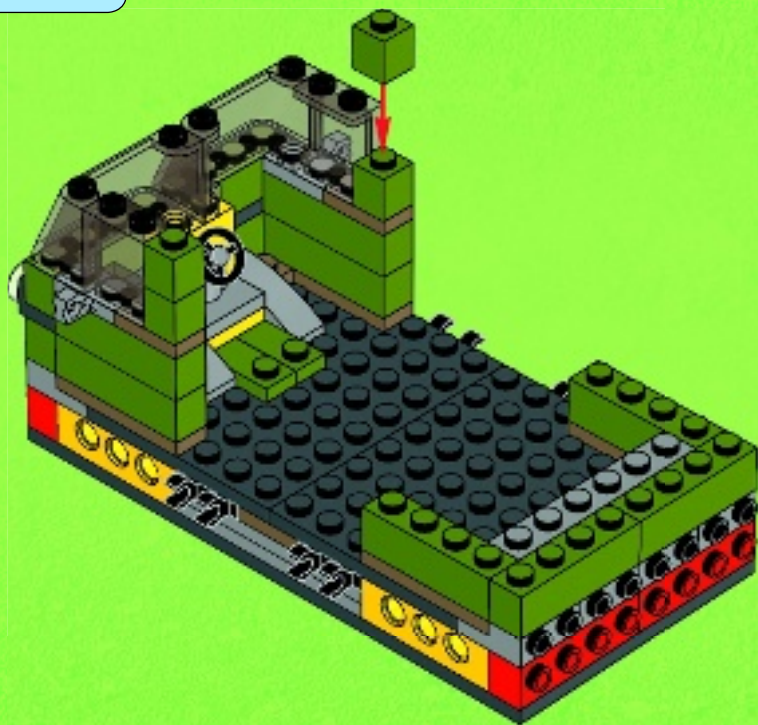



2x



2x



4x

19

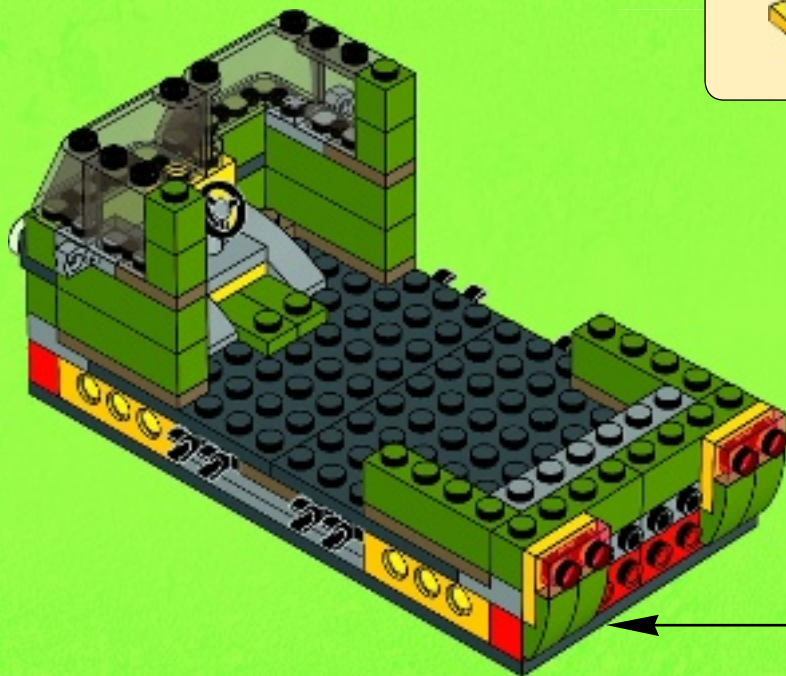

1

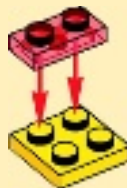

2



2x



1x

20

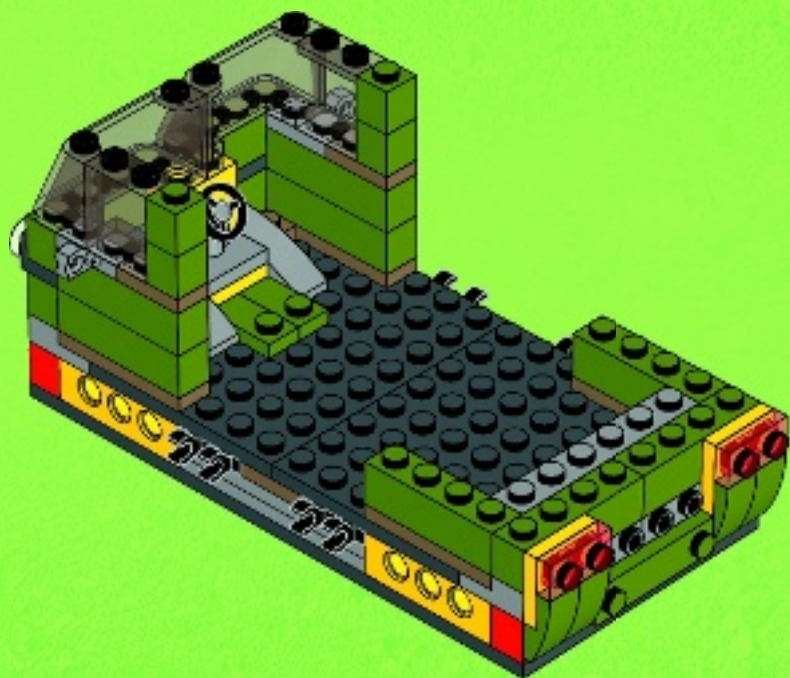

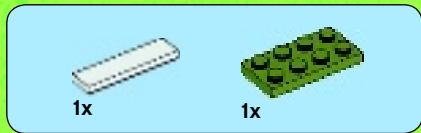

21

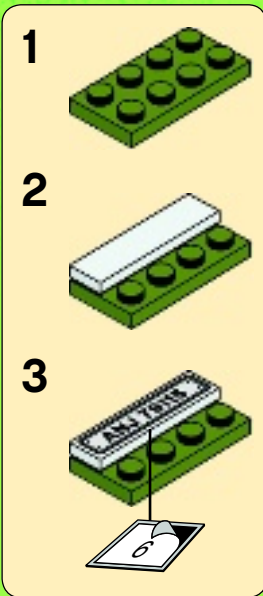
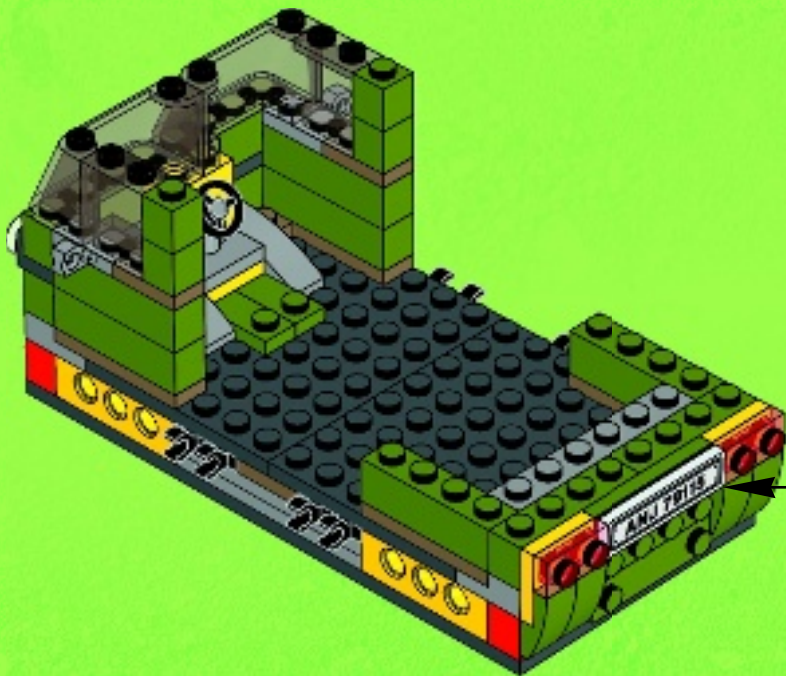



2x



2x

22

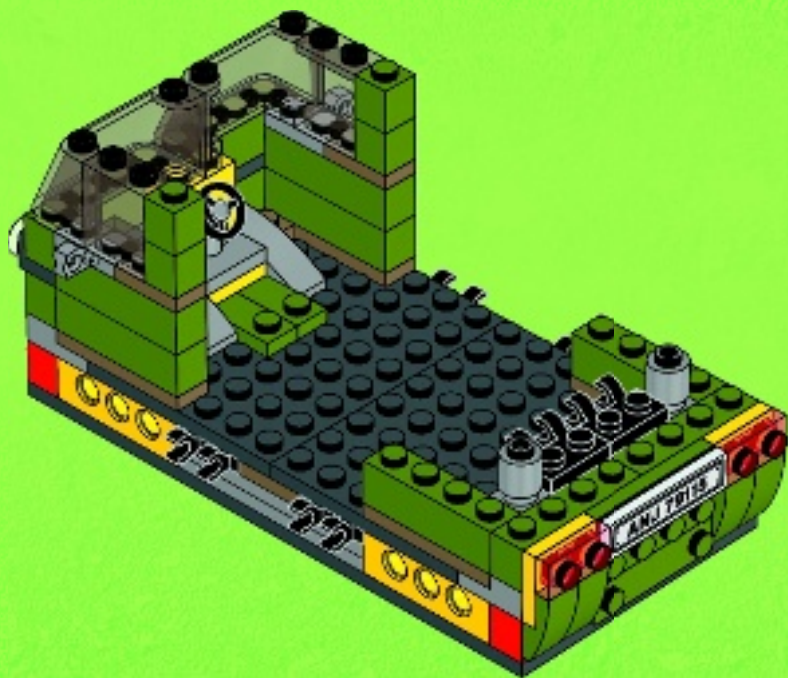



4x



2x

24

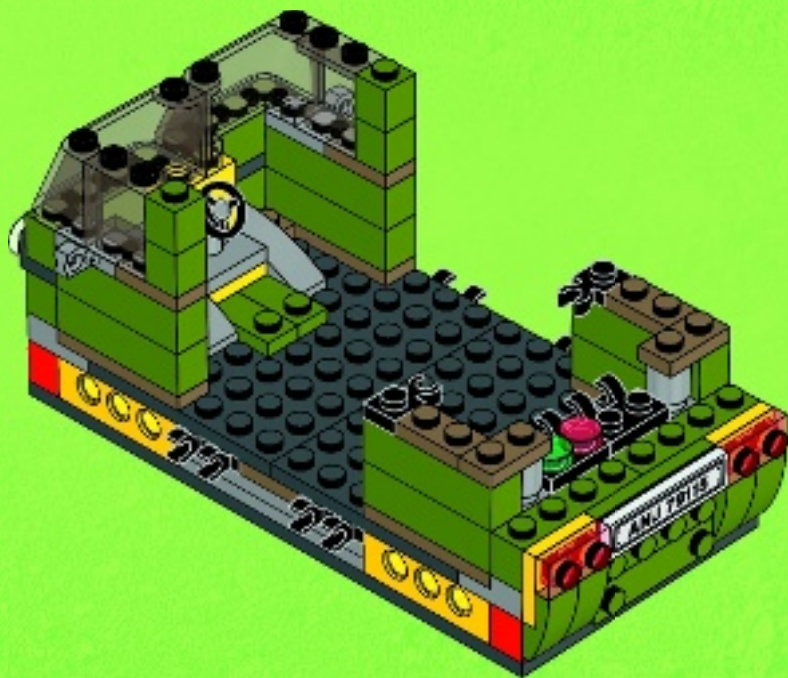

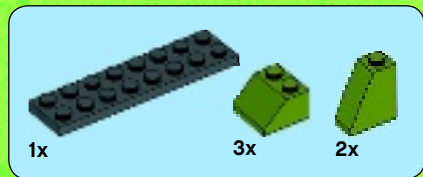

25

1

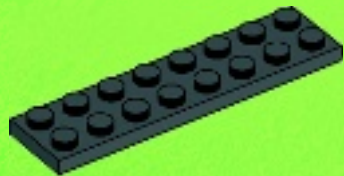

2

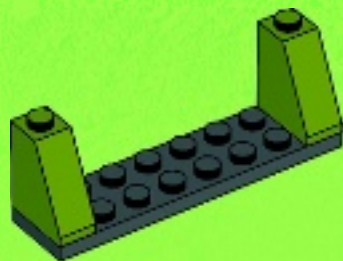

3

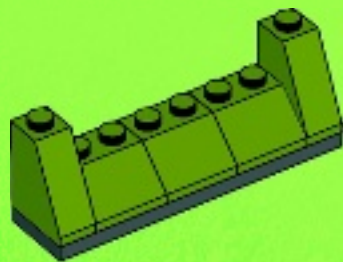

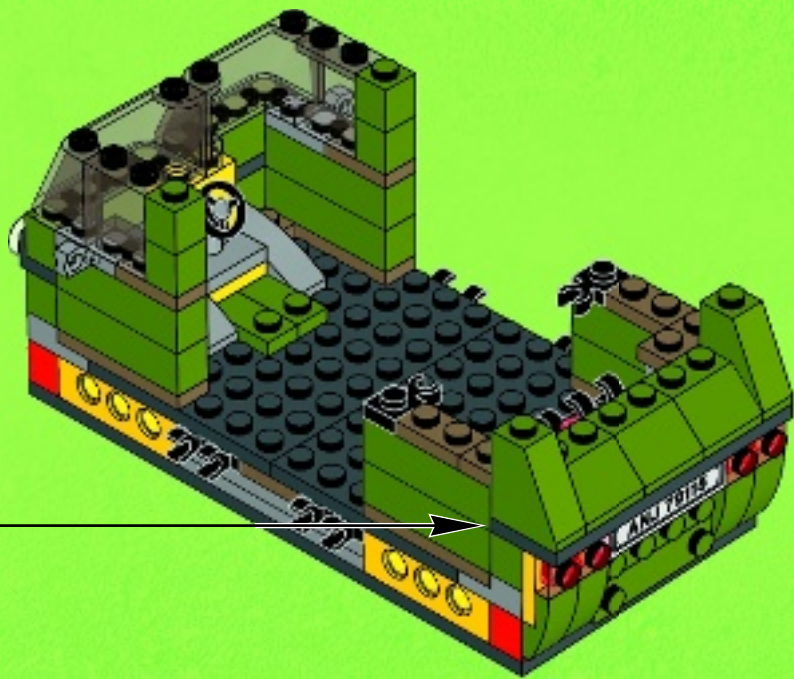



2x

26

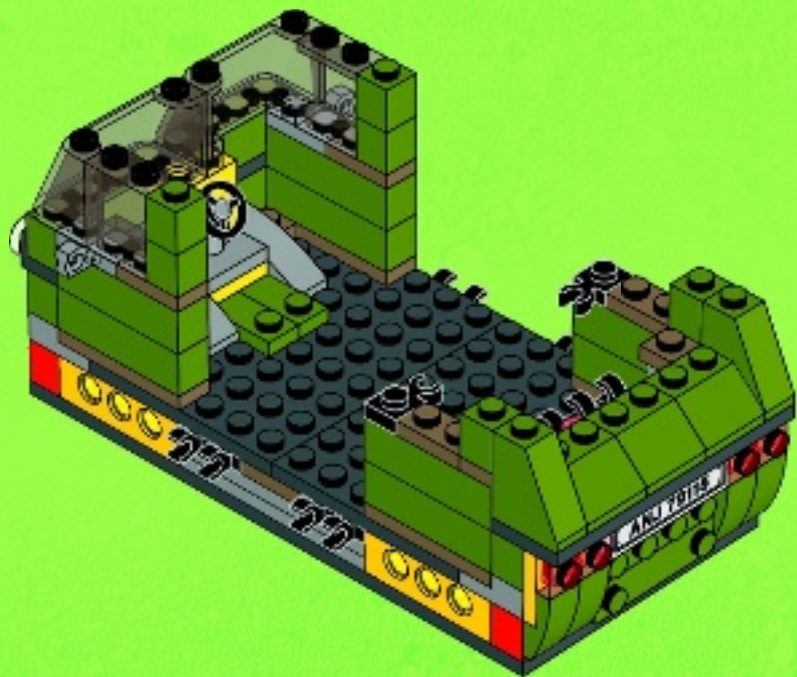

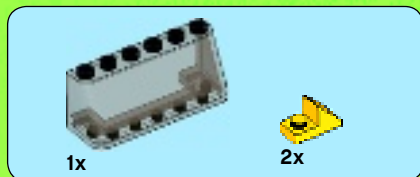

27

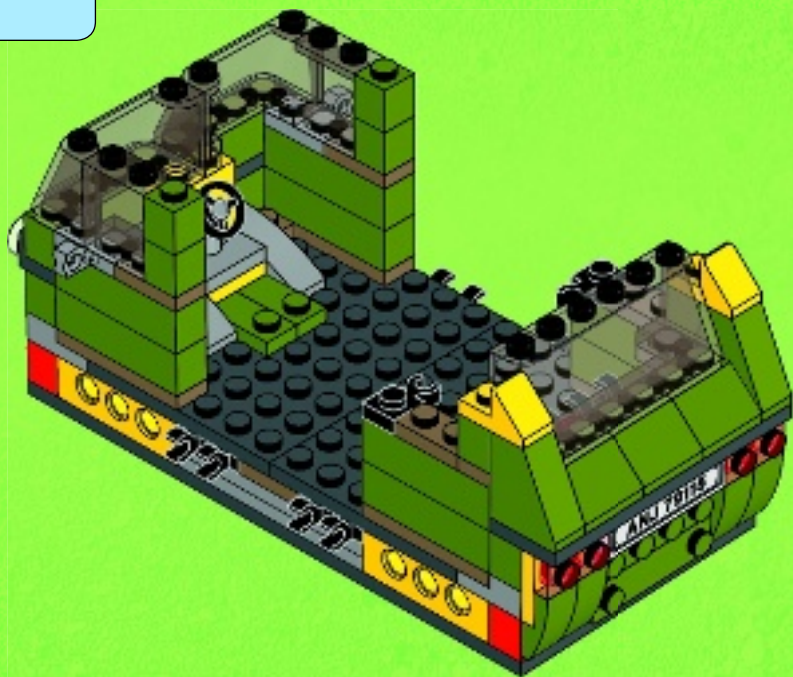



2x



2x

28

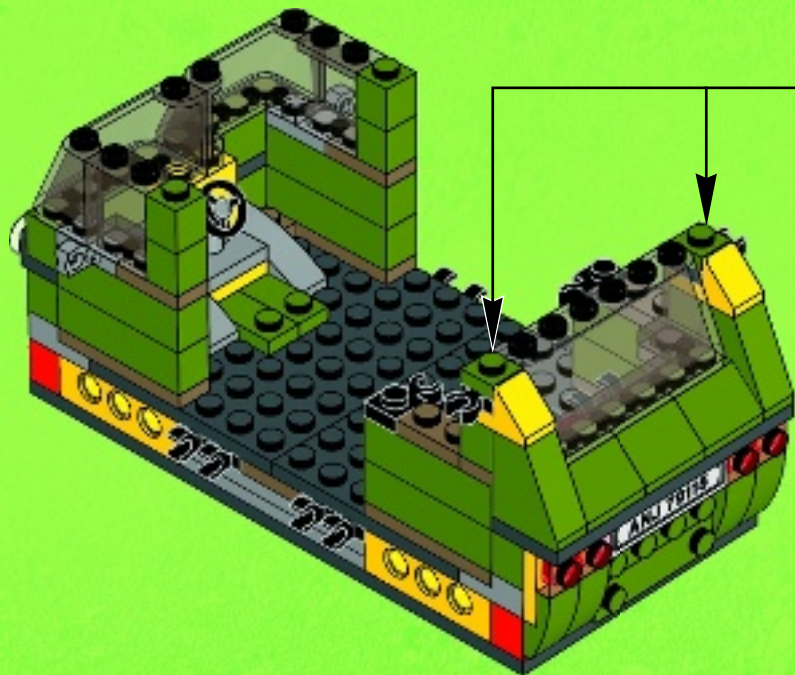

2x

2x 1x 1x



29

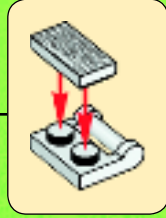
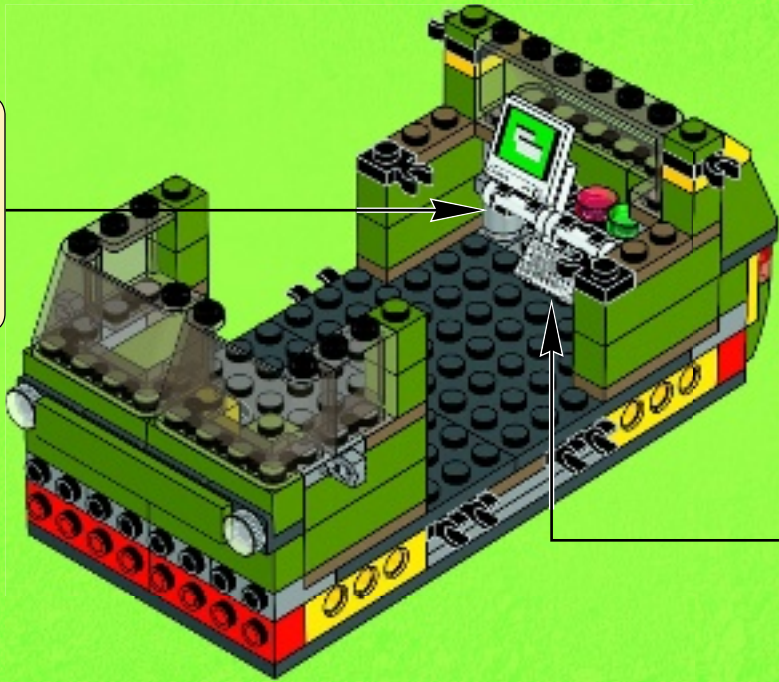
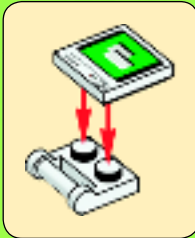



2x

30

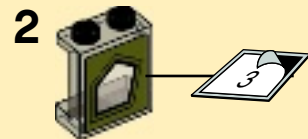
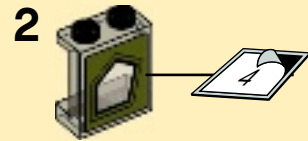
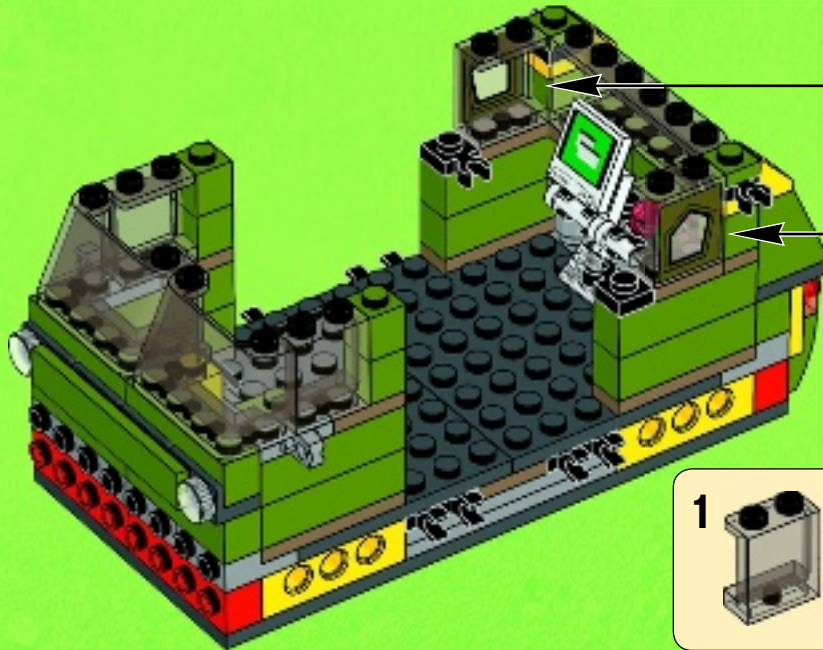



4x

31

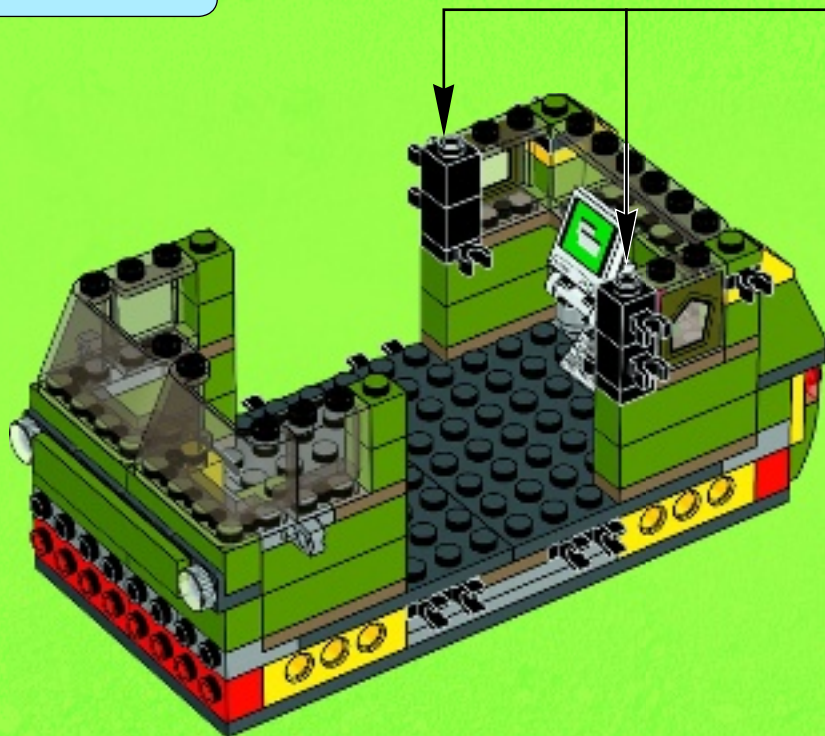

2x

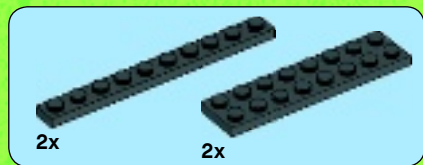

32

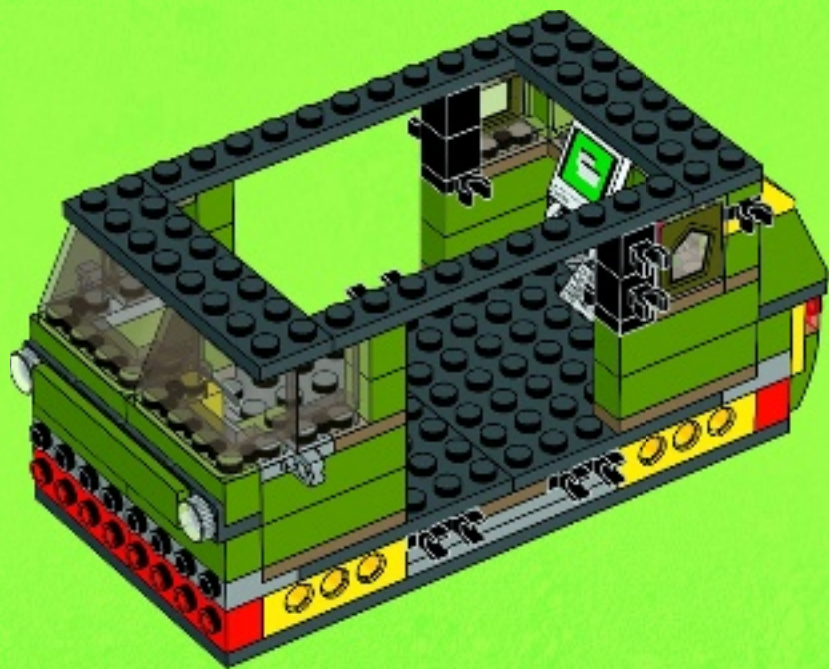



2x



4x

33

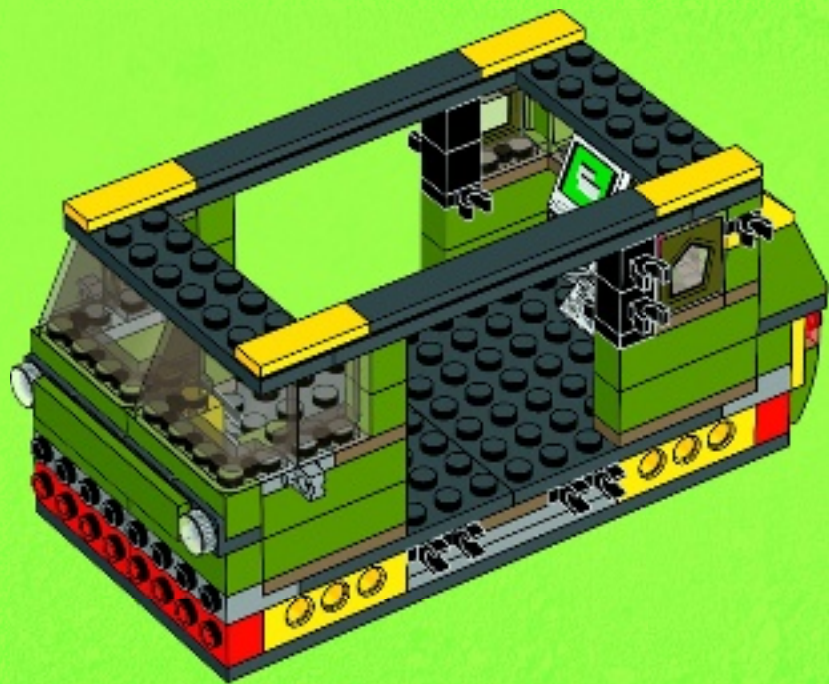

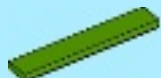

4x

34

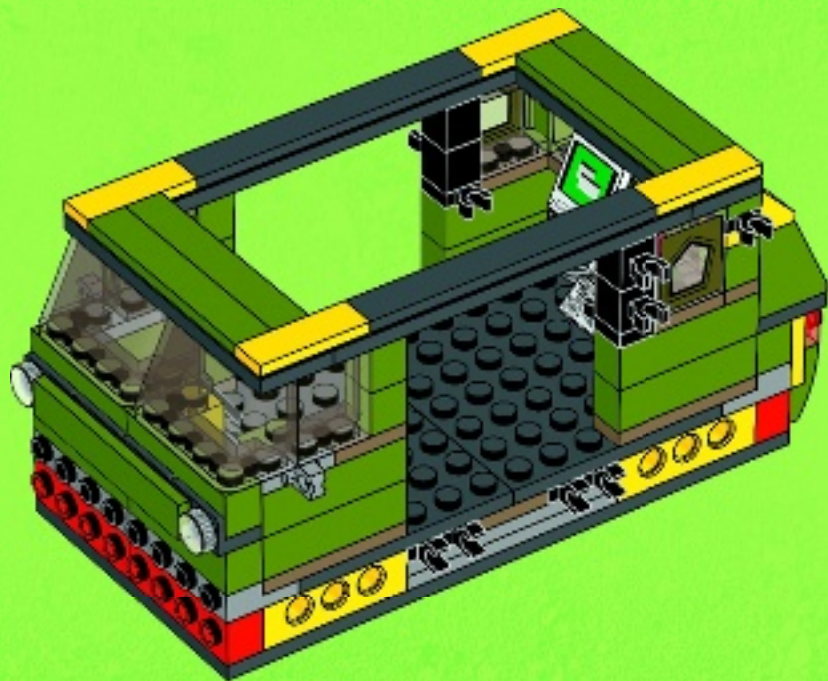





2x

35

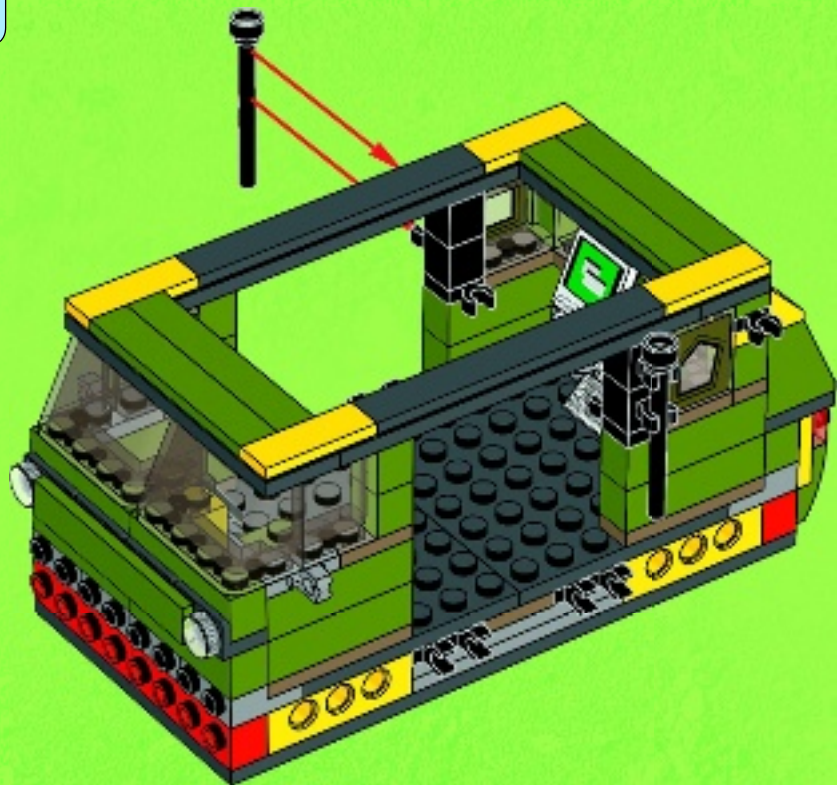



1x

1

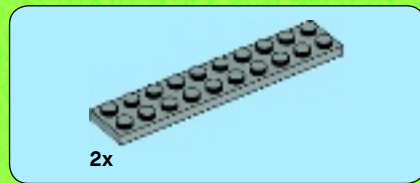

2x

2





4x

3

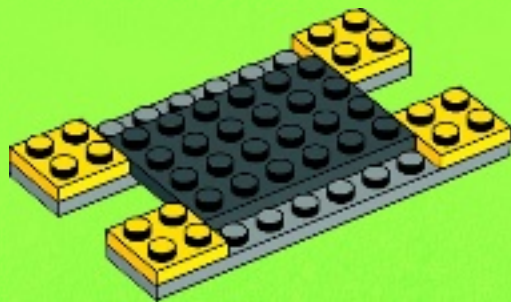



2x

4

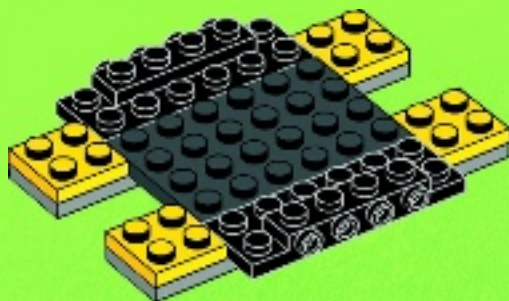

2x

5





4x

6

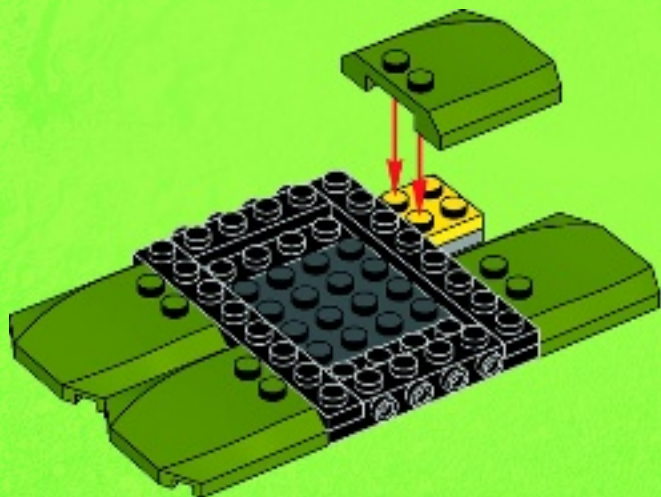

2x

7

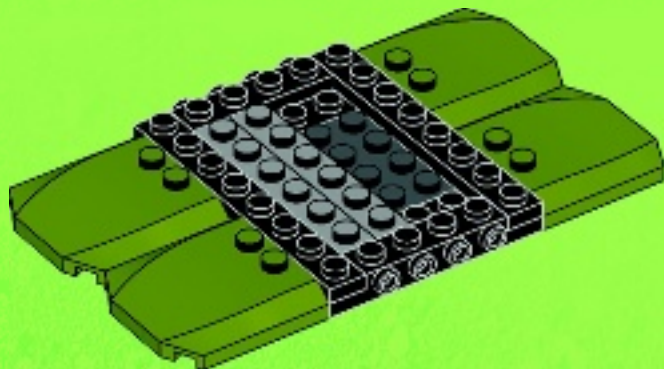



1x



2x

8

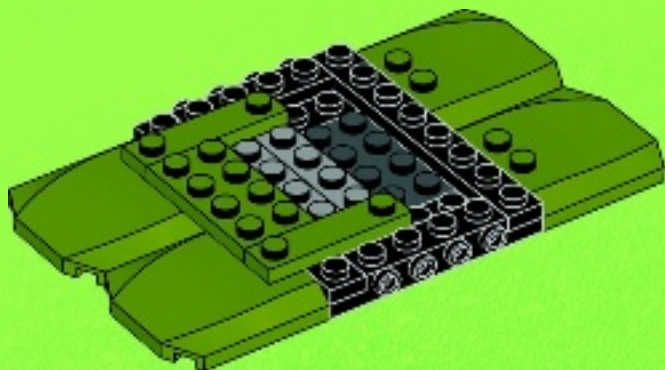

1x



1x



2x

9

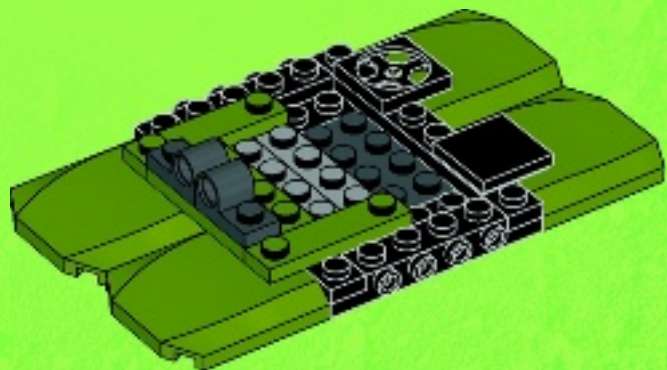



1x



2x

10

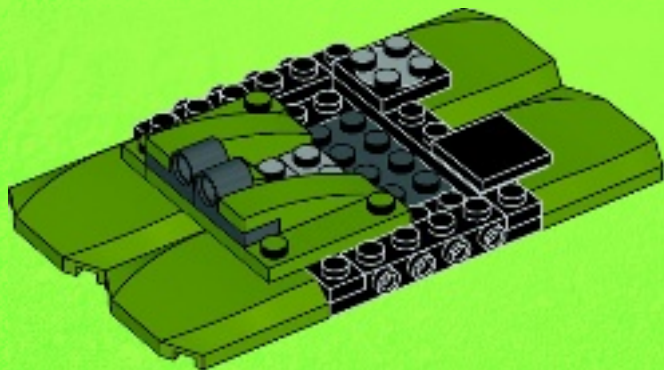

2x

11

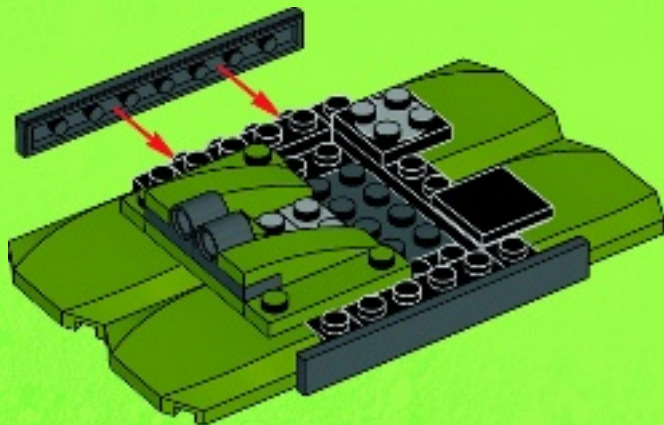



1x



1x

12

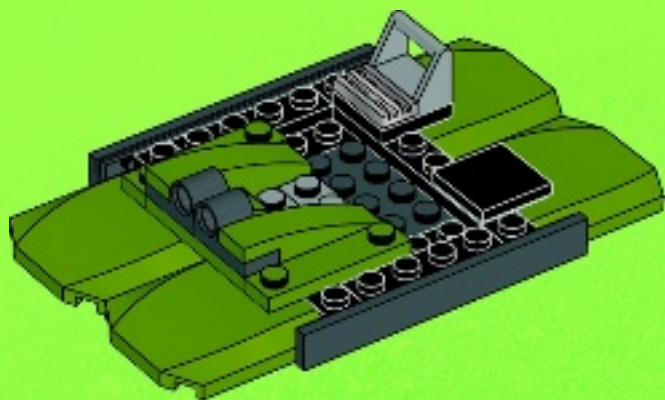

1x



1x

13

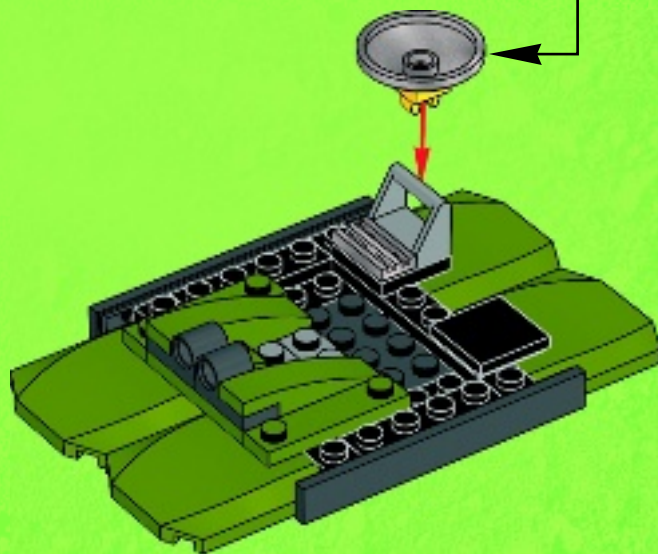

36

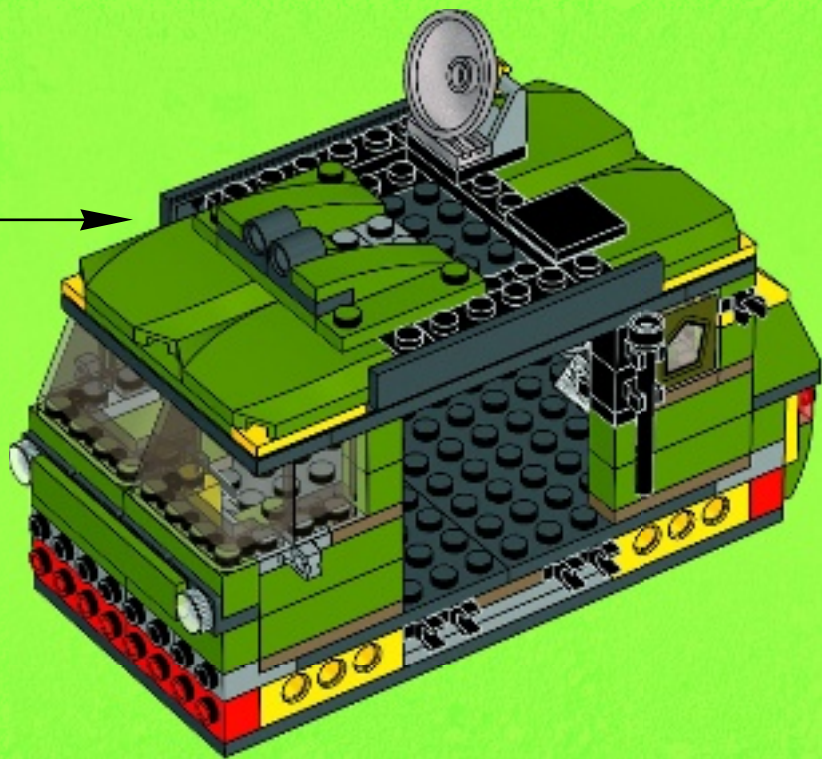



2x



1x

1



1x

2

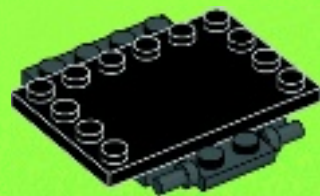



1x

3

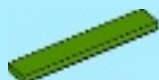
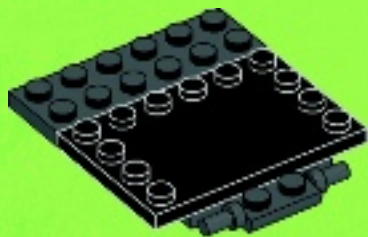

2x

4

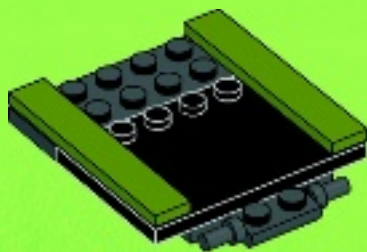



2x

5

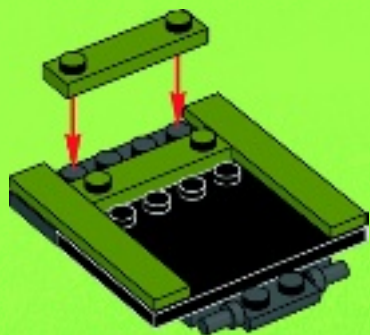

1x

6





1x

7



2x

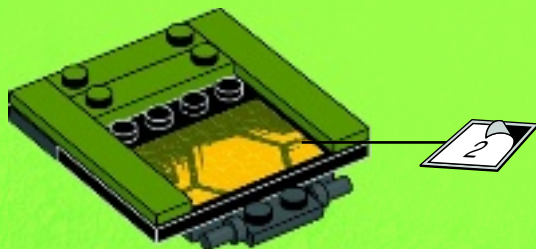
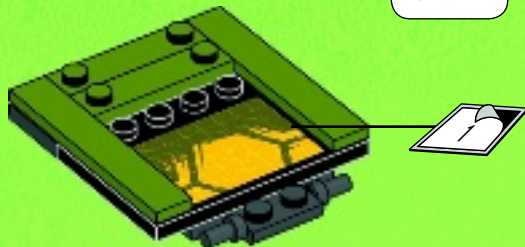
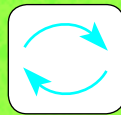

37

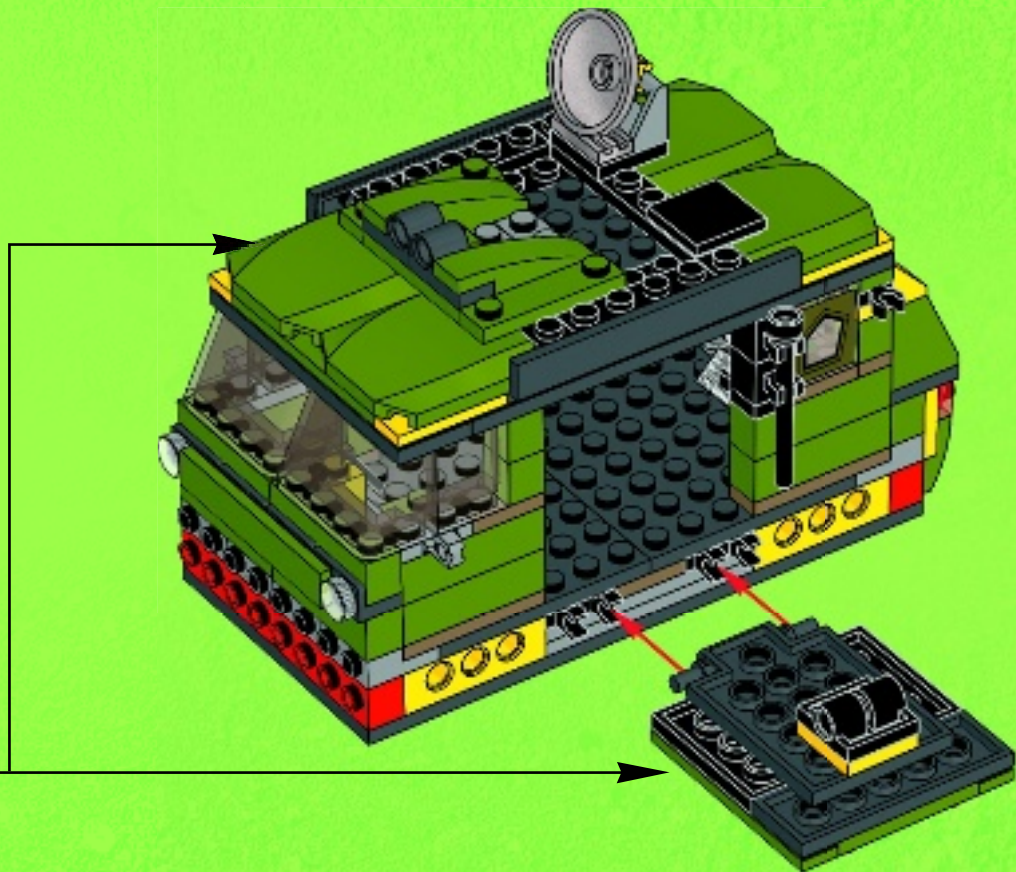



4x



4x

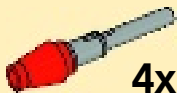

4x



38

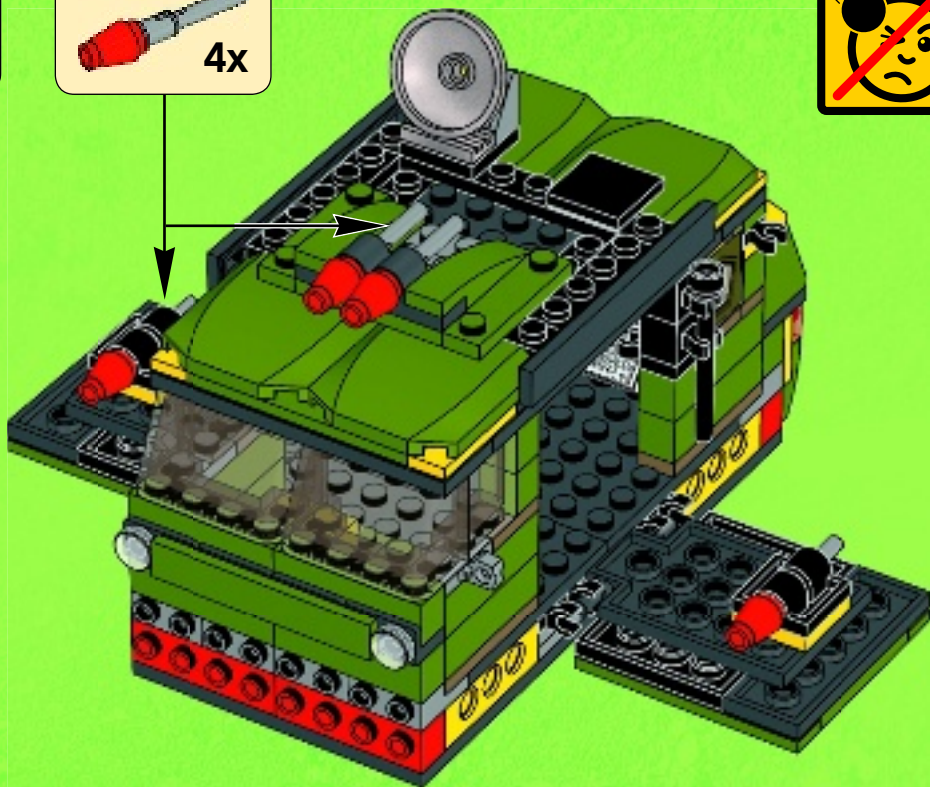



39

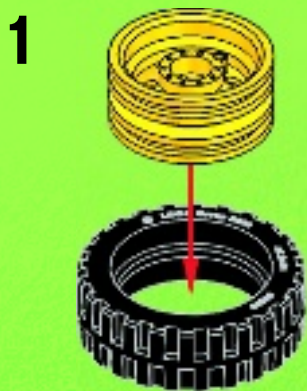

2



4x

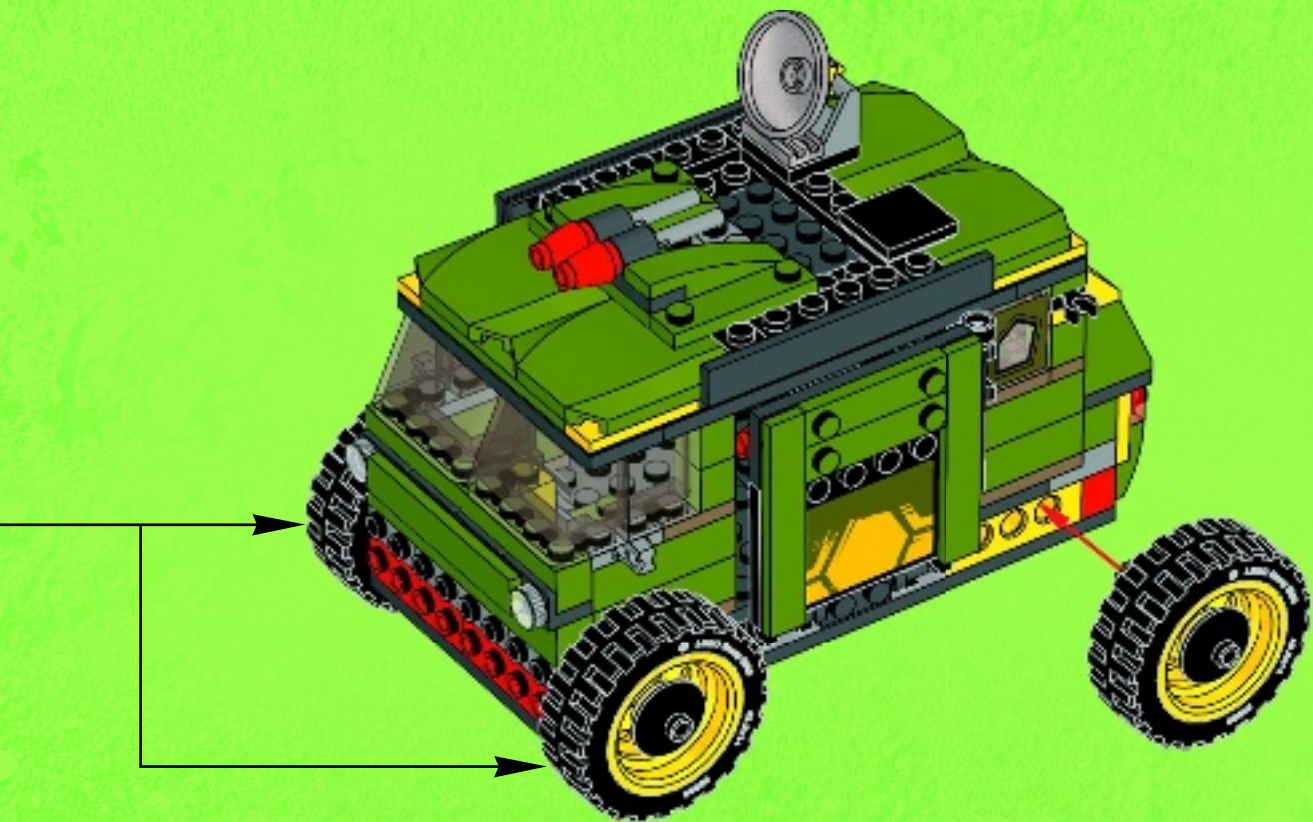



2x



1x

1

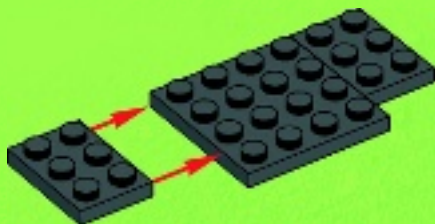

1x

2

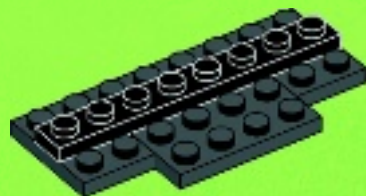



1x



2x



2x

3



2x



2x

4





4x

5



40

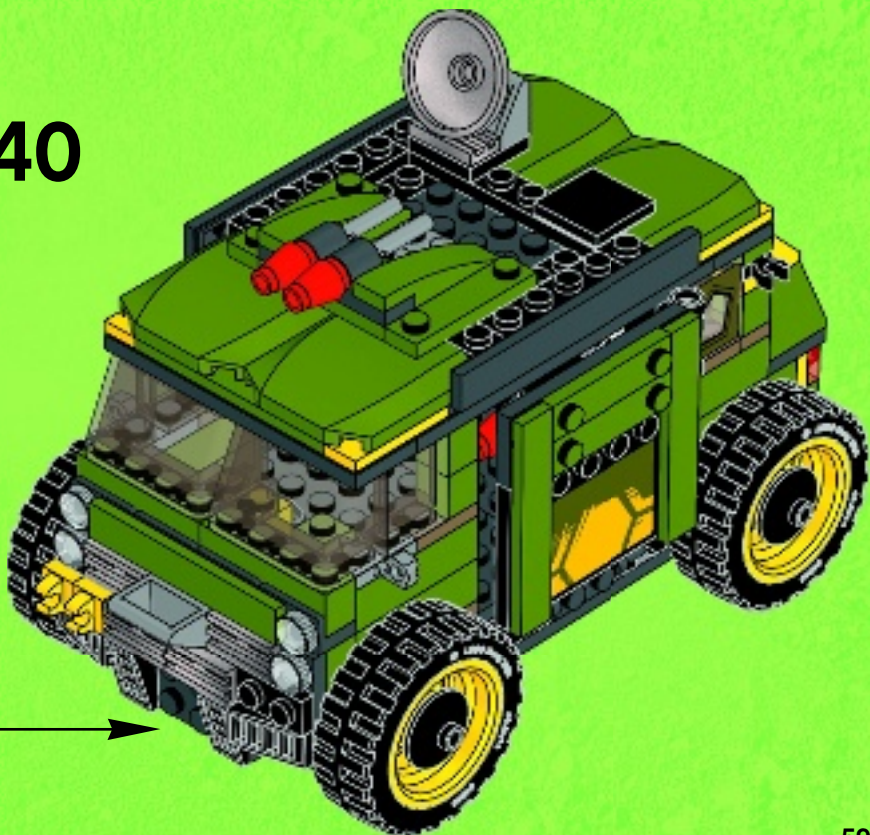



41







2x



2x

42

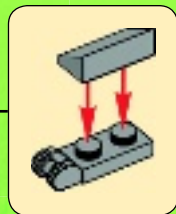
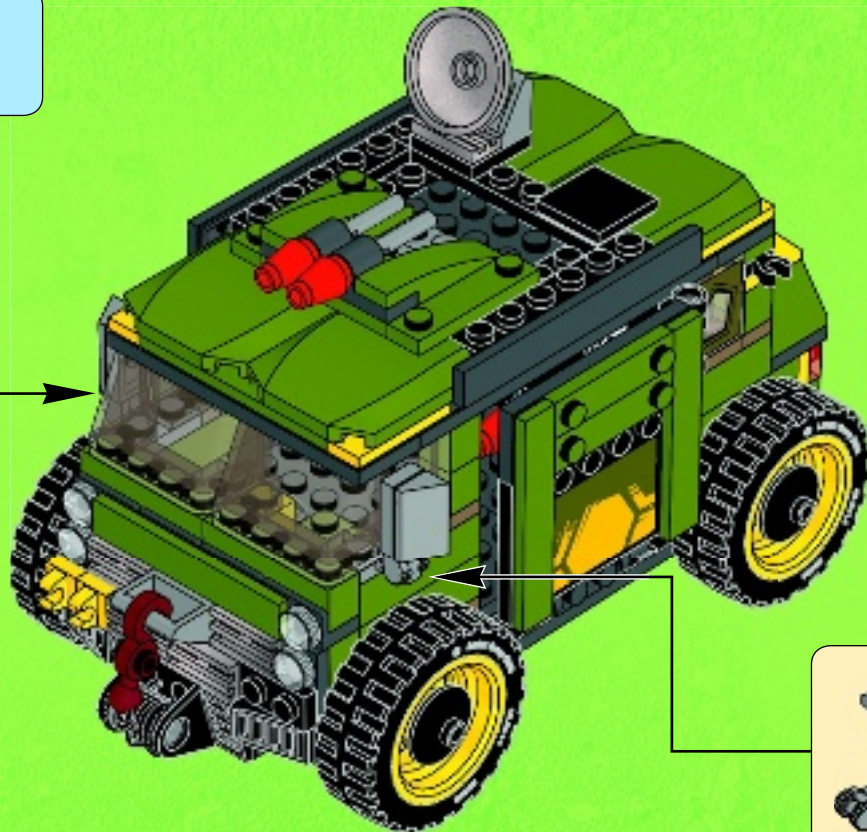
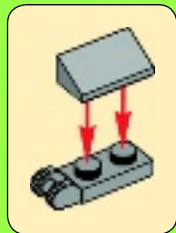

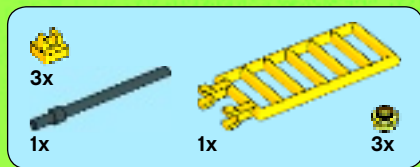

43

1

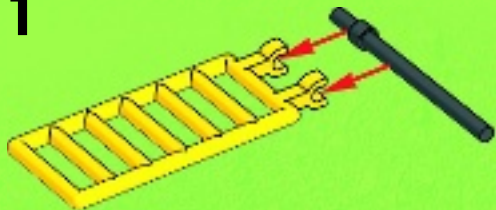

2

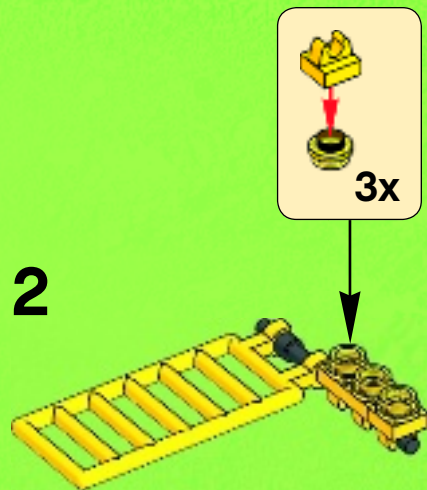

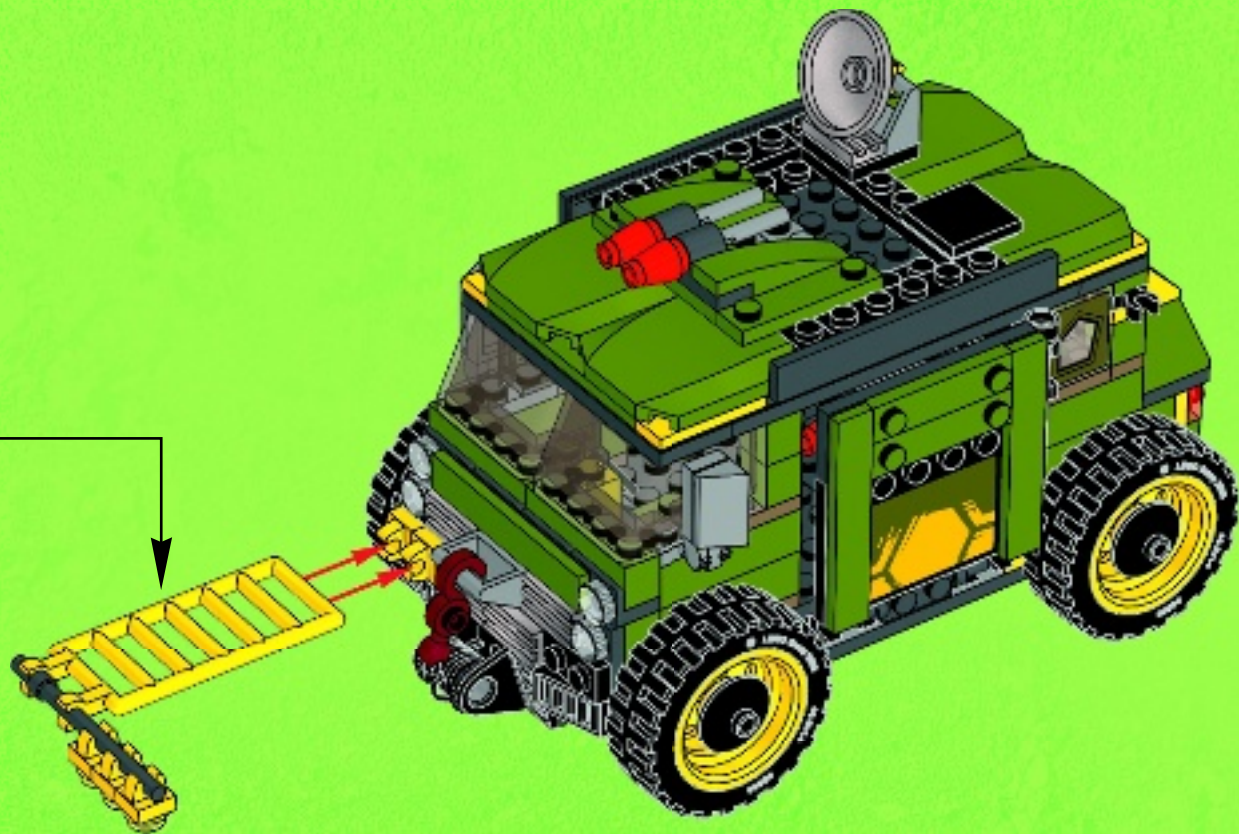



1x

44







club™

Free*! Gratuit !

* Paid subscription in Australia and New Zealand.
Abonnement payant en Australie et Nouvelle-Zélande.



LEGO.com/club



LEGO.com/turtles

LEGO and the LEGO logo are trademarks of the/son des marques de commerce de/son marcas registradas de LEGO Group. ©2014 The LEGO Group.
©2014 Viacom International Inc. All Rights Reserved. Nickelodeon, Teenage Mutant Ninja Turtles and all related titles, logos and characters are trademarks
of Viacom International Inc. ©2014 Viacom International Inc. Tous droits réservés. Nickelodeon, Les Tortues Ninja et tous les titres, logos et personnages qui
s'y rapportent sont des marques de commerce de Viacom International Inc. ©2014 Viacom International Inc. Todos los derechos reservados. Nickelodeon,
Teenage Mutant Ninja Turtles y todos los títulos, logotipos y personajes relacionados son marcas comerciales de Viacom International Inc. nick.com/tmnt
©2014 Paramount Pictures. All Rights Reserved. Nickelodeon and "NINJA TURTLES" are trademarks of Viacom International Inc. ©2014 Paramount Pictures.
Tous droits réservés. Nickelodeon et « TORTUES NINJA » sont des marques de commerce de Viacom International Inc. ©2014 Paramount Pictures. Todos los
derechos reservados. Nickelodeon y "NINJA TURTLES" son marcas comerciales de Viacom International Inc. 6083307

